

 **YORK**<sup>®</sup>

**BY JOHNSON CONTROLS**

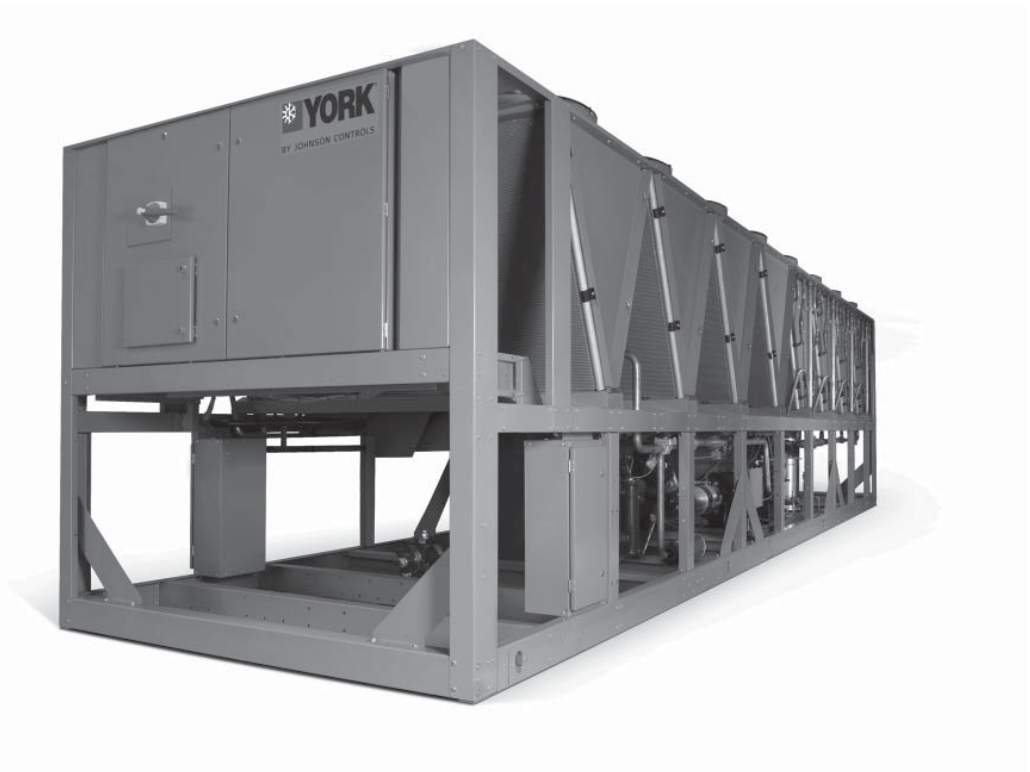

***Model YVAA Air Cooled Screw Compressor Liquid Chillers  
with Variable Speed Drive  
Style A***



525 - 1225 kW  
2 Compressor  
50 Hz  
HFC-134a

**FORM 201.28-EG1.EN.PED/CE (1111)**..... 1  
**Introduction**..... 3  
**Ratings** ..... 4  
**Product Description** ..... 4  
**MicroComputer Control Center**..... 6  
**Accessories and Options** ..... 7  
**Refrigerant Piping Layout**..... 10  
**Application Data** ..... 11  
**Physical Data**..... 14  
**Evaporator Options** ..... 16  
**Dimensions** ..... 17  
**Electrical Data**..... 18  
**Power Wiring**..... 19  
**Customer Control Wiring**..... 20

**NOMENCLATURE**

**YVAA 074 3AXX 50 AA**

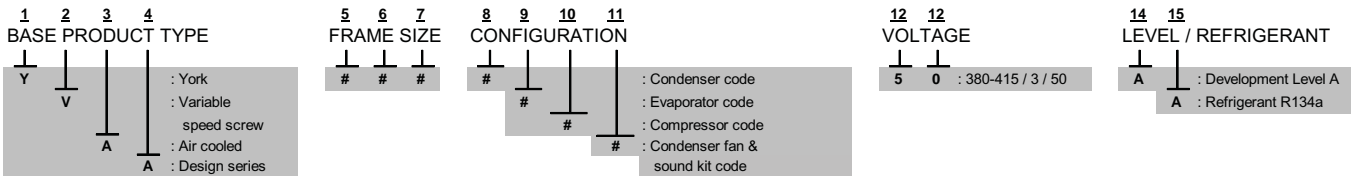

# Introduction

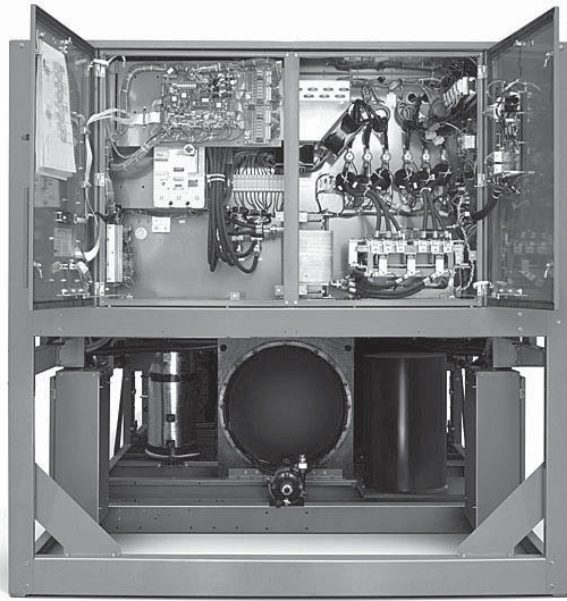

For over 135 years, Johnson Controls has raised the bar of chiller design and customer expectations. We are raising the bar again with a leap forward in air-cooled chiller technology. Continuing the history of innovation in both compressor design and Variable Speed Drive (VSD) technology, Johnson Controls proudly introduces the YORK® YVAA.

In the past, the choice to use an air-cooled chiller came with the expectation of compromise, where simplicity of design and maintenance were traded for performance and efficiency. The new YVAA provides a better balance by combining the best of both - a high performance design that minimizes the total cost of ownership.

YORK YVAA model air-cooled chillers provide superior performance. Higher efficiency heat exchangers coupled with variable speed operation and smart controls elevate the system efficiency to a whole new level. The resulting benefit from YVAA chillers is much greater than the sum of its parts.

## **Efficiency: Reduce your consumption**

YVAA chillers are Johnson Controls' most efficient air-cooled chillers. The design offers a lighter, smaller and quieter package that minimizes the installed cost and maximizes usable building space. YVAA chillers are simpler in design with easy access to service components for reliable operation and efficient maintenance. With up to a 40% improvement in real world efficiency versus current products, YVAA sets the new standards for lowering energy use.

## **Sustainability: Improve your environmental footprint**

YVAA lowers both direct and indirect impact on the environment. It uses R134a refrigerant which has zero ozone depletion potential (ODP). The design minimizes the quantity of refrigerant used in the system.

The highest portion of green house gases is carbon dioxide generated from electric power plants. HVAC systems are one of the largest consumers of electricity in commercial buildings. YVAA chillers reduce the electricity usage, thereby contributing to reducing greenhouse gases and helping keep the planet cool.

## **Low Sound: Quiet operation makes you a good neighbour**

The variable speed technology on YVAA allows unparalleled low sound levels at off peak design conditions. This makes YVAA a great solution for sound sensitive zones. Several acoustic attenuation options with smart controls (SilentNight™), aerodynamic fans and effective sound enclosures will meet the sound levels required.

## **Confidence: Proven performance provides peace of mind**

YVAA design is proven by years of success with the previous generation of VSD air-cooled screw chillers with thousands of machines operating in more than one hundred countries.

YVAA is configurable to be the perfect fit for your unique needs. YVAA offers an array of options that can be tailored and tuned to match the capacity, efficiency, sound and footprint for your specific application. Several variations of condenser fans, evaporator arrangements, sound kits, protection enclosures, and controls schemes are available to meet specific requirements for your site.

# Ratings

## COMPUTERIZED PERFORMANCE RATINGS

Each chiller is custom-matched to meet the individual building load and energy requirements. A variety of standard heat exchangers and pass arrangements are available to provide the best possible match.

It is not practical to provide tabulated performance for each combination, as the energy requirements at both full and part load vary significantly with each heat exchanger and pass arrangement. Computerized ratings are available through each Johnson Controls sales office.

## Product Description

YVAA air-cooled chillers are completely assembled with all interconnecting refrigerant piping and internal wiring, ready for field installation. The unit is pressure tested, evacuated, and fully factory charged with refrigerant R134a and oil in each of the independent refrigerant circuits. After assembly, an operational test is performed with water flowing through the evaporator to ensure that each refrigerant circuit operates correctly.

The unit structure is manufactured from heavy gauge, galvanised steel and coated with baked-on powder paint (colour Champagne ((RAL 7006), (Munsel No. 9.8YR4.36/1.2)).

YVAA chillers are designed within EN ISO 9001 and built within an EN ISO 9002 accredited manufacturing organisation.

Chillers conform with the following European Directives:

- Machinery directive (2006/42/EC)
- EMC Directive (2004/108/EC)
- Pressure Equipment Directive (97/23/EC)
- Safety Code for Mechanical Refrigeration (EN378-2 (2008))

## OFF-DESIGN PERFORMANCE

Since the vast majority of its operating hours are spent at off-design conditions, a chiller should be chosen not only to meet the full load design, but also for its ability to perform efficiently at lower loads. It is not uncommon for chillers with the same full load kW/kW to have an operating cost difference of over 10% due to part-load operation.

Part load information can be easily and accurately generated by use of the computer. And because it is so important to an owner's operating budget, this information has now been standardized.

A more detailed analysis must take into account actual building load profiles, and local weather data. Part load performance data should be obtained for each job using its own design criteria.

## FLUORINATED GREENHOUSE GASES

This equipment contains fluorinated greenhouse gases covered by the Kyoto Protocol.

- The global warming potential of the refrigerant (R134a) used in this unit is 1300.
- The refrigerant quantity is stated in the Physical Data table in this document.
- The fluorinated greenhouse gases in this equipment may not be vented to the atmosphere.
- This equipment should only be serviced by qualified technicians.

## SEMI-HERMETIC YORK TWIN-SCREW COMPRESSORS

Compressors are direct drive, semi-hermetic, rotary twin-screw type, including: muffler, temperature actuated 'off-cycle' heater, IP55 terminal board and precision machined cast iron housing.

Reliable suction gas cooled, high efficiency, accessible hermetic compressor motor, full suction gas flow through mesh screen filter, with inherent internal thermal overload protection and external current overload on all three phases.

Continuous function, microprocessor controlled, Variable Speed Drive (VSD) shall provide valve-less, smooth capacity control from 100% down to 10% of chiller capacity.

In addition, elimination of the slide valve and associated unloading components has resulted in a 50% reduction in compressor moving parts.

# Product Description - continued

## EVAPORATOR

The evaporator is a shell and tube, hybrid falling film type heat exchanger. It contains a balance of flooded and falling film technology to optimize efficiency, minimize refrigerant charge, and maintain reliable control. A specifically designed distribution system provides uniform refrigerant flow for optimum performance.

## CONDENSER

The YVAA introduces micro-channel coil to the York screw compressor chiller line. The micro-channel maximizes condenser heat transfer, resulting in a smaller footprint, and reduces refrigerant charge by as much as 50%.

Each condenser coil is a single piece all aluminium construction including headers, tubes and fins to avoid galvanic corrosion due to dissimilar metals. Coils and headers are brazed as one piece. Integral sub-cooling is included. The design working pressure is 43 bar.

Multiple, standard low sound, high efficiency, TEAO motor driven fans move air through the coils. They are dynamically and statically balanced, direct drive with corrosion-resistant glass fibre reinforced composite blades moulded into low-noise, full airfoil cross sections, providing vertical air discharge from extended orifices for efficiency and low sound.

Fan motors are Totally Enclosed Air-Over (TEAO), squirrel-cage type and current protected. The direct drive motors feature double-sealed and permanently lubricated ball bearings, cutting down on maintenance cost over the life of the unit.

## REFRIGERANT CIRCUIT

An independent refrigerant circuit is provided per compressor. Each circuit uses copper refrigerant pipe formed on computer controlled bending machines to reduce the number of brazed joints resulting in a reliable and leak resistant system.

- Discharge lines are provided with a manual compressor shutoff service valve (See Options and Accessories for suction line service valve).
- The external oil separators, with no moving parts and designed for minimum oil carry-over, are mounted in the discharge line of the compressor.
- Liquid line components include: high absorption removable core filter-drier, sight glasses with moisture indicators, manual shut-off valve with charging port, orifice and electronic expansion valve.
- An economizer (flash) tank is located in each refrigerant circuit to increase the system efficiency. The design working pressure is 31 bar.

## ELECTRICAL

YORK has over 25 years of experience designing variable-speed drives specifically for chiller applications. The result is an extremely reliable air-cooled chiller system that offers industry leading efficiency at real world operating conditions, valve-less compressor loading/unloading, excellent capacity control, high power factor and soft start..

Incoming single point power is standard utilizing a lockable circuit breaker, 115 Vac control transformer, VSD, fan contactors, ON/OFF unit switch, microcomputer keypad and display, Chiller Control and VSD Logic boards, and relay boards.

Standard design includes IP55 rating, powder painted steel cabinet with hinged, latched, and gasket sealed outer doors equipped with wind struts for safer servicing. The panel includes a control display access door so that display and control features can be accessed without opening main cabinet doors.

All exposed power wiring is routed through liquid-tight, UV-stabilized, non-metallic conduit.

## BUILDING AUTOMATION SYSTEM CAPABILITIES

The E-Link Gateway provides an economical and versatile connection between York equipment and open/standard protocols. It efficiently manages the communication protocols currently used by York equipment, exposing the data in a consistent, organized, and defined fashion. The E-Link Gateway is available as a field-installed option on YVAA. A simple switch selection allows configuration of the required equipment profile and output protocol, which reduces equipment connectivity startup time.

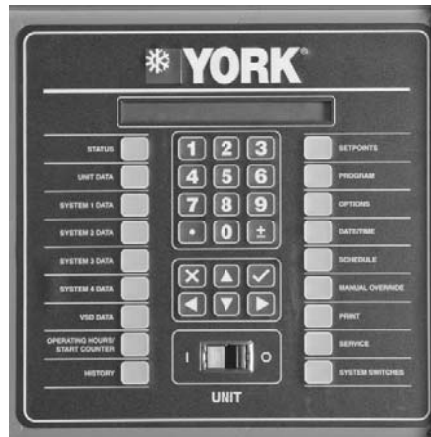

**FIG.1 – VIEW OF YORK CONTROL CENTER USER INTERFACE**

## MICROCOMPUTER CONTROL CENTER

The microcomputer control center (see Figure 1) provides automatic control of chiller operation including compressor start/ stop and load/unload anti-recycle timers, condenser fans, evaporator pump, evaporator heater, unit alarm contacts and run signal contacts. The microcomputer control center comes online as soon as the main power switch on the unit is switched on; immediately, the microcomputer control center will begin to check all variables with a frequency ranging from 30 seconds to almost continuous monitoring.

The microprocessor controls the unit's capacity by matching the actual leaving chilled liquid temperature (LCHLT) to the user-defined setpoint. Factors that may cause the system's actual LCHLT to fluctuate are changes in ambient temperature, loop flow rate, load, and loop volume. The control system reacts to such changes by adjusting the number of compressors that are on and the loading of each compressor in order to keep the LCHLT at the setpoint.

The control system logic monitors the rate at which the LCHLT is approaching the setpoint to ramp up or down compressor capacity as required. The variable frequency drive allows the compressor capacity to match the load.

### Display Data

- Leaving Chilled Liquid Temperature
- Returning Liquid Temperature
- Ambient Temperature
- Lead System
- Compressor Capacity (% of Full Load Amps)
- VSD Output Frequency / Compressor Speed
- Compressor Run Hours
- Compressor Number of Starts
- Oil Pressure and Temperature (per Compressor)

- Evaporator Pump Status
- Evaporator Heater Status
- History Data for Last Twenty Normal Shutdowns
- History Data for Last Ten Shutdown Faults

### Programmable Setpoints

- Chiller On/Off
- Chilled Liquid (Water or Glycol)
- Local or Remote Control
- Units of Measure (Imperial or SI)
- System Lead / Lag
- Remote Temperature Reset
- Remote Current Limit
- Leaving Chilled Liquid Temperature Setpoint and Range

Johnson Controls' systems or another vendor's systems can incorporate these setpoints and data outputs to give the customer a complete understanding of how the system is running through a Building Automation System.

**Extreme Conditions** - During extreme or unusual conditions (i.e. blocked condenser coils, ambient above scheduled maximum, etc.) the chiller control system will avoid shutdown by varying capacity. By monitoring motor current and suction and discharge pressures, the chiller can maintain maximum available cooling output without shutting down.

Unit Safeties are provided for the chiller to perform auto-reset shut down for the following conditions:

- Ambient temperature above or below allowable range
- Out of range leaving chilled liquid temperature
- Under voltage
- Flow switch operation

# Accessories and Options

All options factory mounted unless otherwise noted.

## SOUND ATTENUATION

**LOW NOISE KITS** – The standard chiller configuration is equipped with low sound fans and acoustic treatments on the refrigerant lines and compressors. There are several sound attenuation options available to further reduce sound at its source thereby meeting local sound level regulations.

**SilentNight™** - Due to time of day based sound regulations in some locations it may be desirable to force the chiller to a lower sound level on demand. The SilentNight control option provides a control input to limit sound output of the chiller based on time of day. This feature is programmable at the chiller panel or can be controlled remotely via a signal (4-20 mA or 0-10 VDC) from a BAS system.

## FAN OPTIONS

**ULTRA QUIET FANS** – The chiller is equipped with specially designed fans and motors to provide lower sound levels yet retain appropriate airflow. The result is reduced fan generated sound with minimal effect on the chiller capacity or efficiency.

**HIGH STATIC FANS** - The chiller is equipped with condenser fans with higher power motors suitable for high external static pressure, up to 100 Pa (0.4 in. water), across condenser coils. This option should be selected if additional airflow resistance may be present due to flow restrictions such as field installed ducts, filters, sound enclosures etc. Please contact your local JCI representative for more information.

**HIGH AIRFLOW FANS** - The chiller is equipped with condenser fans with airfoil type blades and high power motors providing extra airflow across coils. In some chiller configurations, this option can provide an increase in chiller capacity at high ambient. The high airflow fans are also available with variable speed control. Please contact your local JCI representative for more information.

## CONDENSER COIL PROTECTION

The aluminium alloys used in the YVAA micro-channel condenser have been carefully selected and tested for high corrosion resistance. However, all metals can corrode in harsh conditions. Consider protecting coils from corrosive environments such as coastal, marine, urban and industrial.

**POST-COATED EPOXY DIPPED CONDENSER** – Micro-channel condenser coils applied with electro-deposited and baked flexible epoxy coating that is finished with a polyurethane UV resistant top-coat suitable for highly corrosive applications.

## PROTECTIVE CHILLER PANELS

**WIRE PANELS** – UV stabilized black polyvinyl chloride coated, heavy gauge, welded wire mesh guards mounted on the exterior of the full unit. Protects condenser coil faces and prevents unauthorized access to refrigerant components (compressors, pipes, evaporator, etc.), yet provides free air flow. This can cut installation cost by eliminating the need for separate, expensive fencing. See Figure 2.

**LOUVERED PANELS** – Louvered panels, painted the same colour as the unit, enclose the unit to visually screen and protect the coils as well as preventing unauthorized access to internal components. Also available as a condenser-only option. See Figures 3 and 4.

**LOUVERED/WIRE PANELS COMBINATION** - Louvered panels, painted the same colour as the unit, are mounted on external condenser coil faces. Heavy gauge, welded wire-mesh panels, coated to resist corrosion, are mounted around base of machine to restrict unauthorized access. See Figure 5.

**END HAIL GUARD** – Louvered panels, painted the same colour as the unit, are installed on the rear of the unit (opposite end of the control panel) to protect the exposed condenser from flying debris or hail. See Figure 6.

**V-GUARD PANELS** – Solid panels, painted the same colour as the unit, are installed along the sides of the units to cover exposed piping within the condenser section without impacting airflow. These guard panels can be combined with End Hail Guard option for additional protection from debris. See Figure 7.

## EVAPORATOR OPTIONS:

**38 mm INSULATION** – Double thickness insulation provided.

**FLANGE KIT** – Provides contractor with the couplings best suited to tie into the chilled water piping. All flanges are PN10.

**CONNECTION LOCATION** - The standard unit configuration is available with fluid inlet connections at rear (opposite control panel end) of unit. Option available for front fluid inlet on select configurations.

# Accessories and Options - continued

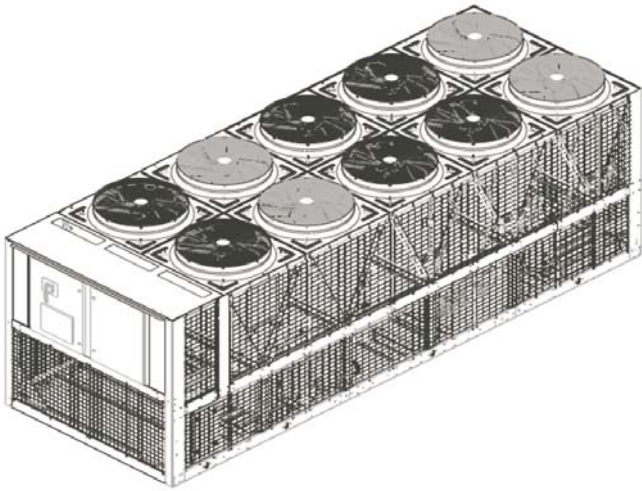

FIG. 2 – FULL UNIT WIRE PANELS

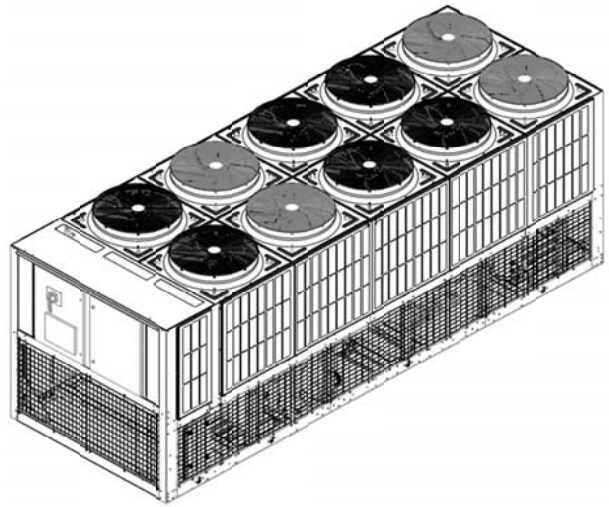

FIG. 5 – LOUVERED/WIRE PANELS COMBINATION

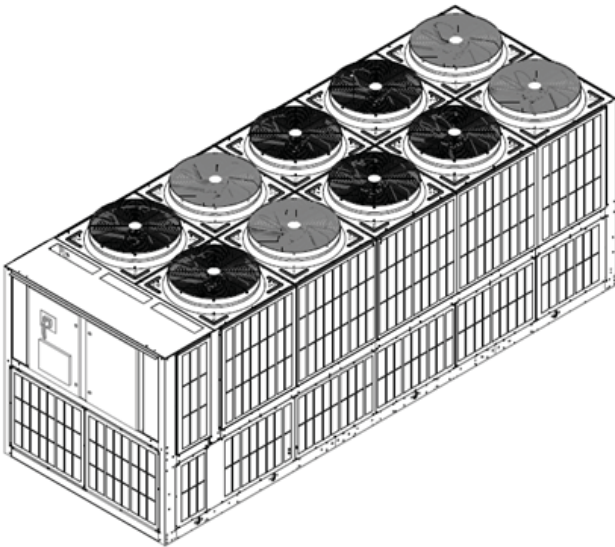

FIG. 3 – FULL UNIT LOUVERED PANELS

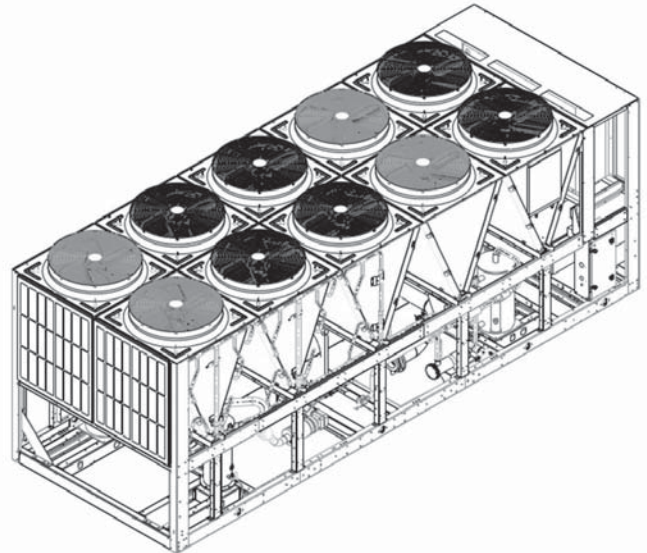

FIG. 6 – END HAIL GUARD

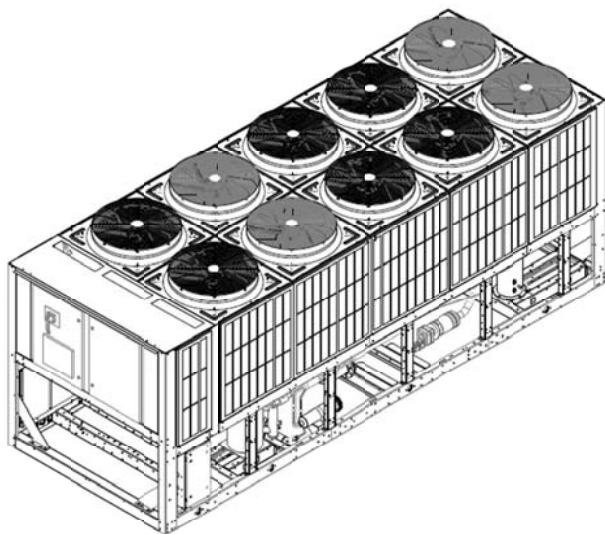

FIG. 4 – CONDENSERS-ONLY LOUVERED PANELS

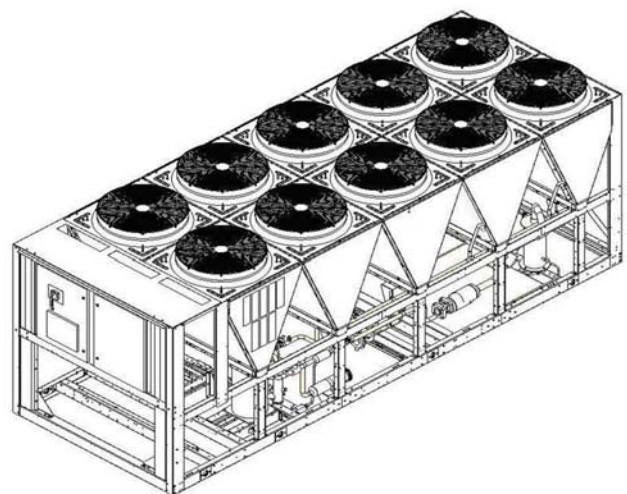

FIG. 7 – V-GUARD OPTION



# Accessories and Options - continued

**THREE-PASS** – The standard evaporator is constructed with two chilled water passes through the evaporator. The three-pass option is recommended for use in brine applications or where a greater water temperature difference is required but efficiency cannot be sacrificed.

**WATER BOX HEATER** - The standard unit comes with freeze protection on the evaporator down to -17.8°C (0°F). The waterbox heater option provides additional freeze protection down to -28°C (-20°F).

## CONTROLS OPTIONS:

**HIGH AMBIENT OPERATION** – This provides special control logic coupled with high airflow fans to permit high ambient (up to 52°C (125°F)) operation. Fans are airfoil type blades with high power motors. This option may also allow for increased machine capacity, allowing the selection of a smaller chassis to meet specific capacity requirements.

**BUILDING AUTOMATION SYSTEM INTERFACE (TEMPERATURE)** - Factory installed option to accept a 4 to 20 mA or a 0 to 10 VDC input to allow remote reset of the Leaving Chilled Liquid Temperature Setpoint. The setpoint can be positively offset upwards up to 22.2°C (40°F). This option is useful for ice storage or process applications or for periods where higher chilled liquid temperatures are adequate for low loads. Available alone or in combination with BAS Load Limit.

**BUILDING AUTOMATION SYSTEM INTERFACE (LOAD LIMIT)** - Factory installed option to accept a 4 to 20 mA or a 0 to 10 VDC input to allow remote reset of the Load Limit Setpoint. The setpoint can limit system demand from 30-100%. Available alone or in combination with BAS Temperature Reset.

**E-Link** – The E-Link gateway provides communication or Building Automation Systems, including BACnet (MS/TP), Modbus, LON and N2.

**THERMAL STORAGE** – Provides special control logic and modifications to produce leaving chilled brine temperatures below 4.4°C (40°F) primarily at times of low ambient temperatures (night time). Option can be used to produce ice to supplement cooling and significantly decrease energy costs. The capability of the chiller is enhanced by using both ice and chilled water simultaneously during times of peak cooling needs.

## GENERAL OPTIONS:

**FLOW SWITCH ACCESSORY** - Vapor proof SPDT, NEMA 3R switch, 10.3 barg (150 psig) DWP, -29°C to 121°C (-20°F to 250°F) with 1" NPT (IPS) connection for upright mounting in horizontal pipe (This flow switch or equivalent must be furnished with each unit). **Field mounted.**

**DIFFERENTIAL PRESSURE SWITCH** – This 0.2-3 barg (3-45 psig) range switch, with 1/4" NPTE pressure connections, is an alternative to the paddle-type flow switch. **Field mounted.**

**SERVICE ISOLATION VALVE** – Service suction isolation valve added to unit for each refrigerant circuit.

**DUAL PRESSURE RELIEF VALVE** – Two safety relief valves are mounted in parallel; one is always operational to assist in valve replacement during maintenance.

**CIRCUIT BREAKER** – A unit-mounted circuit breaker with external lockable handle will be supplied to isolate the single point power voltage for servicing. The circuit breaker is sized to provide motor branch circuit protection, short circuit protection and ground fault protection for the motor branch-circuit conductors, the motor control apparatus and the motors.

**NON-FUSED DISCONNECT SWITCH** – Unit-mounted disconnect switch with external lockable handle can be supplied to isolate the unit power voltage for servicing. Separate external fusing must be supplied by the power wiring, which must comply with local codes.

## VIBRATION ISOLATION:







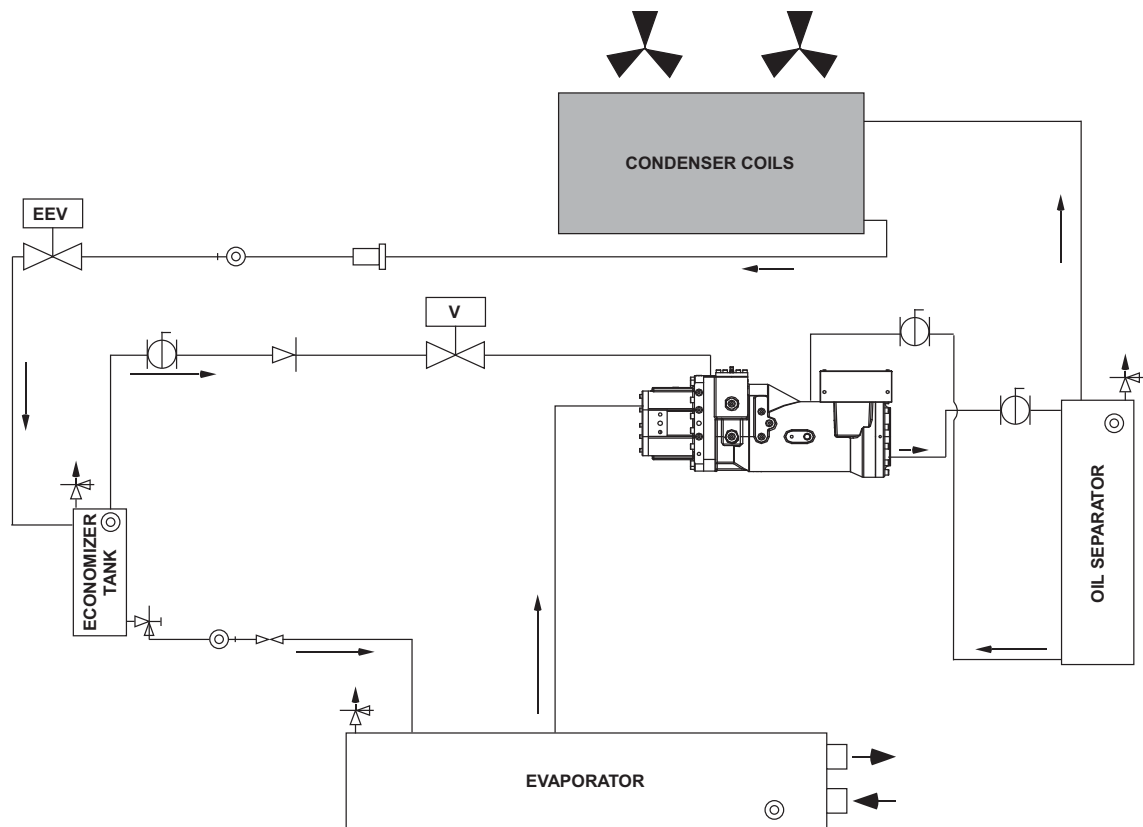

**ELASTOMERIC ISOLATION** – This option is recommended for normal installations. It provides very good performance in most applications for the least cost. **Field mounted.**

**25 mm (1") SPRING ISOLATORS** – Spring and cage type isolators for mounting under the unit base rails are available to support unit. They are level adjustable. 25 mm (1") nominal deflection may vary slightly by application. **Field mounted.**

**50 mm (2") RESTRAINED SPRING ISOLATORS** – Restrained Spring-Flex Mounting isolators incorporate a rugged welded steel housing with vertical and horizontal limit stops. Housings designed to withstand a minimum 1.0g accelerated force in all directions up to 51mm (2"). The deflection may vary slightly by application. They are level adjustable. **Field mounted.**

# Refrigerant Piping Layout



	YVAA System Component
	Electronic Expansion Valve
	Ball Valve
	Relief Valve
	Stop Valve Angle, Access
	Replaceable Core Filter/Dryer
	Sight Glass
	Orifice
	Check Valve
	Valve

Low pressure refrigerant (liquid and gas) enters the evaporator and is sprayed across the top of the tube bundle from spray nozzles. The liquid refrigerant from the nozzles gravity drains down across the tube bundle and is evaporated and superheated by the heat energy absorbed from the chilled liquid passing through the tubes.

The low pressure refrigerant vapour leaves the top of the evaporator and enters the compressor where the refrigerant vapour is compressed and the pressure and superheat are increased. The high pressure superheated gas enters the air cooled condenser where heat is rejected via the condenser coils and fans.

The fully condensed and sub-cooled liquid leaves the air cooled condenser, flows through the filter drier and enters the economizer (flash) tank. The flow of refrigerant into the economizer is controlled by the electronic expansion valve.

Additional cooling of the refrigerant liquid may take place in the economizer tank when the economizer valve is opened. After leaving the economizer tank, liquid refrigerant flows through an orifice where pressure reduction and further cooling takes place. The low pressure refrigerant (liquid and gas) then enters the evaporator.

# Application Data

## UNIT SIZING

Avoid over-sizing a chiller. Properly sized chillers operate stably and provide the best life cycle cost. When designing phased projects, select multiple small chillers to match demand for each phase. Use multiple small chillers when the minimum cooling demand is less than 10% of the maximum cooling demand.

## UNIT LOCATION

The YVAA chillers are designed for outdoor installation. To achieve optimum performance and trouble-free service provide adequate space around chillers (see Figure 8). When selecting chiller installation sites, follow these requirements:

1. Installation sites may be either on a roof or on ground level. (See **FOUNDATION**)
2. Provide space for air to flow into condensers per Figure 8. Restricted airflow or hot air recirculation will diminish performance. Johnson Controls' unit controls will optimize the operation without nuisance high pressure safety cutouts; however, the system designer **MUST** consider potential performance degradation. Recommended clearances for all units are as follows:
  - a. Access to the unit control center stipulates the unit is no higher than on spring isolators.
  - b. Recommended minimum clearances:
    - i. Side to wall – 1.8 m
    - ii. Rear to wall – 1.8 m
    - iii. Control panel end to wall – 1.2 m
    - iv. Top – no obstructions whatsoever
    - v. Distance between adjacent units – 3 m
  - c. No more than one adjacent wall may be higher than the unit
3. Avoid locations near windows or structures where normal operating sounds may be objectionable.
4. The condenser fans are propeller-type and are not recommended for use with ductwork, filters or other impediments to airflow in the condenser air stream.
5. When obstructions to airflow exist, they must not add more than 25 Pascal (0.1") external static pressure.
6. Protection against corrosive environments is available by ordering the units with cured epoxy-coating on the condenser micro-channel. Epoxy-coated coils should be used with any units being installed at the seashore, or where salt spray may hit the units, or where acid rain is prevalent.
7. On installations where winter operation is intended and snow accumulations are expected, additional elevation must be provided to insure normal condenser air flow.
8. Provide adequate space for tubes to be removed from evaporator. For clearances please contact your nearest Johnson Controls Sales Office.

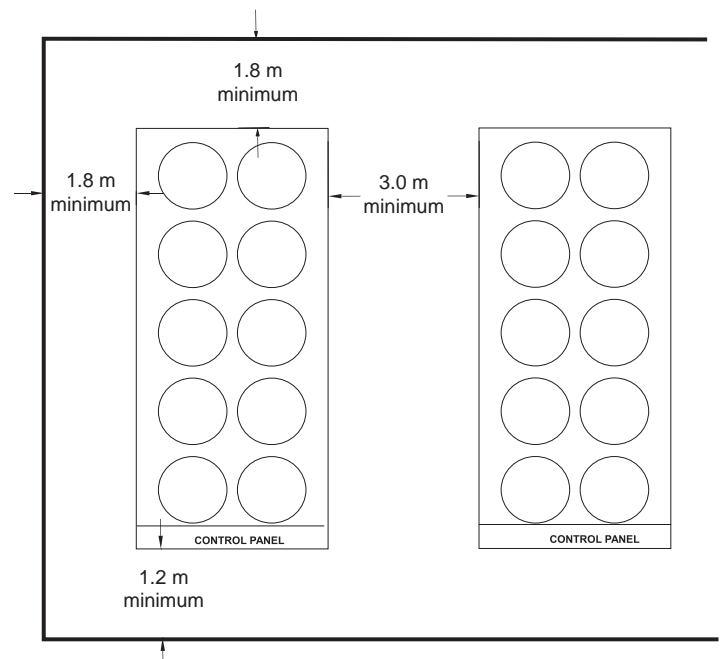

**FIG 8. – ACCEPTABLE MINIMUM CLEARANCES AROUND/BETWEEN UNIT(S) FOR PROPER AIRFLOW**

## FOUNDATION

Mount units on a flat and level foundation, ground or roof, capable of supporting the entire operating weight of the equipment. Please contact your nearest Johnson Controls Sales Office for shipping and operating weights.

**Roof Locations** – Provide structure to safely support the entire weight of the unit and service personnel. Do not damage the roof during installation. If the roof is “bonded”, consult a building contractor or architect for special installation requirements. Use spring isolators to minimize vibration transmission into building structure. Provide additional structural support at the spring-isolator locations.

**Ground Locations** – Units must be installed on a substantial base that will not settle and cause strain on the refrigerant lines, resulting in possible leaks. A one-piece concrete slab, with footers extending below the frost line is recommended. The slab should not be tied to the main building foundation as operational noise will telegraph. Mounting holes (5/8”) are provided in the base rails for bolting the unit to its foundation.

For ground installations, precautions should be taken to protect the unit from tampering by, or injury to, unauthorized persons. Fasteners on access panels will prevent casual tampering; however, further safety precautions such as unit enclosure options, a fenced-in enclosure, or locking devices on the panels may be advisable. Check local authorities for safety regulations.

# Application Data - continued

**Seismic Applications** – Avoid installing chillers on springs or roofs where earthquakes are a risk. Springs and roofs amplify earthquake forces. Rigidly mounting chillers to ground level concrete pads is typically the best option for earthquake zones. Contact Johnson Controls equipment specialists for help with projects that have seismic requirements.

## CHILLED LIQUID PIPING

Design the chilled liquid piping system so that the circulating pump discharges into the evaporator. Hand stop valves are recommended in all lines to facilitate servicing. Provide drain connections at low points to permit complete drainage of the evaporator and system piping.

A strainer (40 mesh) is recommended for use on the **INLET** line to the evaporator, and must be in place at the initial operation of the water pumps.

The evaporator must not be exposed to flushing velocities or debris released during flushing. It is recommended that a suitably sized bypass and valve arrangement is installed to allow flushing of the piping system. The bypass can be used during maintenance to isolate the heat exchanger without disrupting flow to other units.

Pressure-gauge connections are recommended for installation in the inlet and outlet water lines. Gauges are not provided with the unit and are to be furnished by others.

Chilled liquid lines exposed to the weather should be wrapped with a supplemental heater cable and insulated, or glycol should be added to the chilled liquid to protect against freezing if low-ambient periods are expected.

A flow switch is available as an accessory on all units. A flow switch must be installed in the leaving water piping of the evaporator and must not be used to start and stop the unit.

## MINIMUM WATER VOLUME

It is good practice to include as much water volume as possible in a chilled water loop. This increases the thermal mass and “Flywheel” effect within the system (i.e. the more; the better) which in turn promotes stable water temperature control and increases reliability by reducing compressor cycling.

For air conditioning applications, a minimum of 3.2 litres per cooling kW is required. It is preferred that the litre per cooling kW ratio be within 5.4 to 8.6 l/kW range for constant flow rate chilled liquid systems.

For process applications, a minimum of 6.5 litres per cooling kW ratio is required with preference towards a range of 7.5 to 11.8 l/kW. Install a tank or increase pipe sizes to provide sufficient water volume.

## LEAVING WATER TEMPERATURE OUT OF RANGE

The YVAA chiller line has a maximum leaving water temperature of 15.6°C (60°F). Some process applications require a chilled water temperature higher than what the chiller provides. In those applications, a simple piping change can remove the problem. By using a mixture of chiller-cooled water and returning process water, the chilled water entering the process can be held at the desired temperature. (A tank can also be used to meet high leaving water temperature requirements.) (See Figure 9)

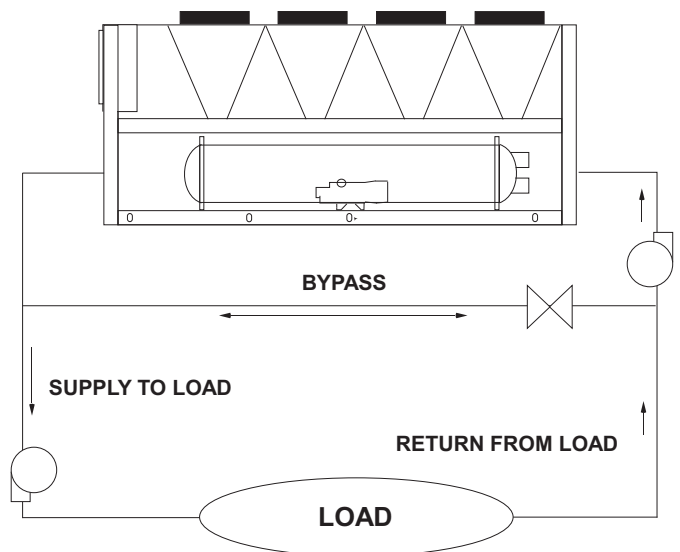

**FIG. 9 – LEAVING WATER TEMPERATURE OUT OF RANGE SUGGESTED LAYOUT**

## FLOW RATE OUT OF RANGE

Each YVAA evaporator has a minimum and maximum flow rate. Some process applications require a flow rate that is out of range for the evaporator. In those applications, a piping change can remove the problem.

In applications where the required flow rate is less than the evaporator’s minimum allowable, the chilled water can be recirculated to the chiller. (See Figure 10)

In applications where the required flow rate is greater than the evaporator’s maximum allowable, the chilled water can be recirculated to the load (see Figure 11).

# Application Data - continued

## THERMAL STORAGE

Thermal storage is the practice of storing cooling energy during a period of little or no load and/or low energy costs for use during periods of high load and/or energy costs. Conventional cooling systems produce cooling when it is needed which is commonly during times of peak demand. Thermal storage allows generation of cooling capacity to occur during off-peak periods and store that capacity to meet future cooling requirements. Using thermal storage can result in smaller equipment sizes, thereby reducing capital cost, and also can result in significant energy cost savings.

The YVAA has special control logic to be able to produce chilled leaving brine temperatures below 4.4°C (40°F) so as to supply a storage tank with chilled liquid during times of low demand. YVAA chillers selected for thermal storage operation can also be selected to efficiently provide chilled fluid at nominal cooling loads.

## VARIABLE PRIMARY FLOW

Johnson Controls recommends a maximum 10% per minute flow rate of change, based on design flow, for variable primary flow applications. Provide 8.6 to 10.8 litre per cooling kW system water volume. Insufficient system volume and rapid flow changes can cause control problems or can even cause chiller shutdowns. There are many other design issues to evaluate with variable primary flow systems. Consult your Johnson Controls Sales Office for more information about successfully applying YVAA chillers.

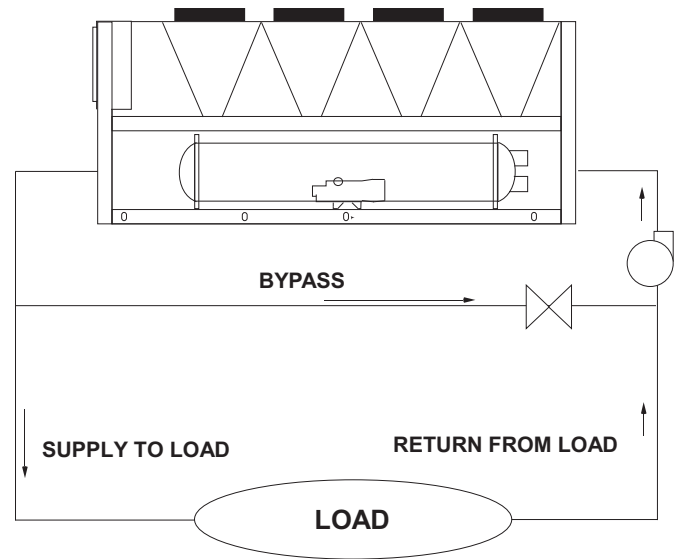

**FIG. 10 – SUGGESTED LAYOUT FOR APPLICATIONS WITH A FLOW RATE LESS THAN THE EVAPORATOR MINIMUM ALLOWABLE FLOW RATE**

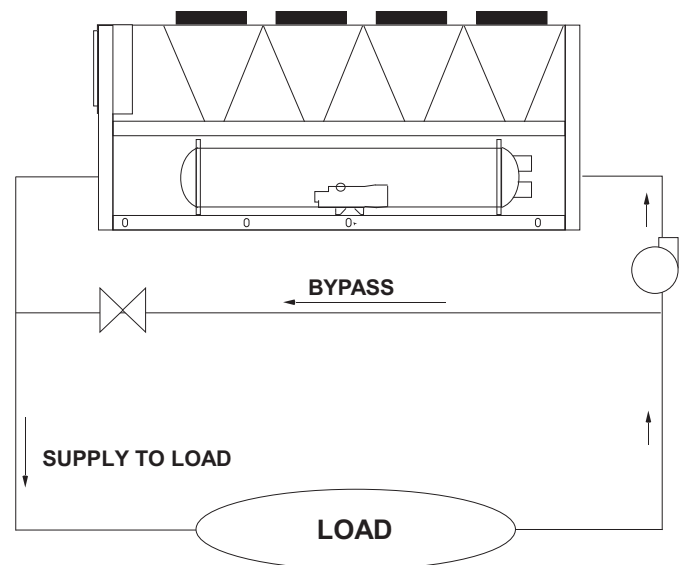

**FIG. 11 – SUGGESTED LAYOUT FOR APPLICATIONS WITH A FLOW RATE GREATER THAN THE EVAPORATOR MAXIMUM ALLOWABLE FLOW RATE**

# Physical Data

The data shown in the tables below is applicable to selected typical configurations. Other configurations are available through our configuration/selection software. Please contact your nearest Johnson Controls Sales Office for the chiller configuration that best matches your specific needs.

UNIT FRAME	054	056	058	064	066	068	070	074	076	078	084	086	088
<b>CONDENSER CODE</b>	<b>3</b>	<b>5</b>	<b>8</b>	<b>3</b>	<b>5</b>	<b>8</b>	<b>0</b>	<b>3</b>	<b>5</b>	<b>8</b>	<b>3</b>	<b>5</b>	<b>8</b>
<b>EVAPORATOR CODE</b>	<b>B</b>	<b>B</b>	<b>C</b>	<b>A</b>	<b>A</b>	<b>B</b>	<b>C</b>	<b>A</b>	<b>C</b>	<b>C</b>	<b>B</b>	<b>C</b>	<b>C</b>
<b>GENERAL UNIT DATA</b>													
Number of Independent Refrigerant Circuits	2												
Refrigerant Charge, R-134a, Ckt.-1/Ckt.-2, kg	80/80	86/86	102/102	80/70	86/78	100/89	93/93	80/80	102/102	109/109	96/86	114/102	114/114
Oil Charge, Ckt.-1/Ckt.-2, liters	8.0/7.7	8.5/8.5	9.3/9.3	9.2/7.7	9.7/8.0	10.4/8.5	10.0/10.0	9.3/9.3	10.5/10.5	10.8/10.8	10.1/9.7	11.1/10.5	11.1/11.1
% Minimum Load	10%												
Unit Shipping Weight, kg <sup>1</sup>	5224	5481	6653	5452	5797	6248	6074	5833	6765	7111	6027	7200	7545
Operating Weight, kg <sup>1</sup>	5434	5691	7000	5652	5997	6458	6421	6033	7111	7457	6237	7546	7891
Chassis Dimensions - Length, mm	5163	6280	7397	6274	7397	8514	5741	7397	7397	8514	7397	8514	9631
Chassis Dimensions - Width, mm	2242	2242	2242	2242	2242	2242	2242	2242	2242	2242	2242	2242	2242
Chassis Dimensions - Height, mm	2403	2403	2403	2403	2403	2403	2403	2403	2403	2403	2403	2403	2403
<b>COMPRESSORS, SEMI-HERMETIC SCREW</b>													
Qty per Chiller	2												
<b>CONDENSER FANS</b>													
Number Ckt-1/Ckt-2	4/4	5/5	6/6	6/4	7/5	8/6	4/4	6/6	6/6	7/7	7/5	8/6	8/8
Air on Condenser (Min/Max), °C	-17.8/51.7												
<b>EVAPORATOR, SHELL AND TUBE HYBRID FALLING FILM <sup>2</sup></b>													
Water Volume, liters	220	220	269	182	182	220	269	182	269	269	220	269	269
Leaving Water Temperature (Min/Max), °C <sup>3</sup>	4.4/15.6												
Maximum Water Side Pressure, bar	10.3												
Maximum Refrigerant Side Pressure, bar	16.2												
Evap Drain Connection, in	3/4												

## NOTES:

- Shipping and operating weights shown are for base unit; selected options may add weight to unit. Contact your nearest Johnson Controls Sales office for weight data.
- The evaporator is protected against freezing to -17.8°C (0°F) with a standard heater.
- For leaving brine temperature below 4.4°C (40°F) or above 15.6°C (60°F), contact your nearest Johnson Controls Sales Office for application requirements.

# Physical Data - continued

The data shown in the tables below is applicable to selected typical configurations. Other configurations are available through our configuration/selection software. Please contact your nearest Johnson Controls Sales Office for the chiller configuration that best matches your specific needs.

UNIT FRAME	094	096	096	098	101	109	106	108	118	114	117	119	121
<b>CONDENSER CODE</b>	<b>3</b>	<b>3</b>	<b>5</b>	<b>8</b>	<b>5</b>	<b>3</b>	<b>5</b>	<b>8</b>	<b>8</b>	<b>3</b>	<b>3</b>	<b>3</b>	<b>5</b>
<b>EVAPORATOR CODE</b>	<b>B</b>	<b>D</b>	<b>E</b>	<b>E</b>	<b>E</b>	<b>C</b>	<b>C</b>	<b>E</b>	<b>E</b>	<b>E</b>	<b>C</b>	<b>E</b>	<b>E</b>
<b>GENERAL UNIT DATA</b>													
Number of Independent Refrigerant Circuits	2												
Refrigerant Charge, R-134a, Ckt.-1/Ckt.-2, kg	96/96	120/120	121/121	123/123	141/120	132/111	134/114	143/125	143/134	134/134	132/132	141/141	143/143
Oil Charge, Ckt.-1/Ckt.-2, liters	10.1/10.1	11.4/11.4	11.4/11.4	11.6/11.6	15.9/11.7	15.5/11.4	15.5/11.4	16.3/12.1	16.3/12.5	15.5/15.5	15.5/15.5	15.9/15.9	16.3/16.3
% Minimum Load	10%												
Unit Shipping Weight, kg <sup>1</sup>	6385	7382	7707	8052	8258	7763	8603	8603	8948	8416	8266	8761	9107
Operating Weight, kg <sup>1</sup>	6594	7758	8097	8442	8648	8109	8993	8993	9339	8806	8612	9151	9497
Chassis Dimensions - Length, mm	8514	8514	8514	9631	9631	9631	10748	10748	11865	9631	10748	10748	11865
Chassis Dimensions - Width, mm	2242	2242	2242	2242	2242	2242	2242	2242	2242	2242	2242	2242	2242
Chassis Dimensions - Height, mm	2403	2403	2403	2403	2403	2403	2403	2403	2403	2403	2403	2403	2403
<b>COMPRESSORS, SEMI-HERMETIC SCREW</b>													
Qty per Chiller	2												
<b>CONDENSER FANS</b>													
Number Ckt-1/Ckt-2	7/7	7/7	7/7	8/8	9/7	9/7	10/8	10/8	10/10	8/8	9/9	9/9	10/10
Air on Condenser (Min/Max), °C	-17.8/51.7												
<b>EVAPORATOR, SHELL AND TUBE HYBRID FALLING FILM <sup>2</sup></b>													
Water Volume, liters	220	310	428	428	428	269	269	428	428	428	269	428	428
Leaving Water Temperature (Min/Max), °C <sup>3</sup>	4.4/15.6												
Maximum Water Side Pressure, bar	10.3												
Maximum Refrigerant Side Pressure, bar	16.2												
Evap Drain Connection, in	3/4												

## NOTES:

- Shipping and operating weights shown are for base unit; selected options may add weight to unit. Contact your nearest Johnson Controls Sales office for weight data.
- The evaporator is protected against freezing to -17.8°C (0°F) with a standard heater.
- For leaving brine temperature below 4.4°C (40°F) or above 15.6°C (60°F), contact your nearest Johnson Controls Sales Office for application requirements.

# Evaporator Options

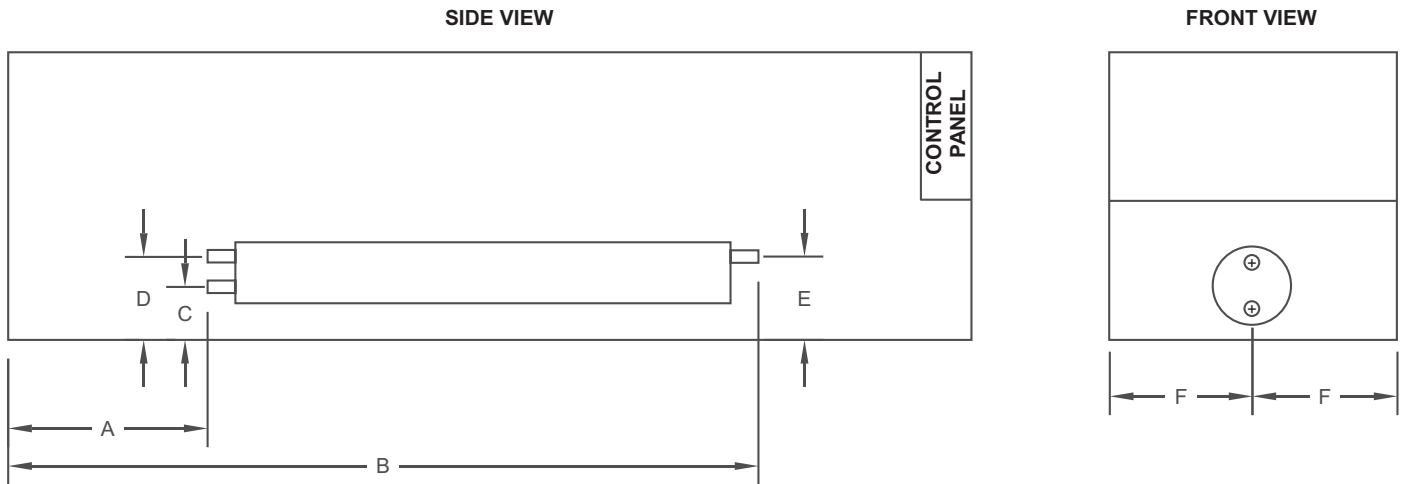

ALL DIMENSIONS IN mm

YVAA MODEL			STANDARD (TWO-PASS, REAR INLET/OUTLET) EVAPORATOR								OPTIONAL THREE-PASS REAR INLET/FRONT OUTLET EVAPORATOR								
FRAME	COND.	EVAP.	A	C	D	F	CONN. SIZE	WATER VOL. LITRES	MINIMUM CHILLED WATER FLOW RATE l/s	MAXIMUM CHILLED WATER FLOW RATE l/s	A	B	C	E	F	CONN. SIZE	WATER VOL. LITRES	MINIMUM CHILLED WATER FLOW RATE l/s	MAXIMUM CHILLED WATER FLOW RATE l/s
054	3	B	176	384	674	1121	6	220	16	60	176	4291	384	674	1121	5	220	10	38
056	5	B	745	384	674	1121	6	220	16	60	745	4860	384	674	1121	5	220	10	38
058	8	C	887	384	674	1121	6	269	19	73	887	5611	384	674	1121	6	269	13	47
064	3	A	449	359	649	1121	6	182	13	47	449	4831	359	649	1121	5	182	8	32
066	5	A	1563	359	649	1121	6	182	13	47	1563	5945	359	649	1121	5	182	8	32
068	8	B	2979	388	678	1121	6	220	16	60	2979	7094	388	678	1121	5	220	10	38
070	0	C	43	384	674	1121	6	269	19	73	43	4767	384	674	1121	6	269	13	47
074	3	A	1566	359	649	1121	6	182	13	47	1566	5948	359	649	1121	5	182	8	32
076	5	C	887	384	674	1121	6	269	19	73	887	5611	384	674	1121	6	269	13	47
078	8	C	2004	388	678	1121	6	269	19	73	2004	6728	388	678	1121	6	269	13	47
084	3	B	1862	384	674	1121	6	220	16	60	1862	5977	384	674	1121	5	220	10	38
086	5	C	2359	388	678	1121	6	269	19	73	2359	7083	388	678	1121	6	269	13	47
088	8	C	3121	388	678	1121	6	269	19	73	3121	7845	388	678	1121	6	269	13	47
094	3	B	2979	388	678	1121	6	220	16	60	2979	7094	388	678	1121	5	220	10	38
096	3	D	1090	388	678	1121	6	310	19	73	1090	6729	388	678	1121	6	310	13	47
096	5	E	1125	394	749	1121	8	428	25	95	1125	6688	394	749	1121	6	428	19	54
098	8	E	2242	394	749	1121	8	428	25	95	2242	7805	394	749	1121	6	428	19	54
101	5	E	2242	394	749	1121	8	428	25	95	2242	7805	394	749	1121	6	428	19	54
109	3	C	3121	388	678	1121	6	269	19	73	3121	7845	388	678	1121	6	269	13	47
106	5	C	4235	384	674	1121	6	269	19	73	4235	8959	384	674	1121	6	269	13	47
108	8	E	3359	394	749	1121	8	428	25	95	3359	8922	394	749	1121	6	428	19	54
118	8	E	4476	394	749	1121	8	428	25	95	4476	10039	394	749	1121	6	428	19	54
114	3	E	2242	394	749	1121	8	428	25	95	2242	7805	394	749	1121	6	428	19	54
117	3	C	4238	388	678	1121	6	269	19	73	4238	8962	388	678	1121	6	269	13	47
119	3	E	3359	394	749	1121	8	428	25	95	3359	8922	394	749	1121	6	428	19	54
121	5	E	4476	394	749	1121	8	428	25	95	4476	10039	394	749	1121	6	428	19	54



# Dimensions

The data shown in this table is applicable to selected typical configurations. Other configurations are available through our configuration/selection software. Please contact your nearest Johnson Controls Sales Office for the chiller configuration that best matches your specific needs.

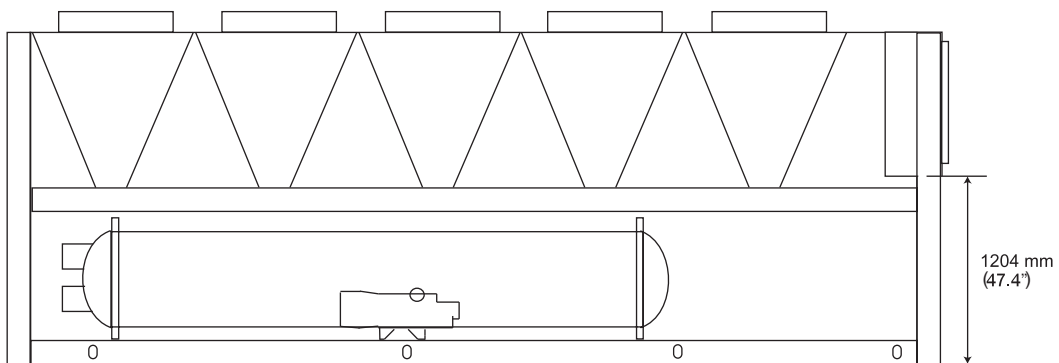
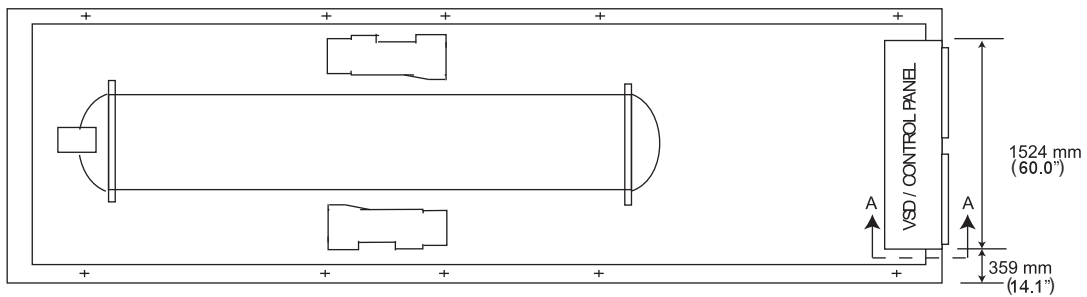
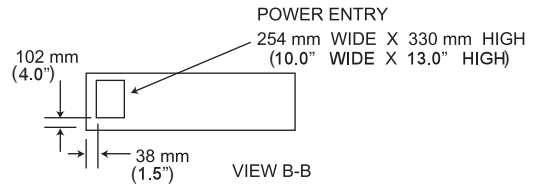
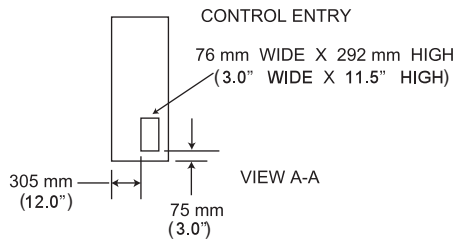
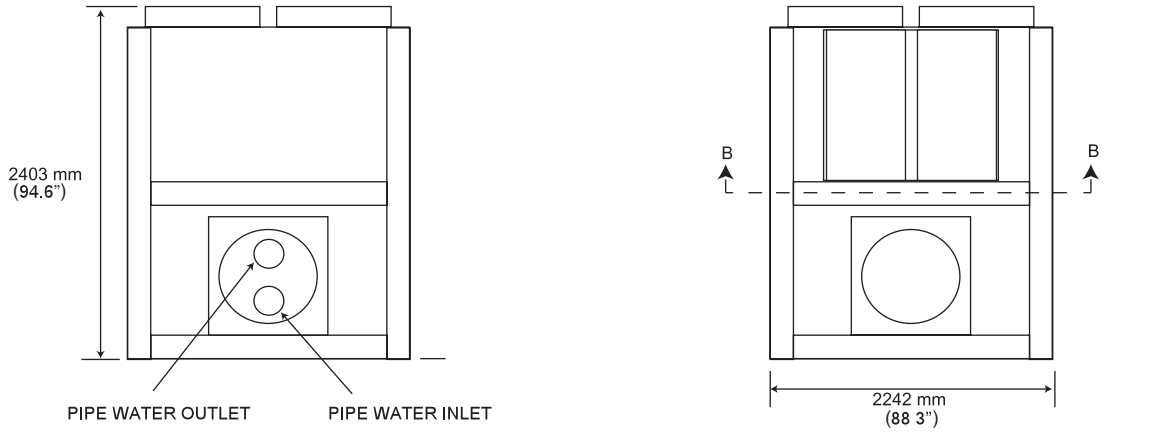

**Notes:**

1. VSD / Control panel doors extend beyond the end of the unit base by 54 mm (2 1/8").
2. Standard circuit breaker handle extends beyond the end of the unit base by 102 mm (4").

# Electrical Data

The data shown in the tables below is applicable to selected typical configurations. Other configurations are available through our configuration/selection software. Please contact your nearest Johnson Controls Sales Office for the chiller configuration that best matches your specific needs.

FIELD WIRING LUGS					STANDARD & ULTRA QUIET CONDENSER FANS			
					CIRCUIT BREAKER		NON-FUSED DISCONNECT SWITCH	
YVAA MODEL			INPUT VOLTS	INPUT FREQ	WIRES PER PHASE	LUG WIRE RANGE	WIRES PER PHASE	LUG WIRE RANGE
FRAME	COND	EVAP						
054	3	B	400	50	2	#2/0 ~ 500 kcmil	2	#2 - 600 kcmil
056	5	B	400	50	2	#2/0 ~ 500 kcmil	2	#2 - 600 kcmil
058	8	C	400	50	2	#2/0 ~ 500 kcmil	2	#2 - 600 kcmil
064	3	A	400	50	2	#1 - 500 kcmil	3	#2 - 600 kcmil
066	5	A	400	50	2	#1 - 500 kcmil	3	#2 - 600 kcmil
068	8	B	400	50	2	#1 - 500 kcmil	3	#2 - 600 kcmil
070	0	C	400	50	3	3/0 ~ 400 kcmil	3	#2 - 600 kcmil
074	3	A	400	50	2	#1 - 500 kcmil	3	#2 - 600 kcmil
076	5	C	400	50	2	#1 - 500 kcmil	3	#2 - 600 kcmil
078	8	C	400	50	2	#1 - 500 kcmil	3	#2 - 600 kcmil
084	3	B	400	50	3	3/0 ~ 400 kcmil	3	#2 - 600 kcmil
086	5	C	400	50	3	3/0 ~ 400 kcmil	3	#2 - 600 kcmil
088	8	C	400	50	3	3/0 ~ 400 kcmil	3	#2 - 600 kcmil
094	3	B	400	50	3	3/0 ~ 400 kcmil	3	#2 - 600 kcmil
096	3	D	400	50	3	3/0 ~ 400 kcmil	3	#2 - 600 kcmil
096	5	E	400	50	3	3/0 ~ 400 kcmil	3	#2 - 600 kcmil
098	8	E	400	50	3	3/0 ~ 400 kcmil	3	#2 - 600 kcmil
101	5	E	400	50	4	#4/0 ~ 500 kcmil	3	#2 - 600 kcmil
109	3	C	400	50	4	#4/0 ~ 500 kcmil	3	#2 - 600 kcmil
106	5	C	400	50	4	#4/0 ~ 500 kcmil	3	#2 - 600 kcmil
108	8	E	400	50	4	#4/0 ~ 500 kcmil	3	#2 - 600 kcmil
118	8	E	400	50	4	#4/0 ~ 500 kcmil	3	#2 - 600 kcmil
114	3	E	400	50	4	#4/0 ~ 500 kcmil	3	#2 - 600 kcmil
117	3	C	400	50	4	#4/0 ~ 500 kcmil	3	#2 - 600 kcmil
119	3	E	400	50	4	#4/0 ~ 500 kcmil	3	#2 - 600 kcmil
121	5	E	400	50	4	#4/0 ~ 500 kcmil	3	#2 - 600 kcmil

FIELD WIRING LUGS					HIGH AIR FLOW / HIGH STATIC CONDENSER FANS			
					CIRCUIT BREAKER		NON-FUSED DISCONNECT SWITCH	
YVAA MODEL			INPUT VOLTS	INPUT FREQ	WIRES PER PHASE	LUG WIRE RANGE	WIRES PER PHASE	LUG WIRE RANGE
FRAME	COND	EVAP						
054	3	B	400	50	2	#1 - 500 kcmil	3	#2 - 600 kcmil
056	5	B	400	50	2	#1 - 500 kcmil	3	#2 - 600 kcmil
058	8	C	400	50	2	#1 - 500 kcmil	3	#2 - 600 kcmil
064	3	A	400	50	3	3/0 ~ 400 kcmil	3	#2 - 600 kcmil
066	5	A	400	50	3	3/0 ~ 400 kcmil	3	#2 - 600 kcmil
068	8	B	400	50	3	3/0 ~ 400 kcmil	3	#2 - 600 kcmil
070	0	C	400	50	3	3/0 ~ 400 kcmil	3	#2 - 600 kcmil
074	3	A	400	50	3	3/0 ~ 400 kcmil	3	#2 - 600 kcmil
076	5	C	400	50	3	3/0 ~ 400 kcmil	3	#2 - 600 kcmil
078	8	C	400	50	3	3/0 ~ 400 kcmil	3	#2 - 600 kcmil
084	3	B	400	50	3	3/0 ~ 400 kcmil	3	#2 - 600 kcmil
086	5	C	400	50	3	3/0 ~ 400 kcmil	3	#2 - 600 kcmil
088	8	C	400	50	3	3/0 ~ 400 kcmil	3	#2 - 600 kcmil
094	3	B	400	50	3	3/0 ~ 400 kcmil	3	#2 - 600 kcmil
096	3	D	400	50	3	3/0 ~ 400 kcmil	3	#2 - 600 kcmil
096	5	E	400	50	3	3/0 ~ 400 kcmil	3	#2 - 600 kcmil
098	8	E	400	50	3	3/0 ~ 400 kcmil	3	#2 - 600 kcmil
101	5	E	400	50	4	#4/0 ~ 500 kcmil	4*	#2 - 600 kcmil
109	3	C	400	50	4	#4/0 ~ 500 kcmil	4*	#2 - 600 kcmil
106	5	C	400	50	4	#4/0 ~ 500 kcmil	4*	#2 - 600 kcmil
108	8	E	400	50	4	#4/0 ~ 500 kcmil	4*	#2 - 600 kcmil
118	8	E	400	50	4	#4/0 ~ 500 kcmil	4*	#2 - 600 kcmil
114	3	E	400	50	4	#4/0 ~ 500 kcmil	4*	#2 - 600 kcmil
117	3	C	400	50	4	#4/0 ~ 500 kcmil	4*	#2 - 600 kcmil
119	3	E	400	50	4	#4/0 ~ 500 kcmil	4*	#2 - 600 kcmil
121	5	E	400	50	4	#4/0 ~ 500 kcmil	4*	#2 - 600 kcmil

# Power Wiring

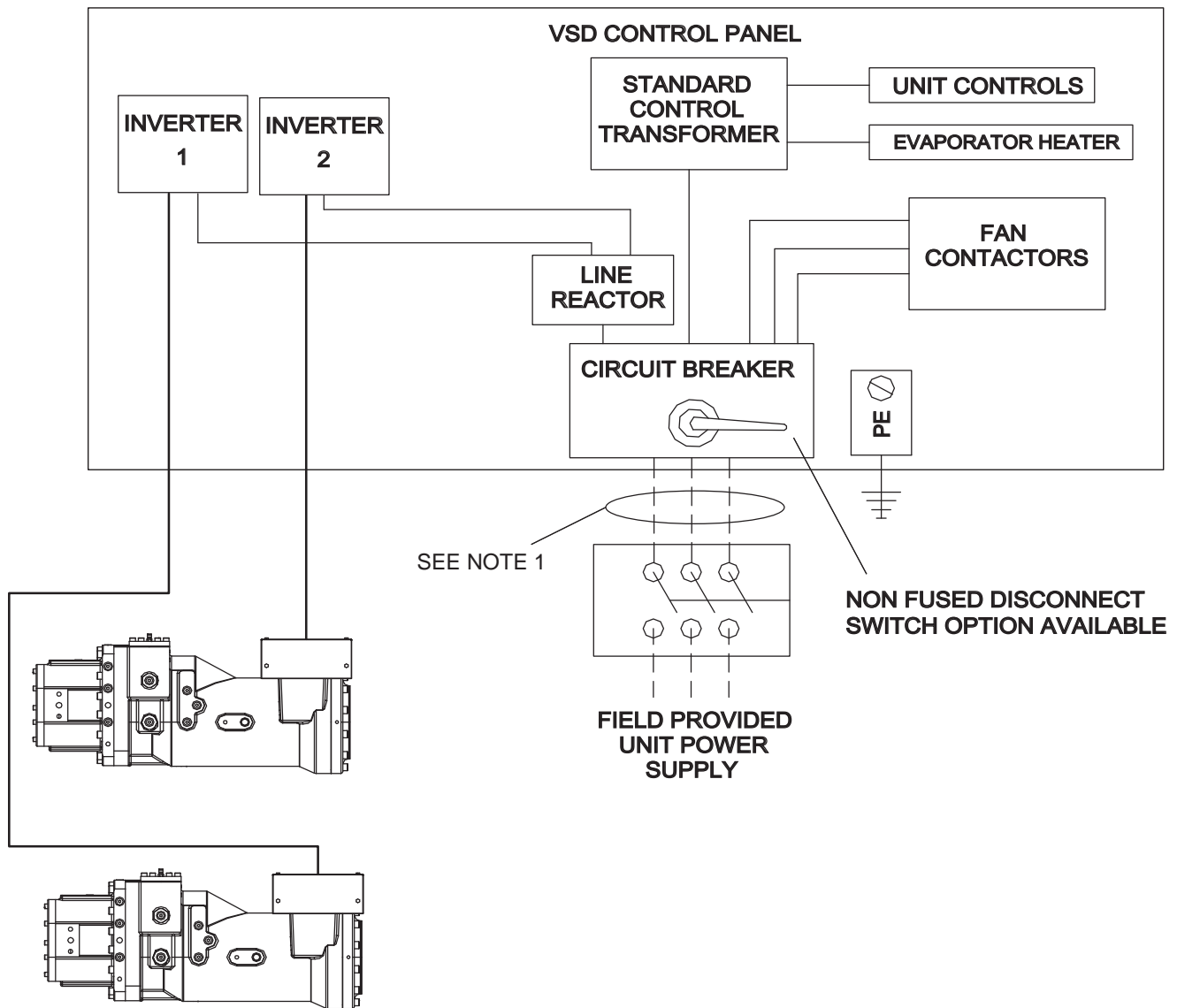

FIG. 12 – POWER WIRING DIAGRAM

**NOTES:**

1. ----- Dashed Line = Field Provided Wiring
2. The transformer is located in a separate box that is attached to the bottom of the control panel.

# Customer Control Wiring

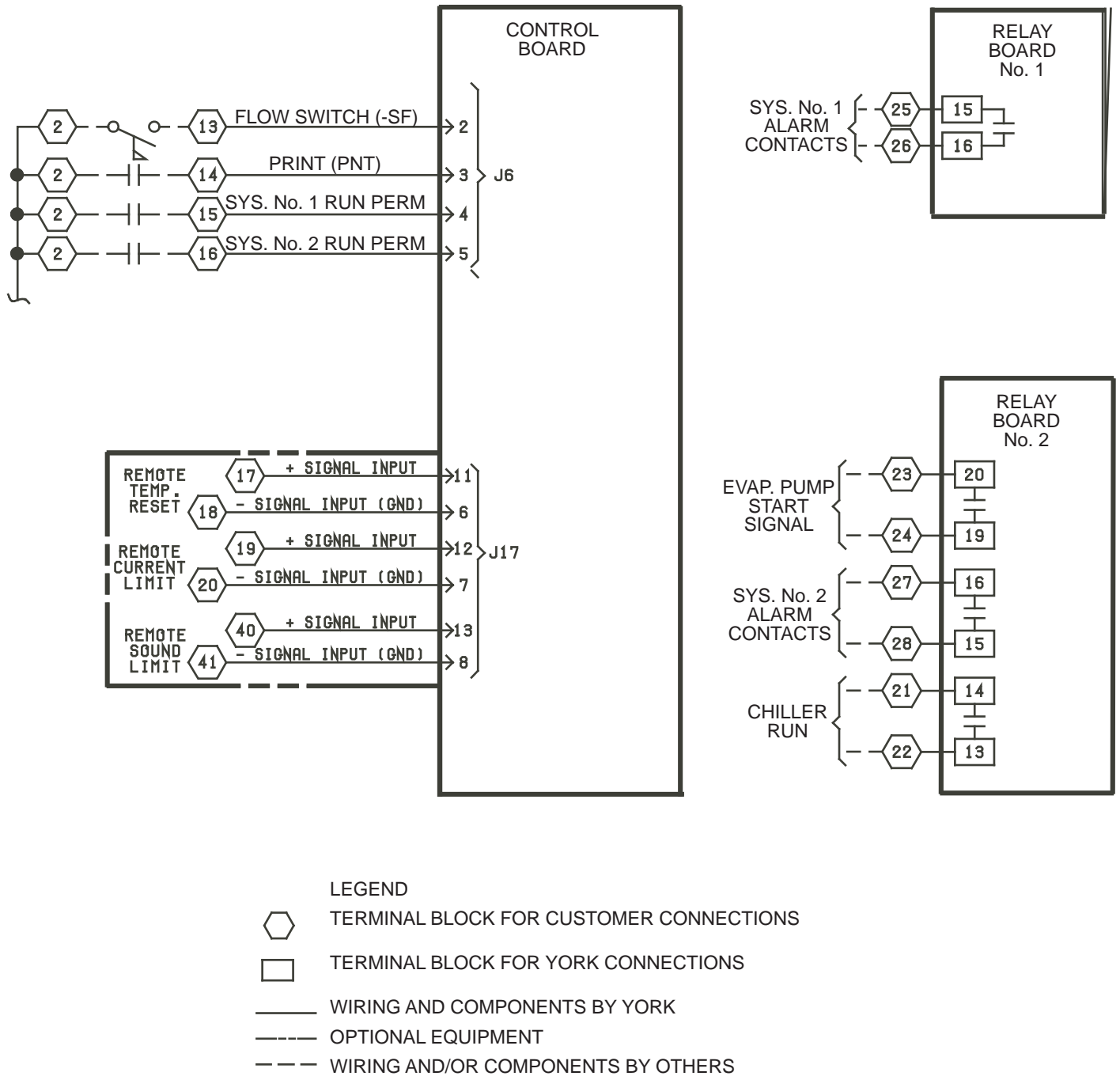

FIG. 13 – CUSTOMER CONTROL WIRING DIAGRAM