

# YLPA0415SE, YLPA0425HE, YLPA0495SE & YLPA0505HE

Operating Instructions

Revision 0

Form 150.68-01.EN.CE (0311)

(035-23225-100)

## REVERSE CYCLE AIR TO WATER HEAT PUMPS MICRO BASED CONTROL SYSTEM WITH IPU STYLE A

(Software version C.MMC.16.04 and higher)

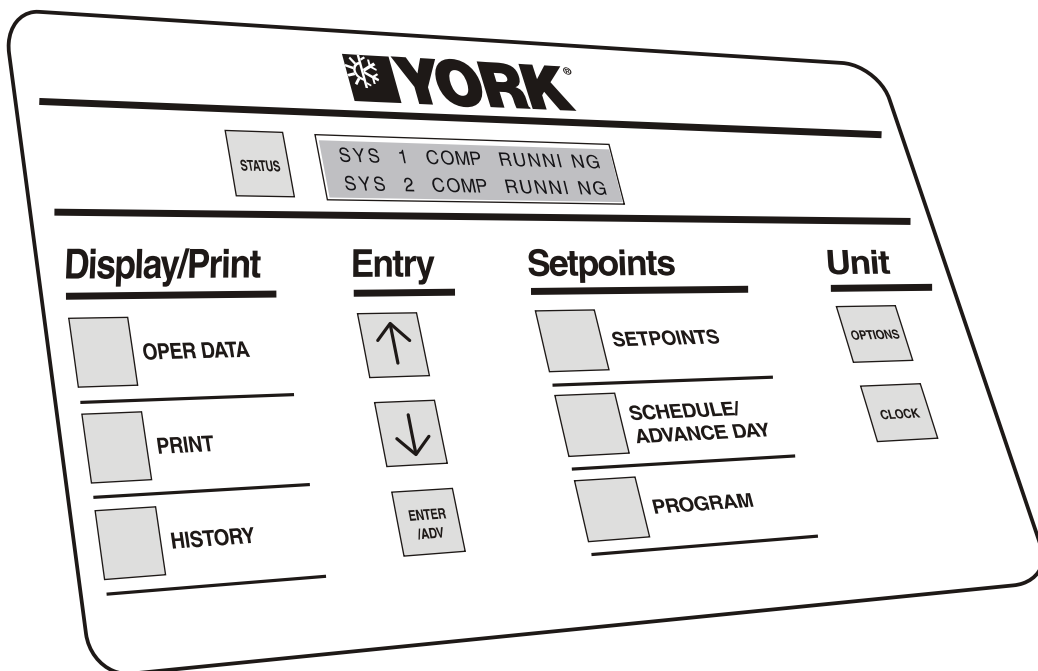

R410A



## Table of Contents

General .....	1	Entry Keys .....	25
Control Panel	1	UP ARROW and DOWN ARROW Keys	25
AMB (IPU II and I/O Boards)	1	ENTER/ADV Key	25
Internal Clock & Memory Backup Battery	1	Setpoints Keys .....	26
Keypad and Display	2	Setpoints	26
Unit ON/OFF Switch	2	SCHEDULE/ADVANCE DAY Key	27
Customer Controls	2	PROGRAM Key	28
System Inputs	2	Setpoint and Cut-out Settings	30
Remote Start/Stop	2	Unit Keys .....	31
Flow Switch	2	OPTIONS Key	31
Remote Mode Selection	2	CLOCK Key	33
Load Limiting	2	Optional Soft Start .....	33
Fan Full Speed Inhibit (units fitted with optional two speed fans)	2	Diagnostics	33
Voltage Free Contacts	3	Detected fault conditions	33
Liquid Pump Control - Units without Hydro Kit Option	3	Commissioning	33
Alarms	3	Inputs / Outputs .....	34
System Run Status	3	Digital Inputs	34
Heat Recovery Option	3	Analogue Inputs	34
Operation .....	3	Digital Outputs	35
Mode Control	4	Optional Printer Installation .....	35
Capacity Control	4	Installation Limitations	35
Ambient Coil Fan Control	7	Parts	36
Adaptive Defrost in Heat Pump Mode	11	Assembly and Wiring	36
Anti-Recycle Timer	15	Using Other Printers	36
Anti-Coincidence Timer	15	Warranty	36
Refrigerant to Water Heat Exchanger Heater Control	15	Obtaining a Printout	36
Compressor Crankcase Heaters	15	BAS/EMS Temperature Reset .....	36
Lead/Lag Control	15	BAS/EMS Temperature Reset Using a Voltage or Current Signal	36
Control Panel Keys .....	16	EMS PWM Remote Setpoint Reset	38
Status Key	16	ISN Control	
Display/Print Keys	16	(York Talk -AMB terminal block TB1) .....	40
Entry Keys	16	Received Data (Control Data)	40
Setpoints Keys	16	Transmitted Data	40
Unit Keys	16	BACnet, Modbus and N2	
Status Key .....	16	(-AMB Board Terminal Block) .....	41
General Status Messages	16	BACnet Modbus and N2 Data Communication	41
Fault Status Messages	18	IPU II Port Settings	42
Display/Print Keys .....	20	Serial Communication Analog Value Data	43
OPER DATA Key	21	Serial Communication Binary Value Data	43
PRINT Key	23	Serial Communication Analog Input Data	44
History Key	23	Serial Communication Binary Value Data	45
		Serial Communication Analog Value Data	45
		Serial Communication Binary Value Data	47



## General

YLPA units are designed to work independently, or in conjunction with other equipment via an ISN, Bacnet or Modbus or N2 (remote communications device) building management system or other automated control system. When operating, the unit controls monitor the liquid system temperatures at the unit and take the appropriate action to maintain the temperatures within desired limits. This action will involve running one or more compressors to match the effect of the refrigerating systems to the load on the liquid system. In the cooling mode the heat removed from the chilled liquid by the refrigerant to water heat exchanger is then rejected from the ambient coils. In the heating mode heat taken from the air is transferred from the air heat exchanger to the refrigerant to water heat exchanger to heat the liquid. As an option heat recovery is available in the cooling mode.

### Control Panel

A microprocessor based control system is fitted to YLPA Heat Pump units. It is capable of dual refrigerant system (circuit) control to maintain liquid temperature within programmed limits, as well as sequencing, system safeties, displaying status, and daily schedules.

Remote cycling, mode selection, demand limiting and liquid temperature reset can be accomplished by field supplied contacts.

Compressor starting/stopping and loading/unloading decisions are performed by the microprocessor to maintain leaving liquid temperature. These decisions are a function of temperature deviation from 'SETPOINT'.

A master (UNIT) ON/OFF switch is provided on the unit control panel to activate or deactivate the complete unit.

With the optional Hydro kit the control of the single or duty/standby pumps are integral to the control system.

### AMB (IPU II and I/O Boards)

The IPU II and I/O boards are assembled to function as a single microprocessor controller. The IPU II board contains a coldfire microprocessor and is the controller and decision maker in the control panel. The I/O board handles all of the unit I/O (Inputs and Outputs). System inputs from pressure transducers and temperature sensors are connected to the I/O board. The I/O board contains a processor capable of reading the inputs and controlling the outputs. It communicates through the transition header with the IPU II microprocessor.

The I/O board circuitry multiplexes the analog inputs, digitizes them, and constantly scans them to keep watch on the unit operating conditions. The input values are transmitted serially to the IPU II microprocessor board. From this information, the IPU II then issues commands to the I/O board relay outputs to control contactors, solenoids, etc. for Leaving Liquid Temperature Control and to react to safety conditions. The I/O board converts logic signals to operate relay outputs to 110 VAC levels used by motor contactors, fan contactors, solenoid valves, etc. to control system operation. The low voltage side of all relay coils on the I/O board are powered by +12V.

Keypad commands are actuated upon by the microprocessor to change setpoints, cutouts, scheduling, operating requirements, and to provide displays. The keypad and display are connected to the I/O board.

The on-board power supply converts 24 VAC from T1, 110/24 VAC transformer to +12V, +5V and +3.3V using switching and linear voltage regulators located on the I/O and IPU II boards. These voltages are used to operate integrated circuitry on the board. The 40 Character Display and unit sensors (transducers and temperature sensors) receive a +5V supply. 24VAC is rectified, but not regulated, to provide an unregulated +30 VDC supply for all of the digital inputs.

The IPU II board contains one green "Power" LED to indicate that the board is powered up and one red "Status" LED to indicate by blinking that the processor is operating. The I/O board contains one green "Power" LED to indicate that the board is powered up and one red "Status" LED to indicate by blinking that the processor is operating. The I/O board also contains two sets of Receiver/Transmit LED's, one for each available serial communication port. The receive LED's are green, and the Transmit LED's are red.

A jumper on the I/O board selects 4-20mA or 0-10 VDC as the input type on the remote temperature reset analog input.

### Internal Clock & Memory Backup Battery

The AMB board contains a real time clock (RTC) integrated circuit chip with an internal battery backup. The battery backup assures that any programmed values (setpoints, clock, cut-outs, etc.) are not lost during a power failure or shutdown period regardless of the time involved.

## Keypad and Display

User interface is via a touch keypad and a liquid crystal display allowing access to operating and programmed data. Information can be displayed in S.I. (Metric) or Imperial units. The 40 character liquid crystal display (2 lines of 20 characters) is used for displaying system parameters and operator messages. The display has a lighted background for night viewing as well as a special feature which intensifies the display for viewing in direct sunlight.

## Unit ON/OFF Switch

The unit ON/OFF switch is located just below the keypad. This switch allows the operator to turn the entire unit OFF, if desired. The switch must be placed in the ON position for the unit to operate. Any time the switch is in the OFF position, a STATUS message will be displayed.

## Customer Controls

The microprocessor based control system can accept remote signals to start and stop the unit, select mode, to adjust the leaving liquid temperature setpoint and to load limit the unit. These functions can easily be controlled by connecting user supplied voltage free contacts to the customer terminal blocks.

In addition, run status and alarm contacts are provided to remotely signal system status and faults.

## System Inputs



Wiring from remote voltage free contacts should be run in screened cable earthed at the panel end only. If an inductive device (relay, contactor) is supplying these contacts, the coil of the device must be suppressed with a standard RC suppresser across the inductive coil.

## Remote Start/Stop

Remote start/stop can be accomplished using a time clock, manual contact or other voltage free contact connected to terminals 13 and 51 on -XTBC1 in the electronic section. The contact must be closed to allow the unit to run. Any time the contact opens for more than 3 seconds, the unit will shutdown and the 'REMOTE STOP NO RUN PERM' message will be displayed.

## Flow Switch

On units without a Hydro Kit options (which include a factory fitted flow switch), the customer must install and wire a field mounted flow switch. The flow switch should be rated for 30 Vdc 1 to 3 ma, gold contacts recommended, connected to terminals 13 and 14 on -XTBC1 in the electronic section to provide adequate protection against loss of liquid flow.



The flow switch should never be by-passed. This will cause damage to the unit and invalidate the warranty.

## Remote Mode Selection

Remote mode selection can be accomplished by connecting a voltage free contact to terminals 13 & 50 on -XTBC1 in the electronic section. For the contact to be enabled the selection for 'LOCAL \ REMOTE MODE' under the 'OPTION' key must be set to 'REMOTE'. If a remote communications device is connected to the unit the page controlling the unit mode must be set to '0' to hand back mode control to the unit. With the voltage free contact is open the unit mode is cooling. With the contact closed the unit mode is heating.

## Load Limiting

Load Limiting is a feature that prevents the unit from loading beyond a desired value. 4 compressor units can be load limited to 50% of the compressors by allowing only 1 compressor per system to run. 5 compressor units can be load limited to 80% or 40% of the compressors. The 80% limit would allow up to 2 compressors per system to run, and the 40% limit would allow a maximum of 1 compressor per system to run. 6 compressor units can be load limited to 33% or 66% of the compressors. The 66% limit would allow up to 2 compressors per system to run, and the 33% limit would allow up to 1 compressors per system to run. No other values of limiting are available.

The unit can be load limited through remote communication device or through closing contacts connected to the Load Limit (terminals 13-21) and PWM inputs (terminals 13-20) on -XTBC1 in the electronic section. Stage 1 of load limiting involves closing the Load Limit input. Stage 2 of load limiting involves closing both the Load Limit and PWM inputs. The first stage of limiting is 50% of unit on 4 compressor units, 80% on 5 compressor units or 66.3% on 6 compressor units. The second stage of limiting is only available on 5 and 6 compressor units, 40% of unit on 5 compressor units or 33% on 6 compressor units. Remote unload when using remote contacts is available when either REMOTE or LOCAL is selected for LOCAL / REMOTE MODE under the OPTION key.

Simultaneous operation of Load Limiting and EMS-PWM Temperature Reset is not possible. However Load Limiting when using remote unload contacts can be implemented if the analog temperature reset is used.

## Fan Full Speed Inhibit (units fitted with optional two speed fans)

To reduce unit noise the fans can be limited to run at a maximum step of all fans in star (reduced speed) i.e. fan full speed is inhibited. Connect a customer voltage free contact to terminals 13 & 15 -XTBC1 in the electronic section. When the contact is closed fan full speed inhibit is in effect.

## Voltage Free Contacts

A 28 Vdc or up to 254 Vac external circuit (supplied by others) may be connected to these contacts. The contacts are rated at 125 VA.



If any inductive load device (relay or contactor) is connected to the alarm contacts, the device must be suppressed at the load with a RC suppressor across the inductive coil. Failure to install suppressors will result in nuisance faults and possible damage to the unit.

## Liquid Pump Control - Units without Hydro Kit Option

Terminals 23 and 24 -XTBC2 in the electronic section close to start the liquid pump. After the "30 second stop to start timer" has timed out, this contact is closed if there is a 'Leaving Liquid Temperature Cutout' or any of the compressors are running or the daily schedule is not calling for a shutdown with the unit switch 'ON' and the remote stop/start input closed (terminals 13 & 14 on -XTBC1 in the electronic section).



The contact must be used to ensure that the pump is running in the event of a 'Leaving Liquid Temperature Cutout'.

The pump contact will not close to run the pump if the unit has been powered up for less than 30 seconds, or if the pump has run in the last 30 seconds, to prevent pump motor overheating.

## Alarms

Contacts are provided connected to -XTBC2 in the electronic section, which can be used to remotely signal alarms. The contacts are normally open (N.O.) and will close when control power is applied to the panel, if no fault conditions are present. When a fault occurs which locks out a system or the unit power is lost, the contacts open. To obtain a system alarm signal, connect the alarm circuit to terminals 29 and 30 for No. 1 system and terminals 31 and 32 for No. 2 system.

## System Run Status

System run status is indicated by closure of contacts connected to -XTBC2 in the electronic section, terminals 25 and 26 for system 1 and terminals 27 and 28 for system 2.

## Heat Recovery Option

On units fitted with optional heat recovery a contact is connected terminals 33 & 34 -XTBC2 in the electronic section which is closed in cooling and open in heating.

## Operation

**The operating sequence described below relates to operation on a cooling demand start after power has been applied, such as start-up commissioning.**

When power is applied to the unit a 2 minute timer will start. This timer also prevents instantaneous starting after a power failure if the option POWER FAILURE RESTART is set to AUTOMATIC under the OPTION key.

If the option POWER FAILURE RESTART is set to MANUAL under the OPTION key the unit switch must be set to OFF then back to ON to reset the unit lockout condition UNIT FAULT: 115VAC UNDER VOLTAGE.

For a unit to run, the unit switch and the software system switches under the option key must be set to on, any remote cycling contacts must be closed, the 'Daily Schedule' must be scheduling the unit on, and a temperature demand must be present. The status message will read 'FLOW SWITCH OPEN' for 30 seconds after which a contact closes to start the liquid pump. On the closing of the flow switch the remaining time on the 120 second anti recycle timers will be displayed.

At the end of the 2 minute timer, the microprocessor will check for cooling demand. If all conditions allow for start, the first compressor on the lead system will start. Coincident with the start, the anti-coincident timer will be set and begin counting downward from '60' seconds to '0' seconds.

If the unit is programmed for 'Automatic Lead/Lag Control', the system with the shortest average run-time of the compressors will be assigned as the 'lead' system. A new lead/lag assignment is made whenever all systems shut down. Several seconds after the compressor starts, that systems first condenser fan will come ON if the discharge pressure is above the programmed set point.

After 1 minute of compressor run time, the next compressor in sequence will start when a system has to load. Additional compressors will be started at 60 second intervals as needed to satisfy temperature load.

If demand requires, the lag system will come on with the same timing sequences as the lead system. However the lead system must be running for a minimum of 5 minutes before the lag system will be allowed to run.

As the load decreases below the 'SETPOINT', the compressors will be shut down in sequence. This will occur at intervals of either 30, 15 or 10 seconds based on the liquid temperature as compared to 'SETPOINT', and control mode.

## Mode Control

The control mode of the unit is selected by:

- A selection under the 'OPTION' key when the local/remote option is set to 'LOCAL'.
- to terminals 13 & 50 on -XTBC1 in the electronic section. For the contact to be enabled the selection for local/remote mode under the 'OPTION' key must be set to 'REMOTE'. If a communication device is connected to the unit the page controlling the unit mode must be set to "0" to hand back mode control to the unit. When the voltage free contact is open the unit mode is cooling. With the contact closed the unit mode is heating.
- A remote communication device. For the remote communications device to select the mode the local/remote mode under the 'OPTION' key must be set to 'REMOTE'. The remote communications device page controlling the unit mode should be set for 1 for cooling or 2 for heating.



For correct operation only change the Mode Selection Local\Remote when unit switch is set to OFF.

In cooling the unit capacity control is from the cooling set point and fans are controlled on discharge pressure. The mode solenoid valves are de-energised to configure the unit with the ambient coils as the condenser and the refrigerant to water heat exchanger as the evaporator to deliver chilled liquid.

In the heating mode the unit capacity control is from the heating set point and the fans in a system start after the first compressor at 5 second intervals. The mode solenoid valves are energised to configure the unit with the ambient coils as the evaporator and the refrigerant to water heat exchanger as the condenser to deliver heated liquid. In the heating mode Ice can form on the ambient coils requiring a defrost.

## Mode Valve Operation (for each system)

Other than for defrost, see Adaptive Defrost in Heat Pump Mode Section, the mode valve changes state as follows:

1. Default state is de-energized (Cooling Mode).
2. When a system is running and the mode changes the mode valve will change state at once.
3. If a system is running in heating with the mode valve energized and the system is required to stop for any other reason than fall of heating demand, the compressors will stop and the mode valve will de-energize, and change to cooling mode.
4. In the heating mode when the first compressors in the system starts its associated mode valve will remain de-energized, still in cooling mode. After 10 seconds of run time, the mode valve will energize, changing to the heating mode.

5. In the heating mode, when temperature demand falls to stop the lead compressor in a system its mode valve will de-energizes, change to cooling mode and after 5 seconds the compressor will stop.

## Capacity Control

The control system will evaluate the need for duty by comparing the actual leaving liquid temperature to the desired 'SETPOINT', and regulate the leaving liquid temperature to meet that desired 'SETPOINT'.

### Leaving Liquid Control (Cooling Mode)

The leaving chilled liquid 'SETPOINT' is the temperature the unit will control to within +/- the 'RANGE'. The Setpoint High Limit is the 'SETPOINT' plus the 'RANGE'. The Setpoint Low Limit is the 'SETPOINT' minus the 'RANGE'.

The 'RANGE' setting takes into account the number of compressors on the unit and the temperature difference between leaving (LLT) and return (RLT) chilled liquid at full load (refer to Setpoints Keys Section for details).

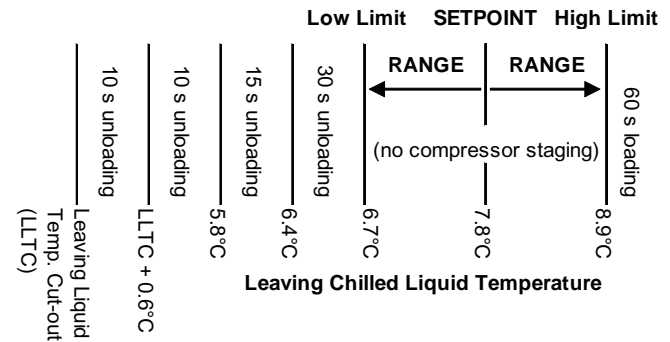

Each system has its own anti-recycle timers. The anti-recycle time under the PROGRAM key can be programmed between 240 and 600 seconds and sets the minimum start-to-start time of the lead compressor in a system. Due to lead lag rotation in a system, consecutive lead compressor starts are not with the same compressor. A second non-programmable anti-recycle timer, stop to start is fixed at 90 seconds, starts to countdown when the lead compressor in a systems cycles off.

The lag compressors in a system, are not controlled by the anti-recycle timer. They have no start to start timer other than the effect of system lead/lag rotation and the load/unload timers. For a given compressor this gives a minimum start to start time of 140 seconds on systems with 2 compressors or 210 seconds on systems with 3 compressors. Their minimum stop to start time for a given compressor is 60 seconds, the 60 second load timer.

When the leaving chilled liquid temperature is above the Setpoint High Limit, the lead compressor on the lead system will be energised.



After 60 seconds of run-time if the leaving chilled liquid temperature is still above the Setpoint High Limit and the leaving chilled liquid temperature is not falling faster than the programmed RATE SENSITIVITY within the programmed RATE CONTROL TEMPERATURE RANGE or above the RATE CONTROL TEMPERATURE RANGE at 1.7°C per minute, the next compressor in sequence will be energised.

Additional loading stages are energised at a rate of one every 60 seconds if the chilled liquid temperature remains above the Setpoint High Limit and the same criteria on leaving chilled liquid temperature rate of change as above are met.

The strategy for loading/unloading is design to meet the following criteria:

- Minimise system starting and stopping;
- The lag system is not available to start until the lead system cannot load further and has been running for 5 minutes;
- When both systems are running, balance loading / unloading between them.

With both systems running the next system to load is determined by the following rules;

- The system must not be fully loaded;
- Remote load limit, suction limiting or discharge limiting must not be in effect on the system.

If both systems are available to load the system with the lowest number of compressors running will load. If both systems have the same number of compressors running the lead system will load.

On units without soft start strategy for compressor loading within a system is to maximize individual compressor run time and ensure that the same compressor does not start twice in a row. This is achieved by rotating the lead/lag sequence of the compressors in a system when a compressor other than the lag most compressor in that system stops. In achieving this objective no attempt will be made to equalize each compressors individual total run hours within a system.

On units with soft start the compressor in each system with soft start is always the last to start. Compressors are always started in the same order, No.1 compressor first.

If the chilled liquid temperature falls below the Setpoint High Limit but is greater than the Setpoint Low Limit, loading and unloading do not occur. This area of control is called the 'CONTROL RANGE'.

If the chilled liquid temperature drops to less than 0.28°C below the Setpoint Low Limit, unloading occurs at a rate of 30 seconds. If the chilled liquid temperature falls to a value greater than 0.28°C below the Setpoint Low Limit but not greater than 0.83°C below the Setpoint Low Limit, unloading occurs at a rate of 15 seconds.

If the chilled liquid temperature falls to a value greater than 0.83°C below the Setpoint Low Limit, unloading occurs at a rate of 10 seconds. If the leaving chilled liquid temperature falls to 0.6 °C above the leaving liquid temperature cutout, unloading occurs at a rate of 10 seconds.

If more than one compressor is running in a system then on unloading the compressor to be stopped is not the same compressor stopped during the last unload sequence. This is achieved by rotating the lead lag sequence of the compressors in a system when a compressor in that system stops.

The leaving chilled liquid 'SETPOINT' is programmable from 4.4°C to 21.1°C in the chilled liquid water mode and from -12.2°C to 21.1°C in chilled liquid glycol mode. In both modes, the 'RANGE' can be from +/- 0.8°C to 2.5°C.

To ensure that the Setpoint Low Limit cannot be inadvertently set to low when setting the Setpoint and Control Range in the water cooling mode the software makes the following adjustments. If as a result of Setpoint and Control Range setting the Setpoint Low Limit would be below 4.4°C the software will set the Setpoint Low Limit to 4.4°C and raise the Setpoint High Limit by the difference to maintain the same Control Range.

To ensure reliable operation of the unit the software will modify the operation of the 'Leaving Chilled Liquid Control' as follows:

- If the run time of the lead system is less than 5 minutes the Setpoint High Limit is increased up to a maximum of 10°C by the 'Setpoint Adjust Value' shown in the following graph. Any adjustment value in excess of the value taking the Setpoint High Limit to 10°C is taken from the Setpoint Low Limit. When the run time exceeds 5 minutes the 'Setpoint Adjust Value' returns to zero. This will occur whilst the unit is running. Pressing the 'COOLING SETPOINTS' key seven times will display the lead system's last run time and the 'Setpoint Adjust Value'.
- If the run time of the lead system is less than 5 minutes on 3 successive occasions, the anti-recycle timer will be doubled, with a maximum allowable anti-recycle value of 10 minutes.

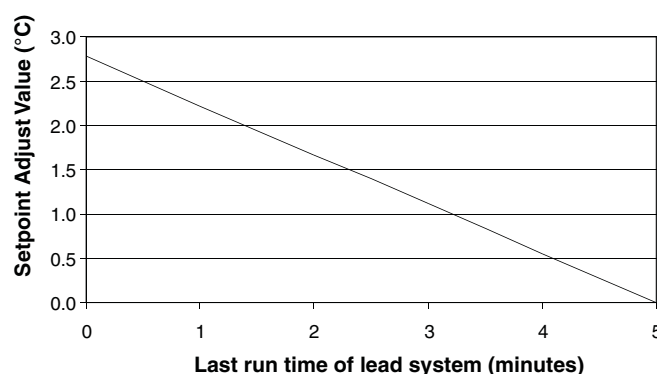

### Leaving Liquid Control (Heating Mode)

The leaving hot liquid 'SETPOINT' is the temperature the unit will control to within +/- the 'RANGE'. The Setpoint High Limit is the 'SETPOINT' plus the 'RANGE'. The Setpoint Low Limit is the 'SETPOINT' minus the 'RANGE'.

The 'RANGE' setting takes into account the number of compressors on the unit and the temperature difference between leaving (LLT) and return (RLT) liquid at full load (refer to Setpoints Keys Section for details).

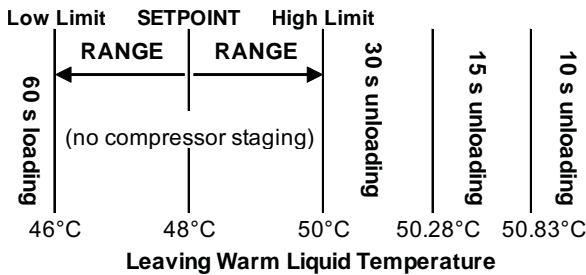

Each system has its own anti-recycle timers. The anti-recycle time under the PROGRAM key can be programmed between 240 and 600 seconds and sets the minimum start-to-start time of the lead compressor in a system. Due to lead lag rotation in a system, consecutive lead compressor starts are not with the same compressor. A second non-programmable anti-recycle timer, stop to start is fixed at 90 seconds, starts to countdown when the lead compressor in a systems cycles off.

The lag compressors in a system, are not controlled by the anti-recycle timer. They have no start to start timer other than the effect of system lead/lag rotation and the load/unload timers. For a given compressor this gives a minimum start to start time of 140 seconds on systems with 2 compressors or 210 seconds on systems with 3 compressors. Their minimum stop to start time for a given compressor is 60 seconds, the 60 second load timer.

When the leaving hot liquid temperature is below the Setpoint Low Limit, the lead compressor on the lead system will be energised.

After 60 seconds of run-time if the leaving hot liquid temperature is still below the Setpoint Low Limit and the leaving hot liquid temperature is not rising faster than the programmed RATE SENSITIVITY within the programmed RATE CONTROL TEMPERATURE RANGE or below the RATE CONTROL TEMPERATURE RANGE at 1.7°C per minute, the next compressor in sequence will be energised.

Additional loading stages are energised at a rate of one every 60 seconds if the hot liquid temperature remains below the Setpoint Low Limit and the same criteria on leaving hot liquid temperature rate of change as above are met.

The strategy for loading/unloading is design to meet the following criteria:

- Minimise system starting and stopping;
- The lag system is not available to start until the lead system cannot load further and has been running for 5 minutes;
- When both systems are running, balance loading / unloading between them.

With both systems running the next system to load is determined by the following rules;

- The system must not be fully loaded;
- Remote load limit, suction limiting or discharge limiting must not be in effect on the system.

If both systems are available to load the system with the lowest number of compressors running will load. If both systems have the same number of compressors running the lead system will load.

On units without soft start strategy for compressor loading within a system is to maximize individual compressor run time and ensure that the same compressor does not start twice in a row. This is achieved by rotating the lead/lag sequence of the compressors in a system when a compressor other than the lag most compressor in that system stops. In achieving this objective no attempt will be made to equalize each compressors individual total run hours within a system.

On units with soft start the compressor in each system with soft start is always the last to start. Compressors are always started in the same order, No1 compressor first.

If the hot liquid temperature rises above the Setpoint Low Limit but is less than the Setpoint High Limit, loading and unloading do not occur. This area of control is called the 'CONTROL RANGE'.

If the hot liquid temperature rises to greater than 0.28°C above the Setpoint High Limit, unloading occurs at a rate of 30 seconds. If the hot liquid temperature rises to a value greater than 0.28°C above the Setpoint High Limit but not less than 0.83°C above the Setpoint high Limit, unloading occurs at a rate of 15 seconds. If the hot liquid temperature rise to a value less than 0.83°C above the Setpoint High Limit, unloading occurs at a rate of 10 seconds. If more than one compressor is running in a system then on unloading the compressor to be stopped is not the same compressor stopped during the last unload sequence. This is achieved by rotating the lead lag sequence of the compressors in a system when a compressor in that system stops.

The leaving hot liquid 'SETPOINT' is programmable from 35°C to 55°C. In both modes, the 'RANGE' can be from +/-0.8°C to 2.5°C.

To ensure reliable operation of the unit the software will modify the operation of the 'Leaving hot Liquid Control' as follows:

- If the run time of the lead system is less than 5 minutes the Setpoint Low Limit is decreased down to a minimum of 40°C by the 'Setpoint Adjust Value' shown in the following graph.

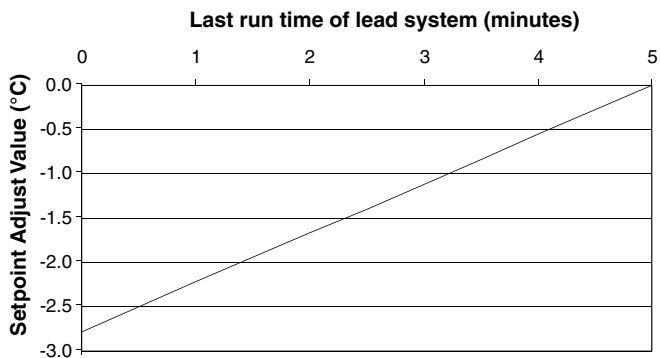

Any adjustment value in excess of the value taking the Setpoint Low Limit to 40°C is added to the Setpoint High Limit. When the run time exceeds 5 minutes the 'Setpoint Adjust Value' returns to zero. This will occur whilst the unit is running. Pressing the 'SETPOINTS' key seven times will display the lead system's last run time and the 'Setpoint Adjust Value'.

- If the run time of the lead system is less than 5 minutes on 3 successive occasions, the anti-recycle timer will be doubled, with a maximum allowable anti-recycle value of 10 minutes.

## Ambient Coil Fan Control

In the cooling mode the fans are controlled by the discharge pressure. In the heating mode the fans run continuously. In defrost mode the fans are off unless the discharge pressure is above 33.8 BARG, in which case the first stage of fan control will come on. If the discharge pressure fall to below 30.3 BARG this stage of fan control turns off again. When a system starts in the heating mode the fans start in sequence stepping up through the fan stages at 5 second intervals. See the Adaptive Defrost in Heat Pump Mode Section for a description of fan operation during defrost.

In the cooling mode there are three to five steps of fan discharge pressure control plus step time control dependant on the number of fans in a system. Subsequent to the compressor starting, and if required by the discharge pressure, there will be a time delay of 5 seconds before the first fan can start. The number of fans in each system is given in the table below.

YLPA	SYS. 1	SYS. 2
0340	3	3
0415	4	3
0355, 0495	4	4
0560, 0425	6	4
0505, 0570, 0610, 0640	6	6

The delay between turning on and off fan stages is fixed at 5 seconds. The controller increments or decrements the fan stage by one stage at a time based on the discharge pressure and the fan delay time.

The Fan On Pressure is programmable under the PROGRAM key. When the discharge pressure is > Fan On Pressure and the fan delay timer has expired, the fan stage is incremented by 1. After incrementing the fan stage the fan delay timer is set to 5 seconds and the Fan On Pressure is ramped from 1.4 BARG over the original value back to the original value over the next 20 seconds.

The Fan Off Pressure is equal to the Fan On Pressure minus the Fan Diff Off Pressure which is programmable under the PROGRAM key. When the discharge pressure is < Fan Off Pressure and the fan delay timer has expired, the fan stage is decremented by 1. After decrementing the fan stage the fan delay timer is set to 5 seconds and the Fan Off Pressure is ramped from 1.4 BARG below the original value back to the original value over the next 20 seconds.

**Single speed fans**

The following tables show the relationship between fan stages and the microprocessor digital outputs and fans:

**Systems with 3 fans**

Stages	Fan Output 1 =AMB-XTB7-8 (SYS1) =AMB-XTB10-8 (SYS2) 1-MF1 2-MF1	Fan Output 2 =AMB-XTB7-9 (SYS1) =AMB-XTB10-9 (SYS2) 1-MF2 2-MF2	Fan Output 3 =AMB-XTB7-10 (SYS1) =AMB-XTB10-10 (SYS2) 1-MF3 2-MF3
0	Off	Off	Off
1	On	Off	Off
2	On	On	Off
3	On	On	On

**Systems with 4 fans**

Stages	Fan Output 1 =AMB-XTB7-8 (SYS1) =AMB-XTB10-8 (SYS2) 1-MF1 2-MF1	Fan Output 2 =AMB-XTB7-9 (SYS1) =AMB-XTB10-9 (SYS2) 1-MF2 2-MF2	Fan Output 3 =AMB-XTB7-10 (SYS1) =AMB-XTB10-10 (SYS2) 1-MF3 & 1-MF4 2-MF3 & 2-MF4
0	Off	Off	Off
1	On	Off	Off
2	On	On	Off
3	On	Off	On
4	On	On	On

**Systems with 6 fans**

Stages	Fan Output 1 =AMB-XTB7-8 (SYS1) =AMB-XTB10-8 (SYS2) 1-MF1 2-MF1	Fan Output 2 =AMB-XTB7-9 (SYS1) =AMB-XTB10-9 (SYS2) 1-MF2 & 1-MF3 2-MF2 & 2-MF3	Fan Output 3 =AMB-XTB7-10 (SYS1) =AMB-XTB10-10 (SYS2) 1-MF4 & 1-MF5 & 1-MF6 2-MF4 & 2-MF5 & 2-MF6
0	Off	Off	Off
1	On	Off	Off
2	Off	On	Off
3	On	On	Off
4	On	Off	On
5	On	On	On

## Two Speed Fan Option

### Cooling Mode

The reason for two speed fans is to reduce unit noise by running the fans in slow speed over as wide a range of conditions as possible, only going to full speed as a last resort. This is achieved by raising the pressure at which the last fan stage occurs, switching from all fans running in slow speed to all fans running in fast speed.

The Fan On Pressure is programmable under the PROGRAM key. When the discharge pressure is > Fan On Pressure and the fan delay timer has expired, the fan stage is incremented by 1. After incrementing the fan stage the fan delay timer is set to 5 seconds and the Fan On Pressure is ramped from 1.4 BARG over the original value back to the original value over the next 20 seconds.

On a fan stage incrementing so that the next incremented fan stage would result in the fans switching from slow to fast speed, the fan delay timer is set to 5 seconds and the Fan On Pressure is raised by 5.5 BARG. The Fan OFF Pressure is not moved at this time. If the discharge pressure then rises above this new value and the fan delay timer has expired, the fan stage is incremented by 1. The fan delay timer is set to 5 seconds and the Fan OFF Pressure is raised by 5.5 BARG. All fans are now on full speed.

On a fan stage decrement resulting in the fans switching from fast to slow speed, the fan delay timer is set to 5 seconds and the Fan OFF Pressure is lowered by 5.5 BARG back to the programmed Fan OFF Pressure. No further lowering or ramping back up occurs when this stage decrements. All fans are now running on slow speed.

The Fan Off Pressure is equal to the Fan On Pressure minus the Fan Diff Off Pressure which is programmable under the PROGRAM key.

On a further fall in discharge pressure when the discharge pressure is < Fan Off Pressure and the fan delay timer has expired, the fan stage is decremented by 1. After decrementing the fan stage the fan delay timer is set to 5 seconds and the Fan Off Pressure is ramped from 1.4 BARG below the original value back to the original value over the next 20 seconds.

## Cooling and Heating Modes

If all the fans are running at full speed they can be forced to run at slow speed to reduce fan noise in two ways. First method is by closing a voltage free contact terminals 13 and 15 on -XTBC1. The second method is by programming a Daily Fan Speed Inhibit time zone under the SCHEDULE/ADVANCE DAY key.

The following tables show the relationship between fan stages and the microprocessor digital outputs and fans:

### Systems with 3 fans

Stages	Fan Output 1 =AMB-XTB7-8 (SYS1) =AMB-XTB10-8 (SYS2) 1-MF1 2-MF1	Fan Output 2 =AMB-XTB7-9 (SYS1) =AMB-XTB10-9 (SYS2) 1-MF2 2-MF2	Fan Output 3 =AMB-XTB7-10 (SYS1) =AMB-XTB10-10 (SYS2) 1-MF3 2-MF3	Fan Speed =AMB-XTB8-5 (SYS 1) =AMB-XTB8-9 (SYS 2) 1-KS 2-KS
0	Off	Off	Off	Slow
1	On	Off	Off	Slow
2	On	On	Off	Slow
3	On	On	On	Slow
4	On	On	On	Fast

### Systems with 4 fans

Stages	Fan Output 1 =AMB-XTB7-8 (SYS1) =AMB-XTB10-8 (SYS2) 1-MF1 2-MF1	Fan Output 2 =AMB-XTB7-9 (SYS1) =AMB-XTB10-9 (SYS2) 1-MF2 2-MF2	Fan Output 3 =AMB-XTB7-10 (SYS1) =AMB-XTB10-10 (SYS2) 1-MF3 & 1-MF4 2-MF3 & 2-MF4	Fan Speed =AMB-XTB8-5 (SYS 1) =AMB-XTB8-9 (SYS 2) 1-KS 2-KS
0	Off	Off	Off	Slow
1	On	Off	Off	Slow
2	On	On	Off	Slow
3	On	Off	On	Slow
4	On	On	On	Slow
5	On	On	On	Fast

### Systems with 6 fans

Stages	Fan Output 1 =AMB-XTB7-8 (SYS1) =AMB-XTB10-8 (SYS2) 1-MF1 2-MF1	Fan Output 2 =AMB-XTB7-9 (SYS1) =AMB-XTB10-9 (SYS2) 1-MF2 & 1-MF3 2-MF2 & 2-MF3	Fan Output 3 =AMB-XTB7-10 (SYS1) =AMB-XTB10-10 (SYS2) 1-MF4 & 1-MF5 & 1-MF6 2-MF4 & 2-MF5 & 2-MF6	Fan Speed =AMB-XTB8-5 (SYS 1) =AMB-XTB8-9 (SYS 2) 1-KS 2-KS
0	Off	Off	Off	Slow
1	On	Off	Off	Slow
2	Off	On	Off	Slow
3	On	On	Off	Slow
4	On	Off	On	Slow
5	On	On	On	Slow
6	On	On	On	Fast

### Fan Star/Delta Dwell Time

In incrementing to the last fan stage all the fan motors are reconnected from star (slow speed) to delta (fast speed). Similarly when decrementing from the last fan stage all the fan motors are reconnected from delta (fast speed) to star (slow speed). To ensure that arcing on the contactors are cleared on switching between states the following step are enacted.

1. Turn off all fan Line contactors.
2. Wait 500 ms.
3. Change the state of KS relay and hence all of the low speed (Star) KFL contactors and high speed (delta) KFH contactors.
4. Wait 500 ms.
5. Turn on all the fan line contactors, each fan stage output, 100 ms apart.

## YLPA Fan Configuration

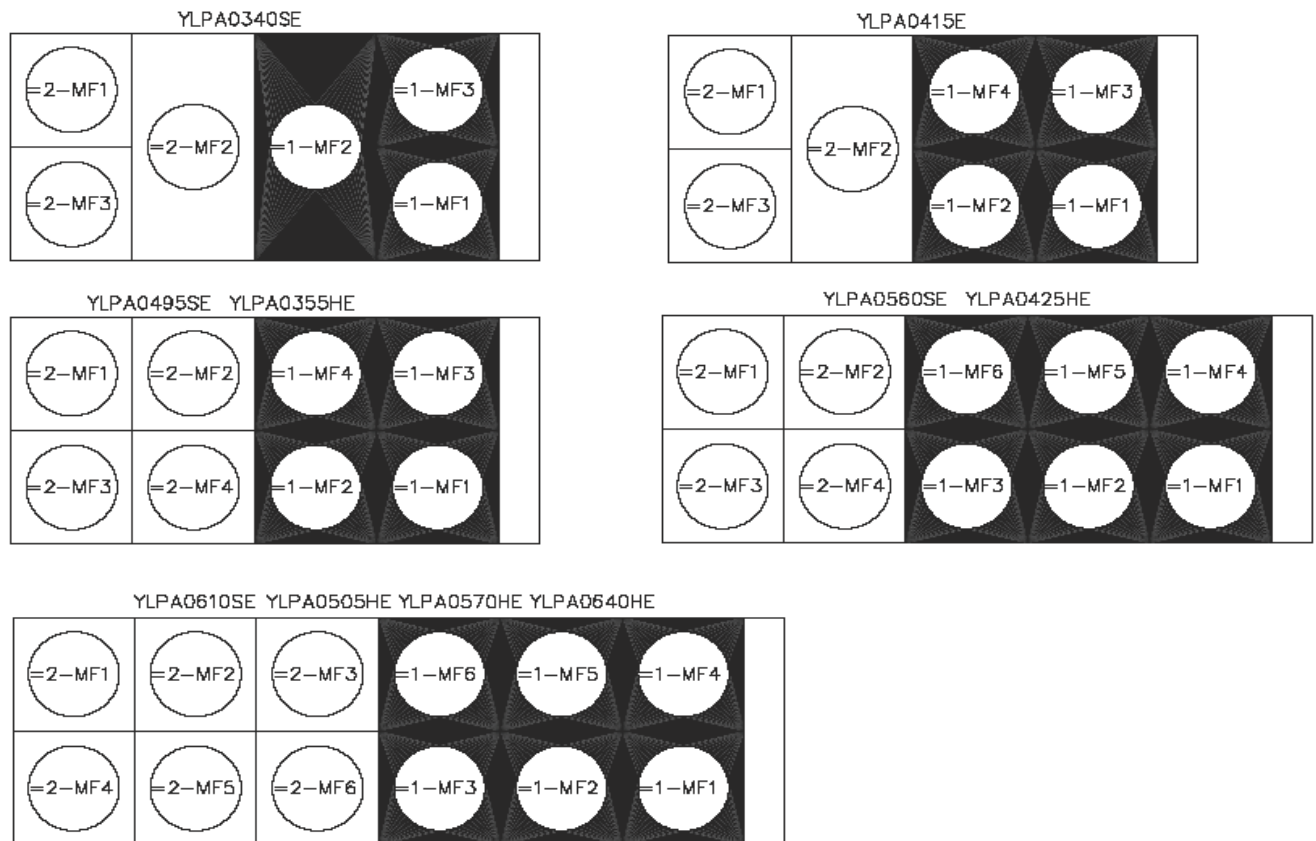

### Adaptive Defrost in Heat Pump Mode

The purpose of any defrost system is to remove frost and ice from the ambient coils. The adaptive defrost system achieves this by optimising the frequency of defrosts dependent on defrost duration with the aim of improving overall unit efficiency. The field programmable set points under the 'PROGRAM' key are:

- DEFROST INITIATION TIME (Program range 15 to 90 minutes)
- DEFROST INITIATION TEMPERATURE (Program range 2.8 to 8.9°C)
- DEFROST TERMINATION TIME (Program range 1 to 6 minutes)

The system has a fixed defrost termination temperature of 8°C.

The temperature sensors used are the defrost sensor(s) mounted on the ambient coils.

The successful implementation of the adaptive defrost is dependant on the location of the temperature sensor. The sensor is factory positioned where in general the frost is most persistent.

There are two defrost sensors fitted to the YLPA units, one per system. Two sensors are fitted as the defrost strategy ensures that both systems do not defrost at the same time, this assists in maintaining some stability to the leaving water temperature during heat pump mode. Coils only defrost on demand, normally when operating in lower ambients below +7 °C.

#### Defrost Initiation Time

The initiation time is the delay between defrosts (system to system) and its 100% value can be set in the range of 15 to 90 minutes with a recommended setting of 60 minutes.

#### Defrost Initiation Temperature

Can be set in the range of 2.8 to 8.9°C with a recommended setting of 5°C. At the end of the defrost initiation delay if the system is not running the defrost time is recorded as if the defrost time is below optimum band, (refer to Programmed Termination Time figure). However if the system is running at the end of the initiation delay the temperature of the ambient coils (fins) is checked. If the temperature is above the initiation temperature the defrost time is recorded as if the defrost time is below optimum band. If the temperature is below the initiation temperature a defrost is initiated. The system mode solenoid changes to the cooling mode. The suction pressure safety continues to operate to the heating mode suction pressure cut-out value.





The system can then reduce the initiation delay in steps of 20% to 60% of set initiation delay. This gives an effective step of initiation delay of 60%, 80%, 100%, 120%, 140% and 160% of set initiation delay (refer to Programmed Initiation Time figure).

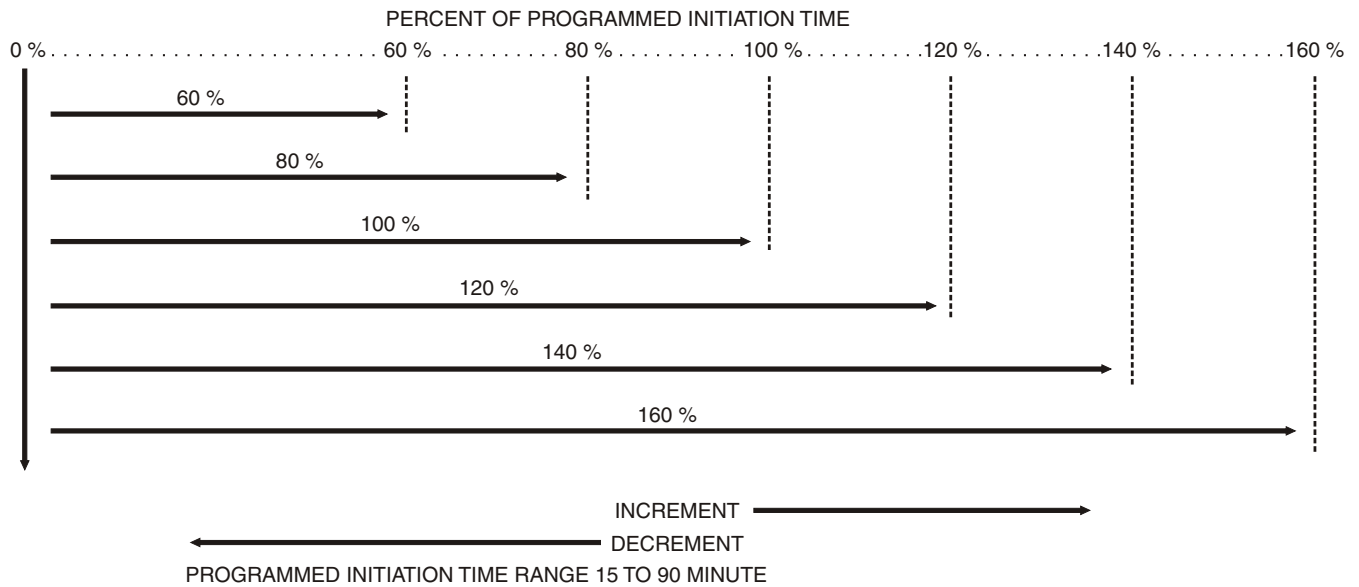

If the termination temperature is not reached within 200% of the termination delay setting, a time override occurs and the defrost is terminated and the initiation delay reduced by 20%.

On a shutdown in the heat pump mode (last system shutting down under normal water temperature control or safety or if the mode changes to cooling) % initiation delay is reset to 100% (programmed initiation delay) and the time remaining of the initiation time is stored. When the system re-starts if the time remaining to a defrost is less than 5 minutes, the time is set to 5 minutes to ensure that there is not a defrost for at least 5 minutes to enable stable operating conditions to be achieved.

Each system defrosts in turn. The determination of the % initiation delay is based on the current defrost and the last defrost, i.e. the defrost on the other coil as shown below (refer to Defrost System Separation figure):

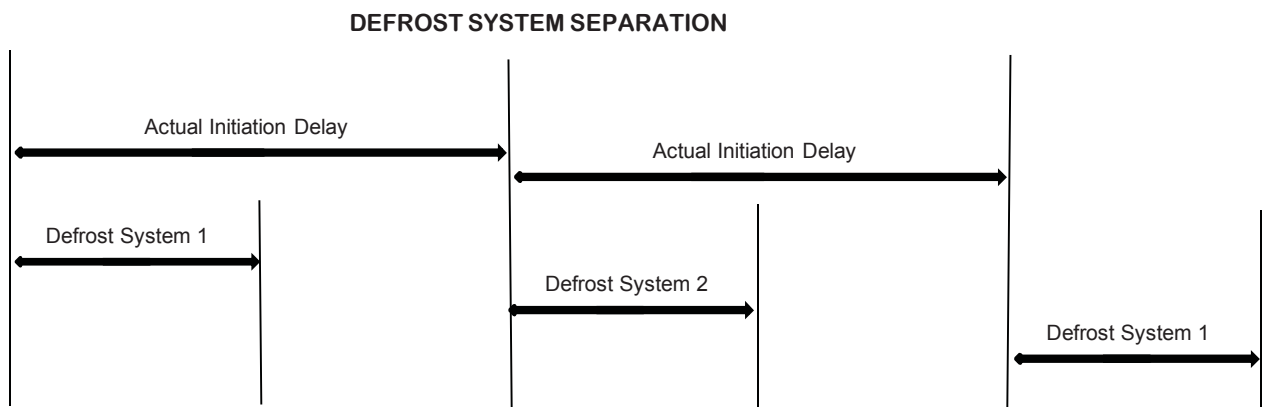

As it can be seen from the table in determining if a change should take place in the initiation delay the priority is given to the system with the most frost. The defrost of each system are spaced equally apart as shown in the Defrost System Separation figure.

LAST DEFROST	THIS DEFROST	% INITIATION DELAY
Any band	Above optimum band	Decrement
Any band	Within optimum band	No change
Below optimum band	Below optimum band	Increment
Within optimum band	Below optimum band	No change
Above optimum band	Below optimum band	No change

## Defrost Termination

When the frost is removed, the coil temperature rises suddenly and soon reaches the termination temperature of 8°C. The software ensures all fans are off, even if the discharge pressure is high. In 5 seconds the mode valve will be set to heating (energized) and the compressors released to operate against leaving hot water set point. Suction limiting loading and unloading are both re-enabled. If the suction pressure ramp up is not completed the suction pressure cut-out valve reverts to actual cut-out value.

## Units Set to Enable Fan Reversing Feature During Defrost

The fan forward contactor is de-energized and the fan reversing contactor is energized. In 1 second the fans stages will step up in sequence at 2 seconds intervals until all fan stages are on, the fans will be running in reverse. Fans are run in the reverse direction to blow away any water remaining between the fins of the air coils. 20 seconds after the defrost termination temperature is reached all fans are stopped. In 1 second the fan reverse contactor is de-energized and the fan forward contactor is energized. In 5 seconds the fans stages will step up in sequence at 2 seconds intervals until all fan stages are on, the fans will be running forward direction.

## Units Set to Disable Fan Reversing Feature During Defrost

In 1 second the fans stages will step up in sequence at 2 second intervals until all fan stages are on, running in the forward direction.

## Drip Tray Heater Option

During a defrost ice is turned to water and drains from the air coils into drip trays which carries the water to the outside of the unit. Optional drip tray heaters are available to prevent water refreezing in the drip trays. When the first compressor on the unit starts in heating the drip tray heaters are turned on if its associated defrost coil temperature is below 8°C.

When the defrost initiation time expires the affected systems defrost coil temperature is checked. If the defrost temperature is above the initiation temperature (no defrost required), the tray heater is turned off. If the defrost temperature is below the initiation temperature (defrost required), the drip tray heater is turned on. In heating with no compressors running or with the unit in the cooling mode the drip tray heater will be off.

## Defrost Sensor Mounting and Position

The Air Coil Defrost Temperature sensors are mounted on the left hand side the first Vee on a system looking from the control panel end. Within the Vee the sensor is on the furthest coil from the panel. The only exception to this is where system 2 has three fans. In this case the sensor is on the nearest coil on the second Vee looking from the control panel end. The sensor is correctly positioned during manufacture but may need to be re-positioned at site, to either suit site operating conditions or optimise the defrost cycle time.

The sensor is positioned on the outer coil of the Vee coil assembly at the edge closest to the incoming air (i.e. furthest from the common plenum formed by the 2 coils). The sensor should be positioned 150mm to 300mm from the bottom of coil and fit into the 90 degree bend formed by the coil end sheet. If needed the sensor cable should be constrained using cable ties.

If the sensor has to be repositioned it should remain in contact with the coil end sheet and be placed adjacent to the coil face which is the last place to defrost.

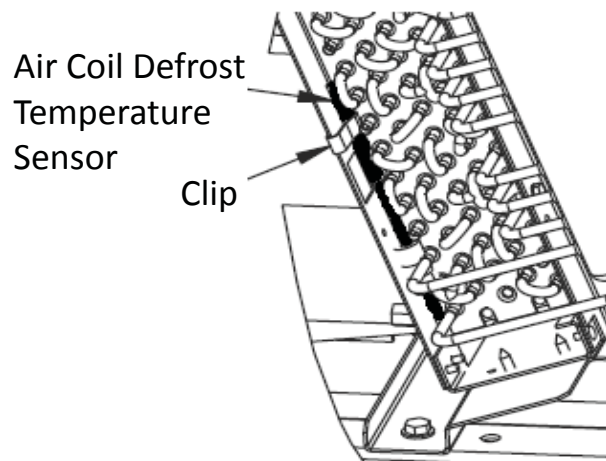

### Anti-Recycle Timer

Each system has its own anti-recycle timers. The anti-recycle time under the PROGRAM key can be programmed between 240 - 600 seconds and sets the minimum start-to-start time of the lead compressor in a system. A second non-programmable anti-recycle timer, stop to start is fixed at 90 seconds, starts to countdown when the lead compressor in a systems cycles off. On power up only this timer is set to 120 seconds not 90 seconds.

The lag compressor(s) in a system, are not controlled by the anti-recycle timer.

### Anti-Coincidence Timer

The anti-coincidence timer prevents both systems from starting simultaneously. This assures that the inrush current is kept to a minimum. A 60 second time delay will always separate motor starts. This timer is not programmable.

### Refrigerant to Water Heat Exchanger Heater Control

The water heat exchanger heater is controlled by ambient temperature. When the ambient temperature is below 4.4 °C the heater will be switched on. When the temperature rises above 7.2°C, the heater is switched off. An under voltage condition will keep the heater off until full voltage is restored to the system.



The 110 Vac control supply must remain ON for freeze protection. Otherwise, the water heat exchanger must be drained.

### Compressor Crankcase Heaters

Each compressor is fitted with a crankcase heater which is 'ON' when the compressor is 'OFF', being feed via a normally closed contact on each compressor contactor.

### Lead/Lag Control

The unit may be set up for AUTO or MANUAL lead/lag. This is accomplished by programming the option under the 'OPTIONS' key.

When AUTO lead/lag is used, the microprocessor attempts to balance run time between the systems. A number of conditions can occur which will prevent this from happening. Factors determining lead/lag selection and the resulting lead/lag determination are:

The microprocessor automatically defaults the lead to system 1 and the lag to system 2 if both systems are ready to start (Anti-recycle Timers timed out) and the systems have equal run time.

If both systems are waiting to start (Anti-recycle timers have not timed out), the microprocessor will assign the lead to the system with the shortest anti-recycle time to provide duty quickly.

If the lead system is locked out, faulted and waiting to restart the lag system is swapped to the lead.

MANUAL lead/Lag selection will be automatically overridden by the microprocessor to allow the lag system to automatically become the lead anytime the selected lead system shuts down due to, lead system faults.

Automatic switch over in MANUAL mode is provided to try to maintain unit liquid temperature as close to 'SETPOINT' as possible.

### Units without Soft Start

The strategy for compressor loading within a system is to maximize individual compressor run time and ensure that the same compressor does not start twice in a row.

This is achieved by rotating the lead/lag sequence of the compressors in a system when a compressor other than the lag most compressor in that system stops. In achieving this objective no attempt will be made to equalize each compressors individual total run hours within a system.

### Units with Soft Start

These units have a soft starter fitted to the last compressor in each system. SOFT START ENABLED must be displayed under the 'OPTIONS' key. With this option enabled the controls ensure that the compressor fitted with the soft starter is the last compressor to start in the system. Compressors are always started in the same order, No.1 compressor first.

## Control Panel Keys

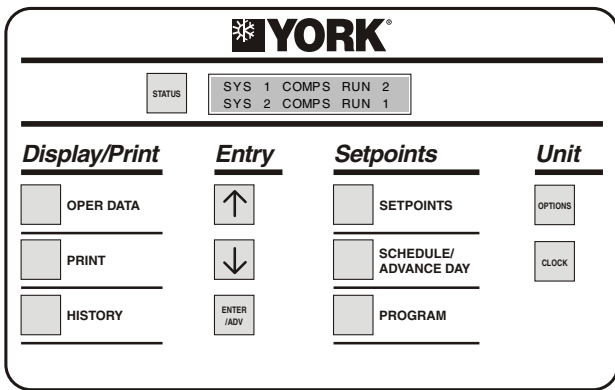

### Status Key

This key provides a display of the current operational and/or fault status of the unit or individual refrigerant systems.

### Display/Print Keys

These keys allow control panel display or remote printout of both current real-time operating data as well as fault history data from recent safety shutdowns.

### Entry Keys

These keys are used for entering data required for programming the unit. The keys are also used for scrolling through displays.

### Setpoints Keys

These keys are used for display and programming: the local and remote unit liquid temperature setpoints; the operating schedule for the unit; the unit operational settings and limits.

### Unit Keys

These keys allow the unit options and clock to be set.

## Status Key

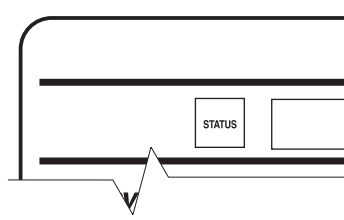

Pressing the 'STATUS' key displays the unit operating status. The messages displayed will include running status, load demand, fault status, external cycling device status, load limiting and anti-recycle/coincident timer status. The display will be a single message relating to the highest priority message as determined by the microprocessor. Status messages fall into the categories of General Status and Fault Status.

The following messages can be displayed when the 'Status' key is pressed. In the case of messages which apply to individual systems, system 1 and system 2 messages will both be displayed and may be different. Following each message is an explanation of its meaning:

### General Status Messages

---

UNIT SWITCH OFF  
SHUTDOWN

---

The unit 'ON/OFF' switch on the control panel is in the 'OFF' position which will not allow the unit to run.

---

REMOTE CONTROLLED  
SHUTDOWN

---

An Integrated Systems Network (ISN), Remote Communications Device or Building Automation System (BAS) has turned the unit off.

---

DAILY SCHEDULE  
SHUTDOWN

---

The 'DAILY/HOLIDAY SCHEDULE' programmed is keeping the unit from running.

---

REMOTE STOP  
NO RUN PERM

---

A remote start/stop contact -XTB1 terminals 13 & 51 is open and the unit will not run.

---

FLOW SWITCH  
OPEN

---

Units without a hydro kit. The flow switch -XTBC1 terminals 13 & 14 is open and the unit will not run or if running, stops. A stop due to the flow switch opening is recorded in history as a UNIT FAULT: FLOW SWITCH OPEN, but no remote alarm is given.

---

**SYS X SYS SWI TCH OFF**

---

The system switch under 'OPTIONS' is turned off. The system will not be allowed to run until the switch is turned back on.

---

**SYS X NO COOL LOAD**

---

This message applies to the cooling mode only. The chilled liquid temperature is below the point (determined by the 'SETPOINT' and 'RANGE') that the microprocessor will bring on a system or that the microprocessor has not loaded the lead system far enough into the loading sequence to be ready to bring the lag system on. The lag system will display this message until the loading sequence is ready for the lag system to start.

---

**SYS X NO HEAT LOAD**

---

This message applies to the heating mode only. The hot liquid temperature is above the point (determined by the 'SETPOINT' and 'RANGE') that the microprocessor will bring on a system or that the microprocessor has not loaded the lead system far enough into the loading sequence to be ready to bring the lag system on. The lag system will display this message until the loading sequence is ready for the lag system to start.

---

**SYS X COOLI NG RUN X**

---



---

**SYS X HEATI NG RUN X**

---



---

**SYS X DEFROST RUN X**

---

Indicates that the respective system is running in cooling or heating or defrost due to demand. The 'X' will be replaced with the number of compressors in that system that are running.

---

**SYS X AR TI MER XXX S**

---

Shows the amount of time left on the respective systems anti-recycle timer. This message is displayed when the system is unable to start due the anti-recycle timer being active.

---

**SYS X AC TI MER XX S**

---

The anti-coincident timer is a software feature that guards against 2 systems starting simultaneously. This assures instantaneous starting current does

not become excessively high due to simultaneous starts. The microprocessor limits the time between compressor starts to 1 minute regardless of demand or the anti-recycle timer being timed out.

---

**SYS X DSCH LI MI TI NG**

---

Discharge pressure limiting is in effect. The limiting pressure is a factory set limit to keep the system from faulting on the high discharge pressure cutout due to high load or pull down conditions. When the unload point is reached, the microprocessor will automatically unload the affected system by de-energising one compressor.

The discharge pressure unload will occur when the discharge pressure gets within 0.7 barg of the programmed discharge pressure cutout. This will only happen if the system is fully loaded and will shut only one compressor off. Discharge limiting will prevent the last compressor in a system from starting if the discharge pressure is above 85% of the programmed discharge pressure cutout. Reloading the affected system will occur when the discharge pressure drops to 85% of the unload pressure and 10 minutes have elapsed.

---

**SYS X SUCT LI MI TI NG**

---

Suction pressure limiting is in effect. The suction pressure limit is a control point that limits the loading of the lag compressor in a system when the suction pressure drops to within 15% (cooling) 20 % (heating) above the suction pressure cutout. In heating/defrost modes the actual suction pressure cut-out value is used. (Refer to Fault Status Messages Section for details of actual suction pressure value calculation from discharge pressure).The system will be allowed to load after 60 seconds and after the suction pressure rises above the suction pressure limit point.



Suction pressure limiting in the cooling mode will not unload a system. Suction pressure limiting only prevents further loading.

In the heating mode if the suction pressure falls below the system actual suction pressure cut-out value then the lag compressor will stop. On units with 3 compressors per system, if after 20 seconds the suction pressure does not rise above the system actual suction pressure cut-out value the next lag compressor will stop. The system will be allowed to re-load after a delay of 180 seconds and after the suction pressure rises above the suction limit point.



During defrost suction limiting, both loading and unloading are disabled.

**Models with 3 compressors in a system (Heat Pump Mode Only)**

SYS X MAX LOAD LI MI T

In the heating mode this message indicates that the leaving hot liquid temperature is low and the number of compressors allowed to run is restricted to prevent low suction pressure trips.

If the Leaving Temperature is below 25°C the maximum number of compressors allowed to run in a system is 2. As the Leaving Temperature rises 5°C above the limit temperature the system is be allowed to load.

SYS X LOAD LI MI T XX%

Load limiting is in effect at the percentage shown. This limiting could be due to a load limit/PWM input terminals 13 and 20 on -XTBC1 or a remote communications device sending a load limit command.

**MANUAL  
OVERRI DE**

'MANUAL OVERRIDE' mode is selected under the 'OPTIONS' key. In this mode the 'Daily Schedule' is ignored and the unit will start-up when liquid temperature allows and the flow switch/remote contacts, unit switch and system switches permit. This is a priority message and cannot be overridden other 'STATUS' messages.



'MANUAL OVERRIDE' is to only be used in emergencies or for servicing. 'MANUAL OVERRIDE' mode automatically disables itself after 30 minutes.

**Fault Status Messages**

Safeties are divided into two categories - system safeties and unit safeties. System safeties are faults that cause the individual system to be shut down. Unit safeties are faults that cause all running compressors to be shut down.

**System Safeties (Auto Reset)**

SYS X DSCH I NHI BI T

In the heat pump mode the discharge inhibit protects a system from operating at low discharge pressure. After a time override of 20 minutes from system start or the end of a defrost the discharge pressure must be above 15 bar. If the discharge pressure is below 15 bar the system will stop with the above message and be held off for 30 minutes. This condition will give an alarm and be recorded in the history.

**System Safeties (Three Faults - Lockout)**

System safeties are faults that cause individual systems to be shut down if a safety threshold is exceeded for 3 seconds. The system will be allowed to restart automatically after the fault condition is no longer present. However, if 3 faults on the same system occur within 90 minutes, that system will be locked out on the last fault. This condition will require a manual reset using the system switch (under 'OPTIONS' key). The switch must be turned off and then back on to clear the lockout fault.

SYS X HI GH DSCH PRES

The software discharge pressure cut-out is backed-up by a mechanical high pressure cut-out switch located in each refrigerant circuit. The software cut-out assures that the system pressure does not exceed safe working limits.

The system will shutdown when the programmable cut-out is exceeded and will be allowed to restart when the discharge pressure falls below the cut-out.

SYS X LOW SUCT PRESS



There are two programmable suction pressure cut-out settings one for cooling mode the other for heating/ defrost modes.

In the Cooling mode the actual suction pressure cut-out cooling is the programmed suction pressure cut-out cooling. In the heating / defrost modes the suction pressure cut-out heating programmed value is used as a base line and is modified based on discharge pressure.

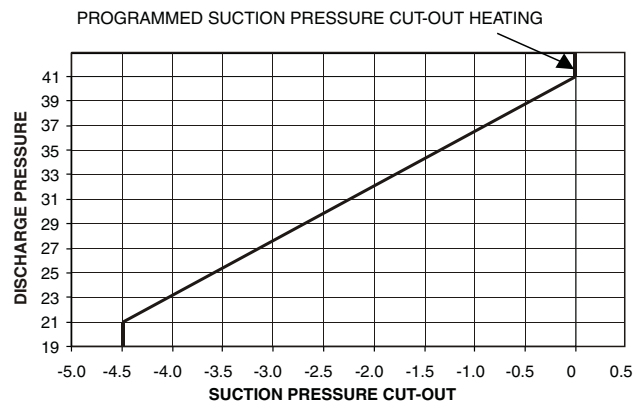

At a discharge pressure of 41 barg and above the actual suction pressure cut-out equals the programmed suction pressure cut-out heating. As the discharge pressure fall below 41 bar to a minimum of 21 bar the programmed suction pressure cut-out heating is lowered lineally by a maximum of 4.5 bar. Below a discharge pressure of 21 bar the actual suction pressure cut-out is equal to the programmed suction pressure cut-out heating minus

4.5 bar. The minimum actual suction pressure cut-out is 2 bar. The actual suction cut-out pressure can be found under the 'OPER DATA' key.

---

SYS 1 ACTUAL SUCTION  
CUTOUT = XXXX PSI G

---

At system start, the cut-out is set to 50% of the actual suction pressure cut-out value. During the next 3 minutes the cut-out point is ramped up to the actual cut-out point. If at any time during this 3 minutes the suction pressure falls below the ramped cut-out point, the system will stop. This cut-out is ignored for the first 30 seconds of system run time to avoid nuisance shutdowns. The ramped cut-out value = ((run time + 180 X actual cut-out value / 360).

After the first 3 minutes, if the suction pressure falls below the actual cut-out setting, a 'transient protection routine' is activated. This sets the cut-out at 50% of the actual value and ramps up the cut-out over the next 30 seconds. If at any time during this 30 seconds the suction pressure falls below the ramped cut-out, the system will stop. The transient cut-out value = ((100 - (1.66 X actual cut-out value / 100)). The transient timer counts down from 30 seconds.

---

SYS X MP/HPCO I NHI B

---



---

SYS X MP/HPCO FAULT

---

The Motor Protector (-FMP) / Mechanical High Pressure Cut-outs (-FHP) protect the compressor from overheating, overcurrent or the system from experiencing dangerously high discharge pressure.

This fault condition is present when 1-K1 (system 1) or 2-K1 (system 2) relays de-energise due to the -FHP cut-out, or the -FMP opening.

#### **-FMP**

The compressor electronic modules are connected to the motor winding temperature sensors and an internal discharge temperature sensor. The -FMP opens when the discharge temperature is above 140°C or when the winding temperature rises above the trip temperature. The winding and discharge sensors are connected in series and have a trip resistance of 4.5 kΩ ±20%, reset is less than 2.75 kΩ. The compressor electronic module has a 30 ±5 minute reset delay after the sensor reset resistance is reached.

#### **-FHP**

Mechanical high pressure cut-outs are fitted to meet code requirements.

The cut-out -FHP auto reset (-FHP2 on CE units hand reset) is set to 40.3 bar. A second high pressure cut-out, hand reset, -FHP1 is fitted on CE units set at 40.1 bar.

The 'SYS MP/HPCO INHIBIT' message indicates that if the shutdown was due to a motor protector, that when the motor protector resets the system will restart automatically. If the shut down was due to the mechanical high pressure cut-out, then the discharge pressure must fall to the reset pressure and for CE units the cut-out must be reset before the system can restart.

The 'SYS MP/HPCO FAULT' message indicates that the system has locked out and requires a electrical reset, in the case of the mechanical high pressure cut-outs, on CE units a device reset is also required.

#### **Unit Safeties**

Unit safeties are faults that cause all running compressors to be shut down.

---

UNI T FAULT:  
LOW AMBI ENT TEMP

---

The low ambient temperature cut-out is a safety shutdown designed to protect the unit from operating in a low ambient conditions. In the cooling mode if the outdoor ambient temperature falls below the programmable cutout, the unit will shut down. Restart can occur when temperature rises 1.2°C above the cut-off. In the heating mode, if the outdoor ambient temperature falls below -10°C or if the unit is fitted with the two speed option and fan speed inhibit is in effect -8°C, the unit will shut down. Restart can occur when temperature rises to above -8.9°C or if the unit is fitted with the two speed option and fan speed inhibit is in effect -6.9°C.

---

UNI T FAULT:  
HI GH AMBI ENT TEMP

---

In the heating mode only a high ambient temperature cut-out is a safety shutdown designed to protect then unit from operating in high ambient conditions. In the heating mode if the outside ambient rises to 25°C the unit will shut down. Restart can occur when temperature falls to 23°C.

---

UNI T FAULT:  
LOW LI QUI D TEMP

---

The low leaving chilled liquid temperature cut-out is operative in the cooling mode only. This safety protects the unit from a water heat exchanger freeze-up should the chilled liquid temperature drop below the freeze point in the cooling mode. This situation could occur under low flow conditions or if the microprocessor setpoint values are improperly programmed. Anytime the leaving chilled liquid temperature (water or glycol) drops below the cut-out point, the unit will shutdown. Restart can occur when chilled liquid temperature rises 1.2°C above the cut-out.

---

UNI T FAULT:  
115VAC UNDER VOLTAGE

---

The under voltage safety assures that the system is not operated at voltages where malfunction of the microprocessor could result in system damage. When the 110 Vac to the microprocessor drops below the limit, a unit fault is initiated to safely shut down the unit. Restart is allowed when the 110 Vac is within limits and the anti-recycle timers have finished counting down, unless MANUAL POWER FAIL RESTART is programmed under the OPTION key. In this case the unit switch must be set to OFF then back to ON to reset this trip.

**Units With Optional Hydro Kit**

On units with one pump: This indicates the manual motor starter protecting the pump from short circuit or overload conditions has tripped or been set to OFF. Setting the device to on will reset the trip.

On units with two pumps, duty and standby: This indicates that both the manual motor starters protecting the pumps from short circuit or overload conditions have tripped or both have been set to OFF. Setting at least one of the device to on will reset the trip.

---

UNIT FAULT:  
PUMP FAIL MAKE FLOW

---

On units with one pump: After the 30 second stop to start timer has timed out the Pump is started if there is a 'Leaving Liquid Temperature Cutout', or any of the compressors are running or with the daily schedule not calling for a shutdown with unit switch on and the remote stop/start input closed (terminals 13 & 51 on -XTBC1). If the flow switch does not close within 10 seconds the unit locks out on UNIT FAULT: PUMP FAIL MAKE FLOW and the pump is stopped. Setting the unit switch to OFF then back to ON will reset the trip.

On units with two pumps, duty and standby: After the 30 second stop to start timer has timed out the Pump is started if there is a 'Leaving Liquid Temperature Cutout', or any of the compressors are running or with the daily schedule not calling for a shutdown with unit switch on and the remote stop/start input closed (terminals 13 & 51 on -XTBC1). If the flow switch does not close within 10 seconds the running pump is stopped and the standby pump is started. If in a further 10 seconds the flow switch does not close the unit locks out on UNIT FAULT: PUMP FAIL MAKE FLOW and the running pump is stopped. Setting the unit switch to OFF then back to ON will reset the trip. In attempting to clear this fault also check that one of the manual motor starters protecting the pumps has not tripped.

**Unit Warning**

The low battery message is not a unit safety and will not be logged to the history buffer. It is a unit warning and will not auto-restart. Operator intervention is required to allow a re-start of the unit.

---

!! LOW BATTERY !!  
CHECK PROG/SETP/OPTN

---

The low battery message is not a unit safety and will not be logged to the history buffer. It is a unit warning and will not auto-restart. Operator intervention is required to allow a re-start of the unit.

The low battery warning will only occur at microprocessor power-up, when the RTC battery is checked. If a low battery is found, all programmed setpoints, program values, options, time, schedule, and history buffers will be lost. These values will all be reset to their default values which may not be the desired operating values.

Once a faulty battery is detected, the unit will be prevented from running until the 'PROGRAM' key is pressed. Once 'PROGRAM' is pressed the anti-recycle timers will be set to allow the operator time to check setpoints, program values, and options.



If a low battery is detected, it should be replaced as soon as possible. The programmed values will all be lost and the unit will be prevented from running on the next power interruption. The RTC/battery is located at U5 on the microprocessor board.

**Display/Print Keys**

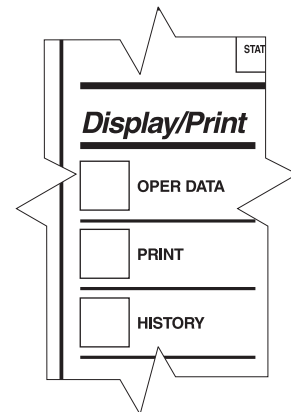

The Display/Print keys allow the user to retrieve system and unit information that is useful for monitoring unit operation, diagnosing potential problems, troubleshooting, and commissioning the unit.

System and unit information, unit options, setpoints, and scheduling can also be printed out with the use of an optional printer. Both real-time and history information are available.



**OPER DATA Key**

The 'OPER DATA' key gives access to unit and system operating parameters. When the 'OPER DATA' key is pressed, system parameters will be displayed and remain on the display until another key is pressed. After pressing the 'OPER DATA' key, the operating data messages can be scrolled through by using the 'UP ARROW' and 'DOWN ARROW' keys.

The following operating data messages will be displayed in the order shown:

---

```
LLT   = XXX. X °C
RLT   = XXX. X °C
```

---

This display shows leaving liquid temperature. The minimum display limit is -19.0°C and the maximum display limit is 60.1°C.

---

```
AMBI ENT AIR TEMP
      = XXX. X °C      "
```

---

This display shows the ambient air temperature. The minimum display limit is -17.4°C and the maximum display limit is 55.2°C.

---

```
SYS 1 SP = XXXX PSI G
      DP = XXXX PSI G
```

---



---

```
SYS 1 ACTUAL SUCTION
      CUTOUT = XXXX PSI G
```

---



---

```
SYS 1 AIR COIL DEFR
      TEMP   = XXX. X °C
```

---

These displays show suction and discharge pressures, in the heating mode the system actual suction cutout setting (based on system discharge pressure) and ambient coil defrost temperature. The minimum display limit for suction and discharge pressure is 0 barg. The maximum display limit for suction pressure is 27.58 barg and for discharge pressure is 44.7 barg. The minimum display limit for defrost temperature is -28.4°C and the maximum display limit is 29.0°C.

The above messages will be repeated sequentially for System 2.

---

```
SYS 1 SP = XXXX PSI G
      DP = XXXX PSI G
```

---



---

```
SYS 1 HOURS   1=XXXXX
              2=XXXXX 3=XXXXX
```

---

The above two messages will appear sequentially for each system. The first display shows accumulated running hours of each compressor for the specific system. The second message shows the number of starts for each compressor on each system.

---

```
LOAD TIMER XXX SEC
UNLOAD TIMER XXX SEC
```

---

This message shows the status of the load and unload timers in seconds until the unit can load or unload. Whether the unit loads or unloads is determined by how far the actual liquid temperature is from the 'SETPOINT'. Refer to Capacity Control Section for details of unit loading and unloading.

---

```
TEMP ERROR XXX. X °C
TEMP RATE XXX. X °C/M
```

---

The first line of this message shows the temperature error. That is the difference between the actual leaving liquid temperature and the 'Setpoint High/Low Limit' ('SETPOINT' plus/minus 'CONTROL RANGE'). Within the control range the error is zero. The second line shows the rate of change of leaving liquid temperature. Refer to Capacity Control Section for further details.

---

```
LEAD SYSTEM IS
SYSTEM NUMBER      X
```

---

This message indicates the current lead system. In the example system 2 is the lead system, making system 1 the lag system. The lead system can be manually or automatically selected. Refer to the 'Options' key Section for details.

---

```
EVAPORATOR HEATER
STATUS IS          OFF"
```

---

This message indicates the status of the evaporator heater.

The evaporator heater is controlled by ambient air temperature. When the ambient temperature drops below 4.4°C the heater is turned on. When the temperature rises above 7.2°C the heater is turned off. An under voltage condition will keep the heater off until full voltage is restored to the system.

---

```
EVAPORATOR WATER
PUMP STATUS      OFF "
```

---

This message indicates the status of the evaporator pump contact. After the 30 second stop to start timer has timed out the pump is started by closing a contact (terminals 23 & 24 on -XTBC2), if there is a 'Leaving Liquid Temperature Cutout', or any of the compressors are running or with the daily schedule not calling for a shutdown with unit switch on and the remote stop/start input closed (terminals 13 & 14 on -XTBC1).

---

```
EVAPORATOR WATER
PUMP STATUS      YYYY
```

---

If the optional Hydro Kit is fitted the above message relates to the unit internal pump.

On dual pump Hydro Kits the following messages are displayed:

---

EVAPORATOR WATER  
PUMP 1 STATUS YYY

---



---

EVAPORATOR WATER  
PUMP 2 STATUS YYY

---



---

EVAP PUMP TOTAL RUN  
HOURS = XXXX

---

This message indicates the total hours that the pump contact is closed (terminals 23 & 24 on -XTBC2).

---

PUMP TOTAL RUN  
HOURS = XXXX

---

If the optional Hydro Kit is fitted the above message relates to the unit internal pump. On dual pump Hydro Kits the following messages are displayed:

---

PUMP NO1 TOTAL RUN  
HOURS = XXXX

---



---

PUMP NO2 TOTAL RUN  
HOURS = XXXX

---

There are several types of remote systems that can be used to control or monitor the unit. The following messages indicate the type of remote control mode active:

---

ACTIVE REMOTE CTRL  
NONE

---

No remote control active. Remote monitoring may be via ISN.

---

ACTIVE REMOTE CTRL  
ISN

---

YorkTalk via ISN (Remote Mode).

---

ACTIVE REMOTE CTRL  
LOAD LIM

---

Load limiting enabled. Can be either stage 1 or stage 2 of limiting.

---

ACTIVE REMOTE CTRL  
PWM TEMP

---

EMS-PWM temperature reset.

---

LAST DEFROST SYS 1  
DURATION XXX SEC

---

In the heating mode the above message shows the last system to defrost and the duration of that defrost.

---

TIME REMAINING TO  
SYS 1 DEFROSTXXX MIN

---

In the heating mode the above message shows next system to be defrosted and the time remaining to that defrost.

---

TRAY HEATER STATUS  
OFF

---

When the optional defrost tray heaters are fitted the above message shows the status of the heaters ON or OFF

---

SYS 1 COMP STATUS  
1=ON 2=ON 3=ON

---



---

SYS 1 RUN TIME  
XX-XX-XX-XX D-H-M-S

---



---

SYS 1 COOLING  
XX-XX-XX-XX D-H-M-S

---



---

SYS 1 LAST STATE  
COOLING

---



---

SYS 1 MODE SV IS OFF

---



---

SYS 1 FAN STAGE XXX

---

The above six message will appear sequentially, first for system 1, then for system 2.

The first message indicates the status (ON or OFF) of each compressor in the system.

The second message indicates the system run time in days - hours - minutes - seconds.

 This is not accumulated run time but only the current system cycle.



The third message indicates the system, and its current status (OFF, COOLING, HEATING or DEFROST) and the time in days - hours - minutes - seconds this state has existed.

The fourth message indicates the system last state previous to the current state.

The fifth message shows the current state of the system mode solenoid valve ON or OFF.

The sixth message indicates what stage of condenser fan operation is active.

## PRINT Key

The 'PRINT' key allows the operator to obtain a printout of real-time system operating data or a printout of system data at the "instant of the fault" on the last six faults which occurred on the unit. An optional printer is required for the printout.

### Operating Data Print-out

Pressing the 'PRINT' key and then 'OPER DATA' key allows the operator to obtain a printout of current system operating parameters. When the 'OPER DATA' key is pressed, a snapshot will be taken of system operating conditions and panel programming selections. This data will be temporarily stored in memory and transmission of this data will begin to the printer..

### History Print-out

Pressing the 'PRINT' key and then the 'HISTORY' key allows the operator to obtain a printout of information relating to the last 6 Safety Shutdowns which occurred. The information is stored at the instant of the fault, regardless of whether the fault caused a lockout to occur. The information is also not affected by power failures or manual resetting of a fault lock-out.

When the 'HISTORY' key is pressed, a printout is transmitted of all system operating conditions which were stored at the "instant the fault occurred" for each of the 6 Safety Shutdowns buffers. The printout will begin with the most recent fault which occurred. The most recent fault will always be stored as Safety Shutdown No. 1. Identically formatted fault information will then be printed for the remaining safety shutdowns.

Information contained in the Safety Shutdown buffers is very important when attempting to troubleshoot a system problem. This data reflects the system conditions at the instant the fault occurred and often reveals other system conditions which actually caused the safety threshold to be exceeded.

The history printout is identical to the operational data printout with the exception of the header and the schedule information which is not printed.

## History Key

The 'HISTORY' key displays unit and system operating parameters at the time of a unit or system safety shutdown.

### Clearing History Buffers

The history buffers may be cleared by pressing the 'HISTORY' key and then repeatedly pressing the 'UP ARROW' key until you scroll past the last history buffer choice. The following message will be displayed:

---

INITIALIZE HISTORY?  
ENTER = YES

---

Pressing the 'ENTER/ADV' key at this display will cause the history buffers to be cleared. Pressing any other key will cancel the operation.

## History Messages

When the 'HISTORY' key is pressed the following message is displayed.

---

DISPLAY SAFETY SHUT-  
DOWN NO. (1 TO 9)

---

While this message is displayed, the 'UP ARROW' or 'DOWN ARROW' keys can be used to select any of the six history buffers. Buffer number 1 is the most recent, and buffer number 6 is the oldest safety shutdown that was saved.

After selecting the shutdown number, pressing the 'ENTER' key displays the following message which shows when the shutdown occurred.

---

SHUTDOWN OCCURRED  
12:00AM 18 JUN 71

---

The 'UP ARROW' and 'DOWN ARROW' keys are used to scroll forwards and backwards through the history buffer to display the shutdown conditions. The history data messages are shown below in the order that they are displayed:

---

UNIT FAULT:  
LOW LIQUID TEMP

---



---

UNIT TYPE  
HEATPUMP

---



---

CHILLED LIQUID  
WATER

---



---

LOCAL / REMOTE MODE  
LOCAL

---



---

CONTROL MODE  
COOLING

---



---

LEAD / LAG CONTROL  
AUTOMATIC

---



---

MANUAL OVERRIDE MODE  
DISABLED

---



---

POWER FAIL RESTART  
MANUAL

---



---

DISCHARGE PRESSURE  
CUTOUT = XXXX PSIG

---



---

SUCTION PRESS CUTOUT  
COOLING= XXXX PSIG

---



---

SUCTION PRESS CUTOUT  
HEATING= XXXX PSIG

---

LOW AMBI ENT TEMP  
CUTOUT = XXX. X °C

LEAVI NG LI QUI D TEMP  
CUTOUT = XXX. X °C

FAN CONTROL ON  
PRESSURE = XXXX PSI G

FAN DI FFERENTI AL OFF  
PRESSURE = XXXX PSI G

DEFROST I NI TI ATI ON  
TEMP = XX. X °C

DEFROST I NI TI ATI ON  
TIME = XX MI N

DEFROST TERMI NATI ON  
TIME = XX MI N

EXTERNAL  
EVAP PUMP

or

YORK HYDRO  
KI T PUMPS = 1

or

YORK HYDRO  
KI T PUMPS = 2

RATE SENSI TI VI TY  
` = XX. X °C/MI N.

LLT = XXX. X °C

C SETP = XX. X °C  
RANGE = +/- X. X °C

H SETP = XXX. X °C  
RANGE = +/- X. X °C

AMBI ENT AI R TEMP  
= XXX. X °C

LEAD SYSTEM I S  
SYSTEM NUMBER X

EVAPORATOR HEATER  
STATUS I S OFF

EVAPORATOR WATER  
PUMP STATUS OFF

Or with York hydrokit option

EVAPORATOR WATER  
PUMP STATUS YYYY

Or with York dual pump hydrokit option

EVAPORATOR WATER  
PUMP 1 STATUS YYYY

EVAPORATOR WATER  
PUMP 2 STATUS YYYY

EVAP PUMP TOTAL RUN  
HOURS = XXXXX

Or with York hydrokit option

PUMP TOTAL RUN  
HOURS = XXXXX

Or with York dual pump hydrokit option

PUMP NO1 TOTAL RUN  
HOURS = XXXXX

PUMP NO2 TOTAL RUN  
HOURS = XXXXX

ACTI VE REMOTE CTRL  
NONE

LAST DEFROST SYS X  
DURATI ON XXX SEC

TI ME REMAI NI NG TO  
SYS X DEFROSTXXX MI N

TRAY HEATER STATUS  
OFF

SYS X COMP STATUS  
1=ON 2=ON 3=ON

SYS X RUN TI ME  
XX-XX-XX-XX D-H-M-S

SYS X OFF  
XX-XX-XX-XX D-H-M-S

SYS X LAST STATE  
COOLI NG

SYS X SP = XXXX PSI G  
DP = XXXX PSI G"

SYS X ACTUAL SUCTION CUTOUT = XXXX PSI G
SYS X AIR COIL DEFR TEMP = XXX. X °C
SYS 1 MODE SV IS XXX
SYS 1 FAN STAGE XXX

The System 1 messages are displayed first and followed by the System 2 messages. Explanations of the history data messages are given under the 'STATUS', 'DISPLAY/PRINT', 'SETPOINTS' or 'UNIT' keys.

**Software Version**

The software version may be viewed by pressing the 'HISTORY' key and then repeatedly pressing the 'DOWN ARROW' key until you scroll past the first history buffer choice. The following message is an example of what will be displayed:

CONTROL	C. MMC. XX. XX
I/O	C. MMC. 18. XX

Where:

C is the Product Classification and stands for Commercial Unit

MMC or M is the Family Code and stands for Middle Market

XX is the Field Revision Number.

ZZ = 16 which is the Product Code.

YY = 00 which is the Version Number.

**Entry Keys**

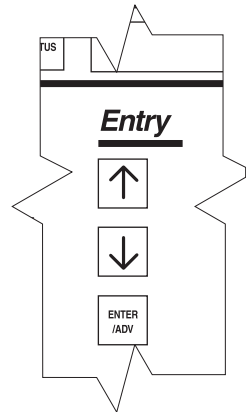

The Entry Keys allow the programmed values to be viewed and changed.

**UP ARROW and DOWN ARROW Keys**

Used in conjunction with the 'OPER DATA' and 'HISTORY' keys, the 'UP ARROW' and 'DOWN ARROW' keys allow the user to scroll through the data messages.

The 'UP ARROW' and 'DOWN ARROW' keys are also used for programming the control panel when changing setpoints, setting the daily schedule, changing safety setpoints, unit options, and setting the clock.

**ENTER/ADV Key**

The 'ENTER' key must be pushed after any change is made during programming to enter the new value into memory. If the 'ENTER' key is not pressed after a value is changed, the changes will not be 'entered' and the original values will be used to control the unit.

## Setpoints Keys

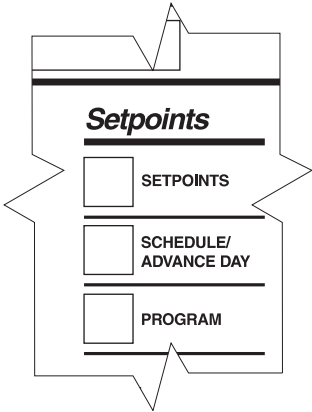

Programming and viewing the cooling and heating setpoints, daily schedule, and safeties is accomplished by using the 'SETPOINTS' keys.

### Setpoints

#### Cooling Setpoint

The cooling 'SETPOINT' and 'RANGE' can be viewed or programmed by pressing the 'SETPOINTS' key (Refer to Setpoint and Cut-out Settings). After pressing the key the 'SETPOINT' and 'RANGE' entry message is displayed:

---

C SETP = XX. X °C  
 RANGE = +/- X. X °C "

---

The above message shows the current chilled water temperature 'SETPOINT' at 6.7°C (the cursor is positioned under the number 6). Pressing the 'UP ARROW' or 'DOWN ARROW' will change the 'SETPOINT' in 0.1° increments. The 'ENTER/ADV' key must be pressed to enter the 'SETPOINT' into memory and advance to the 'RANGE'.

The cursor will move under the current 'RANGE' setting. Pressing the 'UP ARROW' or 'DOWN ARROW' will change the setting between 0.8°C to 2.5°C in 0.1°C increments. The 'ENTER/ADV' key must be pressed to enter the range into memory.

The 'RANGE' setting takes into account the number of compressors on the unit and the temperature difference between leaving (LCHLT) and return chilled liquid at full load.

The 'RANGE' should be set in accordance with the following table:

<b>Compressors</b>	4		
<b>Delta T °C</b>	3	5.5	8
<b>Range</b>	0.8	1.1	1.4

<b>Compressors</b>	5 & 6		
<b>Delta T °C</b>	3	5.5	8
<b>Range</b>	0.8	0.8	1.1



The 'RANGE' is programmed for +/- X.X° C. The 'SETPOINT' is in the centre of the control range.

For further details of cooling setpoint programming refer to Capacity Control Section.

#### Heating Setpoint

Pressing the 'SETPOINTS' key a second time will display the heating set point message:

---

H SETP = XXX. X °C  
 RANGE = +/- X. X °C

---

The above message shows the current hot water temperature 'SETPOINT' at 48.9°C (the cursor is positioned under the number 8). Pressing the 'UP ARROW' or 'DOWN ARROW' will change the 'SETPOINT' in 0.1°C increments. The 'ENTER/ADV' key must be pressed to enter the 'SETPOINT' into memory and advance to the 'RANGE'.

The cursor will move under the current 'RANGE' setting. Pressing the 'UP ARROW' or 'DOWN ARROW' will change the setting between 0.8°C to 2.5°C in 0.1°C increments. The 'ENTER/ADV' key must be pressed to enter the range into memory.

The 'RANGE' setting takes into account the number of compressors on the unit and the temperature difference between leaving (LLT) and return liquid at full load. The 'RANGE' should be set in accordance with the table shown above.



The 'RANGE' is programmed for +/- X.X° C with the 'SETPOINT' is in the centre of the control range.

For further details of heating Setpoint programming refer to Capacity Control Section.

### Remote Cooling Setpoint

Pressing the 'SETPOINTS' key a third time will display the remote cooling 'SETPOINT' and 'RANGE'. The range value is the value entered under the 'COOLING SETPOINT / RANGE' display:

---

REM C SP = XX.X °C  
RANGE = +/- X.X °C

---

This message automatically updates every 2 seconds. This setpoint is not programmable, but is controlled by a remote communications device or analogue voltage or current signal or EMS-PWM temperature reset signal.

### Remote Heating Setpoint

Pressing the 'SETPOINTS' key a fourth time will display the remote heating 'SETPOINT' and 'RANGE'. The range value is the value entered under the 'HEATING SETPOINT / RANGE' display:

---

REM H SP = XXX.X °C  
RANGE = +/- X.X °C

---

This message automatically updates every 2 seconds. This setpoint is not programmable, but is controlled by a remote communications device or analogue voltage or current signal or EMS-PWM temperature reset signal.

### SCHEDULE/ADVANCE DAY Key

The microprocessor features a continuously running internal clock and calendar and can display actual time as well as the day of the week and the date. An automatic schedule feature is provided for starting and stopping the unit on individual days of the week, eliminating the need for an external time clock. Also provided are a holiday feature, allowing special start/stop times to be set for designated holidays.

If the automatic schedule feature is not required, the microprocessor can be programmed to run the unit on demand as long as the unit ON/OFF and system switches are in the ON position. The daily schedule is considered 'not programmed' when the times in the schedule are all zeros (00:00 AM).

Programming of the operating and holiday schedules are described below.

To set the schedule, press the 'SCHEDULE/ADVANCE DAY' key. The display will show the following message:

---

SUN START = 00:00AM  
STOP = 00:00AM

---

The cursor will be under the 0. The time may be changed by using the 'UP ARROW' and 'DOWN ARROW' keys. Pressing the 'ENTER/ADV' key will enter the time and then move the cursor to the minute box. This process should be repeated until the hour, minutes, and meridian (AM or PM) of both the 'START' and 'STOP' times are set. After setting the meridian of the stop time, pressing the 'ENTER/ADV' key will advance the schedule to the next day.



Whenever the daily schedule is changed for Monday, all the other days will change to the new Monday schedule. This means if the Monday times are not applicable for the whole week then the individual days would need to be reprogrammed to the desired schedule.

To page to a specific day press the 'SCHEDULE/ADVANCE DAY' key. The start and stop time of each day may be programmed differently using the 'UP ARROW' and 'DOWN ARROW' and 'ENTER/ADV' keys.

After the Sunday schedule appears on the display a subsequent press of the 'SCHEDULE/ADVANCE DAY' key will display the Holiday schedule. This is a two part message. The first reads:

---

SUN START = 00:00AM  
STOP = 00:00AM

---

The times may be set using the same procedure as described above for the days of the week. After changing the meridian of the stop time, pressing the 'ENTER/ADV' key will advance the schedule to the following display:

---

S M T W T F S  
HOLI DAY NOTED BY \*

---

The line below the empty space next to the 'S' is the cursor and will move to the next empty space when the 'ENTER/ADV' key is pressed. To set the Holiday, the cursor is moved to the space following the day of the week of the holiday and the 'UP ARROW' key is pressed. An '\*' (asterisk) will appear in the space signifying that day as a holiday. The '\*' (asterisk) can be removed by pressing the 'DOWN ARROW' key.



The holiday schedule must be reprogrammed after holiday, because once the holiday schedule runs it will revert to the normal daily schedule.

**With optional two speed fans**

Pressing the ENTER/ADV key will advance the schedule to the following display:

---

FAN            ON    00: 00AM  
 I N H I B I T   OFF   00: 00AM

---

A time range can be set during which the fans will be preventing from operating on the last stage, full speed, to reduce unit noise say at night. Fan inhibit is considered not programmed when the times in the schedule are all zeros (00:00 AM). Programming 12:00 AM in both the On and OFF time means Fan Inhibit is in effect continuously.

The time may be changed by using the UP ARROW and DOWN ARROW keys. Pressing the ENTER/ADV key will enter the time and move the cursor to the minute box. This process should be repeated until the hour, minutes and meridian (AM or PM) of both the ON and OFF times are set. After setting the meridian of the OFF time pressing the ENTER/ADV key will enter the values.

**PROGRAM Key**

The 'PROGRAM' key is used to set the programmable cut-outs, timers and switching points. These parameters can be changed by pressing the 'PROGRAM' key, and then the 'ENTER/ADV' key to enter the program mode. Continuing to press the 'ENTER/ADV' key will display each operating parameter. While a particular parameter is being displayed, the 'UP ARROW' and 'DOWN ARROW' keys can be used to change the value (Refer to Setpoint and Cut-out Settings Section). After the value is changed, the 'ENTER/ADV' key must be pressed to enter the new parameter into memory.

The programmable parameters are displayed in the following order:

---

DI S C H A R G E   P R E S S U R E  
 C U T O U T   =   X X X X   P S I   G

---

The discharge pressure cut-out is the pressure at which the system will shutdown as monitored by the discharge pressure transducer. This cut-out is backed-up by a mechanical (two off manual reset devices on CE units) HP switch located in each refrigerant circuit.

---

S U C T I O N   P R E S S   C U T O U T  
 C O O L I N G =   X X X X   P S I   G

---

In the cooling mode the suction pressure cut-out cooling protects the unit from a refrigerant to water heat exchanger freeze-up. If the suction pressure drops below the cutout point, the system will shut down.

---

S U C T I O N   P R E S S   C U T O U T  
 H E A T I N G =   X X X X   P S I   G

---

In the heating mode the suction pressure cut-out heating protects the unit from low suction pressure in the ambient coils. If the suction pressure drops below the cut-out point, the system will shut down.



There are some exceptions when the suction pressure is permitted to temporarily drop below the cut-out setting. Refer to Fault Status Message Section for details.

---

L O W   A M B I E N T   T E M P  
 C U T O U T   =   X X X . X   ° C

---

The low ambient temperature cut-out setting is applicable to the cooling mode only (NOTE in heating mode the cut-out is fixed at -10°C or -8°C if fan full speed inhibit is in effect with optional 2 speed fans). If the ambient temperature falls below this point, the unit will shut down. Restart can occur when temperature rises 1.11°C above the cut-out setting.

---

L E A V I N G   L I Q U I D   T E M P  
 C U T O U T   =   X X X . X   ° C

---

The leaving liquid temperature cut-out protects the unit in the cooling mode from a refrigerant to water heat exchanger freeze-up. Anytime the leaving liquid temperature drops to the cut-out point, the unit shuts down. Restart will be permitted when the leaving liquid temperature rises 1.11°C cooling mode or 2.0 °C heating mode above the cut-out setting.



When water cooling mode is programmed ('OPTIONS' key), the cut-out is fixed at 3.0°C and cannot be changed. Glycol cooling mode values are programmable.

---

A N T I   R E C Y C L E   T I M E  
 =   X X X   S E C S

---

Each system has its own anti-recycle timers. The anti-recycle time under the 'PROGRAM' key can be programmed between 240-600 seconds and sets the minimum start-to-start time of the lead compressor in a system. A second non-programmable anti-recycle timer, stop to start is fixed at 90 seconds, starts to countdown when the lead compressor in a systems cycles off. On power up only this timer is set to 120 seconds not 90 seconds.

The anti-recycle message is displayed when a system is unable to start due to either of the anti-recycle timers being active (counting down). The actual time displayed will be the longer of the two timers, start-to-start or stop-to-start. The lag compressor in a system, are not controlled by the anti-recycle timer.



---

FAN CONTROL ON  
PRESSURE = XXXX PSI G

---

In the cooling mode the fan control ON pressure is the programmed setting that is used to stage the ambient coil fans on, in relation to discharge pressure.

---

FAN DIFFERENTIAL OFF  
PRESSURE = XXXX PSI G

---

In the cooling mode the fan differential OFF pressure is the programmed differential setting that is used to stage the ambient coil fans off, in relation to discharge pressure.

---

TOTAL NUMBER OF  
COMPRESSORS = X

---

The total number of compressors setting determines the stages of loading available.



The total number of compressors must be programmed correctly to ensure proper unit operation.

---

SYS1 NUMBER OF FANS  
= X

---



---

SYS2 NUMBER OF FANS  
= X

---



The total number of fans per system must be programmed correctly to ensure proper unit operation.

---

REMOTE UNIT ID  
PROGRAMMED = X

---

When the unit is connected to a remote ISN controller this message allows the identification number to be programmed into the unit.

---

DEFROST INITIATION  
TEMP = XX. X °C

---

In the heating mode the defrost initiation temperature is the temperature below which a defrost will occur when the defrost initiation time expires.

---

DEFROST INITIATION  
TIME = XX MIN

---

In the heating mode the defrost initiation time is the programmed optimum time between defrosts, system to system. The actual time between defrost is adapted from this 100% programmed value as part of the adaptive defrost control.

---

DEFROST TERMINATION  
TIME = XX MIN

---

In the heating mode the defrost termination time should be regarded as the maximum optimum time that a defrost should take.

In the cooling mode for loading to take place the leaving water temperature must not be falling faster than the programmed value when the temperature is within the 'RATE CONTROL TEMP RANGE'.

---

RATE SENSITIVITY  
= XX. X °C/MIN.

---

In the heating mode for loading to take place the leaving water temperature must not be rising faster than the programmed value when the temperature is within the 'RATE CONTROL TEMP RANGE'.

---

RATE CONTROL TEMP  
= XX. X °C

---

In the cooling mode this range starts at the top of the control range. Within this range rate sensitivity as programmed above is used. Above this range a fixed 1.7 °C/min is used. Loading is prevented if the leaving water temperature is falling faster than the 'RATE SENSITIVITY' value.

In the heating mode this range starts at the bottom of the control range. Within this range rate sensitivity as programmed above is used. Below this range a fixed 1.7 °C/min is used. Loading is prevented if the leaving water temperature is rising faster than the 'RATE SENSITIVITY' value.

#### Units with Dual Pump Hydro kit Option

---

DUTY/STANDBY PUMP  
CHANGE OVER =XX DAYS

---

When under the 'OPTION' key the PUMP SELECTION is set to AUTOMATIC, the DUTY PUMP is the pump with the shortest run hours. Pump duty is changed when the pumps are off or if the duty pump run hours are greater than the programmed 'DUTY/STANDBY PUMP CHANGE OVER DAYS'.

## Setpoint and Cut-out Settings



Refer to Operating Limitations in ICOM when setting or adjusting Setpoint and Cut-out Settings.

Parameter	Type	Low Limit	High Limit	Default
Cooling Liquid 'SETPOINT' <sup>(1)</sup>	Water Cooling <sup>(2)</sup>	4.4°C	21.1°C	6.7°C
	Glycol Cooling <sup>(3)</sup>	-7.2°C	21.1°C	6.7°C
	Low Glycol Cooling (option)	-13.3°C	21.1°C	6.7°C
Cooling Liquid 'RANGE'	Water/Glycol	0.8°C	2.5°C	1.1°C
Heating Liquid 'SETPOINT'	All	35°C	55°C	50°C
Heating Liquid 'RANGE'	All	0.8°C	2.5°C	1.1°C
Maximum EMS-PWM Remote Temperature Rese	Water/Glycol	1.0°C	22.0°C	11.0°C

(1) Contact York for application guidelines before exceeding 12.8°C 'SETPOINT'.

(2) **Leaving Chilled Liquid 'SETPOINT' should not be set below 5°C for water cooling.**

(3) **Leaving Chilled Liquid 'SETPOINT' should not be set below -6 °C for glycol cooling.**

Parameter	Type	Low Limit	High Limit	Default	Factory Setting
Discharge Pressure Cutout	Water/Glycol	22.4 barg	39.6 barg	38.6 barg	39.6 barg
Suction Pressure Cutout (Cooling)	Water Cooling	5.52 barg	8.27 barg	6.00 barg	5.59 barg
	Glycol Cooling	2.90 barg	8.27 barg	6.00 barg	Note (4)
Suction Pressure Cutout (Heating)	Heating	6.00 barg	6.90 barg	6.00 barg	6.00 barg
Low Ambient Temperature Cut-out (Cooling) <sup>(1)</sup>	Water/Glycol	-17.8°C	15.6°C	-3.9°C	-17.8°C
Leaving Chilled Liquid Temperature Cut-out	Water Cooling			3.0°C	3.0°C
	Glycol Cooling	-13.1.0°C	2.2°C	2.2°C	Note (4)
	Low Glycol Cooling (option)	-18.3°C	2.2°C	2.2°C	Note (4)
Anti-Recycle Timer	Water/Glycol	240 s	600 s	600 s	600 s
Fan Control On-Pressure	Water/Glycol	20.0 barg	33.4 barg	23.0 barg	23.1 barg
Fan Differential Off-Pressure <sup>(2)</sup>	Water/Glycol	3.7 barg	11.0 barg	5.5 barg	5.5 barg
Total Number Of Compressors	Water/Glycol	4	6	6	Note (5)
System 1 Number of Fans	Water/Glycol	2	6	3	Note (6)
System 2 Number of Fans	Water/Glycol	2	6	3	Note (6)
Unit ID	Water/Glycol	0	7	0	0
Defrost Initiation Temperature		2.8°C	8.9°C	5.0°C	5.0°C
Defrost Initiation Time		15 Mins	90 Mins	60 Mins	25 Mins
Defrost Termination Time		1 Min	6 Mins	3 Mins	3 Mins
Rate Sensitivity	Water/Glycol	1.0°C	8.0°C	1.7°C	1.7°C
Rate Control Temperature	Water/Glycol	1.0°C	11.0°C	6.1°C	6.1°C
Duty/Standby Pump Change Over - Dual Pump Hydro Kit Option		1 Day	30 Days	14 Days	14 Days

(1) The low ambient cut-out is fixed at - 10°C or -8°C if fan speed inhibit is in effect on units with two speed fan options in the heating mode.

(2) The minimum discharge pressure allowed with any fans running is approximately 16.6 barg.

i.e. Fan Control On Pressure - Fan Differential Off Pressure is not lower than approximately 16.6 BARG

The Discharge Fan Differential Off Pressure high limit is lowered to prevent going below approximately 16.6 barg based on where the Discharge Fan Control On Pressure is programmed.

(3) Defrost termination temperature is fixed at 8.0°C.

(4) Programmed on site to match glycol concentration and site requirements

(5) Programmed to match number of compressors

(6) Programmed to match number of fans

## Unit Keys

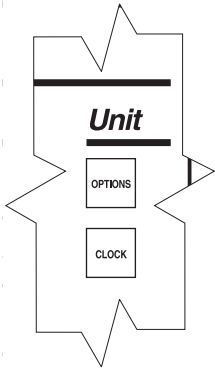

### OPTIONS Key

The 'OPTIONS' key is used to scroll through the list of options by repeatedly pressing the 'OPTIONS' key. The options may be changed using the 'UP ARROW' and 'DOWN ARROW' keys. After an option is changed the 'ENTER/ADV' key must be pressed to enter the setting into memory. The options are displayed in the following order:

---

DI SPLAY LANGUAGE  
ENGLI SH

---

One of the display message languages may be selected.

---

SYS 1 SWI TCH ON  
SYS 2 SWI TCH ON

---



---

SYS 1 SWI TCH OFF  
SYS 2 SWI TCH OFF

---



---

SYS 1 SWI TCH ON  
SYS 2 SWI TCH OFF

---



---

SYS 1 SWI TCH OFF  
SYS 2 SWI TCH ON

---

The System Switches can be set to allow both systems to run, stop both systems or only one system to run.

---

CHI LLED LI QUI D  
WATER

---



---

CHI LLED LI QUI D  
GLYCOL

---

The liquid type can be set for water or glycol.

---

LOCAL / REMOTE MODE  
LOCAL

---



---

LOCAL / REMOTE MODE  
REMOTE

---



For correct operation only change Mode Selection Local\Remote when unit switch is set to OFF.

When programmed for LOCAL the next option message allows the control mode to be selected cooling or heating. If connected the remote mode selection contact is ignored. If connected to a remote communication device it can be used to monitor only. The microprocessor will operate on locally programmed values and ignore all commands from the remote devices. The unit will communicate and send data a remote communication device.

With 'REMOTE' selected the remote mode selection contact is operative unless a remote communication device is connected and is sending other than zero for the mode page. A remote communication device can be used to control the following items: Remote Start/Stop, Cooling Setpoint, Heating Setpoint, mode (heating or cooling), Load Limit, and History Buffer Request (ISN only).

The remote communication device can allow the unit to use its own setpoints (cooling and heating) by sending the appropriate code on the associated pages.

The remote communication device can send 0 (No Load Limit), 1 (One Step Load Limit) or 2 (Two Steps of Load Limit) on the load limit page.

If the unit receives no valid remote communication device transmission for 5 minutes, it will revert back to the locally programmed values.

---

CONTROL MODE  
COOLI NG

---



---

CONTROL MODE  
HEATI NG

---

If the 'LOCAL / REMOTE MODE' option is set to 'LOCAL' this message will determine the mode of unit operation.

---

DI SPLAY UNI TS  
I MPERI AL

---



---

DI SPLAY UNI TS  
SI

---

Display messages can be shown in Imperial units (°F or PSI) or SI units (°C or Bar).



If the DISPLAY UNIT setting under the OPTION key is changed with a Remote Device connected, the power to the unit must be switch OFF and ON again. Failure to do this may result in erroneous data being transmitted.

---

LEAD / LAG CONTROL  
MANUAL SYS 1 LEAD

---



---

LEAD / LAG CONTROL  
MANUAL SYS 2 LEAD

---



---

LEAD / LAG CONTROL  
AUTOMATIC

---

System1 or system 2 can be selected as the lead system under manual or the microprocessor will determine which system is assigned to the lead and lag under automatic. A new lead/lag assignment is made whenever all compressors are shut down in automatic. The microprocessor will then assign the lead to the system compressor with the shortest average run time.

---

MANUAL OVERRIDE MODE  
DISABLED

---



---

MANUAL OVERRIDE MODE  
ENABLED

---

This option allows the programmed daily schedule to be overridden for service tasks when the mode is enabled. It will automatically be disabled after 30 minutes.

---

POWER FAIL RESTART  
AUTOMATIC

---



---

POWER FAIL RESTART  
MANUAL

---

If automatic is set the unit will restart automatically after a power failure with the unit anti recycle timers counting down from 120 seconds.

If manual is set then after a power failure the status message will read 'UNIT FAULT: 115VAC UNDER VOLTAGE'. To restart the unit, the unit switch (under the key pad) must be set to 'OFF' then back to 'ON'.

---

SOFT START  
ENABLED

---

This message must only be displayed when the unit is fitted with soft starters. On units not fitted with soft start the message will not be displayed. If the option is incorrect, contact your local YORK / Johnson Controls service office.

---

UNIT TYPE  
HEATPUMP

---

This option is factory set and should always read HEAT PUMP. If a unit type other than heat pump is displayed, with the power OFF check that a 6.2Kohm resistor is correctly installed on the microprocessor board across J11 pins 7 and 12. Switching the power ON with the resistor fitted will reboot the software to have a 'UNIT TYPE HEAT PUMP'.

---

REFRIGERANT TYPE  
R-410A

---

This option is factory set and should always read R410A. If the refrigerant type is incorrect contact your local YORK office.

---

FLASH CARD UPDATE  
DISABLED

---

This message should read DISABLED. Do not change to ENABLED.

---

REMOTE TEMP RESET  
INPUT DISABLED

---



---

REMOTE TEMP RESET  
INPUT 0.0 TO 10.0 V

---



---

REMOTE TEMP RESET  
INPUT 2.0 TO 10.0 V

---



---

REMOTE TEMP RESET  
INPUT 0.0 TO 20.0 MA

---



---

REMOTE TEMP RESET  
INPUT 4.0 TO 20.0 MA

---

If the temperature input is not used ensure the message reads disabled. If the input is used set to the required type of input.

---

EXTERNAL  
EVAP PUMP

---



---

YORK HYDRO  
KIT PUMPS = 1

---



---

YORK HYDRO  
KIT PUMPS = 2

---

This option must be set to reflect if an external evaporator pump or a YORK Hydro kit with single or dual pumps is used.

---

PUMP SELECTION  
AUTOMATIC

---



---

PUMP SELECTION  
MANUAL PUMP No 1

---



---

PUMP SELECTION  
MANUAL PUMP No 2

---

When the dual pump YORK Hydro Kit Option is fitted one of the above selections can be made. When AUTOMATIC is selected the DUTY PUMP is

the pump with the shortest run hours. Pump duty is changed when the pumps are off or if the duty pump run hours are greater than the 'DUTY/STANDBY PUMP CHANGEOVER DAYS' (programmed under the program key). If the running pump fails to make flow, or flow is lost, or the pumps manual motor starter trips on overload, the duty pump will be stopped and the standby pump will start.

When MANUAL PUMP No 1 or 2 is selected the selected pump is the only pump available to run.

---

DATALOG TO FLASHCARD  
OFF

---

The data log feature should be set to OFF

### CLOCK Key

Pressing the 'CLOCK' displays the current day, time, and date. It is important that the date and time are correct, otherwise the daily schedule will not function as correctly. In addition, for ease of troubleshooting via the History printouts, the day, time, and date should be correct.

To change the day, time, and date press the 'CLOCK' key. The display will show:

---

TODAY I S SUN 12: 00AM  
18 JUN 97

---

The cursor is positioned under the day. Pressing the 'UP ARROW' or 'DOWN ARROW' will change the day. The 'ENTER/ADV' key must be pressed to enter the value into memory and to move to the next value. The hour, minute, meridian, date, month and year may be programmed in the same manner.

### Optional Soft Start



Always isolate the unit supply before removing the compressor motor terminal box covers. On compressors with soft start fitted phase L2 of the starter is uncontrolled and thus the motor terminals will be LIVE even with the compressor OFF, unless the unit supply is isolated.

Optional soft start is fitted to the last compressor to start in each system. The soft starter controls the inrush current by switching the voltage to the compressor motor phases L1 and L3. The starter characteristics are specifically matched to the needs of the scroll compressors to ensure trouble free starting and to meet lubrication requirements by acceleration to full speed within 0.8 of a second. At the end of the voltage ramp up time an internal bypass contactor will operate.

The soft starter is provided with two status LED's: DEVICE light will be ON green as soon as the control circuit supply is turned ON. During the start-up ramp the DEVICE light will flash, but the flashing may not be detectable due to the short ramp up time. The DEVICE

and STATE/BYPASS-FAILURE lights will be on, green, when the compressor is running.

### Diagnostics

If the DEVICE light is OFF check the control supply 110V to soft starter terminal A1 and A2.

DEVICE light On No STATE/BYPASS-FAILURE light ON, compressor expected to start. Check for 110V on soft starter terminals 1 and A2. Check for three phase voltage, soft starter terminals 1, 2 and 3. With the control panel isolator OFF check wiring to compressor motor and compressor motor windings.

### Detected fault conditions

DEVICE light OFF, STATE/BYPASSED/FAILURE RED. The control voltage 1, A1 and A2 is outside the normal control voltage range of the soft starter. Check for correct voltage or intermittent supply or voltage dips.

DEVICE light YELLOW, STATE/BYPASSED/FAILURE RED. The three phase current during normal running is 3.5 \*I<sub>e</sub> of the soft starter indicating to compressor has stalled. Check for mechanical failure of the compressor.

DEVICE light GREEN, STATE/BYPASSED/FAILURE RED. Missing 3 phase input voltage (single phasing), output connection to motor or motor winding problem. Dip in supply voltage 15% for >100ms during starting or >200ms during running.

DEVICE light RED, STATE/BYPASSED/FAILURE RED. Internal problem with soft starter.

### Commissioning

Due to vibration during transport the soft starter internal bypass contactor may be in a undefined state. If the following procedure is not followed this may result in the compressor momentarily starting when the unit power is first turned on.



During commissioning or if the soft start is replaced the following procedure MUST BE PERFORMED.

- With the unit switch and unit switch disconnect set to OFF to isolate the unit, remove the fuses from the compressors fitted with a soft starter.
- Turn ON the unit switch disconnect to turn on the unit supply and thus apply control circuit voltage to soft starter terminals A1 and A2.
- Turn OFF the unit disconnect switch and refit the compressor fuses.

## Inputs / Outputs

### Digital Inputs

INPUT	XTBC1	-AMB	DESCRIPTION	IDENT
	13	J13-1	+30VDC	
1	-	J13-2	UNIT SWITCH	-SOA
2	20	J13-3	PULSE WIDTH MODULATED TEMPERATURE RESET or REMOTE UNLOAD STEP 2	PWM
3	21	J13-4	REMOTE UNLOAD STEP 1	RU
4	51	J13-5	REMOTE START STOP	RP
5	50	J13-6	MODE SELECTION (OPEN COOLING CLOSED HEATING)	MS
6	-	J13-7	NOT USED	NU
7	-	J13-8	SYS 1 FAULT INPUT	=1-KCR
8	14	J13-9	FLOW SWITCH	SF
9	-	J13-10	SYS 2 FAULT INPUT	=2-KCR
10	15	J13-11	FAN SPEED INHIBIT	FSI

### Analogue Inputs

INPUT	-AMB	DESCRIPTION	IDENT
	J11-1,3,4,5,6,7	0V	
	J11-7,8,9,10	+5V	
1	J11-11	REMOTE TEMP RESET +SIGNAL	-XTBC1:A+
2	J11-6	REMOTE TEMP RESET -SIGNAL	-XTBC1:A-
3	J11-12	RESISTOR UNIT TYPE SELECT	-R1
4	J11-13	NOT USED	NU
5	J11-14	NOT USED	NU
6	J11-15	NOT USED	NU
	J6-1,2,3	0V	
	J6-4,5,6	+5V	
7	J6-7	LEAVING LIQUID TEMPERATURE	-BLCT
8	J6-8	NOT USED	NU
9	J6-9	AMBIENT TEMPERATURE	-BAMB
	J7-1,2,3,4,7,9	0V	
	J7-5,6,8	+5V	
10	J7-10	SYS 1 SUCTION PRESSURE	=1-BSP
11	J7-11	SYS 1 DISCHARGE PRESSURE	=1-BDP
12	J7-12	NOT USED	NU
	J8-1,2,3	0V	
	J8-4,5,6	+5V	
13	J8-7	NOT USED	NU
14	J8-8	SYS 1 AIR COIL DEFROST TEMPERATURE	=1-BACDT
15	J8-9	NOT USED	NU
	J9-1,2,3,4,7,9	0V	
	J9-5,6,8	+5V	
16	J9-10	SYS 2 SUCTION PRESSURE	=2-BSP
17	J9-11	SYS 2 DISCHARGE PRESSURE	=2-BDP
18	J9-12	NOT USED	NU
	J10-1,2,3	0V	
	J10-4,5,6	+5V	
19	J10-7	NOT USED	NU
20	J10-8	SYS 2 AIR COIL DEFROST TEMPERATURE	=2-BACDT
21	J10-9	NOT USED	NU

## Digital Outputs

OUTPUT	-AMB	IDENT	DESCRIPTION	IDENT
	XTB7-1	110V VIA =1-KCR		
1	XTB7-2	=AMB-K1	SYS 1 COMPRESSOR 1	=1-KM1
2	XTB7-3	=AMB-K2	SYS 1 MODE SOLENOID VALVE	=1-YMSV
3	XTB7-4	=AMB-K3	SYS 1 COMPRESSOR 2	=1-KM2
4	XTB7-5	=AMB-K4	SYS 1 COMPRESSOR 3	=1-KM3
	XTB7-6	110V		
5	XTB7-7	=AMB-K5	SYS 1 FAN FORWARD	=1-KFFR
6	XTB7-8	=AMB-K6	SYS 1 FAN OUTPUT 1	=1-KF1
7	XTB7-9	=AMB-K7	SYS 1 FAN OUTPUT 2	=1-KF2
8	XTB7-10	=AMB-K8	SYS 1 FAN OUTPUT 3	=1-KF3
	XTB10-1	110V VIA =2-KCR		
9	XTB10-2	=AMB-K17	SYS 2 COMPRESSOR 1	=2-KM1
10	XTB10-3	=AMB-K18	SYS 2 MODE SOLENOID VALVE	=2-YMSV
11	XTB10-4	=AMB-K19	SYS 2 COMPRESSOR 2	=2-KM2
12	XTB10-5	=AMB-K20	SYS 2 COMPRESSOR 3	=2-KM3
	XTB10-6	110V		
13	XTB10-7	=AMB-K21	SYS 2 FAN FORWARD	=2-KFFR
14	XTB10-8	=AMB-K22	SYS 2 FAN OUTPUT 1	=2-KF1
15	XTB10-9	=AMB-K23	SYS 2 FAN OUTPUT 2	=2-KF2
16	XTB10-10	=AMB-K24	SYS 2 FAN OUTPUT 3	=2-KF3
	XTB8-1	110V		
17	XTB8-2	=AMB-K9	EVAPORATOR HEATERS HEAT RECOVERY OPTION HEATER PUMP HEATER RELAY (OPTIONAL)	-EEH -EHRH1/2 -KPH
18	XTB8-3	=AMB-K10	SYS 1 FAULT	=1-KCR
19	XTB8-4	=AMB-K11	OPTION HYDRO KIT PUMP No2	-KP2
20	XTB8-5	=AMB-K12	SYS 1 FAN SPEED RELAY (2 SPEED FANS)	1-KFS
21	XTB8-6/7	=AMB-K13	EXTERNAL EVAPORATOR PUMP (OPTION HYDRO KIT PUMP No1)	-XTBC2 23-24 -KP1
22	XTB8-8/9	=AMB-K14	SYS 2 FAN SPEED RELAY (2 SPEED FANS)	2-KFS
23	XTB9-1/2	=AMB-K15	SYS 2 FAULT	=2-KCR
24	XTB9-3/4	=AMB-K16	HEATER DEFROST TRAY RELAY OPTION	-KHDT

## Optional Printer Installation

The microprocessor is capable of supplying a printout of unit conditions or fault shutdown information at any given time. In addition, to the manually selected printouts the microprocessor will provide an automatic printout whenever a fault occurs. An explanation of the print function is given under the Display/Print Keys Section. If the RS232 (TB3) printer port does not work check the following. Press PROGRAM, DOWN ARROW, DOWN ARROW, DOWN ARROW, DOWN ARROW, ENTER keys in turn. Then repeatedly press the ENTER key and check the following settings: P2 PROTOCOL API, P2 BAUD RATE 1200, P2 PARITY NONE, P2 HW SELECT BIT RS-232. If necessary use the DOWN ARROW key to set the correct value, then press the ENTER key. Power down then power-up the unit



The Printer option is not available if the Modbus feature is being used.

## Printers for UK and Europe

YORK offer a kit which includes a printer which has an internal Ni-cad battery, a roll of paper, a 'D' type connector, one metre lead and a charger. This is a compact low cost printer that is ideal for service work and data logging.

Paper is in the form of a compact roll and is easily handled compared to larger printers using wider business form style paper. The paper is 58 mm wide desktop calculator paper that can be easily and inexpensively purchased at most stationery stores.

## Installation Limitations



The following limitations must be adhered to. Failure to do so may result in improper printer and/or unit operation.

- Maximum cable length between the printer and the Microprocessor Board is 7.5 m. Twisted pair shielded cable is required (1 m with optional printer).
- Serial printer should be set for data bits = 8 parity = none and baud rate = 1200.
- The printer may be left connected to the microprocessor panel.

**Parts**

The following parts are required:

- Printer kit, YORK part number: 362L11330-002 UK, obtainable from UK spares, part number: 36211330-003 EUROPE, obtainable from UK spares.



The printer must be set up by customer as detailed using the operator guide supplied with printer.

- 58 mm wide desk top calculator paper. One roll included in kit. Extra roll part number: 25L01992-000 obtainable from UK spares.
- Spare Ink Ribbon YORK part number: 025L01993-000 obtainable from UK spares.

**Assembly and Wiring**

All components should be assembled and wired as shown in below. Strip the outer insulation back several centimetres and individual wires 10 mm to connect the cable at the microprocessor board (TB3). Do not connect the shield at the printer-end of the cable.

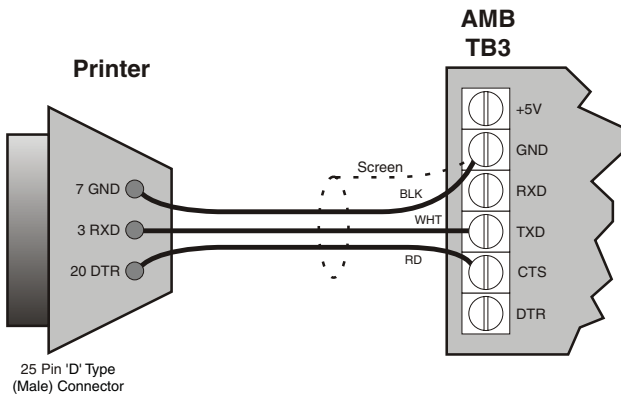

AMB TB3	Function	Printer
TXD	Serial data to printer	RXD
CTS	Busy signal from printer (high to accept data)	DTR
GND	Signal ground to printer	GND

White (WHT)	Cable colours with York Supplied printer option, UK: 362L11330-002, Europe: 362L11330-003
Black(BLK)	
Red(RD)	

**Using Other Printers**

Control codes vary from printer to printer. This may result in unusual formatting of printed data from many printers. In addition, 'handshaking' lines and 'handshaking' sequence will differ between printers. This makes the equipment susceptible to operation problems or mis-wiring which may cause damage to the printer or the microprocessor board. YORK assumes no responsibility for assistance or damage in the use of non-specified printers.

**Warranty**

YORK assumes no warranty responsibility in the use of the printer. This includes damages to the printer and the microprocessor board or unit operation problems which may result.

**Obtaining a Printout**

A printout can be obtained by pressing the 'PRINT' key on the keypad and then pressing either the 'OPER DATA' key or 'HISTORY' key.

**BAS/EMS Temperature Reset**

**BAS/EMS Temperature Reset Using a Voltage or Current Signal**

If the EMS-PWM feature has been activated, no message REMOTE TEMP RESET INPUT is visible under the OPTION key the following feature is disabled. Contact Johnson Controls York Product service if you require the following feature.

The chilled liquid and hot liquid setpoints can be reset using a single remote 0 - 10VDC or 2-10VDC or 0-20ma or a 4-20mA signal connected to terminal block -XTBC1 terminals A- and A+. The corresponding type of signal must be set under the OPTION key. Once an input change is registered the input signal is not read again for 5 minutes.

If enabled this feature will work even when the Option Local/Remote mode is set to Local. This input is not available if a remote communications device is connected, Option Local/Remote is set to remote and remote communications device is not handing back control to the panel.

**Cooling Mode**

In the cooling mode the chilled liquid setpoint can be reset upwards from the manually entered setpoint by using a remote 0 - 10VDC or 2-10VDC or 0-20ma or a 4-20mA signal connected to terminal block -XTBC1 terminals A- and A+. This is the same signal as used to reset the heating setpoint in the heating mode. Whenever a reset is called for by the remote signal, the change may be viewed by pressing the Setpoints key three times. The new value will be displayed as "REM C SP = XXX °C."



**0-10VDC Remote Signal**

Jumper JP on the I/O board must be set to 10V.

To calculate the reset chilled liquid setpoint for values between 0VDC and 10VDC use the following formula:

$$\text{Setpoint} = \text{Local Chilled Liquid Setpoint} + \text{°Reset}$$

$$\text{°Reset} = ((\text{DC voltage signal}) \times (\text{*Max Reset Value}))/10$$

Example:

$$\text{Local Chilled Liquid Setpoint} = 6.4 \text{ °C}$$

$$\text{*Max Reset Value} = 10 \text{ °C}$$

$$\text{Input Signal} = 6\text{VDC}$$

$$\text{°Reset} = (6\text{VDC} \times 10.0 \text{ °C})/10 = 6.0 \text{ °C}$$

$$\text{New Setpoint} = 6.4 \text{ °C} + 6.0 \text{ °C} = 12.4 \text{ °C}$$

**2-10VDC Remote Signal**

Jumper JP on the I/O board must be set to 10V.

To calculate the reset chilled liquid setpoint for values between 2VDC and 10VDC use the following formula:

$$\text{Setpoint} = \text{Local Chilled Liquid Setpoint} + \text{°Reset}$$

$$\text{°Reset} = ((\text{DC voltage signal} - 2) \times (\text{*Max Reset Value}))/8$$

Example:

$$\text{Local Chilled Liquid Setpoint} = 6.4 \text{ °C}$$

$$\text{*Max Reset Value} = 10 \text{ °C}$$

$$\text{Input Signal} = 6\text{VDC}$$

$$\text{°Reset} = ((6\text{VDC} - 2) \times 10.0 \text{ °C})/8 = 5 \text{ °C}$$

$$\text{New Setpoint} = 6.9 \text{ °C} + 5 \text{ °C} = 11.9 \text{ °C}$$

**0-20mA Remote Signal**

Jumper JP on the I/O board must be set to 20mA.

To calculate the chilled liquid setpoint for values between 0mA and 20 mA use the following formula:

$$\text{Setpoint} = \text{Local Chilled Liquid Setpoint} + \text{°Reset}$$

$$\text{°Reset} = (\text{mA signal} \times \text{*Max Reset Value})/20$$

Example:

$$\text{Local Chilled Liquid Setpoint} = 6.4 \text{ °C}$$

$$\text{*Max Reset Value} = 5.0 \text{ °C}$$

$$\text{Input Signal} = 10 \text{ mA}$$

$$\text{°Reset} = (10\text{mA} \times 5.0 \text{ °C})/20 = 2.5 \text{ °C}$$

$$\text{New Setpoint} = 6.4 \text{ °C} + 2.5 \text{ °C} = 8.9 \text{ °C}$$

**4-20mA Remote Signal**

Jumper JP on the I/O board must be set to 20mA.

To calculate the chilled liquid setpoint for values between 4mA and 20 mA use the following formula:

$$\text{Setpoint} = \text{Local Chilled Liquid Setpoint} + \text{°Reset}$$

$$\text{°Reset} = ((\text{mA signal} - 4) \times (\text{*Max Reset Value}))/16$$

Example:

$$\text{Local Chilled Liquid Setpoint} = 6.4 \text{ °C}$$

$$\text{*Max Reset Value} = 6.0 \text{ °C}$$

$$\text{Input Signal} = 8 \text{ mA}$$

$$\text{°Reset} = ((8\text{mA} - 4\text{mA}) \times 6.0 \text{ °C})/16 = 1.5 \text{ °C Reset}$$

$$\text{Setpoint} = 6.4 \text{ °C} + 1.5 \text{ °C} = 7.9 \text{ °C}$$

\* Max Reset Value - Pressing the 'SETPOINTS' key a fifth time will allow the maximum remote EMS-PWM cooling temperature reset to be programmed: Programmable values are from 1.11 °C to 11.11°C.

---

```
MAX EMS-PWM REM C
TEMP RESET = +XX °C
```

---

This value is also used to set the maximum reset to the cooling setpoint that corresponds to the maximum analogue input (10V or 20ma).

**Heating Mode**

In the heating mode the hot liquid setpoint can be reset downwards from the manually entered setpoint by using a remote 0 - 10VDC or 2-10VDC or 0-20ma or a 4-20mA signal connected to terminal block -XTBC1 terminals A- and A+. This is the same signal as used to reset the cooling setpoint in the cooling mode. Whenever a reset is called for by the remote signal, the change may be viewed by pressing the Setpoints key four times. The new value will be displayed as "REM H SP = XXX °C."

**0-10VDC Remote Signal**

Jumper JP on the I/O board must be set to 10V.

To calculate the reset hot liquid setpoint for values between 0VDC and 10VDC use the following formula:

$$\text{Setpoint} = \text{Local Hot Liquid Setpoint} - \text{°Reset}$$

$$\text{°Reset} = ((\text{DC voltage signal}) \times (\text{*Max Reset Value}))/10$$

**Example:**

Local Hot Liquid Setpoint = 50 °C

\*Max Reset Value = 10 °C

Input Signal = 6VDC

 $^{\circ}\text{Reset} = (6\text{VDC} \times 10.0 \text{ }^{\circ}\text{C})/10 = 6.0 \text{ }^{\circ}\text{C}$ 

New Setpoint = 50.0 °C - 6.0 °C = 44.0 °C

**2-10VDC Remote Signal**

Jumper JP on the I/O board must be set to 10V.

To calculate the reset Hot liquid setpoint for values between 2VDC and 10VDC use the following formula:

Setpoint = Local Hot Liquid Setpoint - °Reset

 $^{\circ}\text{Reset} = ((\text{DC voltage signal} - 2) \times (*\text{Max Reset Value}))/8$ **Example:**

Local Hot Liquid Setpoint = 50 °C

\*Max Reset Value = 10 °C

Input Signal = 6VDC

 $^{\circ}\text{Reset} = ((6\text{VDC} - 2) \times 10.0 \text{ }^{\circ}\text{C})/8 = 5 \text{ }^{\circ}\text{C}$ 

New Setpoint = 50.0 °C - 5.0 °C = 45.0 °C

**0-20mA Remote Signal**

Jumper JP on the I/O board must be set to 20mA.

To calculate the chilled liquid setpoint for values between 0mA and 20 mA use the following formula:

Setpoint = Local Hot Liquid Setpoint - °Reset

 $^{\circ}\text{Reset} = (\text{mA signal} \times *\text{Max Reset Value})/20$ **Example:**

Local Hot Liquid Setpoint = 50 °C

\*Max Reset Value = 5.0 °C

Input Signal = 10 mA

 $^{\circ}\text{Reset} = (10\text{mA} \times 5.0 \text{ }^{\circ}\text{C})/20 = 2.5 \text{ }^{\circ}\text{C}$ 

New Setpoint = 50.0 °C - 2.5 °C = 47.5 °C

**4-20mA Remote Signal**

Jumper JP on the I/O board must be set to 20mA.

To calculate the chilled liquid setpoint for values between 4mA and 20mA use the following formula:

Setpoint = Local Hot Liquid Setpoint - °Reset

 $^{\circ}\text{Reset} = ((\text{mA signal} - 4) \times (*\text{Max Reset Value}))/16$ **Example:**

\*Max Reset Value = 6.0 °C

Input Signal = 8 mA

 $^{\circ}\text{Reset} = ((8\text{mA} - 4\text{mA}) \times 6.0 \text{ }^{\circ}\text{C})/16 = 1.5 \text{ }^{\circ}\text{C}$  Reset

Setpoint = 50.0 °C - 1.5 °C = 48.5 °C

\* Max Reset Value - Pressing the 'SETPOINTS' key a sixth time will allow the maximum remote EMS-PWM heating temperature reset to be programmed: Programmable values are from 1.11 °C to 11.11°C.

---

MAX EMS-PWM REM H
TEMP RESET = +XX °C

---

This value is also used to set the maximum reset to the heating setpoint that corresponds to the maximum analogue input (10V or 20mA).

**EMS PWM Remote Setpoint Reset**

The EMS-PWM feature is not normally available. If the message REMOTE TEMP RESET INPUT (being the analogue input) is visible under the OPTION key even when set to DISABLED the EMS-PWM feature is disabled. Contact Johnson Controls York product service if you require this feature. If enabled this feature will work even when the Option Local/Remote mode is set to Local. This input is not available if a remote communications device is connected, Option Local/Remote is set to remote and remote communications device is not handing back control to the panel.

The leaving liquid temperature setpoint programmed into the microprocessor can be remotely adjusted to a higher value cooling or a lower value heating using repeated timed closure of voltage free contacts (terminals 13 & 20) on -XTBC1. The duration of the contact closure will decide the amount of adjustment.

For noise immunity, the microprocessor will ignore closures of less than 1 second.

The setpoint can also be reset by a remote 0-10Vdc, 2-10Vdc, 0-20ma dc or 4-20ma dc signal connected to terminals A+ and A- on -XTBC1

**EMS-PWM Cooling Temperature Reset**

Pressing the 'SETPOINTS' a fifth time will allow the maximum remote EMS-PWM cooling temperature reset to be programmed:

---

MAX EMS-PWM REM C  
TEMP RESET = +XX °C

---

The temperature reset value is the maximum allowable reset of the cooling temperature 'SETPOINT'. The 'SETPOINT' can be reset upwards by the use of a timed contact closure on the PWM input (-XTBC1 terminals 13 - 20).

Pressing the 'UP ARROW' or 'DOWN ARROW' will change the temperature reset value in 1.0°C increments. The 'ENTER/ADV' key must be pressed to enter the value into memory.

**EMS-PWM Heating Temperature Reset**

Pressing the 'SETPOINTS' a sixth time will allow the maximum remote EMS-PWM heating temperature reset to be programmed:

---

MAX EMS-PWM REM H  
TEMP RESET = +XX °C

---

The temperature reset value is the maximum allowable reset of the heating temperature 'SETPOINT'. The 'SETPOINT' can be reset downwards by the use of a timed contact closure on the PWM input (-XTBC1 terminals 13 - 20). Activated on request.

Pressing the 'UP ARROW' or 'DOWN ARROW' will change the temperature reset value in 1.0°C increments. The 'ENTER/ADV' key must be pressed to enter the value into memory.

---

LAST RUN TIME =XXX S  
SETP ADJUST= XX. X °C

---

Pressing the 'SETPOINTS' a seventh time will display the lead system's last run time and the setpoint adjust value. See Capacity Control Section.

**EMS-PWM Remote Temperature Reset**

The EMS-PWM remote temperature reset value at terminals 13 - 20 on -XTBC1, will reset the cooling or heating liquid 'SETPOINT' based on the length of time the contacts remain closed. The maximum temperature reset allowed is achieved with a contact closure of 11 seconds. One second is the shortest time allowed and causes the liquid 'SETPOINT' to revert back to the local programmed value.

In the cooling mode the reset value is always added to the cooling liquid 'SETPOINT', meaning that this function never lowers the cooling liquid 'SETPOINT' below the locally programmed value, it can only reset to a higher value.

In the heating mode the reset value is always subtracted from the heating liquid 'SETPOINT', meaning that this function never raises the heating liquid 'SETPOINT' above the locally programmed value, it can only reset to a lower value.

The microprocessor board must be refreshed between 30 seconds and 30 minutes. Any contact closure occurring sooner than 30 seconds will be ignored. If more than 30 minutes elapse before the next contact closure, the setpoint will revert back to the locally programmed value.

The new chilled liquid 'SETPOINT' is calculated:

**Cooling Mode**

Setpoint = Local Chilled Liquid Setpoint + °Reset

°Reset = ((Contact Closure - 1) x (\*Max. Reset Value))/10

**Example:**

Local Chilled Liquid Setpoint = 6.4 °C

\*Max Reset Value = 10 °C

Input Signal = 6VDC

Contact Closure Time = 6 seconds.

°Reset = (6 sec - 1) \* 10.0°C/10 = 5.0°C

New Setpoint = 6.4°C + 5.0°C = 11.4°C

**Heating Mode**

Setpoint = Local Hot Liquid Setpoint - °Reset

°Reset = ((Contact Closure - 1) x (\*Max. Reset Value))/10

**Example:**

Local Hot Liquid Setpoint = 50 °C

\*Max Reset Value = 5.0 °C

Contact Closure Time = 4 Seconds

°Reset = (4 sec - 1) \* 5°C/10 = 1.5°C

New Setpoint = 50.0°C - 1.5°C = 48.5 °C

The 'SETPOINTS' key should be pressed three times to view the remote cooling 'SETPOINT' and 'RANGE':

---

REM C SP = XX. X °C  
RANGE = +/- X. X °C

---

The 'SETPOINTS' key should be pressed four times to view the remote heating 'SETPOINT' and 'RANGE':

---

REM H SP = XXX. X °C  
RANGE = +/- X. X °C

---

## ISN Control (York Talk -AMB terminal block TB1)



If communications cannot be established check that the panel has been set up for York Talk. Press the Program key, followed by four presses on the down arrow key, followed by the Enter key. The DE MODIFIER ADDRESS must be set to minus one. Use the Enter and down arrow keys to set the value. Repeatedly press the Enter key until the REAL TIME ERROR is displayed. Reset it if not zero. Now turn the power to the panel off then turn back on. Note on power up the second line of the display should read INITIALIZING not INITIALIZING BACNET.

### Received Data (Control Data)

The unit receives 8 data values from the ISN. The first 4 (ISN Page P03 to P06) are analog values and the last 4 (ISN Page P07 to P10, 2 unused) are digital values. These 6 data values are used as control parameters when in REMOTE mode. When the unit is in LOCAL mode, these 6 values are ignored. If the unit receives no valid ISN transmission for 5 minutes it will revert back local control values. The table below lists the 6 used control parameters. These values are found under feature 54 on the ISN.

ISN PAGE	CONTROL DATA
P03	COOLING SETPOINT (99 = UNIT SETPOINT)
P04	LOAD LIMIT STAGES (0, 1, 2)
P05	HEATING SETPOINT (999 = UNIT SETPOINT)
P06	MODE (0 = UNIT, 1 = COOLING, 2 = HEATING)
P07	START/STOP COMMAND
P10	HISTORY BUFFER REQUEST

### Transmitted Data

After receiving a valid transmission from the ISN, the unit will transmit either operational data or history buffer data depending on the status of the 'History Buffer Request' (ISN Page 10). Data must be transmitted for every ISN Page under feature 54. If there is no value to be sent to a particular page, a zero will be sent.

The tables below show the data values and Page listings for the unit.

ISN PAGE	TYPE	DATA
P11	ANALOG	LEAVING LIQUID TEMP.
P16	ANALOG	AMBIENT AIR TEMP.
P18	ANALOG	SYS 1 RUN TIME (SECONDS)
P19	ANALOG	SYS 1 SUCTION PRESSURE
P20	ANALOG	SYS 1 DISCHARGE PRESSURE
P22	ANALOG	SYS 1 AMBIENT COIL DEFROST TEMP.
P24	ANALOG	SYS 1 ANTI-RECYCLE TIMER
P25	ANALOG	ANTI-COINCIDENT TIMER
P27	ANALOG	SYS 2 RUN TIME (SECONDS)
P28	ANALOG	SYS 2 SUCTION PRESSURE
P29	ANALOG	SYS 2 DISCHARGE PRESSURE
P31	ANALOG	SYS 2 AMBIENT COIL DEFROST TEMP.
P33	ANALOG	SYS 2 ANTI-RECYCLE TIMER
P35	ANALOG	NUMBER OF COMPRESSORS
P36	DIGITAL	SYS 1 ALARM
P37	DIGITAL	SYS 2 ALARM
P38	DIGITAL	HEAT EXCH. HEATER STATUS
P39	DIGITAL	WATER PUMP STATUS
P40	DIGITAL	SYS 1 COMP 1 RUN
P41	DIGITAL	SYS 2 COMP 1 RUN
P42	DIGITAL	SYS 1 MODE SOLENOID VALVE
P43	DIGITAL	DRIP TRAY HEATER STATUS
P44	DIGITAL	SYS 1 COMP 2 RUN
P45	DIGITAL	SYS 2 COMP 2 RUN
P46	DIGITAL	SYS 2 MODE SOLENOID VALVE
P47	DIGITAL	LEAD SYSTEM (0=SYS 1, 1 = SYS 2)
P48	DIGITAL	SYS 1 COMP 3 RUN
P49	DIGITAL	SYS 2 COMP 3 RUN
P50	DIGITAL	CHILLED LIQUID TYPE (0=WATER, 1=GLYCOL)
P52	DIGITAL	LOCAL / REMOTE CONTROL MODE (0=LOCAL, 1=REMOTE)
P53	DIGITAL	UNITS (0=IMPERIAL, 1=SI)
P54	DIGITAL	LEAD/LAG CONTROL MODE (0=MANUAL, 1=AUTO)
P56	CODED	*SYS 1 OPERATIONAL CODE
P57	CODED	*SYS 1 FAULT CODE
P58	CODED	*SYS 2 OPERATIONAL CODE
P59	CODED	*SYS 2 FAULT CODE
P61	CODED	**SYS 1 COND FANS RUNNING
P63	CODED	**SYS 2 COND FANS RUNNING
P65	ANALOG	UNIT CONTROL MODE 4 = COOLING 5 = HEATING
P66	ANALOG	ANTI-RECYCLE TIME (PROGRAMMED)
P67	ANALOG	LEAVING CHILLED LIQUID TEMP CUTOUT
P68	ANALOG	LOW AMBIENT TEMP CUTOUT
P69	ANALOG	LOW SUCTION PRESS CUTOUT HEATING
P70	ANALOG	LOW SUCTION PRESS CUTOUT COOLING
P71	ANALOG	HIGH DISCHARGE PRESS CUTOUT
P72	ANALOG	REMOTE COOLING SETPOINT
P73	ANALOG	COOLING RANGE
P74	ANALOG	REMOTE HEATING SETPOINT
P75	ANALOG	HEATING RANGE

\* See ISN Operational and Fault code table below.

\*\* For interpretation of fan stages see tables in Ambient Fan Coil Control Section

P56/58	OPERATIONAL CODE
0	NO ABNORMAL CONDITION
1	UNIT SWITCH OFF
2	SYSTEM SWITCH OFF
3	LOCK-OUT
4	UNIT FAULT
5	SYSTEM FAULT
6	REMOTE SHUTDOWN
7	DAILY SCHEDULE SHUTDOWN
8	NO RUN PERMISSIVE
9	NO LOAD
10	ANTI-COINCIDENCE TIMER ACTIVE
11	ANTI-RECYCLE TIMER ACTIVE
12	MANUAL OVERRIDE
13	SUCTION LIMITING
14	DISCHARGE LIMITING
16	LOAD LIMITING
17	COMPRESSOR(S) RUNNING
18	HEATPUMP MAX LOAD LIMITING
P57/59	FAULT CODE
0	NO FAULT
1	VAC UNDERVOLTAGE
2	LOW AMBIENT TEMPERATURE
4	LOW LEAVING CHILLED LIQUID TEMP
5	HIGH DISCHARGE PRESSURE
7	LOW SUCTION PRESSURE
18	MP /HPCO FAULT
25	DISCHARGE INHIBIT
26	MP /HPCO INHIBIT
27	H K - UNIT FAULT PUMP TRIP (BOTH TRIPPED ON 2 PUMP OPTION)
28	H K - UNIT FAULT PUMP FAIL MAKE FLOW
29	HIGN AMBIENT TEMPERATURE

H K = Hydro Kit Option

### BACnet, Modbus and N2 (-AMB Board Terminal Block)

Data can be read and in some cases modified using a serial communication BACnet or Modbus or N2 network connection. This information allows communications of unit operating parameters and external control changes to setpoint, load limiting, and start/stop commands.

#### BACnet Modbus and N2 Data Communication

In some cases, parameters may need to be modified [port P1 BACnet or N2 (RS485 TB1) and or Modbus port P2 (RS485 TB2, P2 HW select bit set to RS-485)].

If communications cannot be established check that the panel has been setting up for the correct communication protocol. Setting the DE MODIFIER ADDRESS to minus one, sets the RS485 port TB1 up for York Talk. For protocols other than York Talk set the correct parameters then turn the power to the panel off then back on.



On power up the second line of the display should read INITIALIZING BACNET. For Bacnet P1 Protocol must be set to Bacnet, for N2 P1 Protocol must be set to N2 and for Modbus P2 Protocol must be set to MODBUS SRV.



If the DISPLAY UNIT setting under the OPTION key is changed with a Remote Device connected, the power to the unit must be switch OFF and ON again. Failure to do this may result in erroneous data being transmitted.

Modification is accomplished by pressing the PROGRAM, DOWN ARROW, DOWN ARROW, DOWN ARROW, DOWN ARROW, and ENTER keys in sequence. The list below shows the displays for the values that may be modified.

DE MODIFIER ADDRESS  
XXXXXX

DE MODIFIER OFFSET  
XX

P1 PROTOCOL  
XXXXXX

P1 MANUAL MAC  
ADDRESS XXX

P1 BAUD RATE  
XXXXX

P1 PARITY  
XXXXX

P1 STOP BITS  
X

P2 PROTOCOL  
XXXXXXXXXX

P2 MANUAL MAC  
ADDRESS XXX

P2 BAUD RATE  
XXXXX

P2 PARITY  
XXXXX

P2 STOP BITS  
X

P2 HW SELECT BIT  
XXXXXX

XXXXXX = RS-232 or RS-485

REAL TIME ERROR ##  
RESET 1 = YES, 0 = NO 0

**IPU II Port Settings**

With unit switch set to OFF press PROGRAM, DOWN ARROW, DOWN ARROW, DOWN ARROW, DOWN ARROW, ENTER keys in turn and then set the following:

	YORK TALK TB1 (PORT 1)	BACNET TB1 (PORT 1)	MODBUS TB2 (PORT 2)	N2 TB1 (PORT 1)
DE MODIFIER ADDRESS	-1	AS REQUIRED NOT -1	DONT CARE NOT -1	AS REQUIRED NOT -1
DE MODIFIER OFFSET	DONT CARE	AS REQUIRED	DONT CARE	AS REQUIRED
P1 PROTOCOL	DONT CARE	BACNET	DONT CARE	N2
P1 MANUAL MAC ADDRESS	DONT CARE	AS REQUIRED	DONT CARE	AS REQUIRED
P1 BAUD RATE	DONT CARE	AS REQUIRED	DONT CARE	AS REQUIRED
P1 PARITY	DONT CARE	AS REQUIRED	DONT CARE	AS REQUIRED
P1 STOP BITS	DONT CARE	AS REQUIRED	DONT CARE	AS REQUIRED
P2 PROTOCOL	DONT CARE	DONT CARE	MODBUS SVR	DONT CARE
P2 MANUAL MAC ADDRESS	DONT CARE	DONT CARE	AS REQUIRED	DONT CARE
P2 BAUD RATE	DONT CARE	DONT CARE	AS REQUIRED	DONT CARE
P2 PARITY	DONT CARE	DONT CARE	AS REQUIRED	DONT CARE
P2 STOP BITS	DONT CARE	DONT CARE	AS REQUIRED	DONT CARE
P2 HW SELECT	DONT CARE	DONT CARE	RS485	DONT CARE
Reset any real time errors				

After making settings cycle power. Check the second line of the display on power up. For York Talk Bacnet (Modbus, N2) will NOT be initialized, for Bacnet (Modbus, N2) Bacnet will be initialised.

The table below shows the minimum, maximum and default values:

DESCRIPTION	MINIMUM	MAXIMUM	DEFAULT
De Modifier Address	-1	41943	-1
De Modifier Offset	-1	99	-1
P1 Protocol	BACNET	API	BACNET
	BACNET, API, N2 Selectable		
P1 Manual Mac Address	0	127	1
P1 Baud Rate	1200	76800	4800
	1200, 4800, 9600, 19200, 38400, 57600, 76800 AUTO Selectable		
P1 Parity	None	Ignore	None
	None, Even, Odd, Ignore Selectable		
P1 Stop Bits	1	2	1
P2 Protocol	Terminal	Modbus Client	API
	TERMINAL, UNAVAIL, MODBUS IO, MODBUS SERVER, API, MODBUS CLIENT Selectable		
P2 Manual Mac Address	0	127	1
P2 Baud Rate	1200	76800	1200
	1200, 4800, 9600, 19200, 38400, 57600, 76800 Selectable		
P2 Parity	None	Ignore	None
	None, Even, Odd, Ignore Selectable		
P2 Stop Bits	1	2	1
P2 HW Select Bit	RS232	RS485	RS232
Reset Real Time Error	NO	YES	None

The table below details the real time error numbers and a description of each error:

ERROR NUMBER (##)	DESCRIPTION
0	ALL OK
1	DATUM TYPE OK TEST FAILED
2	ENGLISH TEXT TOO LONG
3	FLOATING POINT EXCEPTION
4	GET PACKET FAILED
5	GET TYPE FAILED
6	INVALID UNIT CONVERSION
7	INVALID HARDWARE SELECTION
8	REAL TIME FAULT
9	SPANISH TEXT TOO LONG
10	THREAD EXITED
11	THREAD FAILED
12	THREAD STALLED
13	IO BOARD RESET
14	BRAM INVALID
15	BACNET SETUP FAILED

Unit data that can be read and modified using specific Register Addresses; and the data associated with the addresses, is outlined in the following description:

#### Serial Communication Analog Value Data

This data can be read and modified using a BACnet or Modbus network connection. The Modbus Register Address for these points is 1025 + AV #.

AV	BACNET NAME	ANALOG VALUE DESCRIPTION
1	REM_SETP	SETPOINT COOLING SETPOINT WATER 4.4 °C TO 21.1°C GLYCOL -7.2°C TO 21.1°C LOW TEMP GLYCOL -13.3°C TO 21.1°C 37.2 = Handback to panel when under options display units are set to SI or 99 when set to imperial
2	SP_REM_SP_S1	NOT USED
3	LOAD_LIMIT LOAD LIMIT STAGE	(0, 1, 2)
4	REM_CR COOLING RANGE	NOT USED
5	SP_REM_SP_S2	NOT USED
6	REM_SP_HEAT	HEATING SETPOINT 35 °C - 50°C 537.2 = Handback to panel when under options display units are set to SI or 999 when set to imperial
7	HP_MODE	MODE (0 = PANEL, 1 = COOLING, 2 = HEATING)

#### Serial Communication Binary Value Data

This data can be read and modified using a BACnet or Modbus network connection. The Modbus Register Address for these points is 1537 + BV #.

BV	BACNET	NAME BINARY VALUE DESCRIPTION
1	START_STOP	START / STOP COMMAND

## Serial Communication Analog Input Data

This data can be read using a BACnet or Modbus network connection and can NOT be modified using this connection. The Modbus Register Address for these points is 513 + AI #

AI	BACNET NAME	ANALOG INPUT DESCRIPTION
1	LCHLT	LEAVING LIQUID TEMP
2	RCHLT	NOT USED
3	DAT	NOT USED
4	S1_SUCT_TEMP	NOT USED
5	OAT	AMBIENT AIR TEMPERATURE
6	S1_SUCT_SH	NOT USED
7	S1_RUN_TIME	SYS 1 RUN TIME (SECONDS)
8	S1_SUCT_PR	SYS 1 SUCTION PRESSURE
9	S1_DSCH_PR	SYS 1 DISCHARGE PRESSURE
10	S1_CIR_TEMP	NOT USED
11	S1_DEF_TEMP	SYS 1 DEFROST TEMPERATURE
12	S1_EEV_OUT	NOT USED
13	S1_AR_TIMER	SYS 1 ANTI-RECYCLE TIMER
14	AC_TIMER	ANTI-COINCIDENT TIMER
15	S2_SUCT_TEMP	NOT USED
16	S2_RUN_TIME	SYS 2 RUN TIME (SECONDS)
17	S2_SUCT_PR	SYS 2 SUCTION PRESSURE
18	S2_DSCH_PR	SYS 2 DISCHARGE PRESSURE
19	S2_CIR_TEMP	NOT USED
20	S2_DEF_TEMP	SYS 2 DEFROST TEMPERATURE
21	S2_SUCT_SH	NOT USED
22	S2_AR_TIMER	SYS 2 ANTI-RECYCLE TIMER
23	S2_EEV_OUT	NOT USED
24	NUM_COMPS	NUMBER OF COMPRESSORS
25	S1_OP_CODE	*SYS 1 OPERATIONAL CODE
26	S1_FLT_CODE	*SYS 1 FAULT CODE
27	S2_OP_CODE	*SYS 2 OPERATIONAL CODE
28	S2_FLT_CODE	*SYS 2 FAULT CODE
29	S1_DBG_CODE	NOT USED
30	S1_FAN_STAGE	**SYS 1 CONDENSER FAN STAGE
31	S2_DBG_CODE	NOT USED
32	S2_FAN_STAGE	**SYS 2 CONDENSER FAN STAGE
33	CONTROL_MODE	UNIT CONTROL MODE (5=COOLING, 6=HEATING)
34	AR_TIME	ANTI-RECYCLE TIME (PROGRAMMED)
35	LCHLT_CUT	LEAVING CHILLED LIQUID TEMP CUTOUT
36	LOW_AMB_CUT	LOW AMBIENT TEMPERATURE CUTOUT
37	SUCT_P_CO_HT	LOW SUCTION PRESSURE CUTOUT HEATING
38	L_SUCT_P_CO	LOW SUCTION PRESSURE CUTOUT
39	H_DSCH_P_CO	HIGH DISCHARGE PRESSURE CUTOUT
40	COOL_SETP	COOLING SET POINT
41	SP_SETP_S1	NOT USED
42	CONTROL_RG	COOLING RANGE
43	SP_CTL_RG_S1	NOT USED
44	SP_SETP_S2	NOT USED
45	HEAT_SETP	HEATING SETPOINT
46	SP_CTL_RG_S2	NOT USED
47	HEAT_RANGE	HEATING RANGE
48	S1_DSCH_TEMP	NOT USED
49	S1_DSCH_SH	NOT USED
50	S2_DSCH_TEMP	NOT USED
51	S2_DSCH_SH	NOT USED
52	LEAVING_HOT	NOT USED
53	RETURN_HOT	NOT USED
54	R_COOL_SETP	REMOTE SETPOINT COOLING
55	R_SP_SETP_S1	NOT USED
56	R_SP_SETP_S2	NOT USED
57	R_HEAT_SETP	REMOTE SETPOINT HEATING

\* See ISN Operational and Fault Code table

\*\* For interpretation of fan stages see tables in Ambient Fan Control Section



### Serial Communication Binary Value Data

This data can be read using a BACnet or Modbus network connection and can NOT be modified using this connection. The Modbus Register Address for these points is 1281 + BI #.

BI	BACnet NAME	BINARY INPUT DESCRIPTION
1	S1_ALARM	SYS 1 ALARM
2	S2_ALARM	SYS 2 ALARM
3	EVAP_HTR	EVAPORATOR HEATER STATUS
4	EVAP_PUMP	EVAPORATOR PUMP STATUS
5	S1_C1_RUN	SYS 1 COMP 1 RUN
6	S2_C1_RUN	SYS 2 COMP 1 RUN
7	S1_LLSV	NOT USED
8	S1_MODE_SV	SYS 1 MODE SOLENOID VALVE
9	S1_HGBV	NOT USED
10	S1_BHS	DEFROST TRAY HEATER
11	S1_C2_RUN	SYS 1 COMP 2 RUN
12	S2_C2_RUN	SYS 2 COMP 2 RUN
13	S2_LLSV Sys 2	NO USED
14	S2_MODE_SV	SYS 2 MODE SOLENOID VALVE
15	LEAD_SYS	LEAD SYSTEM (0 = SYS 1, 1 = SYS 2)
16	S1_C3_RUN	SYS 1 COMP 3 RUN
17	S2_C3_RUN	SYS 2 COMP 3 RUN
18	CH_LIQ_TYPE	CHILLED LIQUID TYPE (0=WATER, 1=GLYCOL)
19	AMB_MODE	NOT USED
20	CNTL_MODE	LOCAL/REMOTE CONTROL MODE (0=LOCAL, 1=REMOTE)
21	DATA_UNIT	UNITS (0=IMPERIAL, 1=SI)
22	AUTO_LL	LEAD/LAG CONTROL MODE (0=MANUAL, 1=AUTO)
23	S2_HGSV	NOT USED

### Serial Communication Analog Value Data

This data can be read and where used up to ADF 7 modified using a N2 network connection.

ADF	NAME	ANALOG VALUE DESCRIPTION
1	REM_SETP	SETPOINT COOLING SETPOINT WATER 4.4 °C TO 21.1°C GLYCOL -7.2°C TO 21.1°C LOW TEMP GLYCOL -13.3°C TO 21.1°C 37.2 = Handback to panel when under options display units are set to SI or 99 when set to imperial
2	SP_REM_SP_S1	NOT USED
3	LOAD_LIMIT	(0, 1, 2)
4	REM_CR	NOT USED
5	SP_REM_SP_S2	NOT USED
6	REM_SP_HEAT	HEATING SETPOINT 35 °C - 50°C 537.2 = Handback to panel when under options display units are set to SI or 999 when set to imperial
7	HP_MODE	MODE (0 = PANEL, 1 = COOLING, 2 = HEATING)
8	LCHLT	LEAVING LIQUID TEMP
9	RCHLT	NOT USED
10	DAT	NOT USED

ADF	NAME	ANALOG VALUE DESCRIPTION
11	S1_SUCT_TEMP	NOT USED
12	OAT	AMBIENT AIR TEMPERATURE
13	S1_SUCT_SH	NOT USED
14	S1_RUN_TIME	SYS 1 RUN TIME (SECONDS)
15	S1_SUCT_PR	SYS 1 SUCTION PRESSURE
16	S1_DSCH_PR	SYS 1 DISCHARGE PRESSURE
17	S1_CIR_TEMP	NOT USED
18	S1_DEF_TEMP	SYS 1 DEFROST TEMPERATURE
19	S1_EEV_OUT	NOT USED
20	S1_AR_TIMER	SYS 1 ANTI-RECYCLE TIMER
21	AC_TIMER	ANTI-COINCIDENT TIMER
22	S2_SUCT_TEMP	NOT USED
23	S2_RUN_TIME	SYS 2 RUN TIME (SECONDS)
24	S2_SUCT_PR	SYS 2 SUCTION PRESSURE
25	S2_DSCH_PR	SYS 2 DISCHARGE PRESSURE
26	S2_CIR_TEMP	NOT USED
27	S2_DEF_TEMP	SYS 2 DEFROST TEMPERATURE
28	S2_SUCT_SH	NOT USED
29	S2_AR_TIMER	SYS 2 ANTI-RECYCLE TIMER
30	S2_EEV_OUT	NOT USED
31	NUM_COMPS	NUMBER OF COMPRESSORS
32	S1_OP_CODE	*SYS 1 OPERATIONAL CODE
33	S1_FLT_CODE	*SYS 1 FAULT CODE
34	S2_OP_CODE	*SYS 2 OPERATIONAL CODE
35	S2_FLT_CODE	*SYS 2 FAULT CODE
36	S1_DBG_CODE	NOT USED
37	S1_FAN_STAGE	**SYS 1 CONDENSER FAN STAGE
38	S2_DBG_CODE	NOT USED
39	S2_FAN_STAGE	**SYS 2 CONDENSER FAN STAGE
40	CONTROL_MODE	UNIT CONTROL MODE (5=COOLING, 6=HEATING)
41	AR_TIME	ANTI-RECYCLE TIME (PROGRAMMED)
42	LCHLT_CUT	LEAVING CHILLED LIQUID TEMP CUTOUT
43	LOW_AMB_CUT	LOW AMBIENT TEMPERATURE CUTOUT
44	SUCT_P_CO_HT	LOW SUCTION PRESSURE CUTOUT HEATING
45	L_SUCT_P_CO	LOW SUCTION PRESSURE CUTOUT
46	H_DSCH_P_CO	HIGH DISCHARGE PRESSURE CUTOUT
47	COOL_SETP	COOLING SET POINT
48	SP_SETP_S1	NOT USED
49	CONTROL_RG	COOLING RANGE
50	SP_CTL_RG_S1	NOT USED
51	SP_SETP_S2	NOT USED
52	HEAT_SETP	HEATING SETPOINT
53	SP_CTL_RG_S2	NOT USED
54	HEAT_RANGE	HEATING RANGE
55	S1_DSCH_TEMP	NOT USED
56	S1_DSCH_SH	NOT USED
57	S2_DSCH_TEMP	NOT USED
58	S2_DSCH_SH	NOT USED
59	LEAVING_HOT	NOT USED
60	RETURN_HOT	NOT USED
61	R_COOL_SETP	REMOTE SETPOINT COOLING
62	R_SP_SETP_S1	NOT USED
63	R_SP_SETP_S2	NOT USED
64	R_HEAT_SETP	REMOTE SETPOINT HEATING

\* See ISN Operational and Fault Code table

\*\* For interpretation of fan stages see tables in Ambient Fan Control Section

### Serial Communication Binary Value Data

This data can be read and DB 1 modified using a N2 network connection.

BD	NAME	DESCRIPTION
1	START_STOP	START / STOP COMMAND
2	SS_SYS1	NOT USED
3	SS_SYS2	NOT USED
4	S1_ALARM	SYS 1 ALARM
5	S2_ALARM	SYS 2 ALARM
6	EVAP_HTR	EVAPORATOR HEATER STATUS
7	EVAP_PUMP	EVAPORATOR PUMP STATUS
8	S1_C1_RUN	SYS 1 COMP 1 RUN
9	S2_C1_RUN	SYS 2 COMP 1 RUN
10	S1_LLSV	NOT USED
11	S1_MODE_SV	SYS 1 MODE SOLENOID VALVE
12	S1_HGBV	NOT USED
13	S1_BHS	DEFROST TRAY HEATER
14	S1_C2_RUN	SYS 1 COMP 2 RUN
15	S2_C2_RUN	SYS 2 COMP 2 RUN
16	S2_LLSV Sys 2	NO USED
17	S2_MODE_SV	SYS 2 MODE SOLENOID VALVE
18	LEAD_SYS	LEAD SYSTEM (0 = SYS 1, 1 = SYS 2)
19	S1_C3_RUN	SYS 1 COMP 3 RUN
20	S2_C3_RUN	SYS 2 COMP 3 RUN
21	CH_LIQ_TYPE	CHILLED LIQUID TYPE (0=WATER, 1=GLYCOL)
22	AMB_MODE	NOT USED
23	CNTL_MODE	LOCAL/REMOTE CONTROL MODE (0=LOCAL, 1=REMOTE)
24	DATA_UNIT	UNITS (0=IMPERIAL, 1=SI)
25	AUTO_LL	LEAD/LAG CONTROL MODE (0=MANUAL, 1=AUTO)
26	S2_HGSV	NOT USED



[www.johnsoncontrols.com](http://www.johnsoncontrols.com)