

Vexve AM45 DHC (district heating controller)

AM45 DHC contains self-learning, flow meter guided domestic hot water making and advanced heating control for 1 or 2 heating circuits.



AM45 DHC includes three main parts:

AM40 Heating controller; two heating circuits

- 2 pcs supply sensor connection, RJ-11 quick connector
- 1 pcs outdoor sensor connection, RJ-11 quick connector
- 2 pcs 24 VAC 3-point actuator connection, RJ-12 quick connector
- 1 pcs RF-antenna connection for wireless room units, RJ-11 quick connector
- 1 pcs programmable sensor / switch connection, spring loaded connector
- 1 pcs relay (230 VAC/1A), programmable, screw connector

AM50 Extension Unit; Self-learning DHW control and control for three pumps

- 3 pcs of direct 230VAC pump connection with pump status Leds
- 4 pcs temperature sensor connection, RJ-11 quick connector
- 1 pcs flow meter connection, RJ-11 quick connector
- 1 pcs 230 VAC 3-point actuator connection for fast DHW actuator
- 18 VAC power output for AM40, spring loaded connector

AM40 V-15M certified flow meter:

- Nominal flow: 0,8 m³/h
- Max flow: 1,6 m³/h
- Sensitivity: 5 dm³/h
- Accuracy: ±1% (50-1600 dm³/h)
±2% (20-50 dm³/h)
- RJ-11 quick connector

V-20 optional by special request, not certified:

- Nominal flow: 2,5 m³/h
- Max flow: 5,0 m³/h
- Sensitivity: 15 dm³/h
- Accuracy: ±2% (200-5000 dm³/h)
±3% (100-200 dm³/h)
- RJ-11 quick connector

Self-learning, flow meter guided domestic hot water making:

Flow meter based DHW Control

- Self-learning system uses supply temperature sensor and flow meter to control DHW supply
- System detects also changes in flow and direction of change instead of only start of flow
- Self-learning system learns right valve position for every situation; To all flowrates and different pressure and temperature conditions of DH-network
- System be used with or without domestic hot water circulation

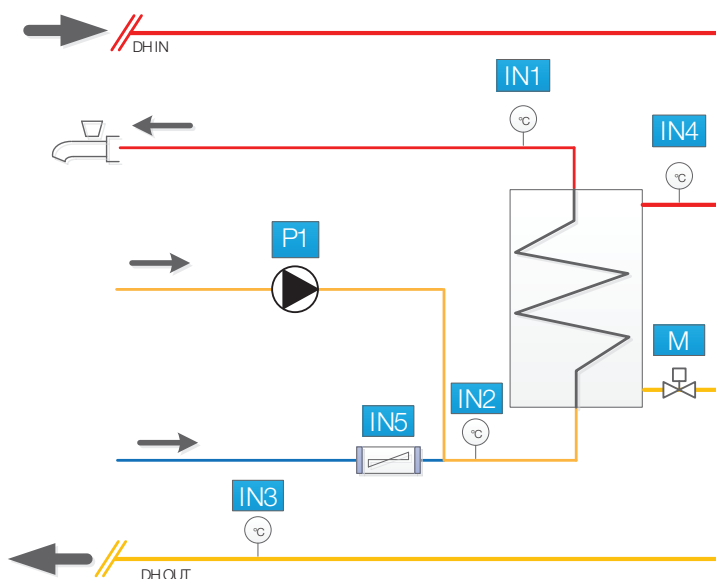

Easy tuning of system

Start-up tuning of system is very simple, just start using hot tap water with different flow rates and controller will automatically adjust itself by self-learning function

Automatic generation of characteristic curve of valve

- Self-learning system stores information of needed valve openings at different flow rates and forms characteristic curve for valve
- Curve is constantly updated during consumption, so controller adapts automatically to temperature and pressure changes at the district heating network

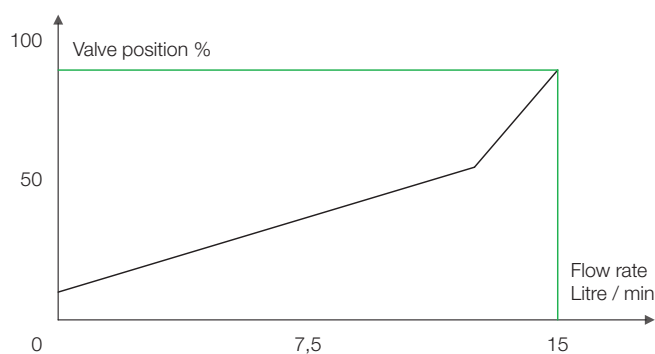

Water consumption monitoring

- Controller measures current and cumulative consumption of DHW
- There is also leakage alarm for DHW if consumption lasts more than four hours

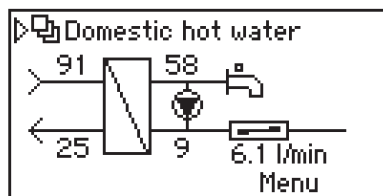

AM50 / Flow information	
Cumulative flow	14m ³
Exit	

Heating Control features:

Modulation ΔT

- Controller measures supply and return water temperatures for heating circuits. Return water temperature reacts to the temperature changes in room such as direct sunlight. Controller adjusts supply water setpoint according to changes in return temperature
- This function is very useful especially in heavy underfloor heating systems because it prevents overloading heavy floor structures, thus saving energy. It also ensures lower return temperature to DH-network

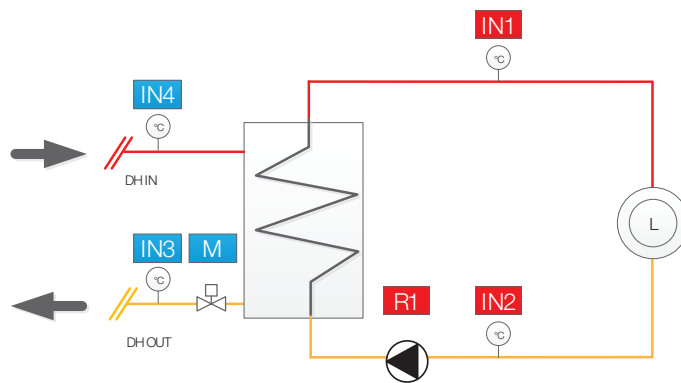

Return temperature prioritization

This function enables prioritization of return water temperature to DH-network. Simply select the maximum limit for return water temperature where the temperature will be kept by limiting opening of valve

Wireless Room Units

- Easiest way to control room temperature is by wireless room unit
- Home-away switch function with one push of button, with pre-programmed Eco-functions. Advanced calendar programs for different temperature profiles
- Can be used only as remote control and display of measured temperatures with alarm functions, available for both heating circuits



Pump Control

- AM45 can control three 230VAC circulator pumps, manually or automatically
- Pumps can be controlled directly from controller, separate detachable Led-panel can be placed in convenient location

Outputs control	
AM50 P1	Auto
AM50 P2	Auto
AM50 P3	Auto
Edit	

Intuitive user menu with start-up wizard

- Basic information for heating and tap water circuits are available at one glance
- All settings and adjustments from same user face, including pumps
- Active alarm with blinking red led and memory for in-active alarms

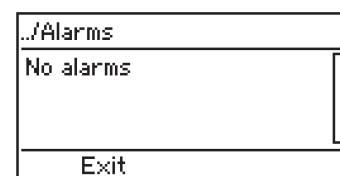
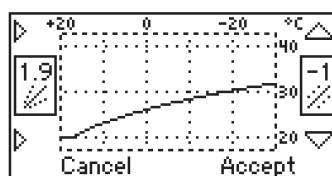
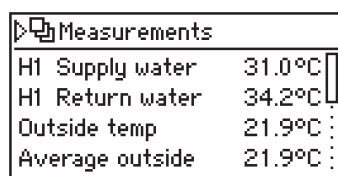
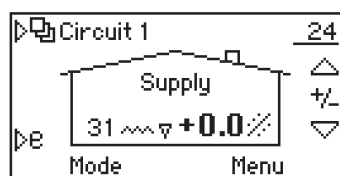

Mounting of AM45 DHC:

AM40 Heating controller;

- Protection class IP21, ready for DIN-rail, wall or panel mounting

AM50 Extension Unit;

- Protection class IP21, ready for DIN-rail and wall mounting
- If AM50 is mounted inside cabinet, pump indicator led panel can be removed from AM50 unit and be placed in a visible place

Wireless room units;

- Wireless data transmission at 868,8 MHz
- Three AA alkaline batteries included with lifetime of 2–3 years
- protection class IP21, ready for wall-mounting
- Antenna unit with 868,8 MHz transmission frequency with 1.5-metre cable and RJ12 connection, wall- mounting
- Protection class IP21, ready for wall mounting

Dimensions

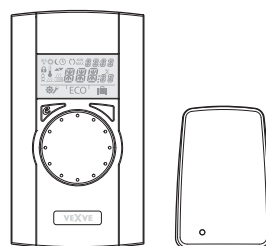
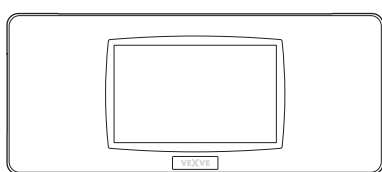
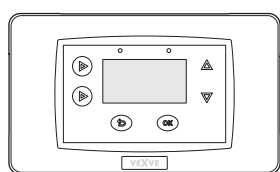

	AM40 (central unit)	AM50 (central unit)	RU (room unit)	RF (RF unit)
Width	167 mm	220 mm	78 mm	55 mm
Height	94 mm	94 mm	139 mm	83 mm
Depth	36 mm	55 mm	23 mm	15 mm

AM45 DHC technical data:

Part	Pcs.	Data	More info
Power to AM50	1	230VAC 50Hz 10A	Wall plug connector
Power to AM40	1	Powered by AM50	3,5mm DC-Plug
Temp. Sensors (pipe)	7	KTY-83 / PT1000	RJ-11 quick connector
Extra input	1	KTY-83 / PT1000 / Switch	Spring loaded contact
Outdoor temp. sensor	1	NTC 2K2, wall mount housing	RJ-11 quick connector, 15m cable
Flow Meter	1	Hall-type flow measuring	RJ-11 quick connector (V-15M / V-20)
Communication Bus	3	RS-485	Modbus interface, max 7pcs of AM50
Relay AM40	1	230 VAC 1A Inductive	1,5 mm ²
Relay AM50	2	230 VAC 1A Inductive	1,5 mm ²
Triac AM50	1	230 VAC variable max. 200W	1,5 mm ²
Heating control actuators	2	24 VAC 3 VA 3-point	RJ-12 quick connector
DHW control actuator	1	230 VAC 7 VA 3-point	1,5 mm ²
Protection class AM40/50	2	IP21	
Fastening	2	DIN-rail, wall or panel mounting	Separate Led-panel for pumps
Display (AM40)	1	52x27mm Dot matrix with Led-backlight	
Wireless Room units	1-2	LCD-display with Led-backlight, wireless data transfer RF 868 MHz, 3 X AA batteries included (lifetime 2-3 years)	Antenna unit with multicolor Led, RJ11 coupling to AM40