



HP_OWER

500 RK - 700 RK - 500 RK A400 - 700 RK A 400

INSTALLATION AND SERVICING MANUAL

Contents

1.	PURPOSE AND CONTENTS OF THE MANUAL	4
1.1	how to keep the manual	4
1.2	graphic symbols used in the manual.....	4
2.	NORMATIVE REFERENCES	4
3.	PERMITTED USE	5
4.	general safety guidelines.....	5
4.1	WORKERS' HEALTH AND SAFETY	5
4.2	personal protective equipment.....	6
4.3	Safety signs.....	7
4.4	REFRIGERATN SAFETY DATA SHEET.....	8
4.5	specific R32 gas warnings	9
4.6	R32 gas charge.....	9
4.7	R32 gas disposal	9
4.8	safety rules for R32 gas transport and storage.....	9
5.	INSTALLATION	9
5.1	GENERAL.....	9
5.2	TRANSPORT AND STORAGE LIMIT TEMPERATURE	10
5.3	lifting and handling.....	10
5.3.1	LIFTING MODE	10
5.4	POSITIONING AND MINIMUM TECHNICAL CLEARANCES.....	11
5.5	DIMENSIONS.....	13
5.5.1	Standard version	13
5.5.2	Version with tank kit	13
5.6	CENTRE OF GRAVITY AND DAMPERS LOCATION	14
5.7	ACCESSING THE INNER PARTS	15
5.7.1	Access to the inside of the unit on the electrical panel side.....	15
5.7.2	Access to the inside of the unit on the hydronic kit side	16
5.8	Plumbing connections	16
5.8.1	Features of the circuit water.....	17
5.8.2	Hydraulic diagram inside the unit	17
5.8.3	Drainage system.....	19
5.8.4	Filling / Discharge of the plant	19
5.8.5	Service sleeves	20
5.9	ELECTRICAL CONNECTIONS	20
5.9.1	Access to electric panel.....	21
5.9.2	Power supply.....	21
5.9.3	User terminal block.....	22
5.9.4	Control logics	23
5.9.5	Fuses	23
5.10	FUNCTIONAL DIAGRAMS	24
6.	START UP	25
6.1	switching on the unit.....	25
7.	INSTRUCTIONS for the user	25

8.	SHUTDOWNS FOR LONG PERIODS.....	26
9.	MAINTENANCE AND PERIODIC CHECKS.....	27
9.1	GENERALITY	27
9.1.1	Cleaning the filled coil treated with the anti-corrosion method.....	27
9.2	CLEANING OF EXTERNAL SURFACES	28
9.3	EXTRAORDINARY MAINTENANCE	28
10.	DECOMMISSIONING	28
11.	RESIDUAL RISK.....	29
12.	TECHNICAL DATA	33
12.1	TECHNICAL SHEET HEAT PUMP.....	33
12.2	UNIT AND AUXILIARY ELECTRICAL DATA	35
13.	OPERATING LIMITS.....	38
13.1	EVAPORATOR WATER FLOW RATE	38
13.2	COLD WATER PRODUCTION (SUMMER MODE)	38
13.3	HOT WATER PRODUCTION (WINTER MODE)	38
13.4	AMBIENT AIR TEMPERATURE AND SUMMERISED TABLE	38
14.	USER INTERFACE - CONTROLLER.....	41
14.1	MENU	42
14.2	SETPOINT MENU	42
14.3	ALARM MENU [ERR].....	42
15.	TROUBLESHOOTING	42

The manual of the units contains all the indications for the optimal use of the machine under safe conditions for the operator.

1. PURPOSE AND CONTENTS OF THE MANUAL

This manual provides basic information as to the selection, installation, operation and maintenance of the unit. It is intended for the operators of the appliance and it enables them to use the equipment efficiently, even if they do not have any previous specific knowledge.

	<p>CAUTION: Although this manual has been drafted for the end user, some of the operations described are the responsibility of skilled personnel having technical or professional qualifications to perform the activities herein. They must also be kept up-to-date by attending refresher courses acknowledged by the competent authorities. These tasks include: installation, routine and extraordinary maintenance, decommissioning of the appliance and any other operation indicated “by qualified personnel”.</p>
	<p>When the installation and/or maintenance operations are over, the qualified operator must correctly inform the end user regarding use of the appliance and the necessary periodical inspections.</p>
	<p>The operator has the responsibility of submitting all of the documentation necessary (including this manual) and of explaining that it all must be kept with care, in the vicinity of the appliance and always available.</p>

The manual describes the machine at the moment it was sold. It must therefore be considered adequate with respect to the state-of-the-art in terms of potentiality, ergonomics, safety and functionality.

The company also performs technological upgrades and does not consider itself obliged to update the manuals of previous machine versions which could even be incompatible. Therefore make sure to use the supplied manual for the installed unit.

The user is recommended to follow the instructions contained in this booklet, especially those concerning safety and routine maintenance.

1.1 HOW TO KEEP THE MANUAL



The manual has to always be kept together with the unit it refers to. It has to be stored in a safe place, away from dust and moisture. It must be accessible to all users who shall consult it any time they are in doubt on how to operate the equipment.

The company reserves the right to modify its products and related manuals without necessarily updating previous versions of the reference material. We also decline any responsibility for possible inaccuracies in the manual if due to printing or transcription errors.

The customer shall store any updated copy of the manual or parts of it delivered by the manufacturer as an attachment to this manual.

The company is available to give any detailed information about this manual and to give information regarding the use and the maintenance of its own units.

1.2 GRAPHIC SYMBOLS USED IN THE MANUAL

	<p>Indicates operations that can be dangerous for people and/or disrupt the correct operation of the unit.</p>
	<p>Indicates prohibited operations.</p>
	<p>Indicates important information that the operator has to follow in order to guarantee the correct operation of the unit in complete safety.</p>

2. NORMATIVE REFERENCES

Units have been designed in compliance with the following directives and harmonized standards on the safety of machinery:

- Community directives, 2014/68/UE, 2006/42/EC, 2014/30/UE;
- Standard UNI EN 378-1, 378-2, 378-3. UNI EN ISO 12100, UNI ISO/TR 14121-2, UNI EN ISO 13857, 14120;
- Standard CEI EN IEC 61000-6-3, 61000-3-3, 61000-6-4. IEC 63000;
- EN 12735-1, 12375-2, 14276-2, 13585, 13134;
- EN 60335-2-40.

And the following directives, regulations and standards on ecodesign and energy labelling:

- Community directive 2009/125/CE and subsequent transposal,
- UE Regulation 2017/1369;
- UE Regulation 811/2013;
- UE Regulation 813/2013;
- EN 14511, EN 14825, UNI EN ISO 9614-1.

3. PERMITTED USE

- The company excludes any contractual and extra contractual liability for damage caused to persons, animals or objects, by incorrect installation, setting and maintenance, improper use of the equipment, and the partial or superficial reading of the information contained in this manual.
- These units are built for the heating and/or cooling of water. Any other use not expressly authorised by the manufacturer is considered improper and therefore not allowed. The fluid to be used is exclusively water or a mixture of water and glycol in case of low water temperatures.



	It is absolutely NOT allowed to connect the heated water supply from the UNIT directly to the taps of the domestic hot water circuit. This fluid is not intended for sanitary use and must not be ingested.
---	--

- The installation place and the water and electric circuit must be established by the plant designer and must take into account both technical requirements as well as any applicable local laws and specific authorisations.
- All the work must be executed by skilled and qualified personnel, competent on the existing regulations in country of installation.
- This appliance is intended to be used by expert or trained operators in shops, light industry and in factories, or for commercial use by non-expert personnel.
- The appliance may be used by children at least 8 years old and by persons with reduced physical, sensory or mental capabilities or without experience or the necessary knowledge as long as they are supervised or after they themselves have received instructions on the safe use of the appliance and understand the relevant dangers. Children must not play with the appliance. The cleaning and maintenance which the user is expected to carry out on the unit cannot be done by children without supervision.
- Direct interaction with the device by people with electrically controlled medical devices, such as pacemakers, is forbidden, as harmful interference may be created. It is recommended to keep adequate distance from unit installation, as indicated by the medical system used.

	Users of electrically controlled medical devices should exercise caution when interacting with the unit.
---	---







4. GENERAL SAFETY GUIDELINES

Before starting any type of operation on the units, every operator must be perfectly familiar with the operation of the machine and its controls and must have read and understood all the information in this manual.

	It is strictly forbidden to remove and/or to tamper with any safety device.
	Children or unassisted disabled persons are not allowed to use the appliance.
	Do not touch the appliance when barefoot or parts of the body are wet or damp.
	It is forbidden to perform any cleaning operation when the master switch is 'ON'.
	It is forbidden to pull, detach or twist the appliance's electric cables, even if unplugged.
	Do not step on, sit down on and/or place any type of object on the appliance.
	Do not spray or pour water directly on the unit.
	Do not dispose of, abandon or leave within reach of children packaging materials (cardboard, staples, plastic bags, etc.) as they may represent a hazard.
	Any routine or extraordinary maintenance operation must be carried out with the machine stopped and disconnected.
	Do not place your hands or introduce screwdrivers, spanners or any other tools on moving parts.
	The machine operator and maintenance personnel must receive suitable training for the performance of their tasks in safety.
	Operators must know how to use personal protective equipment and the accident-prevention rules of national and international laws and regulations.

4.1 WORKERS' HEALTH AND SAFETY

The European Union has issued some directives regarding the safety and health of workers, including: 89/391/CEE, 89/686/CEE, 2009/104/CE, 86/188/CEE and 77/576/CEE, and subsequent amendments which every employer is obliged to follow and have followed. We observe therefore that:

	Do not tamper with or replace parts of the unit without the specific consent of the manufacturer. These interventions release the manufacturer from any civil or legal responsibility.
	Using components, consumables or spare parts that do not correspond to those recommended by the manufacturer and/or listed in this manual may be dangerous for the operators and/or damage the unit.
	The operator's workplace has to be kept clean, tidy and clear of objects that may hinder free movement. Appropriate lighting of the work place shall be provided so as to allow the operator to carry out the required operations safely. Poor or excessive lighting can cause risks.
	Ensure that work places are always adequately ventilated and that the extraction systems are working, in good condition and in compliance with the requirements of the laws in force.
	In the design phase, the indications contained in UNI EN ISO 14738 regarding workstations on the machinery were followed and the lifting limits imposed by UNI ISO 11228-1 were evaluated.
	Make sure to maintain, during the installation and maintenance of the unit, a posture that does not cause fatigue. Check the weight, before moving any component.

The unit works with R32 refrigerant, which is included in the list of greenhouse gases (GWP 675) which are subject to the requirements in EU regulation n. 517/2014 called "F-GAS" (mandatory in the European zone). Among the provisions of this regulation, it sets forth that operators working on systems running with greenhouse gases be in possession of a certification, issued or acknowledged by the competent authorities, attesting that they have passed a test authorising them to perform this work. In particular

- Up to 3kg total refrigerant in the appliance: category 2 certification.
- 3 kg e and more total refrigerant in the appliance: category 1 certification.

The gaseous form of R32 refrigerant is heavier than air and if released into the environment, most of it tends to concentrate in poorly ventilated areas. Inhaling it can cause dizziness and sensations of suffocation and can develop lethal gas if in contact with naked flames or hot objects (see the refrigerant's safety data sheet).



Pay attention to the fact that refrigerant fluids can be odourless

For any operation on the heat pump system:

	Wear the appropriate PPE (specifically gloves and goggles).
	Make sure that the workplace is well ventilated. Do not work in closed environments or ditches with little air circulation.
	Do not operate on the refrigerant in the vicinity of hot parts or naked flames.
	Do not release the refrigerant into the environment and pay special attention to accidental leakage from pipes and/or fittings even after having emptied the plant.
	Make sure there is a fire extinguisher near the unit.

4.2 PERSONAL PROTECTIVE EQUIPMENT

When operating and servicing the units, the following personal protective equipment must be used:

	Clothing: Maintenance technicians and operators must wear protective clothing that does not leave parts of the body uncovered, as during maintenance it is possible to come into contact with hot or sharp surfaces. Clothes that can become entangled or sucked in by air flows should be avoided.
	Wear safety shoes with non-slip soles, especially in rooms with slippery floor.



Gloves: During maintenance or cleaning operations, appropriate protective gloves must be used.



Mask and goggles: Respiratory protection (mask) and eye protection (goggles) should be used during cleaning operations.



4.3 SAFETY SIGNS

The unit features the following safety signs, which must be complied with:



Generic hazard.



Dangerous electric voltage.



Moving parts.



Surfaces which can cause injuries.



Boiling surfaces which can cause burns.



Fire hazard.

REFRIGERANT SAFETY DATA SHEET

Dénomination:	R32
INDICATION DES DANGERS	
Dangers principaux:	Asphyxie.
Dangers spécifiques:	La rapidité de l'évaporation peut provoquer la congélation.
MESURES D'URGENCE	
Informations générales:	Ne rien administrer aux personnes évanouies.
Inhalation:	Transporter la personne à l'air libre. Recourir à l'oxygène ou à la respiration artificielle si nécessaire. Ne pas administrer d'adrénaline ni de substances similaires.
Contact avec les yeux:	Rincer soigneusement et abondamment avec de l'eau pendant au moins 15 minutes et s'adresser à un médecin.
Contact avec la peau:	Rincer aussitôt abondamment avec de l'eau pendant au moins 15 minutes. Appliquer une gaze stérile. Retirer immédiatement les vêtements contaminés.
MESURES ANTI-INCENDIE	
Moyens d'extinction:	Eau nébulisée, poudre sèche.
Dangers spécifiques:	Rupture ou explosion du récipient.
Méthodes spécifiques:	Refroidir les récipients avec des vaporisations d'eau depuis une position protégée. Si possible, arrêter la fuite de produit. Si possible, utiliser de l'eau nébulisée pour abattre les fumées. Déplacer les récipients loin de la zone de l'incendie, s'il est possible de le faire sans risques.
MESURES EN CAS DE FUITE ACCIDENTELLE	
Précautions individuelles:	Tenter de bloquer la fuite. Évacuer le personnel dans des zones de sécurité. Éliminer les sources d'inflammation. Prévoir une ventilation adéquate. Utiliser des équipements de protection individuelle.
Précautions environnementales:	Tenter de bloquer la fuite.
Méthodes de nettoyage:	Ventiler la zone.
MANIPULATION ET STOCKAGE	
Manipulation: mesures/précautions techniques:	Veiller à ce que le renouvellement d'air et/ou l'aspiration d'air soient suffisants dans les locaux de travail.
conseils pour une utilisation sûre:	Ne pas respirer de vapeurs et ne pas utiliser d'aérosol.
Stockage:	Fermer soigneusement et conserver dans un endroit frais, sec et bien ventilé. Conserver dans les récipients originaux. Produits incompatibles: explosifs, matériaux inflammables, Peroxyde organique
CONTRÔLE DE L'EXPOSITION/PROTECTION INDIVIDUELLE	
Paramètres de contrôle:	OEL - données non disponibles. DNEL: Niveau dérivé sans effet (travailleurs) à long terme, effets systémiques, inhalation = 7035 mg/m3. PNEC: Concentration prévisible sans effets eau (eau douce) = 0,142 mg/l aquatique, émissions intermittentes = 1,42 mg/l sédiments, eau douce = 0.534 mg/kg poids sec
Protection respiratoire:	Non nécessaire.
Protection des yeux:	Lunettes de sécurité.
Protection des mains:	Gants de caoutchouc.
Mesures d'hygiène:	Ne pas fumer
PROPRIÉTÉS PHYSIQUES ET CHIMIQUES	
Couleur:	Incolore.
Odeur:	Éthéré. Peu perceptible à basses concentrations.
Point d'ébullition:	-51,7 °C à press. atm.
Point d'inflammation:	648 °C
Densité relative gaz (air=1)	1,8
Densité relative liquide (eau=1)	1,1
Solubilité dans l'eau:	280000 mg/l.
STABILITÉ ET RÉACTIVITÉ	
Stabilité:	Stable en conditions normales.
Matières à éviter: Produits de décomposition dangereux dangereux:	Air, agents oxydants, humidité. En conditions normales de stockage et d'utilisation, aucun produit de décomposition dangereux ne devrait être généré.
INFORMATIONS TOXICOLOGIQUES	
Toxicité élevée: Effets locaux: Toxicité à long terme:	LD/LC50/inhalation/4 heures/test sur rat = 1107000 mg/m3. Aucun effet connu. Aucun effet connu.
INFORMATIONS ÉCOLOGIQUES	
Potentiel de réchauffement global GWP (R744=1):	675
Potentiel de dégradation de l'ozone ODP (R11=1):	0
Considérations sur la mise au rebut:	Se conformer au programme de récupération de gaz du fournisseur. Éviter l'émission directe dans l'atmosphère.

4.4 SPECIFIC R32 GAS WARNINGS

The R32 refrigerant gas:

- is odourless;
- is flammable, but only if there are naked flame;
- it may cause an explosion, but only if a given concentration in air is reached.

It is a good practice to follow these guidelines:

- do not smoke near the unit;
- affix a no smoking sign near the unit;
- keep the premises where the unit is installed properly aerated;
- do not pierce or burn the unit;
- do not place the unit near ignition sources, such as naked flames, electric heaters etc.;
- every extraordinary maintenance or repair on the unit must be performed by skilled technicians or qualified personnel;
- a gas leak test must be performed after installation.

4.5 R32 GAS CHARGE

The procedures described below may only be performed by skilled technicians or qualified personnel:

- ensure the R32 is not contaminated by any other types of refrigerant;
- keep the gas cylinder in an upright position when charging;
- apply the appropriate label on the unit after charging;
- do not charge more refrigerant gas than needed;
- when charging is completed, perform leak tests before the operating test;
- once all the above operations have been completed, a second leak test should be performed.

4.6 R32 GAS DISPOSAL

The procedures described below may only be performed by skilled technicians or qualified personnel:

- do not dispose of the gas in areas at risk of explosive mixtures forming with air. The gas should be disposed of in an appropriate torch with backfiring stop device. Contact the supplier should you require operating instructions.

4.7 SAFETY RULES FOR R32 GAS TRANSPORT AND STORAGE

Before opening the unit's packaging, ensure there are no gas leaks in the environment with an appropriate gas detector. Ensure there are no fire ignition sources near the unit.

No smoking near the unit.

Transport and storage must be performed in accordance with the national regulations in force. Specifically, according to ADR provisions, the total maximum quantity by transport unit in terms of net mass for flammable gases is 333 kg.

5. INSTALLATION



CAUTION: All the operation described below must be done by QUALIFIED PERSONNEL ONLY. Before any operation on the unit, make sure that power is disconnected. Also make sure that power cannot be accidentally switched back on until all the operations are over, by means of specific locks.

5.1 GENERAL

When installing or intervening on the chiller unit, it is necessary to strictly follow the rules listed in this manual, to observe all the indications on the unit and however to take all possible precautions. Failure to comply with the rules reported on this manual can create dangerous situations.



After receiving the unit, immediately check its integrity. The unit left the factory in perfect condition; any damage must be immediately reported to the carrier and recorded on the Delivery Note before signing it.











The company must be informed, within 8 days, of the extent of the damage. The Customer should prepare a written statement of any severe damage.



CAUTION: The units are designed for outdoor installation. The outside temperature must never exceed 46°C. Beyond this value, the unit is no longer covered by the current regulations in the field of safety of pressure equipment.



CAUTION: The installation place must be without any fire risks. Therefore all the necessary measures should be adopted in order to prevent the risk of fire at the installation place. The appliance must not be placed near naked flames and ignition sources or heat sources. The wall of the buildings near the unit must have an adequate fire resistance class, in order to contain any fire that may develop inside the rooms. However it is recommended to place a fire extinguisher near the unit.

	CAUTION: The unit must be installed so as to allow free movement for repair and maintenance operations. The warranty does not cover costs for platforms or other lifting equipment needed for any interventions.
	CAUTION: The unit must be installed so as to allow free movement for repair and maintenance operations. The warranty does not cover costs for platforms or other lifting equipment needed for any interventions.
	All the maintenance operations and tests must be done by QUALIFIED PERSONNEL ONLY .
	Before any operation on the unit, make sure that power is disconnected.
	Do not use equipment to speed up the defrost process or for cleaning except for those recommended by the manufacturer.
	Do not perforate or burn.
	CAUTION: There are some moving components inside the unit. Pay the utmost attention when operating in their vicinity, even if power is disconnected.
	The heads and delivery pipe of the compressor are normally quite hot.
	Be careful when working near the condensing coils. The aluminium fins are very sharp and can cause serious injuries.
	After the maintenance operations, close the panels by fixing them with screws.

5.2 TRANSPORT AND STORAGE LIMIT TEMPERATURE

Minimum transport/storage temperature [°C]	- 10 °C
Maximum transport/storage temperature [°C]	+ 50 °C

5.3 LIFTING AND HANDLING

The handling must be performed by qualified personnel, properly equipped with appropriate tools to the weight and the encumbrance of the unit, in compliance with safety regulations of accident preventing.

It is recommended:

1. Check the weight on unit technical label or on table of technical data;
2. Check moving the unit there are no disconnected paths, ramps, steps, doors that could affect the movement and damage the unit;
3. Make sure the unit stands while moving;
4. Before handling the unit, check that the equipment is suitable for lifting and preserving the integrity of the unit;
5. Check the unit center of gravity and align it with lifting point;
6. Perform lifting only by one of the listed procedures;
7. Before starting handling make sure the unit is in stable equilibrium.

5.3.1 LIFTING MODE

Only perform lifting operations using one of the methods listed below:



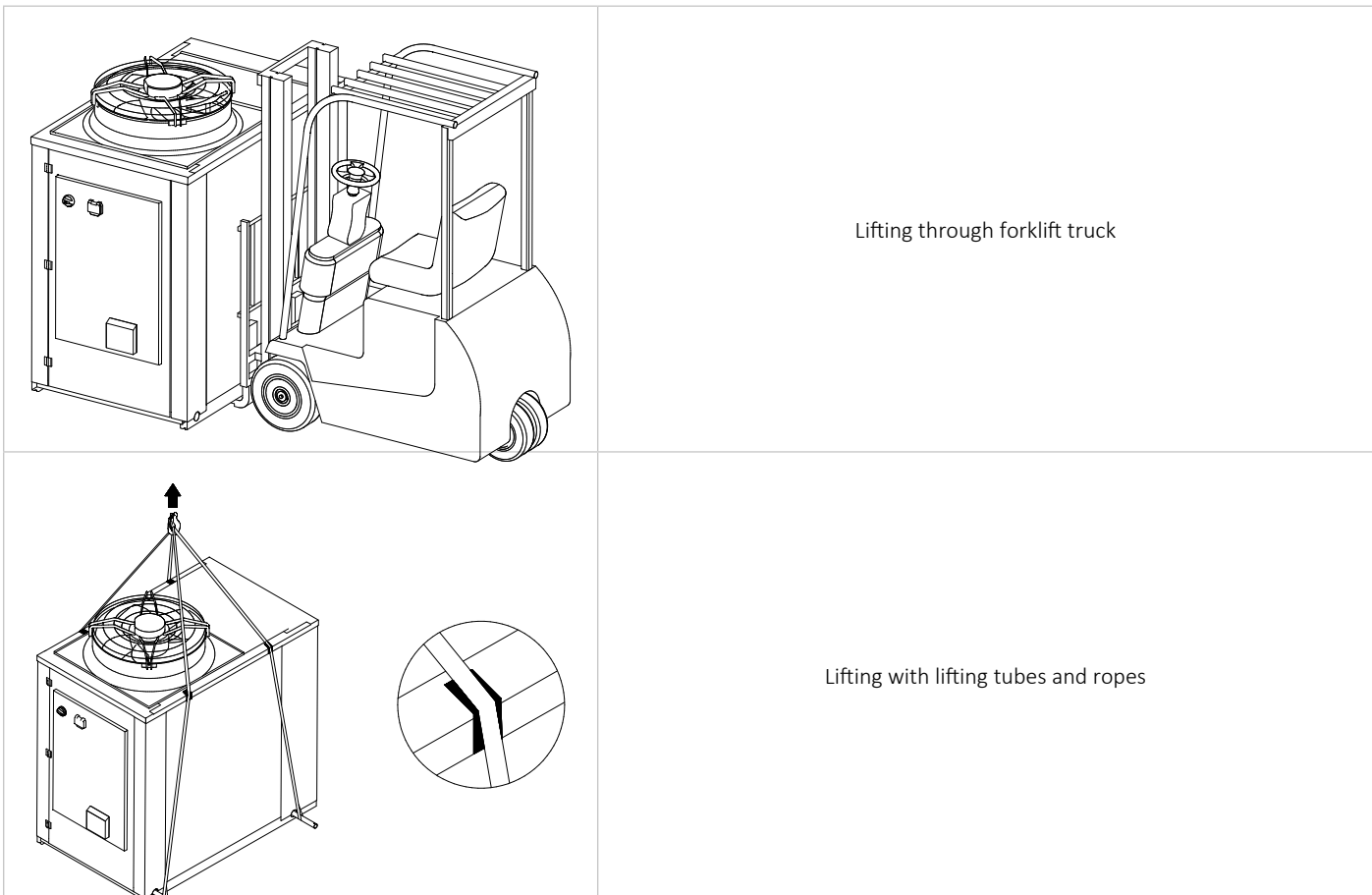

- forklift truck;
- thick lifting tubes according to EN 355 and EN 10297-1, thick lifting tubes according + ropes/chains;
- lifting slings (available as an accessory) + ropes/chains + sling bar. Ensure that the lifting ropes are tensioned gradually and check that they are correctly positioned.



5.4 POSITIONING AND MINIMUM TECHNICAL CLEARANCES

All models of the range are designed and constructed for outdoor installations.

It is advisable to create an adequately sized support base for the unit. The units transmit a small amount of vibrations to the ground: it is nonetheless advisable to apply vibration dampers between the base frame and support surface.

	<p>Suspended installation is forbidden.</p>
	<p>The support plane must have enough capacity to support the unit weight, which can be checked both on the technical label on the unit and on this technical manual under “Technical data” chapter. The support plane mustn't be inclined to ensure the unit works properly and avoid a possible overturning. The support plane mustn't be smooth, to avoid water/ice deposit as potential sources of danger.</p>
	<p>Unit installation place must be free from foliage, dust, etc., which could clog or cover the coil. Installation in areas subject to water stagnation or fall, for example from gutters, should be avoided. Also avoid areas subject to snow accumulation (such as corners of buildings with sloping roofs). In case of installation in areas subject to snowfall, place the unit on a base raised from the ground by 20-30 cm, so as to prevent the formation of snow accumulations around the machine.</p>
	<p>It is recommended to ensure sufficient air exchange to dilute the R32 gas in case of accidental leakage, to avoid the formation of explosive atmospheres. For this reason, a minimum distance of 1 metre must be maintained from openings or wells, where the gas could accumulate.</p>
	<p>Installation of the unit under roofs of any kind, such as roofs, canopies and the like, should be avoided.</p>

It is very important to avoid recirculation between intake and delivery air, so as not to downgrade performance of the unit or even to interrupt its normal operation.

In this case, it is absolutely necessary to guarantee the minimum service spaces listed below.

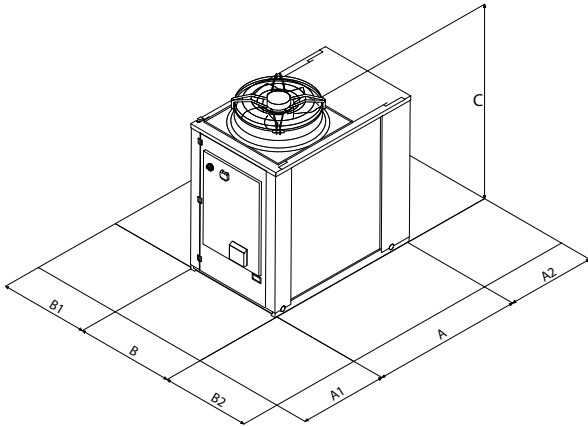

Model		A1	A2	B1	B2
HP_OWER 500RK - 700RK	mm	1200	1000	1500	1500



For strong wind installation place refer to the classification of the area according to the Beaufort table. If the value is > 7 (strong wind, average wind speed = 13,9-17,1 m/s) it is strictly necessary to keep the fan always powered, thus preventing involuntary rotation of the same.

In the event of side-by-side units, the minimum Lmin distance between them is 2200 m.

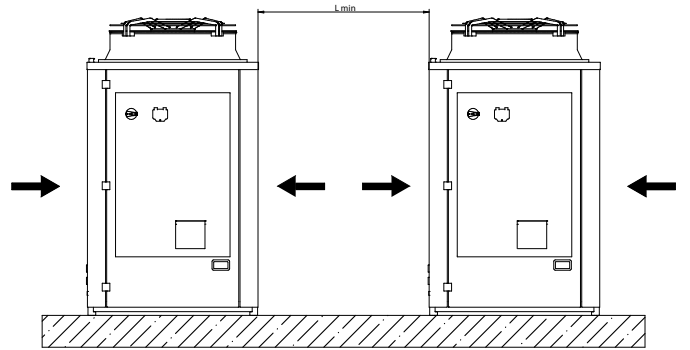

Covering with canopies or placing near plants or walls should be avoided to prevent air circulation.

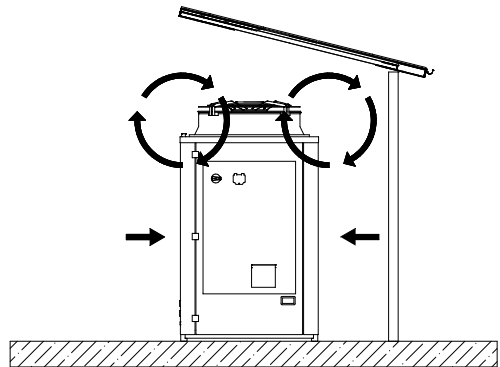

In the event of winds stronger than 13,9-17,1 m/s the use of wind barriers is recommended.

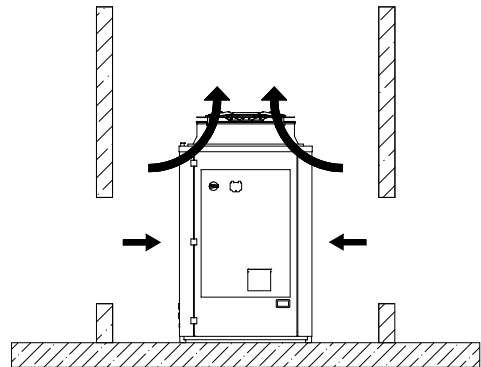

We always invite you to make an environmental impact assessment based on the power and sound pressure data shown in chapter "Technical data" and the sound emission limits based on the installation area of the unit, with reference to the DPCM of 14/11/1997. An assessment must also be made if the unit is installed in the proximity of workers according to D. LGS. 81/2008 Art. 189 and following.

5.5 DIMENSIONS

5.5.1 Standard version

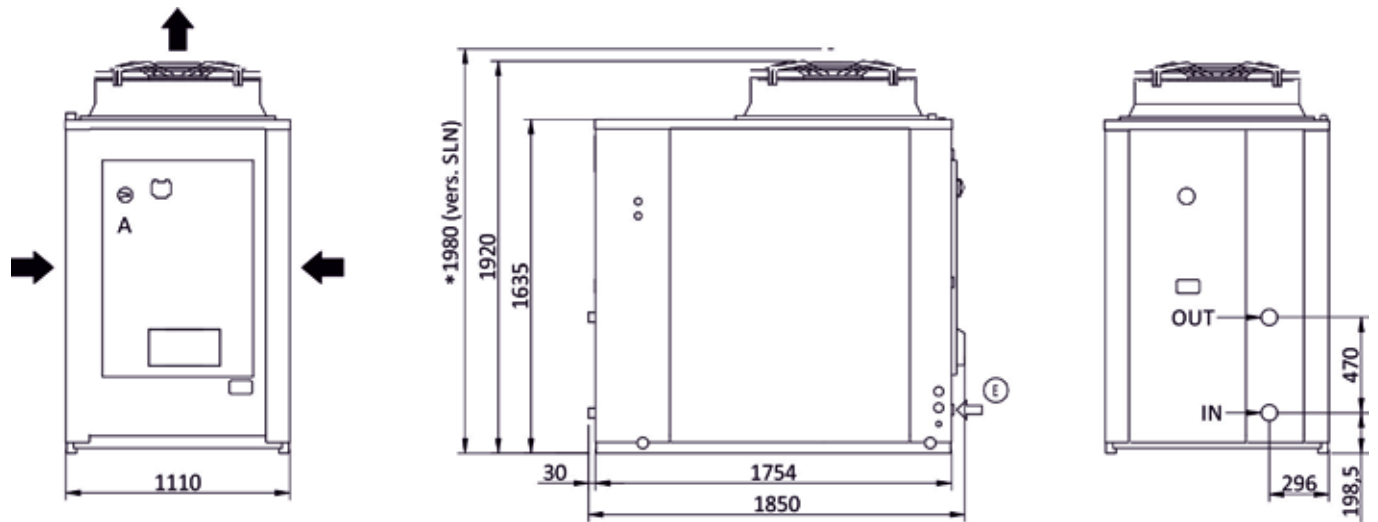

Dimensions		
A - Length	mm	1850
B - Depth	mm	1110
C - Height	mm	1920
IN / OUT	inch	1" 1/2 Grooved
E	-	Power supply input

5.5 DIMENSIONS

5.5.2 Version A400 with tank kit

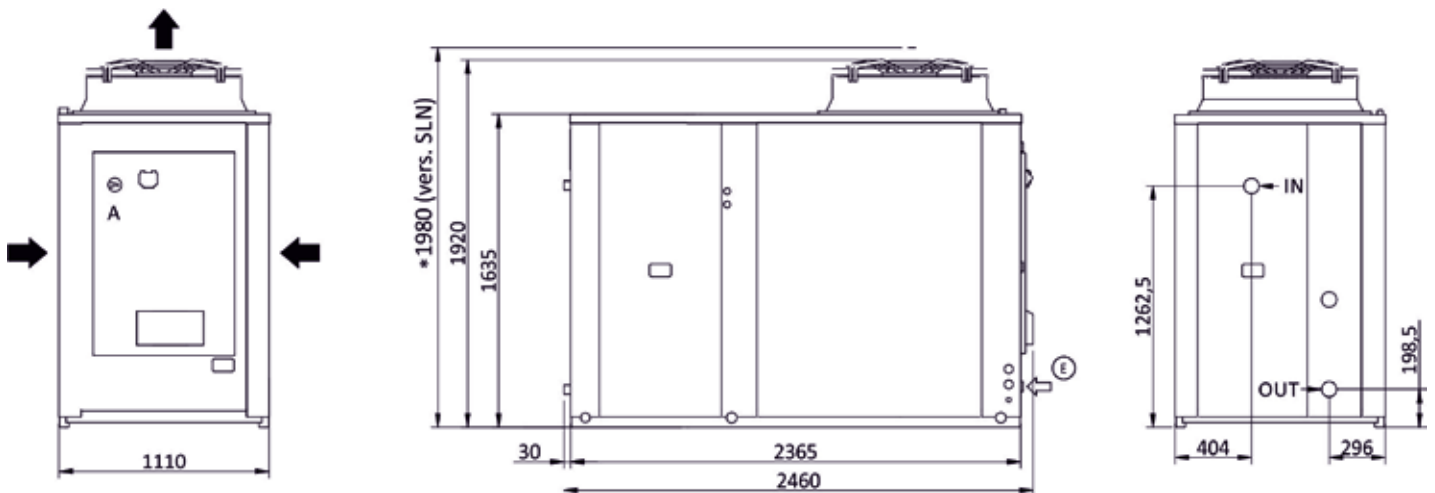

Dimensions		
A - Length	mm	2460
B - Depth	mm	1110
C - Height	mm	1920
IN / OUT	inch	1" 1/2 Grooved
E	-	Power supply input

IDRONIC KIT

Hydronic kit features		
Tank volume	I.	400
Expansion vessel volume	I.	24

5.6 CENTRE OF GRAVITY AND DAMPERS LOCATION

In the following tables, we report the position of the barycentre of each machine, with reference to the dimensions shown in the image. A distinction is made between standard machine version, with hydronic kit (single pump) and if the tank is also installed.

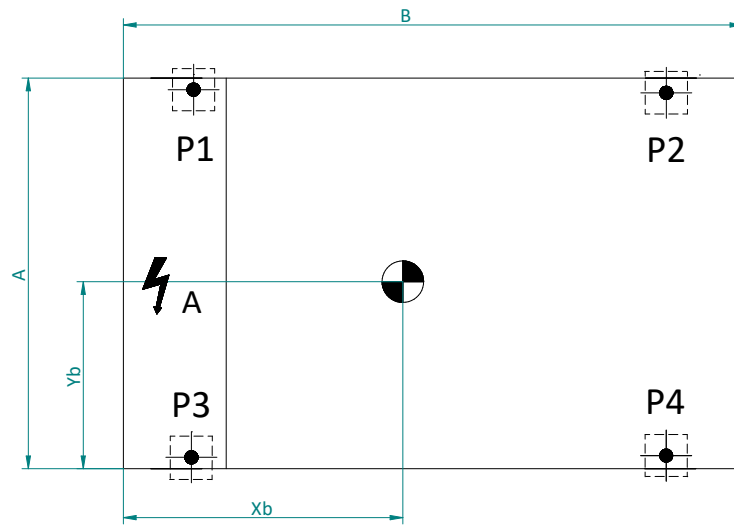

Model	Version	A [mm]	B [mm]	Xb [mm]	Yb [mm]
HP_OWER 500 RK	Standard with integrated pump	1110	1754	652	517
	With tank kit A 400	1110	2365	970	540
HP_OWER 700 RK	Standard with integrated pump	1110	1754	683	511
	With tank kit A 400	1110	2365	979	533

Model	Version	HP_OWER 500 RK	HP_OWER 700 RK
Standard with integrated pump	Shipping weight [kg]	535	595
	Operating weight [kg]	540	600
With tank kit A 400	Shipping weight [kg]	685	745
	Operating weight [kg]	1090	1150

The ideal installation positions of the dampers for each type of machine are shown in the below images.

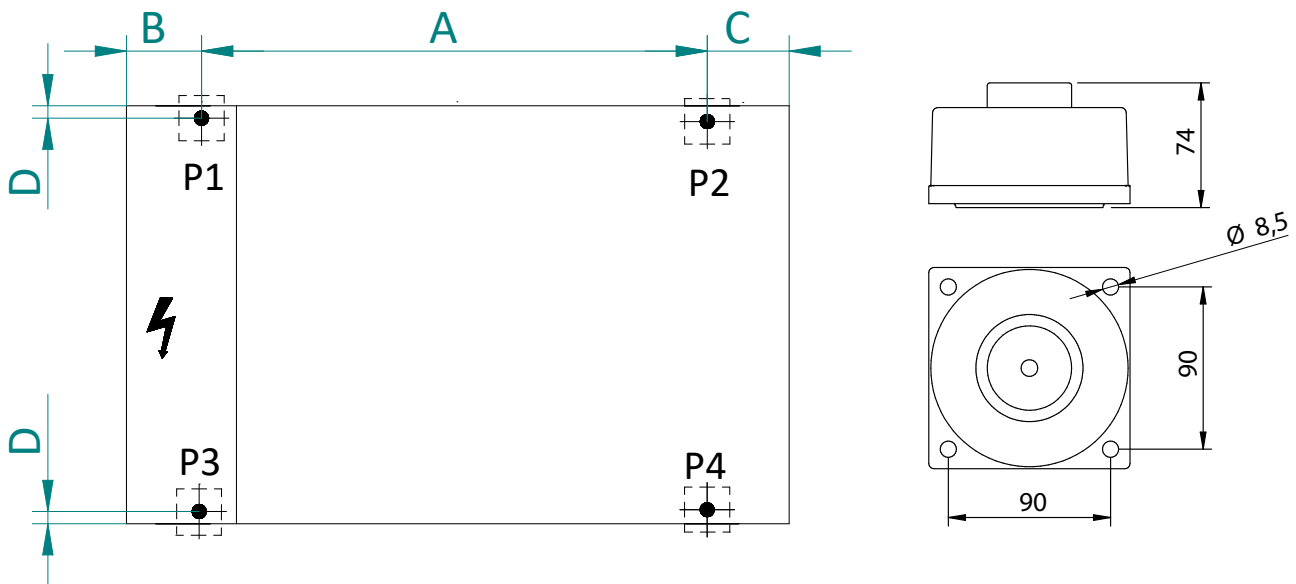

Models	Version	A [mm]	B [mm]	C [mm]	D [mm]
HP_OWER 500 RK 700 RK	Standard	1410	105	235	32
	Hydronic kit with tank A 400	2180	105	80	32

5.7 ACCESSING THE INNER PARTS

5.7.1 Access to the inside of the unit on the electrical panel side

In case of maintenance and/or inspection of the compressors, it is necessary to access the inside of the unit by opening the door, located on the front side where the electrical panel is also located. To unlock it, it is necessary to unscrew the fixing screws using the appropriate tool and pull it towards you using the handle located under the panel. Pay attention to the electrical panel which is bound to the door itself. For access to the panel, see the relative chapter.

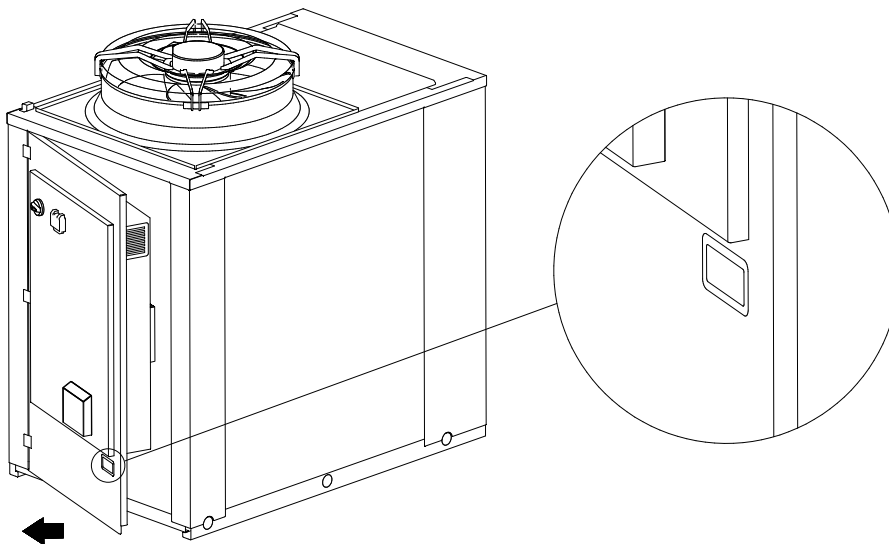

The operator must pay attention to the fins of the driver which protrude from the inside and can be sharp at the edges.



Pay particular attention to any slight differences in level that may cause the door to close unintentionally, with the risk of crushing.

5.7.2 Access to the inside of the unit on the hydronic kit side

In the event of maintenance and/or inspection of the hydronic part and part of the refrigeration circuit, it is necessary to access the inside of the unit from the rear side, near the hydraulic connections. Unscrew the rear panel fixing screws and remove it from the base.

In the case of a single-battery unit, one of the two sides can also be inspected by removing the side panels; in the case of a tank kit, both sides of the additional appendage can also be removed.

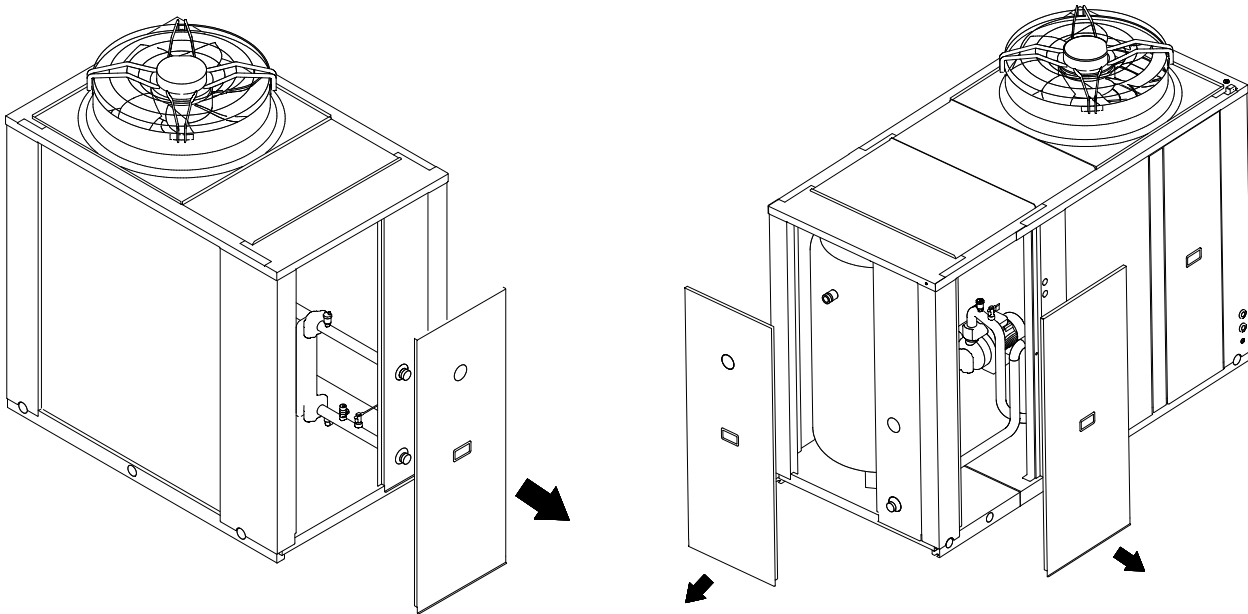

5.8 PLUMBING CONNECTIONS

The plumbing connections must be made in accordance with national and/or local regulations; pipes can be made of steel, galvanised steel or PVC. Pipes must be accurately sized according to the nominal water flow rate of the unit and the pressure drops of the water circuit. All pipes must be insulated with closed-cell material of adequate thickness. The chiller must be connected to the pipes using new flexible joints, not re-used ones. The water circuit should include the following components:

- Well thermometers to monitor the circuit's temperature.
- Manual gate valves to isolate the chiller from the water circuit.
- Metal Y filter and dirt separator (installed on the return pipe) with metal mesh no larger than 1 mm. (obligatory to maintain the validity of the guarantee).
- Loading group and exhaust valve where necessary.

	CAUTION: When sizing the pipes, make sure not to exceed the maximum pressure drop on plant side reported in the technical data table (see useful head).
	CAUTION: Connect the pipes to their fittings always using the key to key method.
	CAUTION: Create a suitable drain for safety valve.
	CAUTION: The expansion vessel, if present on the unit (check the hydraulic diagram), has a limited capacity. It is the installer's responsibility to check that the expansion vessel is adequate for the actual capacity of the system, otherwise an additional expansion vessel must be provided.
	ATTENZIONE: The return pipe from the system must be installed near the label "WATER INLET" otherwise the evaporator could freeze.
	ATTENZIONE: It is mandatory to install a metal filter (with mesh no larger than 1 mm) and a dirt separator on the return pipe from the system labelled "WATER INLET". If the flow switch is manipulated or altered, or if the metal filter and dirt separator are missing, the warranty will terminate immediately. The filter and dirt separator must be kept clean. Therefore after installing the unit, you must make sure that they are still clean and check them regularly.
	All of the units leave the company supplied with flow switch (installed in factory). If the flow switch is altered or removed or if the water filter and dirt separator are missing from the unit, the guarantee will be void. Refer to the wiring diagram attached to the unit to connect the flow switch. Never jumper connections of the flow switch in the terminal block.



The heating system and the safety valves must comply with the requirements of standard EN 12828.

The unit is pre-tensioned on the side cover plate in order to provide a suitable passage for the discharge of the safety valve (the installation of which is the responsibility of the user).

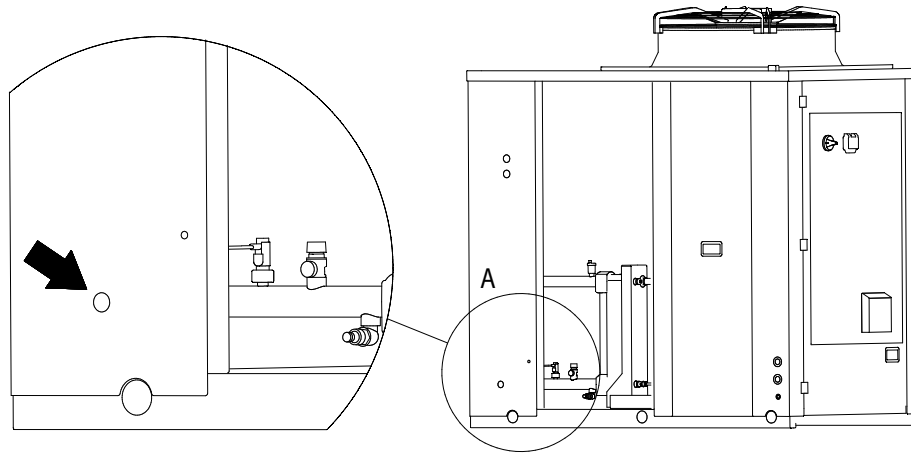

5.8.1 Features of the circuit water

To guarantee correct operation of the unit, the water must be appropriately filtered (see the instructions at the start of this paragraph) and there must be only a minimum amount of dissolved substances. The maximum allowed values are shown below.

MAXIMUM CHEMICAL-PHYSICAL PROPERTIES ALLOWED FOR THE CIRCUIT WATER	
PH	7,5 - 9
Electrical conductivity	100 - 500 $\mu\text{S}/\text{cm}$
Total hardness	4,5 – 8,5 dH
Temperature	< 65°C
Oxygen content	< 0,1 ppm
Max glycol quantity	40 %
Phosphates (PO4)	< 2ppm
Manganese (Mn)	< 0,05 ppm
Iron (Fe)	< 0,3 ppm
Alkalinity (HCO3)	70 – 300 ppm
Chloride ions (Cl-)	< 50 ppm
Sulphate ions (SO4)	< 50 ppm
Sulphide ions (S)	Nessuno
Ammonium ions (NH4)	Nessuno
Silica (SiO2)	< 30 ppm

5.8.2 Hydraulic diagram inside the unit

The hydraulic connection diagrams to the unit for all the available versions and the legend valid for all the diagrams are shown below. In any case, each unit always includes a safety valve with an opening pressure of 6 bar, whatever the hydronic kit with which it is equipped.

Legend			
EV/CO	Plate heat exchanger	WF	Y-filter*
DV	Discharge valve	FC	Flow switch
RV	Safety valve	W-IN	Water input
BV	Shut-off valve	W-OUT	Water output
HKA1	Heat exchanger resistance *	VSI	3-way valve *
HKA2	Pump resistance *	CV	Non-return valve
VA	Expansion vessel	AV	Automatic air vent valve
*	Optional	TK	Tank *
---	Separately supplied accessory to be installed outside the unit		

STANDARD HYDRONIC CIRCUIT

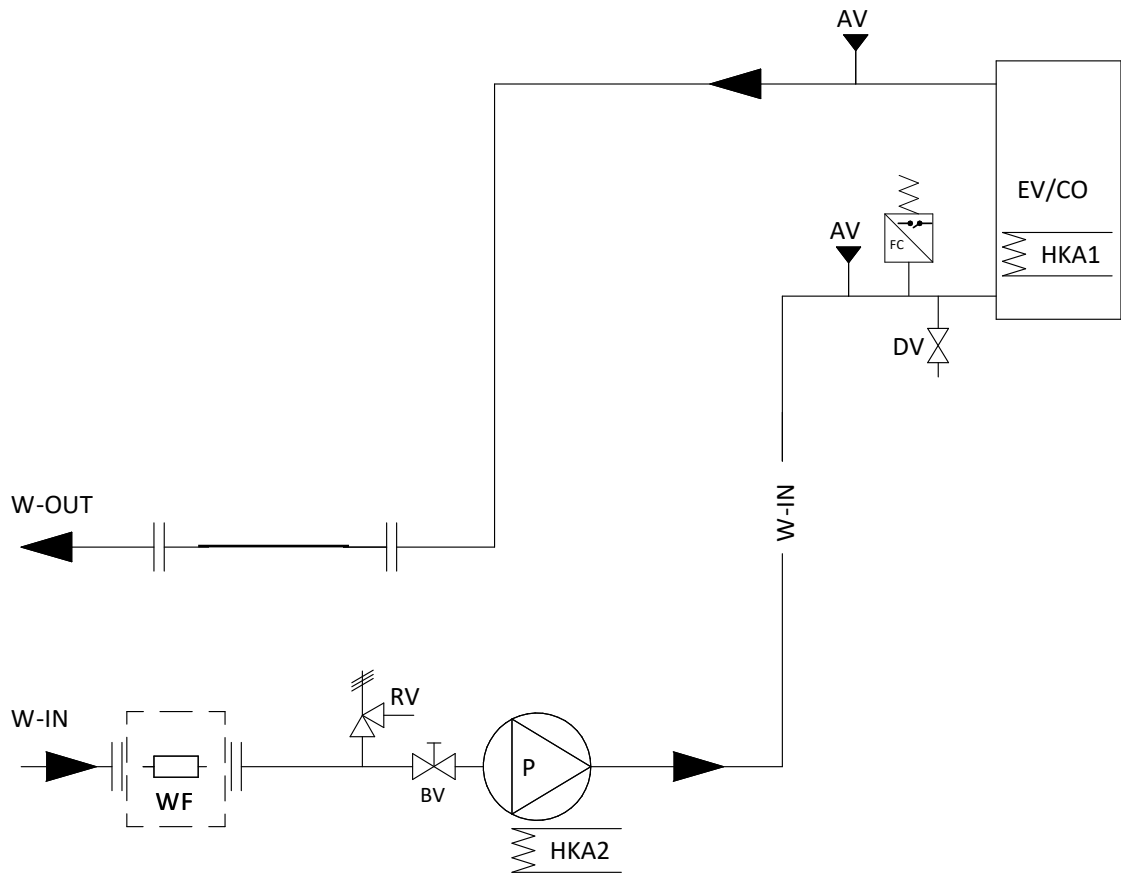

HYDRONIC CIRCUIT VERSION AC 400

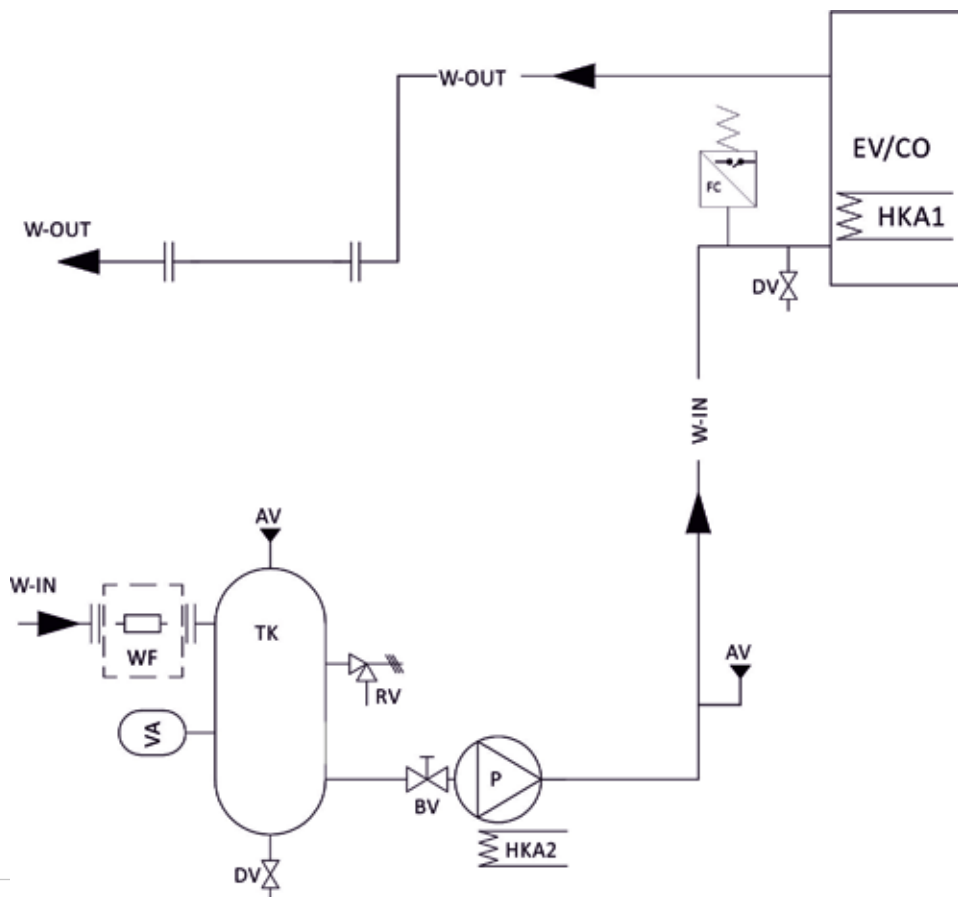



ATTENTION: It is recommended to connect the safety valve vent in an appropriate conveyor / discharge. Otherwise the discharged water could stagnate around the unit and become a source of danger due to slipping / falling.

5.8.2 Drainage system

The units all of them adopt drainage holes on the basement for the condensate draining which can leach from the pipes of hydraulic and refrigerant circuits, and to discharge the generated water during defrosting cycles.

FOR HEAT PUMP UNITS, IN PARTICULARLY COLD CLIMATES, INSTALLATION ON ELEVATION SUPPORTS IS RECOMMENDED TO ALLOW ICE TO FORM UNDER THE UNIT WITHOUT DAMAGING IT.

Any condensation that may leak from the plumbing pipes remains on the base of the unit and dries naturally. As the pipes are well insulated, condensation production is minimal and therefore there is no need to install drainage systems.



CAUTION: for heat pump units, in the event that the prepared ducting system is not used, a limited amount of water (possible ice in the winter period) from the condensate drainage system may be deposited in the vicinity of the unit, with consequent danger of slipping/falling.

5.8.3 Filling / Discharge of the plant



CAUTION: Supervise all filling/top-up operations.

CAUTION: Before filling/topping up the system disconnect power to the units.

CAUTION: The system must always be filled/topped up in controlled pressure conditions (1±3 bar). Make sure that a pressure reducer and safety valve have been installed on the filling/top-up line.

CAUTION: The water on the filling/top-up line must be appropriately pre-filtered from any impurities and suspended particles. Make sure that a removable cartridge filter and dirt separator are installed on the line.

CAUTION: Regularly check and vent the air built up in the system.

CAUTION: Install an automatic air venting valve at the highest point of the system.

It is advisable to use an external tap to fill the system, which is the responsibility of the installer.
There is always a service tap in the unit to be used if it is necessary to top up/discharge the amount of water in the system or adjust the percentage of glycol.

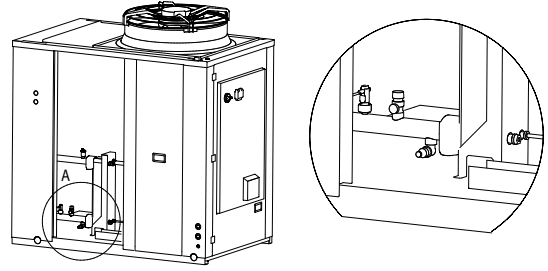

If the unit must be completely drained, first close the manual inlet and outlet shutters (not supplied) and then disconnect the pipes on the water inlet and outlet so that the liquid in the unit can drain (to make this operation easier, it is advisable to install two external drain cocks between the unit and the manual shutters on the water inlet and outlet).

When it is required to top up the circuit or to adapt the glycol level, please use the service valve. Unscrew and remove the cap from the service valve (A) and connect a 14 or 12 mm pipe (inside diameter - check the valve model installed on your unit), connected to the water mains, to the hose connector and then drain the circuit by unscrewing the specific ring nut (B). After the end of the operation, retighten the ring nut (B) and screw the cap back on (A). In any case it is recommended to use an external valve to fill the system which can be set up by the installer.



5.8.4 Service sleeves

The unit is fitted with an air venting valve to automatically remove air that has built up in the circuit, preventing undesirable effects such as premature corrosion and wear, lower performance and low exchange output.
The device also features a safety function because, in the event of exchanger breakdown, it allows the refrigerant gas to escape outside, preventing it from being conveyed to the internal terminals.
The valve can be kept in a closed position by closing the plug on the drain; by loosening the plug, the valve remains in open position and air is discharged automatically.



If you notice a water leak, you must replace the component by unscrewing it with a spanner, as shown in the image below.



5.9 ELECTRICAL CONNECTIONS

Check that the power supply matches the unit's electric nominal data (voltage, phases, frequency) displayed on the rating plate on the unit's side panel. The electric power connections must be made in accordance to the wiring diagram enclosed with the unit and in conformity with national and international standards (providing general circuit breaker, residual current devices for each line, proper earthing of the plant, etc.).



CAUTION: Before starting any operation, make sure that the power supply is disconnected.



CAUTION: Respect the minimum clearances to perform wiring.



CAUTION: The installer is responsible for the disconnection system (e.g. general circuit breaker) upstream of the electrical connections of the unit.



CAUTION: The supply voltage's fluctuations cannot exceed $\pm 10\%$ of the nominal value. If this tolerance should not be respected, please contact our technical department. The power supply must comply with the limits mentioned, otherwise the warranty will expire immediately.



CAUTION: If the supply cable is damaged, it must be replaced by qualified personnel, in order to prevent any risk.



CAUTION: Any devices placed nearby can cause / suffer electromagnetic disturbances to / from the unit. Be aware of this risk at the installation site. It is recommended to electrically power the unit with an adequate line and protections and use an independent cable duct.



CAUTION: The remote control panel is connected to the chiller by 4 cables with a cross-section of 1.5 mm². The power cables must be separate from the remote control cables. Maximum distance 50 metres.



CAUTION: The remote control panel must not be installed in an area with strong vibrations, corrosive gases, excessive dirt or high humidity. Leave the area near the cooling system clear.

2.2.2 Accesso al quadro elettrico

Il quadro elettrico è accessibile anche a macchina chiusa ed è posizionato dal lato compressori. Per poter aprire la porta del quadro è necessario posizionare in OFF il sezionatore e utilizzare una chiave a doppia aletta in entrambe le serrature presenti.

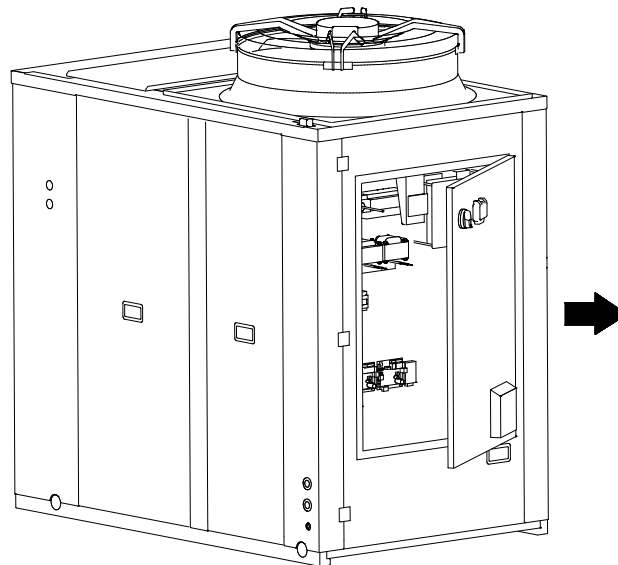

Power supply



The electrical wiring to the terminal blocks has to be done only by qualified personnel.



Make sure to install an adequate ground connection, incomplete grounding can cause electric shock. The manufacturer cannot be held responsible for any damage caused by failure or ineffective earthing.

The power cables, electrical protections and line fuses must be sized in accordance with what is reported in the unit's wiring diagram and in the electrical data contained in the technical characteristics table.

Use a dedicated power line, do not power the appliance through a line to which other users are connected. Fasten the power cables securely and make sure they do not come into contact with sharp corners. Use double insulated cables with copper wires.

The ground connection must be carried out first during the connection phase, vice versa it must be removed last when the unit is disconnected. In the event of any loosening of the power cable, it must be ensured that the tension of the active conductors takes place before that of the ground wire.

A main switch or a disconnection device with adequate breaking capacity must be installed on the power supply line, which has a separation of the contacts in all the poles. The differential protection switch must be compatible with inverter appliances, it is recommended to install a type B differential switch, the installation of a different type switch could give rise to untimely trips.

The following table shows the recommended cable sections for a maximum length of 30 m. In any case, depending on type of installation, the location and the length of the cables (be it less than or greater than 30 m), the electrical system designer will make an appropriate choice.

Power supply	Model	Recommended cable section (max length 30m)	Recommended tightening torque
50Hz 400V / 3ph + N +PE	HP_OWER 500RK-700RK	*5G16	L1/L2/L3: 3,4 Nm – N/PE: 1 Nm

(*) FG16 cable fixed in air at 30°C

The units conform to the specifications for electromagnetic compatibility, however, the designer of the electrical system must make appropriate assessments to ensure the absence of interference.

5.9.1 User terminal block

The connection terminal block is located under the machine cover. For access, see the instructions. The terminal block must be connected respecting the notes below.

The connections shown below are standard. Other connections are given in the MCO manual of the on-machine control (see "USER AND INSTALLER CONFIGURATION TABLES"), according to the configurations adopted.



CAUTION: It is important to keep the high voltage cables separated from the very low voltage ones.

Terminal	Connection	Type
PE	Connect the ground wire	Power input 3-Ph/N/PE, 400 Vac, 50Hz
N	Connect the neutral cable from the mains	Power input 3-Ph/N/PE, 400 Vac, 50Hz
L1	Connect L1 phase cable from the mains	Power input 3-Ph/N/PE, 400 Vac, 50Hz
L2	Connect L2 phase cable from the mains	Power input 3-Ph/N/PE, 400 Vac, 50Hz
L3	Connect L3 phase cable from the mains	Power input 3-Ph/N/PE, 400 Vac, 50Hz
XR+	Modbus RTU + signal connection for remote keyboard	Modbus communication RTU RS 485
XR-	Modbus RTU - signal connection for remote keyboard	Modbus communication RTU RS 485
XGND	Modbus RTU ground reference connection for remote keypad (GND)	Modbus communication RTU RS 485
XC1.1 / 1.2	Remote on/off unit (close=unit on / open=unit off)	Voltage free digital input
XC2.1 / 2.2	Remote summer/winter mode change input (to activate the function see the relative paragraph in the MCO manual)	Voltage free digital input
XC12.1 / 12.2	Analogic Input Temp DHW	Configurable analog input (sensor NTC-10KΩ a 25°C β3435)
XP10.1 / 10.2	DHW valve control (to activate the function see the relevant section in the MCO manual)	Voltage output 230Vac, 50Hz, 2A (AC1)
*XPE-1.1/1.2	Alarm signalling (to activate the function see the relevant section in the MCO manual)	Voltage output 230Vac, 50Hz, 2A (AC1)
*XPE-2.1/2.2	*Defrosting signal in progress (to activate the function see the relevant section in the MCO manual)	Voltage output 230Vac, 50Hz, 2A (AC1)
*XPE-3.1/3.2	*System season signal (to activate the function see the relevant section in the MCO manual)	Voltage output 230Vac, 50Hz, 2A (AC1)
*XPE-4.1/4.2	Double set-point / 3-way valve for radiant panels (to activate the function see the relevant section in the MCO manual)	Voltage output 230Vac, 50Hz, 2A (AC1)
*XPE-5.1/5.2	Double set-point / 3-way valve for radiant panels (to activate the function see the relevant section in the MCO manual)	Voltage output 230Vac, 50Hz, 2A (AC1)
*XCE 2.1 / 2.2	Second set-point call (to activate the function see the relative paragraph in the MCO manual)	Voltage free digital input
*XCE 4.1 / 4.2	Silent ventilation call (to activate the function see the relative paragraph in the MCO manual)	Voltage free digital input

5.10 FUNCTIONAL DIAGRAMS

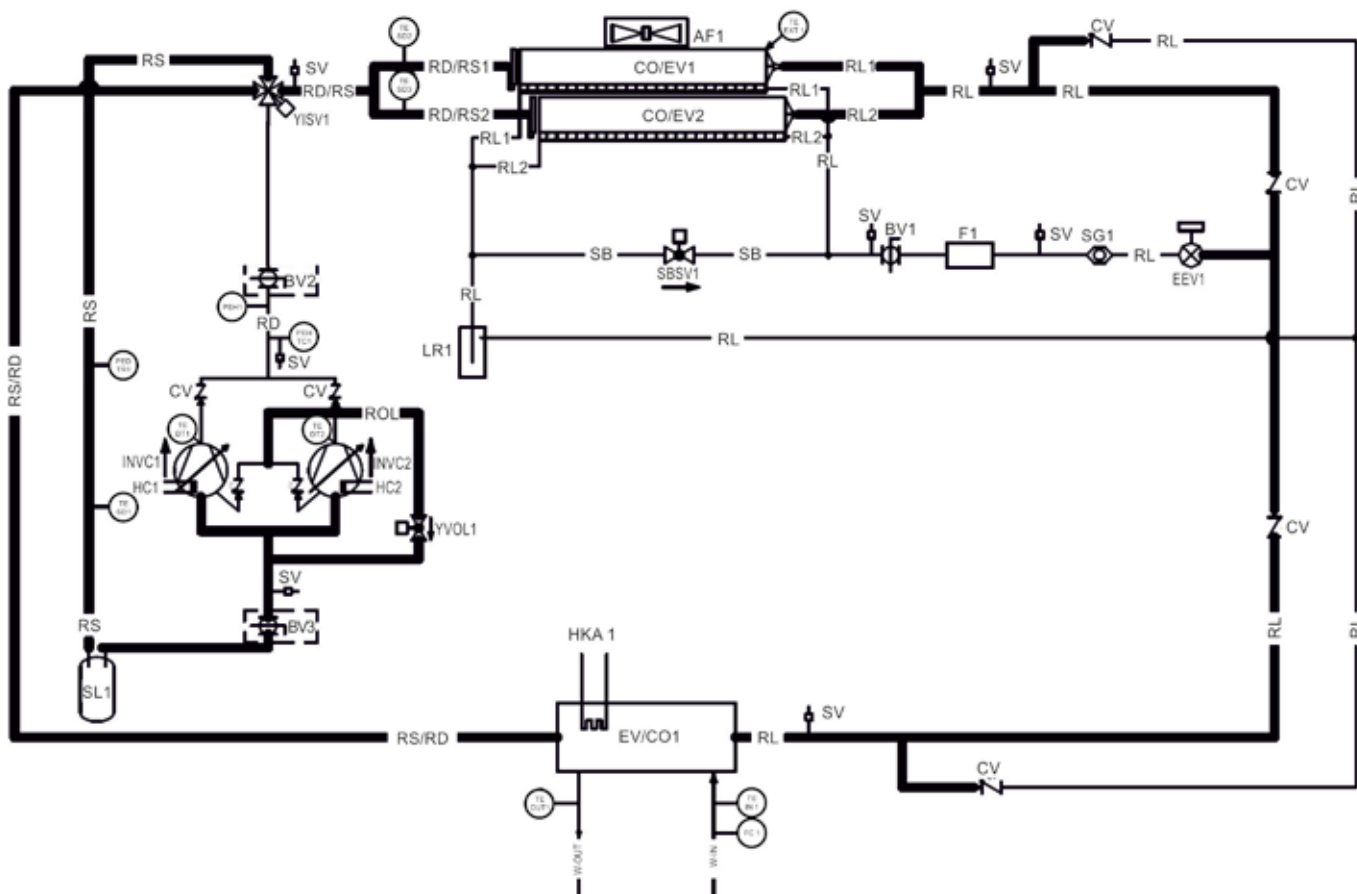

LEGEND					
INVC	1 / 2	VARIABLE SPEED COMPRESSOR	YVOL	1	OIL LINE EQUALIZATION SOLENOID
CO / EV	1 / 2	FINNED BATTERY	YISV	1	VALVE REVERSE CYCLE
EV/CO	1	PLATE EXCHANGER			
LR	1	LIQUID RECEIVER	SBSV	1	BYPASS LINE SOLENOID VALVE
SL	1	LIQUID SEPARATOR	SG		LIQUID AND MOISTURE INDICATOR
EVV	1	ELECTRONIC EXPANSION VALVE	PEH TC	1	HIGH PRESSURE TRANSDUCER
SV		CHARGING ATTACHMENT	PED TR	1	LOW PRESSURE TRANSDUCER
F	1	FILTER DRIER	PSH		HIGH-PRESSURE SWITCH
HC	1 / 2	CRANKCASE RESISTANCE	HKA	1	HEAT EXCHANGER ANTIFREEZE RESISTOR
AF	1	AXIAL FAN	TE SD	1/2/3	SUCTION TEMPERATURE PROBE
RD		SUCTION LINE	TE DT	1 / 2	EXHAUST TEMPERATURE PROBE
RD/RS		SUPPLY / SUCTION LINE	TE DS	1	TEMPERATURE PROBE (DS)
RL		LIQUID LINE	TE EXT	1	OUTDOOR AIR PROBE
RS		SUCTION LINE			
RS/RD		SUCTION/DELIVERY LINE			
ROL		DESUPERHEATER CIRCUIT CIRCULATOR			
SB		SUBCOOLING BYPASS LINE	W-IN		WATER INLET
BV	1/2/3	BALL VALVE	W-OUT		WATER OUTLET
		ACCESSORY INSTALLED ON BOARD	-----		INSULATED PIPES

6. START UP

Before start-up:

1. Check that the diagrams and manuals of the installed machine are available.
2. Check that the wiring and plumbing diagrams of the plant the machine is connected to are available.
3. Check that the shut-off valves of the water circuits are open.
4. Check that the water circuit was filled under pressure and the air vented.
5. Check that all the plumbing connections are installed correctly and that all the indications on the rating plates are complied with.
6. Make sure that measures have been taken to discharge condensate.
7. Check the electrical connection and correct fastening of all the terminals.
8. Check that the electrical connections have been made according to standards in force, including earthing.
9. Voltage must match that on the unit's rating plate.
10. Make sure that the electric voltage is within the tolerance limits ($\pm 10\%$).
11. Check that the electric heaters of the compressors are properly powered.
12. Check that there are no gas leaks.
13. Before switching the unit on, check that all panels are positioned correctly and well-fixed with screws.

	CAUTION: The unit must be connected to the electric mains and placed in STANDBY (powered on) by closing the master switch at least 12 hours before start-up. This will allow the heaters to adequately warm up the compressor crankcase (the heaters are powered automatically when the switch is closed). The heaters are working properly if after a few minutes the temperature of the compressor crankcase is 10-15°C higher than ambient temperature.
	CAUTION: Check that the weight of the pipes does not bear upon the machine structure.
	CAUTION: Never use the master switch to stop the unit temporarily. This must only be done to disconnect the unit from the power supply for long downtimes (e.g. seasonal stops etc.). Furthermore power is missing, the crankcase heaters will not be powered with the risk of breaking the compressors when the unit is switched on.
	CAUTION: Do not modify the electrical connections of the unit so as not to immediately terminate the warranty.
	CAUTION: Summer/winter operation must be selected at the start of the relative season. Frequent and sudden changes of this operation must be avoided so as not to damage the compressors.
	CAUTION: Upon initial installation and start-up, make sure that the machine works properly both in heating and cooling mode.

6.1 SWITCHING ON THE UNIT

To supply power to the machine, turn the external handle of the disconnecter to ON ("I").

The unit display only switches on if the phase sequence is correct (inspection to be made when commissioning the unit). Wait at least 1 minute between switching the unit off and back on again.

7. INSTRUCTIONS FOR THE USER

Write down the unit's identification data to be able to give it to the assistance centre when requesting an intervention.

	The identification plate applied on the machine has all of the technical and performance data of the appliance. In case of tampering, removal or deterioration, ask the Technical Assistance Service for a copy.
	Tampering, removal and deterioration of the identification plate complicates installation, maintenance and request for spare parts.

We recommend keeping track of the interventions carried out on the unit so as to make any troubleshooting easier.

In case of failure or malfunctioning:

- check the type of alarm triggered to report it to the assistance centre;
- contact an authorised assistance centre;
- if requested by the assistance centre, immediately deactivate the unit without resetting the alarm;
- request that original spare parts be used.

8. SHUTDOWNS FOR LONG PERIODS

The shutdown mode of the plant depends on the site of application and the time the plant is expected to be shut down. If the unit is equipped with the antifreeze system, even when off (system on unit at "off" position).



	The anti-freeze system remains in operation if the continuity of electrical supply to the appliances is guaranteed.
---	--

If the system is not to be used for an extended period of time it is recommended to empty the liquid from the system unless there is an adequate amount of glycol.













To switch off the unit completely after having emptied the system:

- Switch off the unit setting the switch of each appliance at "OFF".

- Close the water valves.
- Set the general residual current device at "OFF" (if installed upstream of the system).

	Se la temperatura scende sotto lo zero c'è serio pericolo di gelo: prevedere una miscela di acqua e glicole nell'impianto, diversamente svuotare l'impianto idraulico ed i circuiti idraulici della pompa di calore.
	ATTENZIONE: il funzionamento, seppur transitorio, con temperatura dell'acqua inferiore a +5°C non è garantito sulla base dei limiti stabiliti. Prima di riaccendere l'unità dopo uno spegnimento di lungo periodo, accertarsi pertanto che la temperatura del fluido sia superiore o almeno uguale a +5°C. Nelle versioni predisposte per il funzionamento a bassa temperatura (-8°C÷+4°C) si deve sempre verificare la concentrazione di glicole presente e il relativo punto di congelamento. Al di sotto di tale temperatura è vietato avviare l'unità.

9. MAINTENANCE AND PERIODIC CHECKS

	CAUTION: All the operations described in this chapter MUST BE CARRIED OUT BY QUALIFIED PERSONNEL ONLY . Before performing any intervention on the unit or accessing internal parts, make sure you have disconnected power.
	CAUTION: Before starting to operate, safety checks must be performed to ensure the combustion hazard is reduced to the minimum. The work must be undertaken according to a controlled procedure, to reduce to the minimum the risk of flammable gases or vapours while performing the work. The area must be checked with an appropriate refrigerant fluid detector before and during the work.
	Maintenance must only be carried out in weather conditions suitable for the operations envisaged.
	For maintenance, the use of a lock-valve (access valve to the refrigeration circuit) is strongly recommended, in order to avoid gas leaks and the risk of burns.
	CAUTION: It is possible that a certain quantity of oil from the compressor is deposited in the pipes of the refrigeration circuit, especially by bends. In case of maintenance operations in which it is necessary to unsolder the pipes, it is strongly recommended to proceed with the cutting of the same and not with the desoldering with a torch, as the flame triggers any oil present.
	It is prohibited to fill the refrigerant circuits with a refrigerant other than that indicated on the identification plate. Using a different refrigerant can cause serious damage to the compressor.
	It is prohibited to use oils other than those indicated in this manual. Using a different oil can cause serious damage to the compressor.
	The heads and delivery pipe of the compressor are normally quite hot.
	Be careful when working near the condensing coils. The aluminium fins are very sharp and can cause serious injuries.
	Always use appropriate personal protective equipment.
	After maintenance operations, close the panels again, securing them with the fixing screws. Pay particular attention to the correct closing of the electric box.
	After the maintenance operations, pay attention to the correct tightening of the cable gland designed for the passage of the electric power cable.
	It is recommended to have specialised personnel perform periodical inspections and maintenance. The EU regulation n.517/2014 establishes that users must perform regular inspections on the plants, checking water tightness and eliminating any leaks as quickly as possible. Verify the mandatory nature and the documentation required in regulation n.517/2014 and its subsequent amendments or repeals.

The following are the recommended and mandatory activities for correct operation of the unit. The mandatory activities must be carried out by an authorised customer service which issues a corresponding certificate. Failure to comply with these activities will entail forfeiture of the

warranty and could considerably shorten the service life of your product.

OPERATION	M / R
Filling the water circuit.	R
Presence of bubbles in the water circuit.	R
Check the proper working of the safety and control devices.	M
Check that there are no oil leaks from the compressor.	R
Check if there is a possible water leakage from the water circuit.	R
Check that the flow switch works properly.	M
Check that the crankcase heaters are powered and running.	R
Clean the metal filters of the water circuit.	M
Clean the finned coil with compressed air or water jet.	R
Check that the electric terminals both inside the electric panel and in the terminal blocks of the compressor are well tightened.	M
Tightening of plumbing connections.	R
Check fixing and balancing of the fans.	R
Clean the air filters in the electrical panel or replace them if necessary.(when present).	M
Correct electrical voltage and phase imbalance (without load and under load).	R
Correct absorption.	R
Check the refrigerant charge and eventual refrigerant leaks.	M
Check the operating pressure, superheating and sub-cooling.	R
Circulation pump efficiency.	R
If the unit is to be out of service for a long period, drain the water from the pipes and the heat exchanger. This operation is indispensable if, during the shutdown period, ambient temperatures are expected to be below the freezing point of the fluid used.	M
Check the presence of corrosion/oxidation.	R
Check panel fastening.	R
Check the water quality (see chapter Characteristics of the system water) and the possible concentration of glycol.	M
Check the pressure drop of any filter driers on the liquid line.	R
Check the hydronic side safety valve in accordance with EN 806-5.	R

9.1 GENERALITY

To correctly clean the coil, follow the instructions below:

- Remove any superficial filth. Debris such as leaves, fibres etc. must be removed without a vacuum cleaner (use a brush or another soft tool carefully avoiding scratching with metal or abrasive parts). If you use compressed air, pay attention to keep the air flow perpendicular to the surface of the coil in order not to bend the aluminium fins. Pay attention not to bend the fins with the nozzle of the compressed air lance.
- Rinse. Rinse with water. It is possible to use chemical substances (specific detergents for finned coils). Rinse the coils by letting the water run inside each individual passage of the fins, until they are perfectly clean. Pay attention to direct the water jet perpendicular to the surface of the coil in order not to bend the aluminium fins. Do not strike the coil with the water hose. Apply your thumb at the end of the hose to increase the pressure of the water jet instead of using specific nozzles which could damage the coil.

9.1.1 Cleaning the filled coil treated with the anti-corrosion method

The anti-corrosion treatment applied to the finned coils (available as an alternative to the standard coils) guarantees protection against aggressive atmospheres.

The frequency of cleaning depends on the environmental conditions and is left to the common sense of the maintenance staff. When oxidizing dust or grease particles are observed on the battery surface, cleaning is recommended. In general, in a slightly polluted atmosphere, it is recommended to carry out the cleaning treatment every three months.

Washing should be carried out with preferably hot water (40-60 °C) and detergent with neutral pH, while rinsing is carried out with abundant fresh water (50 l / m²).

If the maintenance staff observes a lack of protective cover on the edge of the fins, it is necessary to contact the nearest service center to proceed with a new application of the cover and completely restore the protection against corrosion.



CAUTION: Do not clean the coil using high-pressure cleaners so as not to apply excessive pressure which could cause irreparable damage. Damage caused by cleaning with unsuitable chemical substances or excessively high water pressure will not be recognised under warranty.

CAUTION: The aluminium fins are thin and sharp. Pay the utmost attention and use appropriate PPE to avoid cuts and abrasions. Cover your eyes and face appropriately to avoid squirting water and filth while blowing. Wear waterproof shoes or boots and clothing covering your entire body.

For units installed in an aggressive atmosphere with a high rate of fouling, cleaning of the coil should be part of the routine maintenance programme. On this type of installation, all dust and particles deposited on the batteries must be removed as soon as possible by periodic cleaning in accordance with the above instructions.

9.2 CLEANING OF EXTERNAL SURFACES

The sheets of the outer casing must be properly cleaned to avoid the accumulation of dust / dirt, preventing the onset of corrosion. The painting ensures resistance to atmospheric agents but it is good practice to make sure to remove any dirt present, cleaning the surfaces with neutral detergent and water, especially if the unit is installed in places with an aggressive atmosphere (high level of pollution, salt, etc).

9.3 EXTRAORDINARY MAINTENANCE

All extraordinary maintenance jobs must be carried out by an authorised assistance centre.

Some extraordinary maintenance works may involve the replacement of broken components, which may have significant mass. Below is the list of components (standard and optional) and the approximate weight for each piece (take into consideration that any residues of oil, liquid gas, water can increase the weight). Consult the table before the maintenance phase (or refer to the label of the component itself) and choose the equipment / posture most suitable for the work to be carried out taking into account the load limits imposed by the technical standards and the state of health and ability of the worker himself.

Weight [kg]		
Component	HP_OWER 500 RK	HP_OWER 700 RK
Compressor	40,1	40,6
Plate exchange coil	25	35
Cu-Al heat exchange coil	41,8	54
Liquid receiver	2,7	5
Liquid separator	5,5	7,1
Pump AC 400	16,4 / 29	17,9 / 29
Vacuum tank	63	63
Vacuum expansion vessel	4	4
Fan std / SSL	47 / 41	52 / 44
Driver compressor	12	12



10. DECOMMISSIONING

Once the unit has reached the end of its life cycle and needs to be replaced, the following operations are recommended:

- the refrigerant has to be recovered by trained personnel and sent to proper collection centres; according to the procedures indicated in Regulation No. 517/2014 on fluorinated greenhouse gases;
- any antifreeze additives in the water circuit must be recovered and disposed of properly;
- the compressors' lubricating oil has to be collected and sent to proper collection centres;
- electronic components such as regulators, driver boards and inverters should be dismantled and sent to collection centres;
- the structure and the different components, if unusable, must be scrapped and divided according to their nature; there is especially a good amount of copper and aluminium in the machine.

These operations allow easy material recovery and the recycling process, thus reducing the environmental impact in accordance with the provisions of Directive 2012/19 / EU on waste electrical and electronic equipment (RAEE).

The user is responsible for the proper disposal of this product, according to national regulations in the country of destination of the appliance. For more information you should contact the Installation Company or local competent authority.

	An incorrect decommissioning of the appliance may create serious environmental damage and endanger people's safety. Therefore, it is recommended that the unit be disposed only by authorised persons with technical training who have attended training courses acknowledged by the competent authorities.
	It is required to follow the same precautions described in the previous paragraphs.
	Pay special attention during disposal of the refrigerant gas.
	The illegal disposal of the product by the end user leads to the application of the penalties in accordance with the law in the country where the disposal takes place.
	The crossed-out bin symbol applied on the appliance indicates that the product, at the end of its useful life, must be collected separately from other solid/municipal waste. The units are manufactured in accordance with the EC directive on waste of electric/electronic equipment and the harmful effects of incorrect disposal are provided in the user/installer manual. The manufacturing company or its importer/retailer is available to respond to any requests for additional information.

11. RESIDUAL RISK

The residual risks related to handling, installation and normal operation of the unit are shown below. Any failure by the user and installer to comply with the instructions / indications given in the manual (for which the references are given in the table) entails the persistence of these risks, which cannot be eliminated by the manufacturer, who has already adopted all the necessary design measures because each risk is minimized.

Danger	Indication / Instruction	Residual risk	User / Activity				
			Operator			User	
			Transport phase	Installation phase	Maintenance phase	Unit interaction	Normal unit operation
Mechanical: crushing caused by the possible instability of the unit during handling	The procedures for correct unit handling and installation are indicated on the user-installer manual under chapter 5, with indication of the center of gravity, of the lifting points and equipment. Protection devices use is also recommended as required by current regulations.	Failure by the installer to comply with the installation procedures.	X	X			
Mechanical: crushing caused by the possible instability of the unit.	The procedures for proper unit installation are indicated on user-installer manual under chapter 5.	Failure by the installer to comply with the installation procedures.		X	X		
Mechanical: Cutting / sectioning / shearing caused by the fan not protected against accidental contacts	The user-installer manual under chapter 9 contains specific warnings, also relating to the routine maintenance phases.	Removal of the protective grille by the user or maintenance technician.			X	X	
Entanglement caused by the fan not protected against accidental contacts	The user-installer manual under chapter 9 contains specific warnings, also relating to the routine maintenance phases.	Removal of the protection grid by the user or maintenance technician.			X	X	
Mechanical: cutting / abrasion due to contact with the heat exchange coil	The user-installer manual under chapter 9 contains specific warnings to be taken into consideration when working near the battery.	Failure to observe the warnings in the manual and on the label.			X	X	
Mechanical: slipping / falling caused by ice / water near the unit as a result of water leaks	In the user-installer manual under paragraph 5.8 is recommended to pay attention to the conveyance of the safety valve and in paragraph 5.4 there are indications regarding the surface on which the unit rests. During maintenance, the use of PPE and the possible removal of all water residues near the machine after intervention is recommended.	Failure to comply with the instructions given in the manual.			X	X	

Danger	Indication / Instruction	Residual risk	User / Activity				
			Operator			User	
			Transport phase	Installation phase	Maintenance phase	Unit interaction	Normal unit operation
Mechanical: cut / abrasion caused by the presence of edges on the external casing of the machine and / or screws protruding both outside and inside the unit	The correct maintenance procedures are indicated in the user-installer manual under chapter 9. Paragraph 4.2 recommends the use of the necessary personal protective equipment.	Failure to comply with the procedures and / or failure to use PPE by the maintenance technician			X	X	
Mechanical: projection of parts or fluids caused by exceeding the operating pressure limits.	The correct maintenance procedures are indicated in the user-installer manual under chapter 9. Paragraph 4.2 recommends the use of the necessary personal protective equipment.	Simultaneous damage to both types of protection devices.			X	X	
Mechanical: Entrapment due to closure of access panel with person inside.	The unit has a square floor plan and the interior is clearly visible.	Lack of control at closure, but this is considered improbable considering the plan and dimensions of the unit.			X		
Mechanical: Pressure, impact due to the open door accidentally moving.	Paragraph 4.2 recommends the use of appropriate personal protective equipment. And in paragraph 5.7 the risk to the operator is highlighted.	Non-observance of procedures by the maintenance technician or behaviour			X		
Mechanical: Cut/abrasion caused by the fins of the inverter heat sinks.	Section 4.2 recommends the use of appropriate personal protective equipment.	Failure of the maintenance technician to use PPE.			X		
Electrical: electrocution / shock / burn caused by contact with live parts.	The safety measures to be taken in case of maintenance, cleaning or checking of the unit are indicated in the user-installer manual under chapter 9. Any intervention must only be carried out by qualified personnel and with the machine switched off.	Failure to comply with the procedures by the maintenance technician or irresponsible behavior by the user.			X	X	
Electrical: effects on medical implants (pacemakers) caused by electromagnetic phenomena	The user-installer manual in chapter 3 states the prohibition of direct interaction with the unit by people with electrically controlled medical devices, such as pacemakers. It is recommended to keep a distance from the installation site of the unit as indicated by the medical system used.	Failure to comply with the instructions given in the manual.			X	X	
Electrical: Fire causes short circuit or electric arc.	The correct installation procedures are indicated in the user-installer manual under chapter 5. In case of maintenance, the use of the necessary personal protective equipment is recommended.	The possibility of triggering cannot be eliminated but its probability of occurrence is reduced. With the measures taken, the spread of the fire is reduced.			X	X	
Electrical: projection of particles and emission of harmful chemicals as a result of electrical overload	Chapter 9 in the user-installer manual indicates that maintenance must be carried out with machine off.	Failure to comply with the instructions given in the manual.			X	X	
Thermic: burning / scalding from contact with hot surfaces	The user-installer manual in chapter 9 indicates the safety measures to be adopted in case of maintenance, cleaning or control of the unit and the personal protective equipment to be equipped.	Failure to comply with the procedures and / or failure to use PPE by the maintenance technician.			X	X	
Caused by noise: Discomfort caused by the noise of the unit during operation	In the user-installer manual in chapter 5 suspended installation is prohibited and an environmental impact assessment is requested based on the installation area of the unit, even in the case of installation close to workers.	Failure to observe the actions recommended in the manual and the study of the environmental impact.					X
Cause by vibration: Discomfort caused by unit vibrations during operation	In the user-installer manual under chapter 5 suspended installation is prohibited and the use of anti-vibration mounts is recommended.	Failure to observe the actions recommended in the manual and the study of the environmental impact.					X

Danger	Indication / Instruction	Residual risk	User / Activity					
			Operator			User		
			Transport phase	Installation phase	Maintenance phase	Unit interaction	Normal unit operation	
Caused by radiation: electromagnetic radiation that the unit generates during operation	-	No one						X
Generated by materials / substances: infections caused by bacteria potentially present in the carrier fluid (technical water)	The use of personal protective equipment is recommended in the user-installer manual under paragraph 4.2. The safety data sheet for the refrigerant (paragraph 4.4) and specific warnings (paragraph 4.5) are also shown.	Failure to comply with the procedures by the maintenance technician.			X	X		
Generated by materials / substances: fire / explosion causes gas classified as slightly flammable	The user-installer manual under chapter 5 contains specific indications about unit installation place and protection devices.	Failure to comply with the indications relating to the place of installation and adequate maintenance procedures			X			X
Generated by materials / substances: infections caused by bacteria potentially present in the carrier fluid (technical water)	The permitted uses of the unit are listed in the user-installer manual under chapter 3.	Failure to comply with the instructions given in the manual.			X			X
Generated by materials / substances: burn caused by the presence of oil inside the refrigeration circuit, triggered by a flame welding torch	The use of personal protective equipment is recommended in the user-installer manual under paragraph 4.2. Under chapter 9 it is advisable, in the case of maintenance that involves desoldering the tubes, to proceed with cutting them, as the flame of the torch for desoldering triggers any oil present.	Failure to comply with the instructions given in the manual.			X			
Generated by materials / substances: burn / scald from escaping refrigerant	The safety measures to be adopted in case of maintenance, cleaning or control of the unit and the personal protective equipment to be equipped are indicated in the user-installer manual under chapter 9.	Failure to comply with the instructions given in the manual.			X			X
Generated by materials / substances: pollution due to inappropriate disposal	The instructions for correct disposal are given in the user-installer manual under chapter 10.	Failure to comply with the instructions given in the manual.						
Ergonomic: fatigue / musculoskeletal disorders caused by exertion during maintenance / installation	Under paragraph 4.1, the user-installer manual recommends compliance with current regulations (international and local) regarding workers health and safety. During maintenance, it is advisable to keep a posture that does not cause fatigue and to check the weight of the component before proceeding with its handling (paragraph 9.3).	Failure to comply with the instructions given in the manual.		X	X			
Generated by unit use environment: Slipping / falling caused by ice / water near the unit due to condensate drain / defrost	Under paragraph 5.8.5 the user-installer manual indicates about condensate drain system, recommending that you pay attention to the danger of slipping.	Failure to comply with the instructions given in the manual.			X	X		
Generated by unit use environment: unexpected events as a result of malfunctions due to water / snow / humidity.	In the user-installer manual under chapter 9 it is recommended to pay attention to the correct tightening of the cable gland designed for the passage of the electric power cable and to the reassembly of all the sheets, in particular those of the electrical panel, in order to maintain the degree of declared protection.	Failure to comply with the procedures by the maintenance technician.			X	X		

Danger	Indication / Instruction	Residual risk	User / Activity				
			Operator			User	
			Transport phase	Installation phase	Maintenance phase	Unit interaction	Normal unit operation
Generated by unit use environment: lightning that can potentially hit the unit	In the user-installer manual under chapter 9 it is recommended to carry out maintenance only in weather conditions suitable for the operations envisaged. It is also indicated that the installation site must be sufficiently far from lightning rods or objects that could attract the lightning (par. 5.3). The unit must be electrically connected to a system that complies with the regulations in force.	Failure to comply with the instructions given in the manual.			X	X	
Generated by unit use environment: electromagnetic disturbances caused by interference between devices placed near the machine and the machine itself.	In the user-installer manual under paragraph 5.9 is recommended to power the unit via a dedicated line and protections. It is also recommended to use an independent cable duct in order to remove the possibility of interaction with other devices.	Failure to comply with the recommendations regarding the electrical system.					X
Generated by unit use environment: possibility of breakage of components / supports caused by corrosion and oxidation.	The user-installer manual under chapter 9 contains specific warnings on maintenance and cleaning to be carried out on the surfaces of the sheets and heat exchange coils. The technical bulletin provides advice on the treatments to choose based on the environmental conditions.	Failure to comply with cleaning and maintenance and / or incorrect assessment of the atmospheric agents that characterize the installation site.			X	X	
Generated by the operating environment of the machine: slipping/falling caused by ice/snow on the base of the unit.	In the user-installer manual in section 4.2 the use of personal protective equipment is recommended. In the user-installer manual in chapter 9 it is recommended that maintenance should only be carried out in weather conditions suitable for the intended operations.	Failure to comply with cleaning and maintenance and / or incorrect assessment of the atmospheric agents that characterize the installation site.			X		
Generated by the operating environment of the machine: Heat stroke due to high temperatures inside the machine if it is hot, the unit is working in a chiller and is located in a particularly sunny area.	In the user-installer manual in section 4.2 the use of personal protective equipment is recommended. In the user-installer manual in chapter 9 it is recommended that maintenance should only be carried out in weather conditions suitable for the intended operations.	Failure to comply with cleaning and maintenance and / or incorrect assessment of the atmospheric agents that characterize the installation site.			X		

12. TECHNICAL DATA

12.1 TECHNICAL SHEET HEAT PUMP

Performance referring to the following conditions, according to standard 14511:2018:

- (1) Cooling: outdoor air temperature 35°C; in/out water temperature 12/7°C.
 - (2) Cooling: outdoor air temperature 35°C; in/out water temperature. 23/18°C.
 - (3) Heating: outdoor air temperature 7°C b.s. 6°C b.u.; in/out water temperature 30/35°C.
 - (4) Heating: outdoor air temperature 7°C b.s. 6°C b.u.; in/out water temperature 40/45°C.
 - (5) Cooling: in/out water temperature 12/7°C.
 - (6) Heating: Average climatic conditions; $T_{biv} = -7^\circ\text{C}$; low temperature.
 - (7) Figures are approximate and subject to change. Always refer to the technical label on the unit for the correct figure.
 - (8) The volume indicated refers to the total required, the designer must meet it considering the quantity already present inside the unit depending on the hydronic kit chosen (please check this value in the data sheet).
 - (9) Sound power: condition (3); value determined on the basis of measurements made in accordance with UNI EN ISO 9614-1, in compliance with the requirements of Eurovent certification.
 - (10) Sound pressure: value calculated from the sound power level using ISO 3744: 2010, considering units operating in open field
 - (12) Heating: outdoor air temperature 7°C b.s. 6°C b.u.; in/out water temperature 47/55°C.
- (*) by activating the "maximum Hz" function

N.B. Performance data are indicative and are subject to change. Furthermore the performance declared in points (1), (2), (3), and (4) is intended to refer to instantaneous power according to UNI EN 14511. The value declared in point (5) and (6) is determined according to UNI EN 14825.

TECHNICAL CHARACTERISTICS		Unit	HP_POWER R	
			500RK - 500RK A400	700RK - 700RK A400
Cooling	Cooling capacity (1) min/nom/max	kW	20,1/36,3/41,2*	27,1/53,2/58,2*
	Power input (1)	kW	11,7	17,7
	E.E.R. (1)	W/W	3,10	3,01
	Cooling capacity (2) min/nom/max	kW	31,2/55,3/62,3*	38,5/66,0/73,8*
	Power input (2)	kW	13,0	16,6
	E.E.R. (2)	W/W	4,25	3,98
	SEER (5)	W/W	4,72	4,85
	Water flow (1)	L/s	1,74	2,55
Heating	Heating capacity (3) min/nom/max	kW	24,1/50,2/56,3*	39,9/66,8/74,6*
	Power input (3)	kW	12,2	16,3
	C.O.P. (3)	W/W	4,11	4,10
	Heating capacity (4) min/nom/max	kW	22,8/49,7/55,9*	32,1/66,6/75,5
	Power input (4)	kW	15,4	20,4
	C.O.P. (4)	W/W	3,23	3,26
	Heating capacity (12) min/nom/max	kW	22,4/48,3	34,8/62,0
	Power input (12)	kW	18,0	23,8
	C.O.P. 12)		2,68	2,61
	SCOP (6)	W/W	4,16	3,94
	Water flow (4)	L/s	2,38	3,19
	Energy efficiency - water 35°C / 55°C	Classe	A++ / A+	A++ / A+
Compressor	Type		Scroll DC Inverter	
	Quantity		2	2
	Refrigerant oil (type)		FW68S	FW68S
	Refrigerant oil (quantity)	mL	3800	3800
	Refrigerant circuits		1	1
Refrigerant	Type			
	Refrigerant quantity (7)	kg	9,5	12,0
	Refrigerant quantity in tonnes of CO2 equivalent (7)	ton	6,4	8,1
	Design pressure (high/low) heat pump mode	bar	46/ 27,6	
	Design pressure (high/low) chiller mode	bar	46 / 27,6	
External zone fans	Type		EC	
	Quantity		1	
	Nominal power (1)	kW	1,95	3,1
	Maximum power input	kW	1,95	3,1
	Maximum current input	A	4,8	4,8
	Nominal air flow	L/s	5431	5547
Internal heat exchanger	Internal heat exchanger type		A piastre / BPHE	
	N° internal heat exchanger		1	1
	Water content	L	3,54	5,12
Hydronic circuit	Useful head (1) (**)	kPa	138	151
	Useful head (4) (**)	kPa	109	122
	Water content of the hydronic circuit	L	7	9
	Maximum pressure hydronic kit (safety valve setting)	bar	6	6
	Grooved water connections	inch	1" 1/2 (DN 40)	1" 1/2 (DN 40)
	Minimum water volume (8)	L	239	322
	Nominal pump power (1)	kW	0,75	1,10
	Maximum pump power input	kW	1,04	1,35
	Maximum pump current input	A	1,86	2,45
Noise	Sound power level Lw (9)	dB(A)	83	84
	Sound power level Lw SLNconfiguration (9)	dB(A)	81	82
	Sound power at 1 m / 10m (10)	dB(A)	65,4/51,2	66,4/52,2
	Sound power at 1 m / 10m version SLN (10)	dB(A)	63,3/49,2	64,3/50,2
Electrical data	Power supply		400V/3P+N+T/50Hz	
	Maximum power input	kW	33	43
	Maximum current input	A	52	68
	Max. power input with antifreeze kit	kW	34	43
	Max. current input with antifreeze kit	A	54	70

12.2 UNIT AND AUXILIARY ELECTRICAL DATA

Unit power supply	V/~ / Hz	400/3PH+PE/50
On board controller circuit	V/~ / Hz	12/1/50
Remote controller circuit	V/~ / Hz	12/1/50
Fan power supply	V/~ / Hz	400/3PH+PE/50

NOTE: The electrical data are subject to change due to updates. It is therefore always necessary to refer to the technical specifications label applied on the right side panel of the unit.

12.3 DATA OF THE HYDRONIC GROUP

12.3.1 CORRECTIVE FACTORS

12.3.2 CORRECTION FACTORS FOR USE OF WATER-GLYCOLE MIXTURE

The correction factors for water flow rate and pressure drop must be applied to the values obtained without the use of glycol. The correction factor for water flow rate shall be calculated to maintain the same temperature difference as would be obtained without the use of glycol. The pressure drop correction factor is applied to the water flow rate value corrected by the water flow rate correction factor.

Percentage of glycol	Freezing point [°C]	Yield corrector factor	Absorbed power correction factor	Water flow correction factor	Pressure drop correction factor
10%	-3,2	0,985	1	1,02	1,08
20%	-7,8	0,98	0,99	1,05	1,12
30%	-14,1	0,97	0,98	1,10	1,22
40%	-22,3	0,965	0,97	1,14	1,25
50%	-33,8	0,955	0,965	1,2	1,33

12.3.3 SCALING CORRECTION FACTOR

The correction factors due to contamination of the internal gas/water exchanger are shown below.

m ² °C/kW	Power output correction factor	Power input correction factor
0,44 x 10 ⁻¹	1,00	1,00
0,88 x 10 ⁻¹	-0,99	1,00
1,76 x 10 ⁻¹	0,98	1,00

12.3.4 CALIBRATIONS AND PROTECTIONS CONTROL

Description	Value
Low pressure switch	46 bar
High pressure alarm	40 bar
Low pressure alarm	1,3 bar heating / 3,5 bar cooling
Maximum number of restarts/hour after high/low pressure (manual reset)	3
Antifreeze protection (standard version)	+3 °C
Hydronic circuit safety valve	6 bar

Check that the antifreeze mixture concentration is suitable for the freezing temperature.

12.3.5 CORRECTION FACTORS DEPENDING ON ALTITUDE

Altitude [m]	500	1000	1500	2000
Correction factor heat output	0,9964	0,9941	0,9888	0,9869
Correction factor power input in heating mode	0,9931	0,9841	0,9853	0,9755
Correction factor cooling capacity	0,9888	0,9762	0,9618	0,9466
Correction factor power input in cooling mode	1,0106	1,0235	1,0386	1,0560

12.3 OPERATING LIMITS

12.4 EVAPORATOR WATER FLOW RATE

The nominal water flow rate refers to a 5°C temperature difference between the evaporator inlet and outlet. The maximum permitted flow rate features a 3°C temperature difference while the minimum one has an 8°C temperature difference at the nominal conditions as shown in the technical sheet.

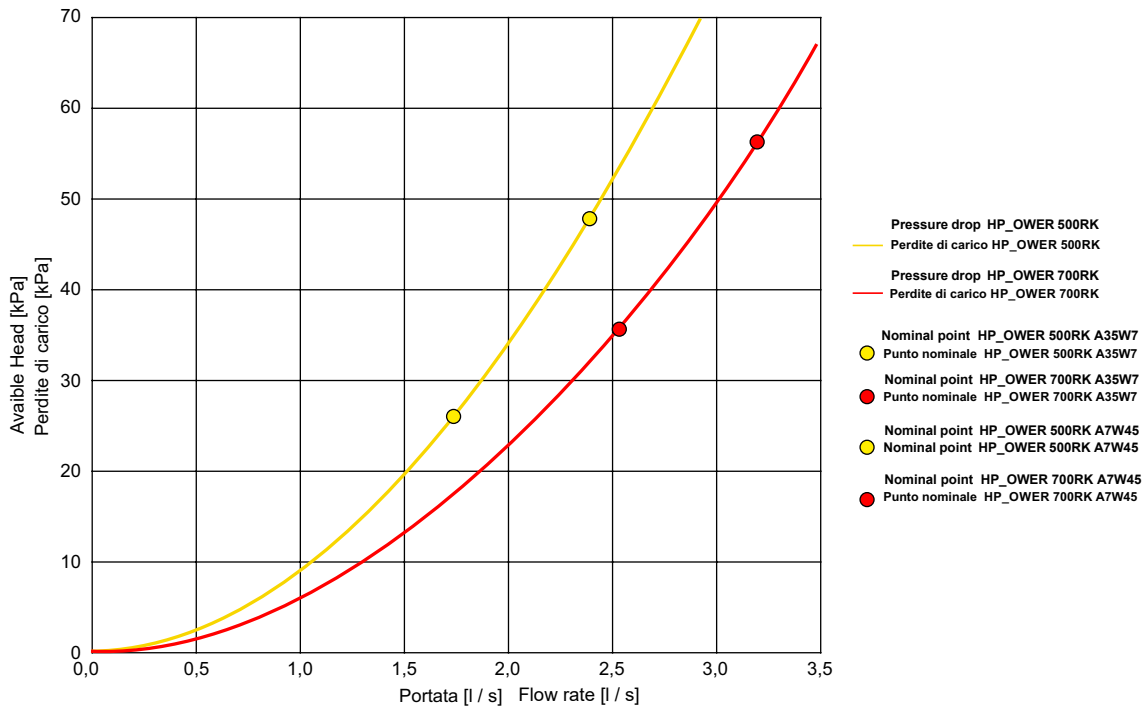

12.5 FLOW RATE

The head-flow characteristic curves are shown below, net of the pressure drops of the hydronic kit. The optimum working point is highlighted on each curve under the conditions specified at the apex (1) and (4) shown in the technical data table. The installation must be designed in such a way as to guarantee the flow rate relative to the points

HP_OWER 500 RK	
Flow rate [l/s]	Available head unit [kPa]
0,5	170
0,7	165
0,8	165
1,0	161
1,1	158
1,3	153
1,4	149
1,6	143
1,8	138
1,9	131
2,1	125
2,2	117
2,4	110
2,5	101
2,7	93
2,8	83

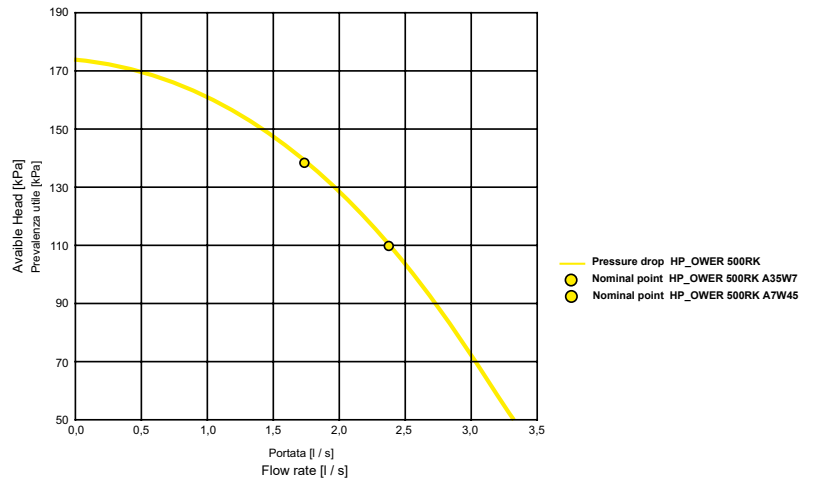

HP_OWER 700 RK	
Flow rate [l/s]	Available head unit [kPa]
0,5	200
0,8	197
1,1	193
1,3	188
1,6	181
1,9	173
2,2	164
2,5	154
2,8	143
3,0	130
3,3	116
3,6	101
3,9	85
4,2	67
4,4	48
4,7	28

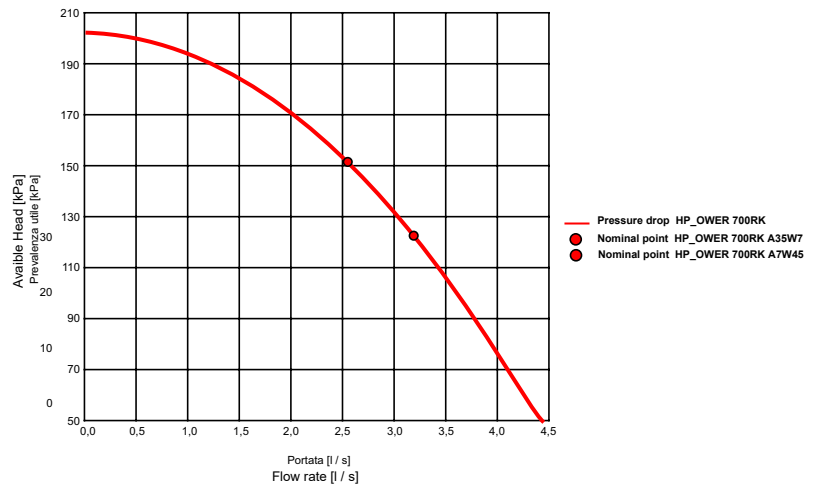

12.6 CURVE DELLE POMPE

Range of useful heads that the machine guarantees during pump modulation (in case of accessory chosen)

HP_OWER 500RK
Operating area of the pump

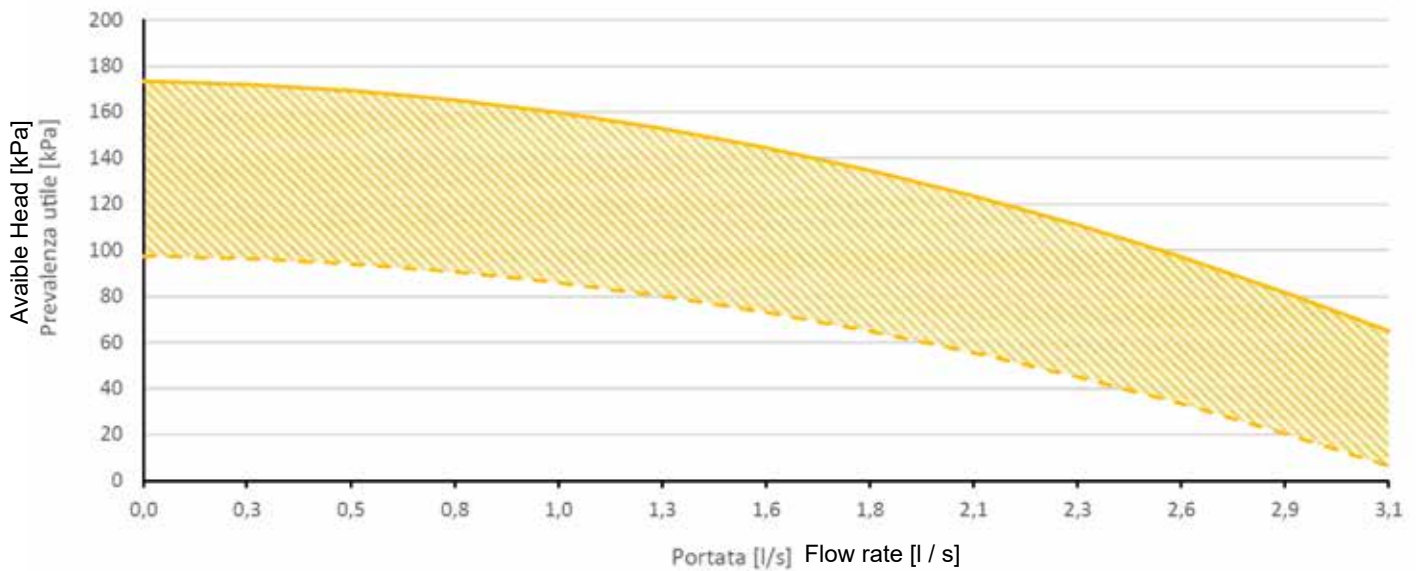

HP_OWER 700RK
Operating area of the pump

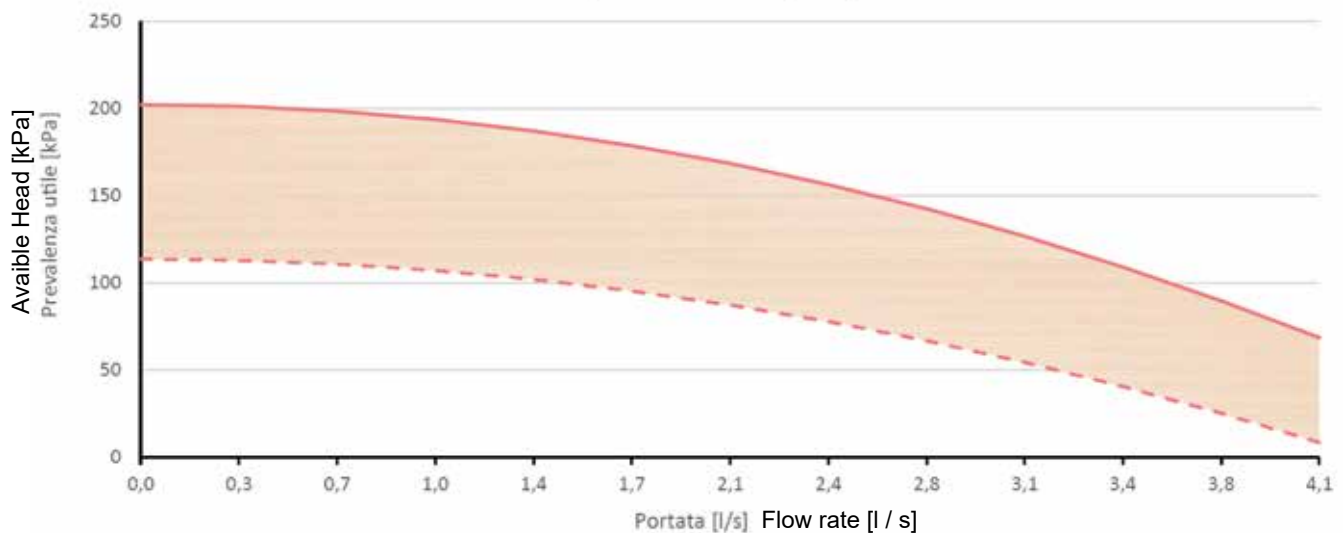

13. OPERATING LIMITS

13.1 EVAPORATOR WATER FLOW RATE

The nominal water flow rate refers to a 5°C temperature difference between the evaporator inlet and outlet. The maximum permitted flow rate features a 3°C temperature difference while the minimum one has an 8°C temperature difference at the nominal conditions as shown in the technical sheet.



Insufficient water flow rates can cause excessively low evaporation temperatures causing the safety devices to trigger and stopping the unit and, in some extreme cases, forming ice in the evaporator and resulting in serious failures to the cooling circuit.

For greater details, we have attached a table below with the minimum flow rates for the plate heat exchanger to guarantee proper operation according to the model (please note: the water flow switch is applied to protect against failed triggering of the antifreeze probe due to the lack of flow but does not guarantee the minimum water flow rate required for correct operation of the unit).

Model		
	500 RK	700 RK
Minimum water flow to be assured in chiller mode (condition (1) technical sheet) [l/s]	1,1	1,6
Maximum water flow to be assured in chiller mode (condition (1) technical sheet) [l/s]	2,9	4,2
Minimum flow switch water flow rate* [l/s]	0,77	0,92
Maximum flow switch water flow rate* [l/s]	0,80	0,95

* When the flow rate drops below the indicated limit (flow switch minimum water flow rate) the flow switch issues an alarm, which may be reset only upon reaching the maximum indicated flow rate.

13.2 COLD WATER PRODUCTION (SUMMER MODE)

A minimum temperature of 5°C is allowed at the evaporator outlet for standard units. For BT units (low temperature) minimum temperature is -8°C. In this case glycol water must be used. A maximum temperature of 20°C can be maintained at the evaporator outlet in steady-state operation.

13.3 HOT WATER PRODUCTION (WINTER MODE)

When the system has reached steady state, the water inlet temperature must not drop below 20°C: lower values, not due to transient phases or reaching steady-state, can cause system failures and could possibly break the compressor. The maximum outlet water temperature must not exceed 58°C. Temperatures higher than those indicated, especially in conjunction with low water flow rates, could result in malfunctioning of the unit, or in the most critical cases safety devices could be triggered.

13.4 AMBIENT AIR TEMPERATURE AND SUMMERISED TABLE

The units are designed and built to operate in summer mode, with condensation control, at outdoor air temperatures between -10°C and 46°C. In heat pump mode, the allowed temperature range of the outdoor air is from -19°C to +39°C depending on the outlet water temperature as shown in table below.

Operating limits

Water chiller mode		
Room temperature	Minimum -10 °C	Maximum +46 °C
Water outlet temperature	Minimum +5°C	Maximum +20°C
Heat pump mode		
Room temperature	Minimum -19 °C	Maximum +20°C
Outlet water temperature	Minimum +25 °C	Maximum +58 °C

Heat pump mode for domestic hot water 700 RK		
Room temperature with water at maximum +58 °C	Minimum -8 °C	Maximum +24 °C
Room temperature with water at maximum +50 °C	Minimum -12 °C	Maximum +39 °C
Outlet water temperature	Minimum +25 °C	Maximum +58 °C

Heat pump mode for domestic hot water 500 RK		
Room temperature with water at maximum +58 °C	Minimum -9 °C	Maximum +24 °C
Room temperature with water at maximum +50 °C	Minimum -12 °C	Maximum +39 °C
Outlet water temperature	Minimum +25 °C	Maximum +58 °C

The following are the graphical operating limits for air-conditioning and domestic hot water production..

HEAT PUMPE MODE HP_OWER 700RK - 700RK A 400

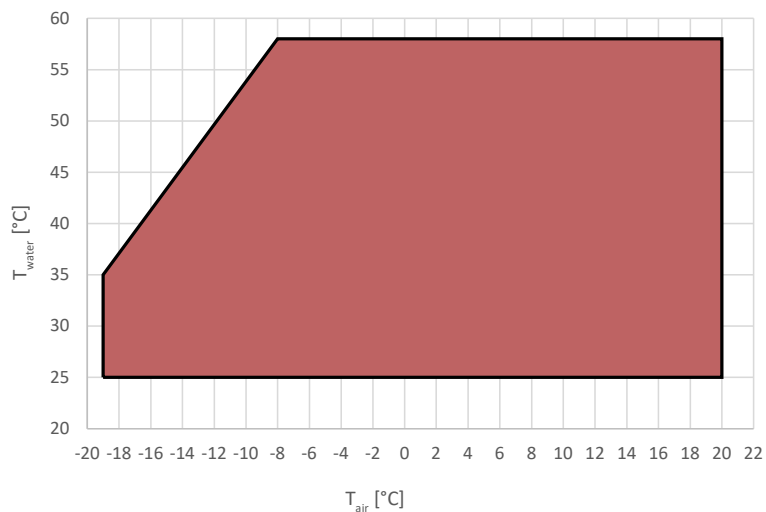

HEAT PUMPE MODE HP_OWER 500RK - 500RK A 400

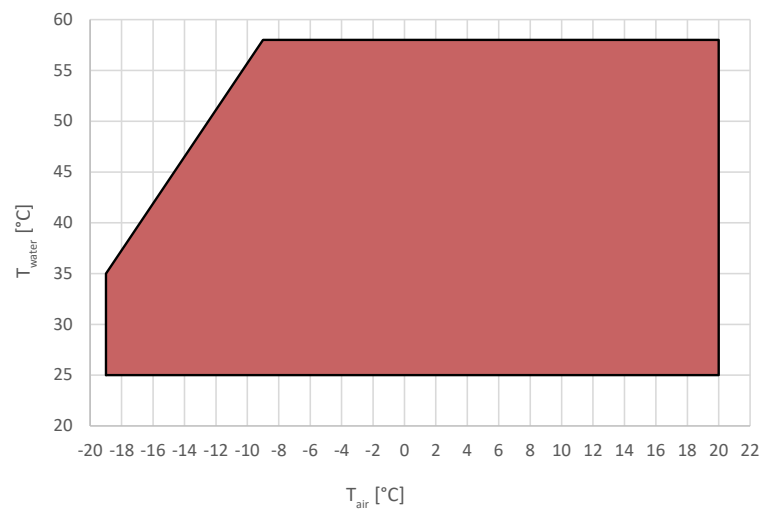

CHILLER MODE

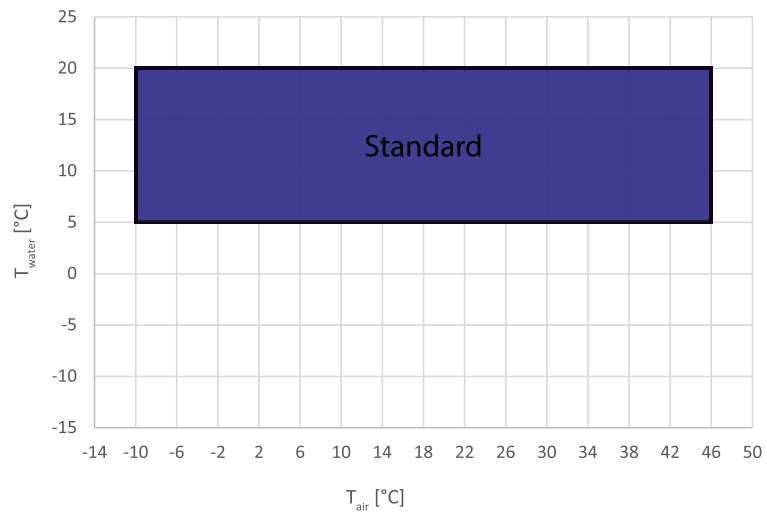

DOMESTIC HOT WATER MODE HP_POWER 700RK - 700RK A 400

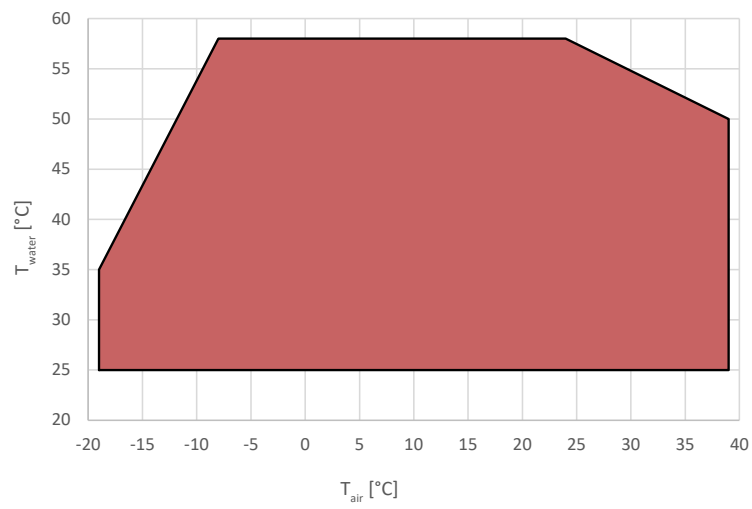



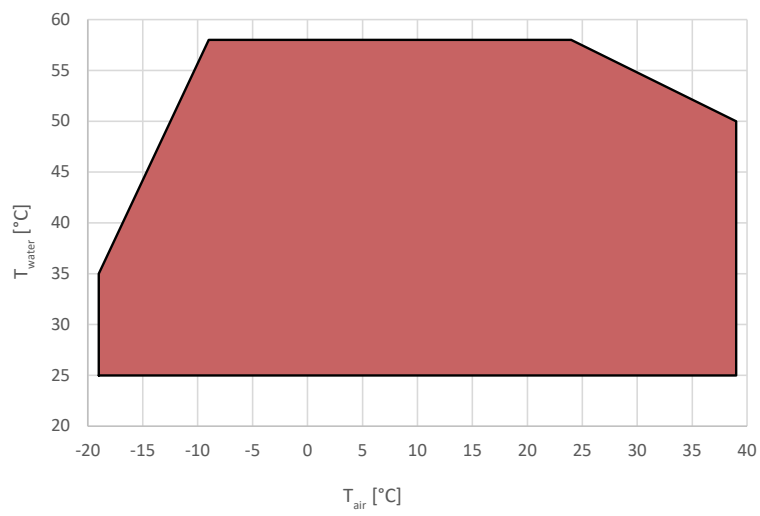





DOMESTIC HOT WATER MODE HP_POWER 500RK - 500RK A 400





14 USER INTERFACE - CONTROLLER

The unit includes a display placed underneath a hinged polycarbonate transparent door with a protection rating of IP67. The interface has a part with variable text and a series of icons identifying operation of the unit as shown in the table below.



Cooling mode led: led ON if unit is in COOL or COOL+SAN mode.	
Heating mode led: led ON if unit is in HEAT or HEAT+SAN mode.	
Pump led: led ON if pump running.	
Alarm led: led ON if an alarm is triggered.	
Defrosting led: flashes to enter defrosting mode, lit when defrosting is in progress.	
Compressor led: flashes if the compressor is starting, is ON if the compressor is active.	
Domestic hot water led: flashes if domestic hot water production is in progress, is ON if COOL+SAN or HEAT+SAN mode is selected and domestic hot water production is not in progress.	
Led KA resistors: is lit if the antifreeze resistors are active.	

The buttons have the specific function described below.

Select the operating mode and manually reset any alarms. Each time you press the key you have the following sequence: OFF -> COOL -> COOL+SAN* -> HEAT -> HEAT+SAN* -> OFF (*= if sanitary mode is enabled) While setting the parameters, this key has the function of sending BACK by one level.	MODE ESC
Allows you to enter the selected menu to view sub-folders or to set a value (e.g. summer, winter and DHW set-points or various parameters).	PRG
The UP key is used to move to a higher menu or to increase the value of a parameter.	
The DOWN key is used to move to a lower menu or to decrease the value of a parameter.	

n standard operation, the display shows the water outlet temperature in tenths of Celsius degrees or the alarm code if at least one is active. If

several alarms are triggered, the first one is displayed while the second one will be displayed as soon as the first one is reset. In menu mode, the display depends on the current position. attivo.

13.5 MENU

The following are the main features for navigating the menus, especially describing functions which are not obvious. The main menu has the following items:

MENU	LABEL	LEVEL	OTHER CONDITIONS
Setpoint	Set	User	Not accessible if connected to Touch screen
Password	PSS	User	---
Alarms	Err	User	Only if active alarms
Probes	tP	Installer	---
Digital inputs	Id	Installer	---
Parameter	Par	Installer	---
Hours of operation	oHr	Installer	---
Alarm log	Hist	Installer	Only if the log contains data
Firmware Version	Fir	Installer	---
USB	USB	Installer	Only with pen drive with relevant update files

The PSS menu is accessed to enter the service password and to enable access with a higher user permission. When you have exited the menus, the password must be entered once again to re-enter.

13.6 SETPOINT MENU

The various setpoints can be viewed and edited.

Set	DESCRIPTION	DEFAULT	RANGE	UNIT
Coo	First summer setpoint	7.0	5 ÷ Coo2	°C
Hea	First winter setpoint	45.0	Hea2 ÷ 60	°C
*San	Sanitary setpoint	48.0	25 ÷ 60	°C
*San2	Second Sanitary setpoint	48.0	25 ÷ 60	°C
Coo2	Second Summer setpoint	18.0	Coo ÷ 25	°C
Hea2	Second Winter setpoint	35.0	25 ÷ Hea	°C

(*) If the DHW function is enabled

(**) If Gi module is included, access is only possible with installer password.

13.7 ALARM MENU [ERR]

The menu only appears if there are active alarms and lists the errors present. In the case of a multi-circuit machine, the alarms are subdivided by circuit.

14. TROUBLESHOOTING

PROBLEM	CAUSE	SOLUTION
The unit does not start	Failure of power supply	Check system voltage Check the protection systems upstream of the unit
	Unit master switch to OFF Circuit breaker OFF	Set on ON
	Damaged electronic board Damaged contactor Compressor damaged	Replace the damage component
Poor unit yield	Insufficient amount of refrigerant Palnt system not properly sized	Check
Noisy compressor	Not adequately fixed Wrong installation Reversed phases	Check
Compressor does not start because of protective devices	Increase in discharge pressure Low inlet pressure Incorrect power supply Incorrect wiring Incorrect working conditions Thermal protection intervention	Check
	Damaged pressure switch	Repalce

PROBLEM	CAUSE	SOLUTION
High exhaust pressure	High outside air temperature High water return temperature Air in the hydraulic circuit Refrigerant gas charge too high	Check
	Poor air flow Poor water flow rate	Check the fan and pump operation
Low exhaust pressure	High outdoor air temperature Low plant return water temperature Residual humidity in the cooling circuit Air in the hydraulic circuit Insufficient refrigerant gas charge	Check
High suction pressure	High outdoor air temperature Low plant return water temperature Expansion valve remains too opened / damaged	Check
Low compressor suction pressure	Low outdoor air temperature Low plant return water temperature Expansion valve remains too closed / clogged/ damaged Dirty plate heat exchanger	Check
	Low air flow rate Low water flow rate	Check the fan and pump operation

Unical®



www.unical.eu

ORIGINAL INSTRUCTION - 00339493EN/a - 2 ed. 12/2022

Unical AG S.p.A. 46033 casteldario - mantova - italia - tel. +39 0376 57001 - fax +39 0376 660556
info@unical-ag.com - export@unical-ag.com - www.unical.eu

Unical declines every responsibility for the possible inaccuracies if owed to errors of transcript or press.
Also reserves the right to bring those changes that it will hold necessary to its own products or profits, without jeopardizing its essential characteristics.