

TOSHIBA

FILE NO. A07-003
Revised: Mar., 2008
Revised 2: Jun., 2008

SERVICE MANUAL

AIR-CONDITIONER

SPLIT TYPE

INDOOR UNIT

<DIGITAL INVERTER>

RAV-SM564UT-E
RAV-SM804UT-E
RAV-SM1104UT-E
RAV-SM1404UT-E
RAV-SM1604UT-E

RAV-SM404SDT-E
RAV-SM454SDT-E
RAV-SM564SDT-E

OUTDOOR UNIT

<SUPER DIGITAL INVERTER>

RAV-SP404AT-E
RAV-SP404ATZ-E
RAV-SP404ATZG-E

RAV-SP1104AT-E
RAV-SP1104ATZ-E
RAV-SP1104ATZG-E

RAV-SP454AT-E
RAV-SP454ATZ-E
RAV-SP454ATZG-E

RAV-SP1404AT-E
RAV-SP1404ATZ-E
RAV-SP1404ATZG-E



Adoption of New Refrigerant

This Air Conditioner is a new type which adopts a new refrigerant HFC (R410A) instead of the conventional refrigerant R22 in order to prevent destruction of the ozone layer.

WARNING

Cleaning of the air filter and other parts of the air filter involves dangerous work in high places, so be sure to have a service person do it. Do not attempt it yourself.

The cleaning diagram for the air filter is there for the service person, and not for the customer.

CONTENTS



SAFETY CAUTION	4
1. SPECIFICATIONS	9
1-1. Indoor Unit.....	9
1-2. Outdoor Unit.....	25
1-3. Operation Characteristic Curve.....	27
2. CONSTRUCTION VIEWS (EXTERNAL VIEWS).....	29
2-1. Indoor Unit.....	29
2-2. Outdoor Unit.....	33
3. SYSTEMATIC REFRIGERATING CYCLE DIAGRAM	36
3-1. Indoor Unit.....	36
3-2. Outdoor Unit.....	37
4. FAN CHARACTERISTICS	39
4-1. Slim Duct (Filter Attached).....	39
5. WIRING DIAGRAM	40
5-1. Indoor Unit.....	40
5-2. Outdoor Unit.....	42
6. SPECIFICATIONS OF ELECTRICAL PARTS	44
6-1. Indoor Unit.....	44
6-2. Outdoor Unit (Parts Ratings)	45
6-3. Accessory Separate Sold Parts	45

7. REFRIGERANT R410A	46
7-1. Safety During Installation / Servicing	46
7-2. Refrigerant Piping Installation	46
7-3. Tools	50
7-4. Recharging of Refrigerant.....	50
7-5. Brazing of Pipes	51
7-6. Instructions for Re-use Piping of R22 or R407C	53
8. INDOOR CONTROL CIRCUIT	58
8-1. Indoor Controller Block Diagram.....	58
8-2. Control Specifications	61
8-3. Optional Connector Specifications of Indoor P.C. Board	74
8-4. Indoor Print Circuit Board	75
9. CIRCUIT CONFIGURATION AND CONTROL SPECIFICATIONS	76
9-1. Outdoor Controls	76
9-2. Outline of Main Controls	78
10. TROUBLESHOOTING	87
10-1. Summary of Troubleshooting.....	87
10-2. Troubleshooting	89
11. REPLACEMENT OF SERVICE P.C. BOARD	141
11-1. Indoort Unit	141
11-2. Outdoor Unit.....	146
12. SETUP AT LOCAL SITE AND OTHERS	147
12-1. Indoor Unit.....	147
12-2. Setup at Local Site / Others	158
12-3. How to Set up Central Control Address Number	160
12-4. Outdoor Unit.....	166
13. ADDRESS SETUP	173
13-1. Address Setup Procedure	173
13-2. Address Setup & Group Control.....	174
13-3. Remote Controller Wiring.....	177
13-4. Address Setup (Manual setting from remote controller)	178
13-5. Confirmation of Indoor Unit No. Position	179
14. DETACHMENTS	181
14-1. Indoor Unit.....	181
14-2. Outdoor Unit.....	196
15. EXPLODED VIEWS AND PARTS LIST	211
15-1. Indoor Unit.....	211
15-2. Outdoor Unit.....	219

SAFETY CAUTION



The important contents concerned to the safety are described on the product itself and on this Service Manual. Please read this Service Manual after understanding the described items thoroughly in the following contents (Indications/Illustrated marks), and keep them.

[Explanation of indications]

Indication	Explanation
 DANGER	Indicates contents assumed that an imminent danger causing a death or serious injury of the repair engineers and the third parties when an incorrect work has been executed.
 WARNING	Indicates possibilities assumed that a danger causing a death or serious injury of the repair engineers, the third parties, and the users due to troubles of the product after work when an incorrect work has been executed.
 CAUTION	Indicates contents assumed that an injury or property damage (*) may be caused on the repair engineers, the third parties, and the users due to troubles of the product after work when an incorrect work has been executed.

* Property damage : Enlarged damage concerned to property, furniture, and domestic animal/pet





[Explanation of illustrated marks]

Mark	Explanation
	Indicates prohibited items (Forbidden items to do) The sentences near an illustrated mark describe the concrete prohibited contents.
	Indicates mandatory items (Compulsory items to do) The sentences near an illustrated mark describe the concrete mandatory contents.
	Indicates cautions (Including danger/warning) The sentences or illustration near or in an illustrated mark describe the concrete cautious contents.









[Confirmation of warning label on the main unit]







Confirm that labels are indicated on the specified positions (Refer to the Parts disassembly diagram (Outdoor unit).)



If removing the label during parts replace, stick it as the original.

 DANGER	
 Turn off breaker.	Turn "OFF" the breaker before removing the front panel and cabinet, otherwise an electric shock is caused by high voltage resulted in a death or injury. During operation, a high voltage with 400V or higher of circuit (*) at secondary circuit of the high-voltage transformer is applied. If touching a high voltage with the naked hands or body, an electric shock is caused even if using an electric insulator. * : For details, refer to the electric wiring diagram.
 Execute discharge between terminals.	When removing the front panel or cabinet, execute short-circuit and discharge between high-voltage capacitor terminals. If discharge is not executed, an electric shock is caused by high voltage resulted in a death or injury. After turning off the breaker, high voltage also keeps to apply to the high-voltage capacitor.
 Prohibition	Do not turn on the breaker under condition that the front panel and cabinet are removed. An electric shock is caused by high voltage resulted in a death or injury.

 **WARNING**

 Check earth wires.	<p>Before troubleshooting or repair work, check the earth wire is connected to the earth terminals of the main unit, otherwise an electric shock is caused when a leak occurs. If the earth wire is not correctly connected, contact an electric engineer for rework.</p>
 Prohibition of modification.	<p>Do not modify the products. Do not also disassemble or modify the parts. It may cause a fire, electric shock or injury.</p>
 Use specified parts.	<p>For spare parts, use those specified (*). If unspecified parts are used, a fire or electric shock may be caused. *: For details, refer to the parts list.</p>
 Do not bring a child close to the equipment.	<p>Before troubleshooting or repair work, do not bring a third party (a child, etc.) except the repair engineers close to the equipment. It causes an injury with tools or disassembled parts. Please inform the users so that the third party (a child, etc.) does not approach the equipment.</p>
 Insulating measures	<p>Connect the cut-off lead wires with crimp contact, etc, put the closed end side upward and then apply a water-cut method, otherwise a leak or production of fire is caused at the users' side.</p>
 No fire	<p>When repairing the refrigerating cycle, take the following measures.</p> <ol style="list-style-type: none"> 1) Be attentive to fire around the cycle. When using a gas stove, etc, be sure to put out fire before work; otherwise the oil mixed with refrigerant gas may catch fire. 2) Do not use a welder in the closed room. When using it without ventilation, carbon monoxide poisoning may be caused. 3) Do not bring inflammables close to the refrigerant cycle, otherwise fire of the welder may catch the inflammables.
 Refrigerant	<p>Check the used refrigerant name and use tools and materials of the parts which match with it. For the products which use R410A refrigerant, the refrigerant name is indicated at a position on the outdoor unit where is easy to see. To prevent miss-charging, the route of the service port is changed from one of the former R22.</p> <p>For an air conditioner which uses R410A, never use other refrigerant than R410A. For an air conditioner which uses other refrigerant (R22, etc.), never use R410A. If different types of refrigerant are mixed, abnormal high pressure generates in the refrigerating cycle and an injury due to breakage may be caused.</p> <p>Do not charge refrigerant additionally. If charging refrigerant additionally when refrigerant gas leaks, the refrigerant composition in the refrigerating cycle changes resulted in change of air conditioner characteristics or refrigerant over the specified standard amount is charged and an abnormal high pressure is applied to the inside of the refrigerating cycle resulted in cause of breakage or injury. Therefore if the refrigerant gas leaks, recover the refrigerant in the air conditioner, execute vacuuming, and then newly recharge the specified amount of liquid refrigerant. In this time, never charge the refrigerant over the specified amount.</p> <p>When recharging the refrigerant in the refrigerating cycle, do not mix the refrigerant or air other than R410A into the specified refrigerant. If air or others is mixed with the refrigerant, abnormal high pressure generates in the refrigerating cycle resulted in cause of injury due to breakage.</p> <p>After installation work, check the refrigerant gas does not leak. If the refrigerant gas leaks in the room, poisonous gas generates when gas touches to fire such as fan heater, stove or cooking stove though the refrigerant gas itself is innocuous.</p> <p>Never recover the refrigerant into the outdoor unit. When the equipment is moved or repaired, be sure to recover the refrigerant with recovering device. The refrigerant cannot be recovered in the outdoor unit; otherwise a serious accident such as breakage or injury is caused.</p>
 Assembly/Cabling	<p>After repair work, surely assemble the disassembled parts, and connect and lead the removed wires as before. Perform the work so that the cabinet or panel does not catch the inner wires. If incorrect assembly or incorrect wire connection was done, a disaster such as a leak or fire is caused at user's side.</p>

 WARNING	
 Insulator check	<p>After the work has finished, be sure to use an insulation tester set (500V Megger) to check the resistance is 2MΩ or more between the charge section and the non-charge metal section (Earth position).</p> <p>If the resistance value is low, a disaster such as a leak or electric shock is caused at user's side.</p>
 Ventilation	<p>When the refrigerant gas leaks during work, execute ventilation.</p> <p>If the refrigerant gas touches to a fire, poisonous gas generates. A case of leakage of the refrigerant and the closed room full with gas is dangerous because a shortage of oxygen occurs. Be sure to execute ventilation.</p>
 Be attentive to electric shock	<p>When checking the circuit inevitably under condition of the power-ON, use rubber gloves and others not to touch to the charging section.</p> <p>If touching to the charging section, an electric shock may be caused.</p>
 Compulsion	<p>When the refrigerant gas leaks, find up the leaked position and repair it surely.</p> <p>If the leaked position cannot be found up and the repair work is interrupted, pump-down and tighten the service valve, otherwise the refrigerant gas may leak into the room. The poisonous gas generates when gas touches to fire such as fan heater, stove or cooking stove though the refrigerant gas itself is innocuous.</p> <p>When installing equipment which includes a large amount of charged refrigerant such as a multi air conditioner in a sub-room, it is necessary that the density does not the limit even if the refrigerant leaks.</p> <p>If the refrigerant leaks and exceeds the limit density, an accident of shortage of oxygen is caused.</p> <p>For the installation/moving/reinstallation work, follow to the Installation Manual.</p> <p>If an incorrect installation is done, a trouble of the refrigerating cycle, water leak, electric shock or fire is caused.</p>
 Check after repair	<p>After repair work has finished, check there is no trouble.</p> <p>If check is not executed, a fire, electric shock or injury may be caused. For a check, turn off the power breaker.</p>
 Check after reinstallation	<p>After repair work (installation of front panel and cabinet) has finished, execute a test run to check there is no generation of smoke or abnormal sound.</p> <p>If check is not executed, a fire or an electric shock is caused. Before test run, install the front panel and cabinet.</p> <p>Check the following items after reinstallation.</p> <ol style="list-style-type: none"> 1) The earth wire is correctly connected. 2) The power cord is not caught in the product. 3) There is no inclination or unsteadiness and the installation is stable. <p>If check is not executed, a fire, an electric shock or an injury is caused.</p>

 CAUTION	
 Put on gloves	<p>Be sure to put on the gloves (*) and a long sleeved shirt: otherwise an injury may be caused with the parts, etc.</p> <p>(*) Heavy gloves such as work gloves</p>
 Cooling check	<p>When the power was turned on, start to work after the equipment has been sufficiently cooled.</p> <p>As temperature of the compressor pipes and others became high due to cooling/heating operation, a burn may be caused.</p>

• New Refrigerant (R410A)

This air conditioner adopts a new HFC type refrigerant (R410A) which does not deplete the ozone layer.

1. Safety Caution Concerned to New Refrigerant

The pressure of R410A is high 1.6 times of that of the former refrigerant (R22).

Accompanied with change of refrigerant, the refrigerating oil has been also changed.

Therefore, be sure that water, dust, the former refrigerant or the former refrigerating oil is not mixed into the refrigerating cycle of the air conditioner with new refrigerant during installation work or service work.

If an incorrect work or incorrect service is performed, there is a possibility to cause a serious accident.

Use the tools and materials exclusive to R410A to purpose a safe work.

2. Cautions on Installation/Service

1) Do not mix the other refrigerant or refrigerating oil.

For the tools exclusive to R410A, shapes of all the joints including the service port differ from those of the former refrigerant in order to prevent mixture of them.

2) As the use pressure of the new refrigerant is high, use material thickness of the pipe and tools which are specified for R410A.

3) In the installation time, use clean pipe materials and work with great attention so that water and others do not mix in because pipes are affected by impurities such as water, oxide scales, oil, etc.

Use the clean pipes.

Be sure to brazing with flowing nitrogen gas. (Never use gas other than nitrogen gas.)

4) For the earth protection, use a vacuum pump for air purge.

5) R410A refrigerant is azeotropic mixture type refrigerant.

Therefore use liquid type to charge the refrigerant. (If using gas for charging, composition of the refrigerant changes and then characteristics of the air conditioner change.)

3. Pipe Materials

For the refrigerant pipes, copper pipe and joints are mainly used.

It is necessary to select the most appropriate pipes to conform to the standard.

Use clean material in which impurities adhere inside of pipe or joint to a minimum.

1) Copper pipe

<Piping>

The pipe thickness, flare finishing size, flare nut and others differ according to a refrigerant type.

When using a long copper pipe for R410A, it is recommended to select "Copper or copper-base pipe without seam" and one with bonded oil amount 40mg/10m or less.

Also do not use crushed, deformed, discolored (especially inside) pipes.
(Impurities cause clogging of expansion valves and capillary tubes.)

<Flare nut>

Use the flare nuts which are attached to the air conditioner unit.

2) Joint

The flare joint and socket joint are used for joints of the copper pipe.

The joints are rarely used for installation of the air conditioner. However clear impurities when using them.

4. Tools

1. Required Tools for R410A

Mixing of different types of oil may cause a trouble such as generation of sludge, clogging of capillary, etc. Accordingly, the tools to be used are classified into the following three types.

- 1) Tools exclusive for R410A (Those which cannot be used for conventional refrigerant (R22))
- 2) Tools exclusive for R410A, but can be also used for conventional refrigerant (R22)
- 3) Tools commonly used for R410A and for conventional refrigerant (R22)

The table below shows the tools exclusive for R410A and their interchangeability.

Tools exclusive for R410A (The following tools for R410A are required.)

Tools whose specifications are changed for R410A and their interchangeability

No.	Used tool	Usage	R410A air conditioner installation		Conventional air conditioner installation
			Existence of new equipment for R410A	Whether conven- tional equipment can be used	Whether conventional equipment can be used
①	Flare tool	Pipe flaring	Yes	*(Note)	Yes
②	Copper pipe gauge for adjusting projection margin	Flaring by conventional flare tool	Yes	*(Note)	*(Note)
③	Torque wrench	Tightening of flare nut	Yes	No	No
④	Gauge manifold	Evacuating, refrigerant charge, run check, etc.	Yes	No	No
⑤	Charge hose				
⑥	Vacuum pump adapter	Vacuum evacuating	Yes	No	Yes
⑦	Electronic balance for refrigerant charging	Refrigerant charge	Yes	Yes	Yes
⑧	Refrigerant cylinder	Refrigerant charge	Yes	No	No
⑨	Leakage detector	Gas leakage check	Yes	No	Yes

(Note) When flaring is carried out for R410A using the conventional flare tools, adjustment of projection margin is necessary. For this adjustment, a copper pipe gauge, etc. are necessary.

General tools (Conventional tools can be used.)

In addition to the above exclusive tools, the following equipments which serve also for R22 are necessary as the general tools.

- | | |
|---|---|
| <ol style="list-style-type: none"> 1) Vacuum pump. Use vacuum pump by attaching vacuum pump adapter. 2) Torque wrench 3) Pipe cutter 4) Reamer 5) Pipe bender 6) Level vial | <ol style="list-style-type: none"> 7) Screwdriver (+, -) 8) Spanner or Monkey wrench 9) Hole core drill 10) Hexagon wrench (Opposite side 4mm) 11) Tape measure 12) Metal saw |
|---|---|

Also prepare the following equipments for other installation method and run check.

- | | |
|--|--|
| <ol style="list-style-type: none"> 1) Clamp meter 2) Thermometer | <ol style="list-style-type: none"> 3) Insulation resistance tester (Megger) 4) Electroscop |
|--|--|

1. SPECIFICATIONS

1-1. Indoor Unit

1-1-1. 4-Way Air Discharge Cassette Type

<Single type>

Model	Indoor unit		RAV-SM	564UT-E	804UT-E	1104UT-E	1404UT-E
	Outdoor unit		RAV-SP	562AT(Z)(ZG)-E	802AT(Z)(ZG)-E	1104AT(Z)(ZG)-E	1404AT(Z)(ZG)-E
Cooling capacity			(kW)	5.3	7.1	10.0	12.5
Heating capacity			(kW)	5.6	8.0	11.2	14.0
Power supply			1 phase 230V (220 – 240V) 50Hz				
Electrical characteristics	Cooling	Running current (A)		7.17 – 6.57	8.95 – 8.21	10.36 – 9.49	14.66 – 13.44
		Power consumption (kW)		1.53	1.93	2.21	3.16
		Power factor (%)		97	98	97	98
		EER		3.46	3.68	4.52	3.96
		Energy efficiency class *		A	A	A	A
		Energy rating **		—	—	—	—
	Heating	Running current (A)		5.62 – 5.15	9.42 – 8.63	10.96 – 10.05	14.89 – 13.65
		Power consumption (kW)		1.20	2.03	2.34	3.21
		Power factor (%)		97	98	97	98
		COP		4.67	3.94	4.79	4.36
		Energy efficiency class *		A	A	A	A
		Energy rating **		—	—	—	—
Maximum current (A)			15.33	15.33	20.50	20.50	
Appearance	Main unit		Zinc hot dipping steel plate				
	Ceiling panel (Sold separately)	Model	RBC-U31PG (W, WS)-E, RBC-U31PGS (W, WS)-E				
		Panel color	W: Moon-white (2.5GY 9.0/0.5), WS: Stripe-white (2.5GY 9.0/0.5, (Gray: 8B 3/0.3))				
Outer dimension	Main unit	Height (mm)	256	256	319	319	
		Width (mm)	840	840	840	840	
		Depth (mm)	840	840	840	840	
	Ceiling panel (Sold separately)	Height (mm)	30	30	30	30	
		Width (mm)	950	950	950	950	
		Depth (mm)	950	950	950	950	
Total weight	Main unit (kg)		20	20	24	24	
	Ceiling panel (Sold separately) (kg)		4.2	4.2	4.2	4.2	
Heat exchanger			Finned tube				
Fan unit	Fan		Turbo fan				
	Standard air flow	H/M/L (m ³ /min.)	17.5/14.5/13.0	20.5/16.0/13.5	33.5/24.0/19.5	35.0/24.0/20.5	
	Motor (W)		14	20	68	72	
Air filter			Standard filter attached (Long life filter)				
Controller (Sold separately)			RBC-AMT32E, AMS41E, AS21E2, AX31U (W)-E				
Sound pressure level		H/M/L (dB•A)	32 / 29 / 28	35 / 31 / 28	43 / 38 / 33	44 / 38 / 34	
Sound power level		H/M/L (dB•A)	47 / 44 / 43	50 / 46 / 43	58 / 53 / 48	59 / 53 / 49	
Connecting pipe	Gas side (mm)		12.7	15.9	15.9	15.9	
	Liquid side (mm)		6.4	9.5	9.5	9.5	
	Drain port (mm)		VP25				

* : IEC standard, ** : AS standard

<Single type>

Model	Indoor unit		RAV-	SM564UT-E	SM804UT-E	SM1104UT-E	SM1404UT-E	SM1604UT-E
	Outdoor unit		RAV-	SM563AT-E	SM803AT-E	SM1103AT-E	SM1403AT-E	SM1603AT-E
Cooling capacity			(kW)	5.3	6.7	10.0	12.0	14.0
Heating capacity			(kW)	5.6	8.0	11.2	14.0	16.0
Power supply				1 phase 230V (220 – 240V) 50Hz				
Electrical characteristics	Cooling	Running current	(A)	7.89 – 7.24	9.97 – 9.12	14.61 – 13.40	17.62 – 16.14	21.48 – 19.69
		Power consumption	(kW)	1.65	2.09	3.11	3.74	4.49
		Power factor	(%)	95	95	97	96	95
		EER		3.21	3.21	3.22	3.21	3.12
		Energy efficiency class *		A	A	A	A	B
		Energy rating **		—	—	—	—	—
	Heating	Running current	(A)	6.89 – 6.32	10.83 – 9.90	13.38 – 12.38	17.88 – 15.87	21.20 – 19.43
		Power consumption	(kW)	1.44	2.21	2.93	3.80	4.43
		Power factor	(%)	95	93	99	98	95
		COP		3.89	3.62	3.82	3.68	3.61
		Energy efficiency class *		A	A	A	A	A
		Energy rating **		—	—	—	—	—
Maximum current			(A)	15.33	15.33	20.50	20.50	32.0
Appearance	Main unit		Zinc hot dipping steel plate					
	Ceiling panel (Sold separately)	Model	RBC-U31PG (W, WS)-E, RBC-U31PGS (W, WS)-E					
		Panel color	W: Moon-white (2.5GY 9.0/0.5), WS: Stripe-white (2.5GY 9.0/0.5, (Gray: 8B 3/0.3))					
Outer dimension	Main unit	Height	(mm)	256	256	319	319	319
		Width	(mm)	840	840	840	840	840
		Depth	(mm)	840	840	840	840	840
	Ceiling panel (Sold separately)	Height	(mm)	30	30	30	30	30
		Width	(mm)	950	950	950	950	950
		Depth	(mm)	950	950	950	950	950
Total weight	Main unit		(kg)	20	20	24	24	24
	Ceiling panel (Sold separately)		(kg)	4.2	4.2	4.2	4.2	4.2
Heat exchanger				Finned tube				
Fan unit	Fan		Turbo fan					
	Standard air flow	H/M/L	(m ³ /min.)	17.5/14.5/13.0	20.5/16.0/13.5	33.5/24.0/19.5	35.0/24.0/20.5	35.5/25.0/21.0
	Motor		(W)	14	20	68	72	72
Air filter				Standard filter attached (Long life filter)				
Controller (Sold separately)				RBC-AMT32E, AMS41E, AS21E2, AX31U (W)-E				
Sound pressure level		H/M/L	(dB•A)	32 / 29 / 28	35 / 31 / 28	43 / 38 / 33	44 / 38 / 34	45 / 40 / 36
Sound power level		H/M/L	(dB•A)	47 / 44 / 43	50 / 46 / 43	58 / 53 / 48	59 / 53 / 49	60 / 55 / 51
Connecting pipe	Gas side		(mm)	12.7	15.9	15.9	15.9	15.9
	Liquid side		(mm)	6.4	9.5	9.5	9.5	9.5
	Drain port		(mm)	VP25				

* : IEC standard, ** : AS standard

<Twin type>

Model	Indoor unit 1		RAV-	SM564UT-E	SM804UT-E
	Indoor unit 2		RAV-	SM564UT-E	SM804UT-E
	Outdoor unit		RAV-	SP1104AT(Z)(ZG)-E	SP1404AT(Z)(ZG)-E
Cooling capacity			(kW)	10.0	12.5
Heating capacity			(kW)	11.2	14.0
Indoor unit					
Power supply				1 phase 230V (220 – 240V) 50Hz	
Electrical characteristics	Cooling	Running current	(A)	10.36 – 9.49	14.66 – 13.44
		Power consumption	(kW)	2.21	3.16
		Power factor	(%)	97	98
		EER		4.52	3.96
		Energy efficiency class *		A	A
	Heating	Running current	(A)	10.96 – 10.05	14.89 – 13.65
		Power consumption	(kW)	2.34	3.21
		Power factor	(%)	97	98
		COP		4.79	4.36
		Energy efficiency class *		A	A
Fan unit	Fan			Turbo fan	
	Standard air flow	H/M/L	(m ³ /min.)	17.5 / 14.5 / 13.0	20.5 / 16.0 / 13.5
	Motor		(W)	14	20
Sound pressure level		H/M/L	(dB•A)	32 / 29 / 28	35 / 31 / 28
Sound power level		H/M/L	(dB•A)	47 / 44 / 43	50 / 46 / 43
Outdoor unit					
Power supply				1 phase 230V (220 – 240V) 50Hz	
Refrigerant pipe	Standard length		(m)	7.5	7.5
	Min. length		(m)	3	3
	Max. total length		(m)	50	50
	Refrigerant charging amount (Charge-less up to 30m)			40g/m (31m to 50m)	
	Height difference	Outdoor lower	(m)	30	30
		Outdoor higher	(m)	30	30
Fan unit	Fan			Propeller fan	
	Standard air flow volume		(m ³ /min.)	101	103
	Motor		(W)	100 + 100	100 + 100
Connecting pipe	Gas side	Main	(mm)	15.9	15.9
		Sub	(mm)	12.7	15.9
	Liquid side	Main	(mm)	9.5	9.5
		Sub	(mm)	6.4	9.5
Sound pressure level		Cooling/Heating	(dB•A)	49 / 50	51 / 52
Sound power level		Cooling/Heating	(dB•A)	66 / 67	68 / 69

* : IEC standard

<Twin type>

Model	Indoor unit 1		RAV-	SM564UT-E	SM804UT-E	SM804UT-E
	Indoor unit 2		RAV-	SM564UT-E	SM804UT-E	SM804UT-E
	Outdoor unit		RAV-	SM1103AT-E	SM1403AT-E	SM1603AT-E
Cooling capacity			(kW)	10.0	12.5	14.0
Heating capacity			(kW)	11.2	14.0	16.0
Indoor unit						
Power supply			1 phase 230V (220 – 240V) 50Hz			
Electrical characteristics	Cooling	Running current	(A)	14.59 – 13.38	19.17 – 17.57	21.48 – 19.69
		Power consumption	(kW)	3.11	4.09	4.49
		Power factor	(%)	98	97	95
		EER		3.22	3.06	3.12
		Energy efficiency class *		A	(B)	(B)
	Heating	Running current	(A)	13.36 – 12.36	18.74 – 17.18	21.20 – 19.43
		Power consumption	(kW)	2.93	4.00	4.43
		Power factor	(%)	99	97	95
		COP		3.82	3.50	3.61
		Energy efficiency class *		A	(B)	(A)
Fan unit	Fan		Turbo fan			
	Standard air flow	H/M/L	(m ³ /min.)	17.5 / 14.5 / 13.0	20.5 / 16.0 / 13.5	20.5 / 16.0 / 13.5
	Motor		(W)	14	20	20
Sound pressure level		H/M/L	(dB•A)	32 / 29 / 28	35 / 31 / 28	35 / 31 / 28
Sound power level		H/M/L	(dB•A)	47 / 44 / 43	50 / 46 / 43	50 / 46 / 43
Outdoor unit						
Power supply			1 phase 230V (220 – 240V) 50Hz			
Refrigerant pipe	Standard length		(m)	7.5	7.5	7.5
	Min. length		(m)	5	5	5
	Max. total length		(m)	50	50	50
	Refrigerant charging amount (Charge-less up to 30m)			40g/m (31m to 50m)		
	Height difference	Outdoor lower	(m)	30	30	30
		Outdoor higher	(m)	30	30	30
Fan unit	Fan		Propeller fan			
	Standard air flow volume		(m ³ /min.)	75	75	103
	Motor		(W)	63	100	100 + 100
Connecting pipe	Gas side	Main	(mm)	15.9	15.9	15.9
		Sub	(mm)	12.7	15.9	15.9
	Liquid side	Main	(mm)	9.5	9.5	9.5
		Sub	(mm)	6.4	9.5	9.5
Sound pressure level		Cooling/Heating	(dB•A)	53 / 54	54 / 54	51 / 53
Sound power level		Cooling/Heating	(dB•A)	70 / 71	71 / 71	68 / 70

* : IEC standard

1-1-2. Concealed Duct Type

<Single type>

Model	Indoor unit		RAV-SM	562BT-E	802BT-E	1102BT-E	1402BT-E	
	Outdoor unit		RAV-SP	562AT(Z)(ZG)-E	802AT(Z)(ZG)-E	1104AT(Z)(ZG)-E	1404AT(Z)(ZG)-E	
Cooling capacity			(kW)	5.0	7.1	10.0	12.5	
Heating capacity			(kW)	5.6	8.0	11.2	14.0	
Power supply			1 phase 230V (220 – 240V) 50Hz					
Electrical characteristics	Cooling	Running current	(A)	6.51 – 5.97	9.74 – 8.93	13.78 – 12.63	17.76 – 16.28	
		Power consumption	(kW)	1.39	2.10	2.94	3.83	
		Power factor	(%)	97	98	97	98	
		EER		3.60	3.38	3.40	3.26	
		Energy efficiency class *		A	A	A	A	
		Energy rating **		—	—	—	—	
	Heating	Running current	(A)	7.26 – 6.66	9.74 – 8.93	12.98 – 11.90	15.82 – 14.50	
		Power consumption	(kW)	1.55	2.41	2.77	3.41	
		Power factor	(%)	97	94	97	98	
		COP		3.61	3.32	4.04	4.11	
		Energy efficiency class *		A	A	A	A	
		Energy rating **		—	—	—	—	
Maximum current			(A)	15.86	16.30	21.73	22.13	
Appearance	Main unit		Zinc hot dipping steel plate					
	Ceiling panel (Sold separately)	Model	—					
		Panel color	—					
Outer dimension	Main unit	Height	(mm)	320	320	320	320	
		Width	(mm)	700	1000	1350	1350	
		Depth	(mm)	800	800	800	800	
	Ceiling panel (Sold separately)	Height	(mm)	—	—	—	—	
		Width	(mm)	—	—	—	—	
		Depth	(mm)	—	—	—	—	
Total weight	Main unit		(kg)	30	39	54	54	
	Ceiling panel (Sold separately)		(kg)	—	—	—	—	
Heat exchanger			Finned tube					
Fan unit	Fan		Centrifugal					
	Standard air flow	H/M/L	(m ³ /min.)	13.0/11.9/9.8	19.0/16.2/13.3	27.0/23.0/18.9	33.0/28.0/23.1	
	Motor		(W)	120	120	120	120	
	External static pressure	Standard (at shipment)	(Pa)	40				
		Set up for tap exchange	(Pa)	20/40/70/100				20/40/65/90
Air filter (Sold separately)			TCB-	UFM21BE UFM61BE	UFM11BFCE UFM31BE UFM51BFCE UFM71BE	UFM21BFCE UFM41BE UFM61BFCE UFM81BE		
Controller (Sold separately)			RBC-AMT31E, AMS41E, AS21E2, AX21U(W)-E2					
Sound pressure level	H/M/L	(dB•A)	40 / 37 / 33	40 / 37 / 34	42 / 39 / 36	44 / 41 / 38		
Sound power level	H/M/L	(dB•A)	55 / 52 / 48	55 / 52 / 49	57 / 54 / 51	59 / 56 / 53		
Connecting pipe	Gas side	(mm)	12.7	15.9	15.9	15.9		
	Liquid side	(mm)	6.4	9.5	9.5	9.5		
	Drain port	(mm)	VP25					

* : IEC standard, ** : AS standard

<Twin type>

Model	Indoor unit 1		RAV-	SM562BT-E	SM802BT-E	
	Indoor unit 2		RAV-	SM562BT-E	SM802BT-E	
	Outdoor unit		RAV-	SP1104AT(Z)(ZG)-E	SP1404AT(Z)(ZG)-E	
Cooling capacity			(kW)	10.0	12.5	
Heating capacity			(kW)	11.2	14.0	
Indoor unit						
Power supply			1 phase 230V (220 – 240V) 50Hz			
Electrical characteristics	Cooling	Running current	(A)	13.78 – 12.63	17.76 – 16.28	
		Power consumption	(kW)	2.94	3.83	
		Power factor	(%)	97	98	
		EER		3.4	3.26	
		Energy efficiency class *		A	A	
	Heating	Running current	(A)	12.98 – 11.90	15.82 – 14.50	
		Power consumption	(kW)	2.77	3.41	
		Power factor	(%)	97	98	
		COP		4.04	4.11	
		Energy efficiency class *		A	A	
Fan unit	Fan		Centrifugal			
	Standard air flow	H/M/L	(m ³ /min.)	13.0 / 11.9 / 9.8	19.0 / 16.2 / 13.3	
	Motor		(W)	120	120	
Sound pressure level		H/M/L	(dB•A)	40 / 37 / 33	40 / 37 / 34	
Sound power level		H/M/L	(dB•A)	55 / 52 / 48	55 / 52 / 49	
Outdoor unit						
Power supply			1 phase 230V (220 – 240V) 50Hz			
Refrigerant pipe	Standard length		(m)	7.5	7.5	
	Min. length		(m)	3	3	
	Max. total length		(m)	50	50	
	Refrigerant charging amount (Charge-less up to 30m)			40g/m (31m to 50m)		
	Height difference	Outdoor lower		(m)	30	30
		Outdoor higher		(m)	30	30
Fan unit	Fan		Propeller fan			
	Standard air flow volume		(m ³ /min.)	101	103	
	Motor		(W)	100 + 100	100 + 100	
Connecting pipe	Gas side	Main	(mm)	15.9	15.9	
		Sub	(mm)	12.7	15.9	
	Liquid side	Main	(mm)	9.5	9.5	
		Sub	(mm)	6.4	9.5	
Sound pressure level		Cooling/Heating	(dB•A)	49 / 50	51 / 52	
Sound power level		Cooling/Heating	(dB•A)	66 / 67	68 / 69	

* : IEC standard

1-1-3. Under Ceiling Type

<Single type>

Model	Indoor unit		RAV-SM	562CT-E	802CT-E	1102CT-E	1402CT-E
	Outdoor unit		RAV-SP	562AT(Z)(ZG)-E	802AT(Z)(ZG)-E	1104AT(Z)(ZG)-E	1404AT(Z)(ZG)-E
Cooling capacity			(kW)	5.0	7.1	10.0	12.5
Heating capacity			(kW)	5.6	8.0	11.2	14.0
Power supply				1 phase 230V (220 – 240V) 50Hz			
Electrical characteristics	Cooling	Running current	(A)	6.61 – 6.06	9.47 – 8.93	12.51 – 11.47	17.30 – 15.86
		Power consumption	(kW)	1.41	2.1	2.67	3.73
		Power factor	(%)	97	98	97	98
		EER		3.55	3.38	3.75	3.35
		Energy efficiency class *		A	A	A	A
		Energy rating **		—	—	—	—
	Heating	Running current	(A)	7.03 – 6.44	10.20 – 9.35	12.28 – 11.25	16.93 – 15.52
		Power consumption	(kW)	1.50	2.20	2.62	3.65
		Power factor	(%)	97	98	97	98
		COP		3.73	3.64	4.27	3.84
		Energy efficiency class *		A	A	A	A
		Energy rating **		—	—	—	—
Maximum current			(A)	15.48	15.90	21.35	21.35
Appearance	Main unit	Shine white					
	Ceiling panel (Sold separately)	Model	—				
		Panel color	—				
Outer dimension	Main unit	Height	(mm)	210	210	210	210
		Width	(mm)	910	1180	1595	1595
		Depth	(mm)	680	680	680	680
	Ceiling panel (Sold separately)	Height	(mm)	—	—	—	—
		Width	(mm)	—	—	—	—
		Depth	(mm)	—	—	—	—
Total weight	Main unit	(kg)	21	25	33	33	
	Ceiling panel (Sold separately)	(kg)	—	—	—	—	
Heat exchanger				Finned tube			
Fan unit	Fan		Centrifugal				
	Standard air flow	H/M/L	(m ³ /min.)	13.0/11.2/10.0	18.5/16.7/14.6	27.5/24.0/21.2	30.0/26.0/23.1
	Motor		(W)	60	60	120	120
Air filter				Attached main unit			
Controller (Sold separately)				RBC-AMT31E, AMS41E, AS21E2, TCB-SC642TLE2, AX21UCE2			
Sound pressure level	H/M/L	(dB•A)	36 / 33 / 30	38 / 36 / 33	41 / 38 / 36	43 / 40 / 37	
Sound power level	H/M/L	(dB•A)	51 / 48 / 45	53 / 51 / 48	56 / 53 / 50	58 / 55 / 52	
Connecting pipe	Gas side	(mm)	12.7	15.9	15.9	15.9	
	Liquid side	(mm)	6.4	9.5	9.5	9.5	
	Drain port	(mm)	VP25				

* : IEC standard, ** : AS standard

<Twin type>

Model	Indoor unit 1		RAV-	SM562CT-E	SM802CT-E	
	Indoor unit 2		RAV-	SM562CT-E	SM802CT-E	
	Outdoor unit		RAV-	SP1104AT(Z)(ZG)-E	SP1404A(Z)(ZG)-E	
Cooling capacity			(kW)	10.0	12.5	
Heating capacity			(kW)	11.2	14.0	
Indoor unit						
Power supply			1 phase 230V (220 – 240V) 50Hz			
Electrical characteristics	Cooling	Running current (A)		12.51 – 11.47	17.30 – 15.86	
		Power consumption (kW)		2.67	3.73	
		Power factor (%)		97	98	
		EER		3.75	3.35	
		Energy efficiency class *		A	A	
	Heating	Running current (A)		12.28 – 11.25	16.93 – 15.52	
		Power consumption (kW)		2.62	3.65	
		Power factor (%)		97	98	
		COP		4.27	3.84	
		Energy efficiency class *		A	A	
Fan unit	Fan		Centrifugal			
	Standard air flow	H/M/L (m ³ /min.)	13.0 / 11.2 / 10.0	18.5 / 16.7 / 14.6		
	Motor (W)		60	60		
Sound pressure level		H/M/L (dB•A)	36 / 33 / 30	38 / 36 / 33		
Sound power level		H/M/L (dB•A)	51 / 48 / 45	53 / 51 / 48		
Outdoor unit						
Power supply			1 phase 230V (220 – 240V) 50Hz			
Refrigerant pipe	Standard length (m)		7.5	7.5		
	Min. length (m)		3	3		
	Max. total length (m)		50	50		
	Refrigerant charging amount (Charge-less up to 30m)		40g/m (31m to 50m)			
	Height difference	Outdoor lower (m)	30	30		
Outdoor higher (m)		30	30			
Fan unit	Fan		Propeller fan			
	Standard air flow volume (m ³ /min.)		101	103		
	Motor (W)		100 + 100	100 + 100		
Connecting pipe	Gas side	Main (mm)	15.9	15.9		
		Sub (mm)	12.7	15.9		
	Liquid side	Main (mm)	9.5	9.5		
		Sub (mm)	6.4	9.5		
Sound pressure level		Cooling/Heating (dB•A)	49 / 50	51 / 52		
Sound power level		Cooling/Heating (dB•A)	66 / 67	68 / 69		

* : IEC standard

1-1-4. High Wall Type

<Single type>

Model	Indoor unit		RAV-	SM562KRT-E	SM802KRT-E
	Outdoor unit		RAV-	SP562AT(Z)(ZG)-E	SP802AT(Z)(ZG)-E
Cooling capacity			(kW)	5.0	6.9
Heating capacity			(kW)	5.6	8.0
Power supply			1 phase 230V (220 – 240V) 50Hz		
Electrical characteristics	Cooling	Running current	(A)	8.33 – 7.63	13.15 – 12.05
		Power consumption	(kW)	1.39	2.4
		Power factor	(%)	95	94
		EER		3.60	2.88
		Energy efficiency class *		A	C
		Energy rating **		—	—
	Heating	Running current	(A)	8.14 – 7.46	12.91 – 11.84
		Power consumption	(kW)	1.55	2.4
		Power factor	(%)	95	94
		COP		3.61	3.33
		Energy efficiency class *		A	C
		Energy rating **		—	—
Maximum current			(A)	15.34	15.47
Appearance	Main unit		Pure white		
	Ceiling panel (Sold separately)	Model	—		
		Panel color	—		
Outer dimension	Main unit	Height	(mm)	298	298
		Width	(mm)	998	998
		Depth	(mm)	221	221
	Ceiling panel (Sold separately)	Height	(mm)	—	—
		Width	(mm)	—	—
		Depth	(mm)	—	—
Total weight	Main unit		(kg)	12	12
	Ceiling panel (Sold separately)		(kg)	—	—
Heat exchanger			Finned tube		
Fan unit	Fan		Cross flow fan		Cross flow fan
	Standard air flow	H/M/L	(m ³ /min.)	14.0 / 12.5 / 10.7	18.5 / 14.6 / 12.2
	Motor		(W)	30	30
Air filter			Attached main unit		
Controller (Sold separately)			RBC-AMT31E, AMS41E, AS21E2, TCB-SC642TLE2, AX21UCE2 (FCU comes with WH-H2UE)		
Sound pressure level		H/M/L	(dB•A)	39 / 36 / 33	45 / 41 / 36
Sound power level		H/M/L	(dB•A)	54 / 51 / 48	60 / 56 / 51
Connecting pipe	Gas side	(mm)	12.7	15.9	
	Liquid side	(mm)	6.4	9.5	
	Drain port	(mm)	VP16		

* : IEC standard, ** : AS standard

<Twin type>

Model	Indoor unit 1		RAV-	SM562KRT-E	SM802KRT-E	
	Indoor unit 2		RAV-	SM562KRT-E	SM802KRT-E	
	Outdoor unit		RAV-	SP1104AT(Z)(ZG)-E	SP1404AT(Z)(ZG)-E	
Cooling capacity			(kW)	10.0	12.3	
Heating capacity			(kW)	11.2	14.0	
Indoor unit						
Power supply				1 phase 230V (220 – 240V) 50Hz		
Electrical characteristics	Cooling	Running current	(A)	12.98 – 11.90	18.00 – 16.50	
		Power consumption	(kW)	2.77	3.88	
		Power factor	(%)	97	98	
		EER		3.61	3.17	
		Energy efficiency class *		A	B	
	Heating	Running current	(A)	13.12 – 12.03	17.76 – 16.28	
		Power consumption	(kW)	2.80	3.83	
		Power factor	(%)	97	98	
		COP		4.00	3.66	
		Energy efficiency class *		A	A	
Fan unit	Fan			Cross flow fan		
	Standard air flow	H/M/L	(m ³ /min.)	14.0 / 12.5 / 10.7	18.5 / 14.6 / 12.2	
	Motor		(W)	30	30	
Sound pressure level		H/M/L	(dB•A)	39 / 36 / 33	45 / 41 / 36	
Sound power level		H/M/L	(dB•A)	54 / 51 / 48	60 / 56 / 51	
Outdoor unit						
Power supply				1 phase 230V (220 – 240V) 50Hz		
Refrigerant pipe	Standard length		(m)	7.5	7.5	
	Min. length		(m)	3	3	
	Max. total length		(m)	50	50	
	Refrigerant charging amount (Charge-less up to 30m)			40g/m (31m to 50m)		
	Height difference	Outdoor lower		(m)	30	30
		Outdoor higher		(m)	30	30
Fan unit	Fan			Propeller fan		
	Standard air flow volume		(m ³ /min.)	101	103	
	Motor		(W)	100 + 100	100 + 100	
Connecting pipe	Gas side	Main	(mm)	15.9	15.9	
		Sub	(mm)	12.7	15.9	
	Liquid side	Main	(mm)	9.5	9.5	
		Sub	(mm)	6.4	9.5	
Sound pressure level		Cooling/Heating	(dB•A)	49 / 50	51 / 52	
Sound power level		Cooling/Heating	(dB•A)	66 / 67	68 / 69	

* : IEC standard

1-1-5. Compact 4-Way Cassette (600 × 600) Type

<Single type>

Model	Indoor unit		RAV-SM562MUT-E
	Outdoor unit		RAV-SP562AT(Z)(ZG)-E
Cooling capacity		(kW)	5.0
Heating capacity		(kW)	5.6
Power supply			1 phase 230V (220 – 240V) 50Hz
Electrical characteristics	Cooling	Running current (A)	6.6 – 7.15
		Power consumption (kW)	1.53
		Power factor (%)	97
		EER	3.27
		Energy efficiency class	A
		Energy rating	4.5
	Heating	Running current (A)	6.62 – 7.21
		Power consumption (kW)	1.54
		Power factor (%)	97
		COP	3.64
		Energy efficiency class	A
		Energy rating	4.5
Maximum current (A)			15.53
Appearance	Main unit		Zinc hot dipping steel plate
	Ceiling panel (Sold separately)	Model	RBC-UM11PG(W)-E
		Panel color	Moon-white (Muncel 2.5GY 9.0 / 0.5)
Outer dimension	Main unit	Height (mm)	268
		Width (mm)	575
		Depth (mm)	575
	Ceiling panel (Sold separately)	Height (mm)	27
		Width (mm)	700
		Depth (mm)	700
Total weight	Main unit (kg)		17
	Ceiling panel (Sold separately) (kg)		3
Heat exchanger			Finned tube
Fan unit	Fan		Turbo fan
	Standard air flow	H/M/L (m ³ /min.)	13.3 / 11.2 / 9.1
	Motor (W)		60
Air filter			—
Controller (Sold separately)			As per enclosure
Sound pressure level		H/M/L (dB•A)	43 / 39 / 34
Sound power level		H/M/L (dB•A)	58 / 54 / 49
Connecting pipe	Gas side (mm)		12.7
	Liquid side (mm)		6.4
	Drain port (mm)		VP25

<Twin type>

Model	Indoor unit 1		RAV-	SM562MUT-E	
	Indoor unit 2		RAV-	SM562MUT-E	
	Outdoor unit		RAV-	SP1104AT(Z)(ZG)-E	
Cooling capacity			(kW)	10.0	
Heating capacity			(kW)	11.2	
Indoor unit					
Power supply			1 phase 230V (220 – 240V) 50Hz		
Electrical characteristics	Cooling	Running current		(A)	12.51 – 11.47
		Power consumption		(kW)	2.67
		Power factor		(%)	97
		EER			3.75
		Energy efficiency class *			A
	Heating	Running current		(A)	12.51 – 11.47
		Power consumption		(kW)	2.67
		Power factor		(%)	97
		COP			4.19
		Energy efficiency class *			A
Fan unit	Fan		Turbo fan		
	Standard air flow	H/M/L	(m ³ /min.)	13.3 / 11.2 / 9.1	
	Motor		(W)	60	
Sound pressure level		H/M/L	(dB•A)	43 / 39 / 34	
Sound power level		H/M/L	(dB•A)	58 / 54 / 49	
Outdoor unit					
Power supply			1 phase 230V (220 – 240V) 50Hz		
Refrigerant pipe	Standard length		(m)	7.5	
	Min. length		(m)	3	
	Max. total length		(m)	50	
	Refrigerant charging amount (Charge-less up to 30m)			40g/m (31m to 50m)	
	Height difference	Outdoor lower		(m)	30
		Outdoor higher		(m)	30
Fan unit	Fan		Propeller fan		
	Standard air flow volume		(m ³ /min.)	101	
	Motor		(W)	100 + 100	
Connecting pipe	Gas side	Main	(mm)	15.9	
		Sub	(mm)	12.7	
	Liquid side	Main	(mm)	9.5	
		Sub	(mm)	6.4	
Sound pressure level		Cooling/Heating	(dB•A)	49 / 50	
Sound power level		Cooling/Heating	(dB•A)	66 / 67	

* : IEC standard

1-1-6. Slim Duct Type

<Single type>

Model	Indoor unit		RAV-SM	404SDT-E	454SDT-E	564SDT-E	
	Outdoor unit		RAV-SP	404AT(Z)(ZG)-E	454AT(Z)(ZG)-E	562AT(Z)(ZG)-E	
Cooling capacity			(kW)	3.6	4.0	5.0	
Heating capacity			(kW)	4.0	4.5	5.6	
Power supply			1 phase 230V (220 – 240V) 50Hz				
Electrical characteristics	Cooling	Running current	(A)	5.20 – 4.77	5.87 – 5.38	7.26 – 6.66	
		Power consumption	(kW)	1.03	1.20	1.55	
		Power factor	(%)	90	93	97	
		EER		3.50	3.33	3.23	
		Energy efficiency class *		A	A	A	
		Energy rating **		5.0	4.5	4.0	
	Heating	Running current	(A)	4.94 – 4.53	5.62 – 5.15	6.75 – 6.19	
		Power consumption	(kW)	1.00	1.15	1.44	
		Power factor	(%)	92	93	97	
		COP		4.00	3.91	3.89	
		Energy efficiency class *		A	A	A	
		Energy rating **		5.5	5.0	5.0	
Maximum current			(A)	15.00	15.00	15.00	
Appearance	Main unit		Zinc hot dipping steel plate				
	Ceiling panel (Sold separately)	Model	—				
		Panel color	—				
Outer dimension	Main unit	Height	(mm)	210	210	210	
		Width	(mm)	845	845	845	
		Depth	(mm)	645	645	645	
	Ceiling panel (Sold separately)	Height	(mm)	—	—	—	
		Width	(mm)	—	—	—	
		Depth	(mm)	—	—	—	
Total weight	Main unit		(kg)	22	22	22	
	Ceiling panel (Sold separately)		(kg)	—	—	—	
Heat exchanger			Finned tube				
Fan unit	Fan		Centrifugal				
	Standard air flow	H/M/L	(m ³ /min.)	11.5 / 10.0 / 8.7	11.5 / 10.0 / 8.7	13.0 / 11.3 / 9.7	
	Motor		(W)	60	60	60	
	External static pressure	Standard (at shipment)		(Pa)	10		
		Set up for tap exchange		(Pa)	10 / 20 / 35 / 50		
Air filter			Standard filter attached (Long life filter)				
Controller (Sold separately)			RBC-AMT32E, AMS41E, AS21E2				
Sound pressure level	Under air inlet	H/M/L	(dB•A)	39 / 36 / 33	39 / 36 / 33	45 / 40 / 36	
	Back air inlet	H/M/L	(dB•A)	30 / 28 / 26	30 / 28 / 26	33 / 31 / 28	
Sound power level	Under air inlet	H/M/L	(dB•A)	54 / 51 / 48	54 / 51 / 48	60 / 55 / 51	
	Back air inlet	H/M/L	(dB•A)	45 / 43 / 41	45 / 43 / 41	48 / 46 / 43	
Connecting pipe	Gas side		(mm)	12.7	12.7	12.7	
	Liquid side		(mm)	6.4	6.4	6.4	
	Drain port		(mm)	VP25			

* : IEC standard, ** : AS standard

<Single type>

Model	Indoor unit		RAV-SM	564SDT-E	
	Outdoor unit		RAV-SM	563AT-E	
Cooling capacity			(kW)	5.0	
Heating capacity			(kW)	5.6	
Power supply				1 phase 230V (220 – 240V) 50Hz	
Electrical characteristics	Cooling	Running current		(A)	7.94 – 7.28
		Power consumption		(kW)	1.66
		Power factor		(%)	95
		EER			3.01
		Energy efficiency class *			B
		Energy rating **			3.5
	Heating	Running current		(A)	7.61 – 6.97
		Power consumption		(kW)	1.59
		Power factor		(%)	95
		COP			3.52
		Energy efficiency class *			B
Energy rating **			4.0		
Maximum current			(A)	15.00	
Appearance	Main unit			Zinc hot dipping steel plate	
	Ceiling panel (Sold separately)	Model		—	
		Panel color		—	
Outer dimension	Main unit	Height		(mm)	210
		Width		(mm)	845
		Depth		(mm)	645
	Ceiling panel (Sold separately)	Height		(mm)	—
		Width		(mm)	—
		Depth		(mm)	—
Total weight	Main unit		(kg)	22	
	Ceiling panel (Sold separately)		(kg)	—	
Heat exchanger				Finned tube	
Fan unit	Fan			Centrifugal	
	Standard air flow	H/M/L	(m ³ /min.)	13.0 / 11.3 / 9.7	
	Motor		(W)	60	
	External static pressure	Standard (at shipment)		(Pa)	10
		Set up for tap exchange		(Pa)	10 / 20 / 35 / 50
Air filter				Standard filter attached (Long life filter)	
Controller (Sold separately)				RBC-AMT32E, AMS41E, AS21E2	
Sound pressure level	Under air inlet	H/M/L	(dB•A)	45 / 40 / 36	
	Back air inlet	H/M/L	(dB•A)	33 / 31 / 28	
Sound power level	Under air inlet	H/M/L	(dB•A)	60 / 55 / 51	
	Back air inlet	H/M/L	(dB•A)	48 / 46 / 43	
Connecting pipe	Gas side		(mm)	12.7	
	Liquid side		(mm)	6.4	
	Drain port		(mm)	VP25	

* : IEC standard, ** : AS standard

<Twin type>

Model	Indoor unit 1		RAV-SM	564SDT-E	564SDT-E
	Indoor unit 2		RAV-SM	564SDT-E	564SDT-E
	Outdoor unit		RAV-SP	1104AT(Z)(ZG)-E	1102AT(Z)(ZG)-E
Cooling capacity			(kW)	10.0	10.0
Heating capacity			(kW)	11.2	11.2
Indoor unit					
Power supply			1 phase 230V (220 – 240V) 50Hz		
Electrical characteristics	Cooling	Running current	(A)	12.98 – 11.90	11.72 – 10.74
		Power consumption	(kW)	2.77	2.50
		Power factor	(%)	97	97
		EER		3.61	4.00
		Energy efficiency class *		A	A
	Heating	Running current	(A)	12.51 – 11.47	11.95 – 10.95
		Power consumption	(kW)	2.67	2.55
		Power factor	(%)	97	97
		COP		4.19	4.39
		Energy efficiency class *		A	A
Fan unit	Fan		Centrifugal		
	Standard air flow	H/M/L	(m ³ /min.)	13.0 / 11.3 / 9.7	13.0 / 11.3 / 9.7
	Motor		(W)	60	60
Sound pressure level	Under air inlet	H/M/L	(dB•A)	45 / 40 / 36	45 / 40 / 36
	Back air inlet	H/M/L	(dB•A)	33 / 31 / 28	33 / 31 / 28
Sound power level	Under air inlet	H/M/L	(dB•A)	60 / 55 / 51	60 / 55 / 51
	Back air inlet	H/M/L	(dB•A)	48 / 46 / 43	48 / 46 / 43
Outdoor unit					
Power supply			1 phase 230V (220 – 240V) 50Hz		
Refrigerant pipe	Standard length		(m)	7.5	7.5
	Min. length		(m)	3	5
	Max. total length		(m)	50	50
	Refrigerant charging amount (Charge-less up to 30m)			40g/m (31m to 50m)	
	Height difference	Outdoor lower	(m)	30	30
		Outdoor higher	(m)	30	30
Fan unit	Fan		Propeller fan		
	Standard air flow volume		(m ³ /min.)	101	125
	Motor		(W)	100 + 100	63 + 63
Connecting pipe	Gas side	Main	(mm)	15.9	15.9
		Sub	(mm)	12.7	12.7
	Liquid side	Main	(mm)	9.5	9.5
		Sub	(mm)	6.4	6.4
Sound pressure level	Cooling/Heating		(dB•A)	49 / 50	49 / 51
Sound power level	Cooling/Heating		(dB•A)	66 / 67	66 / 68

* : IEC standard

<Twin type>

Model	Indoor unit 1		RAV-SM	564SDT-E	
	Indoor unit 2		RAV-SM	564SDT-E	
	Outdoor unit		RAV-SM	1103AT-E	
Cooling capacity			(kW)	10.0	
Heating capacity			(kW)	11.2	
Indoor unit					
Power supply			1 phase 230V (220 – 240V) 50Hz		
Electrical characteristics	Cooling	Running current (A)		16.47 – 15.09	
		Power consumption (kW)		3.55	
		Power factor (%)		98	
		EER		2.82	
		Energy efficiency class *		C	
	Heating	Running current (A)		14.56 – 13.35	
		Power consumption (kW)		3.14	
		Power factor (%)		98	
		COP		3.57	
		Energy efficiency class *		B	
Fan unit	Fan			Centrifugal	
	Standard air flow	H/M/L	(m ³ /min.)	13.0 / 11.3 / 9.7	
	Motor (W)			60	
Sound pressure level	Under air inlet	H/M/L	(dB•A)	45 / 40 / 36	
	Back air inlet	H/M/L	(dB•A)	33 / 31 / 28	
Sound power level	Under air inlet	H/M/L	(dB•A)	60 / 55 / 51	
	Back air inlet	H/M/L	(dB•A)	48 / 46 / 43	
Outdoor unit					
Power supply			1 phase 230V (220 – 240V) 50Hz		
Outer dimension	Standard length (m)		7.5		
	Min. length (m)		5		
	Max. total length (m)		50		
	Over 30m		40g/m (31m to 50m)		
	Height difference	Outdoor lower (m)		30	
		Outdoor higher (m)		30	
Fan unit	Fan			Propeller fan	
	Standard air flow volume (m ³ /min.)		75		
	Motor (W)			100	
Connecting pipe	Gas side	Main (mm)	15.9		
		Sub (mm)	12.7		
	Liquid side	Main (mm)	9.5		
		Sub (mm)	6.4		
Sound pressure level	Cooling/Heating		(dB•A)	53 / 54	
Sound power level	Cooling/Heating		(dB•A)	70 / 71	

* : IEC standard

1-2. Outdoor Unit

<Super Digital Inverter>

Model name	Outdoor unit	RAV-SP	562AT(Z)(ZG)-E	802AT(Z)(ZG)-E	1104AT(Z)(ZG)-E	1404AT(Z)(ZG)-E
Power supply		1 phase 230V (220 – 240V) 50Hz (Power exclusive to outdoor is required.)				
Compressor	Type	Hermetic compressor				
	Motor (kW)	2	2	3.75	3.75	
	Pole	4	4	4	4	
Refrigerant charged		(kg)	1.5	2.1	3.1	3.1
Refrigerant control		Pulse motor valve				
Inter connecting pipe	Standard length	(m)	7.5	7.5	7.5	7.5
	Max. total length	(m)	50	50	75	75
	Additional refrigerant charge under long piping connector		20g/m (21m to 50m)	40g/m (31m to 50m)	40g/m (31m to 75m)	40g/m (31m to 75m)
	Height difference	Outdoor lower	(m)	30	30	30
Outdoor higher		(m)	30	30	30	30
Outer dimension	Height	(mm)	795	795	1340	1340
	Width	(mm)	900	900	900	900
	Depth	(mm)	320	320	320	320
Appearance		Silky shade (Muncel 1Y8.5/0.5)				
Total weight		(kg)	55	62	93	93
Heat exchanger		Finned tube				
Fan unit	Fan	Propeller fan				
	Standard air flow	(m ³ /min.)	57	57	101	103
	Motor	(W)	63	63	100 + 100	100 + 100
Connecting pipe	Gas side	(mm)	12.7	15.9	15.9	15.9
	Liquid side	(mm)	6.4	9.5	9.5	9.5
Sound pressure level		Cooling/Heating (dB•A)	46 / 47	47 / 49	49 / 50	51 / 52
Sound power level		Cooling/Heating (dB•A)	63 / 64	64 / 66	66 / 67	68 / 69
Outside air temperature, Cooling		(°C)	43 to -15°C			
Outside air temperature, Heating		(°C)	15 to -15°C		15 to -20°C	

Model name	Outdoor unit	RAV-SP	404AT(Z)(ZG)-E	454AT(Z)(ZG)-E	
Power supply			1 phase 230V (220 – 240V) 50Hz (Power exclusive to outdoor is required.)		
Compressor	Type		Hermetic compressor		
	Motor	(kW)	1.1	1.1	
	Pole		4	4	
Refrigerant charged		(kg)	1.0	1.0	
Refrigerant control			Pulse motor valve		
Inter connecting pipe	Standard length		(m)	7.5	7.5
	Max. total length		(m)	30	30
	Additional refrigerant charge under long piping connector			20g/m (21m to 30m)	
	Height difference	Outdoor lower	(m)	30	30
Outdoor higher		(m)	30	30	
Outer dimension	Height		(mm)	550	550
	Width		(mm)	780	780
	Depth		(mm)	290	290
Appearance			Silky shade (Muncel 1Y8.5/0.5)		
Total weight		(kg)	40	40	
Heat exchanger			Finned tube		
Fan unit	Fan		Propeller fan		
	Standard air flow		(m ³ /min.)	40	40
	Motor		(W)	43	43
Connecting pipe	Gas side		(mm)	12.7	12.7
	Liquid side		(mm)	6.4	6.4
Sound pressure level		Cooling/Heating (dB•A)	45 / 47	45 / 47	
Sound power level		Cooling/Heating (dB•A)	62 / 64	62 / 64	
Outside air temperature, Cooling		(°C)	43 to –15°C		
Outside air temperature, Heating		(°C)	15 to –15°C		

1-3. Operation Characteristic Curve

• Operation characteristic curve <Super Digital Inverter>

RAV-SP1104AT-E, RAV-SP1104ATZ-E, RAV-SP1104ATZG-E

RAV-SP1404AT-E, RAV-SP1404ATZ-E, RAV-SP1404ATZG-E

<Cooling>

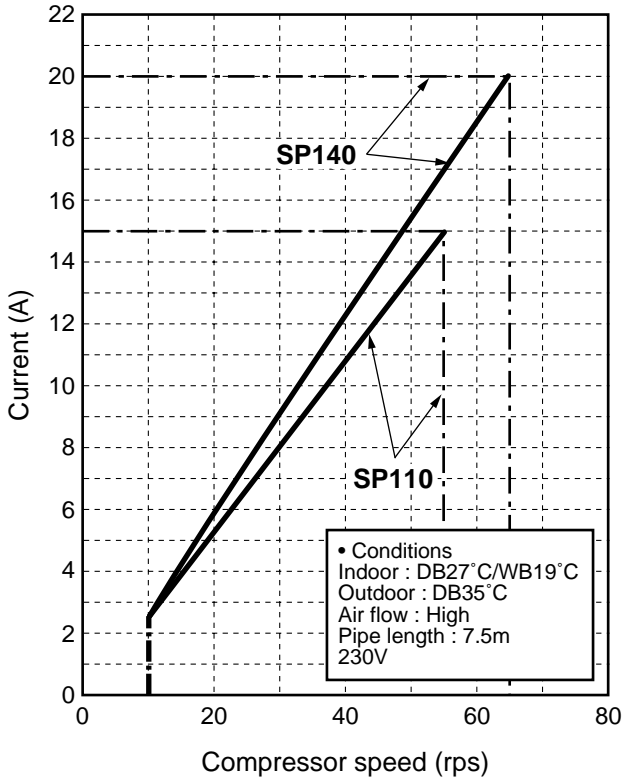

<Heating>

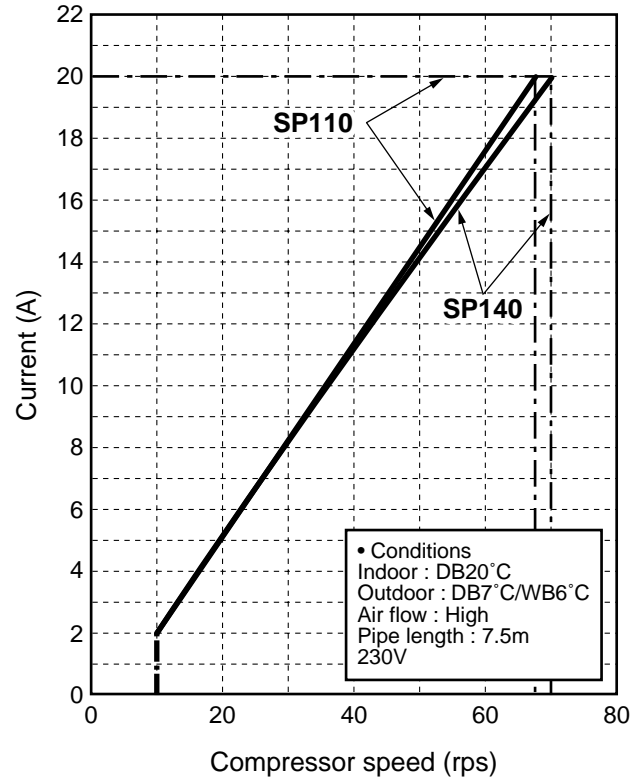

RAV-SP404AT-E, RAV-SP404ATZ-E, RAV-SP404ATZG-E

RAV-SP454AT-E, RAV-SP454ATZ-E, RAV-SP454ATZG-E

<Cooling>

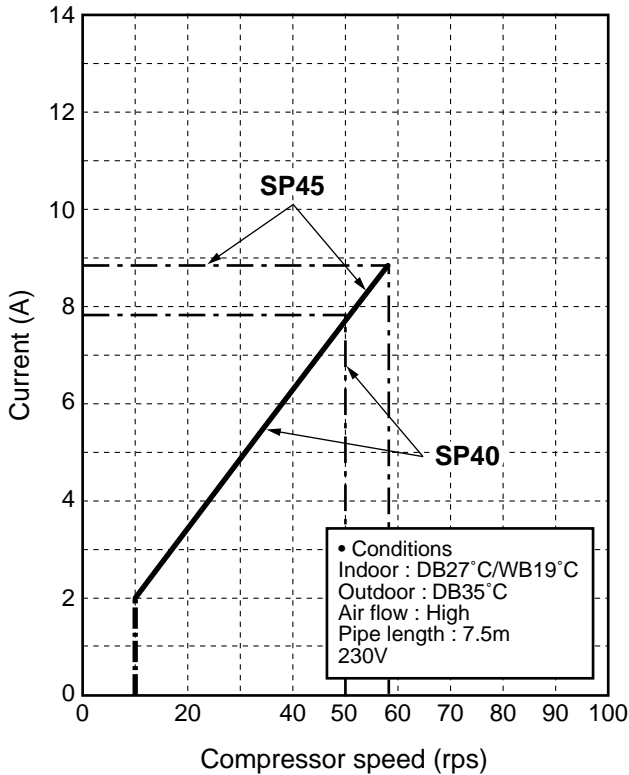

<Heating>

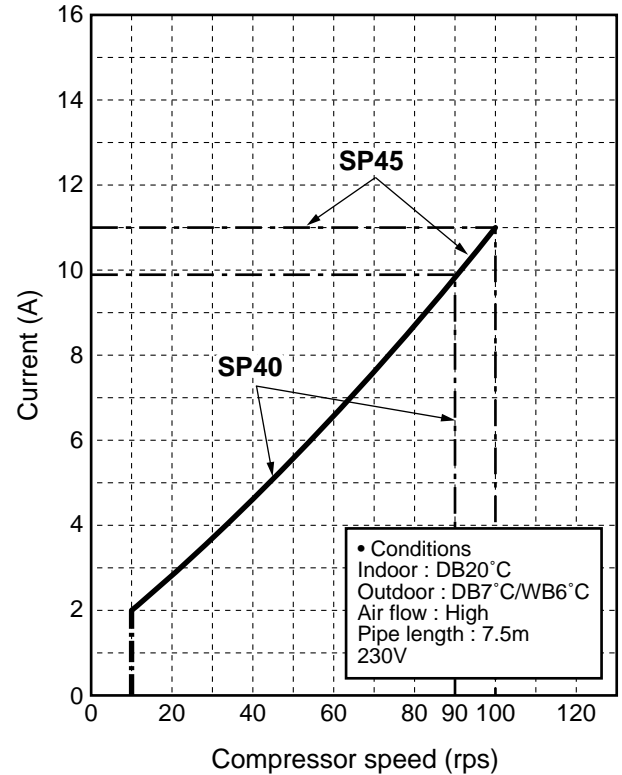

• Capacity variation ratio according to temperature

RAV-SP404AT-E, RAV-SP404ATZ-E, RAV-SP404ATZG-E
 RAV-SP454AT-E, RAV-SP454ATZ-E, RAV-SP454ATZG-E
 RAV-SP1104AT-E, RAV-SP1104ATZ-E, RAV-SP1104ATZG-E
 RAV-SP1404AT-E, RAV-SP1404ATZ-E, RAV-SP1404ATZG-E

<Cooling>

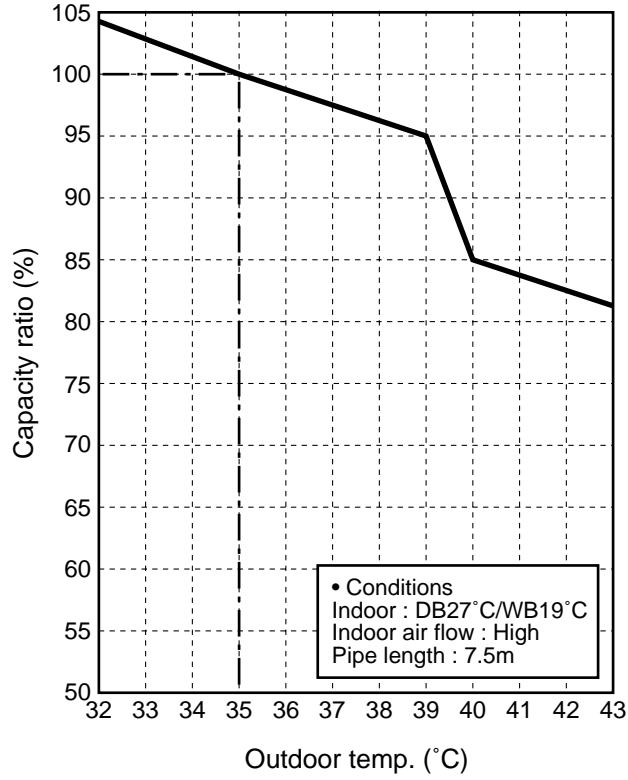

<Heating>

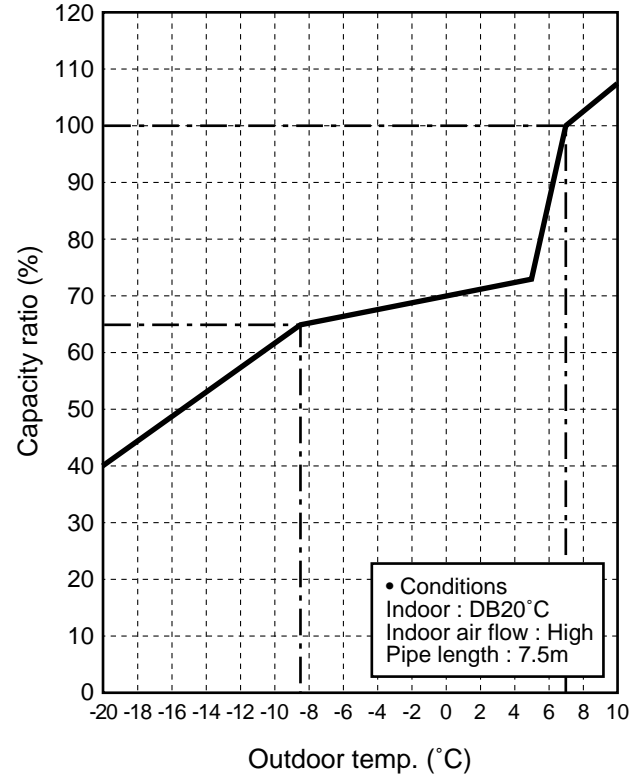

2. CONSTRUCTION VIEWS (EXTERNAL VIEWS)

2-1. Indoor Unit RAV-SM564UT-E

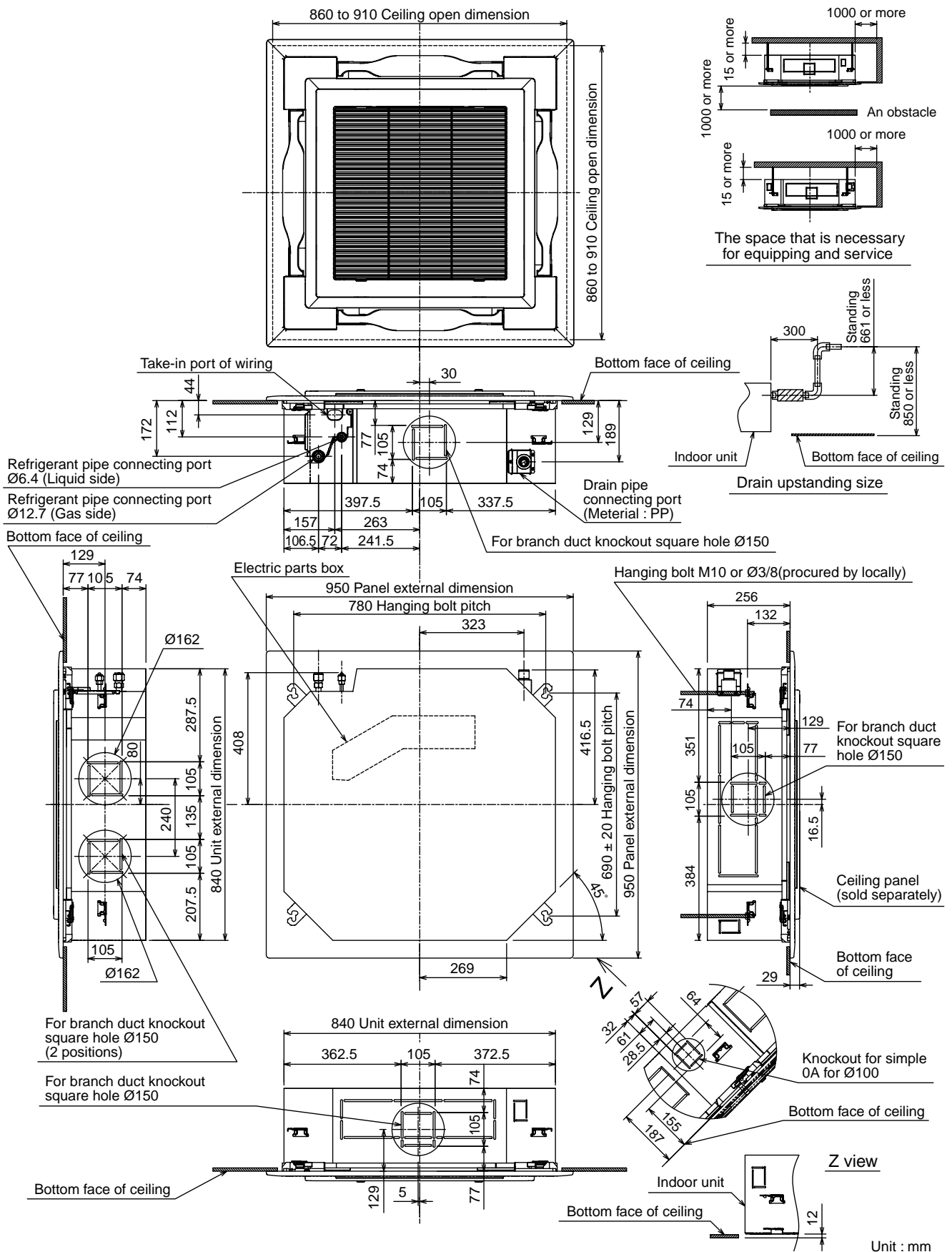

RAV-SM804UT-E

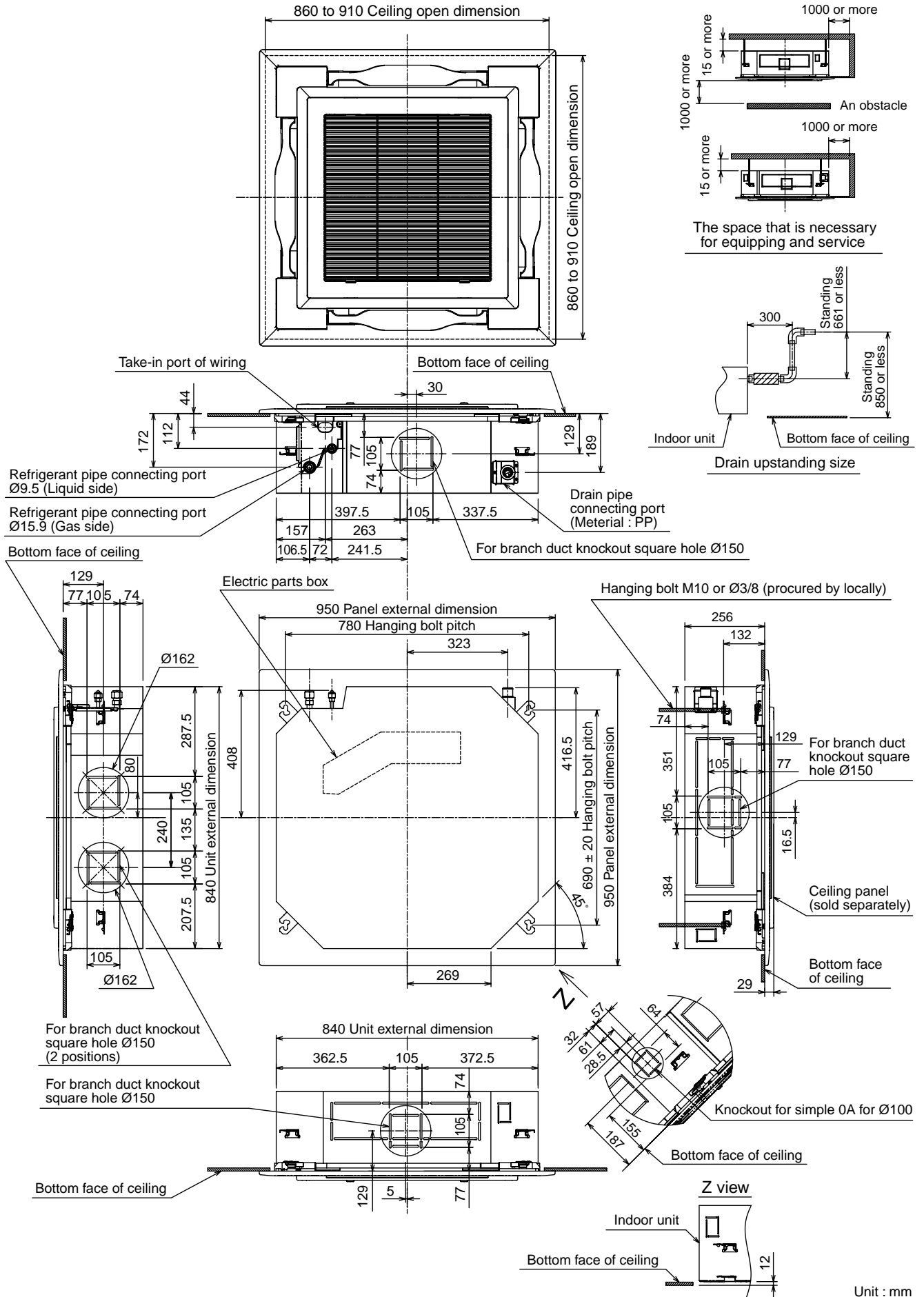

RAV-SM1104UT-E, RAV-SM1404UT-E, RAV-SM1604UT-E

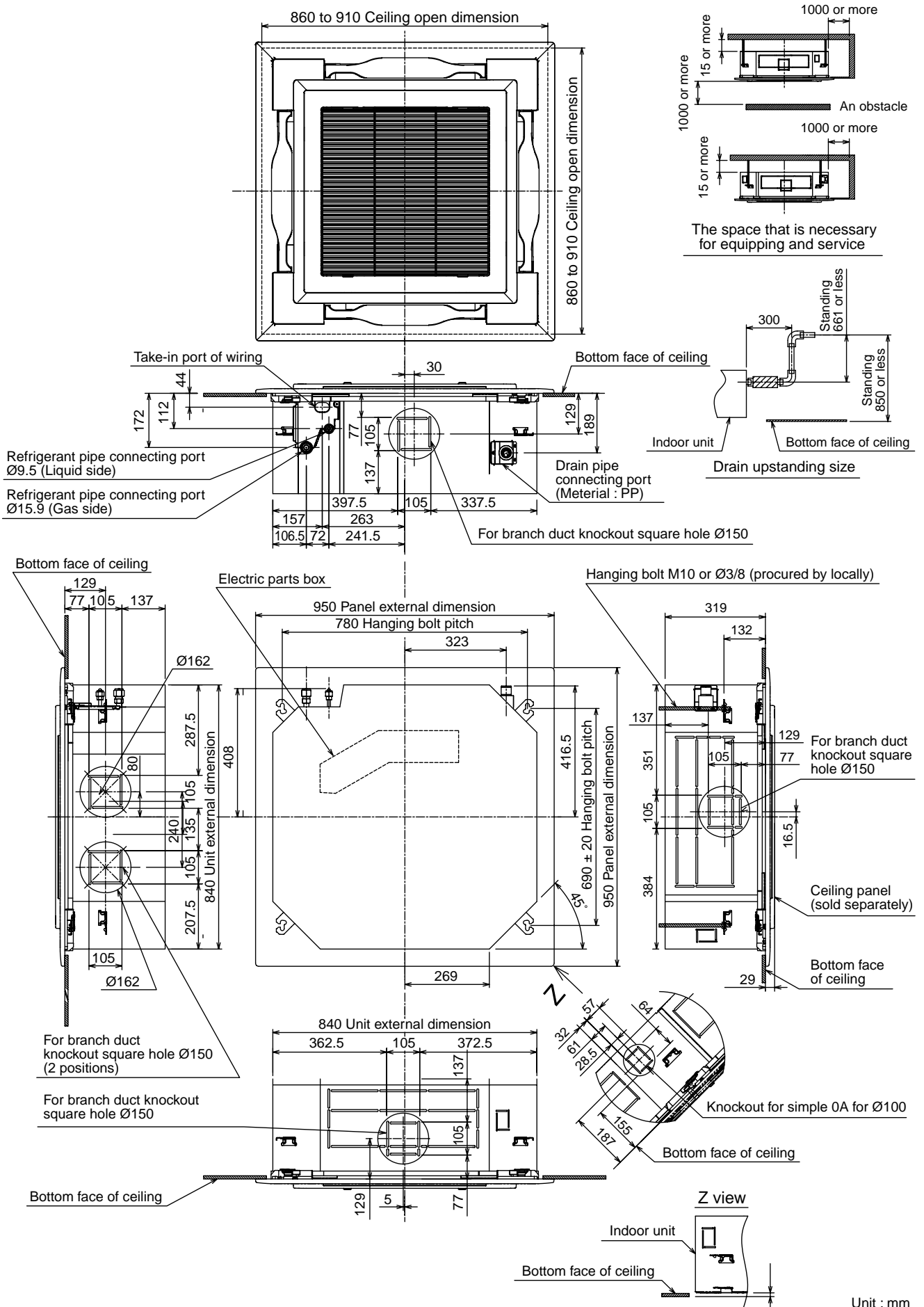

Unit : mm

RAV-SM404SDT-E, RAV-SM454SDT-E, RAV-SM564SDT-E

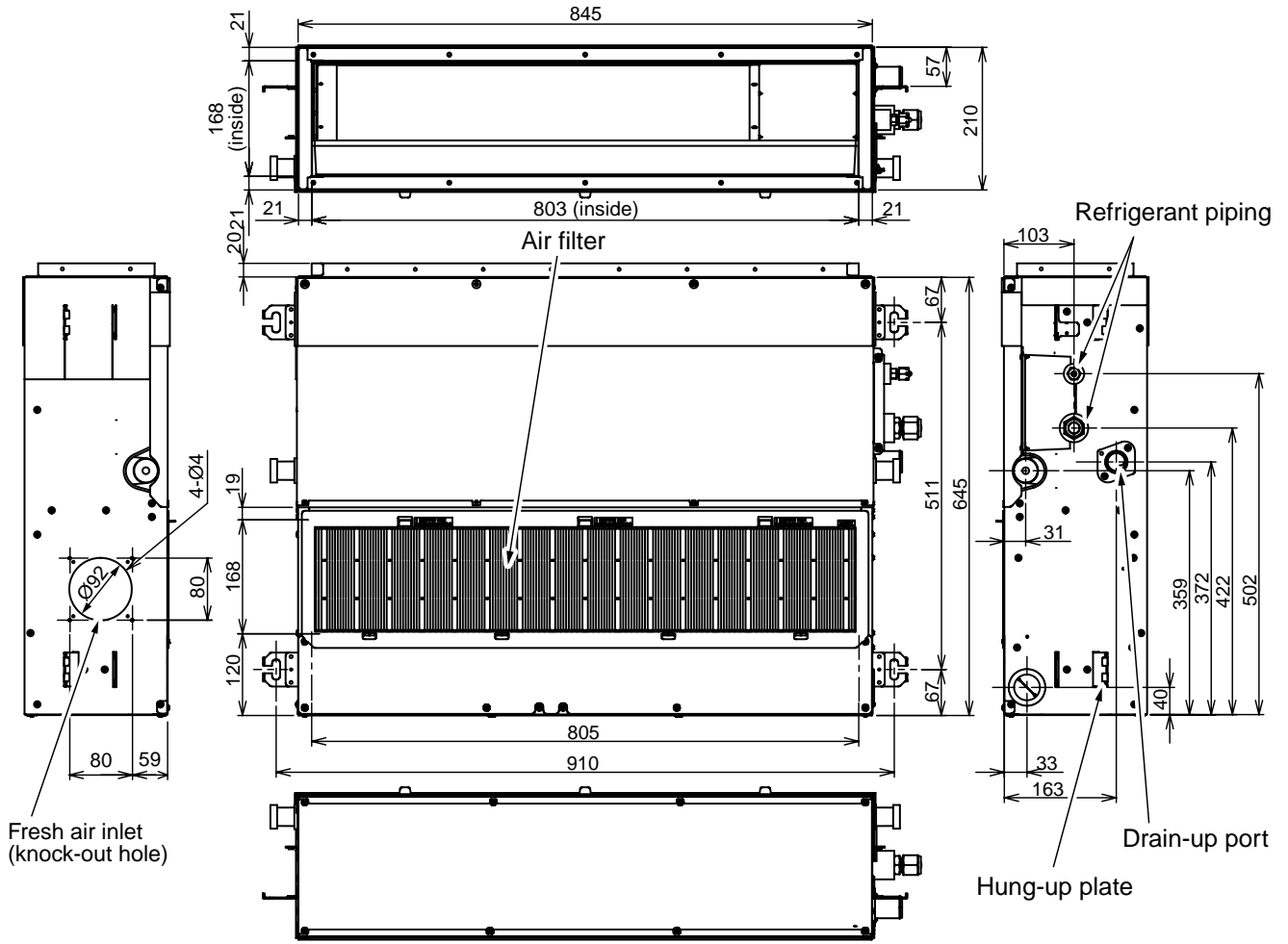

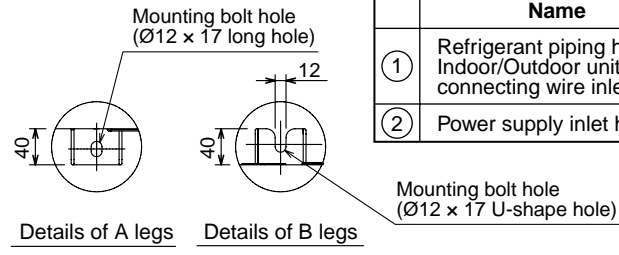
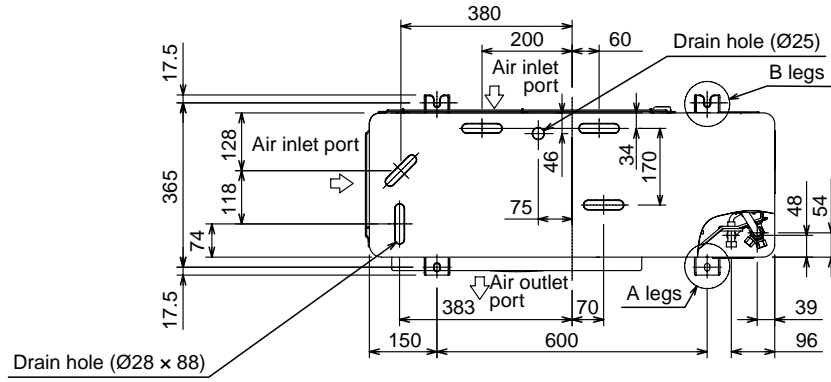

	Name	Note
①	Refrigerant piping hole Indoor/Outdoor unit connecting wire inlet hole	—
②	Power supply inlet hole	Ø38 Knockout hole

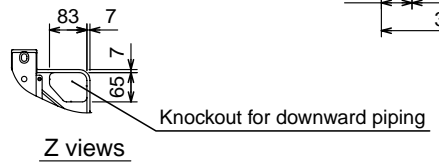
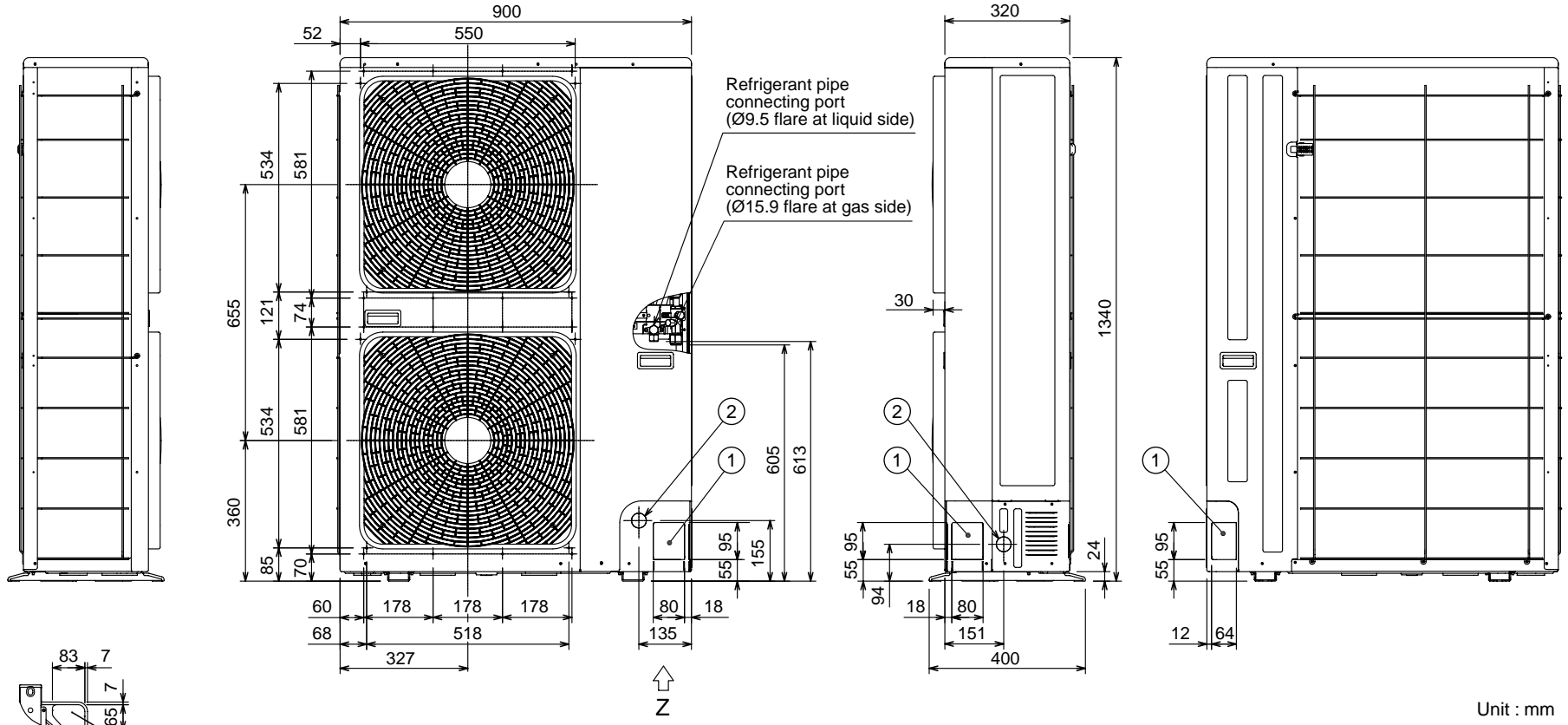

Unit : mm

2-2. Outdoor Unit
RAV-SP1104AT(Z)(ZG)-E, RAV-SP1404AT(Z)(ZG)-E

RAVSP404AT(Z)(ZG)-E, RAV-SP454AT(Z)(ZG)-E

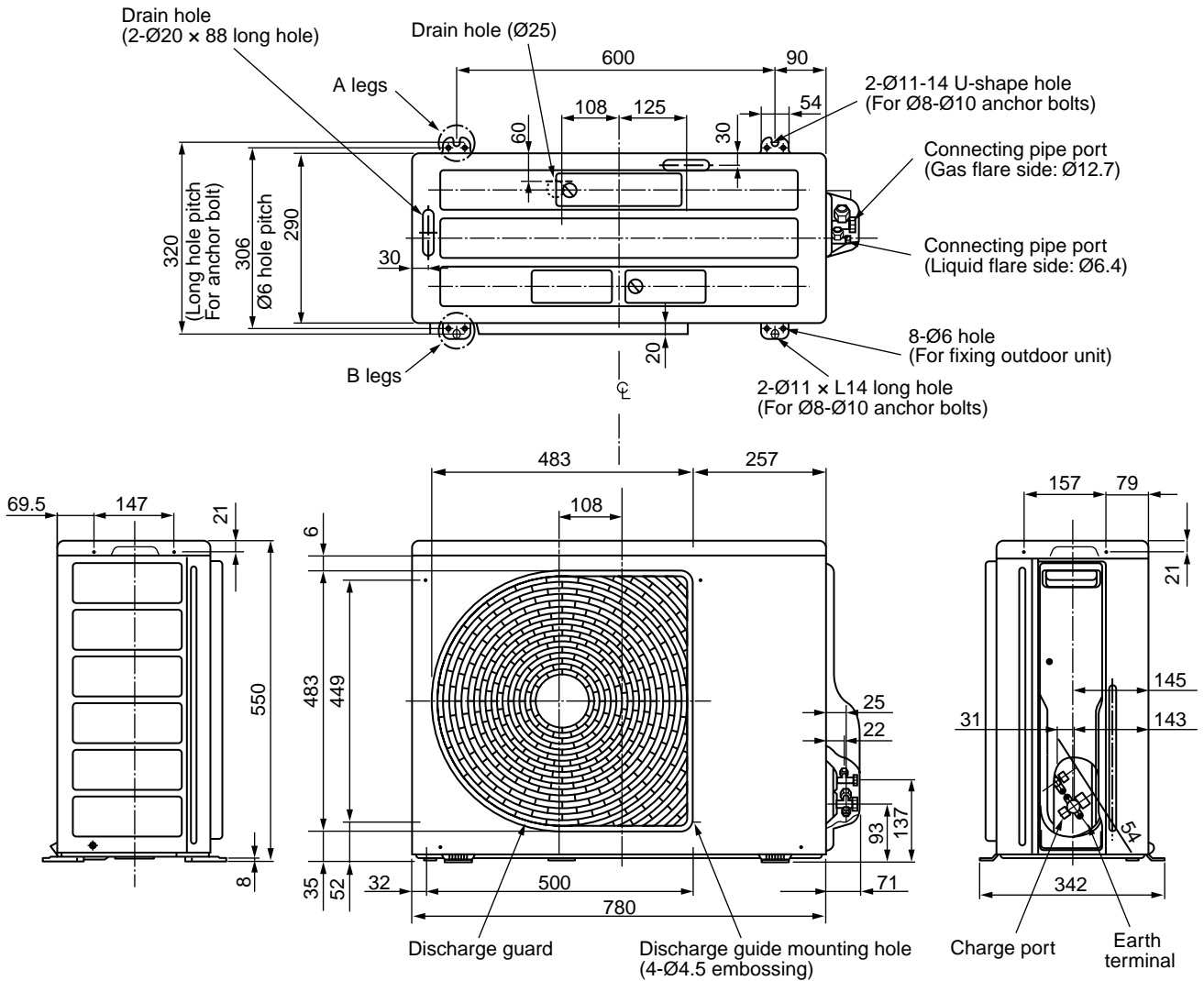

Space required for service

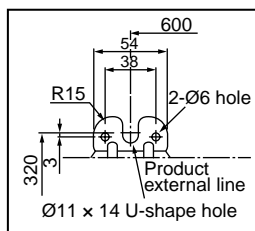
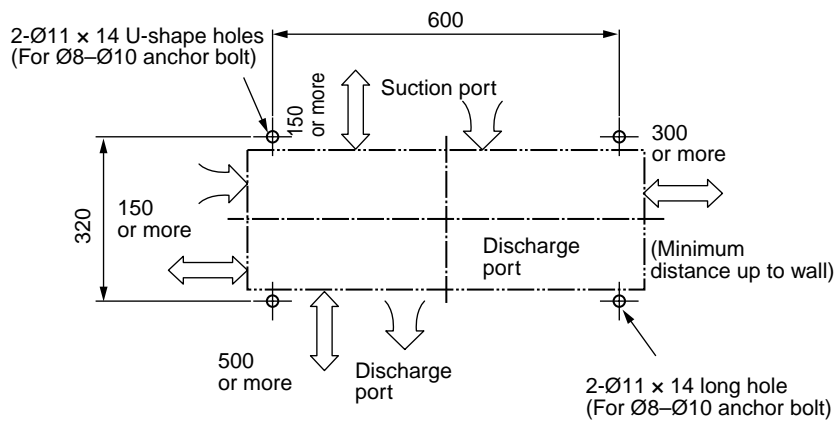

Details of A legs

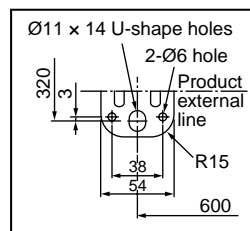

Details of B legs

RAV-TWP30E2, RAV-TWP50E2 (Simultaneous Twin)

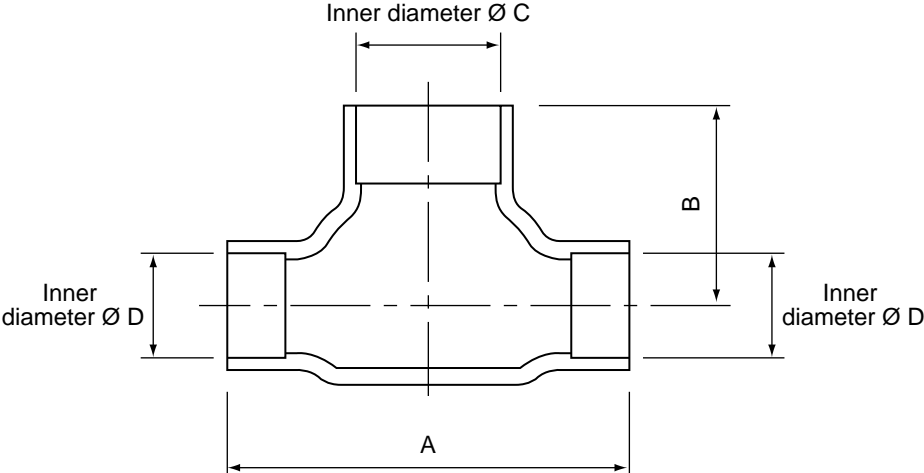

Model (RBC-)		A	B	C	D
TWP30E2	Liquid side	36	14	Ø9.5	Ø6.4
	Gas side	43	23	Ø15.9	Ø12.7
TWP50E2	Liquid side	34	14	Ø9.5	Ø9.5
	Gas side	44	21	Ø15.9	Ø15.9

3. SYSTEMATIC REFRIGERATING CYCLE DIAGRAM

3-1. Indoor Unit

- Single type (Combination of 1 indoor unit and 1 outdoor unit)

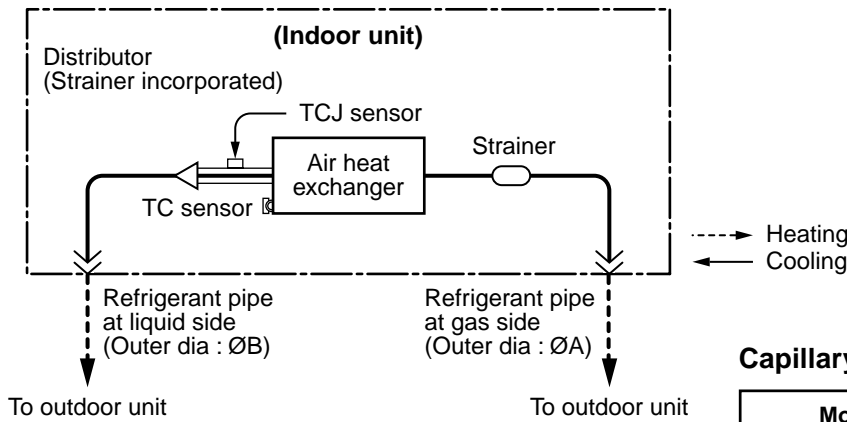

Capillary tube specifications

Model RAV-SM***UT	Inner dia. x Length x Q'ty
SM56 type	Ø2 x 250 x 2, Ø2 x 350 x 1 Ø2 x 700 x 1
SM80 type	Ø2 x 250 x 3, Ø2 x 500 x 1
SM110, 140, 160 type	Ø2 x 200 x 1, Ø2 x 300 x 2 Ø2 x 350 x 2, Ø2 x 700 x 1

Dimension table

Indoor unit	Outer diameter of refrigerant pipe	
	Gas side ØA	Liquid side ØB
SM80, 110, 140, 160 type	15.9	9.5

Model RAV-SM***SDT	Inner dia. x Length x Q'ty
SM40, 45, 56 type	Ø2 x 200 x 2, Ø2 x 350 x 1

- Twin type (Combination of 2 indoor units and 1 outdoor unit)

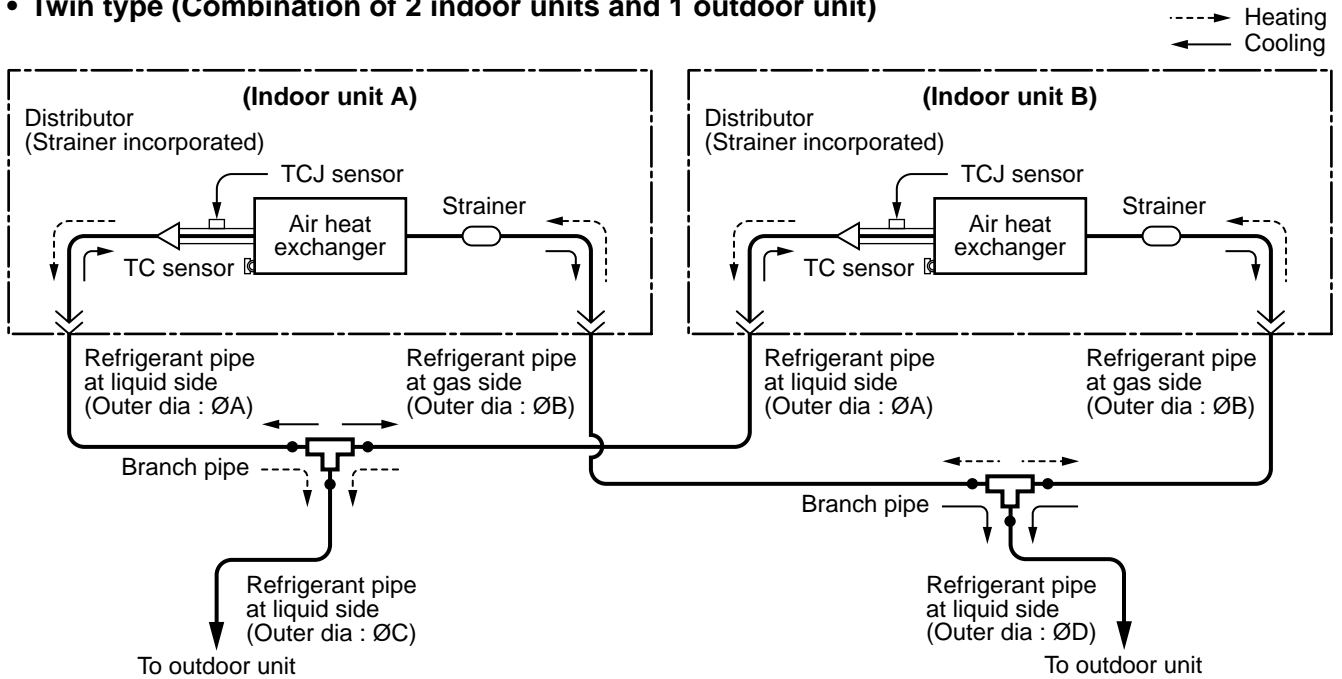

Indoor unit	Branch pipe RBC-	A	B	C	D
SM56 x 2	TWP30E2	6.4	12.7	9.5	15.9
SM80 x 2	TWP50E2	9.5	15.9	9.5	15.9

3-2. Outdoor Unit

RAV-SP1104AT-E, SP1104ATZ-E, SP1104ATZG-E, RAV-SP1404AT-E, SP1404ATZ-E, SP1404ATZG-E

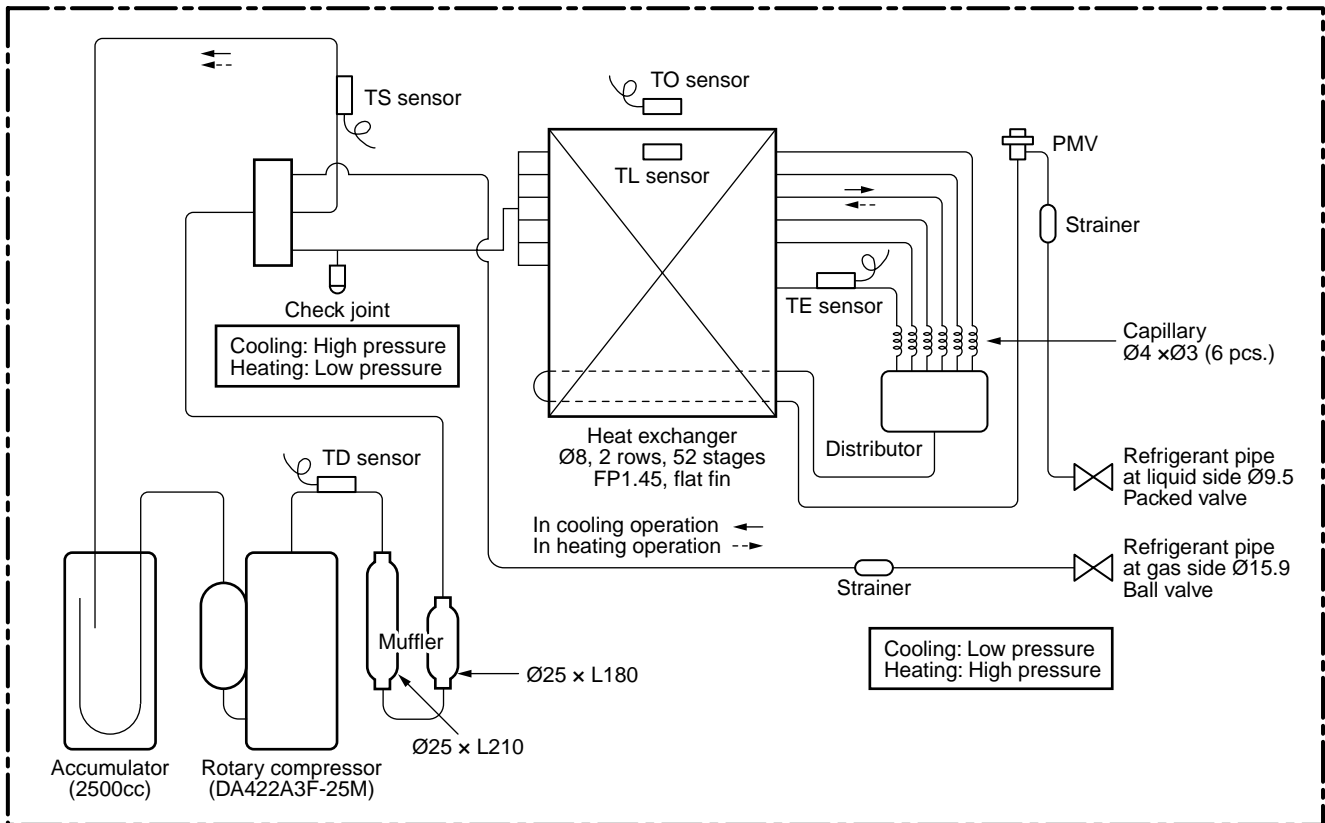

RAV-SP1104AT-E, RAV-SP1104ATZ-E, RAV-SP1104ATZG-E

		Pressure				Pipe surface temperature (°C)					Compressor drive revolution frequency (rps)	Indoor fan	Indoor/Outdoor temp. conditions (DB/WB) (°C)	
		(MPa)		(kg/cm ² g)		Discharge	Suction	Indoor heat exchanger	Outdoor heat exchanger				Indoor	Outdoor
		Pd	Ps	Pd	Ps	(TD)	(TS)	(TC)	(TL)	(TE)				
Cooling	Standard	2.57	0.99	26.2	10.1	66	14	12	44	38	38	HIGH	27/19	35/-
	Overload	3.30	1.09	33.7	11.1	78	9	13	49	43	53	HIGH	32/24	43/-
	Low load	1.74	0.75	17.8	7.7	46	7	5	32	25	21	LOW	18/15.5	-5/-
Heating	Standard	2.32	0.73	23.7	7.4	65	3	39	2	3	43	HIGH	20/-	7/6
	Overload	3.22	1.17	32.9	11.9	73	19	54	14	15	26	LOW	30/-	24/18
	Low load	2.17	0.30	22.1	3.1	87	-15	38	-14	-13	71	HIGH	15/-	-15/-

* This compressor has 4-pole motor. The value when compressor frequency (Hz) is measured by a clamp meter becomes 2 times of No. of compressor revolutions (rps).

RAV-SP1404AT-E, RAV-SP1404ATZ-E, RAV-SP1404ATZG-E

		Pressure				Pipe surface temperature (°C)					Compressor drive revolution frequency (rps)	Indoor fan	Indoor/Outdoor temp. conditions (DB/WB) (°C)	
		(MPa)		(kg/cm ² g)		Discharge	Suction	Indoor heat exchanger	Outdoor heat exchanger				Indoor	Outdoor
		Pd	Ps	Pd	Ps	(TD)	(TS)	(TC)	(TL)	(TE)				
Cooling	Standard	2.72	0.90	27.8	9.2	73	12	10	46	38	51	HIGH	27/19	35/-
	Overload	3.34	1.07	34.1	10.9	80	9	13	51	45	55	HIGH	32/24	43/-
	Low load	1.75	0.76	17.9	7.8	47	8	6	33	25	21	LOW	18/15.5	-5/-
Heating	Standard	2.59	0.69	26.4	7.0	75	3	43	2	2	53	HIGH	20/-	7/6
	Overload	3.13	1.05	31.9	10.7	72	16	53	12	13	26	LOW	30/-	24/18
	Low load	2.40	0.21	24.5	2.1	97	-22	42	-19	-18	90	HIGH	15/-	-15/-

* This compressor has 4-pole motor. The value when compressor frequency (Hz) is measured by a clamp meter becomes two times of No. of compressor revolutions (rps).

**RAV-SP404AT-E, RAV-SP404ATZ-E, RAV-SP404ATZG-E
RAV-SP454AT-E, RAV-SP454ATZ-E, RAV-SP454ATZG-E**

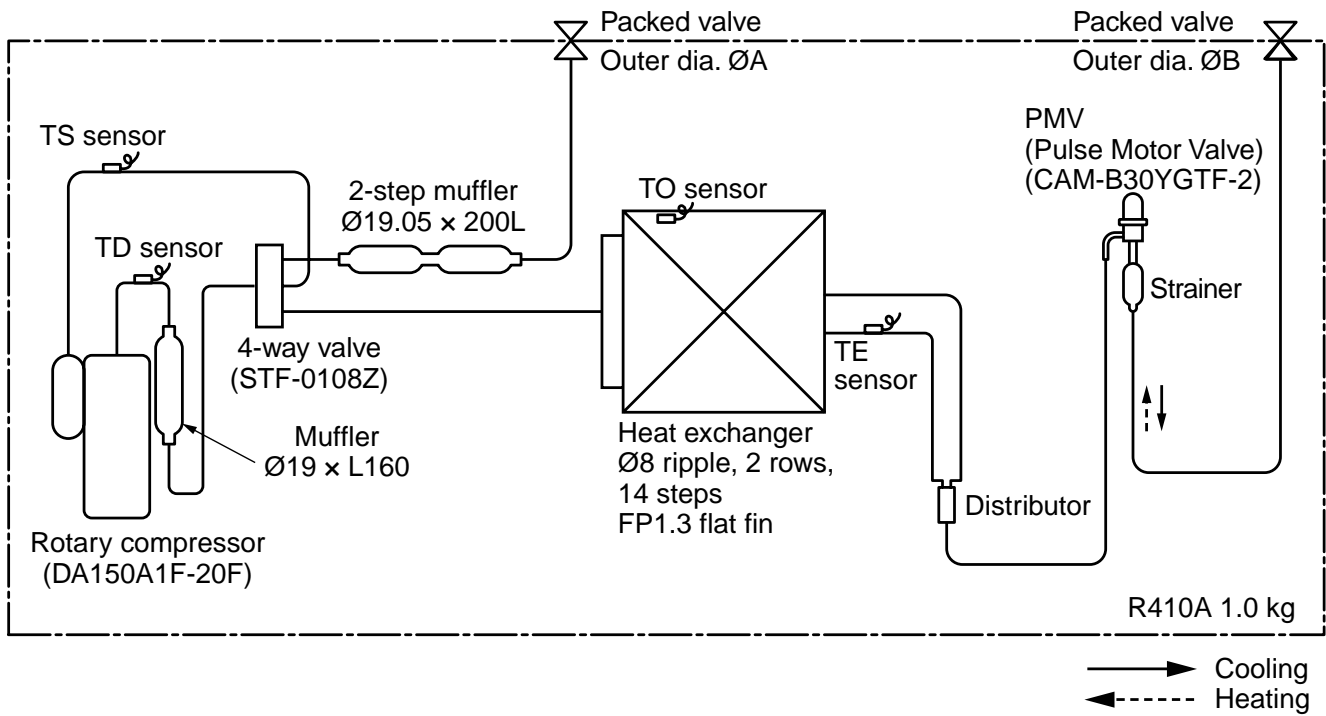

RAV-SP404AT-E, RAV-SP404ATZ-E, RAV-SP404ATZG-E

		Pressure				Pipe surface temperature (°C)				Compressor drive revolution frequency (rps)	Indoor fan	Indoor/Outdoor temp. conditions (DB/WB) (°C)	
		(MPa)		(kg/cm ² g)		Discharge	Suction	Indoor heat exchanger	Outdoor heat exchanger			Indoor	Outdoor
		Pd	Ps	Pd	Ps	(TD)	(TS)	(TC)	(TE)				
Cooling	Standard	2.68	0.94	27.3	9.6	61	12	11	43	47	HIGH	27/19	35/-
	Overload	3.23	1.16	32.9	11.8	77	14	15	50	50	HIGH	32/24	43/-
	Low load	1.34	0.70	13.7	7.1	36	4	2	8	44	LOW	18/15.5	-5/-
Heating	Standard	2.38	0.70	24.3	7.1	65	7	39	4	49	HIGH	20/-	7/6
	Overload	3.39	1.03	34.6	10.5	83	20	54	16	49	LOW	30/-	24/18
	Low load	1.95	0.26	19.9	2.7	90	-17	32	-19	90	HIGH	15/-	-15/-

* This compressor has 4-pole motor. The value when compressor frequency (Hz) is measured by a clamp meter becomes 2 times of No. of compressor revolutions (rps).

RAV-SP454AT-E, RAV-SP454ATZ-E, RAV-SP454ATZG-E

		Pressure				Pipe surface temperature (°C)				Compressor drive revolution frequency (rps)	Indoor fan	Indoor/Outdoor temp. conditions (DB/WB) (°C)	
		(MPa)		(kg/cm ² g)		Discharge	Suction	Indoor heat exchanger	Outdoor heat exchanger			Indoor	Outdoor
		Pd	Ps	Pd	Ps	(TD)	(TS)	(TC)	(TE)				
Cooling	Standard	2.81	0.89	28.7	9.1	68	11	10	41	53	HIGH	27/19	35/-
	Overload	3.24	1.16	33.0	11.8	78	14	15	51	53	HIGH	32/24	43/-
	Low load	1.34	0.70	13.7	7.1	36	4	2	8	44	LOW	18/15.5	-5/-
Heating	Standard	2.53	0.68	25.8	6.9	70	7	41	4	56	HIGH	20/-	7/6
	Overload	3.39	1.03	34.6	10.5	83	20	54	16	49	LOW	30/-	24/18
	Low load	2.00	0.25	20.4	2.6	92	-17	33	-19	98	HIGH	15/-	-15/-

* This compressor has 4-pole motor. The value when compressor frequency (Hz) is measured by a clamp meter becomes two times of No. of compressor revolutions (rps).

4. FAN CHARACTERISTICS

4-1. Slim Duct (Filter Attached)

RAV-SM404SDT-E, RAV-SM454SDT-E

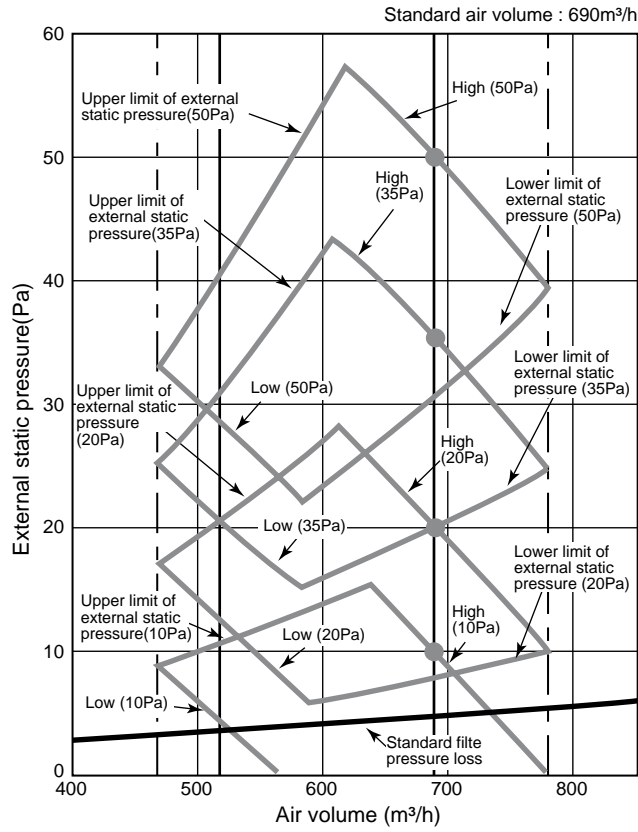

RAV-SM564SDT-E

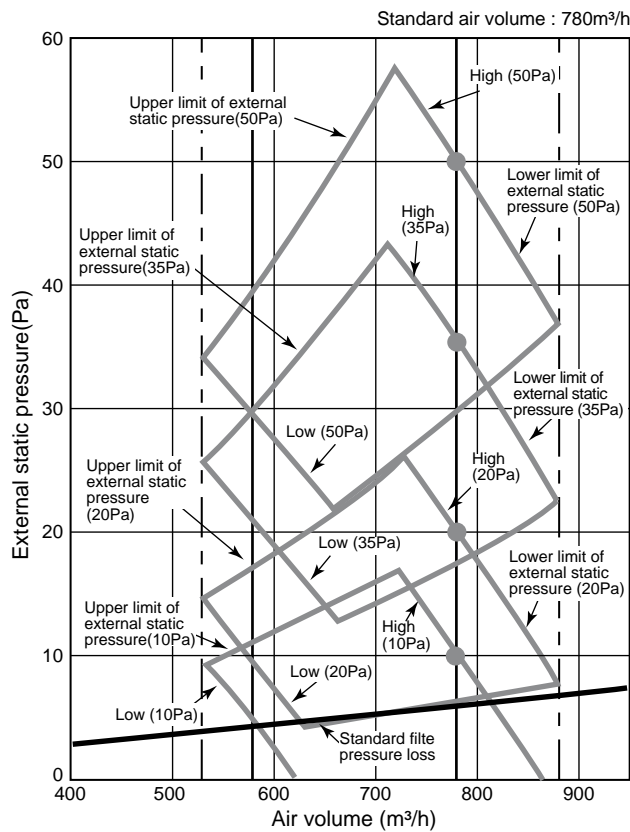

5. WIRING DIAGRAM

5-1. Indoor Unit

5-1-1. 4-Way Air Discharge Cassette Type

RAV-SM564UT-E, RAV-SM804UT-E, RAV-SM1104UT-E, RAV-SM1404UT-E, RAV-SM1604UT-E

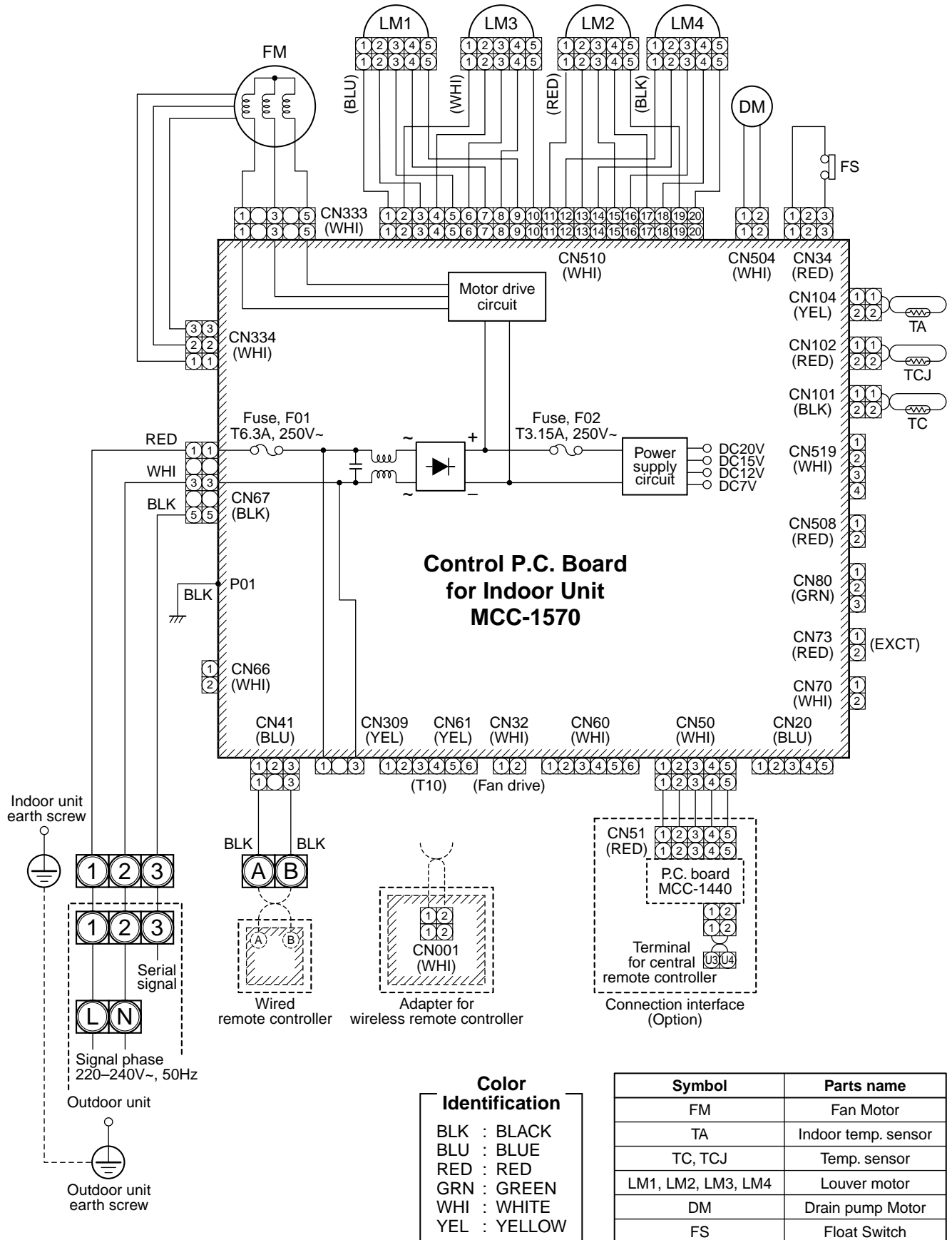

5-1-2. Slim Duct Type

RAV-SM404SDT-E, RAV-SM454SDT-E, RAV-SM564SDT-E

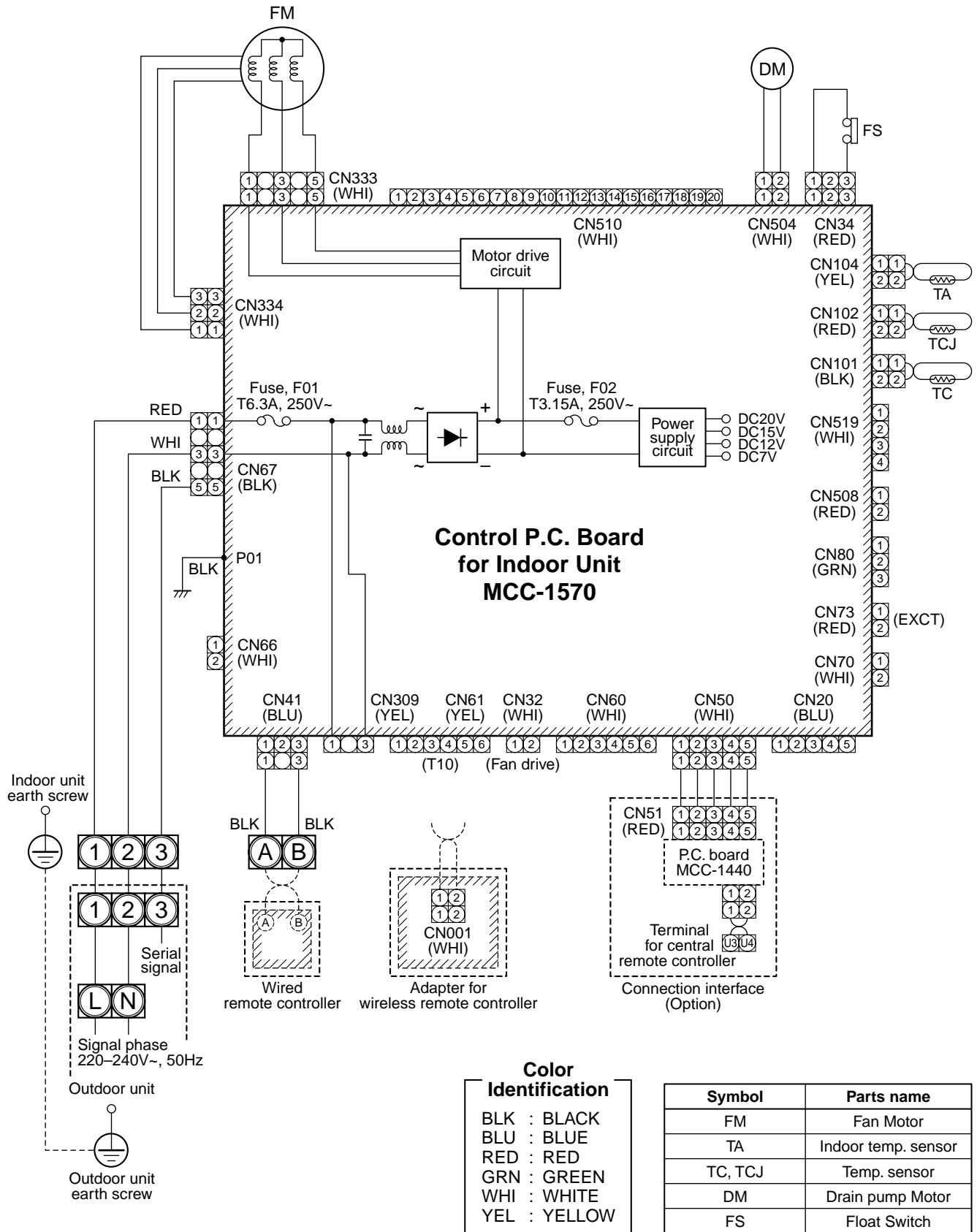

5-2. Outdoor Unit

RAV-SP1104AT-E, SP1104ATZ-E, 1104ATZG-E
RAV-SP1404AT-E, SP1404ATZ-E, 1404ATZG-E

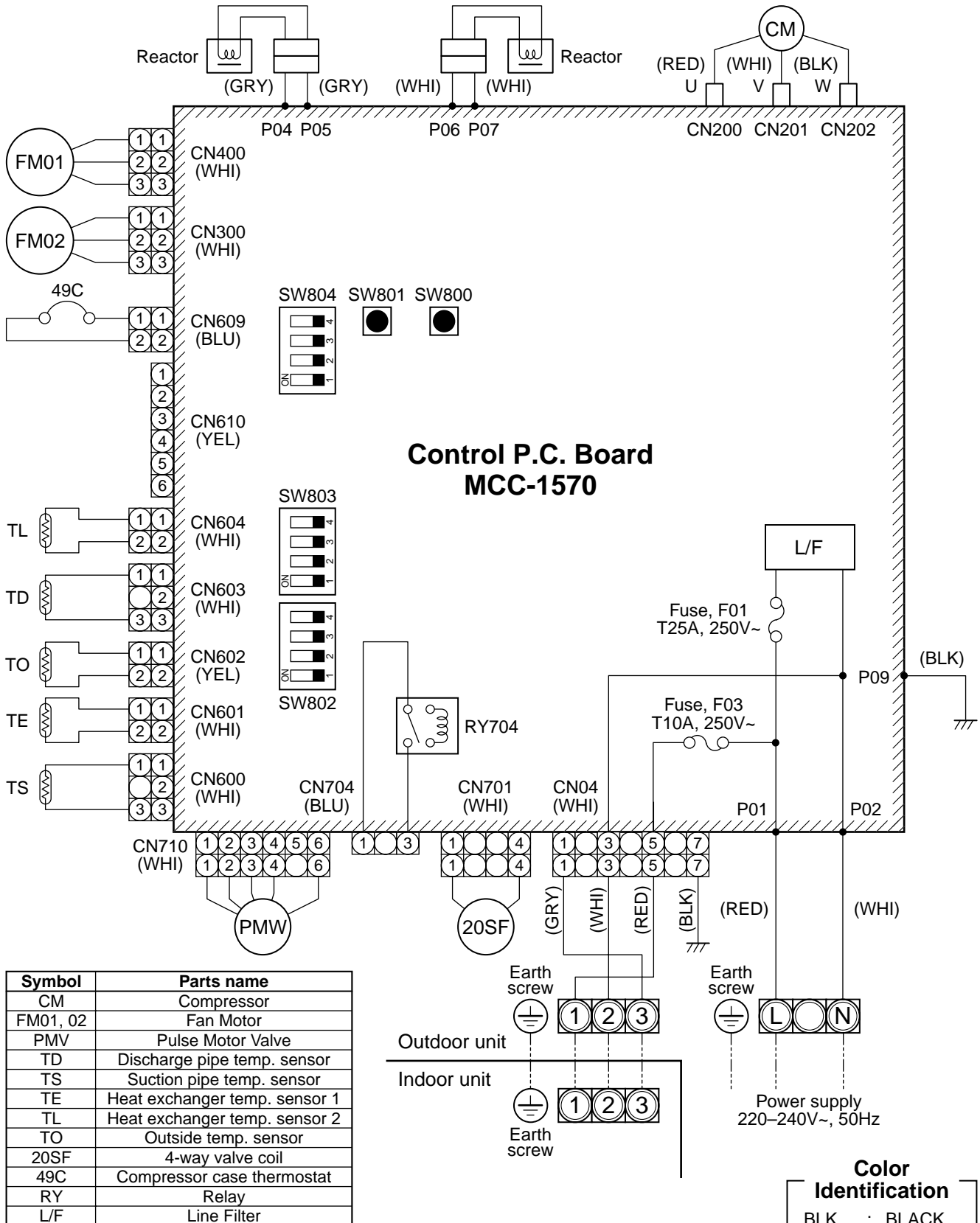

- indicates the terminal block.
Alphanumeric characters in the cycle indicate the terminal No.
- The two-dot chain line indicates the wiring procured locally.
- ▨ indicates the P.C. board.
- For the indoor unit circuit, refer to the wiring diagram of the indoor unit.

Color Identification	
BLK	: BLACK
BLU	: BLUE
RED	: RED
GRY	: GRAY
WHI	: WHITE
YEL	: YELLOW

RAV-SP404AT-E, RAV-SP404ATZ-E, RAV-SP404ATZG-E
 RAV-SP454AT-E, RAV-SP454ATZ-E, RAV-SP454ATZG-E

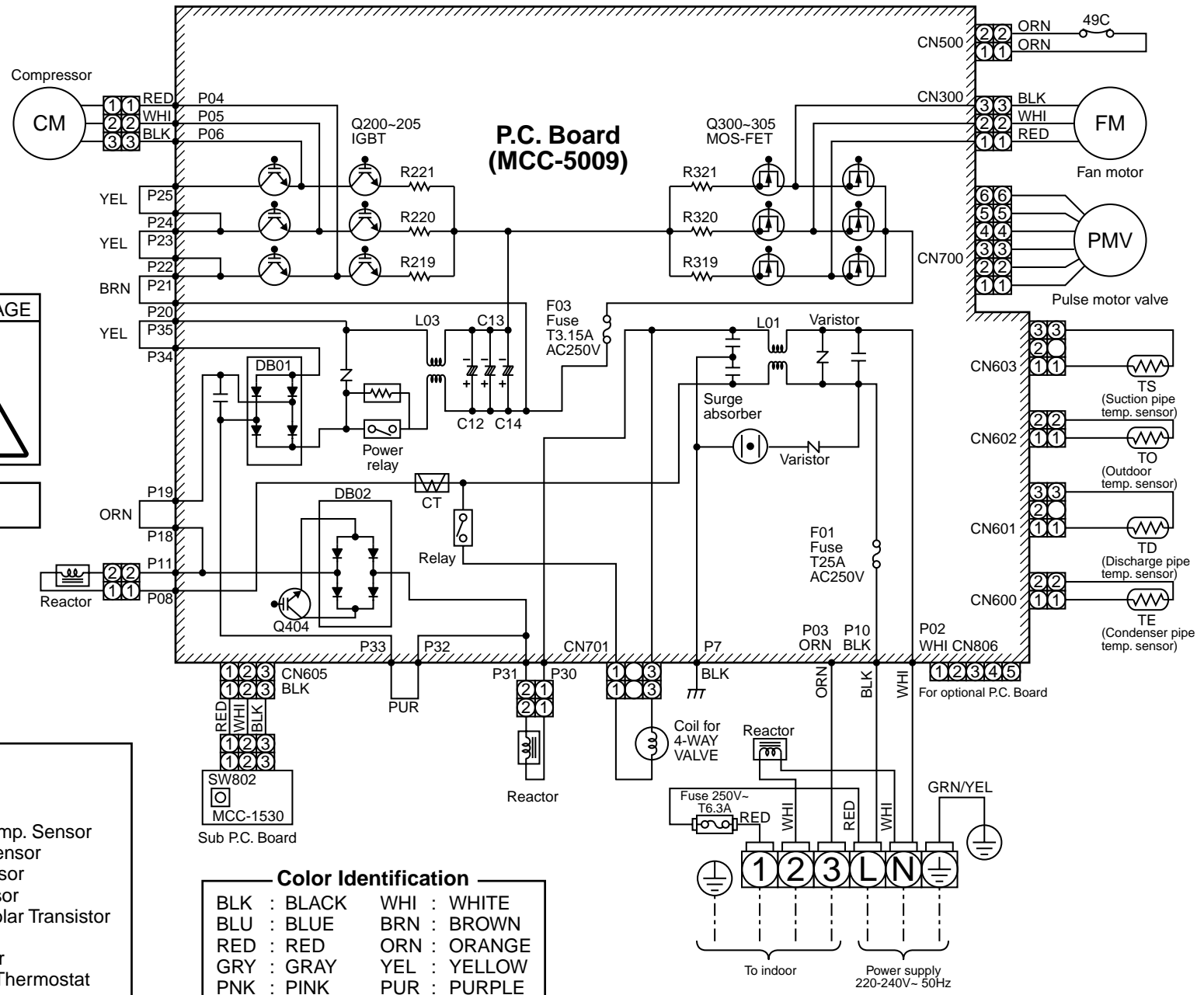

CAUTION : HIGH VOLTAGE

The high voltage circuit is incorporated.
 Be careful to do the check service, as the electric shock may be caused in case of touching parts on the P.C. board by hand

The 4-way valve coil is turned on while the cooling operation

NOTE

CM : Compressor
 PMV : Pulse Motor Valve
 FM : Fan Motor
 TE : Heat Exchanger Temp. Sensor
 TD : Discharge Temp. Sensor
 TO : Outdoor Temp. Sensor
 TS : Suction Temp. Sensor
 IGBT : Insulated Gate Bipolar Transistor
 DB : Rectifier
 CT : Current Transformer
 49C : Compressor Case Thermostat

Color Identification

BLK : BLACK	WHI : WHITE
BLU : BLUE	BRN : BROWN
RED : RED	ORN : ORANGE
GRY : GRAY	YEL : YELLOW
PNK : PINK	PUR : PURPLE

6. SPECIFICATIONS OF ELECTRICAL PARTS

6-1. Indoor Unit

RAV-SM564UT-E, RAV-SM804UT-E

No.	Parts name	Type	Specifications
1	Fan motor (for indoor)	SWF-230-60-2R	Output (Rated) 60 W
2	Thermo. sensor (TA-sensor)	328 mm	10 kΩ at 25°C
3	Heat exchanger sensor (TCJ-sensor)	Ø6 mm, 1000 mm	10 kΩ at 25°C
4	Heat exchanger sensor (TC-sensor)	Ø6 mm, 950 mm	10 kΩ at 25°C
5	Float switch	FS-0218-102	—
6	Drain pump motor	MDP-1401	—

RAV-SM1104UT-E, RAV-SM1404UT-E, RAV-SM1604UT-E

No.	Parts name	Type	Specifications
1	Fan motor	ICF-280-150-1	Output (Rated) 90 W
2	Thermo. sensor (TA-sensor)	328 mm	10 kΩ at 25°C
3	Heat exchanger sensor (TCJ-sensor)	Ø6 mm, 1000 mm	10 kΩ at 25°C
4	Heat exchanger sensor (TC-sensor)	Ø6 mm, 950 mm	10 kΩ at 25°C
5	Float switch	FS-0218-102	—
6	Drain pump motor	MDP-1401	—

RAV-SM404SDT-E, RAV-SM454SDT-E, RAV-SM564SDT-E

No.	Parts name	Type	Specifications
1	Fan motor	SWF-280-60-3	—
2	Drain pump motor	MDP-1401	—
3	Float switch	FS-0218-102	—
4	TA sensor	Lead wire length : 328mm	10 kΩ at 25°C
5	TC sensor	Ø6 size lead wire length : 1200mm Vinyl tube (Black)	10 kΩ at 25°C
6	TCJ sensor	Ø6 size lead wire length : 1200mm Vinyl tube (Red)	10 kΩ at 25°C

6-2. Outdoor Unit (Parts Ratings)

RAV-SP1104AT-E, RAV-SP1104ATZ-E, RAV-SP1104ATZG-E
RAV-SP1404AT-E, RAV-SP1404ATZ-E, RAV-SP1404ATZG-E

No.	Parts name	Type	Specifications
1	Compressor	DA422A3F-25M	—
2	Outdoor fan motor	ICF-280-A100-1	Output 100W
3	Reactor	CH-62	5.7mH, 18.5A
4	4-way valve coil	VHV-01AP552B1	AC240V
5	PMV coil	UKV-A038	DC12V
6	P.C. board	MCC-1571	AC220 – 240V
7	Fuse (Mounted on P.C. board)	—	AC250V, 25A
8	Fuse (Mounted on P.C. board)	—	AC250V, 10A
9	Fuse (Mounted on P.C. board)	—	AC250V, 3.15A
10	Outdoor temp. sensor (TO sensor)	—	10 kΩ at 25°C
11	Heat exchanger sensor (Te sensor)	—	10 kΩ at 25°C
12	Discharge temp. sensor (Td sensor)	—	50 kΩ at 25°C
13	Heat exchanger mid. Temp sensor (TL sensor)	—	10 kΩ at 25°C
14	Compressor thermo. (Protection)	US-622	OFF: 125 ± 4°C, ON: 90 ± 5°C

RAV-SP404AT-E, RAV-SP404ATZ-E, RAV-SP404ATZG-E
RAV-SP454AT-E, RAV-SP454ATZ-E, RAV-SP454ATZG-E

No.	Parts name	Type	Specifications
1	Fan motor	ICF-140-43-4R	Output (Rated) 43W
2	Compressor	DA150A1F-20F	3 phase, 4P, 1100W
3	Reactor	CH-57	10mH, 16A
4	Outdoor temp. sensor (To sensor)	—	10 kΩ at 25°C
5	Heat exchanger sensor (Te sensor)	—	10 kΩ at 25°C
6	Suction temp. sensor (Ts sensor)	—	10 kΩ at 25°C
7	Discharge temp. sensor (Td sensor)	—	50 kΩ at 25°C
8	Fuse (Switching power (Protect))	—	T3.15A, AC 250V
9	Fuse (Inverter, input (Current protect))	—	AC240V
10	4-way valve solenoid coil	STF-01AJ502E1	—
11	Compressor thermo. (Protection)	US-622	OFF: 125 ± 4°C, ON: 90 ± 5°C
12	Coil (Pulse Motor Valve)	CAM-MD12TF-6	—

6-3. Accessory Separate Sold Parts

RBC-U31PG (W, WS)-E (Ceiling panel), RBC-U31PGS (W, WS)-E (Ceiling panel)
RAV-SM564UT-E, RAV-SM804UT-E, RAV-SM1104UT-E, RAV-SM1404UT-E, RAV-SM1604UT-E

No.	Parts name	Type	Specifications
1	Motor-louver	MP24ZN3N	DC 12 V
2			

7. REFRIGERANT R410A

This air conditioner adopts the new refrigerant HFC (R410A) which does not damage the ozone layer.

The working pressure of the new refrigerant R410A is 1.6 times higher than conventional refrigerant (R22). The refrigerating oil is also changed in accordance with change of refrigerant, so be careful that water, dust, and existing refrigerant or refrigerating oil are not entered in the refrigerant cycle of the air conditioner using the new refrigerant during installation work or servicing time.

The next section describes the precautions for air conditioner using the new refrigerant.

Conforming to contents of the next section together with the general cautions included in this manual, perform the correct and safe work.

7-1. Safety During Installation/Serviceing

As R410A's pressure is about 1.6 times higher than that of R22, improper installation/servicing may cause a serious trouble. By using tools and materials exclusive for R410A, it is necessary to carry out installation/servicing safely while taking the following precautions into consideration.

1. Never use refrigerant other than R410A in an air conditioner which is designed to operate with R410A.

If other refrigerant than R410A is mixed, pressure in the refrigeration cycle becomes abnormally high, and it may cause personal injury, etc. by a rupture.

2. Confirm the used refrigerant name, and use tools and materials exclusive for the refrigerant R410A.

The refrigerant name R410A is indicated on the visible place of the outdoor unit of the air conditioner using R410A as refrigerant.

To prevent mischarging, the diameter of the service port differs from that of R22.

3. If a refrigeration gas leakage occurs during installation/servicing, be sure to ventilate fully.
If the refrigerant gas comes into contact with fire, a poisonous gas may occur.
4. When installing or removing an air conditioner, do not allow air or moisture to remain in the refrigeration cycle.
Otherwise, pressure in the refrigeration cycle may become abnormally high so that a rupture or personal injury may be caused.
5. After completion of installation work, check to make sure that there is no refrigeration gas leakage.

If the refrigerant gas leaks into the room, coming into contact with fire in the fan-driven heater, space heater, etc., a poisonous gas may occur.

6. When an air conditioning system charged with a large volume of refrigerant is installed in a small room, it is necessary to exercise care so that, even when refrigerant leaks, its concentration does not exceed the marginal level.

If the refrigerant gas leakage occurs and its concentration exceeds the marginal level, an oxygen starvation accident may result.

7. Be sure to carry out installation or removal according to the installation manual.
Improper installation may cause refrigeration trouble, water leakage, electric shock, fire, etc.
8. Unauthorized modifications to the air conditioner may be dangerous. If a breakdown occurs please call a qualified air conditioner technician or electrician.

Improper repair may result in water leakage, electric shock and fire, etc.

7-2. Refrigerant Piping Installation

7-2-1. Piping Materials and Joints Used

For the refrigerant piping installation, copper pipes and joints are mainly used.

Copper pipes and joints suitable for the refrigerant must be chosen and installed.

Furthermore, it is necessary to use clean copper pipes and joints whose interior surfaces are less affected by contaminants.

1. Copper Pipes

It is necessary to use seamless copper pipes which are made of either copper or copper alloy and it is desirable that the amount of residual oil is less than 40 mg/10 m.

Do not use copper pipes having a collapsed, deformed or discolored portion (especially on the interior surface).

Otherwise, the expansion valve or capillary tube may become blocked with contaminants.

As an air conditioner using R410A incurs pressure higher than when using R22, it is necessary to choose adequate materials.

Thicknesses of copper pipes used with R410A are as shown in Table 7-2-1. Never use copper pipes thinner than 0.8mm even when it is available on the market.

NOTE:

Refer to the "7-6. Instructions for Re-use Piping of R22 or R407C".

Table 7-2-1 Thicknesses of annealed copper pipes

		Thickness (mm)	
Nominal diameter	Outer diameter (mm)	R410A	R22
1/4	6.4	0.80	0.80
3/8	9.5	0.80	0.80
1/2	12.7	0.80	0.80
5/8	15.9	1.00	1.00

1. Joints

For copper pipes, flare joints or socket joints are used. Prior to use, be sure to remove all contaminants.

a) Flare Joints

Flare joints used to connect the copper pipes cannot be used for pipings whose outer diameter exceeds 20 mm. In such a case, socket joints can be used.

Sizes of flare pipe ends, flare joint ends and flare nuts are as shown in Tables 7-2-3 to 7-2-5 below.

b) Socket Joints

Socket joints are such that they are brazed for connections, and used mainly for thick pipings whose diameter is larger than 20 mm. Thicknesses of socket joints are as shown in Table 7-2-2.

Table 7-2-2 Minimum thicknesses of socket joints

Nominal diameter	Reference outer diameter of copper pipe jointed (mm)	Minimum joint thickness (mm)
1/4	6.4	0.50
3/8	9.5	0.60
1/2	12.7	0.70
5/8	15.9	0.80

7-2-2. Processing of Piping Materials

When performing the refrigerant piping installation, care should be taken to ensure that water or dust does not enter the pipe interior, that no other oil other than lubricating oils used in the installed air conditioner is used, and that refrigerant does not leak. When using lubricating oils in the piping processing, use such lubricating oils whose water content has been removed. When stored, be sure to seal the container with an airtight cap or any other cover.

1. Flare Processing Procedures and Precautions

a) Cutting the Pipe

By means of a pipe cutter, slowly cut the pipe so that it is not deformed.

b) Removing Burrs and Chips

If the flared section has chips or burrs, refrigerant leakage may occur.

Carefully remove all burrs and clean the cut surface before installation.

c) Insertion of Flare Nut

d) Flare Processing

Make certain that a clamp bar and copper pipe have been cleaned.

By means of the clamp bar, perform the flare processing correctly.

Use either a flare tool for R410A or conventional flare tool.

Flare processing dimensions differ according to the type of flare tool.

When using a conventional flare tool, be sure to secure "dimension A" by using a gauge for size adjustment.

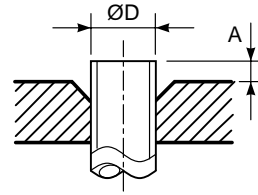

Fig. 7-2-1 Flare processing dimensions

Table 7-2-3 Dimensions related to flare processing for R410A / R22

Nominal diameter	Outer diameter (mm)	Thickness (mm)	A (mm)				
			Flare tool for R410A, R22 clutch type	Conventional flare tool (R410A)		Conventional flare tool (R22)	
				Clutch type	Wing nut type	Clutch type	Wing nut type
1/4	6.4	0.8	0 to 0.5	1.0 to 1.5	1.5 to 2.0	0.5 to 1.0	1.0 to 1.5
3/8	9.5	0.8	0 to 0.5	1.0 to 1.5	1.5 to 2.0	0.5 to 1.0	1.0 to 1.5
1/2	12.7	0.8	0 to 0.5	1.0 to 1.5	2.0 to 2.5	0.5 to 1.0	1.5 to 2.0
5/8	15.9	1.0	0 to 0.5	1.0 to 1.5	2.0 to 2.5	0.5 to 1.0	1.5 to 2.0

Table 7-2-4 Flare and flare nut dimensions for R410A

Nominal diameter	Outer diameter (mm)	Thickness (mm)	Dimension (mm)				Flare nut width (mm)
			A	B	C	D	
1/4	6.4	0.8	9.1	9.2	6.5	13	17
3/8	9.5	0.8	13.2	13.5	9.7	20	22
1/2	12.7	0.8	16.6	16.0	12.9	23	26
5/8	15.9	1.0	19.7	19.0	16.0	25	29

Table 7-2-5 Flare and flare nut dimensions for R22

Nominal diameter	Outer diameter (mm)	Thickness (mm)	Dimension (mm)				Flare nut width (mm)
			A	B	C	D	
1/4	6.4	0.8	9.1	9.2	6.5	13	17
3/8	9.5	0.8	13.0	13.5	9.7	20	22
1/2	12.7	0.8	16.2	16.0	12.9	20	24
5/8	15.9	1.0	19.4	19.0	16.0	23	27
3/4	19.0	1.0	23.3	24.0	19.2	34	36

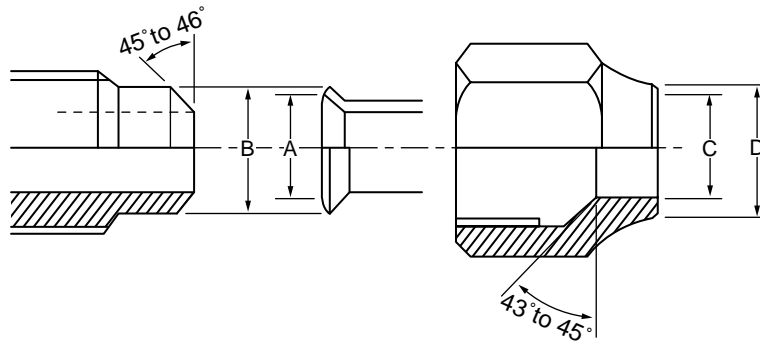

Fig. 7-2-2 Relations between flare nut and flare seal surface

2. Flare Connecting Procedures and Precautions

- a) Make sure that the flare and union portions do not have any scar or dust, etc.
- b) Correctly align the processed flare surface with the union axis.
- c) Tighten the flare with designated torque by means of a torque wrench.

The tightening torque for R410A is the same as that for conventional R22.

Incidentally, when the torque is weak, the gas leakage may occur.

When it is strong, the flare nut may crack and may be made non-removable.

When choosing the tightening torque, comply with values designated by manufacturers.

Table 7-2-6 shows reference values.

NOTE:

When applying oil to the flare surface, be sure to use oil designated by the manufacturer.

If any other oil is used, the lubricating oils may deteriorate and cause the compressor to burn out.

Table 7-2-6 Tightening torque of flare for R410A [Reference values]

Nominal diameter	Outer diameter (mm)	Tightening torque N•m (kgf•m)	Tightening torque of torque wrenches available on the market N•m (kgf•m)
1/4	6.4	14 to 18 (1.4 to 1.8)	16 (1.6), 18 (1.8)
3/8	9.5	33 to 42 (3.3 to 4.2)	42 (4.2)
1/2	12.7	50 to 62 (5.0 to 6.2)	55 (5.5)
5/8	15.9	63 to 77 (6.3 to 7.7)	65 (6.5)

7-3. Tools

7-3-1. Required Tools

Refer to the “4. Tools” (Page 8)

7-4. Recharging of Refrigerant

When it is necessary to recharge refrigerant, charge the specified amount of new refrigerant according to the following steps.

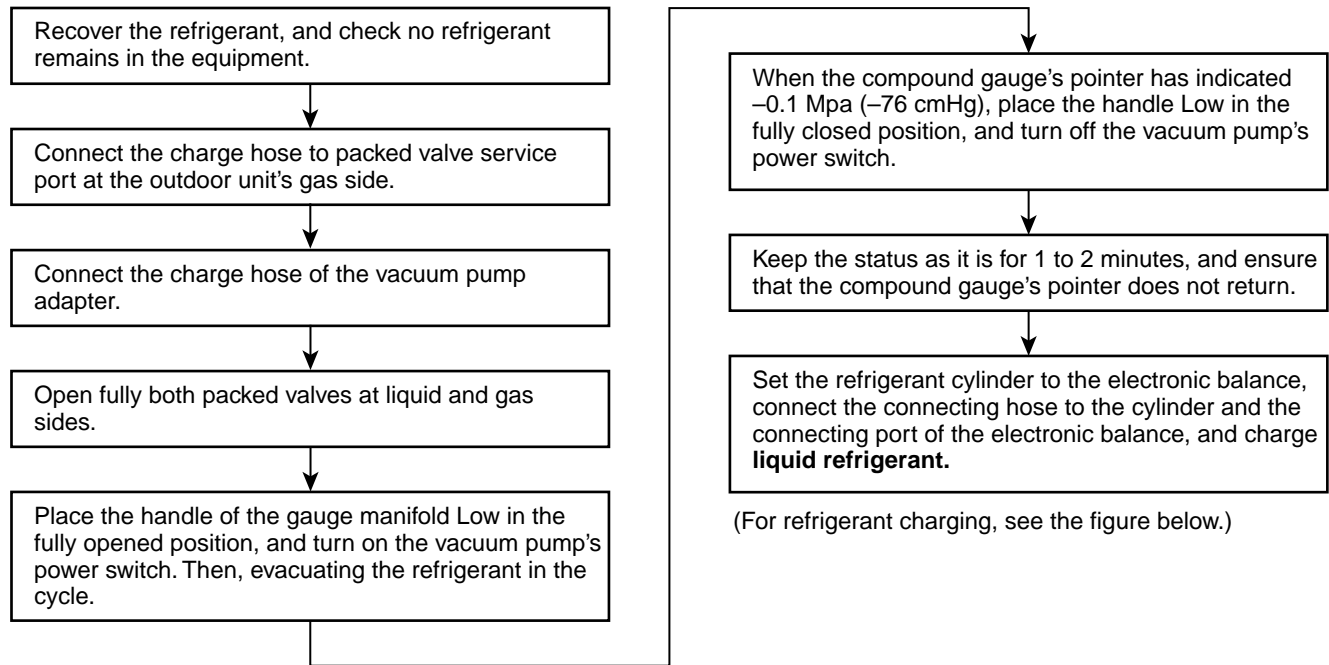

- 1) Never charge refrigerant exceeding the specified amount.
- 2) If the specified amount of refrigerant cannot be charged, charge refrigerant **bit by bit** in COOL mode.
- 3) Do not carry out additional charging.
When additional charging is carried out if refrigerant leaks, the refrigerant composition changes in the refrigeration cycle, that is characteristics of the air conditioner changes, refrigerant exceeding the specified amount is charged, and working pressure in the refrigeration cycle becomes abnormally high pressure, and may cause a rupture or personal injury.

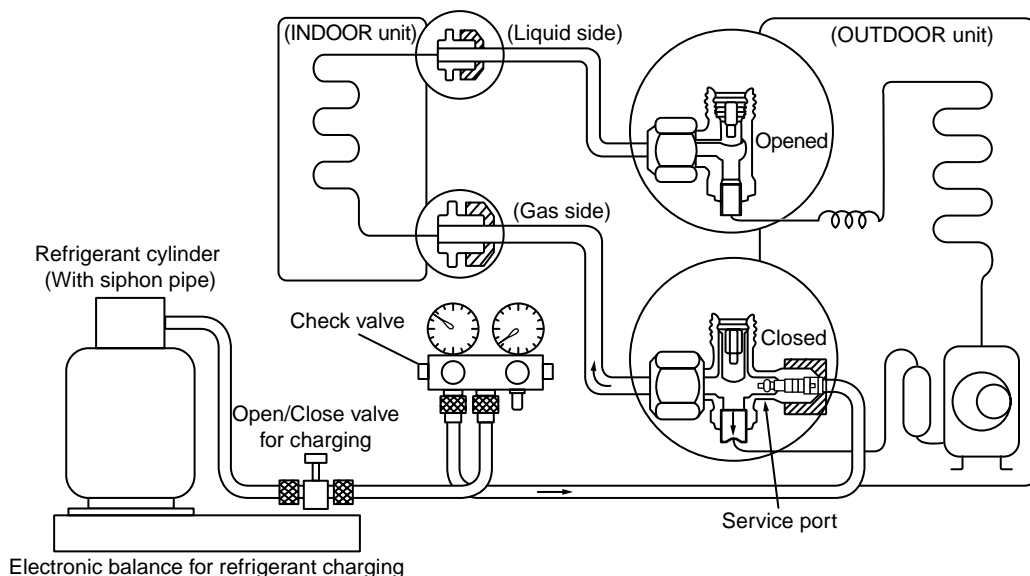
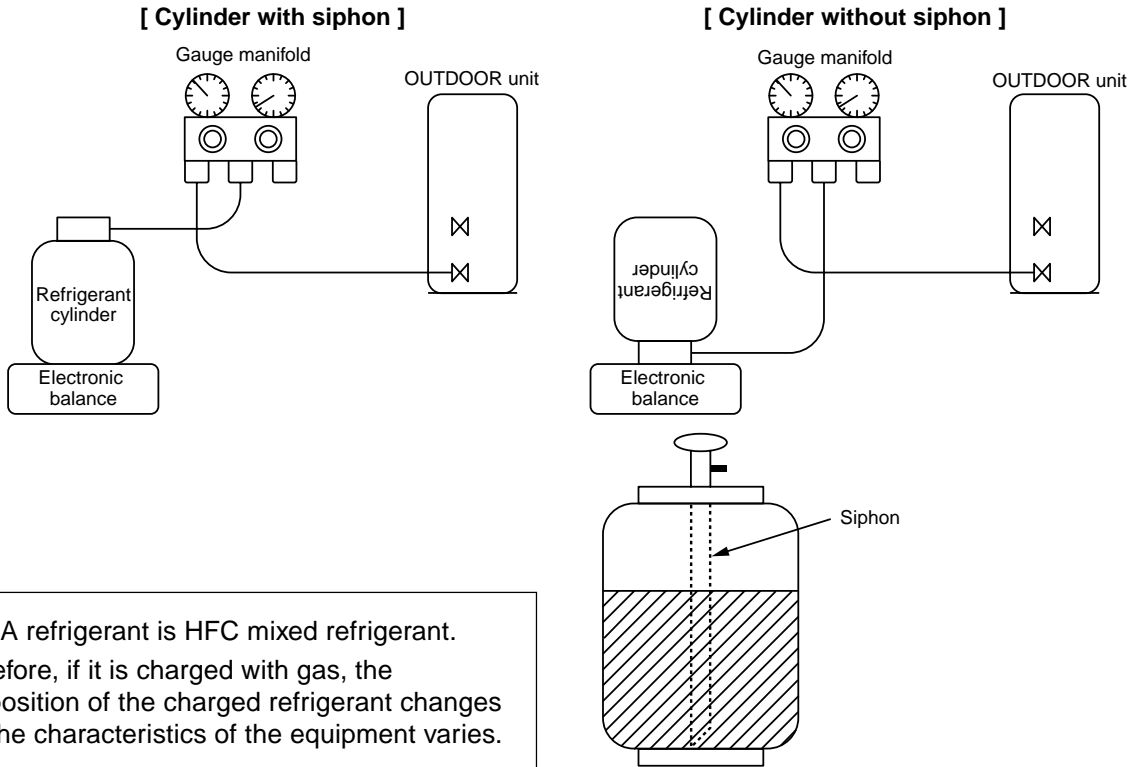

Fig. 7-4-1 Configuration of refrigerant charging

- 1) Be sure to make setting so that **liquid** can be charged.
- 2) When using a cylinder equipped with a siphon, liquid can be charged without turning it upside down.

It is necessary for charging refrigerant under condition of liquid because R410A is mixed type of refrigerant. Accordingly, when charging refrigerant from the refrigerant cylinder to the equipment, charge it turning the cylinder upside down if cylinder is not equipped with siphon.



R410A refrigerant is HFC mixed refrigerant. Therefore, if it is charged with gas, the composition of the charged refrigerant changes and the characteristics of the equipment varies.

Fig. 7-4-2

7-5. Brazing of Pipes

7-5-1. Materials for Brazing

1. Silver brazing filler

Silver brazing filler is an alloy mainly composed of silver and copper.

It is used to join iron, copper or copper alloy, and is relatively expensive though it excels in solderability.

2. Phosphor bronze brazing filler

Phosphor bronze brazing filler is generally used to join copper or copper alloy.

3. Low temperature brazing filler

Low temperature brazing filler is generally called solder, and is an alloy of tin and lead.

Since it is weak in adhesive strength, do not use it for refrigerant pipes.

- 1) Phosphor bronze brazing filler tends to react with sulfur and produce a fragile compound water solution, which may cause a gas leakage. Therefore, use any other type of brazing filler at a hot spring resort, etc., and coat the surface with a paint.
- 2) When performing brazing again at time of servicing, use the same type of brazing filler.

7-5-2. Flux

1. Reason why flux is necessary

- By removing the oxide film and any foreign matter on the metal surface, it assists the flow of brazing filler.
- In the brazing process, it prevents the metal surface from being oxidized.
- By reducing the brazing filler's surface tension, the brazing filler adheres better to the treated metal.

2. Characteristics required for flux

- Activated temperature of flux coincides with the brazing temperature.
- Due to a wide effective temperature range, flux is hard to carbonize.
- It is easy to remove slag after brazing.
- The corrosive action to the treated metal and brazing filler is minimum.
- It excels in coating performance and is harmless to the human body.

As the flux works in a complicated manner as described above, it is necessary to select an adequate type of flux according to the type and shape of treated metal, type of brazing filler and brazing method, etc.

3. Types of flux

• Noncorrosive flux

Generally, it is a compound of borax and boric acid.

It is effective in case where the brazing temperature is higher than 800°C.

• Activated flux

Most of fluxes generally used for silver brazing are this type.

It features an increased oxide film removing capability due to the addition of compounds such as potassium fluoride, potassium chloride and sodium fluoride to the borax-boric acid compound.

4. Piping materials for brazing and used brazing filler/flux

Piping material	Used brazing filler	Used flux
Copper - Copper	Phosphor copper	Do not use
Copper - Iron	Silver	Paste flux
Iron - Iron	Silver	Vapor flux

- 1) Do not enter flux into the refrigeration cycle.
- 2) When chlorine contained in the flux remains within the pipe, the lubricating oil deteriorates. Therefore, use a flux which does not contain chlorine.
- 3) When adding water to the flux, use water which does not contain chlorine (e.g. distilled water or ion-exchange water).
- 4) Remove the flux after brazing.

7-5-3. Brazing

As brazing work requires sophisticated techniques, experiences based upon a theoretical knowledge, it must be performed by a person qualified.

In order to prevent the oxide film from occurring in the pipe interior during brazing, it is effective to proceed with brazing while letting dry Nitrogen gas flow.

Never use gas other than Nitrogen gas.

1. Brazing method to prevent oxidation

- 1) Attach a reducing valve and a flow-meter to the Nitrogen gas cylinder.
- 2) Use a copper pipe to direct the piping material, and attach a flow-meter to the cylinder.
- 3) Apply a seal onto the clearance between the piping material and inserted copper pipe for Nitrogen in order to prevent backflow of the Nitrogen gas.
- 4) When the Nitrogen gas is flowing, be sure to keep the piping end open.
- 5) Adjust the flow rate of Nitrogen gas so that it is lower than 0.05 m³/Hr or 0.02 MPa (0.2kgf/cm²) by means of the reducing valve.
- 6) After performing the steps above, keep the Nitrogen gas flowing until the pipe cools down to a certain extent (temperature at which pipes are touchable with hands).
- 7) Remove the flux completely after brazing.

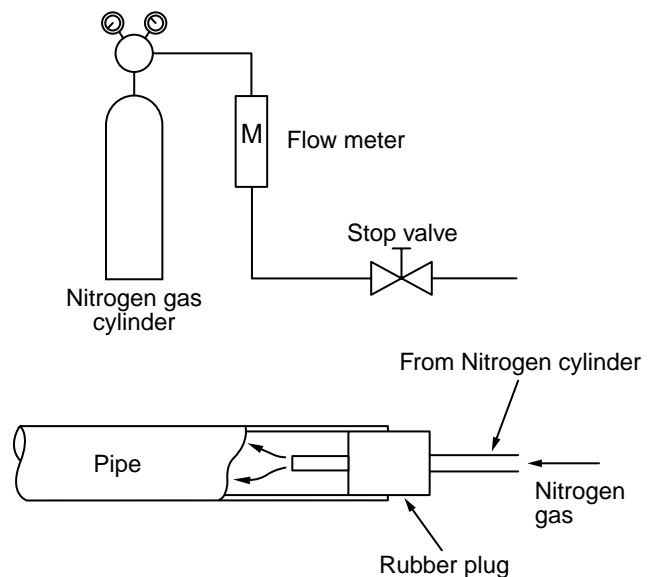

Fig. 7-5-1 Prevention of oxidation during brazing

7-6. Instructions for Re-use Piping of R22 or R407C

Instruction of Works:

The existing R22 and R407C piping can be reused for our digital inverter R410A products installations.

NOTE)

Confirmation of existence of scratch or dent of the former pipes to be applied and also confirmation of reliability of the pipe strength are conventionally referred to the local site.

If the definite conditions can be cleared, it is possible to update the existing R22 and R407C pipes to those for R410A models.

7-6-1. Basic Conditions Needed to Reuse the Existing Pipe

Check and observe three conditions of the refrigerant piping works.

1. Dry (There is no moisture inside of the pipes.)
2. Clean (There is no dust inside of the pipes.)
3. Tight (There is no refrigerant leak.)

7-6-2. Restricted Items to Use the Existing Pipes

In the following cases, the existing pipes cannot be reused as they are. Clean the existing pipes or exchange them with new pipes.

1. When a scratch or dent is heavy, be sure to use the new pipes for the works.
2. When the thickness of the existing pipe is thinner than the specified "Pipe diameter and thickness" be sure to use the new pipes for the works.
 - The operating pressure of R410A is high (1.6 times of R22 and R407C). If there is a scratch or dent on the pipe or thinner pipe is used, the pressure strength is poor and may cause break-age of the pipe at the worst.

* Pipe diameter and thickness (mm)

Pipe outer diameter		Ø6.4	Ø9.5	Ø12.7	Ø15.9	Ø19.0
Thickness	R410A	0.8	0.8	0.8	1.0	1.0
	R22 (R407C)					

- In case that the pipe diameter is Ø12.7 mm or less and the thickness is less than 0.7 mm, be sure to use the new pipes for works.
3. The pipes are left as coming out or gas leaks. (Poor refrigerant)
 - There is possibility that rain water or air including moisture enters in the pipe.
 4. Refrigerant recovery is impossible. (Refrigerant recovery by the pump-down operation on the existing air conditioner)
 - There is possibility that a large quantity of poor oil or moisture remains inside of the pipe.
 5. A dryer on the market is attached to the existing pipes.
 - There is possibility that copper green rust generated.

6. Check the oil when the existing air conditioner was removed after refrigerant had been recovered. In this case, if the oil is judged as clearly different compared with normal oil
 - The refrigerator oil is copper rust green : There is possibility that moisture is mixed with the oil and rust generates inside of the pipe.
 - There is discolored oil, a large quantity of the remains, or bad smell.
 - A large quantity of sparkle remained wear-out powder is observed in the refrigerator oil.
7. The air conditioner which compressor was exchanged due to a faulty compressor. When the discolored oil, a large quantity of the remains, mixture of foreign matter, or a large quantity of sparkle remained wear-out powder is observed, the cause of trouble will occur.
8. Installation and removal of the air conditioner are repeated with temporary installation by lease and etc.
9. In case that type of the refrigerator oil of the existing air conditioner is other than the following oil (Mineral oil), Suniso, Freol-S, MS (Synthetic oil), alkyl benzene (HAB, Barrel-freeze), ester series, PVE only of ether series.
 - Winding-insulation of the compressor may become inferior.

NOTE)

The above descriptions are results of confirmation by our company and they are views on our air conditioners, but they do not guarantee the use of the existing pipes of the air conditioner that adopted R410A in other companies.

7-6-3. Branching Pipe for Simultaneous Operation System

- In the concurrent twin system, when TOSHIBA-specified branching pipe is used, it can be reused. Branching pipe model name: RBC-TWP30E-2, RBC-TWP50E-2
On the existing air conditioner for simultaneous operation system (twin system), there is a case of using branch pipe that has insufficient compressive strength. In this case please change it to the branch pipe for R410A.

7-6-4. Curing of Pipes

When removing and opening the indoor unit or outdoor unit for a long time, cure the pipes as follows:

- Otherwise rust may generate when moisture or foreign matter due to dewing enters in the pipes.
- The rust cannot be removed by cleaning, and a new piping work is necessary.

Place position	Term	Curing manner
Outdoors	1 month or more	Pinching
	Less than 1 month	Pinching or taping
Indoors	Every time	

7-6-5. Final Installation Checks

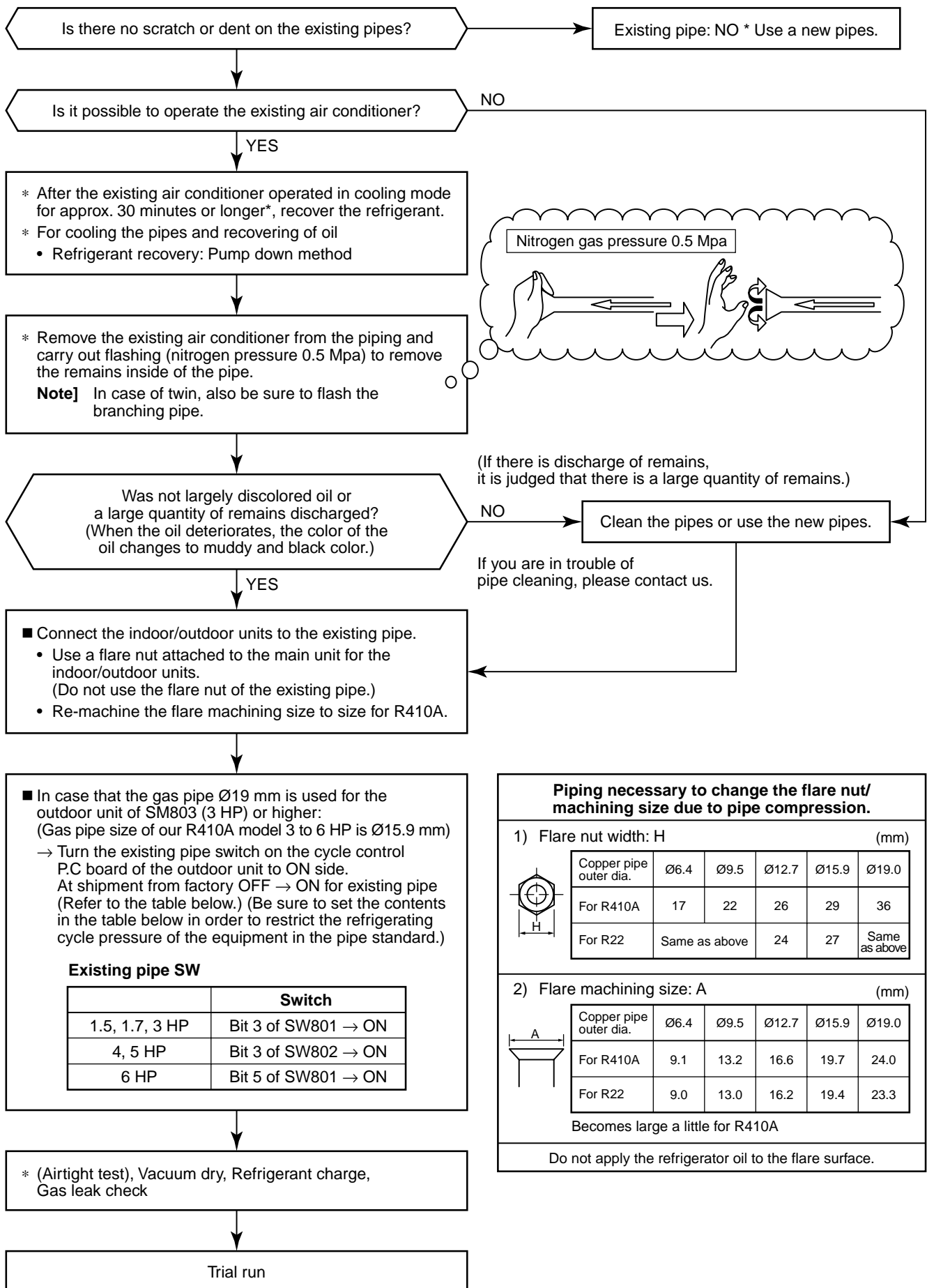

7-6-6. Handling of Existing Pipe

When using the existing pipe, carefully check it for the following:

- Wall thickness (within the specified range)
- Scratches and dents
- Water, oil, dirt, or dust in the pipe
- Flare looseness and leakage from welds
- Deterioration of copper pipe and heat insulator

Cautions for using existing pipe

- Do not reuse the flare to prevent gas leak.
Replace it with the supplied flare nut and then process it to a flare.
- Blow nitrogen gas or use an appropriate means to keep the inside of the pipe clean.

If discolored oil or much residue is discharged, wash the pipe.

- Check welds, if any, on the pipe for gas leak.

When the pipe corresponds to any of the following, do not use it. Install a new pipe instead.

- The pipe has been open (disconnected from indoor unit or outdoor unit) for a long period.
- The pipe has been connected to an outdoor unit that does not use refrigerant R22, R410A or R407C.
- The existing pipe must have a wall thickness equal to or larger than the following thickness.

Reference outside diameter (mm)	Wall thickness (mm)
Ø9.5	0.8
Ø15.9	1.0
Ø19.1	1.0

- Never use any pipe with a wall thickness less than these thicknesses due to insufficient pressure capacity.

RAV-SP1104AT-E, RAV-SP1404AT-E

- To use an existing Ø19.1 mm pipe, set bit 3 of SW802 (switch for existing pipe) on the P.C. board of the outdoor unit to ON.

In this case, the heating performance may be reduced depending on the outside air temperature and room temperature.

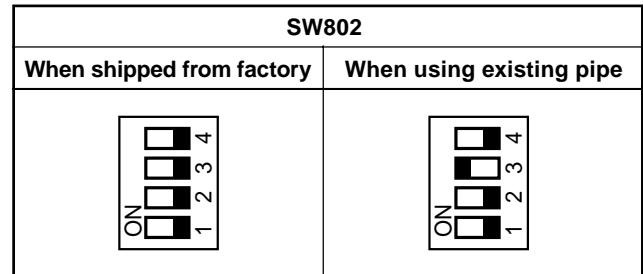

RAV-SM1603AT-E

- To use an existing Ø19.1 mm pipe, set bit 5 of SW801 (switch for existing pipe) on the P.C. board of the outdoor unit to ON.

In this case, the heating performance may be reduced depending on the outside air temperature and room temperature.

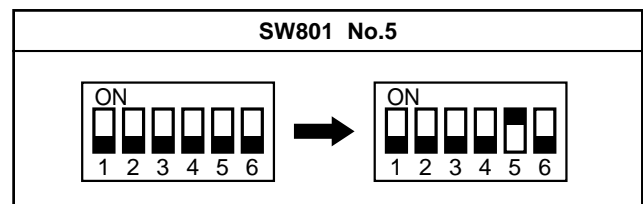

7-6-7. Recovery Method of Refrigerant

RAV-SP1104AT-E, RAV-SP1404AT-E

- Use the refrigerant recovery switch SW801 on the P.C. board of the outdoor unit to recover refrigerant when the indoor unit or outdoor unit is moved.

Procedure

1. Turn on the power of the air conditioner.
2. Select the FAN mode for indoor unit operation with the remote controller.
3. Set SW804 on the P.C. board of the outdoor unit to all OFF, and then push SW801 for one second or more.

The air conditioner enters the forced cooling mode for up to 10 minutes.

Operation or handling the valve to recover refrigerant during this time period.

4. Upon completion of refrigerant recovery, close the valve and push SW801 for at least one second to stop operation.
5. Turn off the power.

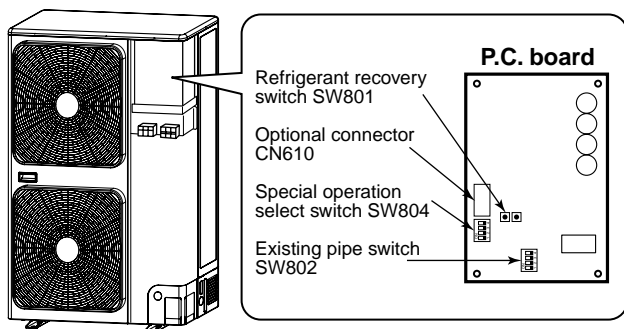

RAV-SM1603AT-E

- Use the refrigerant recovery switch SW802 on the P.C. board of the outdoor unit to recover refrigerant when the indoor unit or outdoor unit is moved.

Procedure

1. Turn on the power of the air conditioner.
2. Select the FAN mode for indoor unit operation with the remote controller.
3. Push the refrigerant recovery switch SW802 on the P.C. board of the outdoor unit to drive the air conditioner into the forced cooling mode for up to 10 minutes.

Open the valve to start refrigerant recovery.

4. Upon completion of refrigerant recovery, close the valve and push SW802 for at least one second to stop operation.
5. Turn off the power.

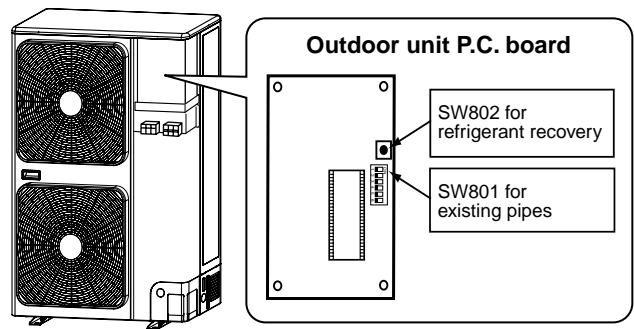

DANGER

Take care for an electric shock because the P.C. board is electrified.

**7-6-8. Recovery method of refrigerant for
RAV-SP404AT-E, RAV-SP404ATZ-E, RAV-SP404ATZG-E
RAV-SP454AT-E, RAV-SP454ATZ-E, RAV-SP454ATZG-E**

- When recovering refrigerant in case of reinstallation of the indoor or outdoor unit, etc., use the refrigerant recovery switch on the terminal block of the outdoor unit.

Procedure

1. Set FAN operation to the indoor unit.
2. Push the refrigerant recovery switch (SW802) of the outdoor unit
(Keep pushing it for approx. 2 seconds.)
The cooling operation starts.
(This operation continues for 10 minutes.)
3. After operation for 3 minutes or more, close the valve at liquid side.
4. After finish of the refrigerant recovery, close the valve at gas side.
5. When keeping pushed the refrigerant recovery SW again for approx. 2 seconds, the outdoor unit stops.
6. Stop the indoor unit and then turn off the power supply.

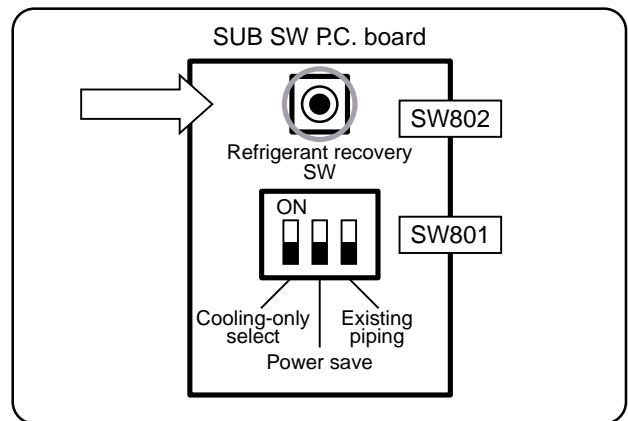
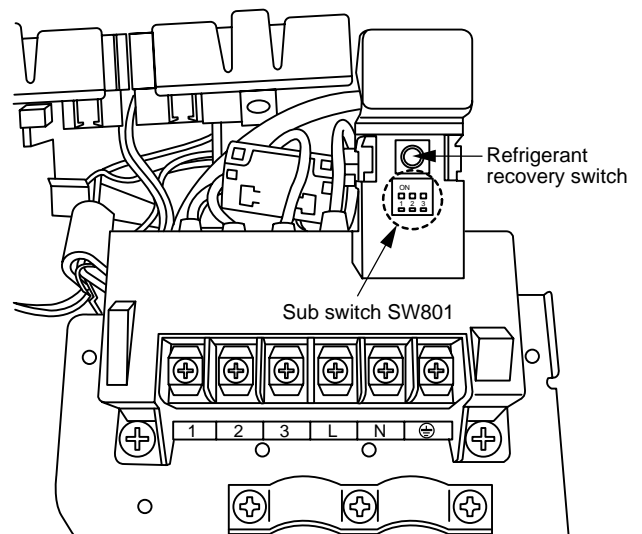

DANGER

Take care for an electric shock because the control P.C. board is electrified.

8. INDOOR CONTROL CIRCUIT

8-1. Indoor Controller Block Diagram

8-1-1. Connection of Main (Sub) Remote Controller

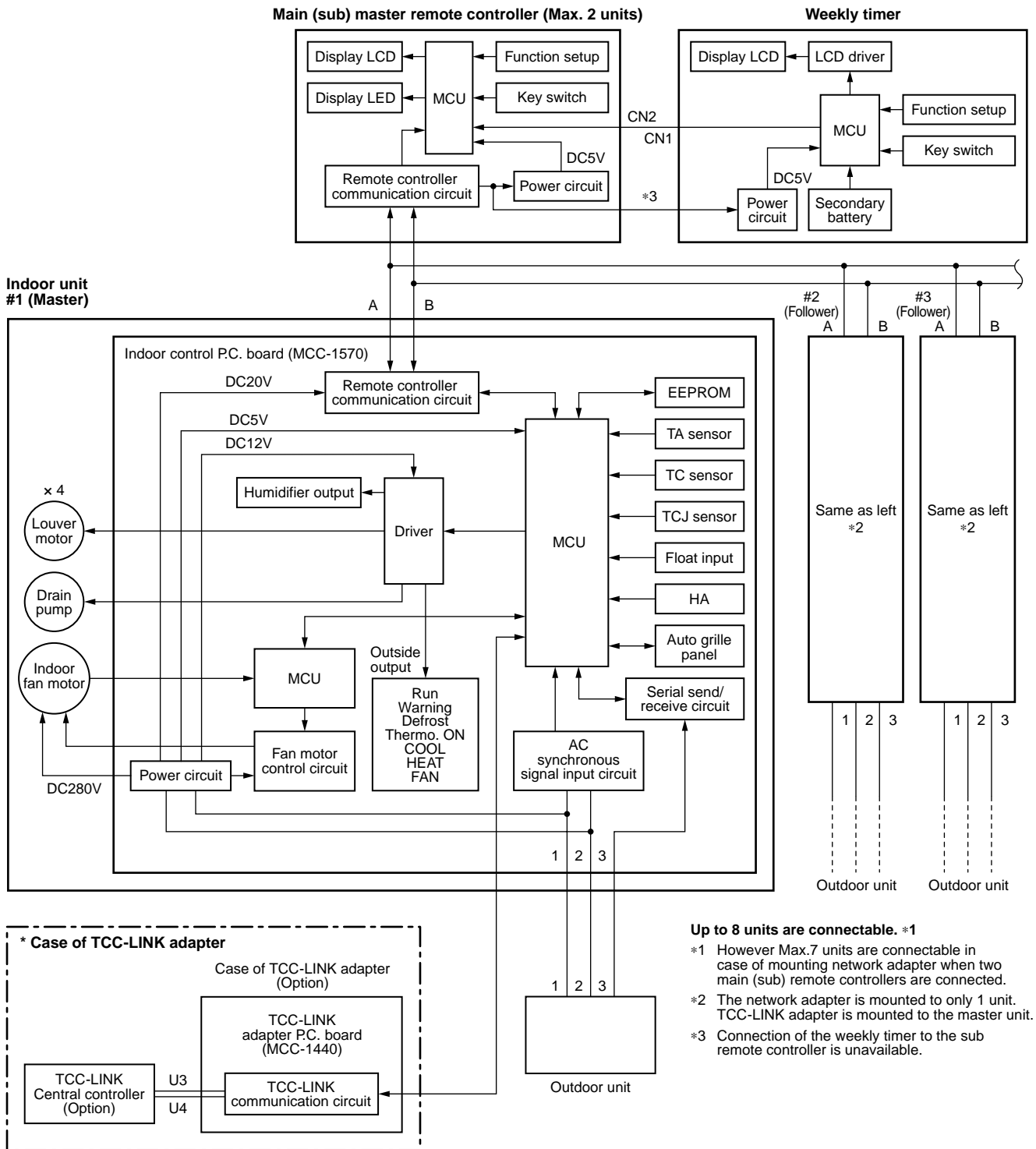

8-1-2. Connection of Wireless Remote Controller Kit

Indoor unit
#1 (Master)

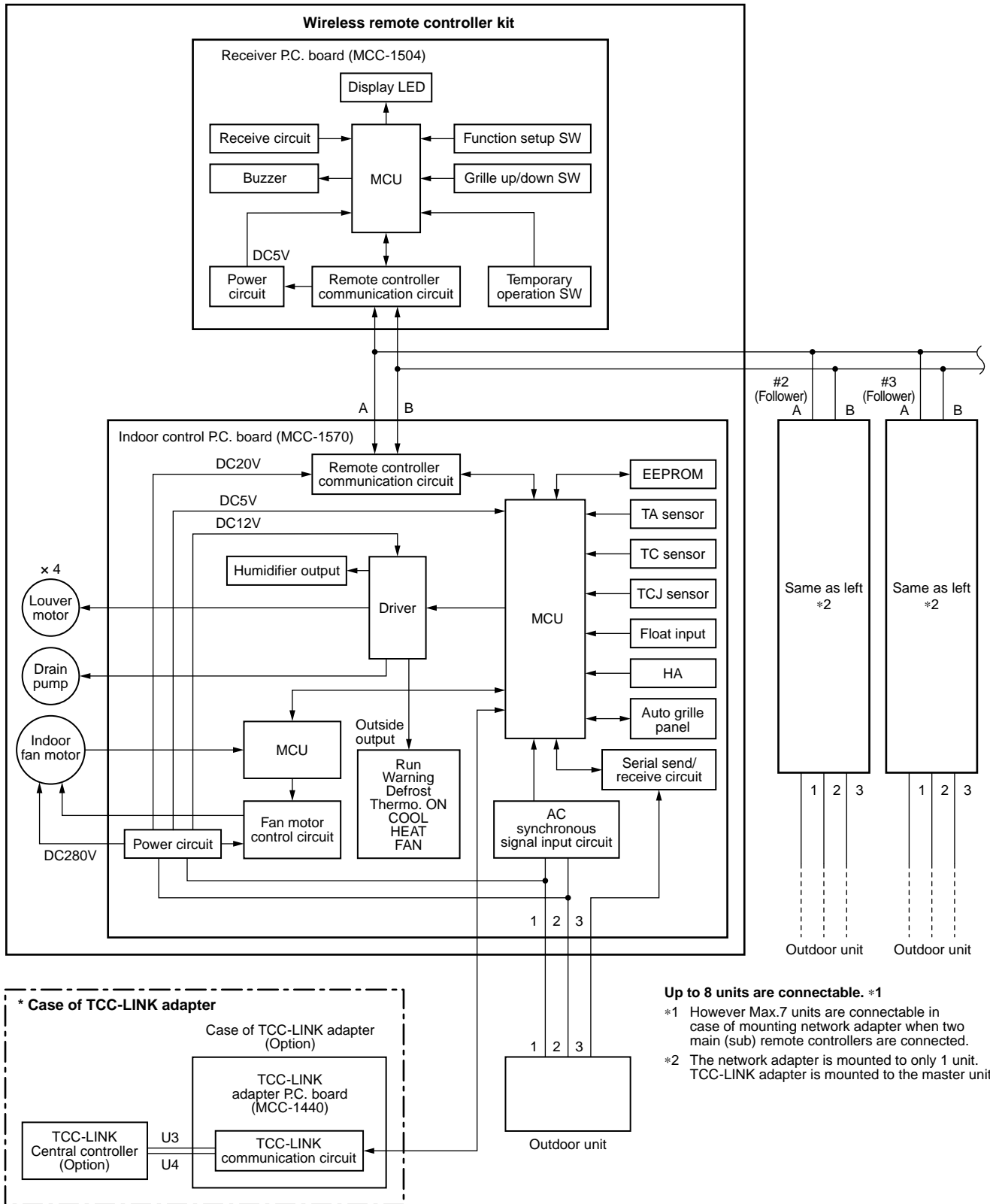

8-1-3. Connection of Both Main (Sub) Remote Controller and Wireless Remote Controller Kit

Indoor unit
#1 (Master)

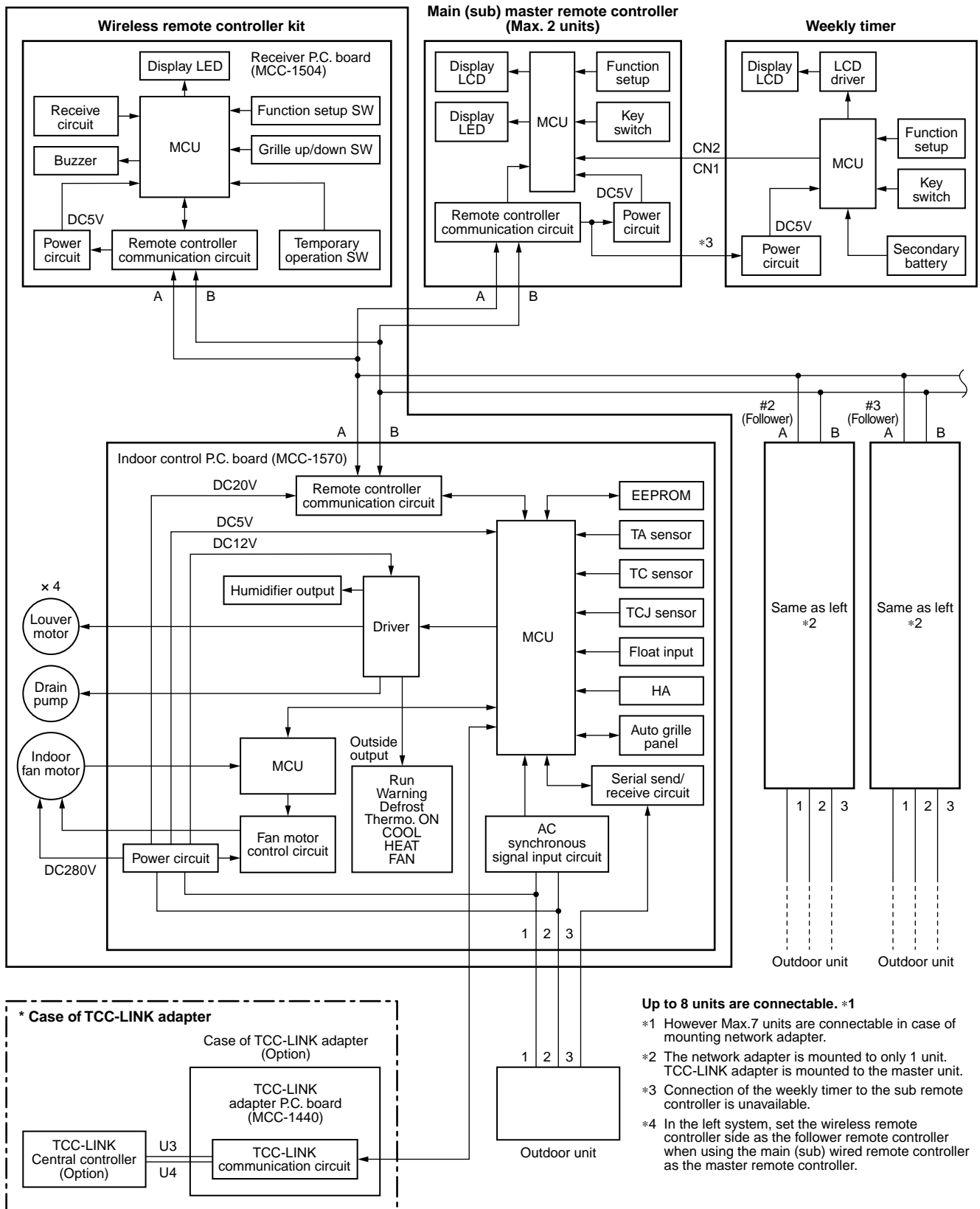



8-2. Control Specifications

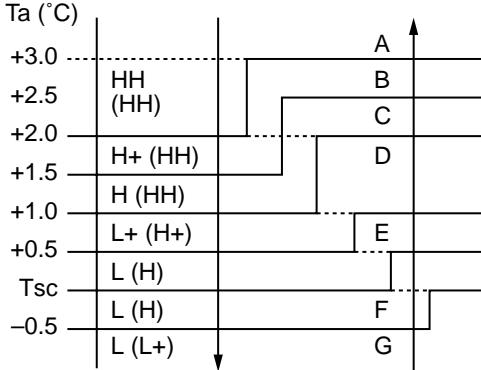
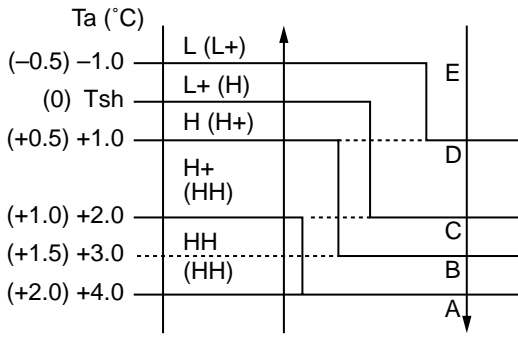

No.	Item	Outline of specifications	Remarks																										
1	When power supply is reset	<p>1) Distinction of outdoor unit When the power supply is reset, the outdoors are distinguished and the control is selected according to the distinguished result.</p> <p>2) Setting of indoor fan speed and existence of air direction adjustment Based on EEPROM data, select setting of the indoor fan speed and the existence of air direction adjustment.</p>	Air speed (rpm)/ Air direction adjustment																										
2	Operation mode selection	<p>1) Based on the operation mode selecting command from the remote controller, the operation mode is selected.</p> <table border="1" style="width: 100%; border-collapse: collapse;"> <thead> <tr> <th style="text-align: center;">Remote controller command</th> <th style="text-align: center;">Control outline</th> </tr> </thead> <tbody> <tr> <td style="text-align: center;">STOP</td> <td>Air conditioner stops.</td> </tr> <tr> <td style="text-align: center;">FAN</td> <td>Fan operation</td> </tr> <tr> <td style="text-align: center;">COOL</td> <td>Cooling operation</td> </tr> <tr> <td style="text-align: center;">DRY</td> <td>Dry operation</td> </tr> <tr> <td style="text-align: center;">HEAT</td> <td>Heating operation</td> </tr> <tr> <td style="text-align: center;">AUTO</td> <td> <ul style="list-style-type: none"> • COOL/HEAT operation mode is automatically selected by Ta, Ts and To for operation. • The operation is performed as shown in the following figure according to Ta value at the first time only. (In the range of $T_s + \alpha - 1 < T_a < T_s + \alpha + 1$, Cooling thermo. OFF (Fan)/Setup air volume operation continues.) <div style="text-align: center;"> </div> <ul style="list-style-type: none"> • α is corrected according to the outside temperature. <table border="1" style="width: 100%; border-collapse: collapse; margin-top: 10px;"> <thead> <tr> <th style="text-align: center;">Outside temp.</th> <th style="text-align: center;">Correction value (α)</th> </tr> </thead> <tbody> <tr> <td style="text-align: center;">No To</td> <td style="text-align: center;">0K</td> </tr> <tr> <td style="text-align: center;">$T_o \geq 24^\circ\text{C}$</td> <td style="text-align: center;">-1K</td> </tr> <tr> <td style="text-align: center;">$24 > T_o \geq 18^\circ\text{C}$</td> <td style="text-align: center;">0K</td> </tr> <tr> <td style="text-align: center;">$T_o < 18^\circ\text{C}$</td> <td style="text-align: center;">+1K</td> </tr> <tr> <td style="text-align: center;">To error</td> <td style="text-align: center;">0K</td> </tr> </tbody> </table> </td> </tr> </tbody> </table>	Remote controller command	Control outline	STOP	Air conditioner stops.	FAN	Fan operation	COOL	Cooling operation	DRY	Dry operation	HEAT	Heating operation	AUTO	<ul style="list-style-type: none"> • COOL/HEAT operation mode is automatically selected by Ta, Ts and To for operation. • The operation is performed as shown in the following figure according to Ta value at the first time only. (In the range of $T_s + \alpha - 1 < T_a < T_s + \alpha + 1$, Cooling thermo. OFF (Fan)/Setup air volume operation continues.) <div style="text-align: center;"> </div> <ul style="list-style-type: none"> • α is corrected according to the outside temperature. <table border="1" style="width: 100%; border-collapse: collapse; margin-top: 10px;"> <thead> <tr> <th style="text-align: center;">Outside temp.</th> <th style="text-align: center;">Correction value (α)</th> </tr> </thead> <tbody> <tr> <td style="text-align: center;">No To</td> <td style="text-align: center;">0K</td> </tr> <tr> <td style="text-align: center;">$T_o \geq 24^\circ\text{C}$</td> <td style="text-align: center;">-1K</td> </tr> <tr> <td style="text-align: center;">$24 > T_o \geq 18^\circ\text{C}$</td> <td style="text-align: center;">0K</td> </tr> <tr> <td style="text-align: center;">$T_o < 18^\circ\text{C}$</td> <td style="text-align: center;">+1K</td> </tr> <tr> <td style="text-align: center;">To error</td> <td style="text-align: center;">0K</td> </tr> </tbody> </table>	Outside temp.	Correction value (α)	No To	0K	$T_o \geq 24^\circ\text{C}$	-1K	$24 > T_o \geq 18^\circ\text{C}$	0K	$T_o < 18^\circ\text{C}$	+1K	To error	0K	<p>Ta: Room temp. Ts: Setup temp. To: Outside temp.</p> <p style="text-align: right;">k = deg</p>
Remote controller command	Control outline																												
STOP	Air conditioner stops.																												
FAN	Fan operation																												
COOL	Cooling operation																												
DRY	Dry operation																												
HEAT	Heating operation																												
AUTO	<ul style="list-style-type: none"> • COOL/HEAT operation mode is automatically selected by Ta, Ts and To for operation. • The operation is performed as shown in the following figure according to Ta value at the first time only. (In the range of $T_s + \alpha - 1 < T_a < T_s + \alpha + 1$, Cooling thermo. OFF (Fan)/Setup air volume operation continues.) <div style="text-align: center;"> </div> <ul style="list-style-type: none"> • α is corrected according to the outside temperature. <table border="1" style="width: 100%; border-collapse: collapse; margin-top: 10px;"> <thead> <tr> <th style="text-align: center;">Outside temp.</th> <th style="text-align: center;">Correction value (α)</th> </tr> </thead> <tbody> <tr> <td style="text-align: center;">No To</td> <td style="text-align: center;">0K</td> </tr> <tr> <td style="text-align: center;">$T_o \geq 24^\circ\text{C}$</td> <td style="text-align: center;">-1K</td> </tr> <tr> <td style="text-align: center;">$24 > T_o \geq 18^\circ\text{C}$</td> <td style="text-align: center;">0K</td> </tr> <tr> <td style="text-align: center;">$T_o < 18^\circ\text{C}$</td> <td style="text-align: center;">+1K</td> </tr> <tr> <td style="text-align: center;">To error</td> <td style="text-align: center;">0K</td> </tr> </tbody> </table>	Outside temp.	Correction value (α)	No To	0K	$T_o \geq 24^\circ\text{C}$	-1K	$24 > T_o \geq 18^\circ\text{C}$	0K	$T_o < 18^\circ\text{C}$	+1K	To error	0K																
Outside temp.	Correction value (α)																												
No To	0K																												
$T_o \geq 24^\circ\text{C}$	-1K																												
$24 > T_o \geq 18^\circ\text{C}$	0K																												
$T_o < 18^\circ\text{C}$	+1K																												
To error	0K																												
3	Room temp. control	<p>1) Adjustment range: Remote controller setup temperature ($^\circ\text{C}$)</p> <table border="1" style="width: 100%; border-collapse: collapse; margin-top: 10px;"> <thead> <tr> <th></th> <th style="text-align: center;">COOL/DRY</th> <th style="text-align: center;">HEAT</th> <th style="text-align: center;">AUTO</th> </tr> </thead> <tbody> <tr> <td style="text-align: center;">Wired type</td> <td style="text-align: center;">18 to 29</td> <td style="text-align: center;">18 to 29</td> <td style="text-align: center;">18 to 29</td> </tr> <tr> <td style="text-align: center;">Wireless type</td> <td style="text-align: center;">18 to 30</td> <td style="text-align: center;">16 to 30</td> <td style="text-align: center;">17 to 27</td> </tr> </tbody> </table>		COOL/DRY	HEAT	AUTO	Wired type	18 to 29	18 to 29	18 to 29	Wireless type	18 to 30	16 to 30	17 to 27															
	COOL/DRY	HEAT	AUTO																										
Wired type	18 to 29	18 to 29	18 to 29																										
Wireless type	18 to 30	16 to 30	17 to 27																										

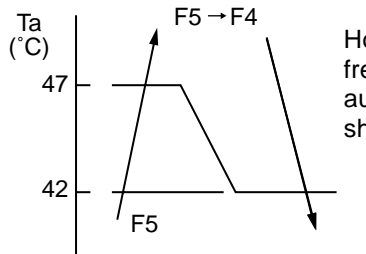
No.	Item	Outline of specifications	Remarks												
3	Room temp. control (Continued)	2) Using the Item code 06, the setup temperature in heating operation can be corrected. <table border="1" data-bbox="443 286 1096 369"> <thead> <tr> <th>Setup data</th> <th>0</th> <th>2</th> <th>4</th> <th>6</th> </tr> </thead> <tbody> <tr> <td>Setup temp. correction</td> <td>+0°C</td> <td>+2°C</td> <td>+4°C</td> <td>+6°C</td> </tr> </tbody> </table> Setting at shipment <table border="1" data-bbox="443 427 732 470"> <tbody> <tr> <td>Setup data</td> <td>2</td> </tr> </tbody> </table>	Setup data	0	2	4	6	Setup temp. correction	+0°C	+2°C	+4°C	+6°C	Setup data	2	Shift of suction temperature in heating operation
Setup data	0	2	4	6											
Setup temp. correction	+0°C	+2°C	+4°C	+6°C											
Setup data	2														
4	Automatic capacity control (GA control)	1) Based on the difference between Ta and Ts, the operation frequency is instructed to the outdoor unit. 2) Cooling operation Every 90 seconds, the room temperature difference between temperature detected by Ta and Ts and the varied room temperature value are calculated to obtain the correction value of the frequency command and then the present frequency command is corrected. $Ta(n) - Ts(n)$: Room temp. difference n : Counts of detection $Ta(n-1) - Ts(n)$: Varied room temp. value $n - 1$: Counts of detection of 90 seconds before 3) Heating operation Every 1 minute (60 sec.), the room temperature difference between temperature detected by Ta and Ts and the varied room temperature value are calculated to obtain the correction value of the frequency command and then the present frequency command is corrected. $Ts(n) - Ta(n)$: Room temp. difference n : Counts of detection $Ta(n) - Ta(n - 1)$: Varied room temp. value $n - 1$: Counts of detection of 1 minute before 4) Dry operation The frequency correction control is same as those of the cooling operation. However the maximum frequency is limited to approximately "S6". Note) When LOW is set up, the maximum frequency is limited to approximately "SB".													
5	Automatic cooling/heating control	1) The judgment of selecting COOL/HEAT is carried out as shown below. When +1.5 exceeds against Tsh 10 minutes and after thermo.-OFF, heating operation (Thermo. OFF) exchanges to cooling operation. Description in the parentheses shows an example of cooling ON/OFF. <div data-bbox="571 1624 970 1825" style="text-align: center;"> </div> When -1.5 lowers against Tsc 10 minutes and after thermo. OFF, cooling operation (Thermo. OFF) exchanges to heating operation. 2) For the automatic capacity control after judgment of cooling/heating, see Item 4. 3) For temperature correction of room temp. control in automatic heating, see Item 3.	Tsc: Setup temp. in cooling operation Tsh: Setup temp. in heating operation + temp. correction of room temp. control												



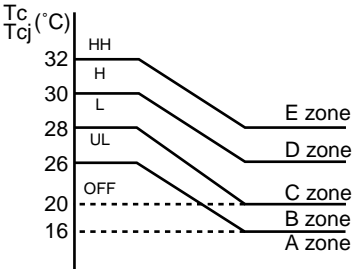

No.	Item	Outline of specifications	Remarks
6	Air speed selection	<p>1) Operation with (HH), (H), (L) or [AUTO] mode is carried out by the command from the remote controller.</p> <p>2) When the air speed mode [AUTO] is selected, the air speed varies by the difference between Ta and Ts.</p> <p><COOL></p>  <ul style="list-style-type: none"> Controlling operation in case when thermo of remote controller works is same as a case when thermo of the body works. If the air speed has been changed once, it is not changed for 3 minutes. However when the air volume is exchanged, the air speed changes. When cooling operation has started, select a downward slope for the air speed, that is, the high position. If the temperature is just on the difference boundary, the air speed does not change. Mode in the parentheses indicates one in automatic cooling operation. <p><HEAT></p>  <p>Value in the parentheses indicates one when thermostat of the remote controller works. Value without parentheses indicates one when thermostat of the body works.</p> <ul style="list-style-type: none"> If the air speed has been changed once, it is not changed for 1 minute. However when the air speed is exchanged, the air speed changes. When heating operation has started, select an upward slope for the air speed, that is, the high position. If the temperature is just on the difference boundary, the air speed does not change. Mode in the parentheses indicates one in automatic heating operation. In $T_c \geq 60^\circ\text{C}$, the air speed increases by 1 step. 	<p>HH > H+ > H > L+ > L > UL</p> <p>Tc: Indoor heat exchanger sensor temperature</p>

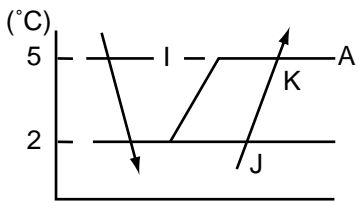

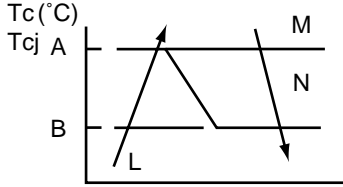

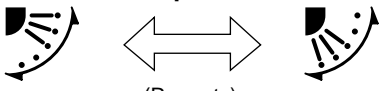

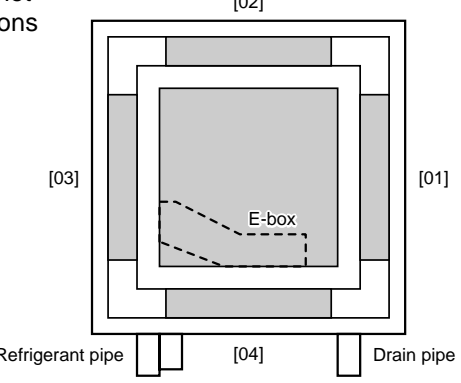
No.	Item	Outline of specifications	Remarks																																																																																																																																																																																																																																																	
6	Air speed selection (Continued): In case of 4-way Discharge Cassette type	<table border="1" data-bbox="443 235 1139 792"> <thead> <tr> <th rowspan="2">Item code [5d]</th> <th colspan="2">Standard</th> <th colspan="2">Type 1</th> <th colspan="2">Type 3</th> <th colspan="2">Type 6</th> </tr> <tr> <th colspan="2">0</th> <th colspan="2">1</th> <th colspan="2">3</th> <th colspan="2">6</th> </tr> <tr> <th>SW501 (1)/(2)</th> <th colspan="2">OFF/OFF</th> <th colspan="2">ON/OFF</th> <th colspan="2">OFF/ON</th> <th colspan="2">ON/ON</th> </tr> <tr> <th>Tap</th> <th>HEAT</th> <th>COOL</th> <th>HEAT</th> <th>COOL</th> <th>HEAT</th> <th>COOL</th> <th>HEAT</th> <th>COOL</th> </tr> </thead> <tbody> <tr><td>F1</td><td></td><td></td><td></td><td></td><td>HH</td><td>HH</td><td>HH</td><td>HH</td></tr> <tr><td>F2</td><td></td><td></td><td>HH</td><td>HH</td><td></td><td></td><td></td><td></td></tr> <tr><td>F3</td><td></td><td></td><td></td><td>H+</td><td>H+, H</td><td>H+, H</td><td>H+, H L+, L</td><td>H+, H L+, L</td></tr> <tr><td>F4</td><td></td><td></td><td>H+</td><td></td><td></td><td></td><td></td><td></td></tr> <tr><td>F5</td><td></td><td>HH</td><td></td><td>H</td><td></td><td></td><td></td><td></td></tr> <tr><td>F6</td><td>HH</td><td></td><td>H</td><td></td><td>L+</td><td>L+</td><td></td><td></td></tr> <tr><td>F7</td><td>H+</td><td>H+</td><td></td><td></td><td>L</td><td>L</td><td></td><td></td></tr> <tr><td>F8</td><td></td><td>H</td><td></td><td>L+</td><td></td><td></td><td></td><td></td></tr> <tr><td>F9</td><td>H</td><td></td><td>L+</td><td>L</td><td></td><td></td><td></td><td></td></tr> <tr><td>FA</td><td></td><td>L+</td><td>L</td><td></td><td></td><td></td><td></td><td></td></tr> <tr><td>FB</td><td>L+</td><td>L</td><td></td><td></td><td></td><td></td><td></td><td></td></tr> <tr><td>FC</td><td>L</td><td></td><td></td><td></td><td></td><td></td><td></td><td></td></tr> <tr><td>FD</td><td></td><td>UL</td><td></td><td>UL</td><td></td><td>UL</td><td></td><td>UL</td></tr> </tbody> </table> <table border="1" data-bbox="443 824 1139 1301"> <thead> <tr> <th rowspan="2">Tap</th> <th>SM56</th> <th>SM80</th> <th>SM110</th> <th>SM140</th> <th>SM160</th> </tr> <tr> <th colspan="5">Revolution speed (rpm)</th> </tr> </thead> <tbody> <tr><td>F1</td><td>610</td><td>630</td><td>700</td><td>700</td><td>700</td></tr> <tr><td>F2</td><td>550</td><td>590</td><td>670</td><td>670</td><td>670</td></tr> <tr><td>F3</td><td>500</td><td>530</td><td>660</td><td>660</td><td>660</td></tr> <tr><td>F4</td><td>450</td><td>470</td><td>640</td><td>650</td><td>650</td></tr> <tr><td>F5</td><td>400</td><td>450</td><td>620</td><td>640</td><td>640</td></tr> <tr><td>F6</td><td>390</td><td>440</td><td>610</td><td>630</td><td>630</td></tr> <tr><td>F7</td><td>370</td><td>410</td><td>550</td><td>560</td><td>580</td></tr> <tr><td>F8</td><td>350</td><td>380</td><td>490</td><td>490</td><td>530</td></tr> <tr><td>F9</td><td>340</td><td>370</td><td>480</td><td>480</td><td>520</td></tr> <tr><td>FA</td><td>330</td><td>350</td><td>450</td><td>460</td><td>490</td></tr> <tr><td>FB</td><td>320</td><td>330</td><td>400</td><td>430</td><td>450</td></tr> <tr><td>FC</td><td>310</td><td>320</td><td>400</td><td>420</td><td>440</td></tr> <tr><td>FD</td><td>250</td><td>250</td><td>300</td><td>300</td><td>300</td></tr> </tbody> </table> <p data-bbox="427 1323 1158 1630"> 3) In heating operation, the mode changes to [UL] if thermostat is turned off. 4) If $T_a \geq 25^\circ\text{C}$ when heating operation has started and when defrost operation has been cleared, the air conditioner operates with (H) mode or higher mode for 1 minute after T_c entered in E zone of cool air discharge preventive control (Item 7). 5) In automatic cooling/heating operation, the revolution frequency of (HH) is set larger than that in the standard cooling/heating operation. </p> <div data-bbox="459 1659 1158 1912">  <p data-bbox="799 1682 1158 1800">However the revolution frequency is restricted in the automatic heating operation as shown in the following figure.</p> </div> <p data-bbox="427 1951 1107 2047"> 6) Self-clean operation When performing self-clean operation after stopping the cooling operation, the mode becomes [UL] (210 rpm). </p>	Item code [5d]	Standard		Type 1		Type 3		Type 6		0		1		3		6		SW501 (1)/(2)	OFF/OFF		ON/OFF		OFF/ON		ON/ON		Tap	HEAT	COOL	HEAT	COOL	HEAT	COOL	HEAT	COOL	F1					HH	HH	HH	HH	F2			HH	HH					F3				H+	H+, H	H+, H	H+, H L+, L	H+, H L+, L	F4			H+						F5		HH		H					F6	HH		H		L+	L+			F7	H+	H+			L	L			F8		H		L+					F9	H		L+	L					FA		L+	L						FB	L+	L							FC	L								FD		UL		UL		UL		UL	Tap	SM56	SM80	SM110	SM140	SM160	Revolution speed (rpm)					F1	610	630	700	700	700	F2	550	590	670	670	670	F3	500	530	660	660	660	F4	450	470	640	650	650	F5	400	450	620	640	640	F6	390	440	610	630	630	F7	370	410	550	560	580	F8	350	380	490	490	530	F9	340	370	480	480	520	FA	330	350	450	460	490	FB	320	330	400	430	450	FC	310	320	400	420	440	FD	250	250	300	300	300	<p data-bbox="1182 248 1406 434">Selection of high ceiling type Item code: [5d] or selection of high ceiling on P.C. board SW501</p> <p data-bbox="1182 1547 1414 1659">However only when the high ceiling selection is set to [Standard]</p> <p data-bbox="1182 1957 1382 2018">[Self-clean  </p>
Item code [5d]	Standard			Type 1		Type 3		Type 6																																																																																																																																																																																																																																												
	0		1		3		6																																																																																																																																																																																																																																													
SW501 (1)/(2)	OFF/OFF		ON/OFF		OFF/ON		ON/ON																																																																																																																																																																																																																																													
Tap	HEAT	COOL	HEAT	COOL	HEAT	COOL	HEAT	COOL																																																																																																																																																																																																																																												
F1					HH	HH	HH	HH																																																																																																																																																																																																																																												
F2			HH	HH																																																																																																																																																																																																																																																
F3				H+	H+, H	H+, H	H+, H L+, L	H+, H L+, L																																																																																																																																																																																																																																												
F4			H+																																																																																																																																																																																																																																																	
F5		HH		H																																																																																																																																																																																																																																																
F6	HH		H		L+	L+																																																																																																																																																																																																																																														
F7	H+	H+			L	L																																																																																																																																																																																																																																														
F8		H		L+																																																																																																																																																																																																																																																
F9	H		L+	L																																																																																																																																																																																																																																																
FA		L+	L																																																																																																																																																																																																																																																	
FB	L+	L																																																																																																																																																																																																																																																		
FC	L																																																																																																																																																																																																																																																			
FD		UL		UL		UL		UL																																																																																																																																																																																																																																												
Tap	SM56	SM80	SM110	SM140	SM160																																																																																																																																																																																																																																															
	Revolution speed (rpm)																																																																																																																																																																																																																																																			
F1	610	630	700	700	700																																																																																																																																																																																																																																															
F2	550	590	670	670	670																																																																																																																																																																																																																																															
F3	500	530	660	660	660																																																																																																																																																																																																																																															
F4	450	470	640	650	650																																																																																																																																																																																																																																															
F5	400	450	620	640	640																																																																																																																																																																																																																																															
F6	390	440	610	630	630																																																																																																																																																																																																																																															
F7	370	410	550	560	580																																																																																																																																																																																																																																															
F8	350	380	490	490	530																																																																																																																																																																																																																																															
F9	340	370	480	480	520																																																																																																																																																																																																																																															
FA	330	350	450	460	490																																																																																																																																																																																																																																															
FB	320	330	400	430	450																																																																																																																																																																																																																																															
FC	310	320	400	420	440																																																																																																																																																																																																																																															
FD	250	250	300	300	300																																																																																																																																																																																																																																															



No.	Item	Outline of specifications	Remarks																																																																																																																																																																																																																				
6	Air speed selection (Continued): In case of Slim Duct Type	<p data-bbox="443 219 625 248">Slim Duct Type</p> <table border="1" data-bbox="443 264 1139 808"> <thead> <tr> <th data-bbox="443 264 592 327">Item code [5d]</th> <th colspan="2" data-bbox="592 264 730 327">Standard</th> <th colspan="2" data-bbox="730 264 869 327">Type 1</th> <th colspan="2" data-bbox="869 264 1008 327">Type 3</th> <th colspan="2" data-bbox="1008 264 1139 327">Type 6</th> </tr> <tr> <td></td> <td colspan="2" data-bbox="592 297 730 327">0</td> <td colspan="2" data-bbox="730 297 869 327">1</td> <td colspan="2" data-bbox="869 297 1008 327">3</td> <td colspan="2" data-bbox="1008 297 1139 327">6</td> </tr> <tr> <td data-bbox="443 327 592 358">SW501 (1)/(2)</td> <td colspan="2" data-bbox="592 327 730 358">OFF/OFF</td> <td colspan="2" data-bbox="730 327 869 358">ON/OFF</td> <td colspan="2" data-bbox="869 327 1008 358">OFF/ON</td> <td colspan="2" data-bbox="1008 327 1139 358">ON/ON</td> </tr> <tr> <th data-bbox="443 358 592 389">Tap</th> <th data-bbox="592 358 660 389">HEAT</th> <th data-bbox="660 358 730 389">COOL</th> <th data-bbox="730 358 799 389">HEAT</th> <th data-bbox="799 358 869 389">COOL</th> <th data-bbox="869 358 938 389">HEAT</th> <th data-bbox="938 358 1008 389">COOL</th> <th data-bbox="1008 358 1077 389">HEAT</th> <th data-bbox="1077 358 1139 389">COOL</th> </tr> </thead> <tbody> <tr><td data-bbox="443 389 592 421">F1</td><td></td><td></td><td></td><td></td><td></td><td></td><td>HH</td><td>HH</td></tr> <tr><td data-bbox="443 421 592 452">F2</td><td></td><td></td><td></td><td></td><td>HH</td><td>HH</td><td>H+</td><td>H+</td></tr> <tr><td data-bbox="443 452 592 483">F3</td><td></td><td></td><td></td><td></td><td></td><td></td><td>H</td><td>H</td></tr> <tr><td data-bbox="443 483 592 515">F4</td><td></td><td></td><td>HH</td><td>HH</td><td>H+</td><td>H+</td><td></td><td></td></tr> <tr><td data-bbox="443 515 592 546">F5</td><td></td><td></td><td></td><td></td><td>H</td><td>H</td><td>L+</td><td>L+</td></tr> <tr><td data-bbox="443 546 592 577">F6</td><td></td><td></td><td></td><td></td><td></td><td></td><td></td><td></td></tr> <tr><td data-bbox="443 577 592 609">F7</td><td>HH</td><td>HH</td><td>H+</td><td>H+</td><td></td><td></td><td></td><td></td></tr> <tr><td data-bbox="443 609 592 640">F8</td><td></td><td></td><td>H</td><td>H</td><td>L+</td><td>L+</td><td></td><td></td></tr> <tr><td data-bbox="443 640 592 672">F9</td><td>H+</td><td>H+</td><td></td><td></td><td></td><td></td><td></td><td></td></tr> <tr><td data-bbox="443 672 592 703">FA</td><td>H</td><td>H</td><td>L+</td><td>L+</td><td></td><td></td><td></td><td></td></tr> <tr><td data-bbox="443 703 592 734">FB</td><td>L+</td><td>L+</td><td></td><td></td><td></td><td></td><td></td><td></td></tr> <tr><td data-bbox="443 734 592 766">FC</td><td>L</td><td>L</td><td></td><td></td><td></td><td></td><td></td><td></td></tr> <tr><td data-bbox="443 766 592 797">FD</td><td>LL</td><td>LL</td><td>LL</td><td>LL</td><td>LL</td><td>LL</td><td>LL</td><td>LL</td></tr> </tbody> </table> <p data-bbox="443 846 625 875">Slim Duct Type</p> <table border="1" data-bbox="443 891 1139 1368"> <thead> <tr> <th data-bbox="443 891 592 954" rowspan="2">Tap</th> <th data-bbox="592 891 778 954">SM40</th> <th data-bbox="778 891 965 954">SM45</th> <th data-bbox="965 891 1139 954">SM56</th> </tr> <tr> <th colspan="3" data-bbox="592 925 1139 954">Revolution speed (rpm)</th> </tr> </thead> <tbody> <tr><td data-bbox="443 954 592 985">F1</td><td data-bbox="592 954 778 985">1260</td><td data-bbox="778 954 965 985">1260</td><td data-bbox="965 954 1139 985">1320</td></tr> <tr><td data-bbox="443 985 592 1016">F2</td><td data-bbox="592 985 778 1016">1180</td><td data-bbox="778 985 965 1016">1180</td><td data-bbox="965 985 1139 1016">1220</td></tr> <tr><td data-bbox="443 1016 592 1048">F3</td><td data-bbox="592 1016 778 1048">1120</td><td data-bbox="778 1016 965 1048">1120</td><td data-bbox="965 1016 1139 1048">1220</td></tr> <tr><td data-bbox="443 1048 592 1079">F4</td><td data-bbox="592 1048 778 1079">1040</td><td data-bbox="778 1048 965 1079">1040</td><td data-bbox="965 1048 1139 1079">1220</td></tr> <tr><td data-bbox="443 1079 592 1111">F5</td><td data-bbox="592 1079 778 1111">1020</td><td data-bbox="778 1079 965 1111">1020</td><td data-bbox="965 1079 1139 1111">1180</td></tr> <tr><td data-bbox="443 1111 592 1142">F6</td><td data-bbox="592 1111 778 1142">990</td><td data-bbox="778 1111 965 1142">990</td><td data-bbox="965 1111 1139 1142">1180</td></tr> <tr><td data-bbox="443 1142 592 1173">F7</td><td data-bbox="592 1142 778 1173">960</td><td data-bbox="778 1142 965 1173">960</td><td data-bbox="965 1142 1139 1173">1180</td></tr> <tr><td data-bbox="443 1173 592 1205">F8</td><td data-bbox="592 1173 778 1205">950</td><td data-bbox="778 1173 965 1205">950</td><td data-bbox="965 1173 1139 1205">1040</td></tr> <tr><td data-bbox="443 1205 592 1236">F9</td><td data-bbox="592 1205 778 1236">910</td><td data-bbox="778 1205 965 1236">910</td><td data-bbox="965 1205 1139 1236">990</td></tr> <tr><td data-bbox="443 1236 592 1267">FA</td><td data-bbox="592 1236 778 1267">870</td><td data-bbox="778 1236 965 1267">870</td><td data-bbox="965 1236 1139 1267">990</td></tr> <tr><td data-bbox="443 1267 592 1299">FB</td><td data-bbox="592 1267 778 1299">840</td><td data-bbox="778 1267 965 1299">840</td><td data-bbox="965 1267 1139 1299">880</td></tr> <tr><td data-bbox="443 1299 592 1330">FC</td><td data-bbox="592 1299 778 1330">790</td><td data-bbox="778 1299 965 1330">790</td><td data-bbox="965 1299 1139 1330">820</td></tr> <tr><td data-bbox="443 1330 592 1361">FD</td><td data-bbox="592 1330 778 1361">550</td><td data-bbox="778 1330 965 1361">550</td><td data-bbox="965 1330 1139 1361">550</td></tr> </tbody> </table> <p data-bbox="443 1397 1139 1608"> 3) In heating operation, the mode changes to [UL] if thermostat is turned off. 4) If $T_a \geq 25^\circ\text{C}$ when heating operation has started and when defrost operation has been cleared, the air conditioner operates with (H) mode or higher mode for 1 minute after T_c entered in E zone of cool air discharge preventive control (Item 7). </p>	Item code [5d]	Standard		Type 1		Type 3		Type 6			0		1		3		6		SW501 (1)/(2)	OFF/OFF		ON/OFF		OFF/ON		ON/ON		Tap	HEAT	COOL	HEAT	COOL	HEAT	COOL	HEAT	COOL	F1							HH	HH	F2					HH	HH	H+	H+	F3							H	H	F4			HH	HH	H+	H+			F5					H	H	L+	L+	F6									F7	HH	HH	H+	H+					F8			H	H	L+	L+			F9	H+	H+							FA	H	H	L+	L+					FB	L+	L+							FC	L	L							FD	LL	LL	LL	LL	LL	LL	LL	LL	Tap	SM40	SM45	SM56	Revolution speed (rpm)			F1	1260	1260	1320	F2	1180	1180	1220	F3	1120	1120	1220	F4	1040	1040	1220	F5	1020	1020	1180	F6	990	990	1180	F7	960	960	1180	F8	950	950	1040	F9	910	910	990	FA	870	870	990	FB	840	840	880	FC	790	790	820	FD	550	550	550	<p data-bbox="1177 255 1437 439">Selection of high static pressure type Item code: [5d] or selection of high static pressure on P.C. board SW501</p>
Item code [5d]	Standard		Type 1		Type 3		Type 6																																																																																																																																																																																																																
	0		1		3		6																																																																																																																																																																																																																
SW501 (1)/(2)	OFF/OFF		ON/OFF		OFF/ON		ON/ON																																																																																																																																																																																																																
Tap	HEAT	COOL	HEAT	COOL	HEAT	COOL	HEAT	COOL																																																																																																																																																																																																															
F1							HH	HH																																																																																																																																																																																																															
F2					HH	HH	H+	H+																																																																																																																																																																																																															
F3							H	H																																																																																																																																																																																																															
F4			HH	HH	H+	H+																																																																																																																																																																																																																	
F5					H	H	L+	L+																																																																																																																																																																																																															
F6																																																																																																																																																																																																																							
F7	HH	HH	H+	H+																																																																																																																																																																																																																			
F8			H	H	L+	L+																																																																																																																																																																																																																	
F9	H+	H+																																																																																																																																																																																																																					
FA	H	H	L+	L+																																																																																																																																																																																																																			
FB	L+	L+																																																																																																																																																																																																																					
FC	L	L																																																																																																																																																																																																																					
FD	LL	LL	LL	LL	LL	LL	LL	LL																																																																																																																																																																																																															
Tap	SM40	SM45	SM56																																																																																																																																																																																																																				
	Revolution speed (rpm)																																																																																																																																																																																																																						
F1	1260	1260	1320																																																																																																																																																																																																																				
F2	1180	1180	1220																																																																																																																																																																																																																				
F3	1120	1120	1220																																																																																																																																																																																																																				
F4	1040	1040	1220																																																																																																																																																																																																																				
F5	1020	1020	1180																																																																																																																																																																																																																				
F6	990	990	1180																																																																																																																																																																																																																				
F7	960	960	1180																																																																																																																																																																																																																				
F8	950	950	1040																																																																																																																																																																																																																				
F9	910	910	990																																																																																																																																																																																																																				
FA	870	870	990																																																																																																																																																																																																																				
FB	840	840	880																																																																																																																																																																																																																				
FC	790	790	820																																																																																																																																																																																																																				
FD	550	550	550																																																																																																																																																																																																																				

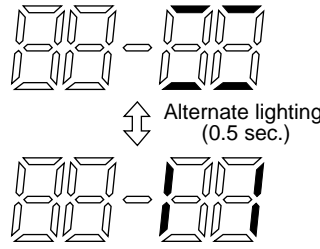
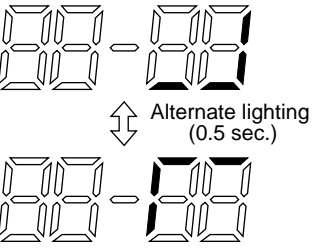



No.	Item	Outline of specifications	Remarks
7	Cool air discharge preventive control	<p>1) In heating operation, the indoor fan is controlled based on the detected temperature of Tc sensor or Tcj sensor. As shown below, the upper limit of the revolution frequency is restricted.</p> <p>However B zone is assumed as C zone for 6 minutes and after when the compressor activated.</p> <p>In defrost operation, the control value of Tc is shifted by 6°C.</p> 	<p>In D and E zones, the priority is given to air volume selection setup of remote controller.</p> <p>In A zone while thermo is ON, [PRE-HEAT  (Heating ready)] is displayed.</p>
8	Freeze preventive control (Low temperature release)	<p>1) The cooling operation (including Dry operation) is performed as follows based on the detected temperature of Tc sensor or Tcj sensor.</p> <p>When [J] zone is detected for 6 minutes (Following figure), the commanded frequency is decreased from the real operation frequency.</p> <p>After then the commanded frequency changes every 30 seconds while operation is performed in [J] zone.</p> <p>In [K] zone, time counting is interrupted and the operation is held.</p> <p>When [I] zone is detected, the timer is cleared and the operation returns to the normal operation.</p> <p>If the commanded frequency becomes S0 because the operation continues in [J] zone, the return temperature A is raised from 5°C to 12°C until [I] zone is detected and the indoor fan operates with [L] mode.</p>  <p>In heating operation, the freeze-preventive control works if 4-way valve is not exchanged and the following conditions are satisfied. (However the temperature for J zone dashing control is changed from 2°C to -5°C.)</p> <p><Conditions></p> <ul style="list-style-type: none"> • When ① or ② is established 5 minutes after activation. ① $T_{cn} \leq T_c(n-1) - 5$ ② $T_{cn} < T_c(n-1) - 1$ and $T_{cn} \leq T_a < 5^\circ\text{C}$ 	<p>Tcj: Indoor heat exchanger sensor temperature</p> <p>Tcn: Tc temperature when 5 minutes elapsed after activation</p> <p>Tc (n - 1): Tc temperature at start time</p>







No.	Item	Outline of specifications	Remarks						
9	High-temp. release control	<p>1) The heating operation is performed as follows based on the detected temperature of Tc sensor or Tcj sensor.</p> <ul style="list-style-type: none"> • When [M] zone is detected, the commanded frequency is decreased from the real operation frequency. After then the commanded frequency changes every 30 seconds while operation is performed in [M] zone. • In [N] zone, the commanded frequency is held. • When [L] zone is detected, the commanded frequency is returned to the original value by approx. 6Hz every 60 seconds. <p>Setup at shipment</p> <table border="1" data-bbox="437 600 678 719"> <thead> <tr> <th colspan="2">Control temp. (°C)</th> </tr> <tr> <th>A</th> <th>B</th> </tr> </thead> <tbody> <tr> <td>56 (54)</td> <td>52 (52)</td> </tr> </tbody> </table>  <p>NOTE: When the operation has started or when Tc or Tcj < 30°C at start of the operation or after operation start, temperature is controlled between values in parentheses of A and B.</p>	Control temp. (°C)		A	B	56 (54)	52 (52)	<p>However this control is ignored in case of the follower unit of the twin.</p> <p>Same status as that when “thermostat-OFF” (status that the air conditioner enters in the room temp. monitor mode when the temperature reached the setup temperature on the remote controller)</p>
Control temp. (°C)									
A	B								
56 (54)	52 (52)								
10	Drain pump control	<ol style="list-style-type: none"> 1) In cooling operation (including Dry operation), the drain pump is usually operated. 2) If the float switch works while drain pump drives, the compressor stops, the drain pump continues the operation, and a check code is output. 3) If the float switch works while drain pump stops, the compressor stops and the drain pump operates. If the float switch keeps operating for approx. 4 minutes, a check code is output. 	Check code [P10]						
11	After-heat elimination	When heating operation stops, in some cases, the indoor fan operates with (L) for approx. 30 seconds.	⊖ is displayed.						





No.	Item	Outline of specifications	Remarks
12	Louver control: In case of 4-way Discharge Cassette type	<p>1) Louver position setup</p> <ul style="list-style-type: none"> When the louver position is changed, the position moves necessarily to downward discharge position once to return to the set position. The louver position can be set up in the following operation range. <p>In cooling/dry operation In heating/fan operation</p>  <ul style="list-style-type: none"> In group twin/triple operation, the louver positions can be set up collectively or individually. <p>2) Swing setup</p> <ul style="list-style-type: none"> [SWING] is displayed and the following display is repeated. <p>In all operations</p>  <p>(Repeats)</p> <ul style="list-style-type: none"> In group twin operation, the louver positions can be set up collectively or individually. <p>3) When the unit stopped or the warning was output, the louver is automatically set to full closed position.</p> <p>4) When PRE-HEAT (Heating ready) is displayed (Heating operation started or defrost operation is performed), heating thermo is off or self-cleaning is performed, the louver is automatically set to horizontal discharge position.</p> <p>* The louver which air direction is individually set or the locked louver closes fully when the unit stops and the louver is automatically set to horizontal discharge position when PRE-HEAT (Heating ready) is displayed, heating thermo is off or self-cleaning is performed.</p> <p><<Individual air direction setup>></p> <ul style="list-style-type: none"> Pushing  Louver select button enables every discharge port to set up the air direction. In case of no input (key operation) for approx. 5 seconds during setting of individual air direction (during displaying of louver No. on the remote controller screen), the remote controller screen returns to the normal display screen. For the air direction illustration during normal operation, the air direction of the least No. among the louvers which are block-set is displayed. While individual air direction is being set, the remote controller operation (Illustration of air direction) and operation of the real machine are linked. When selecting a case,  Louver select button is not pushed or louver No. is not displayed, the air directions of all the louvers are collectively set up. 	<p>The louver position at horizontal discharge position at under SM80 differs from that at over SM110.</p> <p>The swinging louver moves usually up to the ceiling side from the louver position of the set time.</p> <p>Setup from the remote controller without  button is unavailable.</p> <p>For the setup operation, refer to "How to set up louver individually" of Item "Setup at local site/Others".</p> <p>Using same as the present 4-way Air Discharge Cassette Type is possible</p>

No.	Item	Outline of specifications	Remarks															
12	Louver control (Continued): In case of 4-way Discharge Cassette type	<p><<Selection of Swing mode>></p> <ul style="list-style-type: none"> For the Swing mode, the following three types of modes are selectable and settable by keeping Swing/Direction  button pushed for 4 seconds or more on the remote controller. <ol style="list-style-type: none"> Standard (4 pieces: same phase) swing → Data: [0001 (At shipment)] When Swing operation is selected, four louvers align at the horizontal discharge position and then start the Swing operation at the same time. Dual swing → Data: [0002] When operation is selected, the louvers of louver No. [01] and [03] move to the horizontal discharge position, the louvers of louver No. [02] and [04] move to the downward discharge position and then start the Swing operation at the same time. Cycle swing → Data: [0003] When operation is selected, the louver No. [01] moves to the horizontal discharge position, [03] to the downward discharge position, [02] and [04] to the middle position and then start the Swing operation at the same time. Three types of the swing modes can be also selected and set by the setup data of Item code (DN) [F0]. In case of selecting the Swing mode, “Dual swing” or “Cycle swing”, the following numerals is displayed at the center of the remote controller screen for approx. 3 seconds when  button was pushed to select [SWING]. (No display for the standard swing) <div style="display: flex; justify-content: space-around; align-items: center;"> <div style="text-align: center;">  <p>Dual swing</p> </div> <div style="text-align: center;">  <p>Cycle swing</p> </div> </div> <p><<Louver lock (Louver fix)>></p> <ul style="list-style-type: none"> For the air direction setup for each discharge port, the louver position can be locked during the normal operation. An arbitrary air direction of an arbitrary louver can be registered and set by keeping  button pushed for 4 seconds or more on the remote controller. The louver lock can be set by registering the setup data to Item code (DN) [F1] to [F4] according to the following table. <table border="1" data-bbox="438 1825 1125 2027" style="width: 100%; border-collapse: collapse;"> <thead> <tr> <th>Item code</th> <th>Objective louver No.</th> <th>Setup data</th> </tr> </thead> <tbody> <tr> <td>F1</td> <td>01</td> <td>0000: Release (At shipment)</td> </tr> <tr> <td>F2</td> <td>02</td> <td>0001: Horizontal discharge position</td> </tr> <tr> <td>F3</td> <td>03</td> <td style="text-align: center;">~</td> </tr> <tr> <td>F4</td> <td>04</td> <td>0005: Downward discharge position</td> </tr> </tbody> </table>	Item code	Objective louver No.	Setup data	F1	01	0000: Release (At shipment)	F2	02	0001: Horizontal discharge position	F3	03	~	F4	04	0005: Downward discharge position	<p>On the remote controller before the wired remote controller (RBC-AMT31E), the mode cannot be moved to the select mode  even if pushing  button for a long time.</p> <p>Carry out setting operation during stop of the unit; otherwise the unit stops operation.</p> <p>The standard swing performs the same swing operation as the present operation (2 series).</p> <p>For the setting operation, refer to [How to set up type of the swings] in Item “Setup at local site/Others”.</p> <p>On the remote controller before the wired remote controller (RBC-AMT31E), flashing showing the Swing mode is not indicated.</p> <p>On the remote controller before the wired remote controller (RBC-AMT31E), flashing showing the Swing mode is not provided.</p> <p>Carry out setting operation during stop of the unit; otherwise the unit stops operation.</p>
Item code	Objective louver No.	Setup data																
F1	01	0000: Release (At shipment)																
F2	02	0001: Horizontal discharge position																
F3	03	~																
F4	04	0005: Downward discharge position																

No.	Item	Outline of specifications	Remarks																					
12	Louver control (Continued): In case of 4-way Discharge Cassette type	<ul style="list-style-type: none"> • If there is the locked louver in the unit, [] goes on the remote controller screen. • While the following controls are performed, the louvers operate even if executing the louver lock. <table border="1" data-bbox="475 358 1161 638"> <thead> <tr> <th></th> <th>Control which ignores lock</th> <th>Objective louver No.</th> </tr> </thead> <tbody> <tr> <td>①</td> <td>Operation stop</td> <td>Full-close position</td> </tr> <tr> <td>②</td> <td>When heating operation started</td> <td>Horizontal discharge position</td> </tr> <tr> <td>③</td> <td>Heating thermo. OFF</td> <td>Horizontal discharge position</td> </tr> <tr> <td>④</td> <td>During defrost operation</td> <td>Horizontal discharge position</td> </tr> <tr> <td>⑤</td> <td>Initialize operation</td> <td>Full-close position</td> </tr> <tr> <td>⑥</td> <td>Self-clean operation</td> <td>Horizontal discharge position</td> </tr> </tbody> </table> <ul style="list-style-type: none"> • The real louver corresponding to the louver No. displayed on the remote controller screen during setting of louver lock operates swinging. 		Control which ignores lock	Objective louver No.	①	Operation stop	Full-close position	②	When heating operation started	Horizontal discharge position	③	Heating thermo. OFF	Horizontal discharge position	④	During defrost operation	Horizontal discharge position	⑤	Initialize operation	Full-close position	⑥	Self-clean operation	Horizontal discharge position	<p>For the setting operation, refer to [How to set louver lock] of Installation Manual.</p> <p>It is position check operation and it does not link with the real louver and air direction setup (Illustration on the remote controller screen).</p>
	Control which ignores lock	Objective louver No.																						
①	Operation stop	Full-close position																						
②	When heating operation started	Horizontal discharge position																						
③	Heating thermo. OFF	Horizontal discharge position																						
④	During defrost operation	Horizontal discharge position																						
⑤	Initialize operation	Full-close position																						
⑥	Self-clean operation	Horizontal discharge position																						
13	HA control	<ol style="list-style-type: none"> 1) This control is connected to TV control or remote start/stop I/F, etc, and start/stop are available by HA signal input from the remote position. 2) This control outputs start/stop status to HA output terminal. 3) I/O specifications conform to JEMA regulations. 4) This control outputs [Operation OFF (STOP) signal] to HA output terminal while self-cleaning works. However selection of [Operation ON (Operating) signal] is possible by changing [0000 (At shipment)] of Item code (DN) [CC] to [0001]. In this case, if HA is input during self-clean operation during operation of the air conditioner, the self-clean operation is not performed. (Unit stops.) 	In the group operation, use this control by connecting to either master or follower indoor unit.																					
14	Frequency fixed operation (Test run)	<p><In case of wired remote controller></p> <ol style="list-style-type: none"> 1) When pushing [CHK] button for 4 seconds or more, [TEST] is displayed on the display screen and the mode enters in Test run mode. 2) Push [ON/OFF] button. 3) Using [MODE] button, set the mode to [COOL] or [HEAT]. <ul style="list-style-type: none"> • Do not use other mode than [COOL]/[HEAT] mode. • During test run operation, the temperature cannot be adjusted. • An error is detected as usual. • A frequency fixed operation is performed. 4) After the test run, push [ON/OFF] button to stop the operation. (Display in the display part is same as the procedure in Item 1.) 5) Push [CHK] button to clear the test run mode. ([TEST] display in the display part disappears and the status returns to the normal stop status.) 	Command frequency is approximately [S7]																					
15	Filter sign display (Except wireless type) * It is provided on the separately sold type TCB-AX21E2.	<ol style="list-style-type: none"> 1) The operation time of the indoor fan is calculated, the filter reset signal is sent to the remote controller when the specified time (2500H) has passed, and it is displayed on LCD. 2) When the filter reset signal has been received from the remote controller, time of the calculation timer is cleared. In this case, the measurement time is reset if the specified time has passed, and display on LCD disappears. 	[FILTER ] goes on.																					

No.	Item	Outline of specifications	Remarks
16	Central control mode selection	<p>1) Setting at the centerl controller side enables to select the contents which can be operated on the remote controller at indoor unit side.</p> <p>2) Setup contents</p> <ul style="list-style-type: none"> • 64 line central controller (TCB-SC642TLE2) <p>[Individual]: Operated on the remote controller (Priority to second pushing)</p> <p>[Central 1]: ON/OFF operation cannot be operated on the remote controller.</p> <p>[Central 2]: ON/OFF, mode selection, temp. setup operations cannot be operated on the remote controller.</p> <p>[Central 3]: Mode selection and temp. setup operations cannot be operated on the remote controller.</p> <p>[Central 4]: Mode selection cannot be operated on the remote controller.</p> <p>* In case of the wireless type, the display lamp does not change but the contents are same. If operating an item which is prohibited by the central control mode from the remote controller, it is notified with the receive sound, Pi, Pi, Pi, Pi, Pi (5 times).</p>	<p>Display at remote controller side (No display)</p> <p>[Central ] goes on</p> <p>[Central ] goes on</p> <p>[Central ] goes on</p> <p>[Central ] goes on</p>
17	Energy-saving control	<p>1) Selecting [AUTO] mode enables an energy-saving to be operated.</p> <p>2) The setup temperature is shifted (corrected) in the range not to lose the comfort ability according to input values of various sensors.</p> <p>3) Data (Input value room temp. Ta, Outside temp. To, Air volume, Indoor heat exchanger sensor temp. Tc) for 20 minutes are taken the average to calculate correction value of the setup temperature.</p> <p>4) The setup temperature is shifted every 20 minutes, and the shifted range is as follows.</p> <p>In cooling time: +1.5 to - 1.0K In heating time: -1.5 to +1.0K</p>	
18	Max. frequency cut control	<p>1) This control is operated by selecting [AUTO] operation mode.</p> <p>2) COOL operation mode: It is controlled according to the following figure if $T_o < 28^{\circ}\text{C}$.</p> <p>3) HEAT operation mode: It is controlled according to the following figure if $T_o > 15^{\circ}\text{C}$.</p> <div style="display: flex; justify-content: space-around;"> <div data-bbox="491 1615 922 1832"> </div> <div data-bbox="986 1576 1417 1787"> </div> </div>	

No.	Item	Outline of specifications	Remarks														
19	DC motor	1) When the fan operation has started, positioning of the stator and the rotor are performed. (Moves slightly with tap sound) 2) The motor operates according to the command from the indoor controller. Notes) <ul style="list-style-type: none"> • When the fan rotates while the air conditioner stops due to entering of outside air, etc, the air conditioner may operate while the fan motor stops. • When a fan lock is found, the air conditioner stops, and an error is displayed. 	Check code [P12]														
20	Self-clean operation (Dry operation): In case of 4-way Discharge Cassette type	1) When cooling operation mode (AUTO COOL, COOL, DRY) stopped, the following three self-clean operations are performed. <table border="1" data-bbox="491 707 1422 891" style="margin: 10px auto;"> <thead> <tr> <th>Compressor ON period</th> <th>Self-clean operation period</th> <th>FAN</th> <th>Drain pump</th> <th>Louver</th> </tr> </thead> <tbody> <tr> <td>0 to 10 min.</td> <td>None</td> <td rowspan="3">Fan (UL)</td> <td rowspan="3">STOP</td> <td rowspan="3">Horizontal discharge position</td> </tr> <tr> <td>10 to 60 min.</td> <td>1 hour</td> </tr> <tr> <td>60 min. to</td> <td>2 hours</td> </tr> </tbody> </table> 2) During operation of self-clean,  lights on the wired remote controller screen. However the operation lamp (Green LED) goes off. 3) To stop the self-clean operation, push twice the [ON/OFF] button on the remote controller continuously. (Stop the operation as compressor ON time in the table above: 10 minutes or below.) 4) When the follower unit executes self-clean operation in the group connection, the segment of  is displayed on the wired remote controller screen via master unit. * If self-clean operation is not used, set invalidity (does not use) of the self-clean operation by changing [0001 (At shipment) of Item code (DN) [D3] to [0000]. * To erase the  display during operation of self-clean, change Item code [D4] from [0000: Display (At shipment)] to [0001: Non-display].	Compressor ON period	Self-clean operation period	FAN	Drain pump	Louver	0 to 10 min.	None	Fan (UL)	STOP	Horizontal discharge position	10 to 60 min.	1 hour	60 min. to	2 hours	On the remote controller before the wired remote controller (RBC-AMT31E), Self-clean operation display is not output. And it is not also on the wireless remote controller. It is recognized as [STOP] from the remote monitor side.
Compressor ON period	Self-clean operation period	FAN	Drain pump	Louver													
0 to 10 min.	None	Fan (UL)	STOP	Horizontal discharge position													
10 to 60 min.	1 hour																
60 min. to	2 hours																
21	Save operation	1) Turn on  button on the remote controller. 2) During operation of save operation,  lights on the wired remote controller. 3) During save operation, the current release control is performed with the restriction ratio set in EEPROM on the outdoor unit. 4) The restriction ratio can be set by keeping  button pushed for 4 seconds or more on the remote controller. 5) When validating the save operation, the next operation starts with save operation valid because contents are held even when operation stops, operation mode changes or power supply is reset. 6) The restriction ratio can be set by changing the setup data of Item code (DN) [C2] in the range of 50 to 100% (every 1%, Setting at shipment: 75%).	Operation and display also are unavailable on the wired remote controller RBC-AMT31E and before. Carry out setting operation during stop of the unit; otherwise the unit stops operation. For the setup operation, refer to “How to set up contents of save operation” of Installation Manual.														

No.	Item	Outline of specifications	Remarks
22	8°C heating/ Frost protective operation	<ol style="list-style-type: none"> 1) This functional is intended for the cold latitudes and performs objective heating operation (8°C heating operation). 2) This function is valid only for combination with the outdoor units (Super Digital Inverter (SDI) 4-series outdoor units). 3) Using the indoor DN code [D1] (1 bit), Valid/Invalid of this function is set up at the customer's side. * The setup by DN code is Invalid [0]/Valid [1] and Invalid [0] has been set at the shipment. 4) This operation is the heating operation which sets 8°C as the setup temperature of the target. 5) This function starts operation by pushing temperature button  during heating operation; besides by pushing  button for 4 seconds or more after temperature reached the minimum set temperature. 6) To stop/release this operation, select and execute one from the following operations. <ol style="list-style-type: none"> ① Push  button: Heating operation (18°C setting) continues. ② Push [START/STOP] button: Air conditioner stops. (Heating 18°C operation at the next start) ③ Push  : Other operation mode is selected and the operation continues. 7) As the setup temperature is 8°C and the human heating is not targeted, the cold air discharge preventive control (Item 7) is made invalid to suppress the intermittent operation. 8) The settings of the air direction and air volume are changeable during this operation. 9) The indoor fan stops to protect the compressor for 2 minutes after start of heating operation (Thermo-ON) by this function. 	<p>In a group connection, if there is even one combination with other unit, "This function is not provided." is displayed.</p> <p>The setup temperature jumps from [18] to [8].</p>

Function	Connector No.	Pin No.	Specifications	Remarks
Humidifier output (*)	CN66	1	DC12V	Humidifier output is ON when heating operation is performed, when thermostat is on, when the fan is on. * The setting of Humidifier provided + Drain pump ON is performed by short-circuit of CN70 or from the remote controller. (DN [40] = 0001)
		2	Output (Open collector)	
ntilation output	CN32	1	DC12V	Setting at shipment: Interlock of ON by indoor unit operation, with OFF by stop operation * The single operation setting by FAN button on the remote controller is performed on the remote controller (DN [31] = 0000 → 0001)
		2	Output (Open collector)	
HA	CN61	1	ON/OFF input	HA ON/OFF input (J01: YES/NO=Pulse (At shipment from factory) /Static input selection)
		2	0V	
		3	Remote controller prohibited input	Permission/Prohibition of remote controller operation stop is performed by input.
		4	Operation output (Open collector)	Operation ON (Answer back of HA)
		5	DC12V	
		6	Warning output (Open collector)	Warning output ON
Option output	CN60	1	DC12V	
		2	Defrost output (Open collector)	ON when outdoor unit is defrosted
		3	Thermostat ON output (Open collector)	ON when real thermostat is on. (Compressor ON)
		4	Cooling output (Open collector)	ON when operation mode is cooling system (COOL, DRY, Cooling/Heating automatic cooling)
		5	Heating output (Open collector)	ON when operation mode is heating system (HEAT, Cooling/Heating automatic heating)
		6	Fan output (Open collector)	ON when indoor fan is on. (When air cleaner is used) OFF while clean operation is performed.
Outside error input	CN80	1	DC12V	Generate the warning code "L30" (continuously for 1 minute) and stop the operation forcibly.
		2	NC	
		3	Outside error input	
AUTO up/down grille (*)	CN20	1	DC12V	The grille is controlled according to up/down operation from the remote controller. * Setting of automatic up/down grille provided is performed on the remote controller. (DN [30] = 0000 → 0001)
		2	Panel operation input	
		3	Panel up output (Open collector)	
		4	Panel down output (Open collector)	
		5	0V	
FILTER Option error / Humidifier setting (*)	CN70	1		Selection of option error input (Protective operation display of device attached to outside) or Humidifier setting input (Vaporizing + Drain pump ON) Humidifier is set at shipment from factory. * Setting of option error input is performed on the remote controller. (DN [2A] = 0002 → 0001)
		2	0V	
CHK Operation check	CN71	1		This check is used to check indoor operation. (Performs operation of indoor fan "H", Louver horizontal and Drain pump ON without communication with outdoor and remote controller)
		2	0V	
DISP Exhibition mode	CN72	1		Communication is available by indoor unit and remote controller only.
		2	0V	
EXCT Demand	CN73	1	Demand input	Indoor unit forced thermostat OFF operation
		2	0V	

* This option is not provided to oversea models.

8-4. Indoor Print Circuit Board
<MCC-1570>

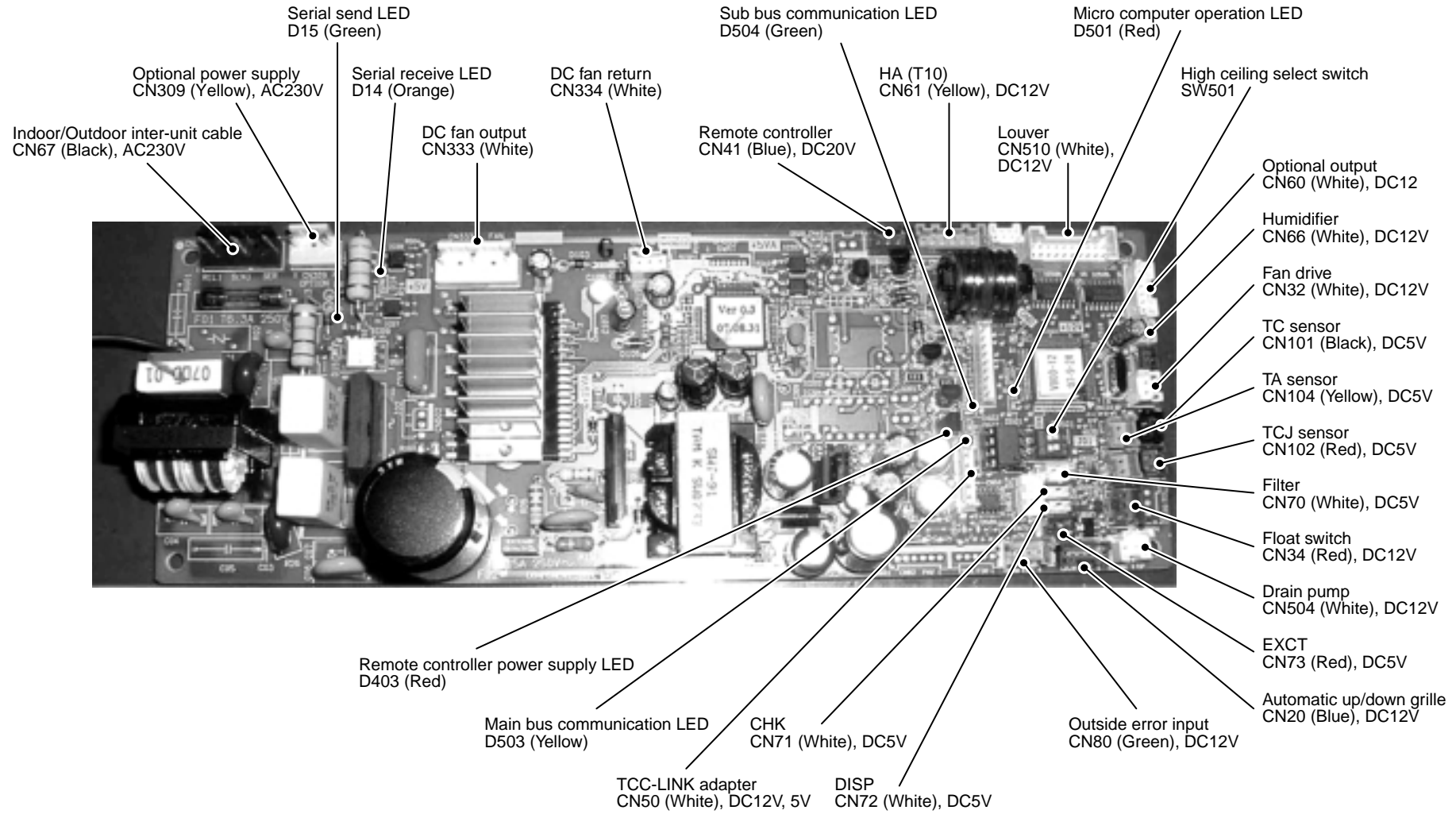

9. CIRCUIT CONFIGURATION AND CONTROL SPECIFICATIONS

9-1. Outdoor Controls

9-1-1. Print Circuit Board

<Viewed from parts of P.C board>

RAV-SP1104AT-E, RAV-SP1404AT-E
 RAV-SP1104ATZ-E, RAV-SP1404ATZ-E
 RAV-SP1104ATZG-E, RAV-SP1404ATZG-E

<MCC-1571>

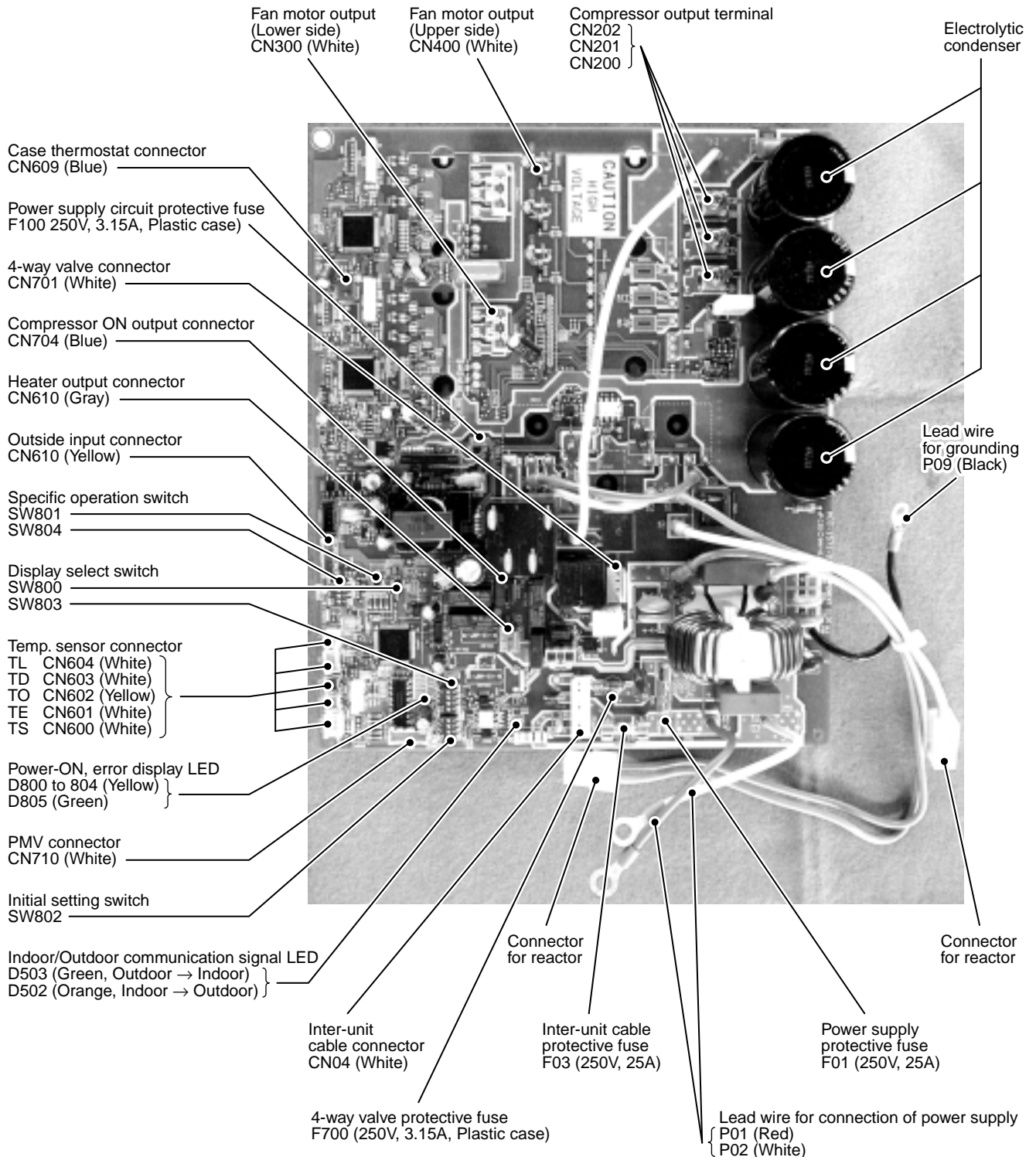

<Viewed from parts of P.C boards>
 RAV-SP404ATE, RAV-SP404ATZ-E, RAV-SP404ATZG-E
 RAV-SP454ATE, RAV-SP454ATZ-E, RAV-SP454ATZG-E
 <MCC-5009>

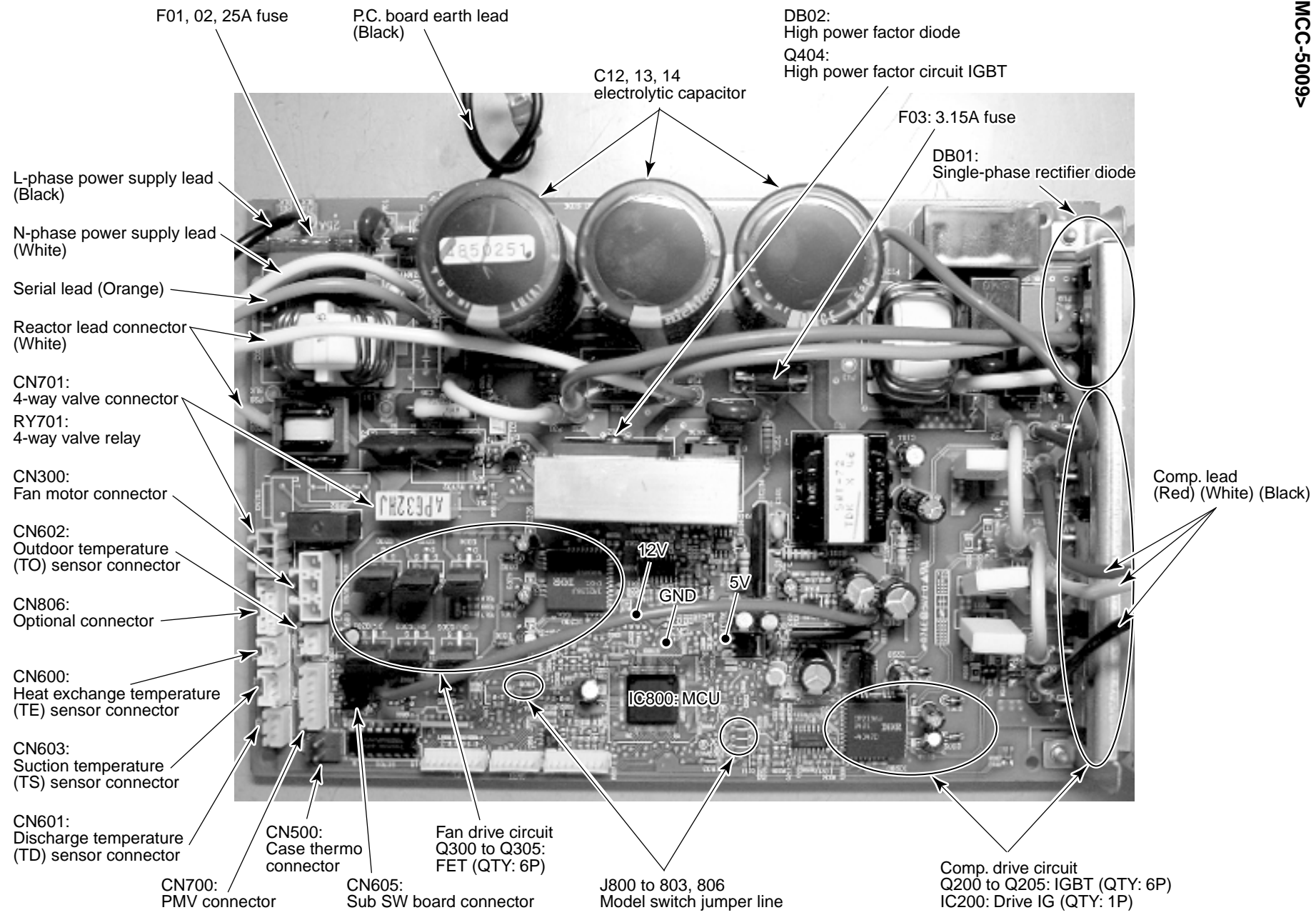

9-2. Outline of Main Controls

<In case of RAV-SP110 and SP140 models>

1. PMV (Pulse Motor Valve) control

- 1) PMV is controlled between 30 and 500 pulsed during operation.
- 2) In cooling operation, PMV is usually controlled with the temperature difference between TS sensor and TC sensor aiming 1 to 4K as the target value.
- 3) In heating operation, PMV is usually controlled with the temperature difference between TS sensor and TE sensor aiming -1 to 4K as the target value.
- 4) When the cycle excessively heated in both cooling and heating operation, PMV is controlled by TD sensor. The target value is usually 91°C in cooling operation and 96°C in heating operation.

REQUIREMENT

A sensor trouble may cause a liquid back-flow or abnormal overheat resulting in excessive shortening of the compressor life. In a case of trouble on the compressor, be sure to check there is no error in the resistance value or the refrigerating cycle of each sensor after repair and then start the operation.

2. Discharge temperature release control

- 1) When the discharge temperature did not fall or the discharge temperature rapidly went up by PMV control, this control lowers the operation frequency. It subdivides the frequency control up to 0.6Hz to stabilize the cycle.
- 2) When the discharge temperature detected an abnormal stop zone, the compressor stops and then restarts after 2 minutes 30 seconds.
The error counting is cleared when the operation continued for 10 minutes. If the error is detected by 4 times without clearing, the error is determined and restarting is not performed.
* The cause is considered as excessively little amount of refrigerant, PMV error or clogging of the cycle.
- 3) For displayed contents of error, confirm on the check code list.

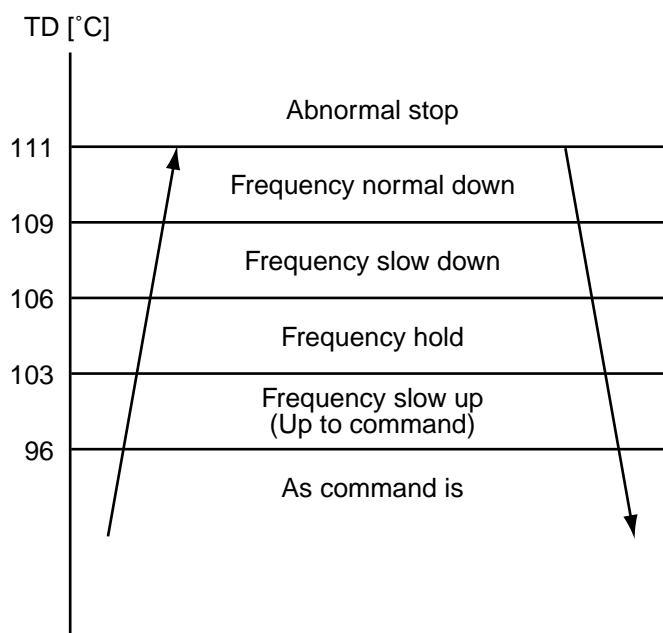

3. Outdoor fan control

Revolution frequency allocation of fan taps [rpm]

		W1	W2	W3	W4	W5	W6	W7	W8	W9	WA	WB	WC	WD	WE
SP110 SP140	Up	200	240	240	260	320	380	480	500	530	610	640	660	720	780
	Down	—	—	200	280	360	400	500	520	550	630	660	700	740	820

3-1) Cooling fan control

- The outdoor fan is controlled by TL sensor, TO sensor and the operation frequency.
The outdoor fan is controlled by every 1 tap of DC fan control (14 taps).
- Only for 60 seconds after the operation has started, the maximum fan tap corresponding to the zone in the following table is fixed and then the fan is controlled by temperature of TL sensor.

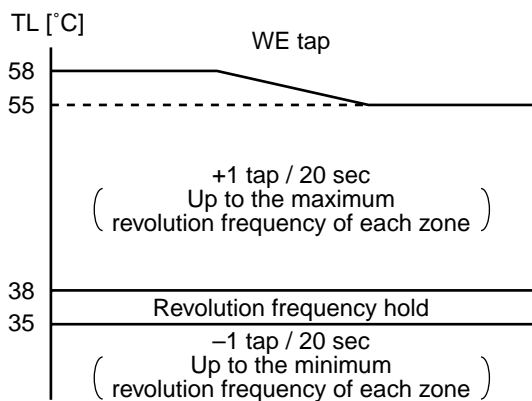

Temp. range	20 Hz or lower		20Hz to 45Hz		45Hz or higher	
	Min.	Max.	Min.	Max.	Min.	Max.
$38^{\circ}\text{C} \leq \text{TO}$	W6	WC	W8	WC	WA	WD
$29^{\circ}\text{C} \leq \text{TO} < 38^{\circ}\text{C}$	W5	WB	W7	WC*	W9	WC
$15^{\circ}\text{C} \leq \text{TO} < 29^{\circ}\text{C}$	W4	W8	W6	WA	W8	WC
$5^{\circ}\text{C} \leq \text{TO} < 15^{\circ}\text{C}$	W3	W6	W5	W8	W7	WA
$0^{\circ}\text{C} \leq \text{TO} < 5^{\circ}\text{C}$	W2	W4	W4	W6	W5	W8
$-4^{\circ}\text{C} \leq \text{TO} < 0^{\circ}\text{C}$	W2	W3	W3	W5	W4	W6
$\text{TO} < -4^{\circ}\text{C}$	W1	W2	W1	W4	W2	W6
TO error	W1	WC	W1	WC	W2	WD

* : WB for SP110

3-2) Heating fan control

- The outdoor fan is controlled by TE sensor, TO sensor and the operation frequency.
(Control from minimum W1 to maximum (according to the following table))
- For 3 minutes after the operation has started, the maximum fan tap corresponding to the zone in the following table is fixed and then the fan is controlled by temperature of TE sensor.

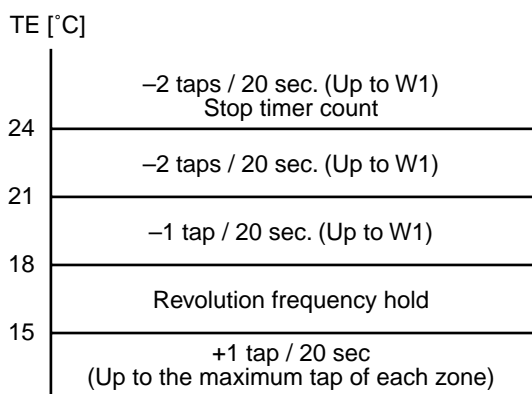

- When $\text{TE} \geq 24^{\circ}\text{C}$ continues for 5 minutes, the compressor stops.
It is the same status as the normal thermostat-OFF without error display.
The compressor restarts after approx. 2 minutes 30 seconds and this intermittent operation is not abnormal.
- In case that the status in item ③ generates frequently, stain on filter of the suction part of the indoor unit is considered.
Clean the filter and then restart the operation.

Object: SP140

Temp. range	20 Hz or lower	20Hz to 45Hz	45Hz or higher
	Max.	Max.	Max.
$10^{\circ}\text{C} \leq \text{TO}$	W7	W8	W9
$5^{\circ}\text{C} \leq \text{TO} < 10^{\circ}\text{C}$	W9	WA	WB
$-3^{\circ}\text{C} \leq \text{TO} < 5^{\circ}\text{C}$	WB	WB	WC
$-10^{\circ}\text{C} \leq \text{TO} < -3^{\circ}\text{C}$	WC	WC	WC
$\text{TO} < -10^{\circ}\text{C}$	WD	WD	WD
TO error	WD	WD	WD

Object: SP110

Temp. range	20 Hz or lower	20Hz to 45Hz	45Hz or higher
	Max.	Max.	Max.
$10^{\circ}\text{C} \leq \text{TO}$	W7	W8	W9
$5^{\circ}\text{C} \leq \text{TO} < 10^{\circ}\text{C}$	W9	WA	WA
$-3^{\circ}\text{C} \leq \text{TO} < 5^{\circ}\text{C}$	WA	WA	WB
$-10^{\circ}\text{C} \leq \text{TO} < -3^{\circ}\text{C}$	WB	WB	WB
$\text{TO} < -10^{\circ}\text{C}$	WD	WD	WD
TO error	WD	WD	WD

4. Coil heating control

- 1) This control function heats the compressor by turning on the stopped compressor instead of a case heater. It purposes to prevent stagnation of the refrigerant inside of the compressor.
- 2) As usual, turn on power of the compressor for the specified time before a test run after installation; otherwise a trouble of the compressor may be caused.
As same as a test run, it is recommended to turn on power of the compressor beforehand when starting operation after power of the compressor has been interrupted and left as it is for a long time.
- 3) A judgment for electricity is performed by TD and TO sensors.
If TO sensor is defective, a backup control is automatically performed by TE sensor.
For a case of defective TO sensor, judge it with outdoor LED display.
- 4) For every model, the power is turned off when TD is 30°C or more.

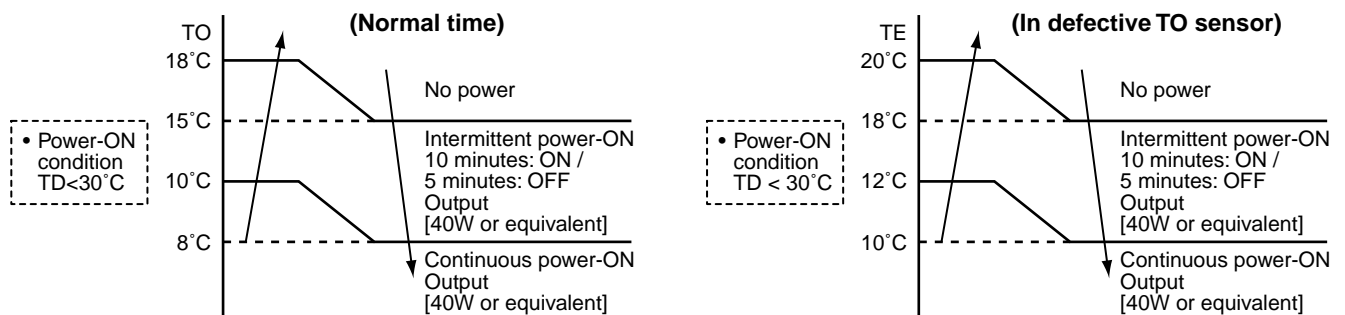

REQUIREMENT

While heating the coil, the power sound may be heard. However it is not a trouble.

5. Short intermittent operation preventive control

- 1) For 3 to 10 minutes after operation start, in some cases, the compressor does not stop to protect the compressor even if receiving the thermostat-OFF signal from indoor.
However it is not abnormal status. (The operation continuance differs according to the operation status.)
- 2) When the operation stops by the remote controller, the operation does not continue.

6. Current release control

No. of revolutions of the compressor is controlled by AC current value detected by T620 on the outdoor P.C. board so that the input current of the inverter does not exceed the specified value.

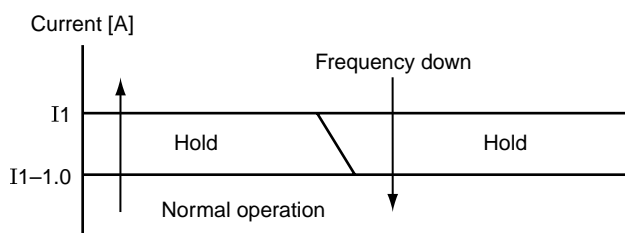

Objective model	SP110 / SP140	
	COOL	HEAT
I1 value [A]	20.0	20.0

7. Current release value shift control

- 1) This control purposes to prevent troubles of the electronic parts such as the compressor driving elements and the compressor during cooling operation.
- 2) The current release control value (I1) is selected from the following table according to TO sensor value.

Current release control value (I1)

[A]

Temperature range	SP110, SP140
$44^{\circ}\text{C} \leq T_o$	15.0
$39^{\circ}\text{C} \leq T_o < 44^{\circ}\text{C}$	17.7
$T_o < 39^{\circ}\text{C}$	20.0
TO error	15.0

8. Over-current protective control

- 1) When the over-current protective circuit detected an abnormal current, stop the compressor.
- 2) The compressor restarts after 2 minutes 30 seconds setting [1] as an error count.
- 3) When the error count [8] was found, determine an error and restart operation is not performed.
- 4) For the error display contents, confirm on the check code list.

9. High-pressure release control

- 1) The operation frequency is controlled to restrain abnormal rising of high pressure by TL sensor in cooling operation and TC sensor in heating operation.
- 2) When TL sensor in cooling operation or TC sensor in heating operation detects abnormal temperature of the stop zone, stop the compressor and the error count becomes +1.
- 3) When the compressor stopped with 2), the operation restarts from the point of the normal operation zone (e point or lower) where it returned after 2 minutes 30 seconds.
- 4) The error count when the compressor stopped with 2) is cleared after the operation continued for 10 minutes.

If the error count becomes [10] without clearing, the error is determined and reactivation is not performed.

- 5) For the error display contents, confirm on the check code list.

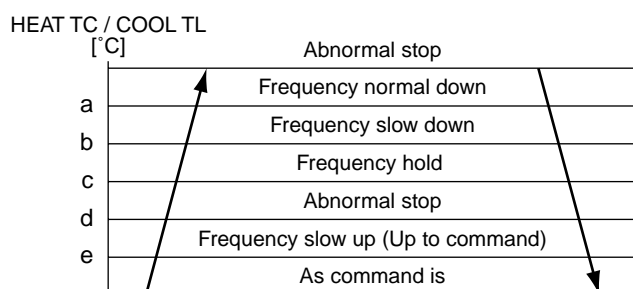

	HEAT	COOL
	TC	TL
a	62°C	63°C
b	57°C	62°C
c	55°C	60°C
d	53°C	58°C
e	49°C	54°C

10. Defrost control

- 1) In heating operation, defrost operation is performed when TE sensor satisfies any condition in A zone to D zone.
- 2) During defrosting operation, it finishes if TE sensor continued 12°C or higher for 3 seconds or continued $7^{\circ}\text{C} \leq \text{TE} < 12^{\circ}\text{C}$ for 1 minute.
The defrost operation also finishes when it continued for 10 minutes even if TE sensor temperature was 7°C or lower.
- 3) After defrost operation was reset, the compressor stopped for approx. 40 seconds and then the heating operation starts.

Start of heating operation

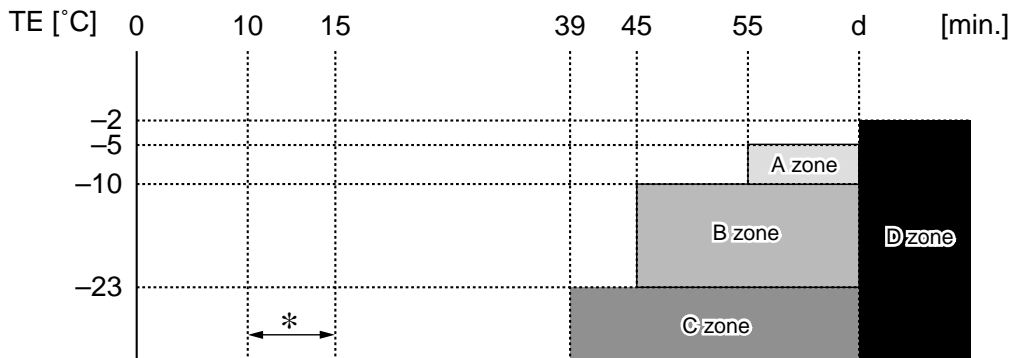

* The minimum TE value and To value between 10 and 15 minutes after heating operation has started are stored in memory as TE0 and To0, respectively.

	In normal To	In abnormal To
A zone	When status $(\text{TE0} - \text{TE}) - (\text{To0} - \text{To}) \geq 3^{\circ}\text{C}$ continued for 20 seconds	When status $(\text{TE0} - \text{TE}) \geq 3^{\circ}\text{C}$ continued for 20 seconds
B zone	When status $(\text{TE0} - \text{TE}) - (\text{To0} - \text{To}) \geq 2^{\circ}\text{C}$ continued for 20 seconds	When status $(\text{TE0} - \text{TE}) \geq 2^{\circ}\text{C}$ continued for 20 seconds
C zone	When status $(\text{TE} \leq -23^{\circ}\text{C})$ continued for 20 seconds	
D zone	When compressor operation status of $\text{TE} < -2^{\circ}\text{C}$ is calculated by d portion	

- 4) The time of above d can be changed by exchanging jumper [J805] and [J806] of the outdoor control P.C. board.
(Setting at shipment: 150 minutes)

J805	J806	d
○	○	150 minutes Setting at shipment
○	✕	90 minutes
✕	○	60 minutes
✕	✕	30 minutes

○ : Short circuit, ✕ : Open

<In case of RAV-SP40 and SP45 models>

1. Pulse Motor Valve (PMV) control

- 1) For PMV with 50 to 500 pulses during operation, respectively.
- 2) In cooling operation, PMV is controlled with the temperature difference between TS sensor and TC sensor.
- 3) In heating operation, PMV is controlled with the temperature difference between TS sensor and TE sensor.
- 4) For the temperature difference in items 2) and 3), 1 to 5K is aimed as the target in both cooling and heating operations.
- 5) When the cycle excessively rose in both cooling and heating operations, PMV is controlled by TD sensor.
The aimed value is usually 106°C in both cooling and heating operations.

REQUIREMENT

A sensor trouble may cause a liquid back-flow or abnormal overheat resulting in excessive shortening of the compressor life. In a case of trouble on the compressor, be sure to check there is no error in the resistance value an the refrigerating cycle of each sensor after repair and then start the operation.

2. Discharge temperature release control

- 1) This function controls the operation frequency, that is, lowers the operation frequency when the discharge temperature has not lower or the discharge temperature has rapidly risen during PMV control.
It subdivides the frequency control up to a unit of 0.6 Hz to stabilize the cycle.
- 2) When the discharge temperature is detected in an abnormal stop zone, the unit stops the compressor and restarts after 2 minutes 30 seconds.
The error counter is cleared when it has continued the operation for 6 minutes.
If the abnormal stop zone has been detected by 8 times without clearing of counter, an error "P03" is displayed.
* The cause is considered as excessively little amount of refrigerant, defective PMV, or clogging of cycle.

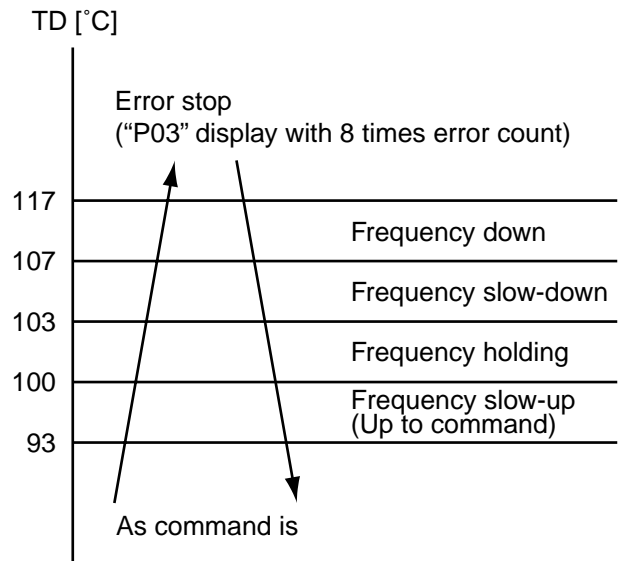

3. Current release control

The output frequency and the output voltage are controlled by AC current value detected by T02 on the outdoor P.C. board so that input current of the inverter does not exceed the specified value.

Objective model	SP40, SP45	
	COOL	HEAT
I1 value [A]	10.13	10.50

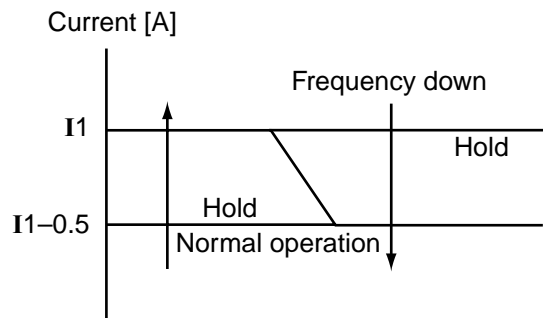

4. Outdoor fan control

Allocations of fan tap revolutions [rpm]

	W1	W2	W3	W4	W5	W6	W7	W8	W9	WA	WB	WC	WD	WE	WF
SP40, SP45	200	300	350	410	480	500	560	640	670	700	750	800	800	840	840

1) Cooling fan control

- ① The outdoor fan is controlled by TE, TD, and TO sensors and also revolution frequency of the operation.
The outdoor fan is controlled by every 1 tap of DC fan control (15 taps).
- ② Only during 60 seconds after the operation has started, the fan is fixed with the maximum fan tap which corresponds to the zone in the following table.
After then the fan is controlled by TE sensor temperature.
- ③ Considering a case that TE sensor has come out of the holder, the fan is controlled so that revolution frequency of the fan increases regardless of TE if temperature of TD sensor has risen.

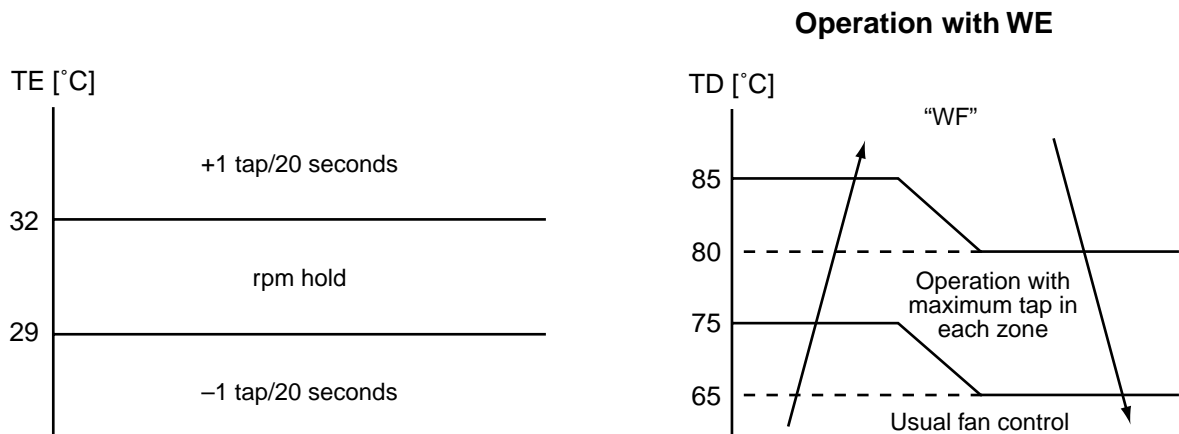

Temp. range	f < 34.1Hz		34.1Hz ≤ f < 58.6Hz		58.6Hz ≤ f	
	Min.	Max.	Min.	Max.	Min.	Max.
38°C ≤ TO	W6	WB	W8	WD	WA	WF
32 ≤ TO < 38°C	W5	WA	W7	WC	W9	WF
15 ≤ TO < 32°C	W3	W7	W5	W9	W7	WB
5 ≤ TO < 15°C	W2	W5	W4	W7	W6	W9
1 ≤ TO < 5°C	W1	W3	W3	W5	W4	W7
-5 ≤ TO < 1°C	W1	W2	W2	W4	W3	W5
TO < -5°C	OFF		OFF	W3	W1	W4
TO error	W1	WF	W1	WF	W1	WF

2) Heating fan control

① The outdoor fan is controlled by TE sensor, TO sensor and the operation frequency.
(From Min. W1 to Max. are controlled according to the following table.)

② During 3 minutes after start-up, the fan is fixed with the maximum fan tap corresponding to zone in the following table.

After then the fan is controlled by temperature of TE sensor.

③ If status, $TE \geq 24^{\circ}\text{C}$ continues for 5 minutes, the operation stops.

This status is same to the usual Thermo-OFF which has no alarm display, and the fan restarts after 2 minutes and 30 seconds.

This intermittent operation is not abnormal.

④ When the above status ② occurs frequently, it is considered that the filter of suction part of the indoor unit is stain.

Clean the filter and then restart the operation.

TE [$^{\circ}\text{C}$]	
24	-2 tap/20 seconds STOP timer count
21	-2 tap/20 seconds
18	-1 tap/20 seconds
15	rpm hold
	+1 tap/20 seconds

	Temp. range	$f < 38.9\text{Hz}$	$38.9\text{Hz} \leq f < 67.6\text{Hz}$	$67.6\text{Hz} \leq f$
Maximum	$10^{\circ}\text{C} \leq \text{TO}$	W7	W8	W9
	$5 \leq \text{TO} < 10^{\circ}\text{C}$	WA	WB	WD
	$-5 \leq \text{TO} < 5^{\circ}\text{C}$	WE	WF	WF
	$\text{TO} < -5^{\circ}\text{C}$	WE	WF	WF
	TO error	WE	WF	WF

5. Coil heating control

1) This control function heats the compressor by turning on the stopped compressor instead of a case heater.
It purposes to prevent slackness of the refrigerant inside of the compressor.

2) As usual, turn on power of the compressor for the specified time before a test run after installation, otherwise a trouble of the compressor may be caused.

As same as a test run, it is recommended to turn on power of the compressor beforehand when starting operation after power of the compressor has been interrupted for a long time.

3) Coil heating is controlled by TD and TE sensor.

4) The power is turned off when TD is 30°C or more.

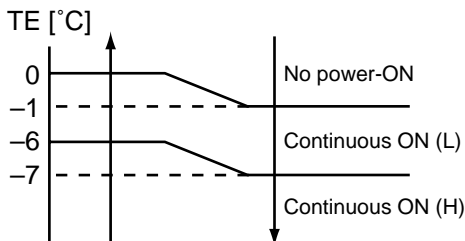

SP40, SP45	
L	10W and equivalent
H	30W and equivalent

6. Defrost control

- ① In heating operation, defrost operation is performed when TE sensor temperature satisfies any condition in A zone to C zone.
- ② The defrost operation is immediately finished if TE sensor temperature has become 12°C or more, or it also is finished when condition of $5^{\circ}\text{C} < \text{TE} < 12^{\circ}\text{C}$ has continued for 80 seconds.
The defrost operation is also finished when defrost operation has continued for 15 minutes even if TE sensor temperature has become 5°C or lower.
- ③ After defrost operation has finished, the compressor and the outdoor fan start heating operation after stopped for approx. 40 seconds.

Start of heating operation

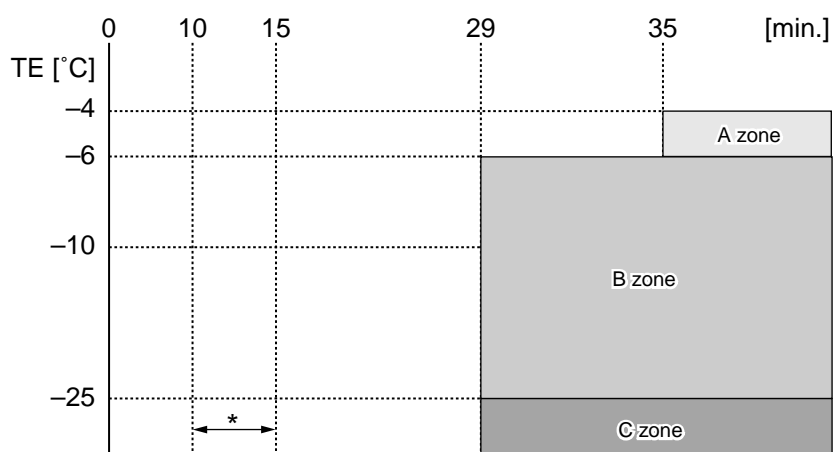

* The minimum TE value between 10 and 15 minutes after heating operation has started is stored in memory as TE0.

A zone	Defrost operation is performed in this zone when $\text{TE0} - \text{TE} > 2.5$ continued for 20 seconds.
B zone	Defrost operation is performed in this zone when $\text{TE0} - \text{TE} > 3$ continued for 20 seconds.
C zone	Defrost operation is performed when this zone continued for 20 seconds.

10. TROUBLESHOOTING

10-1. Summary of Troubleshooting

<Wired remote controller type>

1. Before troubleshooting

- 1) Required tools/instruments
 - ⊕ and ⊖ screwdrivers, spanners, radio cutting pliers, nippers, push pins for reset switch
 - Tester, thermometer, pressure gauge, etc.
- 2) Confirmation points before check
 - a) The following operations are normal.
 1. Compressor does not operate.
 - Is not 3-minutes delay (3 minutes after compressor OFF)?
 - Is not the outdoor unit in standby status though the remote controller reached the setup temperature?
 - Does not timer operate during fan operation?
 - Is not an overflow error detected on the indoor unit?
 - Is not outside high-temperature operation controlled in heating operation?
 2. Indoor fan does not rotate.
 - Does not cool air discharge preventive control work in heating operation?
 3. Outdoor fan does not rotate or air volume changes.
 - Does not high-temperature release operation control work in heating operation?
 - Does not outside low-temperature operation control work in cooling operation?
 - Is not defrost operation performed?
 4. ON/OFF operation cannot be performed from remote controller.
 - Is not the control operation performed from outside/remote side?
 - Is not automatic address being set up?
(When the power is turned on at the first time or when indoor unit address setting is changed, the operation cannot be performed for maximum approx. 5 minutes after power-ON.)
 - Is not being carried out a test run by operation of the outdoor controller?
 - b) Did you return the cabling to the initial positions?
 - c) Are connecting cables of indoor unit and remote controller correct?

2. Troubleshooting procedure

When a trouble occurred, check the parts along with the following procedure.



NOTE :

For cause of a trouble, power conditions or malfunction/erroneous diagnosis of microcomputer due to outer noise is considered except the items to be checked. If there is any noise source, change the cables of the remote controller to shield cables.

<Wireless remote controller type>

1. Before troubleshooting

- 1) Required tools/instruments
 - ⊕ and ⊖ screwdrivers, spanners, radio cutting pliers, nippers, etc.
 - Tester, thermometer, pressure gauge, etc.
- 2) Confirmation points before check
 - a) The following operations are normal.
 1. Compressor does not operate.
 - Is not 3-minutes delay (3 minutes after compressor OFF)?
 - Is not the outdoor unit in standby status though the remote controller reached the setup temperature?
 - Does not timer operate during fan operation?
 - Is not an overflow error detected on the indoor unit?
 - Is not outside high-temperature operation controlled in heating operation?
 2. Indoor fan does not rotate.
 - Does not cool air discharge preventive control work in heating operation?
- 3) Outdoor fan does not rotate or air volume changes.
 - Does not high-temperature release operation control work in heating operation?
 - Does not outside low-temperature operation control work in cooling operation?
 - Is not defrost operation performed?
- 4) ON/OFF operation cannot be performed from remote controller.
 - Is not forced operation performed?
 - Is not the control operation performed from outside/remote side?
 - Is not automatic address being set up?
 - Is not being carried out a test run by operation of the outdoor controller?
 - a) Did you return the cabling to the initial positions?
 - b) Are connecting cables between indoor unit and receiving unit correct?

2. Troubleshooting procedure

(When the power is turned on at the first time or when indoor unit address setting is changed, the operation cannot be performed for maximum approx. 5 minutes after power-ON.)

When a trouble occurred, check the parts along with the following procedure.

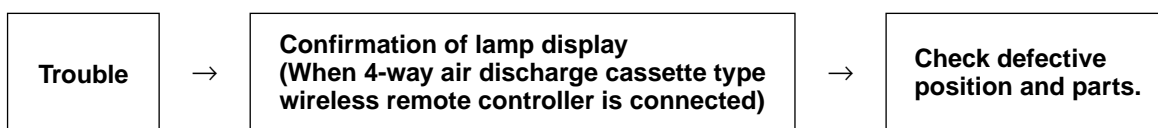

1) Outline of judgment

The primary judgment to check where a trouble occurred in indoor unit or outdoor unit is performed with the following method.

Method to judge the erroneous position by flashing indication on the display part of indoor unit (sensors of the receiving unit)

The indoor unit monitors operating status of the air conditioner, and the blocked contents of self-diagnosis are displayed restricted to the following cases if a protective circuit works.

10-2. Troubleshooting







10-2-1. Outline of judgment

The primary judgment to check whether a trouble occurred in the indoor unit or outdoor unit is carried out with the following method.

Method to judge the erroneous position by flashing indication on the display part of the indoor unit (sensors of the receiving part)

The indoor unit monitors the operating status of the air conditioner, and the blocked contents of self-diagnosis are displayed restricted to the following cases if a protective circuit works.

● : Go off, ○ : Go on,  : Flash (0.5 sec.)

Lamp indication	Check code	Cause of trouble occurrence
Operation Timer Ready ● ● ● No indication at all	—	Power supply OFF or miswiring between receiving unit and indoor unit
Operation Timer Ready  ● ● Flash	E01	Receiving error } Receiving unit } Sending error } Miswiring or wire connection error Communication stop } between receiving unit and indoor unit
	E02	
	E03	
	E08	Duplicated indoor unit No. } Duplicated master units of remote controller } Setup error
	E09	
	E10	Communication error between CPUs on indoor unit P.C. board
E18	Wire connection error between indoor units, Indoor power OFF (Communication stop between indoor master and follower or between main and sub indoor twin)	
Operation Timer Ready ● ●  Flash	E04	Miswiring between indoor unit and outdoor unit or connection error (Communication stop between indoor and outdoor units)
Operation Timer Ready ●   Alternate flash	P10	Overflow was detected. } Indoor DC fan error } Protective device of indoor unit worked.
	P12	
Operation Timer Ready  ●  Alternate flash	P03	Outdoor unit discharge temp. error } Outdoor high pressure system error } Protective device of outdoor unit worked. *1
	P04	
	P05	Negative phase detection error } Heat sink overheat error } Outdoor unit error Gas leak detection error }
	P07	
	P15	
	P19	4-way valve system error (Indoor or outdoor unit judged.)
	P20	Outdoor unit high pressure protection
	P22	Outdoor unit: Outdoor unit error } Outdoor unit: Inverter Idc operation } Protective device of outdoor unit worked. *1 Outdoor unit: Position detection error }
	P26	
	P29	
P31	Stopped because of error of other indoor unit in a group (Check codes of E03/L03/L07/L08)	

*1: These are representative examples and the check code differs according to the outdoor unit to be combined.

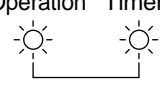
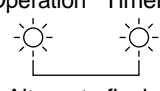
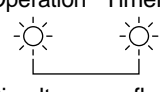
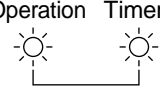
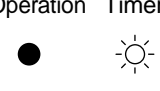
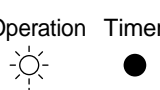
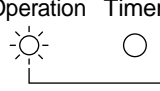
Lamp indication	Check code	Cause of trouble occurrence
Operation Timer Ready  Alternate flash	F01	Heat exchanger sensor (TCJ) error Heat exchanger sensor (TC) error Heat exchanger sensor (TA) error } Indoor unit sensor error
	F02	
	P10	
Operation Timer Ready  Alternate flash	F04	Discharge temp. sensor (TD) error Temp. sensor (TE) error Temp. sensor (TL) error Temp. sensor (TO) error Temp. sensor (TS) error Temp. sensor (TH) error Temp. Sensor miswiring (TE, TS) } Sensor error of outdoor unit *1
	F06	
	F07	
	F08	
	F12	
	F13	
	F15	
Operation Timer Ready  Simultaneous flash	F29	Indoor EEPROM error
Operation Timer Ready  Simultaneous flash	F31	Outdoor EEPROM error
Operation Timer Ready  Flash	H01	Compressor break down Compressor lock Current detection circuit error Case thermostat worked. Outdoor unit low pressure system error } Outdoor compressor system error *1
	H02	
	H03	
	H04	
	H06	
Operation Timer Ready  Simultaneous flash	L03	Duplicated master indoor units There is indoor unit of group connection in individual indoor unit. Unsetting of group address Missed setting (Unset indoor capacity) } → AUTO address * If group construction and address are not normal when power supply turned on, automatically goes to address setup mode.
	L07	
	L08	
	L09	
Operation Timer Ready  Simultaneous flash	L10	Unset model type (Service board) Duplicated indoor central addresses Outdoor unit and other error Outside interlock error Negative phase error } Others
	L20	
	L29	
	L30	
	L31	

*1: These are representative examples and the check code differs according to the outdoor unit to be combined.

10-2-2. Others (Other than Check Code)

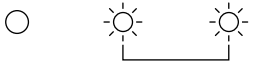
Lamp indication	Check code	Cause of trouble occurrence
Operation Timer Ready  Simultaneous flash	—	During test run
Operation Timer Ready  Alternate flash	—	Disagreement of cool/heat (Automatic cool/heat setting to automatic cool/heat prohibited model, or setting of heating to cooling-only model)

10-2-3. Check Code List (Indoor)

○ : Go on, ◎ : Flash, ● : Go off ALT (Alternate): Alternate flashing when there are two flashing LED SIM (Simultaneous): Simultaneous flashing when there are two flashing LED

(Indoor unit detected)

Check code indication	Sensor lamp indication				Representative defective position	Explanation of error contents	Air conditioner operation	
	Block indication						Automatic reset	Operation continuation
TCC-LINK central & Wired remote controller	Operation	Timer	Ready	Flash				
E03	◎	●	●		Regular communication error between indoor and remote controller	No communication from remote controller and network adapter (Also no communication from central control system)	○	×
E04	●	●	◎		Indoor/Outdoor serial error	There is error on serial communication between indoor and outdoor units	○	×
E08	◎	●	●		Duplicated indoor addresses	Same address as yours was detected.	○	×
E10	◎	●	●		Communication error between indoor MCU	MCU communication error between main motor and micro computer	○	×
E18	◎	●	●		Regular communication error between indoor master and follower units	Regular communication between indoor master and follower units is impossible, Communication between twin master (main) and follower (sub) units is impossible.	○	×
F01	◎	◎	●	ALT	Indoor unit, Heat exchanger (TCJ) error	Open/short was detected on heat exchanger (TCJ).	○	×
F02	◎	◎	●	ALT	Indoor unit, Heat exchanger (TC) error	Open/short was detected on heat exchanger (TC).	○	×
F10	◎	◎	●	ALT	Indoor unit, Room temp. sensor (TA) error	Open/short was detected on room temp. sensor (TA).	○	×
F29	◎	◎	●	SIM	Indoor unit, other indoor P.C. board error	EEPROM error (Other error may be detected. If no error, automatic address is repeated.	×	×
L03	◎	●	◎	SIM	Duplicated setting of indoor group master unit	There are multiple master units in a group.	×	×
L07	◎	●	◎	SIM	There is group cable in individual indoor unit.	When even one group connection indoor unit exists in individual indoor unit.	×	×
L08	◎	●	◎	SIM	Unset indoor group address	Indoor group address is unset.	×	×
L09	◎	●	◎	SIM	Unset indoor capacity	Capacity of indoor unit is unset.	×	×
L20	◎	○	◎	SIM	Duplicated central control system address	Duplicated setting of central control system address	○	×
L30	◎	○	◎	SIM	Outside error input to indoor unit (Interlock)	Abnormal stop by outside error (CN80) input	×	×
P01	●	◎	◎	ALT	Indoor unit, AC fan error	An error of indoor AC fan was detected. (Fan motor thermal relay worked.)	×	×
P10	●	◎	◎	ALT	Indoor unit, overflow detection	Float switch worked.	×	×
P12	●	◎	◎	ALT	Indoor unit, DC fan error	Indoor DC fan error (Over-current/Lock, etc.) was detected.	×	×
P19	◎	●	◎	ALT	4-way valve system error	In heating operation, an error was detected by temp. down of indoor heat exchanger sensor.	○	×
P31	◎	●	◎	ALT	Other indoor unit error	Follower unit in group cannot operate by warning from [E03/L03/L07/L08] of master unit.	○	×

◇ When this warning was detected before group construction/address check finish at power supply was turned on, the mode shifts automatically to AUTO address setup mode.

(Remote controller detected)

Check code indication	Sensor lamp indication				Representative defective position	Explanation of error contents	Air conditioner operation	
	Block indication						Automatic reset	Operation continuation
Wired remote controller	Operation	Timer	Ready	Flash				
E01	◎	●	●		No master remote controller, Remote controller communication (Receive) error	Signal cannot be received from indoor unit. Master remote controller was not set. (including 2 remote controllers)	—	—
E02	◎	●	●		Remote controller communication (Send) error	Signal cannot be sent to indoor unit.	—	—
E09	◎	●	●		Duplicated master remote controller	In 2-remote controller control, both were set as master. (Indoor master unit stops warning and follower unit continues operation.)	×	△

(Central control devices detected)

Check code indication	Sensor lamp indication				Representative defective position	Explanation of error contents	Air conditioner operation	
	Block indication						Automatic reset	Operation continuation
TCC-LINK central	Operation	Timer	Ready	Flash				
C05	Is not displayed. (Common use of remote controller, etc.)				Central control system communication (send) error	Signal sending operation of central control system is impossible. There are multiple same central devices. (AI-NET)	—	—
C06					Central control system communication (receive) error	Signal receiving operation of central control system is impossible.	—	—
C12	—				General-purpose device control interface batched warning	An error on device connected to general-purpose device control interface of exclusive to TCC-LINK/AI-NET	—	—
P30	By warning unit (Above-mentioned)				Group follower unit is defective.	Group follower unit is defective. (For remote controller, above-mentioned [***] details are displayed with unit No.	—	—

NOTE: Even for the same contents of error such as communication error, the display of check code may differ according to detection device. When remote controller or central controller detects an error, it is not necessarily related to operation of the air conditioner. In this list, the check codes that outdoor unit detects are not described.

Check Code List (Outdoor)

○ : Go on, ◎ : Flash, ● : Go off
 ALT (Alternate): Alternate flashing when there are two flashing LED SIM (Simultaneous): Simultaneous flashing when there are two flashing LED

Remote controller indication	Sensor lamp part				Representative defective position	Detection	Explanation of error contents	Automatic reset	Operation continuation
	Block indication								
	Operation	Timer	Ready	Flash					
F04	◎	◎	○	ALT	Outdoor unit Discharge temp. sensor (TD) error	Outdoor	Open/Short of discharge temp. sensor was detected.	×	×
F06	◎	◎	○	ALT	Outdoor unit Temp. sensor (TE, TS, TL) error	Outdoor	Open/Short of heat exchanger temp. sensor was detected. Miswiring between TE sensor and TS sensor	×	×
F08	◎	◎	○	ALT	Outdoor unit Outside temp. sensor (TO) error	Outdoor	Open/Short of outside temp. sensor was detected.	○	○
F07	◎	◎	○	ALT	Outdoor unit Temp. sensor (TL) error	Outdoor	Open/Short of heat exchanger temp. sensor was detected.	×	×
F12	◎	◎	○	ALT	Outdoor unit Temp. sensor (TS) error	Outdoor	Open/Short of suction temp. sensor was detected.	×	×
F13	◎	◎	○	ALT	Outdoor unit Temp. sensor (TH) error	Outdoor	Open/Short of heat sink temp. sensor (Board installed) was detected.	×	×
F15	◎	◎	○	ALT	Outdoor unit Misconnection of temp. sensor (TE, TS)	Outdoor	Misconnection of outdoor heat exchanger temp. sensor and suction temp. sensor was detected.	×	×
F31	◎	◎	○	SIM	Outdoor unit EEPROM error	Outdoor	Outdoor P.C. board part (EEPROM) error was detected.	×	×
H01	●	◎	●		Outdoor unit Compressor break down	Outdoor	When reached min-Hz by current release control, short-circuited current (Idc) after DC excitation was detected.	×	×
H02	●	◎	●		Outdoor unit Compressor lock	Outdoor	Compressor lock was detected.	×	×
H03	●	◎	●		Outdoor unit Current detection circuit error	Outdoor	Current detection circuit error	×	×
H04	●	◎	●		Outdoor unit Case thermostat operation	Outdoor	Case thermostat operation was detected.	×	×
L10	◎	○	◎	SIM	Outdoor unit Setting error of service P.C. board type	Outdoor	When outdoor service P.C. board was used, model type select jumper setting was inappropriate.	×	×
L29	◎	○	◎	SIM	Outdoor unit Other outdoor unit error	Outdoor	1) Defective parts on outdoor P.C. board (MCU communication, EEPROM, TH sensor error) 2) When outdoor service P.C. board was used, model type selection was inappropriate. 3) Other error (Heat sink abnormal overheat, gas leak, 4-way valve inverse error) was detected.	×	×
P03	◎	●	◎	ALT	Outdoor unit Discharge temp. error	Outdoor	Error was detected by discharge temp. release control.	×	×
P04	◎	●	◎	ALT	Outdoor unit High pressure system error, Power supply voltage error	Outdoor	When case thermostat worked, error was detected by high release control from indoor/outdoor heat exchanger temp. sensor. Power supply voltage error	×	×
P05	◎	●	◎	ALT	Power supply error	Outdoor	Power supply voltage error	×	×
P07	◎	●	◎	ALT	Outdoor unit Heat sink overheat	Outdoor	Abnormal overheat was detected by outdoor heat sink temp. sensor.	×	×
P15	◎	●	◎	ALT	Gas leak detection	Outdoor	Abnormal overheat of discharge temp. or suction temp. was detected.	×	×
P20	◎	●	◎	ALT	Outdoor unit High pressure system error	Outdoor	Error was detected by high release control from indoor/outdoor heat exchanger temp. sensor.	×	×
P22	◎	●	◎	ALT	Outdoor unit Outdoor fan error	Outdoor	Error (Over-current, lock, etc.) was detected on outdoor fan drive circuit.	×	×
P26	◎	●	◎	ALT	Outdoor unit Inverter Idc operation	Outdoor	Short-circuited protective operation of compressor drive circuit element (G-Tr /IGBT) worked.	×	×
P29	◎	●	◎	ALT	Outdoor unit Position detection error	Outdoor	Position detection error of compressor motor was detected.	×	×
E01	◎	●	●		No remote controller master unit Remote controller communication error	Remote controller	Signal was not received from indoor unit. Main remote controller was not set. (including 2 remote controllers)	—	—
E02	◎	●	●		Remote controller send error	Remote controller	Signal cannot be sent to indoor unit.	—	—
E03	◎	●	●		Regular communication error between indoor and remote controller	Indoor	No communication from remote controller and network adapter	○	×
E04	●	●	◎		Indoor/Outdoor serial error	Indoor	Serial communication error between indoor and outdoor	○	×
E08	◎	●	●		Duplicated indoor addresses	Indoor	Same address as yours was detected.	○	
E09	◎	●	●		Duplicated main remote controllers	Remote controller	In 2-remote controller control, both were set as master. (Indoor master unit stops warning and follower unit continues operation.)	×	×
E10	◎	●	●		Communication error between CPU	Indoor	MCU communication error between main motor and micro computer	○	△
E18	◎	●	●		Regular communication error between master and follower indoor units	Indoor	Regular communication was impossible between master and follower indoor units. Communication between twin master (Main unit) and follower (sub unit) was impossible.	○	×
L03	◎	●	◎	SIM	Duplicated indoor master units	Indoor	There are multiple master units in a group.	×	×
L07	◎	●	◎	SIM	There is group cable in individual indoor unit.	Indoor	When even one group connection indoor unit exists in individual indoor unit	×	×
L08	◎	●	◎	SIM	Unset indoor group address	Indoor	Indoor address group was unset.	×	×
L09	◎	●	◎	SIM	Unset indoor capacity	Indoor	Capacity of indoor unit was unset.	×	×
L30	◎	○	◎	SIM	Outside error input to indoor unit (Interlock)	Indoor	Abnormal stop by CN80 outside error input	×	×
P19	◎	●	◎	ALT	4-way valve inverse error	Indoor Outdoor	In heating operation, error was detected by temp. down of indoor heat exchanger or temp. up of TE, TS.	○	×

◇ When this warning was detected before group construction/address check finish at power supply was turned on, the mode shifts automatically to AUTO address setup mode.

<In case of SP110, SP140>

○ : Go on, ◎ : Flash, ● : Go off
 ALT (Alternate): Alternate flashing when there are two flashing LED SIM (Simultaneous): Simultaneous flashing when there are two flashing LED

Remote controller indication	Sensor lamp part				Representative defective position	Detection	Explanation of error contents	Automatic reset	Operation continuation	
	Block indication									
	Operation	Timer	Ready	Flash						
F01	◎	◎	●	ALT	Indoor unit Heat exchanger sensor (TCJ) error	Indoor	Open/Short of heat exchanger (TCJ) was detected.	○	×	
F02	◎	◎	●	ALT	Indoor unit Heat exchanger sensor (TC) error	Indoor	Open/Short of heat exchanger (TC) was detected.	○	×	
F10	◎	◎	●	ALT	Indoor unit Room temp. sensor (TA) error	Indoor	Open/Short of room temp. (TA) was detected.	○	×	
F29	◎	◎	●	SIM	Indoor unit Other indoor P.C. board error	Indoor	EEPROM error (Other error may be detected. If no error, automatic address is repeated.)	×	×	
P01	●	◎	◎	ALT	Indoor unit Indoor fan error	Indoor	Indoor AC fan error was detected. (Fan thermal relay worked.)	×	×	
P10	●	◎	◎	ALT	Indoor unit Overflow detection	Indoor	Float switch worked.	×	×	
P12	●	◎	◎	ALT	Indoor unit Indoor fan error	Indoor	Indoor fan error (Over-current / Lock, etc.) was detected.	×	×	
P31	◎	●	◎	ALT	Other indoor unit error	Indoor	Other indoor under condition of warning in group. E03/L07/L03/L08 warning	○	×	
—	By unit with warning No.				ALT	Error in indoor group	Network adapter	Sub remote controller error in a group (Details of remote controller are displayed with unit No. Only central control side is displayed.)	—	—
—	—					LAN system communication error	Network adapter/Center	Communication error of central control system signal * Is not displayed on the remote controller	○	○
L20	◎	○	◎	SIM	LAN system communication error	Network adapter/Center	Duplicated indoor address of central control system communication	○	×	
—	—					There are multiple communication adapters.	Network adapter	There are multiple communication adapters on remote controller communication line.	○	○

Error mode detected by indoor unit

Operation of diagnostic function				Judgment and measures
Check code	Cause of operation	Status of air conditioner	Condition	
E03	No communication from remote controller (including wireless) and communication adapter	Stop (Automatic reset)	Displayed when error is detected	1. Check cables of remote controller and communication adapters. • Remote controller LCD display OFF (Disconnection) • Central remote controller [97] check code
E04	The serial signal is not output from outdoor unit to indoor unit. • Miswiring of inter-unit wire • Defective serial sending circuit on outdoor P.C. board • Defective serial receiving circuit on indoor P.C. board	Stop (Automatic reset)	Displayed when error is detected	1. Outdoor unit does not completely operate. • Inter-unit wire check, correction of miswiring • Check outdoor P.C. board. Correct wiring of P.C. board. 2. When outdoor unit normally operates Check P.C. board (Indoor receiving / Outdoor sending).
E08	Duplicated indoor unit address	Stop	Displayed when error is detected	1. Check whether remote controller connection (Group/Individual) was changed or not after power supply turned on (Finish of group construction/Address check). * If group construction and address are not normal when the power has been turned on, the mode automatically shifts to address setup mode. (Resetting of address)
L03	Duplicated indoor master unit			
L07	There is group wire in individual indoor unit.			
L08	Unset indoor group address			
L09	Unset indoor capacity	Stop	Displayed when error is detected	1. Set indoor capacity (DN=11)
L30	Abnormal input of outside interlock	Stop	Displayed when error is detected	1. Check outside devices. 2. Check indoor P.C. board.
P10	Float switch operation • Float circuit, Disconnection, Coming-off, Float switch contact error	Stop	Displayed when error is detected	1. Trouble of drain pump 2. Clogging of drain pump 3. Check float switch. 4. Check indoor P.C. board.
P12	Indoor DC fan error	Stop	Displayed when error is detected	1. Position detection error 2. Over-current protective circuit of indoor fan driving unit operated. 3. Indoor fan locked. 4. Check indoor P.C. board.
P19	4-way valve system error • After heating operation has started, indoor heat exchangers temp. is down.	Stop (Automatic reset)	Displayed when error is detected	1. Check 4-way valve. 2. Check 2-way valve and check valve. 3. Check indoor heat exchanger (TC/TCJ). 4. Check indoor P.C. board.
P31	Own unit stops while warning is output to other indoor units.	Stop (Follower unit) (Automatic reset)	Displayed when error is detected	1. Judge follower unit while master unit is [E03], [L03], [L07] or [L08]. 2. Check indoor P.C. board.
F01	Coming-off, disconnection or short of indoor heat exchanger temp. sensor (TCJ)	Stop (Automatic reset)	Displayed when error is detected	1. Check indoor heat exchanger temp. sensor (TCJ). 2. Check indoor P.C. board.
F02	Coming-off, disconnection or short of indoor heat exchanger temp. sensor (TC)	Stop (Automatic reset)	Displayed when error is detected	1. Check indoor heat exchanger temp. sensor (TC). 2. Check indoor P.C. board.
F10	Coming-off, disconnection or short of indoor heat exchanger temp. sensor (TA)	Stop (Automatic reset)	Displayed when error is detected	1. Check indoor heat exchanger temp. sensor (TA). 2. Check indoor P.C. board.
F29	Indoor EEPROM error • EEPROM access error	Stop (Automatic reset)	Displayed when error is detected	1. Check indoor EEPROM. (including socket insertion) 2. Check indoor P.C. board.
E10	Communication error between indoor MCU • Communication error between fan driving MCU and main MCU	Stop (Automatic reset)	Displayed when error is detected	1. Check indoor P.C. board.
E18	Regular communication error between indoor master and follower units and between main and sub units	Stop (Automatic reset)	Displayed when error is detected	1. Check remote controller wiring. 2. Check indoor power supply wiring. 3. Check indoor P.C. board.

Error mode detected by remote controller or central controller (TCC-LINK)

Operation of diagnostic function				Judgment and measures
Check code	Cause of operation	Status of air conditioner	Condition	
Not displayed at all (Operation on remote controller is impossible.)	No communication with master indoor unit <ul style="list-style-type: none"> Remote controller wiring is not correct. Power of indoor unit is not turned on. Automatic address cannot be completed. 	Stop	—	Power supply error of remote controller, Indoor EEPROM error <ol style="list-style-type: none"> Check remote controller inter-unit wiring. Check remote controller. Check indoor power wiring. Check indoor P.C. board. Check indoor EEPROM. (including socket insertion) → Automatic address repeating phenomenon generates.
E01 *2	No communication with master indoor unit <ul style="list-style-type: none"> Disconnection of inter-unit wire between remote controller and master indoor unit (Detected by remote controller side) 	Stop (Automatic reset) * If center exists, operation continues.	Displayed when error is detected	Receiving error from remote controller <ol style="list-style-type: none"> Check remote controller inter-unit wiring. Check remote controller. Check indoor power wiring. Check indoor P.C. board.
E02	Signal send error to indoor unit (Detected by remote controller side)	Stop (Automatic reset) * If center exists, operation continues.	Displayed when error is detected	Sending error of remote controller <ol style="list-style-type: none"> Check sending circuit inside of remote controller. → Replace remote controller.
E09	There are multiple main remote controllers. (Detected by remote controller side)	Stop (Sub unit continues operation.)	Displayed when error is detected	<ol style="list-style-type: none"> In 2-remote controllers (including wireless), there are multiple main units. Check that there are 1 main remote controller and other sub remote controllers.
L20 ----- Central controller L20	Duplicated indoor central addresses on communication of central control system (Detected by indoor/central controller side)	Stop (Automatic reset)	Displayed when error is detected	<ol style="list-style-type: none"> Check setting of central control system network address. (Network adapter SW01) Check network adapter P.C. board.
— *3 ----- Central controller (Send) C05 (Receive) C06	Communication circuit error of central control system (Detected by central controller side)	Continues (By remote controller)	Displayed when error is detected	<ol style="list-style-type: none"> Check communication wire / miswiring Check communication (U3, U4 terminals) Check network adapter P.C. board. Check central controller (such as central control remote controller, etc.) Check terminal resistance. (TCC-LINK)
— ----- Central controller P30	Indoor Gr sub unit error (Detected by central controller side)	Continuation/Stop (According to each case)	Displayed when error is detected	Check the check code of the corresponding unit from remote controller.

*2 The check code cannot be displayed by the wired remote controller.
(Usual operation of air conditioner becomes unavailable.)

For the wireless models, an error is notified with indication lamp.

*3 This trouble is related to communication of remote controller (A, B), central system (TCC-LINK U3, U4), and [E01], [E02], [E03], [E09] or [E18] is displayed or no check display on the remote controller according to the contents.

Error mode detected by outdoor unit

The check code has been ramified from 4 series and after.

The ramified check code is displayed only when both the indoor unit and the outdoor unit are 4 series and after.

(Ex. Combination of RAV-SM1404UT-E with RAV-SP1404AT-E)

When the indoor unit is 3 series and before, the conventional check code is displayed.

(Ex. Combination of RAV-SM1402BT-E and RAV-SP1404AT-E: Outdoor unit only is 4 series.)

Operation of diagnostic function						Judgment and measures
Check code		Cause of operation	Status of air conditioner	Condition		
Indoor unit						
before 3 series	after 4 series					
F04	F04	Disconnection, short of discharge temp. sensor (TD)	Stop	Displayed when error is detected	1. Check discharge temp. sensor (TD). 2. Check outdoor P.C. board.	
F06	F06	Disconnection, short of outdoor temp. sensor (TE)	Stop	Displayed when error is detected	1. Check temp. sensor (TE). 2. Check outdoor P.C. board.	
	F07	Disconnection, short of outdoor temp. sensor (TL)	Stop	Displayed when error is detected	1. Check temp. sensor (TL). 2. Check outdoor P.C. board.	
	F12	Disconnection, short of suction temp. sensor (TS)	Stop	Displayed when error is detected	1. Check suction temp. sensor (TS). 2. Check outdoor P.C. board.	
	F15	Miss-mounting of outdoor temp. sensor (TE, TS)	Stop	Displayed when error is detected	1. Check temp. sensor (TE, TS). 2. Check outdoor P.C. board.	
F08	F08	Disconnection, short of outside temp. sensor (TO)	Continue	Displayed when error is detected	1. Check outside temp. sensor (TO). 2. Check outdoor P.C. board.	
L29	F13	Disconnection, short of heat sink temp. sensor (TH)	Stop	Displayed when error is detected	1. Check outdoor P.C. board.	
	F31	Outdoor P.C. EEPROM error	Stop	Displayed when error is detected	1. Check outdoor P.C. board.	
	L10	Unset jumper of service P.C. board	Stop	Displayed when error is detected	1. Outdoor service P.C. board Check model type setting jumper wire.	
	L29	Communication error between outdoor P.C. board MCU	Stop	Displayed when error is detected	1. Check outdoor P.C. board.	
	P07	Heat sink overheat error * Heat sink temp. sensor detected over specified temperature.	Stop	Displayed when error is detected	1. Check screw tightening between PC. Board and heat sink and check radiator grease. 2. Check heat sink blast path.	
	P15	Detection of gas leak * Discharge temp. sensor (TD), Suction temp. sensor (TS) detected temperature over specified temp.	Stop	Displayed when error is detected	1. Check gas leak, recharge 2. Check full open of service valve. 3. Check PMV (Pulse Motor Valve). 4. Check broken pipe. 5. Check discharge temp. sensor (TD), suction temp. sensor (TS).	
H01	H01	Compressor break down * Although operation has started, operation frequency decreases and operation stops.	Stop	Displayed when error is detected	1. Check power supply voltage. (AC198 to 264V) 2. Overload operation of refrigerating cycle	
		Compressor lock * Over-current detection after compressor start-up	Stop	Displayed when error is detected	1. Trouble of compressor (Lock, etc.): Replace compressor. 2. Wiring error of compressor (Open phase)	
		Current detection circuit error	Stop	Displayed when error is detected	1. Check outdoor P.C. board. (AC current detection circuit)	

Operation of diagnostic function					Judgment and measures
Check code		Cause of operation	Status of air conditioner	Condition	
Indoor unit					
before 3 series	after 4 series				
P03	P03	Discharge temp. error * Discharge temp. (TD) over specified value was detected.	Stop	Displayed when error is detected	1. Check refrigerating cycle (Gas leak) 2. Trouble of electronic expansion valve 3. Check discharge temp. sensor (TD).
P04	H04	Case thermostat operation * Abnormal overheat of compressor	Stop	Displayed when error is detected	1. Check case thermostat and connector. 2. Check gas leak, recharge 3. Check full open of service valve. 4. Check PMV (Pulse Motor Valve). 5. Check broken pipe.
	P05	Power supply voltage error	Stop	Displayed when error is detected	1. Check power supply voltage. AC198 to 264V
	P20	High pressure protective operation • During cooling operation, outdoor temp. sensor (TL) detected temperature over specified temp. • During heating operation, indoor temp. sensor (TC, TCJ) detected temperature over specified temp.	Stop	Displayed when error is detected	1. Check outdoor heat exchanger sensor (TL). 2. Check indoor heat exchanger sensor (TC, TCJ). 3. Check full open of service valve. 4. Check indoor/outdoor fan. 5. Check PMV (Pulse Motor Valve). 6. Check clogging and short circuit of indoor/outdoor heat exchanger. 7. Overcharge of refrigerant. Recharge
P22	P22	Outdoor fan system error	Stop	Displayed when error is detected	1. Check lock of fan motor. 2. Check power supply voltage. AC198 to 264V 3. Check outdoor P.C. board.
P26	P26	Short-circuit error of compressor driving element	Stop	Displayed when error is detected	1. When performing operation while taking-off compressor wire, P26 error occurs. Check control P.C. board. 2. When performing operation while taking-off compressor wire, an error does not occur. (Compressor rare short)
P29	P29	Position detection circuit error	Stop	Displayed when error is detected	1. Check control P.C. board.

10-2-4. Diagnostic Procedure for Each Check Code (Indoor Unit)

Check code

[E01 error]

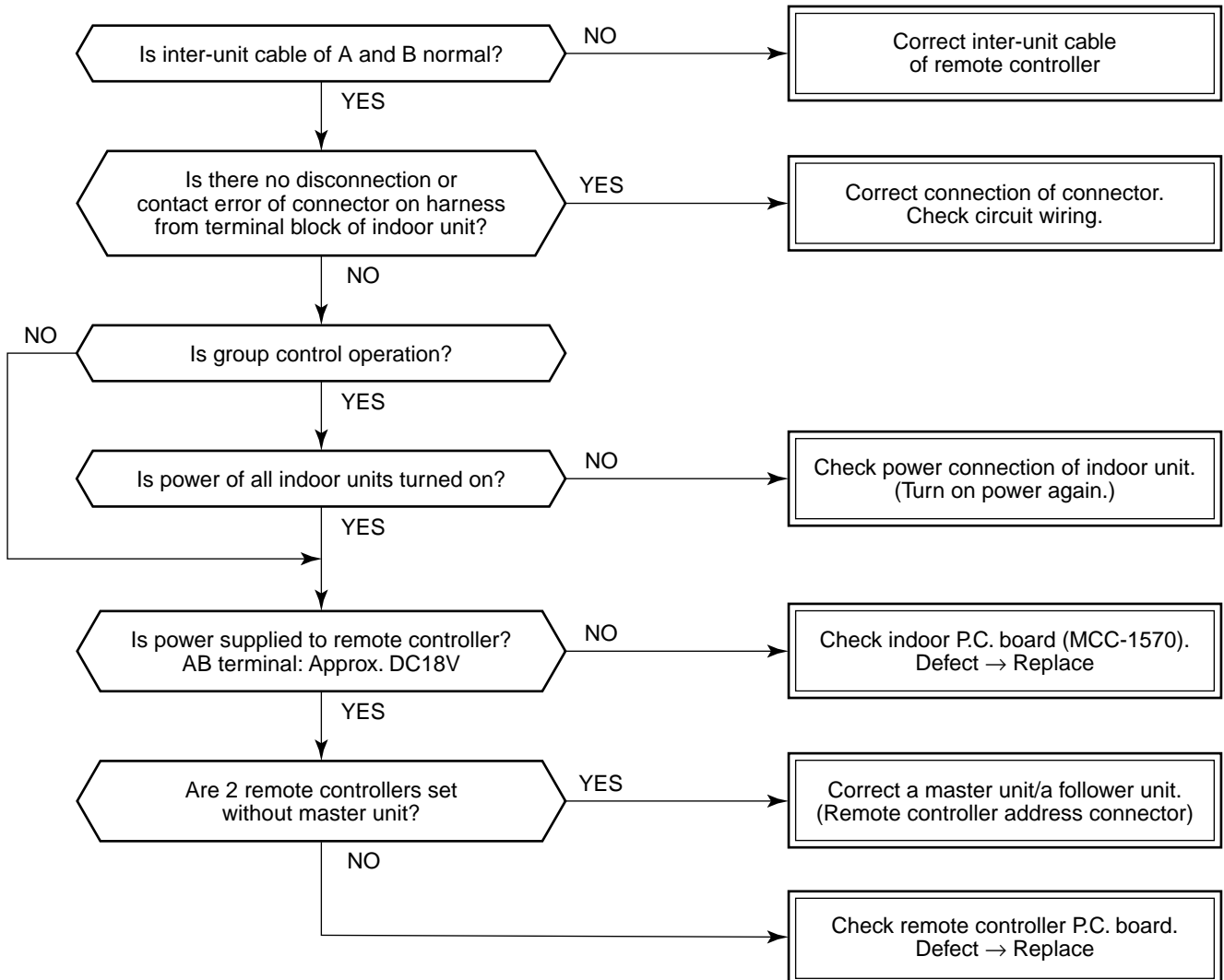

[E09 error]

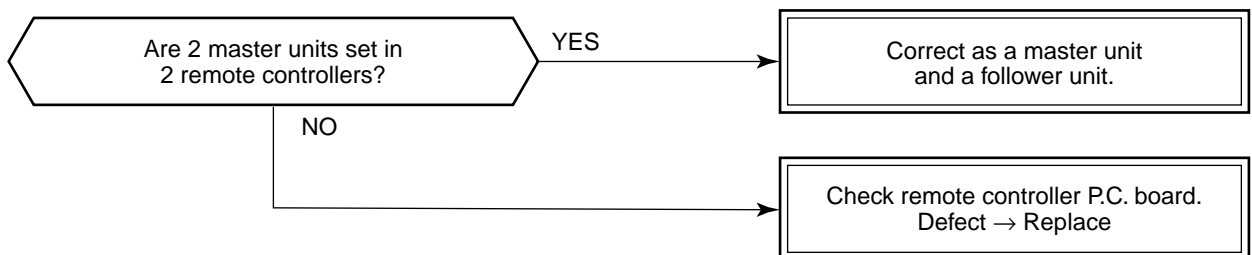

[E04 error]

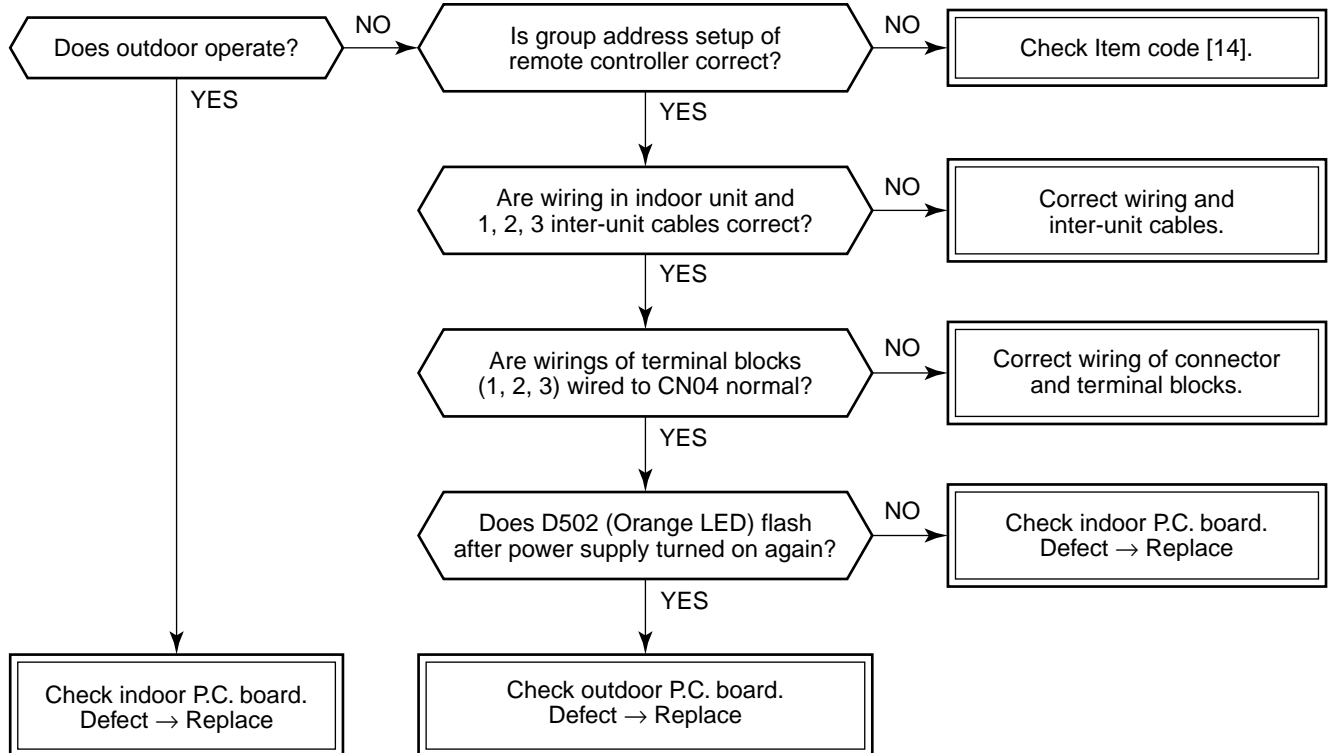

[E10 error]

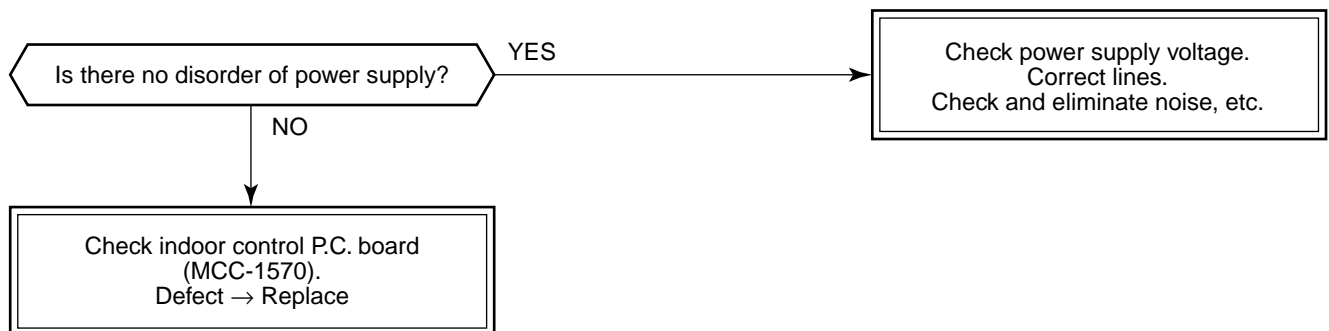

[E18 error]

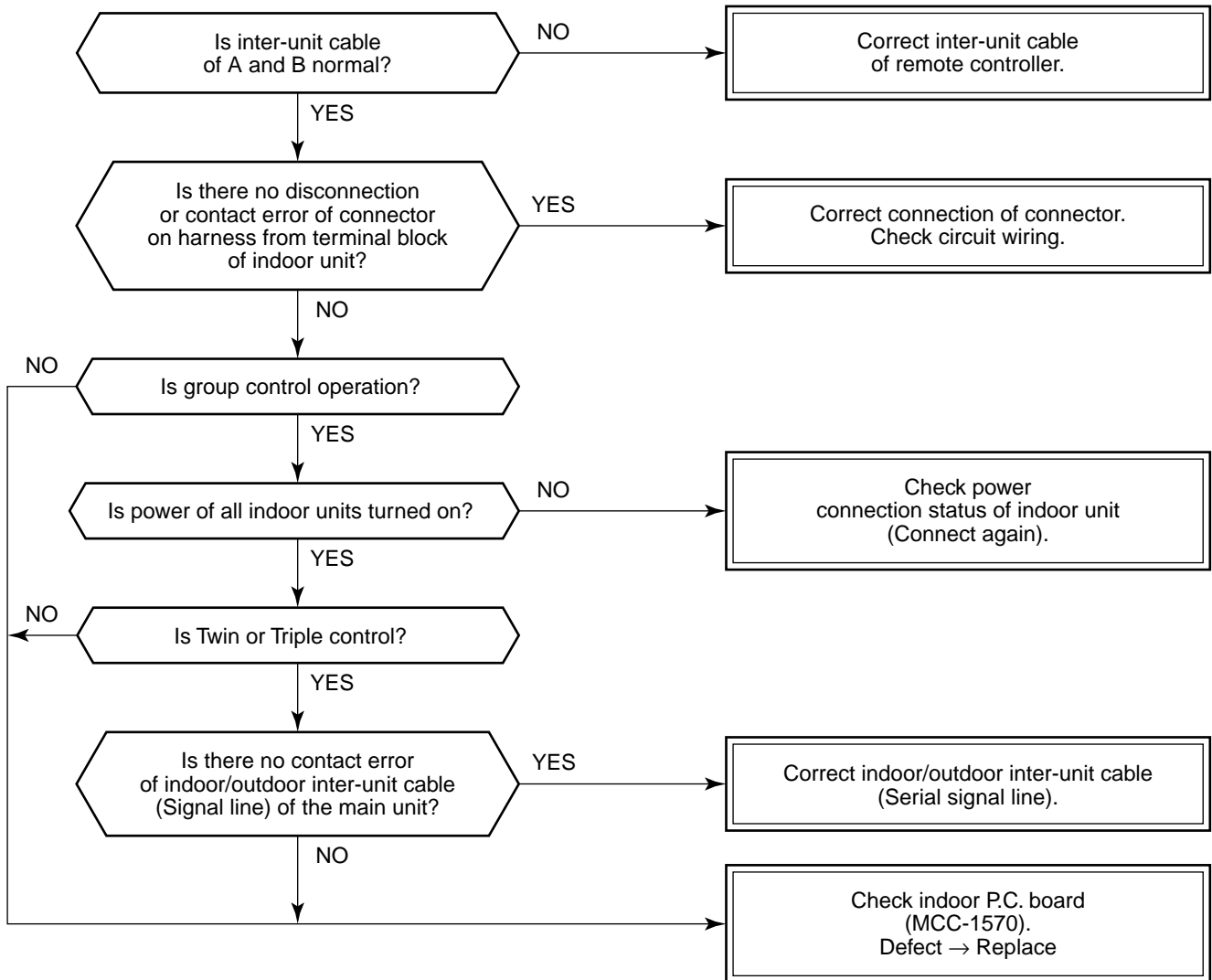

[E08, L03, L07, L08 error]

E08: Duplicated indoor unit No.

L03: There are 2 or more master units in a group control.

L07: There is 1 or more group address [Individual] in a group control.

L08: The indoor group address is unset. (13. ADDRESS SETUP)

If the above error is detected when power supply turned on, the mode enters automatically in the automatic address set mode. (Check code is not output.)

However, if the above error is detected during the automatic address set mode, a check code may be output.

[L09 error]

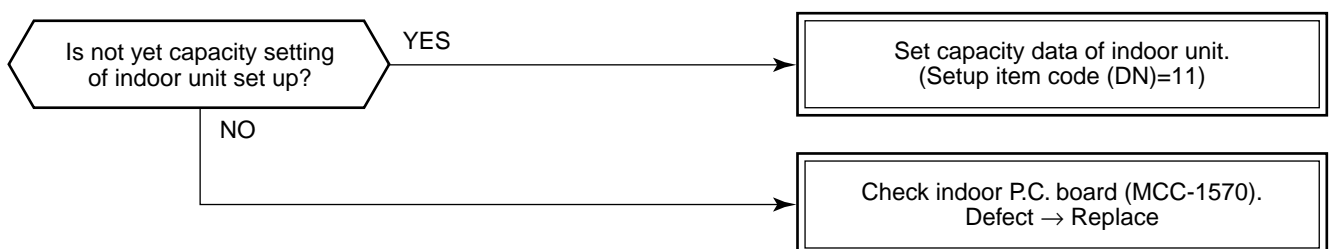

[L20 error]

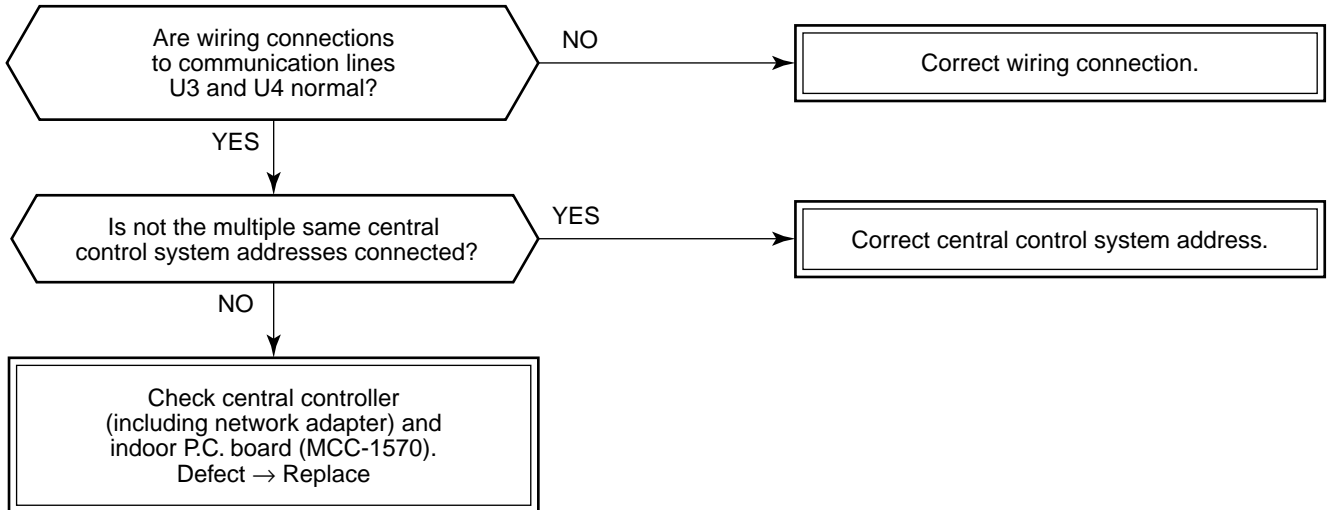

[L30 error]

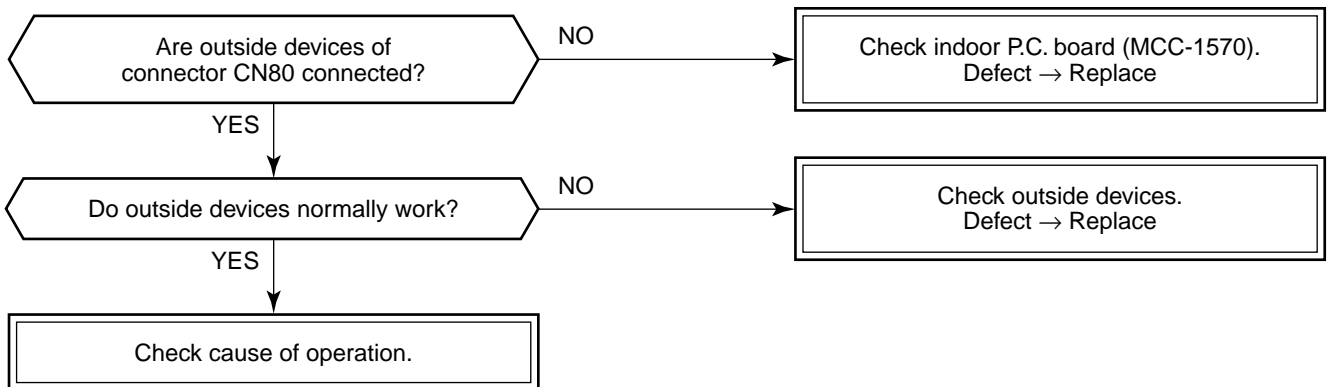

[P30 error] (Central controller)

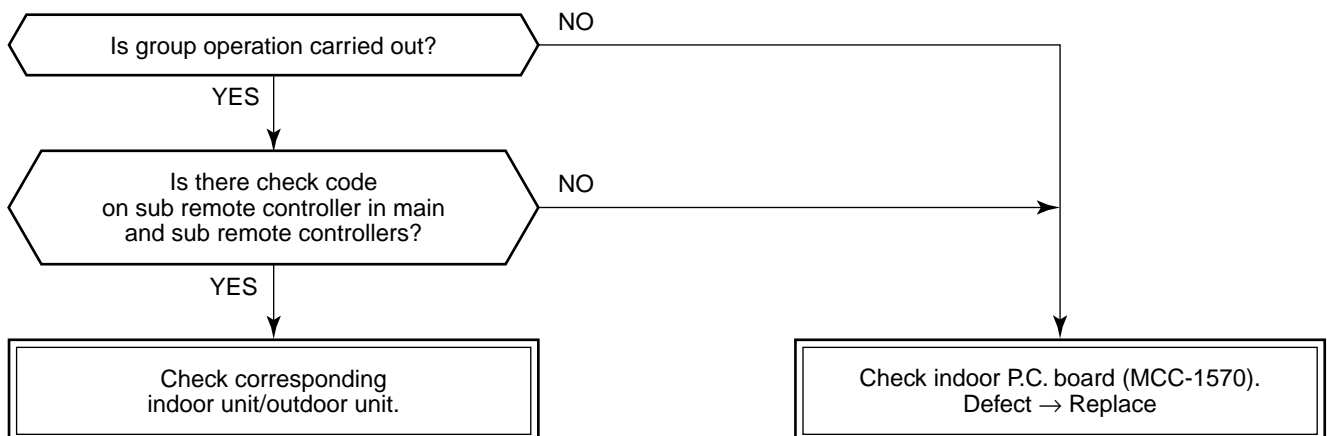

[P10 error]

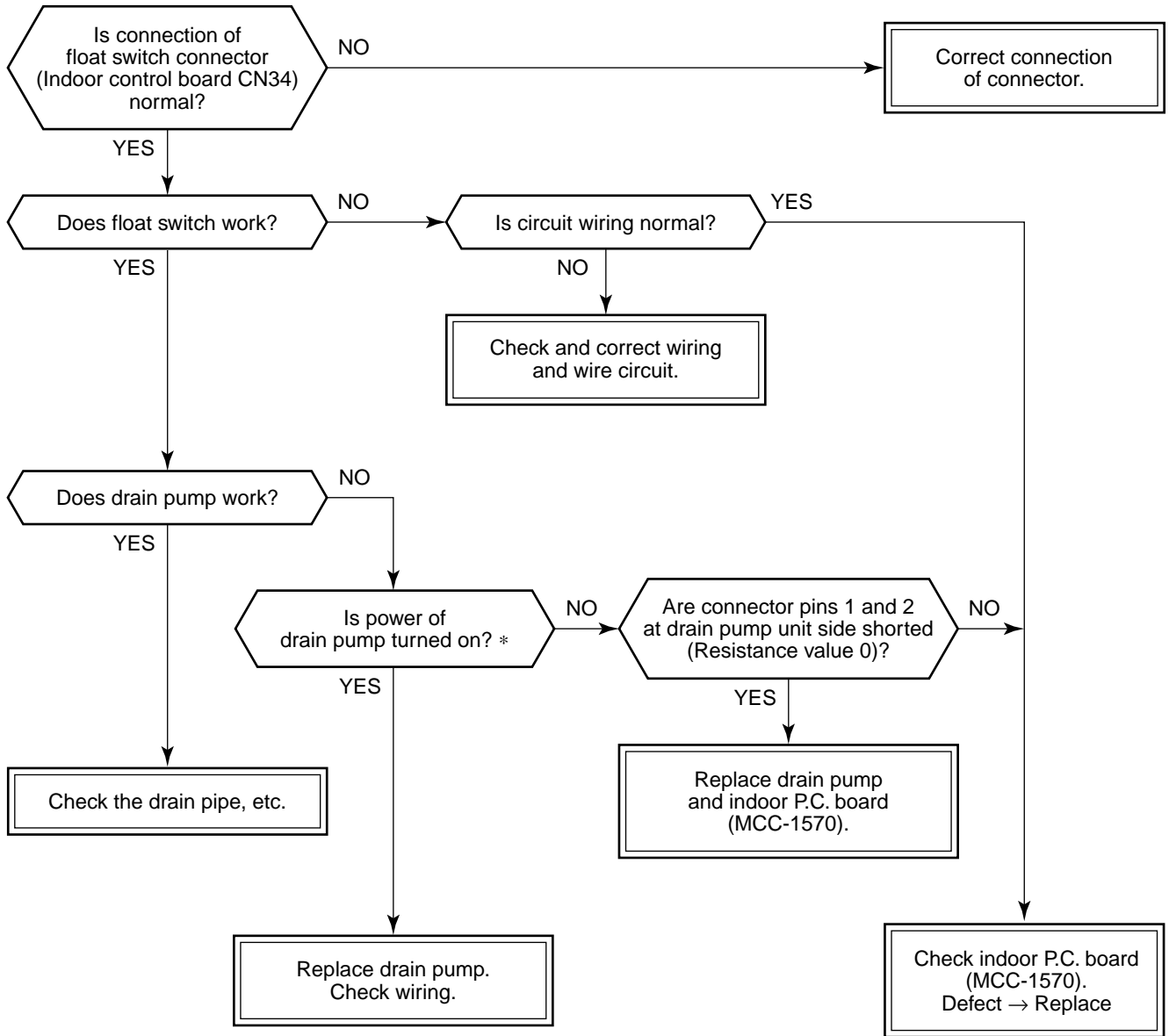

* Check that voltage of 1-2 pin of CN504 on the indoor P.C. board is +12V. (1 pin is plus (+).)

[F10 error]

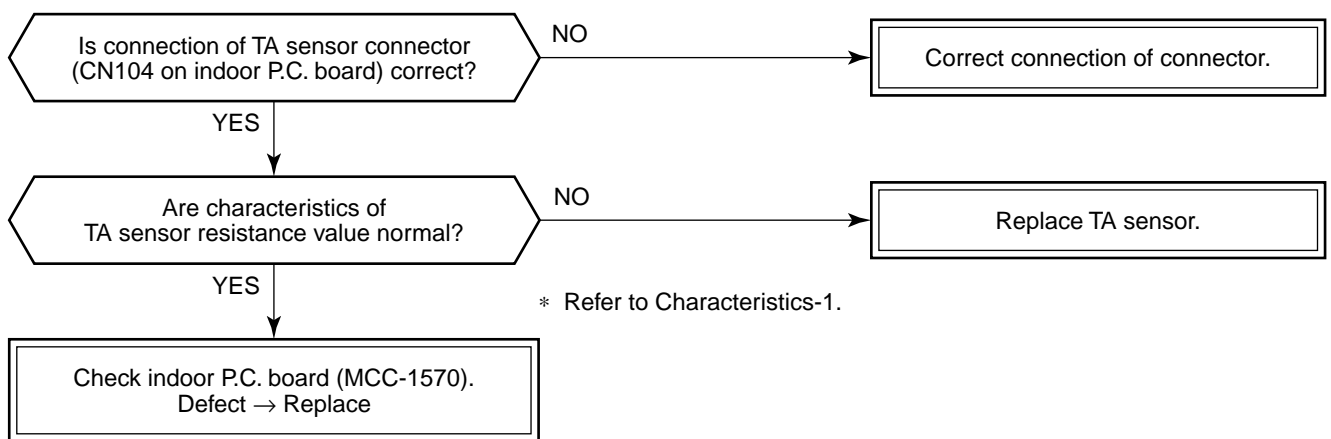

* Refer to Characteristics-1.

[P12 error]

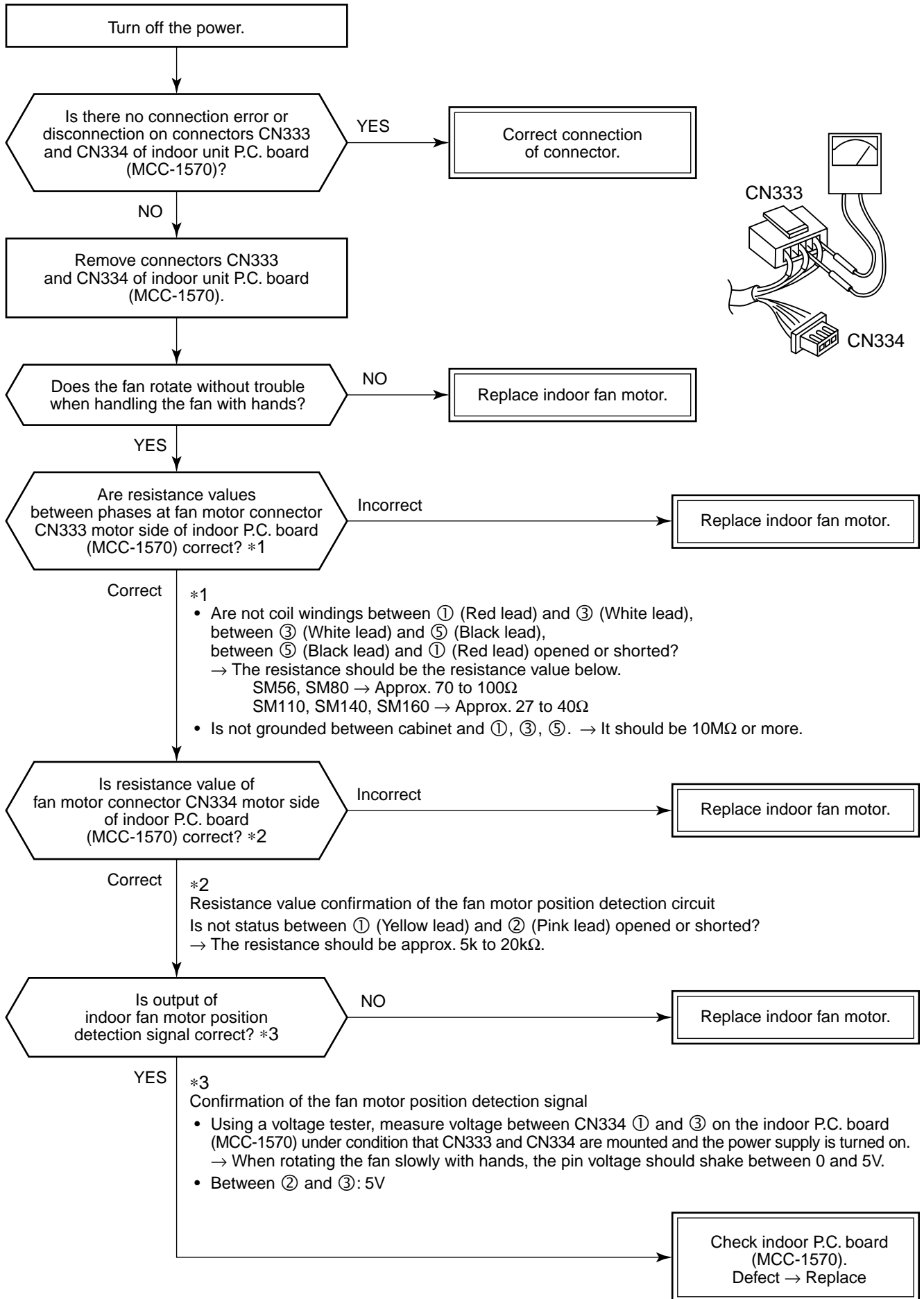

[F02 error]

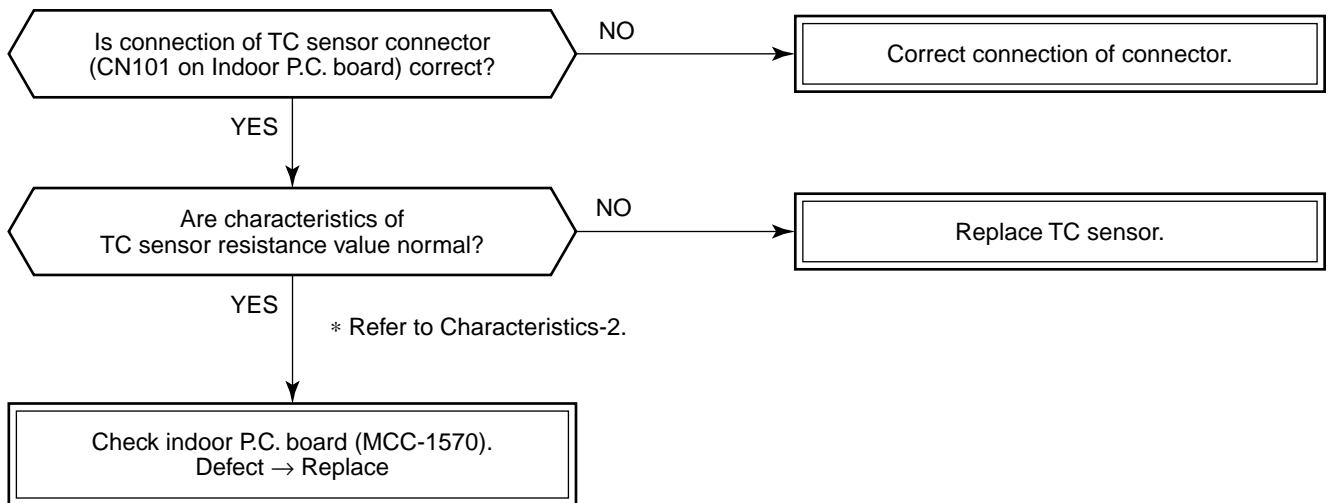

[F01 error]

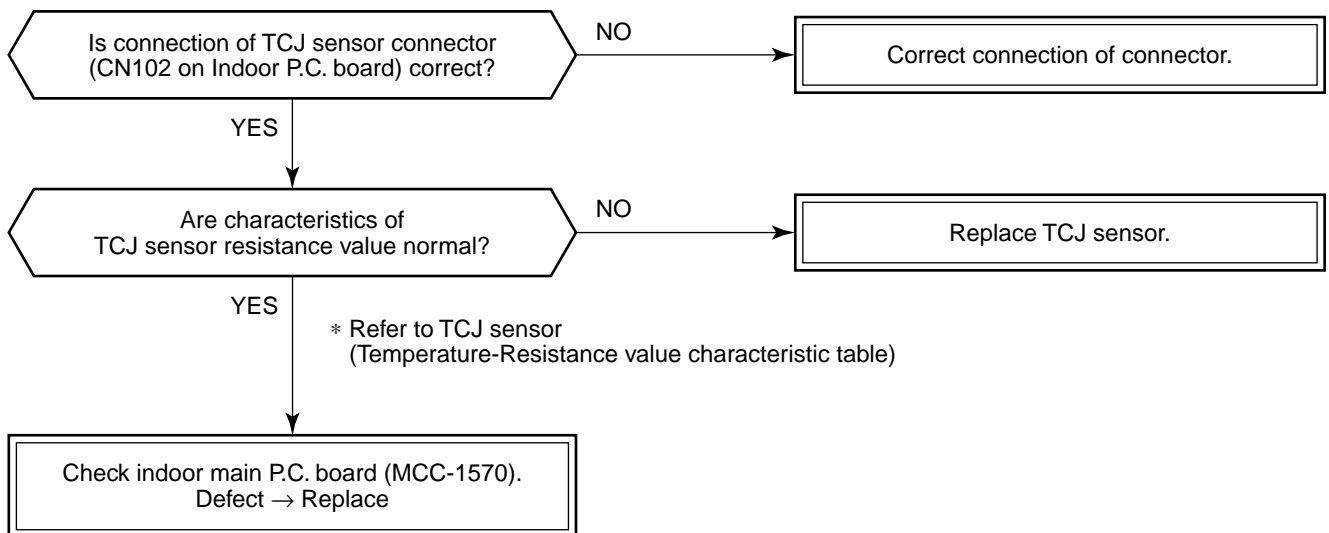

[C06 error] (TCC-LINK central controller)

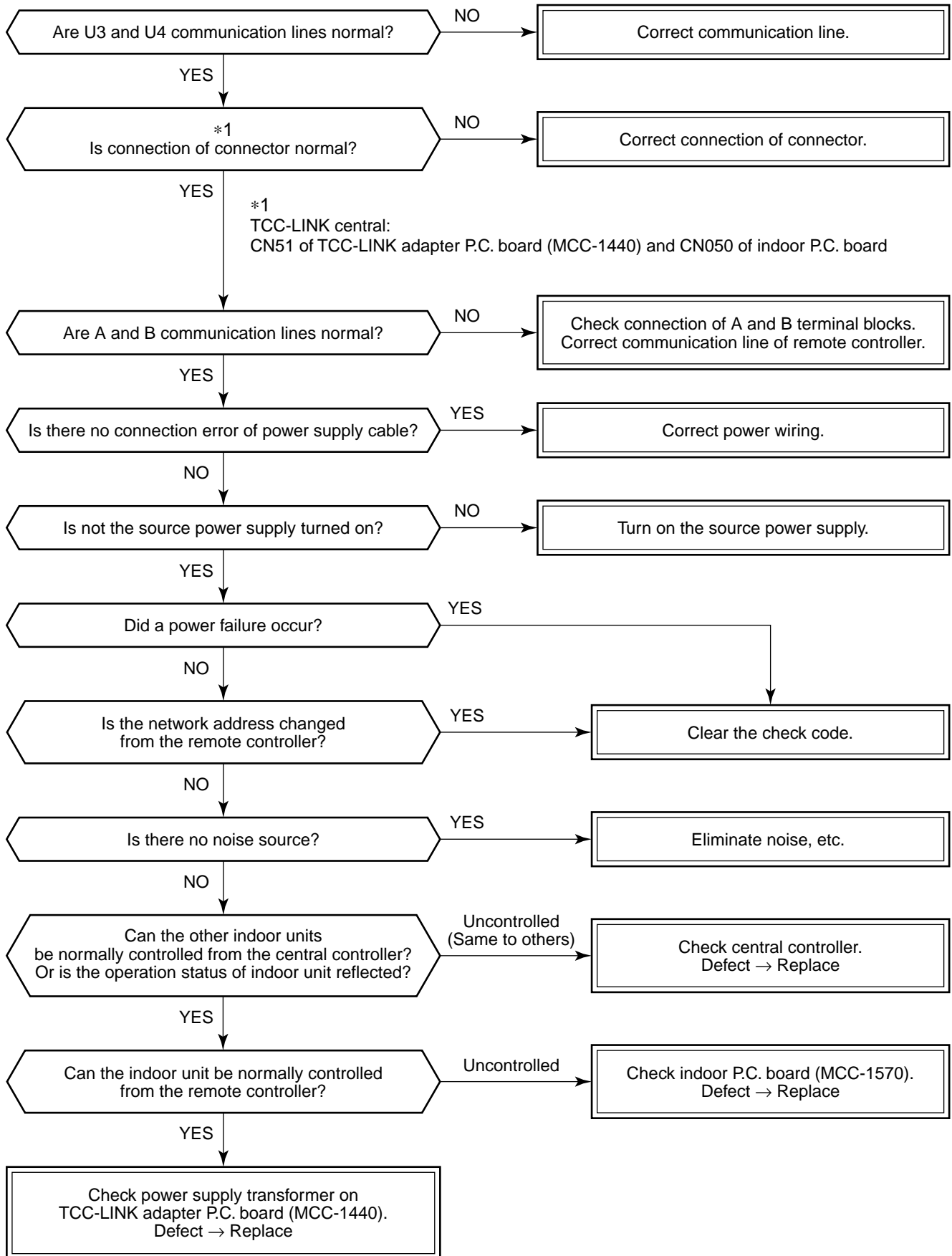

[E03 error] (Master indoor unit)

[E03 error] is detected when the indoor unit cannot receive a signal from the remote controller (also central controller).

Check A and B remote controllers and communication lines of the central control system U3 and U4.

As communication is impossible, this check code [E03] is not displayed on the remote controller and the central controller. [E01] is displayed on the remote controller and [C06 error] is displayed on the central controller.

If these check codes generate during operation, the air conditioner stops.

[F29 error]

This check code indicates a detection error of IC10 non-volatile memory (EEPROM) on the indoor unit P.C. board, which generated during operation of the air conditioner. Replace the service P.C. board.

* When EEPROM was not inserted when power supply turned on or when the EEPROM data read/write operation is impossible at all, the automatic address mode is repeated. In this time, [97 error] is displayed on the central controller.

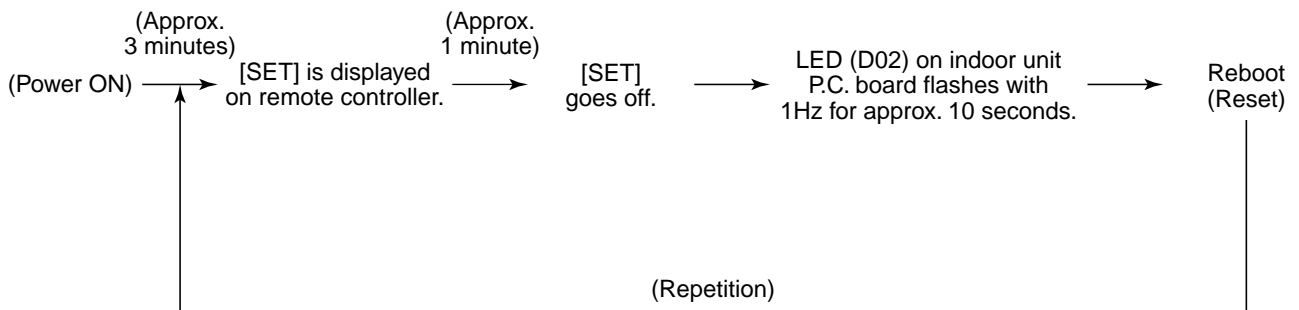

[P31 error] (Follower indoor unit)

When the master unit of a group operation detected [E03], [L03], [L07] or [L08] error, the follower unit of the group operation detects [P31 error] and then the unit stops.

There is no display of the check code or alarm history of the remote controller. (In this model, the mode enters in automatic address set mode when the master unit detected [L03], [L07] or [L08] error.)

10-2-5. Diagnostic Procedure for Each Check Code (Outdoor Unit)

- 1) This section describes the diagnostic method for each check code displayed on the remote controller.
- 2) In some cases, a check code indicates multiple symptoms.
In this case, confirm LED display on the outdoor P.C. board to narrow the contents to be confirmed.
- 3) The check code on the remote controller is displayed only when the same error occurred continuously by multiple times while LED of the outdoor P.C. board displays even an error which occurred once.
Therefore the display on the remote controller may differ from that of LED.

LED display on outdoor P.C. board

Dip switch setup

- When turning on 1) only of SW803, the latest error is displayed. As the memory is stored, it can be confirmed even if the power supply is turned off once. (excluding outside temp. sensor (TO) error)
- When the work finished or the outdoor temp. sensor (TO) error was found, turn off all of SW803. (The error which occurs at present is displayed.)

<Latest error display>

Only 1) of SW803 is ON.

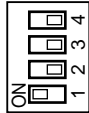

<Error display, which occurs at present>

All SW803 are OFF. (Initial status)



Display selection

- When even a LED of D800 to D804 (Yellow) goes on, error occurrence is indicated. **<Display 1>**
- If pushing the button switch SW800 for 1 second under the above condition, the yellow LED is displayed with flashing. **<Display 2>**
- When pushing SW800 for 1 second again, the status returns to **<Display 1>**.
- The error contents can be confirmed by combining **<Display 1>** and **<Display 2>**.

	(No error)	(Error occurred)	(Push SW800)
D800 (Yellow)	●	○	●
D801 (Yellow)	●	○	●
D802 (Yellow)	●	●	◎
D803 (Yellow)	●	●	●
D804 (Yellow)	●	○	●
D805 (Green)	○	○	○

(Example of discharge temp. sensor error)
● : Go off, ○ : Go on, ◎ : Flash

Check code	Outdoor LED display	Check and troubleshooting (Item without special mention Indicates part of outdoor unit.)
[E04]	—	<p>[Indoor/Outdoor communication error]</p> <pre> graph TD Q1{{Is setting of group address of remote controller correct?}} -- NO --> A1[Check Item code [14].] Q1 -- YES --> Q2{{Are inner wiring and inter-unit cables (1, 2, 3) normal?}} Q2 -- NO --> A2[Correct wiring and inter-unit cable.] Q2 -- YES --> Q3{{Are CN04 connection and wiring of terminal blocks (1, 2, 3) normal?}} Q3 -- NO --> A3[Correct wiring of connectors and terminal blocks.] Q3 -- YES --> Q4{{Does D502 (Orange LED) flash after power supply is turned on again?}} Q4 -- NO --> A4[Check indoor P.C. board. Defect → Replace] Q4 -- YES --> A5[Check outdoor P.C. board. Defect → Replace] </pre>

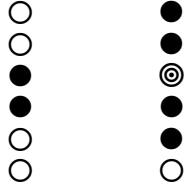
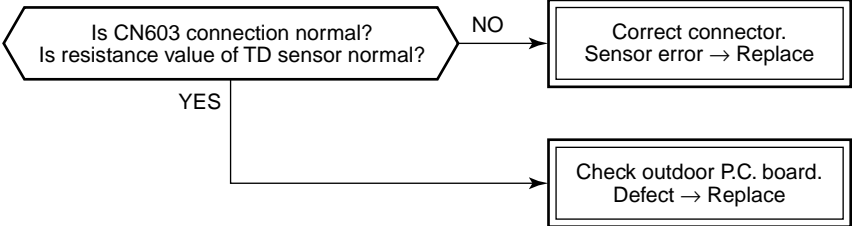
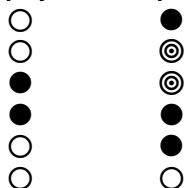
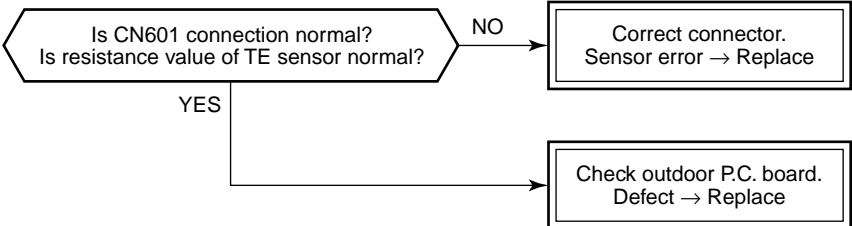
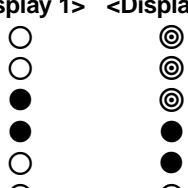
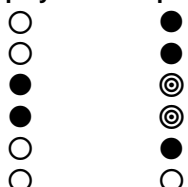
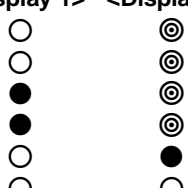
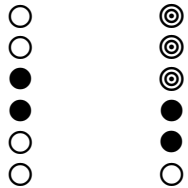
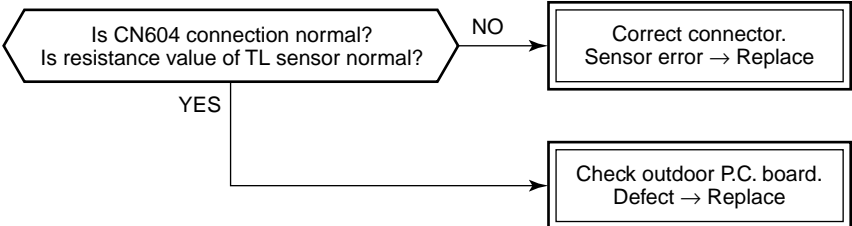
Check code	Outdoor LED display	Check and troubleshooting (Item without special mention Indicates part of outdoor unit.)
[F04]	<Display 1> <Display 2> 	[Discharge temp. sensor (TD) error] 
[F06]	<Display 1> <Display 2> 	<ul style="list-style-type: none"> • There is a possibility that it is one of the following errors. Confirm LED on outdoor P.C. board to judge which error it is. Heat exchanger temp. sensor (TE) error, Heat exchanger temp. sensor (TL) error, Suction temp. sensor (TS) error, Miswiring of heat exchanger sensor (TE, TS) [Heat exchanger temp. sensor (TE) error]  [Heat exchanger temp. sensor (TL) error] → Refer to [F07] column.  [Suction temp. sensor (TS) error] → Refer to [F12] column.  [Miswiring of heat exchanger sensor (TE, TS)] → Refer to [F15] column. 
[F07]	<Display 1> <Display 2> 	[Heat exchanger temp. sensor (TL) error] 

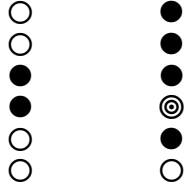
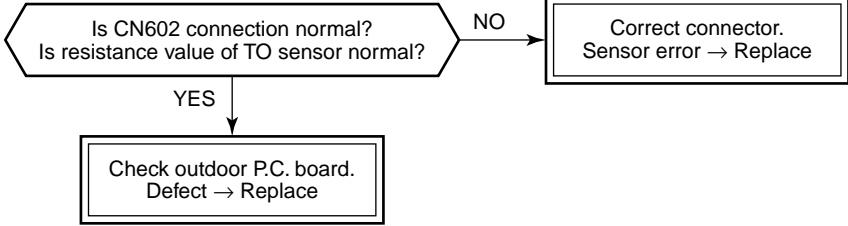
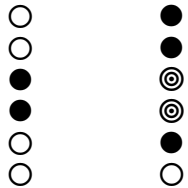
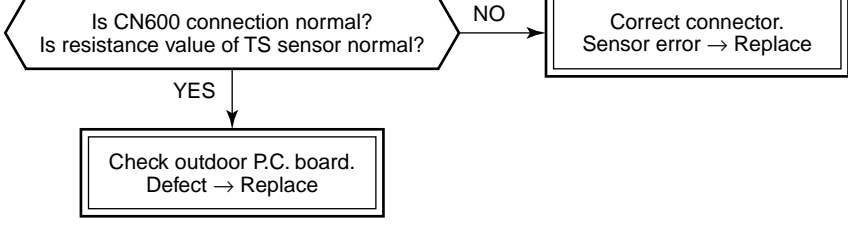
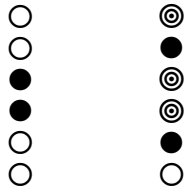
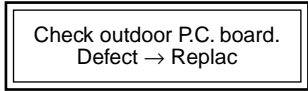
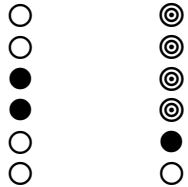
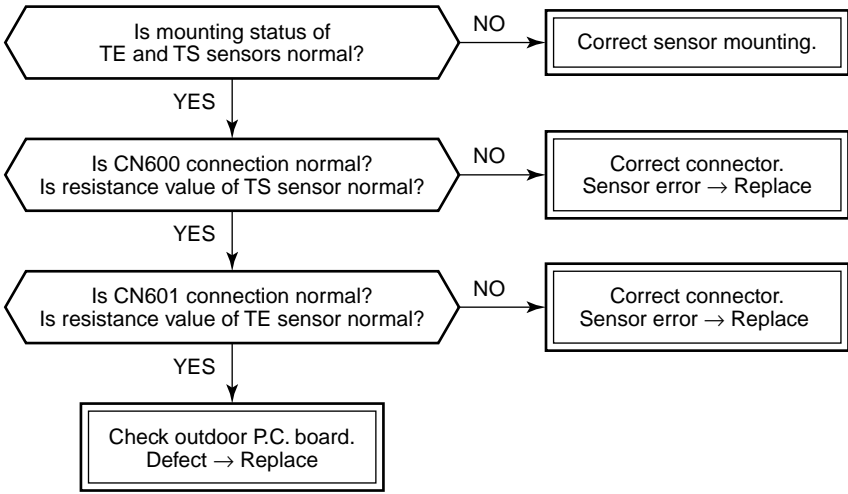
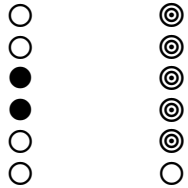
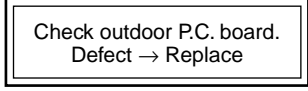
Check code	Outdoor LED display	Check and troubleshooting (Item without special mention Indicates part of outdoor unit.)
[F08]	<Display 1> <Display 2> 	[Outside air temp. sensor (TO) error] 
[F12]	<Display 1> <Display 2> 	[Suction temp. sensor (TS) error] 
[F13]	<Display 1> <Display 2> 	[Heat sink temp. sensor (TH) error] 
[F15]	<Display 1> <Display 2> 	[Miswiring of heat exchanger sensor (TE, TS)] 
[F31]	<Display 1> <Display 2> 	[EEPROM error] 

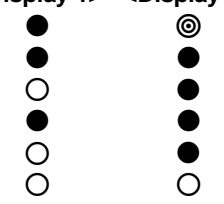
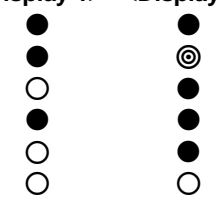
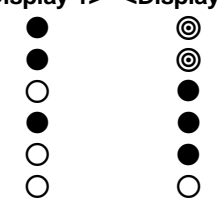
Check code	Outdoor LED display	Check and troubleshooting (Item without special mention Indicates part of outdoor unit.)
[H01]	<Display 1> <Display 2> 	<p>[Compressor break down]</p> <pre> graph TD Q1{{Is power supply voltage normal? AC198 to 264V}} -- NO --> A1[Correct power supply line.] Q1 -- YES --> Q2{{Is wire connection normal? Compressor lead (Board side, Compressor side), Reactor lead, Power supply lead}} Q2 -- NO --> A2[Check wire connection and correct it.] Q2 -- YES --> Q3{{Is it not abnormal overload?}} Q3 -- YES --> A3[Correct and clear the cause.] Q3 -- NO --> A4[Check outdoor P.C. board. Defect → Replace] </pre>
[H02]	<Display 1> <Display 2> 	<p>[Compressor lock]</p> <pre> graph TD Q1{{Is power supply voltage normal? AC198 to 264V}} -- NO --> A1[Correct power supply line.] Q1 -- YES --> Q2{{Is wire connection normal? Compressor lead (Board side, Compressor side), Reactor lead, Power supply lead}} Q2 -- NO --> A2[Check wire connection and correct it.] Q2 -- YES --> Q3{{Is compressor normal?}} Q3 -- YES --> A3[Check outdoor P.C. board. Defect → Replace] Q3 -- NO --> Q4{{Is there no refrigerant stagnation?}} Q4 -- NO --> A4[Compressor lock → Replace] Q4 -- YES --> Q5{{Does PMV normally operate?}} Q5 -- NO --> A5[Check TE, TS sensors and PMV. Defect → Replace] Q5 -- YES --> A6[Check outdoor P.C. board. Defect → Replace] </pre>
[H03]	<Display 1> <Display 2> 	<p>[Current detection circuit error]</p> <pre> graph TD A[Check outdoor P.C. board. Defect → Replace] </pre>

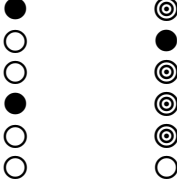
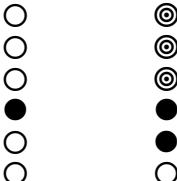
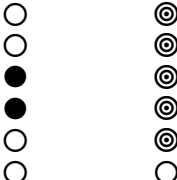
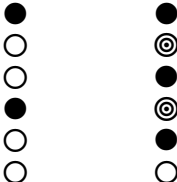
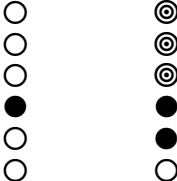
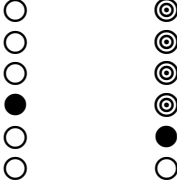
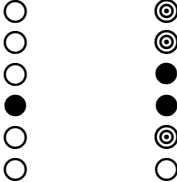

Check code	Outdoor LED display	Check and troubleshooting (Item without special mention Indicates part of outdoor unit.)
[H04]	<p><Display 1> <Display 2></p> <div style="display: flex; justify-content: space-around;"> <div style="text-align: center;"> <p>●</p><p>●</p><p>○</p><p>●</p><p>○</p><p>○</p> </div> <div style="text-align: center;"> <p>●</p><p>●</p><p>◎</p><p>●</p><p>○</p> </div> </div>	<p>[Case thermostat operation]</p> <pre> graph TD Q1{{Are CN609 connection and case thermostat normal?}} -- NO --> A1[Correct connector. Case thermostat error → Replace] Q1 -- YES --> Q2{{Is cooling/heating operation available when short-circuiting case thermostat?}} Q2 -- NO --> A2[Check outdoor P.C. board. Defect → Replace] Q2 -- YES --> Q3{{Is there no gas leak? Is it not refrigerant shortage?}} Q3 -- NO --> A3[Repair defectives position. Recharge refrigerant.] Q3 -- YES --> Q4{{Is valve fully opened?}} Q4 -- NO --> A4[Open valve fully.] Q4 -- YES --> Q5{{Is PMV normal?}} Q5 -- NO --> A5[Correct defective position. Replace defective part.] Q5 -- YES --> A6[Check crushed or broken pipe. Defect → Correct and Replace] </pre>
[L10]	<p><Display 1> <Display 2></p> <div style="display: flex; justify-content: space-around;"> <div style="text-align: center;"> <p>●</p><p>○</p><p>○</p><p>●</p><p>○</p><p>○</p> </div> <div style="text-align: center;"> <p>●</p><p>◎</p><p>●</p><p>◎</p><p>●</p><p>○</p> </div> </div>	<p>[Unset model type]: Only when service P.C. board is used</p> <div style="border: 1px solid black; padding: 5px; margin: 10px auto; width: fit-content;"> <p>Cut jumper line according to the explanation sheet packaged with the service P.C. board.</p> </div>

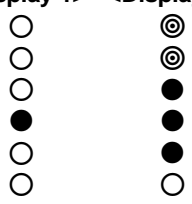
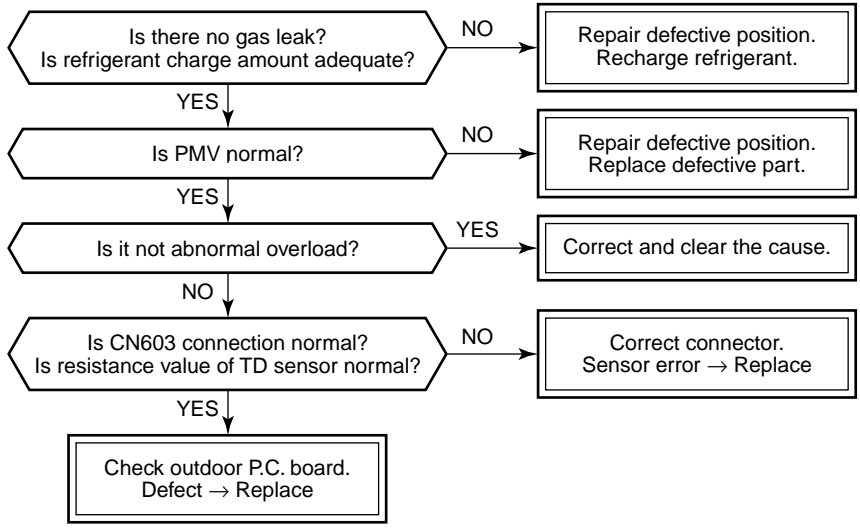
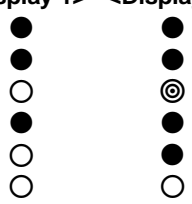
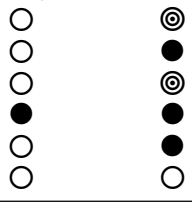
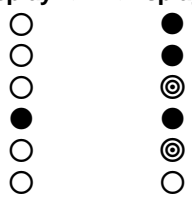
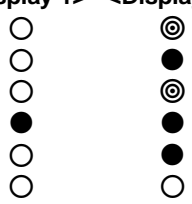
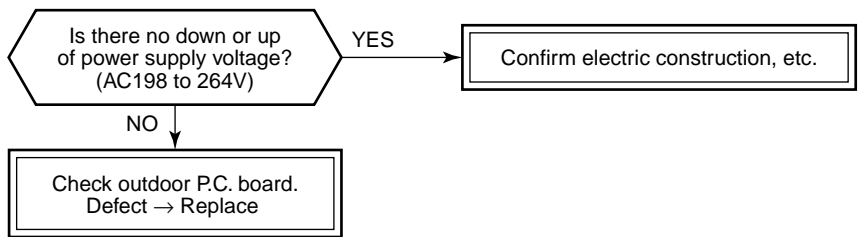
Check code	Outdoor LED display	Check and troubleshooting (Item without special mention Indicates part of outdoor unit.)
[L29]		* There is a possibility that it is one of the following errors. Confirm LED on outdoor P.C. board to judge which error it is. Communication error between MCU, Heat sing temp. sensor (TH) error, EEPROM error, Unset model type, Heat sink overhear error, Gas leak detection, 4-way valve inverse error
	<Display 1> <Display 2> 	[Communication error between MCU] <div style="border: 1px solid black; padding: 5px; width: fit-content; margin: 0 auto;"> Check outdoor P.C. board. Defect → Replace </div>
	<Display 1> <Display 2> 	[Heat sink temp. sensor (TH) error] → Refer to [F13] column.
	<Display 1> <Display 2> 	[EEPROM error] → Refer to [F31] column.
	<Display 1> <Display 2> 	[Unset model type] → Refer to [L10] column.
	<Display 1> <Display 2> 	[Heat sink overhear error] → Refer to [P07] column.
	<Display 1> <Display 2> 	[Gas leak detection] → Refer to [P15] column.
	<Display 1> <Display 2> 	[4-way valve inverse error] → Refer to [P19] column.

Check code	Outdoor LED display	Check and troubleshooting (Item without special mention Indicates part of outdoor unit.)
[P03]	<Display 1> <Display 2> 	<p>[Discharge temp. error]</p> 
[P04]		<p>* There is a possibility that it is one of the following errors. Confirm LED on outdoor P.C. board to judge which error it is. Power supply error (Vdc), High pressure protective operation, Case thermostat operation</p>
	<Display 1> <Display 2> 	<p>[Case thermostat operation] → Refer to [H04] column.</p>
	<Display 1> <Display 2> 	<p>[Power supply error (Vdc)] → Refer to [P05] column.</p>
	<Display 1> <Display 2> 	<p>[High pressure protective operation] → Refer to [P20] column.</p>
[P05]	<Display 1> <Display 2> 	<p>[Power supply error (Voltage error)]</p> 

Check code	Outdoor LED display	Check and troubleshooting (Item without special mention Indicates part of outdoor unit.)
[P07]	<p><Display 1> <Display 2></p> <div style="display: flex; justify-content: space-around;"> <div style="text-align: center;"> <p>○</p><p>○</p><p>○</p><p>●</p><p>○</p><p>○</p> </div> <div style="text-align: center;"> <p>◎</p><p>◎</p><p>◎</p><p>●</p><p>●</p><p>○</p> </div> </div>	<p>[Heat sink overheat error]</p> <pre> graph TD Q1{{Is there no loosening of screws of motor drive element of outdoor P.C. board Q200, Q300, Q400 and rectifier DB01, DB02, DB03? Did not forget to apply radiation grease to rear side of Q200, DB01, DB02 or DB03?}} Q2{{Is not the ventilation flue of the heat sink blocked? Is not the fan blocked? (Short-circuit, etc.)}} A1[Apply radiation grease to objective part. Retightening of screws. (Be sure not to forget to attach insulating sheet between heat sink and Q300, Q400.)] A2[Remove blocking matter. Correct short-circuit.] A3[Check outdoor P.C. board. Defect -> Replace] Q1 -- YES --> A1 Q1 -- NO --> Q2 Q2 -- YES --> A3 Q2 -- NO --> A2 </pre>
[P15]	<p><Display 1> <Display 2></p> <div style="display: flex; justify-content: space-around;"> <div style="text-align: center;"> <p>○</p><p>○</p><p>○</p><p>●</p><p>○</p><p>○</p> </div> <div style="text-align: center;"> <p>◎</p><p>◎</p><p>◎</p><p>◎</p><p>●</p><p>○</p> </div> </div>	<p>[Gas leak detection]</p> <pre> graph TD Q1{{Is there no gas leak? Is refrigerant charge amount adequate?}} Q2{{Is PMV normal?}} Q3{{Is valve fully opened?}} Q4{{Is there no crushed pipe?}} Q5{{Check temp. sensor. TD sensor CN603 TS sensor CN600}} A1[Repair defective position. Recharge refrigerant.] A2[Correct defective position. Replace defective part.] A3[Open valve fully.] A4[Correct and replace piping.] A5[Correct connector. Sensor error -> Replace] A6[Check outdoor P.C. board. Defect -> Replace] Q1 -- YES --> Q2 Q1 -- NO --> A1 Q2 -- YES --> Q3 Q2 -- NO --> A2 Q3 -- YES --> Q4 Q3 -- NO --> A3 Q4 -- YES --> A4 Q4 -- NO --> Q5 Q5 -- Error --> A5 Q5 -- OK --> A6 </pre>

Check code	Outdoor LED display	Check and troubleshooting (Item without special mention Indicates part of outdoor unit.)				
[P19]	<p><Display 1> <Display 2></p> <div style="display: flex; justify-content: space-around;"> <div style="text-align: center;"> <p>○</p><p>○</p><p>○</p><p>●</p><p>○</p><p>○</p> </div> <div style="text-align: center;"> <p>◎</p><p>◎</p><p>●</p><p>◎</p><p>○</p> </div> </div>	<p>[4-way valve inverse error]</p> <p>Check method of outdoor P.C. board operation (Self-hold valve type)</p> <ol style="list-style-type: none"> Set SW804 of Dip switch as the following figure and then push SW801 for approx. 1 second to check exchange operation to cooling cycle/heating cycle. <ul style="list-style-type: none"> Power is turned on for approx. 10 seconds. When checking again, check operation 1 minute or more after the first check because exothermic of part (Coil, resistance R700) is large. (There is no problem when coil is not connected.) After check, turn off all the Dip switch SW804. <table border="1" style="width: 100%; text-align: center;"> <thead> <tr> <th style="width: 50%;">Exchange to cooling cycle</th> <th style="width: 50%;">Exchange to heating cycle</th> </tr> </thead> <tbody> <tr> <td> </td> <td> </td> </tr> </tbody> </table> <p>Note) Check by tester Analog tester : Good if over DC200V Digital tester : Good if Max. value is over DC200V though the varied value may be displayed.</p>	Exchange to cooling cycle	Exchange to heating cycle		
Exchange to cooling cycle	Exchange to heating cycle					

Check code	Outdoor LED display	Check and troubleshooting (Item without special mention Indicates part of outdoor unit.)
[P20]	<Display 1>  <Display 2> 	<p>[High pressure protective operation]</p> <pre> graph TD Q1{{Is valve fully opened?}} -- NO --> A1[Open valve fully.] Q1 -- YES --> B1[Reset the power supply and then perform test run matching to the season.] B1 --> Q2{{Is there no problem on outdoor TL sensor? (Measurement of resistance value)}} Q2 -- NO --> A2[Replace sensor.] Q2 -- YES --> Q3{{Is there no crack or loosening of outdoor fan?}} Q3 -- NO --> A3[Check outdoor fan. Defect -> Replace, retightening] Q3 -- YES --> Q4{{Does not the outdoor fan perform abnormal operation?}} Q4 -- NO --> A4[Check the same items as [P22] error.] Q4 -- YES --> Q5{{Is there no element which interfere heat exchange of outdoor unit? (Clogging of heat exchanger, Short circuit)}} Q5 -- YES --> A5[Eliminate interfering element.] Q5 -- NO --> B2[Check overcharge of refrigerant, clogging of cycle, broken pipe, abnormal overload, etc. Defect -> Correct defective position.] B2 --> Q6{{Does indoor fan normally operate?}} Q6 -- NO --> Q7{{Are indoor fan motor and connector normal?}} Q7 -- NO --> A6[Repair defective position.] Q7 -- YES --> Q8{{Are resistance values of indoor TC and TCJ sensors normal?}} Q8 -- NO --> A7[Replace sensor.] Q8 -- YES --> Q9{{Is there no element which interfere heat exchange of indoor unit? (Clogging of filter, Clogging of heat exchanger, Short circuit)}} Q9 -- YES --> A8[Check indoor P.C. board. Defect -> Replace] Q9 -- YES --> A9[Eliminate interfering element.] Q9 -- NO --> B3[Check overcharge of refrigerant, clogging of cycle, broken pipe, abnormal overload, etc. Defect -> Correct defective position.] </pre>

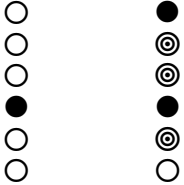
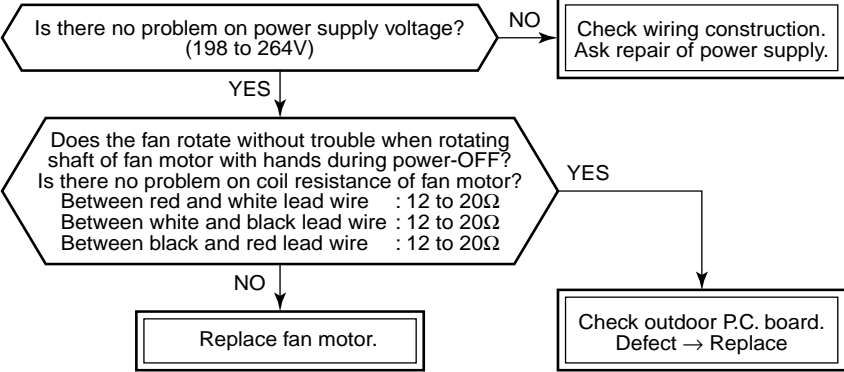
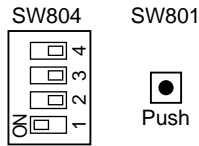
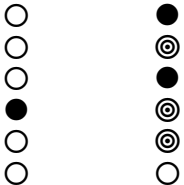
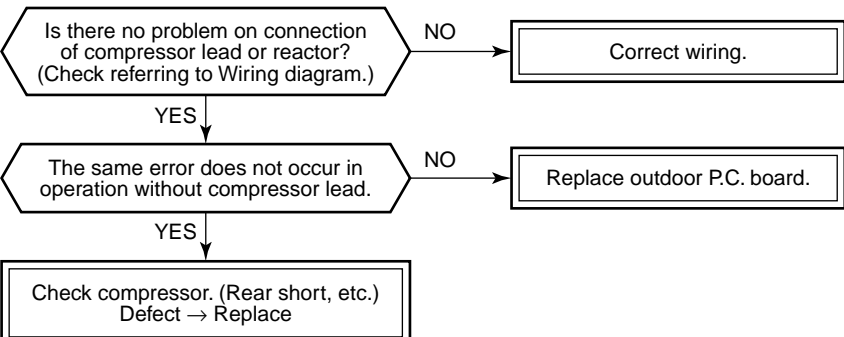
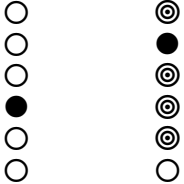
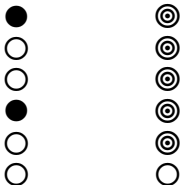
Check code	Outdoor LED display	Check and troubleshooting (Item without special mention Indicates part of outdoor unit.)
[P22]	<p><Display 1> <Display 2></p> 	<p>[Fan system error]</p>  <p>Single operation check for outdoor fan</p> <ol style="list-style-type: none"> Set SW804 of Dip switch as the following figure and then push SW801 for approx. 1 second to check single operation of outdoor fan. Use this method to check which fan, upper or lower fan, has a trouble. <ul style="list-style-type: none"> When pushing SW801 for 1 second again or 2 minutes passed, the fan stops. After check, turn off all Dip switch SW804. <div data-bbox="1088 840 1428 1064" style="border: 1px solid black; padding: 5px;"> <p style="text-align: center;">Outdoor fan single operation</p>  </div>
[P26]	<p><Display 1> <Display 2></p> 	<p>[Short-circuit of compressor drive element]</p> 
[P29]	<p><Display 1> <Display 2></p> 	<p>[Position detection circuit error]</p> <div data-bbox="582 1646 917 1724" style="border: 1px solid black; padding: 5px;"> <p>Check outdoor P.C. board. Defect → Replace</p> </div>
— No code	<p><Display 1> <Display 2></p> 	<p>[Other error] Compressor disorder due to sudden change of load, etc.</p> <ul style="list-style-type: none"> * Although the display of outdoor LED outputs, the unit automatically restarts and error is not determined. * LED display also may output due to negative phase of compressor or wire coming-off.

Temperature sensor Temperature – Resistance value characteristic table

TA, TC, TCJ, TE, TS, TO sensors

TD, TL sensors

Representative value

Representative value

Temperature (°C)	Resistance value (kΩ)		
	(Minimum value)	(Standard value)	(Maximum value)
0	32.33	33.80	35.30
10	19.63	20.35	21.09
20	12.23	12.59	12.95
25	9.75	10.00	10.25
30	7.764	7.990	8.218
40	5.013	5.192	5.375
50	3.312	3.451	3.594
60	2.236	2.343	2.454
70	1.540	1.623	1.709
80	1.082	1.146	1.213
90	0.7740	0.8237	0.8761
100	0.5634	0.6023	0.6434

Temperature (°C)	Resistance value (kΩ)		
	(Minimum value)	(Standard value)	(Maximum value)
0	150.5	161.3	172.7
10	92.76	99.05	105.6
20	58.61	62.36	66.26
25	47.01	49.93	52.97
30	37.93	40.22	42.59
40	25.12	26.55	28.03
50	17.00	17.92	18.86
60	11.74	12.34	12.95
70	8.269	8.668	9.074
80	5.925	6.195	6.470
90	4.321	4.507	4.696
100	3.205	3.336	3.468

TA, TC, TCJ, TE, TS, TO sensors

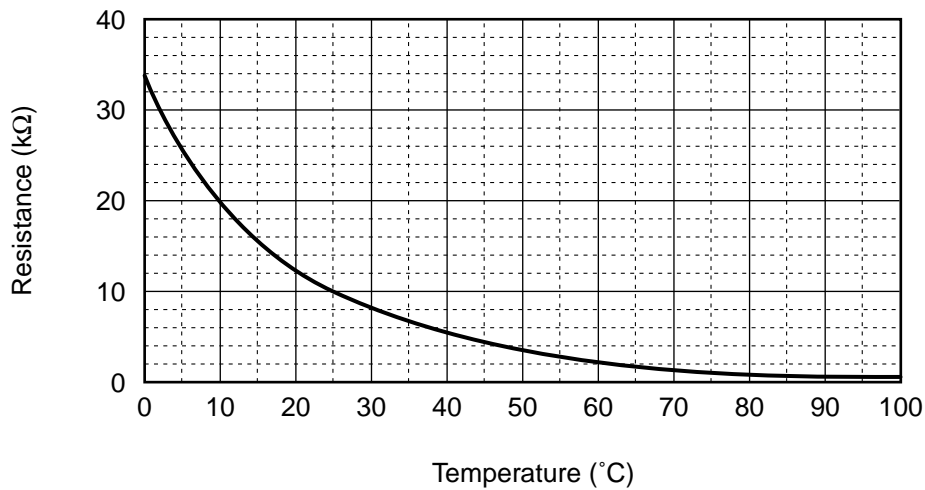

TD, TL sensors

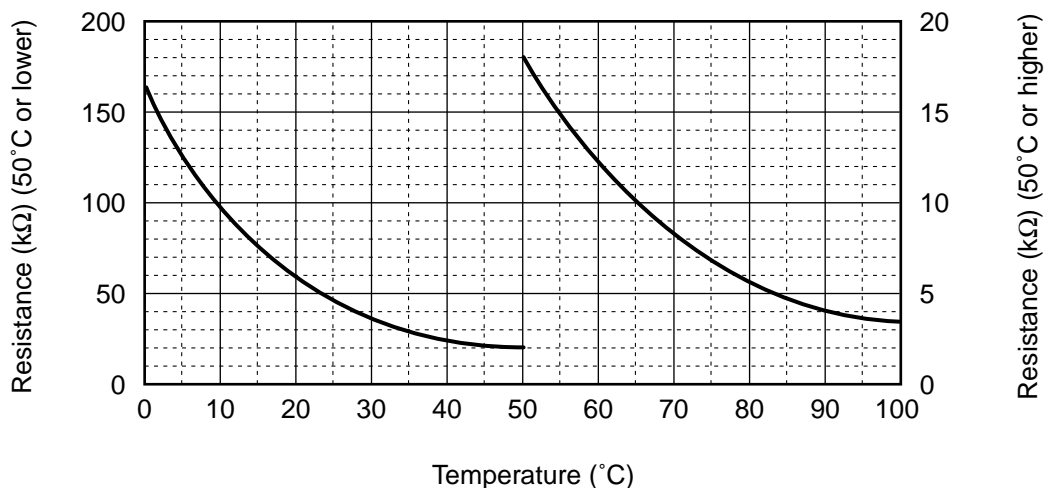

* As TH sensor (Outdoor unit heat sink temp. sensor) is incorporated in the outdoor control P.C. board, the resistance value cannot be measured.

10-2-6. Outline of judgment

The primary judgment to check whether a trouble occurred in the indoor unit or outdoor unit is carried out with the following method.

Method to judge the erroneous position by flashing indication on the display part of the indoor unit (sensors of the receiving part)

The indoor unit monitors the operating status of the air conditioner, and the blocked contents of self-diagnosis are displayed restricted to the following cases if a protective circuit works.

● : Go off, ○ : Go on, ☼ : Flash (0.5 sec.)

Lamp indication	Check code	Cause of trouble occurrence
Operation Timer Ready ● ● ● No indication at all	—	Power supply OFF or miswiring between receiving unit and indoor unit
Operation Timer Ready ☼ ● ● Flash	E01	Receiving error } Receiving unit } Sending error } Miswiring or wire connection error Communication stop } between receiving unit and indoor unit
	E02	
	E03	
	Duplicated indoor unit No. } Duplicated master units of remote controller } Setup error	E08
		E09
	E10	Communication error between CPUs on indoor unit P.C. board
E18	Wire connection error between indoor units, Indoor power OFF (Communication stop between indoor master and follower or between main and sub indoor twin)	
Operation Timer Ready ● ● ☼ Flash	E04	Miswiring between indoor unit and outdoor unit or connection error (Communication stop between indoor and outdoor units)
Operation Timer Ready ● ☼ ☼ Alternate flash	P10	Overflow was detected. } Indoor DC fan error } Protective device of indoor unit worked.
	P12	
Operation Timer Ready ☼ ● ☼ Alternate flash	P03	Outdoor unit discharge temp. error } Protective device of outdoor unit worked. *1
	P05	Negative phase detection error } Outdoor unit error
	P19	4-way valve system error (Indoor or outdoor unit judged.)
	Outdoor unit: Outdoor fan error } Outdoor unit: Inverter Idc operation } Outdoor unit: Position detection error } Protective device of outdoor unit worked. *1	P22
		P26
	P29	
P31	Stopped because of error of other indoor unit in a group (Check codes of E03/L03/L07/L08)	

*1: These are representative examples and the check code differs according to the outdoor unit to be combined.

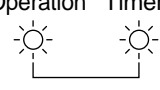
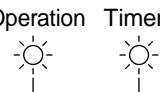
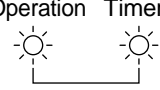
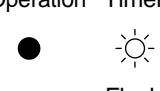
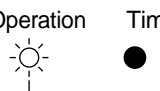
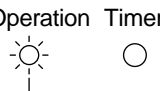
Lamp indication	Check code	Cause of trouble occurrence
Operation Timer Ready  Alternate flash	F01	Heat exchanger sensor (TCJ) error Heat exchanger sensor (TC) error Heat exchanger sensor (TA) error } Indoor unit sensor error
	F02	
	P10	
Operation Timer Ready  Alternate flash	F04	Discharge temp. sensor (TD) error Temp. sensor (TE) error Temp. sensor (TO) error Temp. sensor (TS) error } Sensor error of outdoor unit *1
	F06	
	F08	
	F12	
Operation Timer Ready  Simultaneous flash	F29	Indoor EEPROM error
Operation Timer Ready  Flash	H01	Compressor break down Compressor lock Current detection circuit error } Outdoor compressor system error *1
	H02	
	H03	
Operation Timer Ready  Simultaneous flash	L03	Duplicated master indoor units There is indoor unit of group connection in individual indoor unit. Unsetting of group address Missed setting (Unset indoor capacity) } → AUTO address * If group construction and address are not normal when power supply turned on, automatically goes to address setup mode.
	L07	
	L08	
	L09	
Operation Timer Ready  Simultaneous flash	L20	Duplicated indoor central addresses Outside interlock error Negative phase error } Others
	L30	
	L31	

*1: These are representative examples and the check code differs according to the outdoor unit to be combined.

10-2-7. Others (Other than Check Code)

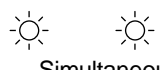
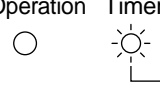
Lamp indication	Check code	Cause of trouble occurrence
Operation Timer Ready  Simultaneous flash	—	During test run
Operation Timer Ready  Alternate flash	—	Disagreement of cool/heat (Automatic cool/heat setting to automatic cool/heat prohibited model, or setting of heating to cooling-only model)

10-2-8. Check Code List (Indoor)

○ : Go on, ◎ : Flash, ● : Go off ALT (Alternate): Alternate flashing when there are two flashing LED SIM (Simultaneous): Simultaneous flashing when there are two flashing LED

(Indoor unit detected)

Check code indication TCC-LINK central & Wired remote controller	Sensor lamp indication				Representative defective position	Explanation of error contents	Air conditioner operation	
	Block indication						Automatic reset	Operation continuation
	Operation	Timer	Ready	Flash				
E03	◎	●	●		Regular communication error between indoor and remote controller	No communication from remote controller and network adapter (Also no communication from central control system)	○	✕
E04	●	●	◎		Indoor/Outdoor serial error	There is error on serial communication between indoor and outdoor units	○	✕
E08	◎	●	●		Duplicated indoor addresses	Same address as yours was detected.	○	✕
E10	◎	●	●		Communication error between indoor MCU	MCU communication error between main motor and micro computer	○	✕
E18	◎	●	●		Regular communication error between indoor master and follower units	Regular communication between indoor master and follower units is impossible, Communication between twin master (main) and follower (sub) units is impossible.	○	✕
F01	◎	◎	●	ALT	Indoor unit, Heat exchanger (TCJ) error	Open/short was detected on heat exchanger (TCJ).	○	✕
F02	◎	◎	●	ALT	Indoor unit, Heat exchanger (TC) error	Open/short was detected on heat exchanger (TC).	○	✕
F10	◎	◎	●	ALT	Indoor unit, Room temp. sensor (TA) error	Open/short was detected on room temp. sensor (TA).	○	✕
F29	◎	◎	●	SIM	Indoor unit, other indoor P.C. board error	EEPROM error (Other error may be detected. If no error, automatic address is repeated.	✕	✕
L03	◎	●	◎	SIM	Duplicated setting of indoor group master unit	There are multiple master units in a group.	✕	✕
L07	◎	●	◎	SIM	There is group cable in individual indoor unit.	When even one group connection indoor unit exists in individual indoor unit.	✕	✕
L08	◎	●	◎	SIM	Unset indoor group address	Indoor group address is unset.	✕	✕
L09	◎	●	◎	SIM	Unset indoor capacity	Capacity of indoor unit is unset.	✕	✕
L20	◎	○	◎	SIM	Duplicated central control system address	Duplicated setting of central control system address	○	✕
L30	◎	○	◎	SIM	Outside error input to indoor unit (Interlock)	Abnormal stop by outside error (CN80) input	✕	✕
P01	●	◎	◎	ALT	Indoor unit, AC fan error	An error of indoor AC fan was detected. (Fan motor thermal relay worked.)	✕	✕
P10	●	◎	◎	ALT	Indoor unit, overflow detection	Float switch worked.	✕	✕
P12	●	◎	◎	ALT	Indoor unit, DC fan error	Indoor DC fan error (Over-current/Lock, etc.) was detected.	✕	✕
P19	◎	●	◎	ALT	4-way valve system error	In heating operation, an error was detected by temp. down of indoor heat exchanger sensor.	○	✕
P31	◎	●	◎	ALT	Other indoor unit error	Follower unit in group cannot operate by warning from [E03/L03/L07/L08] of master unit.	○	✕

◇ When this warning was detected before group construction/address check finish at power supply was turned on, the mode shifts automatically to AUTO address setup mode.

(Remote controller detected)

Check code indication Wired remote controller	Sensor lamp indication				Representative defective position	Explanation of error contents	Air conditioner operation	
	Block indication						Automatic reset	Operation continuation
	Operation	Timer	Ready	Flash				
E01	◎	●	●		No master remote controller, Remote controller communication (Receive) error	Signal cannot be received from indoor unit. Master remote controller was not set. (including 2 remote controllers)	—	—
E02	◎	●	●		Remote controller communication (Send) error	Signal cannot be sent to indoor unit.	—	—
E09	◎	●	●		Duplicated master remote controller	In 2-remote controller control, both were set as master. (Indoor master unit stops warning and follower unit continues operation.)	✕	△

(Central control devices detected)

Check code indication TCC-LINK central	Sensor lamp indication				Representative defective position	Explanation of error contents	Air conditioner operation	
	Block indication						Automatic reset	Operation continuation
	Operation	Timer	Ready	Flash				
C05	Is not displayed. (Common use of remote controller, etc.)				Central control system communication (send) error	Signal sending operation of central control system is impossible. There are multiple same central devices. (AI-NET)	—	—
C06					Central control system communication (receive) error	Signal receiving operation of central control system is impossible.	—	—
C12	—				General-purpose device control interface batched warning	An error on device connected to general-purpose device control interface of exclusive to TCC-LINK/AI-NET	—	—
P30	By warning unit (Above-mentioned)				Group follower unit is defective.	Group follower unit is defective. (For remote controller, above-mentioned [***] details are displayed with unit No.	—	—

NOTE: Even for the same contents of error such as communication error, the display of check code may differ according to detection device. When remote controller or central controller detects an error, it is not necessarily related to operation of the air conditioner. In this list, the check codes that outdoor unit detects are not described.

Check Code List (Outdoor)

○ : Go on, ◎ : Flash, ● : Go off ALT (Alternate): Alternate flashing when there are two flashing LED SIM (Simultaneous): Simultaneous flashing when there are two flashing LED

Remote controller indication	Sensor lamp part				Representative defective position	Detection	Explanation of error contents	Automatic reset	Operation continuation
	Block indication								
	Operation	Timer	Ready	Flash					
F04	◎	◎	○	ALT	Outdoor unit Discharge temp. sensor (TD) error	Outdoor	Open/Short of discharge temp. sensor was detected.	×	×
F06	◎	◎	○	ALT	Outdoor unit Temp. sensor (TE, TS, TL) error	Outdoor	Open/Short of heat exchanger temp. sensor was detected. Miswiring between TE sensor and TS sensor	×	×
F08	◎	◎	○	ALT	Outdoor unit Outside temp. sensor (TO) error	Outdoor	Open/Short of outside temp. sensor was detected.	○	○
F12	◎	◎	○	ALT	Outdoor unit Temp. sensor (TS) error	Outdoor	Open/Short of suction temp. sensor was detected.	×	×
H01	●	◎	●		Outdoor unit Compressor break down	Outdoor	When reached min-Hz by current release control, short-circuited current (Idc) after DC excitation was detected.	×	×
H02	●	◎	●		Outdoor unit Compressor lock	Outdoor	Compressor lock was detected.	×	×
H03	●	◎	●		Outdoor unit Current detection circuit error	Outdoor	Current detection circuit error	×	×
P03	◎	●	◎	ALT	Outdoor unit Discharge temp. error	Outdoor	Error was detected by discharge temp. release control.	×	×
P05	◎	●	◎	ALT	Power supply error	Outdoor	Power supply voltage error	×	×
P22	◎	●	◎	ALT	Outdoor unit Outdoor fan error	Outdoor	Error (Over-current, lock, etc.) was detected on outdoor fan drive circuit.	×	×
P26	◎	●	◎	ALT	Outdoor unit Inverter Idc operation	Outdoor	Short-circuited protective operation of compressor drive circuit element (G-Tr /IGBT) worked.	×	×
P29	◎	●	◎	ALT	Outdoor unit Position detection error	Outdoor	Position detection error of compressor motor was detected.	×	×
E01	◎	●	●		No remote controller master unit Remote controller communication error	Remote controller	Signal was not received from indoor unit. Main remote controller was not set. (including 2 remote controllers)	—	—
E02	◎	●	●		Remote controller send error	Remote controller	Signal cannot be sent to indoor unit.	—	—
E03	◎	●	●		Regular communication error between indoor and remote controller	Indoor	No communication from remote controller and network adapter	○	×
E04	●	●	◎		Indoor/Outdoor serial error	Indoor	Serial communication error between indoor and outdoor	○	×
E08	◎	●	●		Duplicated indoor addresses ◇	Indoor	Same address as yours was detected.	○	×
E09	◎	●	●		Duplicated main remote controllers	Remote controller	In 2-remote controller control, both were set as master. (Indoor master unit stops warning and follower unit continues operation.)	×	×
E10	◎	●	●		Communication error between CPU	Indoor	MCU communication error between main motor and micro computer	○	△
E18	◎	●	●		Regular communication error between master and follower indoor units	Indoor	Regular communication was impossible between master and follower indoor units. Communication between twin master (Main unit) and follower (sub unit) was impossible.	○	×
L03	◎	●	◎	SIM	Duplicated indoor master units ◇	Indoor	There are multiple master units in a group.	×	×
L07	◎	●	◎	SIM	There is group cable in individual indoor unit. ◇	Indoor	When even one group connection indoor unit exists in individual indoor unit	×	×
L08	◎	●	◎	SIM	Unset indoor group address ◇	Indoor	Indoor address group was unset.	×	×
L09	◎	●	◎	SIM	Unset indoor capacity	Indoor	Capacity of indoor unit was unset.	×	×
L30	◎	○	◎	SIM	Outside error input to indoor unit (Interlock)	Indoor	Abnormal stop by CN80 outside error input	×	×
P19	◎	●	◎	ALT	4-way valve inverse error	Indoor Outdoor	In heating operation, error was detected by temp. down of indoor heat exchanger or temp. up of TE, TS.	○	×
F01	◎	◎	●	ALT	Indoor unit Heat exchanger sensor (TCJ) error	Indoor	Open/Short of heat exchanger (TCJ) was detected.	○	×
F02	◎	◎	●	ALT	Indoor unit Heat exchanger sensor (TC) error	Indoor	Open/Short of heat exchanger (TC) was detected.	○	×
F10	◎	◎	●	ALT	Indoor unit Room temp. sensor (TA) error	Indoor	Open/Short of room temp. (TA) was detected.	○	×
F29	◎	◎	●	SIM	Indoor unit Other indoor P.C. board error	Indoor	EEPROM error (Other error may be detected. If no error, automatic address is repeated.	×	×
P01	●	◎	◎	ALT	Indoor unit Indoor fan error	Indoor	Indoor AC fan error was detected. (Fan thermal relay worked.)	×	×
P10	●	◎	◎	ALT	Indoor unit Overflow detection	Indoor	Float switch worked.	×	×
P12	●	◎	◎	ALT	Indoor unit Indoor fan error	Indoor	Indoor fan error (Over-current / Lock, etc.) was detected.	×	×
P31	◎	●	◎	ALT	Other indoor unit error	Indoor	Other indoor under condition of warning in group. E03/L07/L03/L08 warning	○	×
—	By unit with warning No.				ALT	Error in indoor group	Network adapter	Sub remote controller error in a group (Details of remote controller are displayed with unit No. Only central control side is displayed.)	
—	—					LAN system communication error	Network adapter/ Center	Communication error of central control system signal * Is not displayed on the remote controller	
L20	◎	○	◎	SIM	LAN system communication error	Network adapter/ Center	Duplicated indoor address of central control system communication		
—	—					There are multiple communication adapters.	Network adapter	There are multiple communication adapters on remote controller communication line.	

◇ When this warning was detected before group construction/address check finish at power supply was turned on, the mode shifts automatically to AUTO address setup mode.

Error mode detected by indoor unit

Operation of diagnostic function				Judgment and measures
Check code	Cause of operation	Status of air conditioner	Condition	
E03	No communication from remote controller (including wireless) and communication adapter	Stop (Automatic reset)	Displayed when error is detected	1. Check cables of remote controller and communication adapters. • Remote controller LCD display OFF (Disconnection) • Central remote controller [97] check code
E04	The serial signal is not output from outdoor unit to indoor unit. • Miswiring of inter-unit wire • Defective serial sending circuit on outdoor P.C. board • Defective serial receiving circuit on indoor P.C. board	Stop (Automatic reset)	Displayed when error is detected	1. Outdoor unit does not completely operate. • Inter-unit wire check, correction of miswiring • Check outdoor P.C. board. Correct wiring of P.C. board. 2. When outdoor unit normally operates Check P.C. board (Indoor receiving / Outdoor sending).
E08	Duplicated indoor unit address	Stop	Displayed when error is detected	1. Check whether remote controller connection (Group/Individual) was changed or not after power supply turned on (Finish of group construction/Address check). * If group construction and address are not normal when the power has been turned on, the mode automatically shifts to address setup mode. (Resetting of address)
L03	Duplicated indoor master unit			
L07	There is group wire in individual indoor unit.			
L08	Unset indoor group address			
L09	Unset indoor capacity	Stop	Displayed when error is detected	1. Set indoor capacity (DN=11)
L30	Abnormal input of outside interlock	Stop	Displayed when error is detected	1. Check outside devices. 2. Check indoor P.C. board.
P10	Float switch operation • Float circuit, Disconnection, Coming-off, Float switch contact error	Stop	Displayed when error is detected	1. Trouble of drain pump 2. Clogging of drain pump 3. Check float switch. 4. Check indoor P.C. board.
P12	Indoor DC fan error	Stop	Displayed when error is detected	1. Position detection error 2. Over-current protective circuit of indoor fan driving unit operated. 3. Indoor fan locked. 4. Check indoor P.C. board.
P19	4-way valve system error • After heating operation has started, indoor heat exchangers temp. is down.	Stop (Automatic reset)	Displayed when error is detected	1. Check 4-way valve. 2. Check 2-way valve and check valve. 3. Check indoor heat exchanger (TC/TCJ). 4. Check indoor P.C. board.
P31	Own unit stops while warning is output to other indoor units.	Stop (Follower unit) (Automatic reset)	Displayed when error is detected	1. Judge follower unit while master unit is [E03], [L03], [L07] or [L08]. 2. Check indoor P.C. board.
F01	Coming-off, disconnection or short of indoor heat exchanger temp. sensor (TCJ)	Stop (Automatic reset)	Displayed when error is detected	1. Check indoor heat exchanger temp. sensor (TCJ). 2. Check indoor P.C. board.
F02	Coming-off, disconnection or short of indoor heat exchanger temp. sensor (TC)	Stop (Automatic reset)	Displayed when error is detected	1. Check indoor heat exchanger temp. sensor (TC). 2. Check indoor P.C. board.
F10	Coming-off, disconnection or short of indoor heat exchanger temp. sensor (TA)	Stop (Automatic reset)	Displayed when error is detected	1. Check indoor heat exchanger temp. sensor (TA). 2. Check indoor P.C. board.
F29	Indoor EEPROM error • EEPROM access error	Stop (Automatic reset)	Displayed when error is detected	1. Check indoor EEPROM. (including socket insertion) 2. Check indoor P.C. board.
E10	Communication error between indoor MCU • Communication error between fan driving MCU and main MCU	Stop (Automatic reset)	Displayed when error is detected	1. Check indoor P.C. board.
E18	Regular communication error between indoor aster and follower units and between main and sub units	Stop (Automatic reset)	Displayed when error is detected	1. Check remote controller wiring. 2. Check indoor power supply wiring. 3. Check indoor P.C. board.

Error mode detected by remote controller or central controller (TCC-LINK)

Operation of diagnostic function				Judgment and measures
Check code	Cause of operation	Status of air conditioner	Condition	
Not displayed at all (Operation on remote controller is impossible.)	No communication with master indoor unit <ul style="list-style-type: none"> Remote controller wiring is not correct. Power of indoor unit is not turned on. Automatic address cannot be completed. 	Stop	—	Power supply error of remote controller, Indoor EEPROM error <ol style="list-style-type: none"> Check remote controller inter-unit wiring. Check remote controller. Check indoor power wiring. Check indoor P.C. board. Check indoor EEPROM. (including socket insertion) → Automatic address repeating phenomenon generates.
E01 *2	No communication with master indoor unit <ul style="list-style-type: none"> Disconnection of inter-unit wire between remote controller and master indoor unit (Detected by remote controller side) 	Stop (Automatic reset) * If center exists, operation continues.	Displayed when error is detected	Receiving error from remote controller <ol style="list-style-type: none"> Check remote controller inter-unit wiring. Check remote controller. Check indoor power wiring. Check indoor P.C. board.
E02	Signal send error to indoor unit (Detected by remote controller side)	Stop (Automatic reset) * If center exists, operation continues.	Displayed when error is detected	Sending error of remote controller <ol style="list-style-type: none"> Check sending circuit inside of remote controller. → Replace remote controller.
E09	There are multiple main remote controllers. (Detected by remote controller side)	Stop (Sub unit continues operation.)	Displayed when error is detected	<ol style="list-style-type: none"> In 2-remote controllers (including wireless), there are multiple main units. Check that there are 1 main remote controller and other sub remote controllers.
L20 ----- Central controller L20	Duplicated indoor central addresses on communication of central control system (Detected by indoor/central controller side)	Stop (Automatic reset)	Displayed when error is detected	<ol style="list-style-type: none"> Check setting of central control system network address. (Network adapter SW01) Check network adapter P.C. board.
----- *3 ----- Central controller (Send) C05 (Receive) C06	Communication circuit error of central control system (Detected by central controller side)	Continues (By remote controller)	Displayed when error is detected	<ol style="list-style-type: none"> Check communication wire / miswiring Check communication (U3, U4 terminals) Check network adapter P.C. board. Check central controller (such as central control remote controller, etc.) Check terminal resistance. (TCC-LINK)
----- Central controller P30	Indoor Gr sub unit error (Detected by central controller side)	Continuation/Stop (According to each case)	Displayed when error is detected	Check the check code of the corresponding unit from remote controller.

*2 The check code cannot be displayed by the wired remote controller.
(Usual operation of air conditioner becomes unavailable.)
For the wireless models, an error is notified with indication lamp.

*3 This trouble is related to communication of remote controller (A, B), central system (TCC-LINK U3, U4), and [E01], [E02], [E03], [E09] or [E18] is displayed or no check display on the remote controller according to the contents.

Error mode detected by outdoor unit

Operation of diagnostic function				Judgment and measures
Check code	Cause of operation	Status of air conditioner	Condition	
F04	Disconnection, short of discharge temp. sensor (TD)	Stop	Displayed when error is detected	1. Check discharge temp. sensor (TD). 2. Check outdoor P.C. board.
F06	Disconnection, short of outdoor temp. sensor (TE)	Stop	Displayed when error is detected	1. Check temp. sensor (TE). 2. Check outdoor P.C. board.
F12	Disconnection, short of suction temp. sensor (TS)	Stop	Displayed when error is detected	1. Check suction temp. sensor (TS). 2. Check outdoor P.C. board.
F08	Disconnection, short of outside temp. sensor (TO)	Continue	Displayed when error is detected	1. Check outside temp. sensor (TO). 2. Check outdoor P.C. board.
P19	4-way valve inverse error * After heating operation has started, indoor heat exchanger temp. lowers under the specified temp. * After heating operation has started, outdoor heat exchanger / suction temp. rises over the specified temp.	Stop	Displayed when error is detected	1. Check operation of 4-way valve. 2. Check outdoor heat exchanger (TE), suction temp. sensor (TS). 3. Check indoor heat exchanger sensor (TC). 4. Check 4-way valve coil. 5. Check PMV (Pulse Motor Valve).
H01	Compressor break down * Although operation has started, operation frequency decreases and operation stops.	Stop	Displayed when error is detected	1. Check power supply voltage. (AC198 to 264V) 2. Overload operation of refrigerating cycle
H02	Compressor lock * Over-current detection after compressor start-up	Stop	Displayed when error is detected	1. Trouble of compressor (Lock, etc.): Replace compressor. 2. Wiring error of compressor (Open phase)
H03	Current detection circuit error	Stop	Displayed when error is detected	1. Check outdoor P.C. board. (AC current detection circuit)
P03	Discharge temp. error * Discharge temp. (TD) over specified value was detected.	Stop	Displayed when error is detected	1. Check refrigerating cycle (Gas leak) 2. Trouble of electronic expansion valve 3. Check discharge temp. sensor (TD).
P05	Power supply voltage error	Stop	Displayed when error is detected	1. Check power supply voltage. AC198 to 264V
P22	Outdoor fan system error	Stop	Displayed when error is detected	1. Check lock of fan motor. 2. Check power supply voltage. AC198 to 264V 3. Check outdoor P.C. board.
P26	Short-circuit error of compressor driving element	Stop	Displayed when error is detected	1. When performing operation while taking-off compressor wire, P26 error occurs. Check control P.C. board. 2. When performing operation while taking-off compressor wire, an error does not occur. (Compressor rare short)
P29	Position detection circuit error	Stop	Displayed when error is detected	1. Check control P.C. board.

10-2-9. Diagnostic Procedure for Each Check Code (Indoor Unit)

Check code

[E01 error]

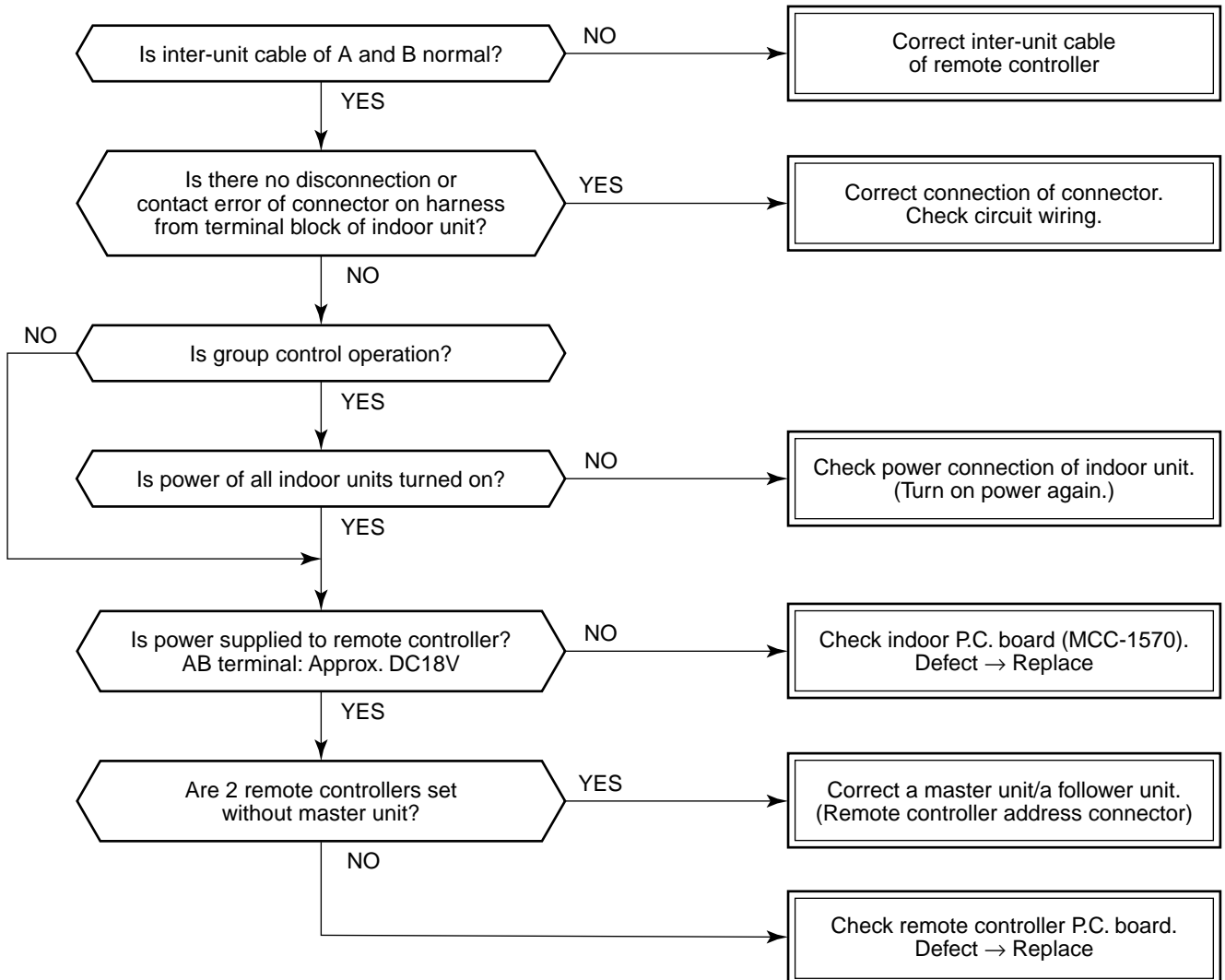

[E09 error]

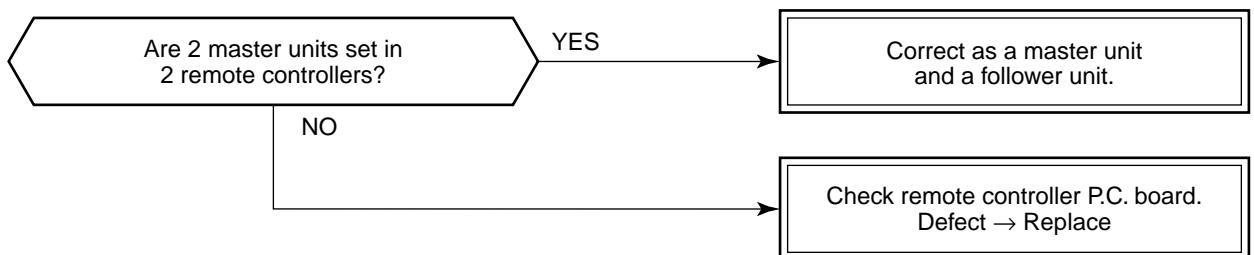

[E04 error]

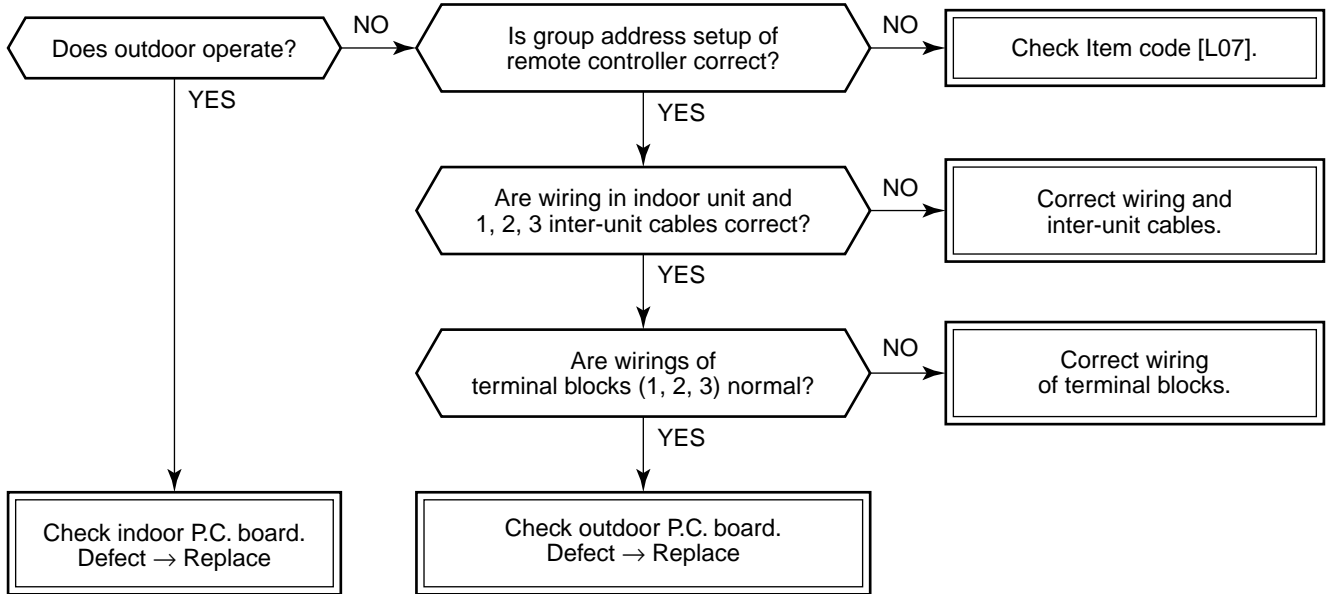

[E10 error]

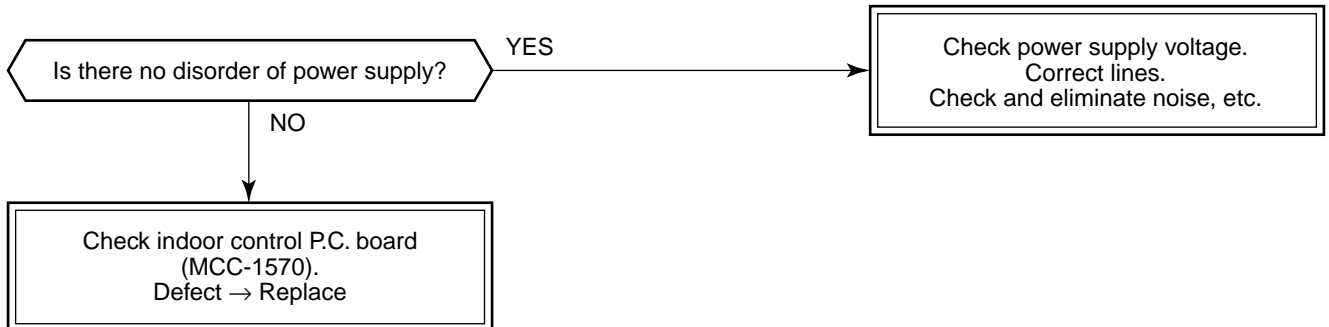

[E18 error]

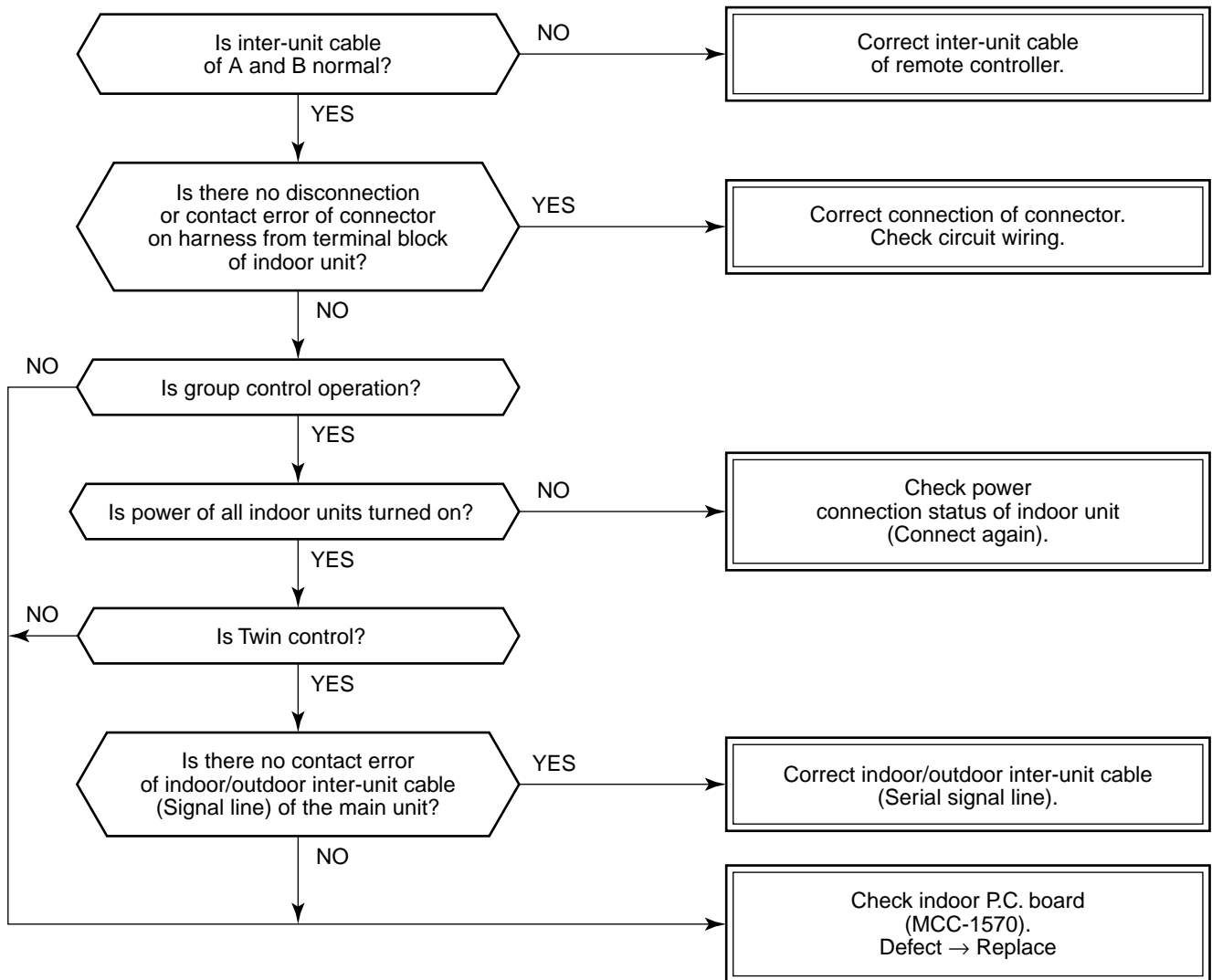

[E08, L03, L07, L08 error]

E08: Duplicated indoor unit No.

L03: There are 2 or more master units in a group control.

L07: There is 1 or more group address [Individual] in a group control.

L08: The indoor group address is unset. **(13. ADDRESS SETUP)**

If the above error is detected when power supply turned on, the mode enters automatically in the automatic address set mode. (Check code is not output.)

However, if the above error is detected during the automatic address set mode, a check code may be output.

[L09 error]

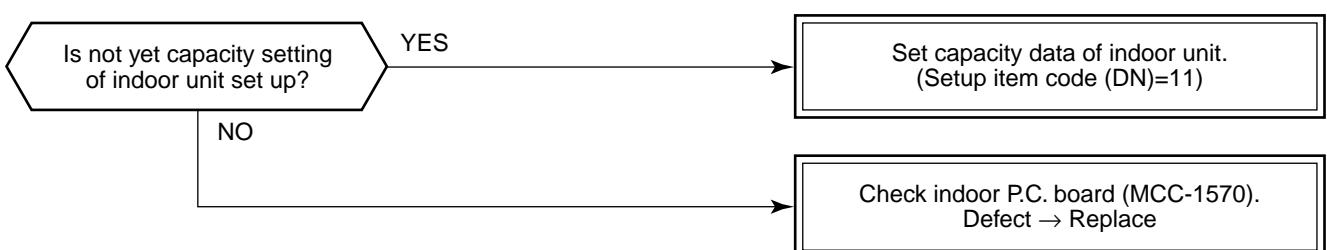

[L20 error]

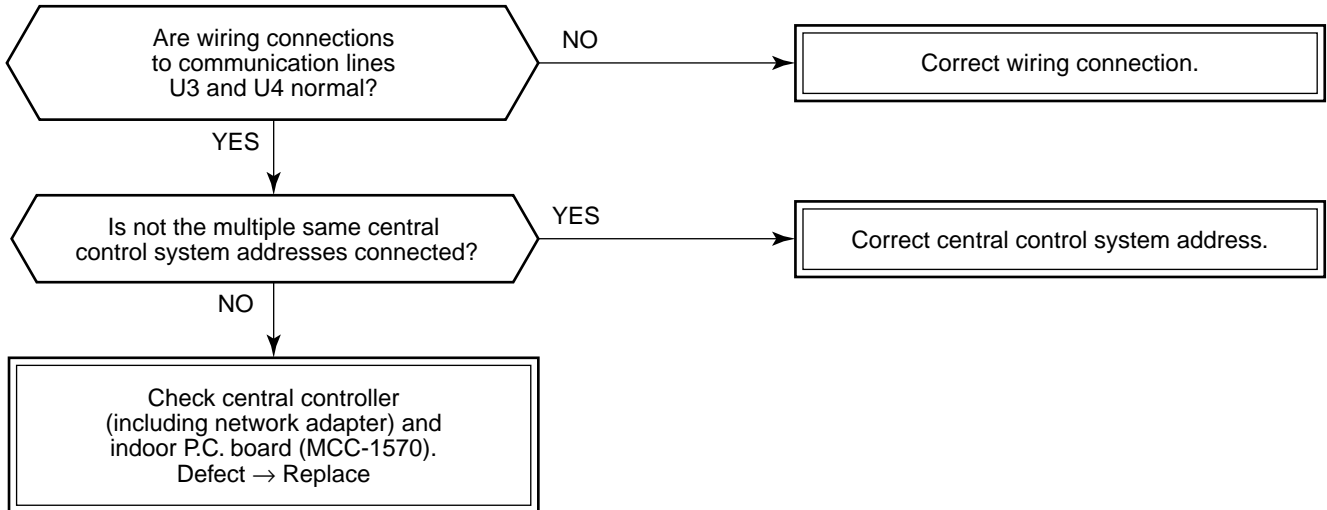

[L30 error]

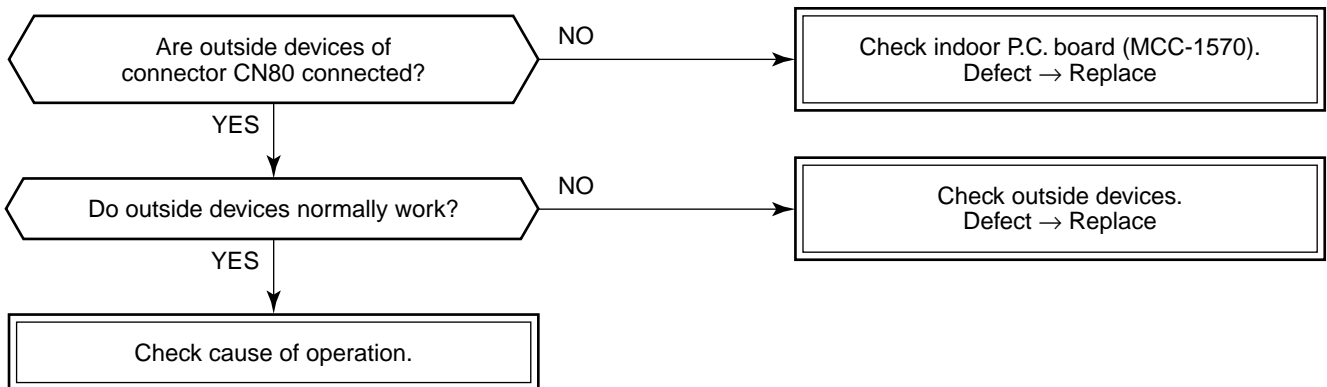

[P30 error] (Central controller)

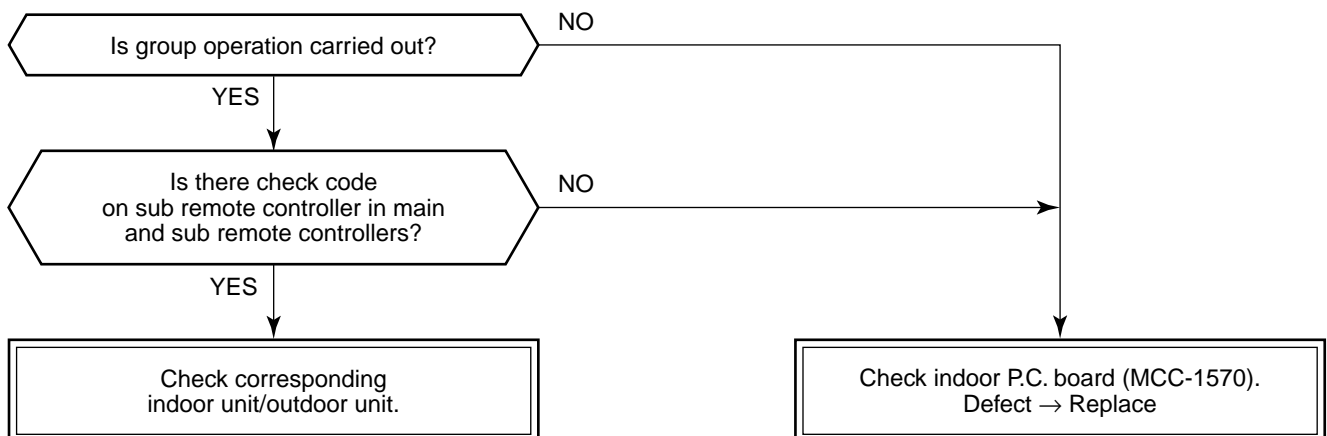

[P10 error]

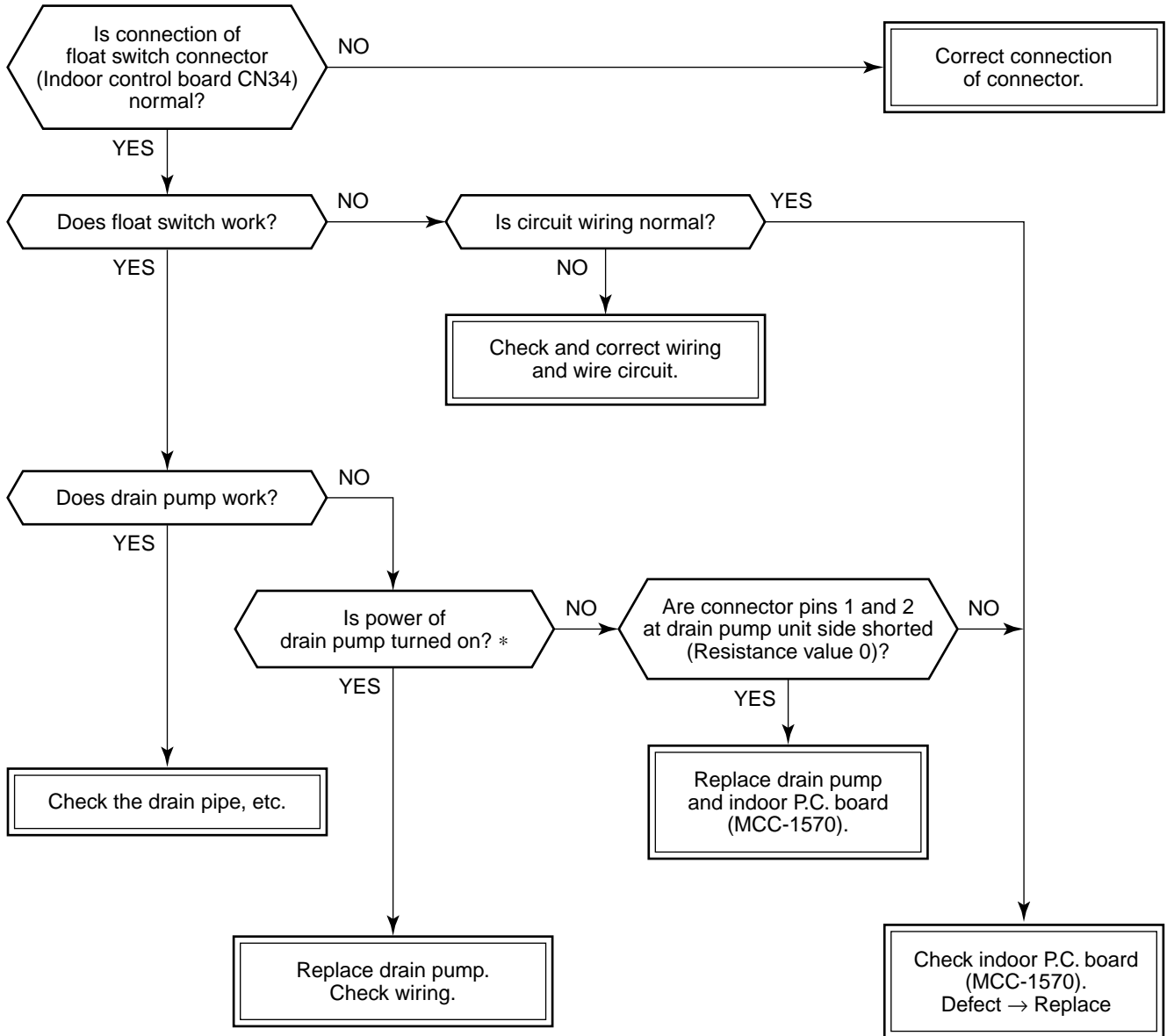

* Check that voltage of 1-2 pin of CN504 on the indoor P.C. board is +12V. (1 pin is plus (+).)

[F10 error]

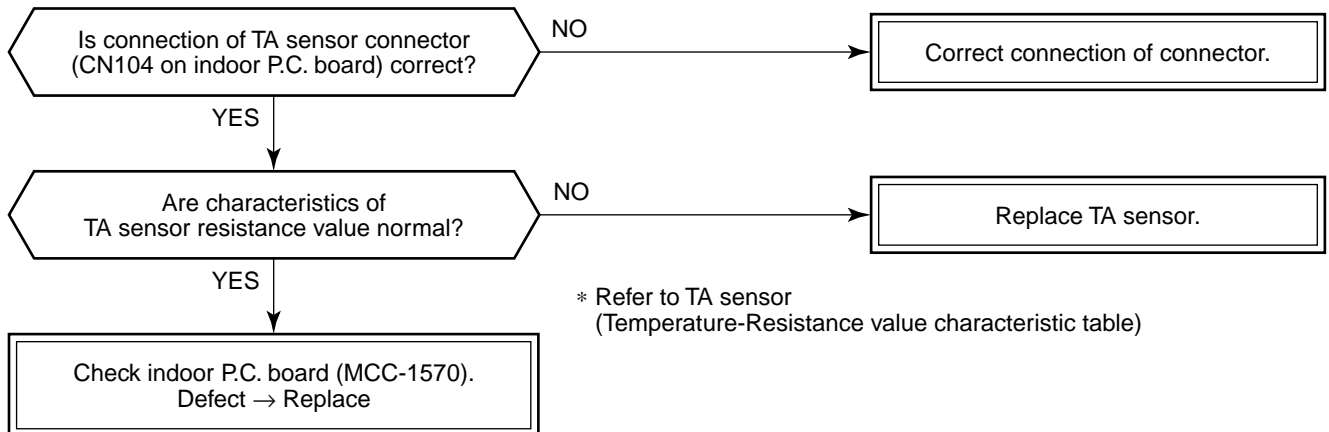

* Refer to TA sensor (Temperature-Resistance value characteristic table)

[P12 error]

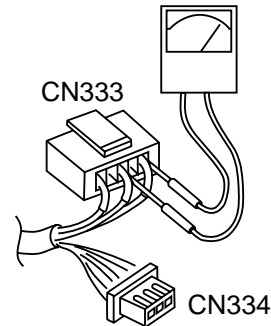
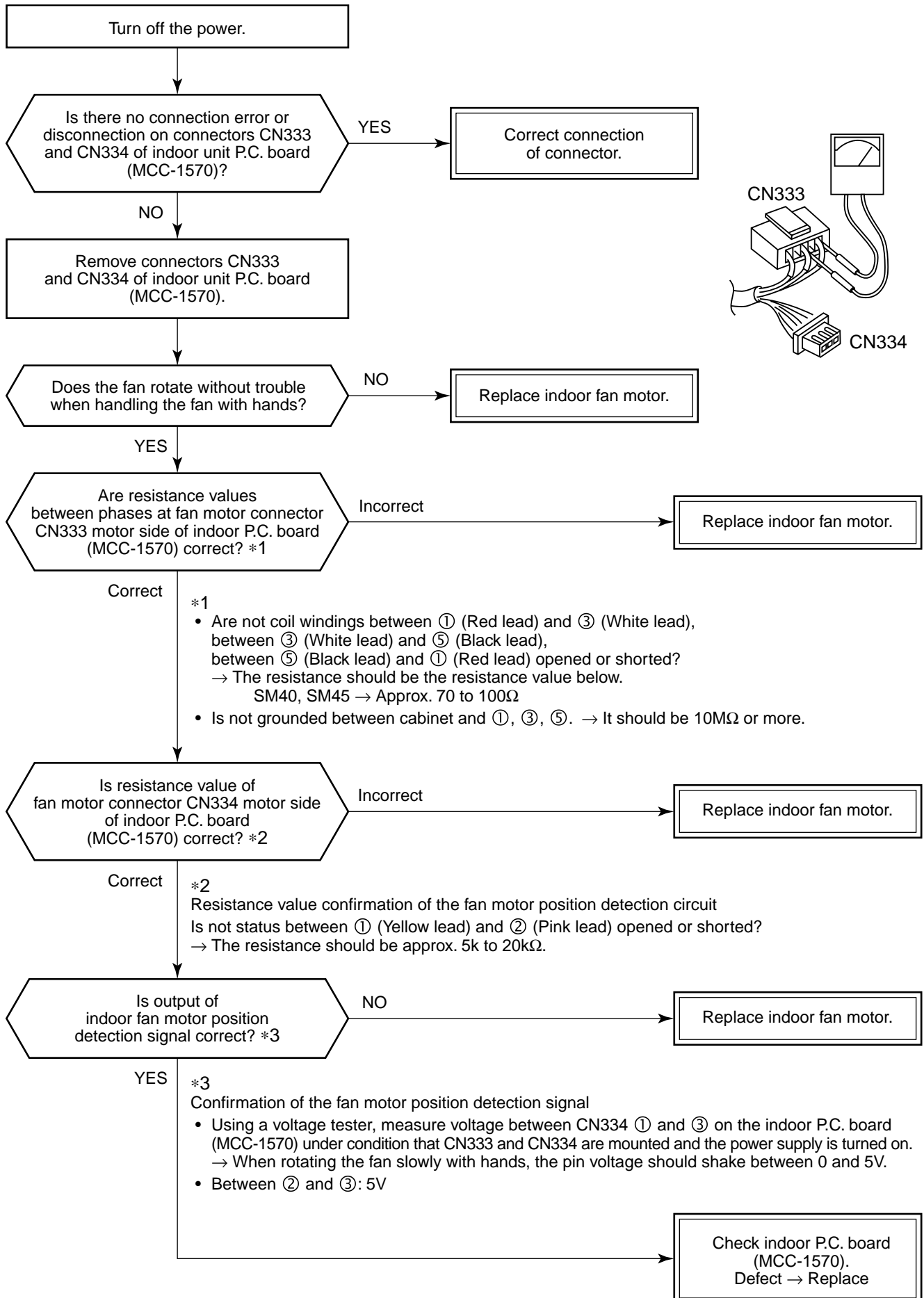

[F02 error]

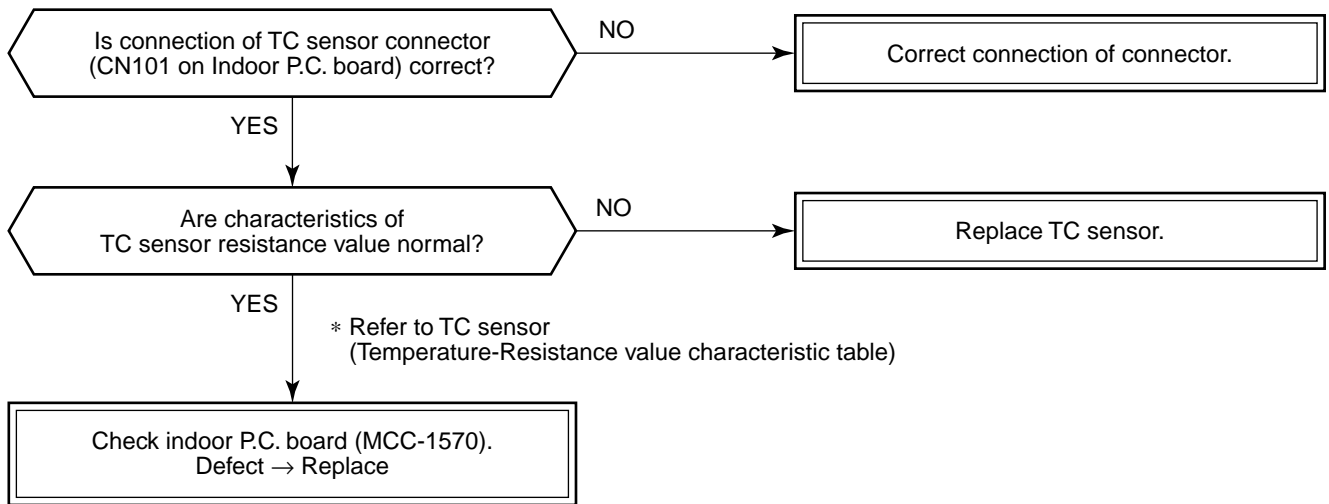

[F01 error]

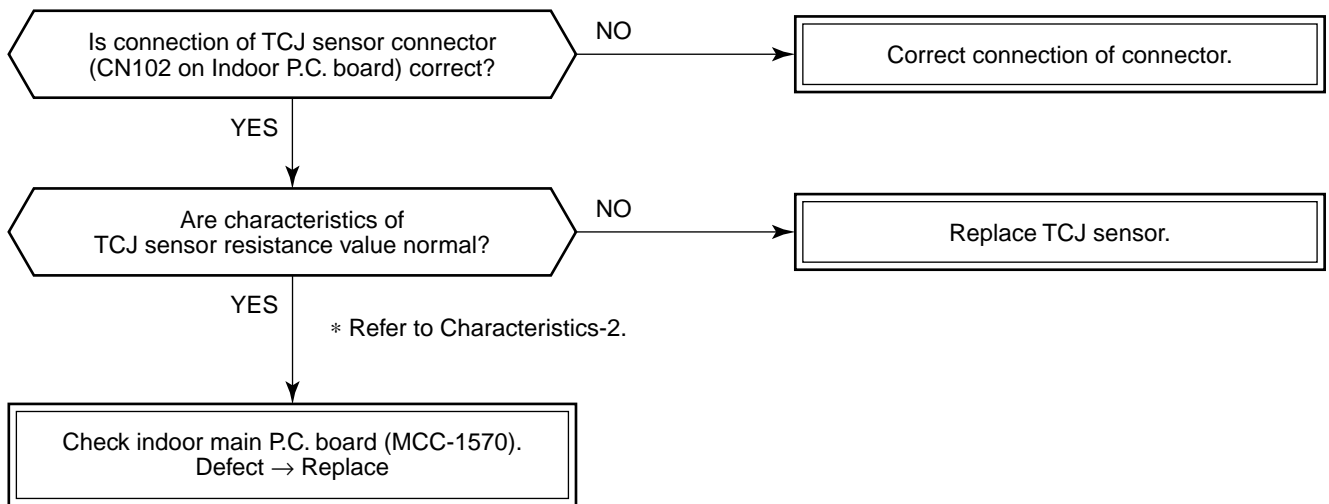

[C06 error] (TCC-LINK central controller)

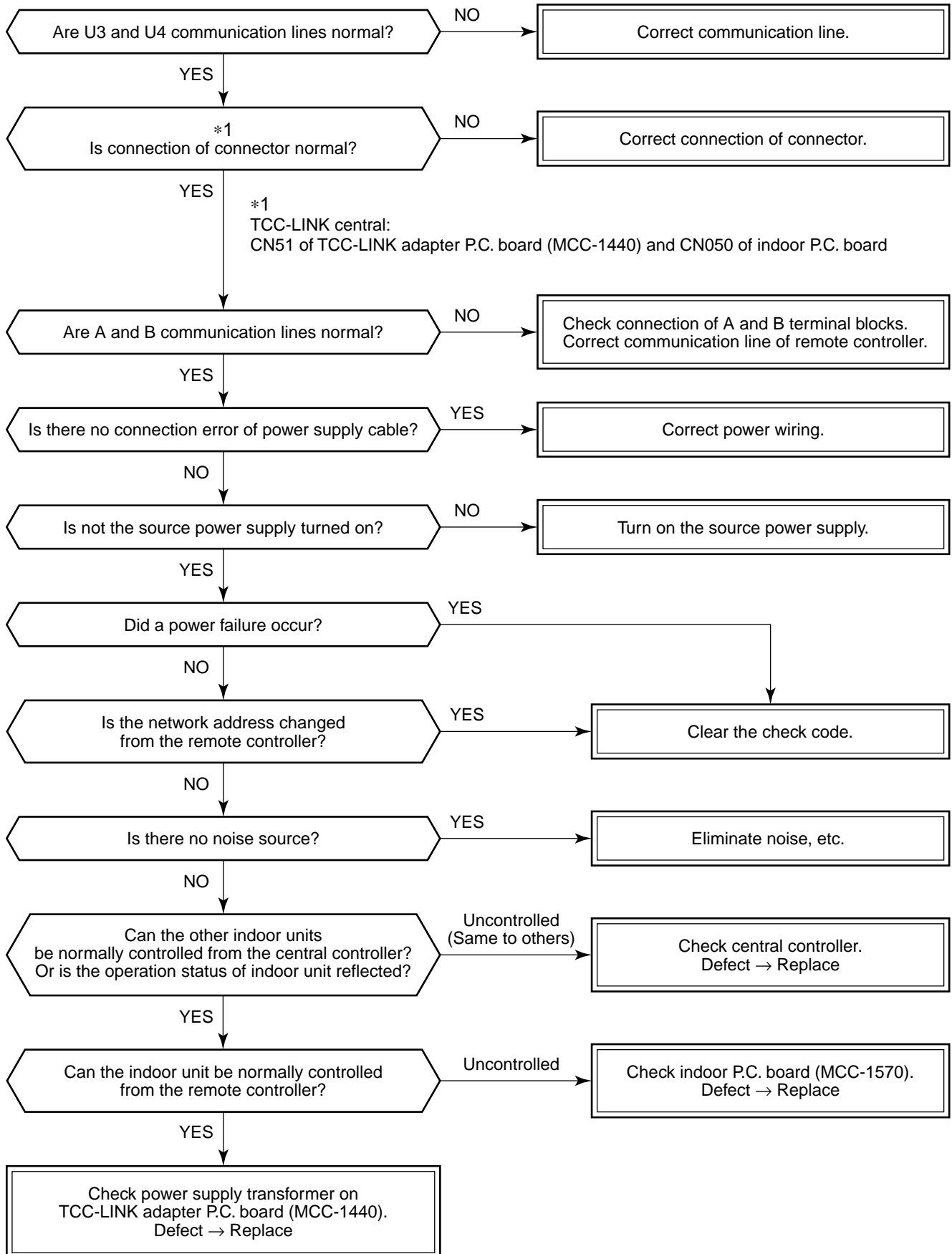

[E03 error] (Master indoor unit)

[E03 error] is detected when the indoor unit cannot receive a signal from the remote controller (also central controller).

Check A and B remote controllers and communication lines of the central control system U3 and U4.

As communication is impossible, this check code [E03] is not displayed on the remote controller and the central controller. [E01] is displayed on the remote controller and [C06 error] is displayed on the central controller.

If these check codes generate during operation, the air conditioner stops.

[F29 error]

This check code indicates a detection error of IC10 non-volatile memory (EEPROM) on the indoor unit P.C. board, which generated during operation of the air conditioner. Replace the service P.C. board.

* When EEPROM was not inserted when power supply turned on or when the EEPROM data read/write operation is impossible at all, the automatic address mode is repeated. In this time, [97 error] is displayed on the central controller.

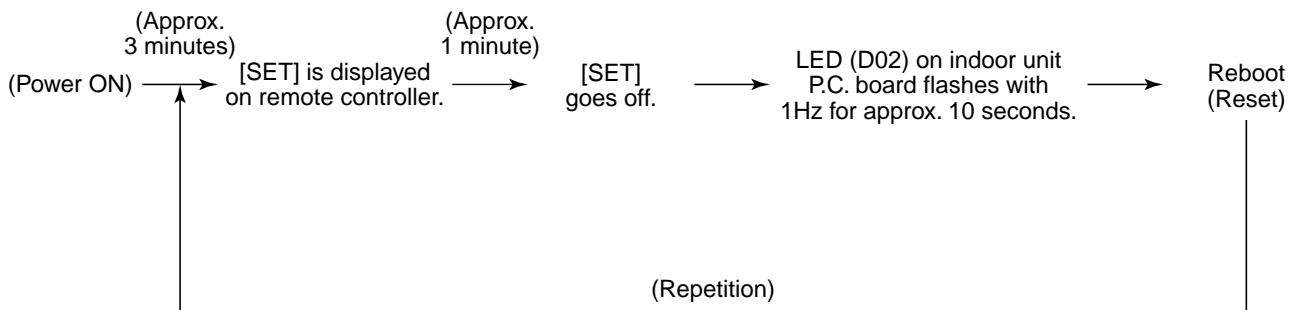

[P31 error] (Follower indoor unit)

When the master unit of a group operation detected [E03], [L03], [L07] or [L08] error, the follower unit of the group operation detects [P31 error] and then the unit stops.

There is no display of the check code or alarm history of the remote controller. (In this model, the mode enters in automatic address set mode when the master unit detected [L03], [L07] or [L08] error.)

10-2-10. Diagnostic Procedure for Each Check Code (Outdoor Unit)

- This section describes the diagnostic method for each check code displayed on the remote controller. In some cases, a check code indicates multiple symptoms.

Check code	Check and troubleshooting (Item without special mention indicates part of outdoor unit.)
[E04]	<p>[Indoor/Outdoor communication error]</p> <pre> graph TD Q1{{Is setting of group address of remote controller correct?}} -- NO --> A1[Check Item code [14].] Q1 -- YES --> Q2{{Are inner wiring and inter-unit cables (1, 2, 3) normal?}} Q2 -- NO --> A2[Correct wiring and inter-unit cable.] Q2 -- YES --> Q3{{Is wiring of terminal blocks (1, 2, 3) normal?}} Q3 -- NO --> A3[Correct wiring of terminal blocks.] Q3 -- YES --> A4[Check outdoor P.C. board. Defect -> Replace] </pre>
[F04]	<p>[Discharge temp. sensor (TD) error]</p> <pre> graph TD Q1{{Is CN601 connection normal? Is resistance value of TD sensor normal?}} -- NO --> A1[Correct connector. Sensor error -> Replace] Q1 -- YES --> A2[Check outdoor P.C. board. Defect -> Replace] </pre>
[F06]	<p>[Heat exchanger temp. sensor (TE) error]</p> <pre> graph TD Q1{{Is CN600 connection normal? Is resistance value of TE sensor normal?}} -- NO --> A1[Correct connector. Sensor error -> Replace] Q1 -- YES --> A2[Check outdoor P.C. board. Defect -> Replace] </pre>
[F08]	<p>[Outside air temp. sensor (TO) error]</p> <pre> graph TD Q1{{Is CN602 connection normal? Is resistance value of TO sensor normal?}} -- NO --> A1[Correct connector. Sensor error -> Replace] Q1 -- YES --> A2[Check outdoor P.C. board. Defect -> Replace] </pre>

Check code	Check and troubleshooting (Item without special mention Indicates part of outdoor unit.)
[F12]	<p>[Suction temp. sensor (TS) error]</p> <pre> graph TD Q1{{Is CN603 connection normal? Is resistance value of TS sensor normal?}} A1[Correct connector. Sensor error → Replace] A2[Check outdoor P.C. board. Defect → Replace] Q1 -- NO --> A1 Q1 -- YES --> A2 </pre>
[H01]	<p>[Compressor break down]</p> <pre> graph TD Q1{{Is power supply voltage normal? AC198 to 264V}} A1[Correct power supply line.] Q2{{Is wire connection normal? Compressor lead (Board side, Compressor side), Reactor lead, Power supply lead}} A2[Check wire connection and correct it.] Q3{{Is it not abnormal overload?}} A3[Correct and clear the cause.] A4[Check outdoor P.C. board. Defect → Replace] Q1 -- NO --> A1 Q1 -- YES --> Q2 Q2 -- NO --> A2 Q2 -- YES --> Q3 Q3 -- YES --> A3 Q3 -- NO --> A4 </pre>
[H02]	<p>[Compressor lock]</p> <pre> graph TD Q1{{Is power supply voltage normal? AC198 to 264V}} A1[Correct power supply line.] Q2{{Is wire connection normal? Compressor lead (Board side, Compressor side), Reactor lead, Power supply lead}} A2[Check wire connection and correct it.] Q3{{Is compressor normal?}} A3[Check outdoor P.C. board. Defect → Replace] Q4{{Is there no refrigerant stagnation?}} A4[Compressor lock → Replace] Q5{{Does PMV normally operate?}} A5[Check TE, TS sensors and PMV. Defect → Replace] A6[Check outdoor P.C. board. Defect → Replace] Q1 -- NO --> A1 Q1 -- YES --> Q2 Q2 -- NO --> A2 Q2 -- YES --> Q3 Q3 -- YES --> A3 Q3 -- NO --> Q4 Q4 -- NO --> A4 Q4 -- YES --> Q5 Q5 -- NO --> A5 Q5 -- YES --> A6 </pre>
[H03]	<p>[Current detection circuit error]</p> <pre> graph TD A1[Check outdoor P.C. board. Defect → Replace] A1 </pre>

Check code	Check and troubleshooting (Item without special mention Indicates part of outdoor unit.)
<p>[P03]</p>	<p>[Discharge temp. error]</p> <pre> graph TD Q1{{"Is there no gas leak? Is refrigerant charge amount adequate?"}} -- NO --> A1[Repair defective position. Recharge refrigerant.] Q1 -- YES --> Q2{{"Is PMV normal?"}} Q2 -- NO --> A2[Repair defective position. Replace defective part.] Q2 -- YES --> Q3{{"Is it not abnormal overload?"}} Q3 -- YES --> A3[Correct and clear the cause.] Q3 -- NO --> Q4{{"Is CN601 connection normal? Is resistance value of TD sensor normal?"}} Q4 -- NO --> A4[Correct connector. Sensor error -> Replace] Q4 -- YES --> A5[Check outdoor P.C. board. Defect -> Replace] </pre>
<p>[P05]</p>	<p>[Power supply error (Voltage error)]</p> <pre> graph TD Q1{{"Is there no down or up of power supply voltage? (AC198 to 264V)"}} -- YES --> A1[Confirm electric construction, etc.] Q1 -- NO --> A2[Check outdoor P.C. board. Defect -> Replace] </pre>
<p>[P19]</p>	<p>[4-way valve inverse error]</p> <pre> graph TD Q1{{"Is operation of 4-way valve normal? (Check pipe temp., etc. in cooling/heating operation.)"}} -- YES --> A1["Temperature sensor check TE sensor CN600 TS sensor CN603 Indoor TC sensor Defect -> Correct and repair"] Q1 -- NO --> Q2{{"Is the coil resistance value of 4-way valve between 1.3 and 1.6kΩ?"}} Q2 -- NO --> A2[Replace coil of 4-way valve.] Q2 -- YES --> A3[Check 4-way valve. Defect -> Replace] </pre>

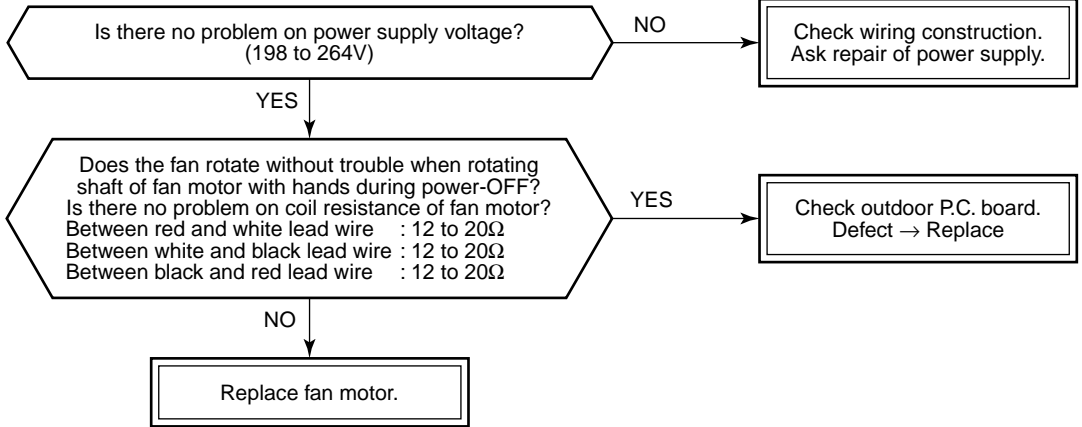
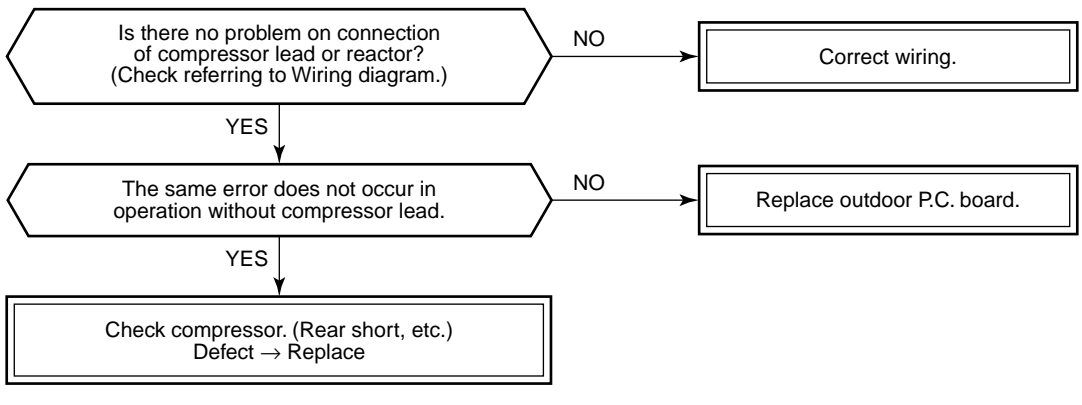
Check code	Check and troubleshooting (Item without special mention Indicates part of outdoor unit.)
[P22]	<p>[Fan system error]</p>  <pre> graph TD Q1{{Is there no problem on power supply voltage? (198 to 264V)}} A1[Check wiring construction. Ask repair of power supply.] Q2{{Does the fan rotate without trouble when rotating shaft of fan motor with hands during power-OFF? Is there no problem on coil resistance of fan motor? Between red and white lead wire : 12 to 20Ω Between white and black lead wire : 12 to 20Ω Between black and red lead wire : 12 to 20Ω}} A2[Check outdoor P.C. board. Defect → Replace] A3[Replace fan motor.] Q1 -- NO --> A1 Q1 -- YES --> Q2 Q2 -- YES --> A2 Q2 -- NO --> A3 </pre>
[P26]	<p>[Short-circuit of compressor drive element]</p>  <pre> graph TD Q1{{Is there no problem on connection of compressor lead or reactor? (Check referring to Wiring diagram.)}} A1[Correct wiring.] Q2{{The same error does not occur in operation without compressor lead.}} A2[Replace outdoor P.C. board.] A3[Check compressor. (Rear short, etc.) Defect → Replace] Q1 -- NO --> A1 Q1 -- YES --> Q2 Q2 -- NO --> A2 Q2 -- YES --> A3 </pre>
[P29]	<p>[Position detection circuit error]</p> <p>Check outdoor P.C. board. Defect → Replace</p>
— No code	<p>[Other error] Compressor disorder due to sudden change of load, etc. * LED display also may output due to negative phase of compressor or wire coming-off.</p>

Temperature sensor Temperature – Resistance value characteristic table

T A, T C, T CJ, T E, T S, T O sensors

T D, T L sensors

Representative value

Representative value

T emperature (°C)	Resistance value (kΩ)		
	(Minimum value)	(Standard value)	(Maximum value)
0	32.33	33.80	35.30
10	19.63	20.35	21.09
20	12.23	12.59	12.95
25	9.75	10.00	10.25
30	7.764	7.990	8.218
40	5.013	5.192	5.375
50	3.312	3.451	3.594
60	2.236	2.343	2.454
70	1.540	1.623	1.709
80	1.082	1.146	1.213
90	0.7740	0.8237	0.8761
100	0.5634	0.6023	0.6434

T emperature (°C)	Resistance value (kΩ)		
	(Minimum value)	(Standard value)	(Maximum value)
0	150.5	161.3	172.7
10	92.76	99.05	105.6
20	58.61	62.36	66.26
25	47.01	49.93	52.97
30	37.93	40.22	42.59
40	25.12	26.55	28.03
50	17.00	17.92	18.86
60	11.74	12.34	12.95
70	8.269	8.668	9.074
80	5.925	6.195	6.470
90	4.321	4.507	4.696
100	3.205	3.336	3.468

T A, T C, T CJ, T E, T S, T O sensors

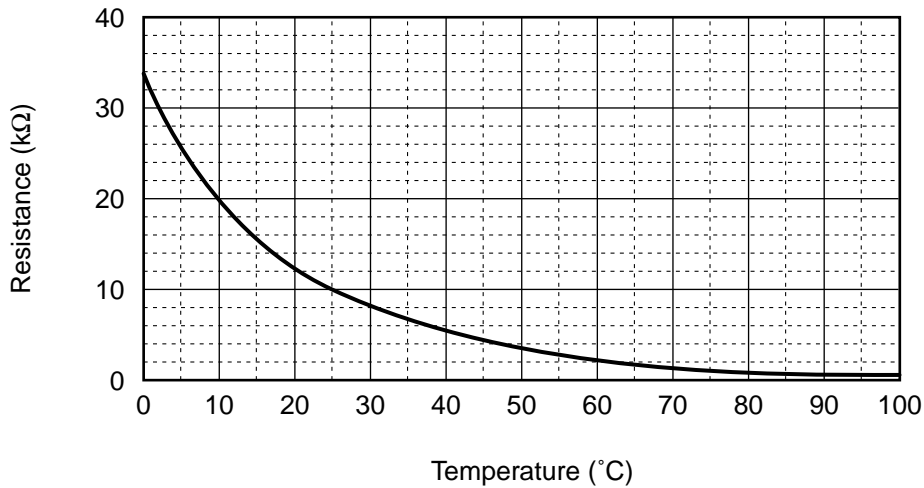

T D, T L sensors

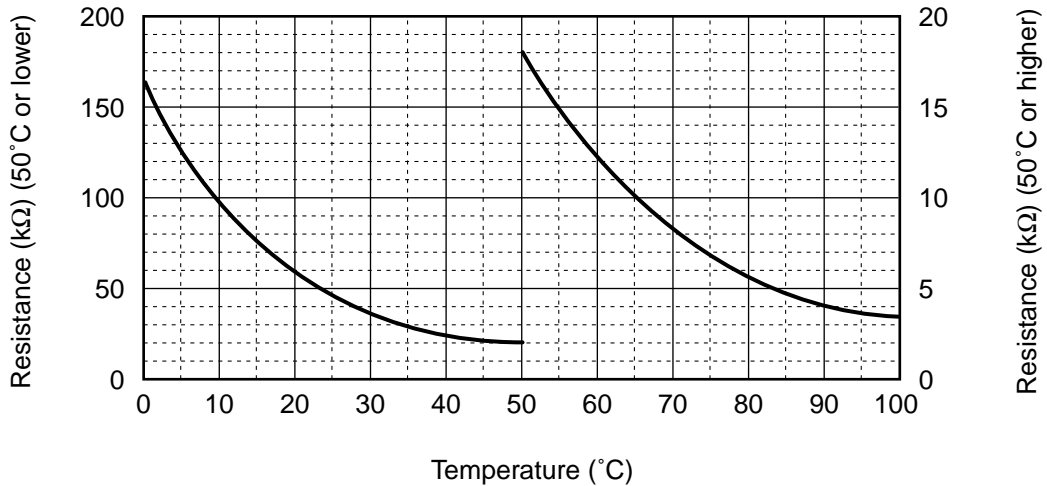

* As TH sensor (Outdoor unit heat sink temp. sensor) is incorporated in the outdoor control P.C. board, the resistance value cannot be measured.

11. REPLACEMENT OF SERVICE P.C. BOARD

11-1. Indoort Unit

<Note: when replacing the P.C. board for indoor unit servicing>

The nonvolatile memory (hereafter called EEPROM, IC503) on the indoor unit P.C. board before replacement includes the model specific type information and capacity codes as the factory-set value and the important setting data which have been automatically or manually set when the indoor unit is installed, such as system/indoor/group addresses, high ceiling select setting, etc.

When replacing the P.C. board for indoor unit servicing, follow the procedures below.

After replacement completes, confirm whether the settings are correct by checking the indoor unit No., Group header unit/follower unit settings and perform the cooling cycle confirmation through the trial operation.

<Replacement procedures>

CASE 1

Before replacement, the indoor unit can be turned on and the setting data can be read out by wired remote control operation.

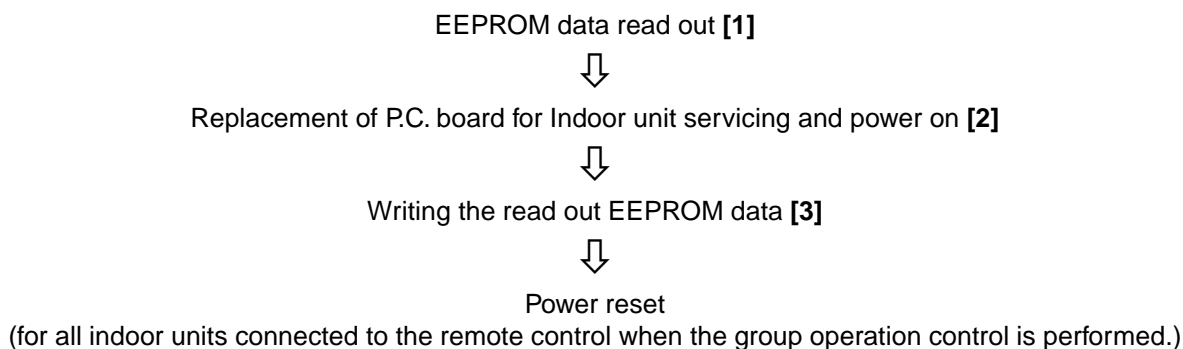





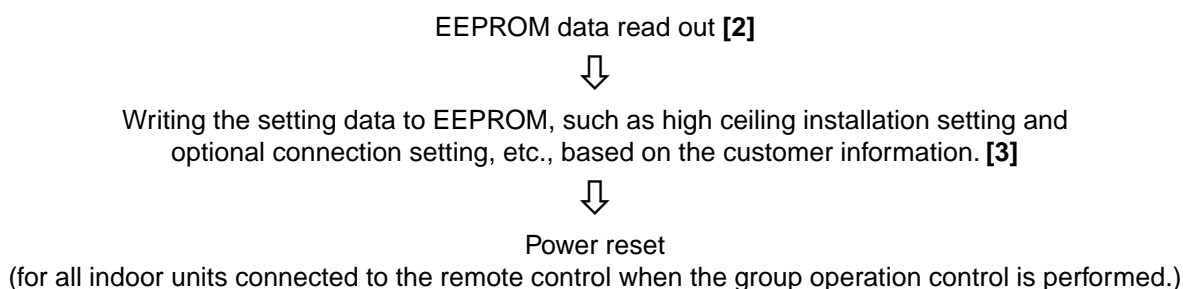



CASE 2

The EEPROM before replacement is defective and the setting data cannot be read out.



[1] Setting data read out from EEPROM

The setting data modified on the site, other than factory-set value, stored in the EEPROM shall be read out.



- Step 1** Push ,  and  button on the remote controller simultaneously for more than 4 seconds.
- * When the group operation control is performed, the unit No. displayed for the first time is the header unit No. At this time, the CODE No. (DN) shows "10". Also, the fan of the indoor unit selected starts its operation and the swing operation also starts if it has the louvers.
- Step 2** Every time when the  button is pushed, the indoor unit No. under the group control is displayed in order. Specify the indoor unit No. to be replaced.
1. **Change the CODE No. (DN) to 10 → 01 by pushing  /  buttons for the temperature setting. (this is the setting for the filter sign lighting time.)**
At this time, be sure to write down the setting data displayed.
 2. Change the CODE No. (DN) by pushing  /  buttons for the temperature setting. Similarly, be sure to write down the setting data displayed.
 3. Repeat the step 2-2 to set the other settings in the same way and write down the setting data as shown in the table 1 (example).
 * The CODE No. (DN) are ranged from "01" to "FF". The CODE No. (DN) may skip.
- Step 3** After writing down all setting data, push  button to return to the normal stop status. (It takes approx. 1 min until the remote controller operation is available again.)

CODE No. required at least

DN	Contents
10	Type
11	Indoor unit capacity
12	System address
13	Indoor unit address
14	Group address

1. The CODE No. for the Indoor unit type and Indoor unit capacity are required to set the rotation number setting of the fan.
2. If the system/indoor/group addresses are different from those before replacement, the auto-address setting mode starts and the manual resetting may be required again. (when the multiple units group operation including twin system.)

[2] P.C. Board for indoor unit servicing replacement procedures

- Step 1** Replace the P.C. board to the P.C. board for indoor unit servicing.
 At this time, perform the same setting of the jumper wire (J01) setting (cut), switch SW501, (short-circuit) connector CN34 as the setting of the P.C. board before replacement.
- Step 2** According to the system configuration, turn on the indoor unit following to the either methods shown below.
- a) Single operation (Indoor unit is used as standalone.)
 Turn on the indoor unit.
 1. After completion of the auto-address setting mode (required time: approx. 5 min.), proceed to [3]. (System address = 1, Indoor unit address = 1, Group address = 0 (standalone) are automatically set.)
 2. Push ,  and  buttons simultaneously for more than 4 seconds to interrupt the auto-address setting mode, and proceed to [3]. (The unit No. "ALL" is displayed.)
 - b) Group operation (including twin system)
 Turn on the indoor unit(s) with its P.C. board replaced to the P.C. board for indoor unit servicing, according to either methods 1 or 2 shown below.
 1. Turn on only the indoor unit with its P.C. board replaced. (Be sure to confirm the remote controller is surely connected. If not, the operation [3] cannot be performed.)
 Perform either methods 1 or 2 described in item a) above.
 2. Turn on the multiple indoor units including the indoor unit with its P.C. board replaced.
 - Twin 1 system only
 - All group connections

After completion of the auto-address setting mode (required time: approx. 5 min.), proceed to [3].

- * The header unit of the group may be changed by performing the auto-address setting. Also, the system address/Indoor unit address of the indoor unit with its P.C. board replaced may be assigned to the addresses (not used) other than those of the indoor units without its P.C. board replaced. It is recommended to keep the information in advance, which cooling system the indoor unit belongs to or whether the indoor unit works as the header unit or the follower unit in the group control operation.

Setting 4-way air discharge cassette Indoor Unit model only

1. Using the set temperature ∇ / \blacktriangle buttons, set “ LE ” to the CODE No. (DN).
2. Using the timer time ∇ / \blacktriangle buttons, set the data. (0001)

- Push SET button. (The setting completes if the setting data are displayed.)

<In case of 4-way Discharge Cassette type>

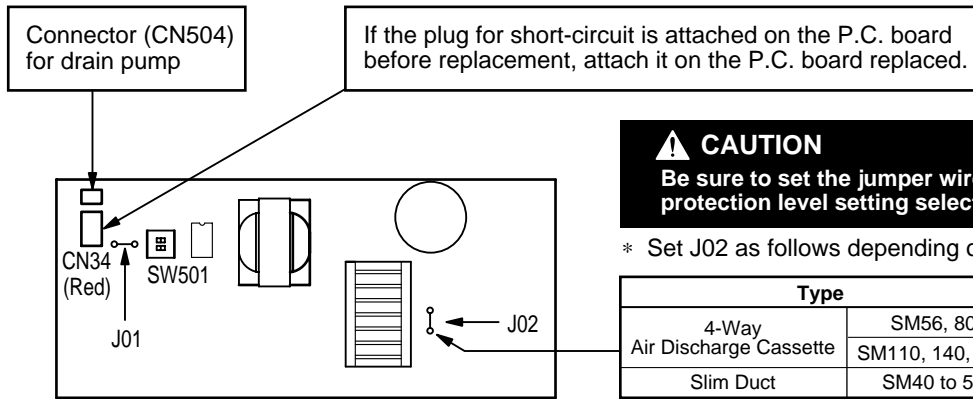

<In case of Slim Duct type>

- As P.C. board of the Slim Duct type differs from that of the 4-way Discharge Cassette type, selection by HP is unnecessary.
- Push the TEST button to return to the normal stop status. (It takes approx. 1 min until the remote controller operation is available again.)



[3] Writing the setting data to EEPROM

The settings stored in the EEPROM of the P.C. board for indoor unit servicing are the factory-set values.

- Step 1** Push SET , CL and TEST buttons on the remote controller simultaneously for more than 4 seconds.
- * In the group control operation, the unit No. displayed for the first time is the header unit No.
 - At this time, the CODE No. (DN) shows “ I ”. Also, the fan of the indoor unit selected starts its operation and the swing operation starts if it has the louvers.
 - (The unit No. “ ALL ” is displayed if the auto-address setting mode is interrupted in [2] step 2 a))
- Step 2** Every time when UNIT LOUVER button is pushed, the indoor unit No. in the group control operation are displayed in order.
- (The settings stored in the EEPROM of the P.C. board for indoor unit servicing are the factory-set values.)
Specify the indoor unit No. with its P.C. board replaced to the P.C. board for indoor unit servicing.
(You cannot perform this operation if “ ALL ” is displayed.)
- Step 3** Select the CODE No. (DN) can be selected by pushing the ∇ / \blacktriangle button for the temperature setting.
- Set the indoor unit type and capacity.
 - The factory-set values shall be written to the EEPROM by changing the type and capacity.
1. Set the CODE No. (DN) to “ I ”. (without change)
 2. Select the type by pushing ∇ / \blacktriangle buttons for the timer setting. (For example, 4-way Air Discharge Cassette Type is set to “0001”. Refer to table 2)
 3. Push SET button. (The operation completes if the setting data is displayed.)
 4. Change the CODE No. (DN) to “ I ” by pushing ∇ / \blacktriangle buttons for the temperature setting.
 5. Select the capacity by pushing ∇ / \blacktriangle buttons for the timer setting. (For example, 80 Type is set to “0012”. Refer to table 3)
 6. Push SET button. (The setting completes if the setting data are displayed.)

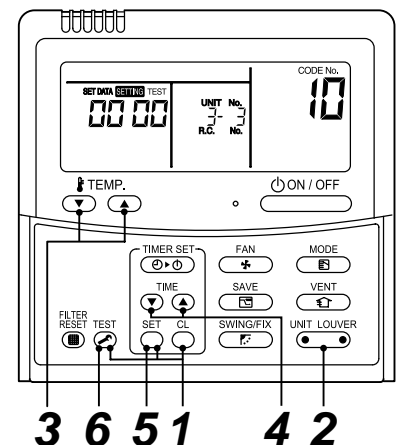
<Fig. 1 RBC-AMT32E>



- Step 4** Write the on-site setting data to the EEPROM, such as address setting, etc. Perform the steps 1 and 2 above again.
- Step 5** Change the CODE No. (DN) to “01” by pushing ▼ / ▲ buttons for the temperature setting. (this is the setting for the filter sign lighting time.)
- Step 6** Check the setting data displayed at this time with the setting data put down in [1].
1. If the setting data is different, modify the setting data by pushing ▼ / ▲ buttons for the timer setting to the data put down in [1].
The operation completes if the setting data is displayed.
 2. If the data is the same, proceed to next step.
- Step 7** Change the CODE No. (DN) by pushing ▼ / ▲ buttons for the temperature setting. As described above, check the setting data and modify to the data put down in [1].
- Step 8** Repeat the steps 6 and 7.
- Step 9** After the setting completes, push  button to return to the normal stop status. (It takes approx. 1 min until the remote control operation is available again.)
- * The CODE No. (DN) are ranged from “01” to “FF”. The CODE No. (DN) is not limited to be serial No. Even after modifying the data wrongly and pushing  button, it is possible to return to the data before modification by pushing  button if the CODE No. (DN) is not changed.

<Fig. 2 EEPROM layout diagram>

The EEPROM (IC503) is attached to the IC socket. When detaching the EEPROM, use a tweezers, etc. Be sure to attach the EEPROM by fitting its direction as shown in the figure.

* Do not bend the IC lead when replacing.

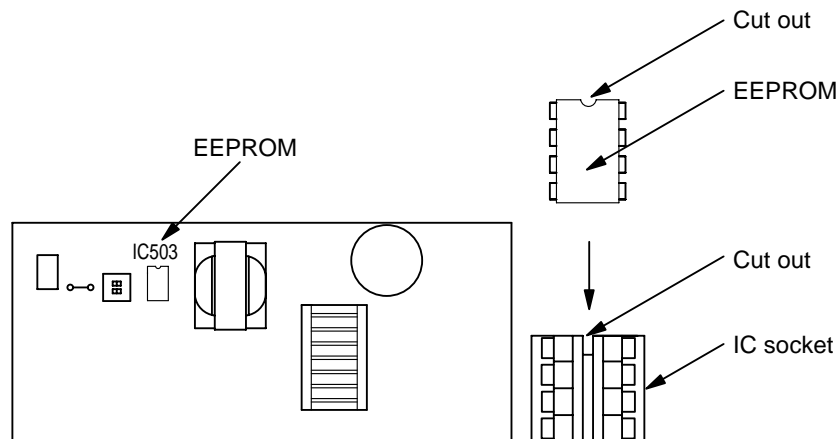

Table 1. Setting data (CODE No. table (example))

DN	Item	Setting data	Factory-set value
01	Filter sign lighting time		Depending on Type
02	Filter pollution leve		0000: standard
03	Central control address		0099: Not determined
06	Heating suction temperature shift		0002: +2°C (flooring installation type: 0)
OF	Cooling only		0000: Heat pump
10	Type		Depending on model type
11	Indoor unit capacity		Depending on capacity type
12	System address		0099: Not determined
13	Indoor unit address		0099: Not determined
14	Group address		0099: Not determined
19	Louver type (wind direction adjustment)		Depending on Type.
1E	Temperature range of cooling/heating automatic SW control point		0003: 3 deg (Ts ± 1.5)
28	Power failure automatic recovery		0000: None
2A	Option/Abnormal input (CN70) SW		0002: Humidifier
2b	Thermo output SW (T10 ③)		0000: Thermo ON
31	Ventilation fan (standalone)		0000: Not available
32	Sensor SW (Selection of static pressure)		0000: Body sensor
40	Humidifier control (+ drain pump control)		0003: Humidifier ON + Pump OFF
5d	High ceiling SW		0000: Standard
60	Timer setting (wired remote controller)		0000: Available
C2	Demand setting (outdoor unit current demand)		0075: 75 %
d0	Remote controller operation save function		0001: Enable
d3	Rotation number of the self-clean operation		0001: 210ypm(at self-clean operation)
d1	Frost protection function		0000: None
F0	Swing mode		0001: Standard
F1	Louver fixing position (Flap No. 1)		0000: Not fixed
F2	Louver fixing position (Flap No. 2)		0000: Not fixed
F3	Louver fixing position (Flap No. 3)		0000: Not fixed
F4	Louver fixing position (Flap No. 4)		0000: Not fixed

Table 2. Type: CODE No. 10

Setting data	Type	Type name abb.
0001*1*2	4-way Air Discharge Cassette Type	RAV-SM***UT-E
0005	Slim Duct Type	RAV-SM***SDT-E

*1 EEPROM initial value on the P.C. board for indoor unit servicing

*2

 **CAUTION**

<Model Name: RAV-SM***UT-E>

For the above models, set the CODE No. to “*LE*” and the setting data 0000 (initial) to “0001”.

Table 3.

Indoor unit capacity: CODE No. 11

Setting data	Type
0000*	Disable
0006	40
0007	45
0009	56
0012	80
0015	110
0017	140
0018	160

* EEPROM initial value on the P.C. board for indoor unit servicing.

11-2. Outdoor Unit

1. Setting the jumper wires and DIP switches

Part name		Function	Setting
Jumper wire	J800 to J803	Model switching	Cut these jumper wires according to the following table.
	J804 to J810	Settings	Set these jumper wires to the settings of the P.C. board before replacement.
DIP switch	SW802	Settings	Set SW802 to the setting of the P.C. board before replacement.
	SW803	LED indication switching	Set SW803 to all OFF.
	SW804	Special operations for service	Set SW804 to all OFF.

Model switching (J800 to J803)

Since this service P.C. board is available for several models, cut the jumper wires according to the following table. If they are not cut correctly, an error code "L10" or "L29" appears on the remote controller and the operation of the air conditioner is disabled.

Model name	J 800	J 801	J 802	J 803
Factory setting (default)	○	○	○	○
RAV-SP1104AT*-E	✕	○	○	○
RAV-SP1404AT*-E	○	✕	○	○
* : Characters that indicate the following: No character Standard models Z For salt-affected areas ZG For heavily salt-affected areas	○ : Connected, ✕ : Cut			

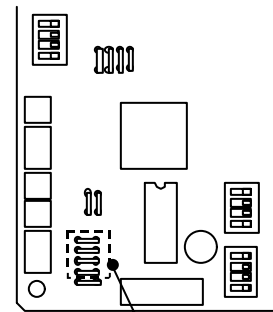

J800 to J803

2. Installing the P.C. board

- 1) Apply thermal grease to the back (heat sink contacting side) of devices Q200, Q650, DB01, and DB02. (Q300 and Q400 are not necessary to be applied thermal grease.)
- 2) Reuse the insulating sheet. When a small amount of thermal grease is applied to the back of the insulating sheet, it adheres temporarily to the heat sink, which makes it easy to attach the insulating sheet.
- 3) Insert the P.C. board, align the holes of the insulating sheets, semiconductor devices, and heat sinks, and then secure them with screws.
- 4) Connect the lead wires according to the wiring diagram stucked on the backside of the panel .

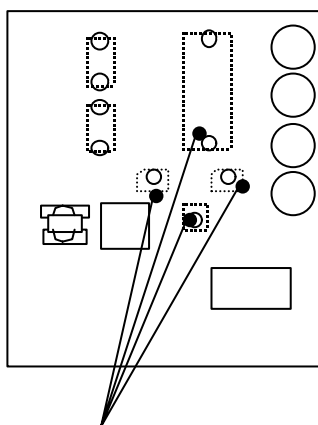

Apply thermal grease to the back (heat sink contacting side) of Q200, Q650, DB01, and DB02.

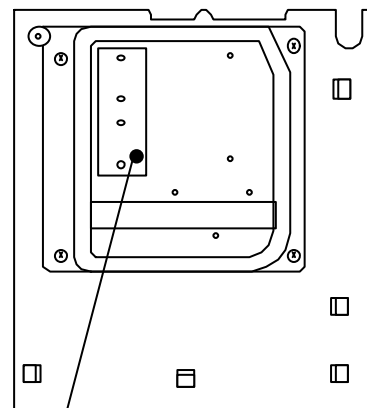



Reuse the insulating sheet. Applying thermal grease to the back of the insulating sheet makes it easy to attach the insulating sheet.

12. SETUP AT LOCAL SITE AND OTHERS

12-1. Indoor Unit

12-1-1. Test Run Setup on Remote Controller

<Wired remote controller>

1. When pushing  button on the remote controller for 4 seconds or more, "TEST" is displayed on LC display. Then push  button.
 - "TEST" is displayed on LC display during operation of Test Run.
 - During Test Run, temperature cannot be adjusted but air volume can be selected.
 - In heating and cooling operation, a command to fix the Test Run frequency is output.
 - Detection of error is performed as usual. However, do not use this function except case of Test Run because it applies load on the unit.
2. Use either heating or cooling operation mode for [TEST].
NOTE : The outdoor unit does not operate after power has been turned on or for approx. 3 minutes after operation has stopped.
3. After a Test Run has finished, push  button again and check that [TEST] on LC display has gone off. (To prevent a continuous test run operation, 60-minutes timer release function is provided to this remote controller.)

<Wireless remote controller>

(4-way Air Discharge Cassette Type only)

1 Turn off power of the unit.

Remove the adjuster attached with sensors from the ceiling panel.

For removing, refer to the Installation manual attached to the ceiling panel.

(Be careful to handle the adjuster because cables are connected to the sensor.)

Remove the sensor cover from the adjuster. (1 screw)

2 Change ON of Bit [1: TEST] of the sensor P.C. board switch [S003] to OFF.

Mount the sensor cover and mount the adjuster with sensor to the ceiling panel.

Turn on power of the unit.

3 Push button on the wireless remote controller and select [COOL] or [HEAT] operation mode using button. (All the display lamps of sensors on the wireless remote controller flash during Test Run.)

- Do not perform Test Run operation in other modes than [HEAT] / [COOL] mode.
- Detection of error is performed as usual.

4 After Test Run operation, push button to stop the operation.

5 Turn off power of the unit.

Return Bit [1] of the sensor P.C. board switch [S003] to the original position. (ON → OFF)

Mount the adjuster with sensors to the ceiling panel.

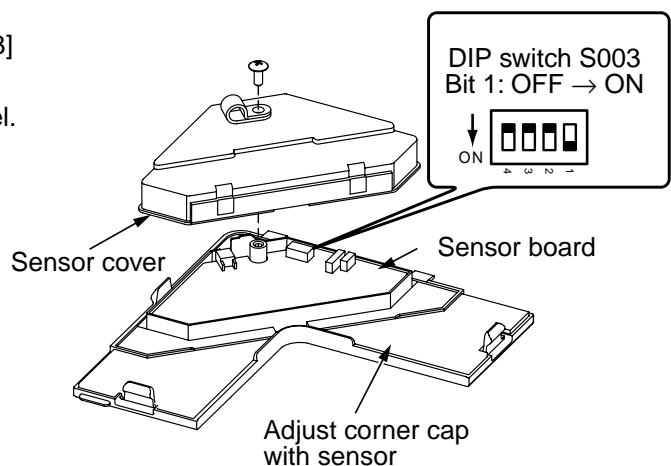



(Except 4-way Air Discharge Cassette Type and Under Ceiling Type)

1 Remove a screw which fixes the name plate of the receiver part on the wireless remote controller.

Remove the nameplate of the receiver section by inserting a minus screwdriver, etc. into the notch at the bottom of the plate, and set the Dip switch to [TEST RUN ON].

2 Execute a test operation with  button on the wireless remote controller.

- ,  and  LED flash during test operation.
- Under status of [TEST RUN ON], the temperature adjustment from the wireless remote controller is invalid.

Do not use this method in the operation other than test operation because the equipment is damaged.

3 Use either [COOL] or [HEAT] operation mode for test operation.

- The outdoor unit does not operate approx. 3 minutes after power-ON and operation stop.

4 After the test operation finished, stop the air conditioner from the wireless remote controller, and return Dip switch of the sensor section as before.

(A 60 minutes timer clearing function is attached to the sensor section in order to prevent a continuous test operation.)

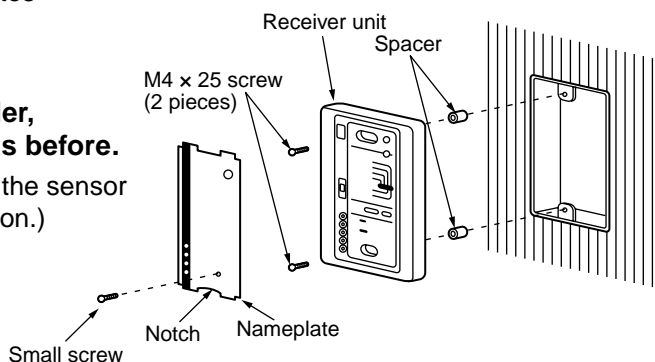

(Under Ceiling Type only)

1 Turn off power of the air conditioner.

Remove the adjust corner cap attached with sensor section from the ceiling panel. For removing method, follow to the installation manual attached to the ceiling panel.

(Be careful to handle the sensor section because cables are connected to the sensor section.)

Remove the sensor cover from the adjust corner cap. (1 screw)

2 Change Bit [1: TEST] of the switch [S003] on the sensor P.C. board from OFF to ON.

Mount the sensor cover and attach the adjust corner cap with with sensors to the ceiling panel.

Turn on power of the air conditioner.

3 Push  button of the wireless remote controller and select an operation mode [COOL] or [HEAT] with  button. (All the display lamps of the wireless remote controller sensor section flash during the test operation.)

- Do not use operation mode other than [COOL] or [HEAT].
- Error is detected as usual.

4 When the test operation has finished, push button to stop the operation.

5 Turn off power of the air conditioner.

Change Bit [1] of the switch [S003] on the sensor P.C. board from ON to OFF.

Attach the adjust corner cap with sensors to the ceiling panel.

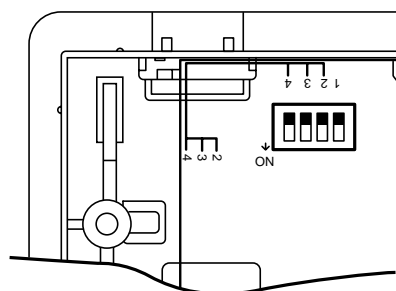

<In case of wireless remote controller>

Procedure	Description	
1	Turn on power of the air conditioner.	
	The operation is not accepted for 5 minutes when power has been turned on at first time after installation, and 1 minute when power has been turned on at the next time and after. After the specified time has passed, perform a test operation.	
2	Push [Start/Stop] button and change the operation mode to [COOL] or [HEAT] with [Mode] button. Then change the fan speed to [High] using [Fan] button.	
	Test cooling operation	Test heating operation
3	Set temperature to [18°C] using [Temperature set] button.	Set temperature to [30°C] using [Temperature set] button.
4	After checking the receiving sound "Pi", immediately push [Temperature set] button to set to [19°C]	After checking the receiving sound "Pi", immediately push [Temperature set] button to set to [29°C].
5	After checking the receiving sound "Pi", immediately push [Temperature set] button to set to [18°C].	After checking the receiving sound "Pi", immediately push [Temperature set] button to set to [30°C].
6	Then repeat the procedure 4 → 5 → 4 → 5 .	
	After approx. 10 seconds, all the display lamps on the sensor part of wireless remote controller, [Operation] (Green), [Timer] (Green), and [Ready] (Yellow) flash and the air conditioner starts operation. If the lamps do not flash, repeat the procedure 2 and after.	
7	After the test operation, push [Start/Stop] button to stop the operation.	

<Outline of test operation from the wireless remote controller>

Test cooling operation:

Start → 18°C → 19°C → 18°C → 19°C → 18°C → 19°C → 18°C → (Test operation) → Stop

Test heating operation:

Start → 30°C → 29°C → 30°C → 29°C → 30°C → 29°C → 30°C → (Test operation) → Stop

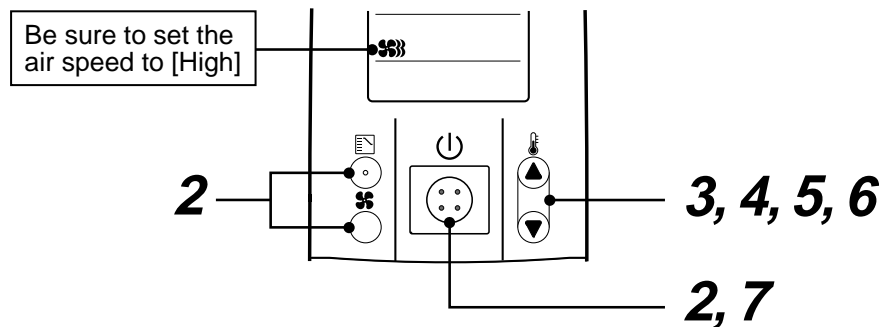

12-1-2. Forced Defrost Setup of Remote Controller (For wired remote controller only)

(Preparation in advance)

- 1** Push  +  +  buttons simultaneously for 4 seconds or more on the remote controller. (Push buttons while the air conditioner stops.)

The first displayed unit No. is the master indoor unit address in the group control.

- 2** Every pushing  button, the indoor unit No. in the group control is displayed one after the other.

Select a main indoor unit (outdoor unit is connected) which is to be defrosted. In this time, fan and louver of the selected indoor unit operate.

- 3** Using the set temperature   buttons, specify the item code (DN) 8C.

- 4** Using the timer time   buttons, set time to data 0001. (0000 at shipment)

- 5** Push  button. (OK if indication lights)

- 6** Pushing  button returns the status to the normal stop status.

(Practical operation)

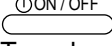
- Push ON/OFF  Key.
- Select the HEAT mode.
- After while, the forced defrost signal is sent to the outdoor unit and then the outdoor unit starts defrost operation. (The forced defrost operation is performed for Max. 12 minutes.)
- After defrost operation finished, the operation returns to the heating operation.

To execute the defrost operation again, start procedure from above item **1**.

(If the forced defrost operation was executed once, setting of the above forced defrost operation is cleared.)

12-1-3. LED Display on P.C. Board

1. D501 (Red)

- It goes on (Goes on by operation of the main microcomputer) at the same time when the power supply is turned on.
- It flashes with 1-second interval (every 0.5 second): When there is no EEPROM or writing-in operation fails.
- It flashes with 10-seconds interval (every 5 second): During DISP mode
- It flashes with 2-seconds interval (every 1 second): While setting of function select (EEPROM)

2. D403 (Red)

- It goes on when power supply of the remote controller is turned on. (Lights on hardware)

3. D503 (Yellow): Main bus communication

- It goes on for 5 seconds in the first half of communication with the central controller.

4. D504 (Green): Sub bus communication

- It flashes for 5 seconds in the first half of communication with the remote controller. (Group master unit)
- It flashes with 0.2-second interval (for 0.1 second) for 5 second in the latter half of communication between master and follower in the Gr indoor unit.

5. D14 (Orange)

- It flashes while receiving the serial signal from the outdoor unit. (Hardware)

6. D15 (Green)

- It flashes while sending the serial signal to the outdoor unit. (Hardware)

12-1-4. Function Selection Setup

<Procedure> Perform setting while the air conditioner stops.

1 Push **TEST** + **SET** + **CL** buttons simultaneously for 4 seconds or more.

The first displayed unit No. is the master indoor unit address in the group control.

In this time, fan and louver of the selected indoor unit operate.



2 Every pushing **UNIT LOUVER** button (button at left side), the indoor unit No. in the group control is displayed one after the other. In this time, fan and louver of the selected indoor unit only operate.



3 Using the set temperature **TEMP.** buttons, specify the item code (DN).



4 Using the timer time **TIME** buttons, select the set data.



5 Push **SET** button. (OK if indication lights)

- To change the selected indoor unit, proceed to Procedure **2**.
- To change item to be set up, proceed to Procedure **3**.



6 Pushing **TEST** button returns the status to the normal stop status.

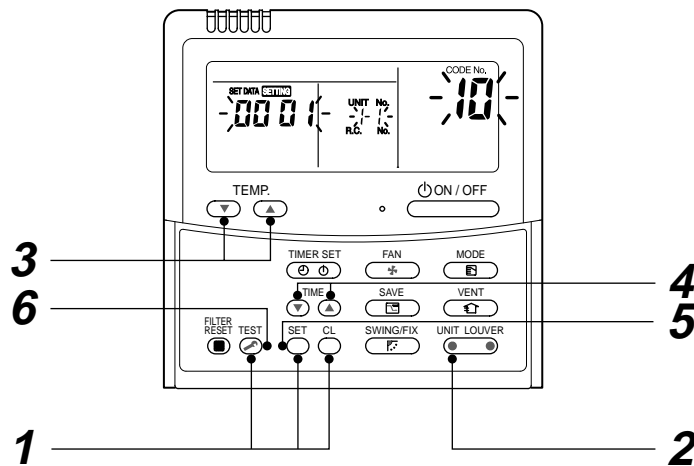

<Operation procedure>

1 → 2 → 3 → 4 → 5 → 6 END

Function selection item No. (DN) list

DN	Item	Contents		At shipment from factory
01	Filter sign lighting time	0000: None 0002: 2500H 0004: 10000H	0001: 150H 0003: 5000H 0005: Clogging sensor used	According to type
02	Filter stain level	0000: Standard 0001: Heavy stain (Half of standard time)		0000: Standard
03	Central control address	0001: No.1 unit 0099: Undecided	to 0064: No.64 unit	0099: Undecided
06	Heating suction temp. shift	0000: No shift 0002: +2°C	to 0001: +1°C 0010: +10°C (Up to +6 is recommended.)	0002: +2°C (Floor type 0000: 0°C)
0F	Cooling-only	0000: Heat pump 0001: Cooling only (No display for [AUTO] [HEAT])		0000: Heat pump
10	Type	0000: (1-way air discharge cassette) 0001: (4-way air discharge cassette) to 0037		According to model type
11	Indoor unit capacity	0000: Undecided	0001 to 0034	According to capacity type
12	Line address	0001: No.1 unit	to 0030: No.30 unit	0099: Undecided
13	Indoor unit address	0001: No.1 unit	to 0064: No.64 unit	0099: Undecided
14	Group address	0000: Individual 0002: Follower unit in group	0001: Master unit in group	0099: Undecided
19	Louver type (Adjustment of air direction)	0000: No louver model (0002:1-way) 0004: 4-way	0001: Swing only (0003:2-way)	According to model type
1E	In automatic cooling/heating, temp. width of cool → heat, heat → cool mode selection control point	0000: 0 deg	to 0010: 10 deg (Cool/heat are reversed with ± (Data value) / 2 against the set temperature)	0003: 3 deg (Ts±1.5)
28	Automatic reset of power failure	0000: None	0001: Provided	0000: None
2A	Selection of option / error input (CN70)	0000: Filter input 0002: Humidifier input	0001: Alarm input (Air cleaner, etc.)	0002: Humidifier
2b	Selection of thermostat output (T10 ③)	0000: Indoor thermostat ON 0001: ON receiving output of outdoor compressor		0000: Thermostat ON
2E	Selection of HA (T10) terminal	0000: Normal (JEMA) 0002: Fire alarm input	0001: Card input (Forgotten to be off)	0000: Normal (HA terminal)
30	AUTO grille (This function is not provided.)	0000: Impossible	0001: Possible	0000: Impossible
31	Fan (Single operation)	0000: Impossible	0001: Possible	0000: Impossible
32	Sensor selection	0000: Body TA sensor	0001: Remote controller sensor	0000: Body sensor
40	Humidifier control (+Drain pump control) (This function is not provided.)	0000: No control 0001: Humidifier + Vaporizing type (Pump ON) 0002: Humidifier + Supersonic type (Pump ON when specified time elapsed) 0003: Humidifier + Natural drain type (Pump OFF)		0003: Humidifier ON Pump OFF
5d	<4-way Discharge Cassette type> High ceiling selection (Air volume selection)	0000: Standard filter 0001: Super long life 0003: High performance (65%), High performance (90%), (0006:Deodorant, Ammonia deodorization)		0000: Standard
	<Slim Duct type> External static pressure	0000: Standard (At shipment)	(10 Pa) 0001: High static pressure 1 (20 Pa) 0003: High static pressure 2 (35 Pa) 0006: High static pressure 3 (50 Pa)	0000: Standard
60	Timer setting (Wired remote controller)	0000: Operable	0001: Operation prohibited	0000: Operable

DN	Item	Contents	At shipment from factory
42	Self-clean operation time	0000: None 0000: 0.5 h to 0.012: 0 h Set when compressor-ON time is 10 to 60 minutes. When ON-time is 60 minutes or more, the double of this operation time setting is set.	0002: 1 hour
45	Selection of louver horizontal discharge position	0000: Smudging-less setting 0002: Cold draft preventive setting	0000: Smudging-less setting
C2	Current demand X% to outdoor unit	0050: 50% to 0100: 100%	0075: 75%
CC	Setting of self-clean operation forced stop	0000: No • Clean operation is performed in case of stop by HA input. • HA operation output OFF during clean operation in case of stop by remote controller 0001: Yes • Clean operation is not performed in case of stop by HA input. • HA operation output ON during clean operation in case of stop by remote controller	0000: None
CD	Clean operation stop function when [ON/OFF] operation is prohibited.	The air conditioner stops (including fire alarm such as remote monitor system) while setup of [ON/OFF] operation prohibited (Central 1, 2) is performed from the central controller side. 0000: Valid (Clean operation) 0001: Invalid (No clean operation)	0000: Valid
D0	Existence of remote controller save function	0000: Invalid (Impossible) 0001: Valid (Possible)	0001: Valid (Possible)
D1	Existence of 8°C heating operation function	0000: Invalid (Impossible) 0001: Valid (Possible)	0001: Invalid (Impossible)
D3	Revolution frequency of self clean operation	0000: Invalid (Self clean operation is not carried out.) 0001: Valid (Self clean operation is practiced with 210 rpm.)	0001: Valid (210 rpm / operation)
D4	Display / No display of [Dry operation] during self clean operation	0000: Display 0001: No display	0000: Display
F0	Louver swing mode	0000: No synchronization 0001: 4-way synchronization 0002: Dual 0003: Cycle	0001: 4-way synchronization
F1	Louver No.1 fixed position	0000: Release (Free) 0001 to 0005: Horizontal discharge position to Downward discharge position	0000: Release
F2	Louver No.2 fixed position	0000: Release (Free) 0001 to 0005: Horizontal discharge position to Downward discharge position	0000: Release
F3	Louver No.3 fixed position	0000: Release (Free) 0001 to 0005: Horizontal discharge position to Downward discharge position	0000: Release
F4	Louver No.4 fixed position	0000: Release (Free) 0001 to 0005: Horizontal discharge position to Downward discharge position	0000: Release

* The swing mode selection (DN code No. [F0]), louver fix (DN code No. [F1] to [F4]) and restriction ratio setting for save operation (DN code No. [C2]) can be set/changed from the normal DN setup (Detail DN setup).

12-1-5. Wiring and Setting of Remote Controller Control

2-remote controller control (Controlled by 2 remote controllers)

This control is to operate 1 or multiple indoor units are operated by 2 remote controllers.
(Max. 2 remote controllers are connectable.)

• When connected 2 remote controllers operate an indoor unit

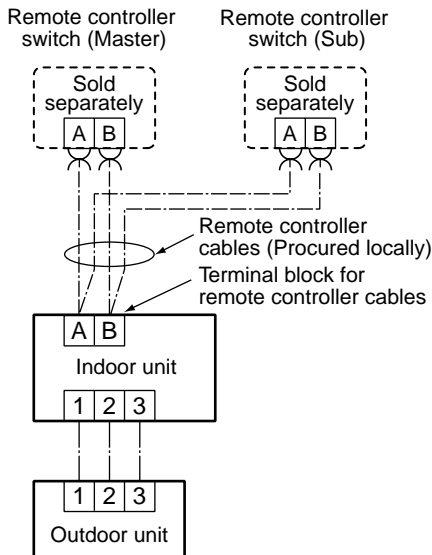

• When connected 2 remote controllers operate the twin

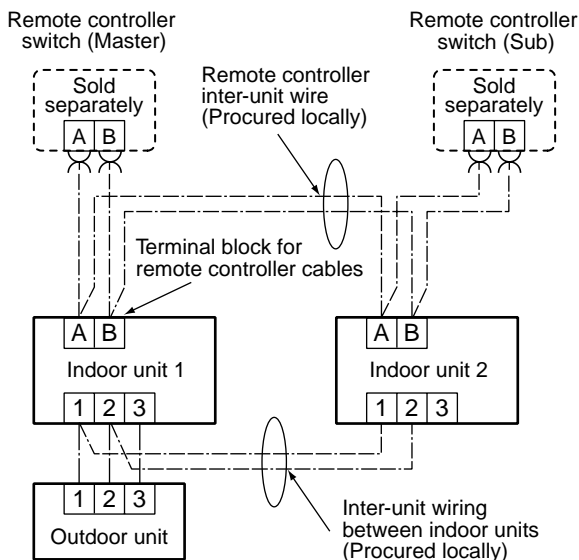

(Setup method)

One or multiple indoor units are controlled by 2 remote controllers.
(Max. 2 remote controllers are connectable.)

[Operation]

1. The operation contents can be changed by Last-push-priority.
2. Use a timer on either Master remote controller or Sub remote controller.

<Wired remote controller>

How to set wired remote controller as sub remote controller

Change DIP switch inside of the rear side of the remote controller switch from remote controller master to sub. (In case of RBC-AMT32E)

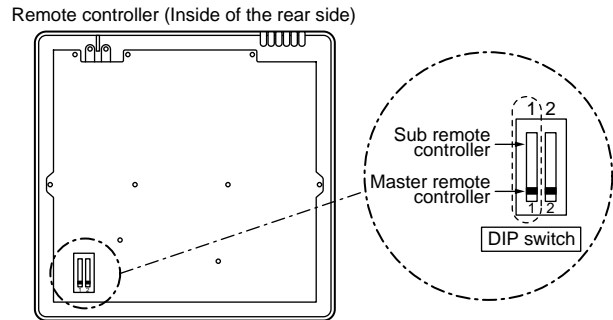

<Wireless remote controller>

How to set wireless remote controller to sub remote controller

Change OFF of Bit [3: Remote controller Sub/Master] of switch S003 to ON.

<In case of 4-way Discharge Cassette type>

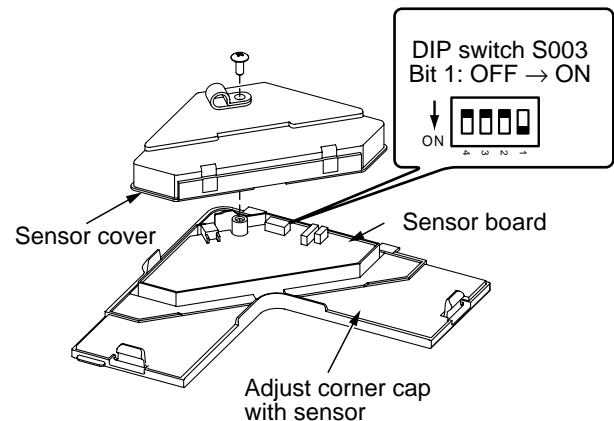

Replace OFF with ON of the Bit SW [Remote controller Sub/Master].

<In case of Slim Duct type>

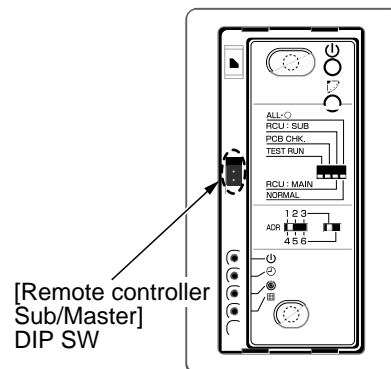

12-1-6. Monitor Function of Remote Controller Switch

■ Calling of sensor temperature display

<Contents>

Each data of the remote controller, indoor unit and outdoor unit can be understood by calling the service monitor mode from the remote controller.

<Procedure>

- 1 Push **TEST** + **CL** buttons simultaneously for 4 seconds to call the service monitor mode.

The service monitor goes on, the master indoor unit No. is displayed at first and then the temperature of item code **00** is displayed.



- 2 Push temperature set **TEMP.** buttons and then change the item code of data to be monitored.

The item code list is shown below.

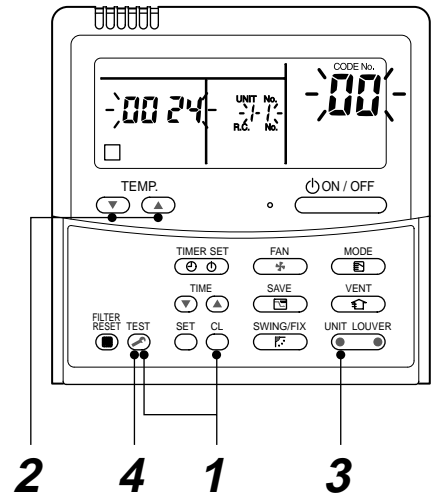

<Operation procedure>

1 → 2 → 3 → 4

Returned to usual display

	Item code	Data name	Unit
Indoor unit data	01	Room temperature (Remote controller)	°C
	02	Indoor suction temperature (TA)	°C
	03	Indoor heat exchanger (Coil) temperature (TC,J)	°C
	04	Indoor heat exchanger (Coil) temperature (TC)	°C
	* 07	Indoor fan revolution frequency	rpm
	* F2	Indoor fan calculated operation time	×100h
	F3	Filter sign time	×1h
	* F8	Indoor discharge temperature*1	°C

	Item code	Data name	Unit
Outdoor unit data	60	Outdoor heat exchanger (Coil) temperature (TE)	°C
	61	Outside temperature (TO)	°C
	62	Compressor discharge temperature (TD)	°C
	63	Compressor suction temperature (TS)	°C
	65	Heat sink temperature (THS)	°C
	6A	Operation current (× 1/10)	A
	* 6D	Outdoor heat exchanger (Coil) temperature (TL)	°C
	* 70	Compressor operation frequency	rps
	* 72	Outdoor fan revolution frequency (Lower)	rpm
	* 73	Outdoor fan revolution frequency (Upper)	rpm
	F1	Compressor calculated operation time	×100h

Items with * marks are not provided to the Slim Duct type.



- 3 Push **UNIT LOUVER** button to select the indoor unit to be monitored. Each data of the indoor unit and its outdoor units can be monitored.



- 4 Pushing **TEST** button returns the status to the usual display.

*1 The indoor discharge temperature of item code [F8] is the estimated value from TC or TCJ sensor.

Use this value to check discharge temperature at test run.
(A discharge temperature sensor is not provided to this model.)

- The data value of each item is not the real time, but value delayed by a few seconds to ten-odd seconds.
- If the combined outdoor unit is one before 2 or 3 series, the outdoor unit data [6D], [70], [72] and [73] are not displayed.

■ Calling of error history

<Contents>

The error contents in the past can be called.

<Procedure>

- 1 Push **SET** + **TEST** buttons simultaneously for 4 seconds or more to call the service check mode.

Service Check goes on, the **item code 01** is displayed, and then the content of the latest alarm is displayed. The number and error contents of the indoor unit in which an error occurred are displayed.

- 2 In order to monitor another error history, push the set temperature **▼** / **▲** buttons to change the error history No. (Item code).

Item code **01** (Latest) → Item code **04** (Old)

NOTE : 4 error histories are stored in memory.

- 3 Pushing **TEST** button returns the display to usual display.

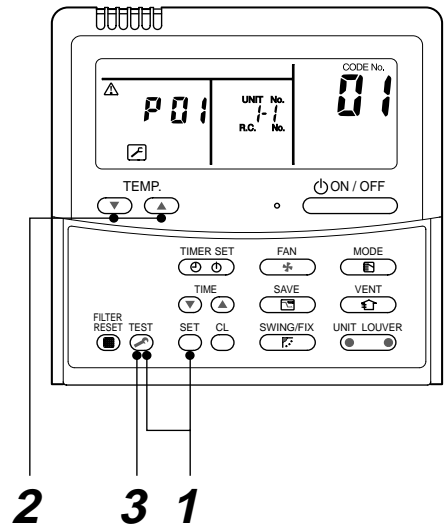

<Operation procedure>

1 → 2 → 3

Returned to usual display

REQUIREMENT

Do not push **CL** button, otherwise all the error histories of the indoor unit are deleted.

(Group control operation)

In a group control, operation of maximum 8 indoor units can be controlled by a remote controller.

The indoor unit connected with outdoor unit (Individual/Master of twin) controls room temperature according to setting on the remote controller.

<System example>

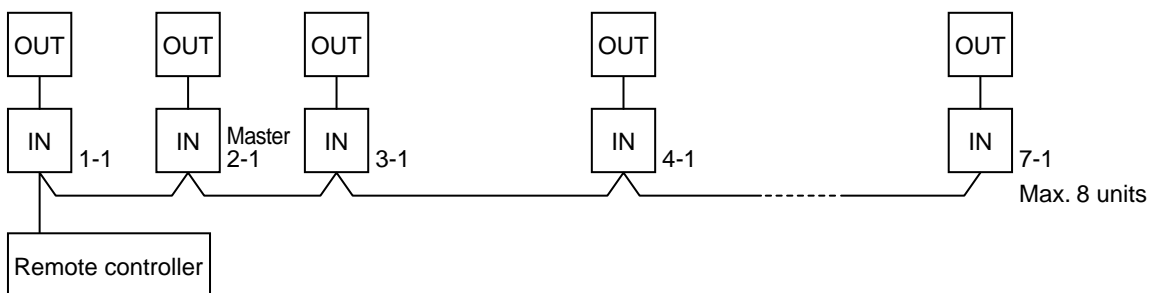

1. Display range on remote controller

The setup range (Operation mode/Air volume select/Setup temp) of the indoor unit which was set to the master unit is reflected on the remote controller.

2. Address setup

Turn on power of the indoor unit to be controlled in a group within 3 minutes after setting of automatic address.

If power of the indoor unit is not turned on within 3 minutes (completion of automatic address setting), the system is rebooted and the automatic address setting will be judged again.

- 1) Connect 3 In/Out cables surely.
- 2) Check line address/indoor address/group address of the unit one by one.
- 3) The unit No. (line/indoor gout address) which have been set once keep the present status as a rule if the unit No. is not duplicated with one of another unit.

■ Indoor unit power-ON sequence

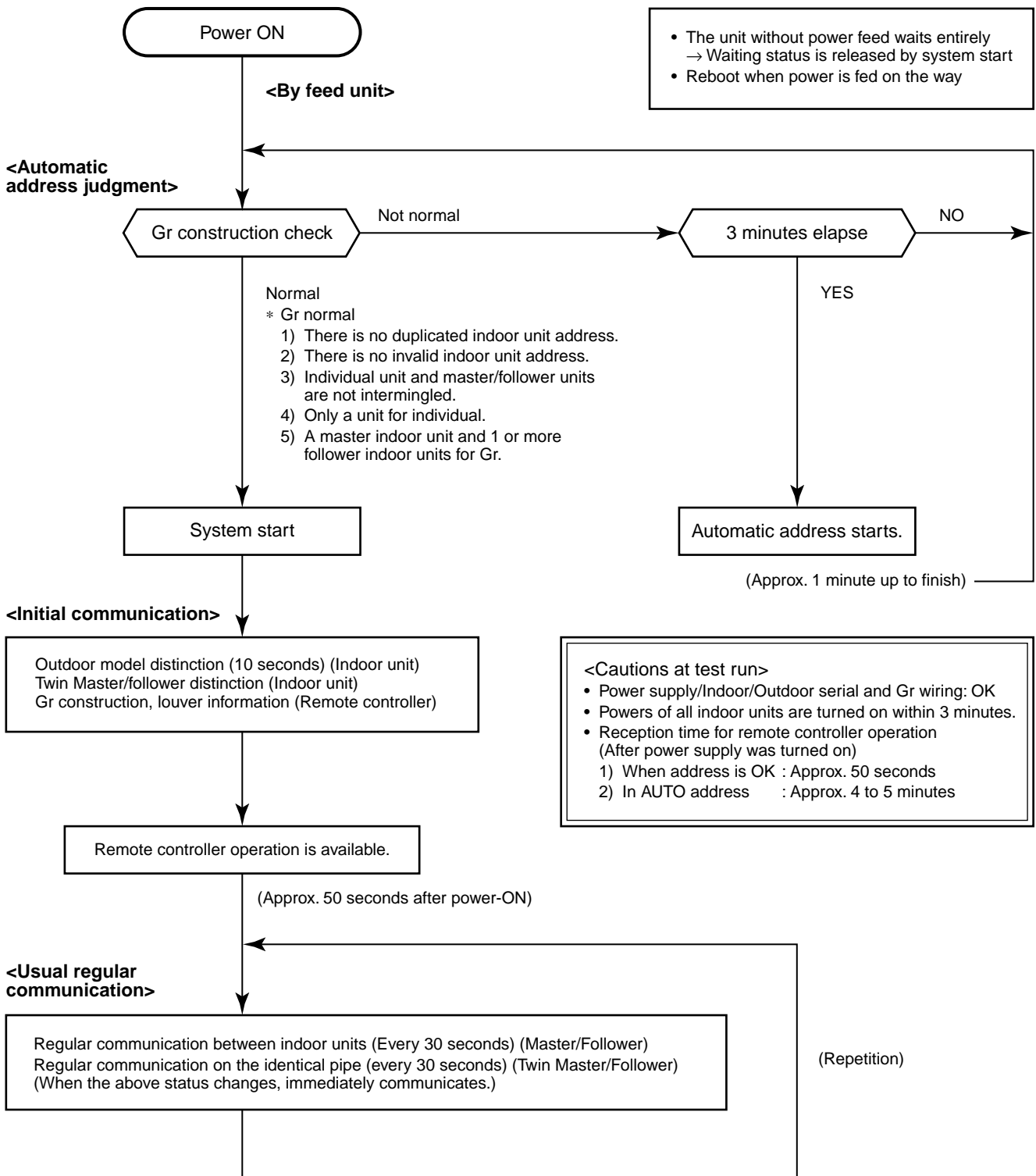

- In a group operation, if the indoor unit which was fed power after judgment of automatic address cannot receive regular communication from the master unit and regular communication on identical pipe within 120 seconds after power was turned on, it reboots (system reset).
→ The operation starts from judgment of automatic address (Gr construction check) again.
(If the address of the master unit was determined in the previous time, the power fed to the master unit and reboot works, the master unit may change though the indoor unit line address is not changed.)

12-2. Setup at Local Site / Others

Model name: TCB-PCNT30TLE2

12-2-1. TCC-LINK Adapter (For TCC-LINK Central Control)

1. Function

This model is an optional P.C. board to connect the indoor unit to TCC-LINK (Central controller).

2. Microprocessor block diagram

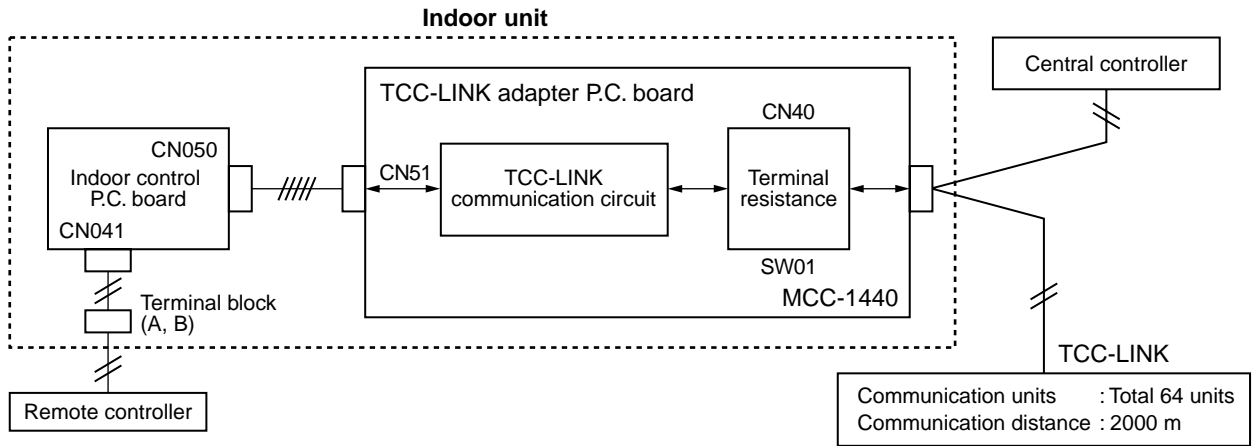

3. TCC-LINK wiring connection

CAUTION

- 1) When controlling customized setup collectively, TCC-LINK adapter (This option) is required.
- 2) In case of group operation or twin operation, the adapter is necessary to be connected to the main unit.
- 3) Connect the central control devices to the central control system wiring.
- 4) When controlling collectively customized setup only, turn on only Bit 1 of SW01 of the least line of the system address No. (OFF when shipped from the factory)

* In case of customized setup, the address is necessary to be set up again from the wired remote controller after automatic addressing.

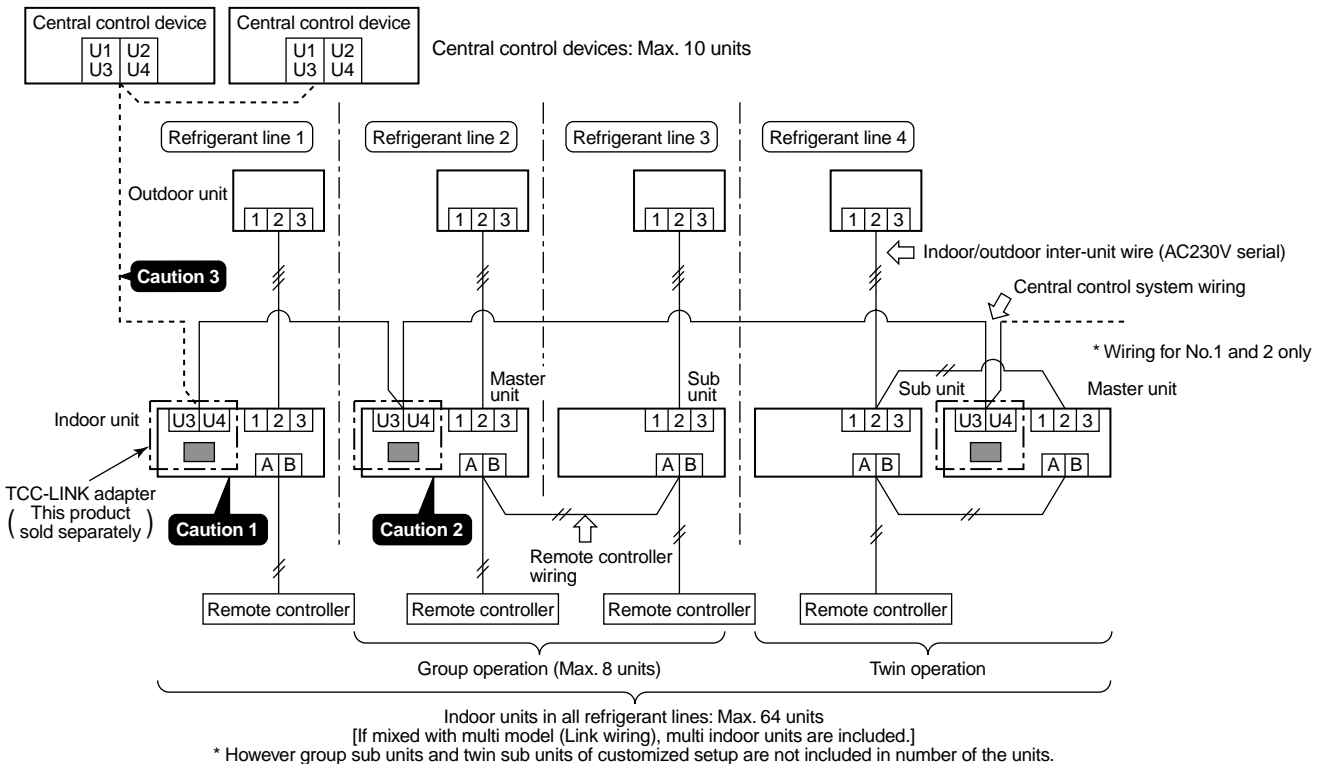

4. Wiring specifications

- Use 2-core with no polar wire.
- Match the length of wire to wire length of the central control system.

If mixed in the system, the wire length is lengthened with all indoor/outdoor inter-unit wire length at side.

- To prevent noise trouble, use 2-core shield wire.
- Connect the shield wire by closed-end connection and apply open process (insulating process) to the last terminal. Ground the earth wire to 1 point at indoor unit side. (In case of central controlling of digital inverter unit setup)

No. of wires	Size
2	Up to 1000m: twisted wire 1.25mm ² Up to 2000m: twisted wire 2.0mm ²

CAUTION

- 1) Closed-end connection of shield wire (Connect all the connecting parts of each indoor unit)
- 2) Apply open process to the last terminal (insulating process).
- 3) Ground earth wire to 1 point at indoor unit side.

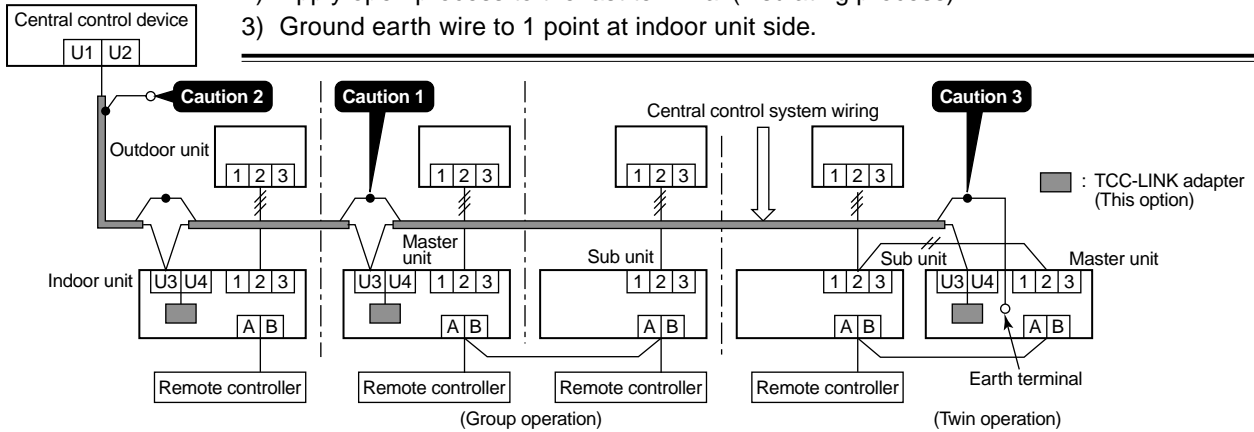

5. P.C. board switch (SW01) setup

When performing collective control by customized setup only, the setup of terminator is necessary.

- Using SW01, set up the terminator.
- Set up the terminator to only the adapter connected to the indoor unit of least line address No.

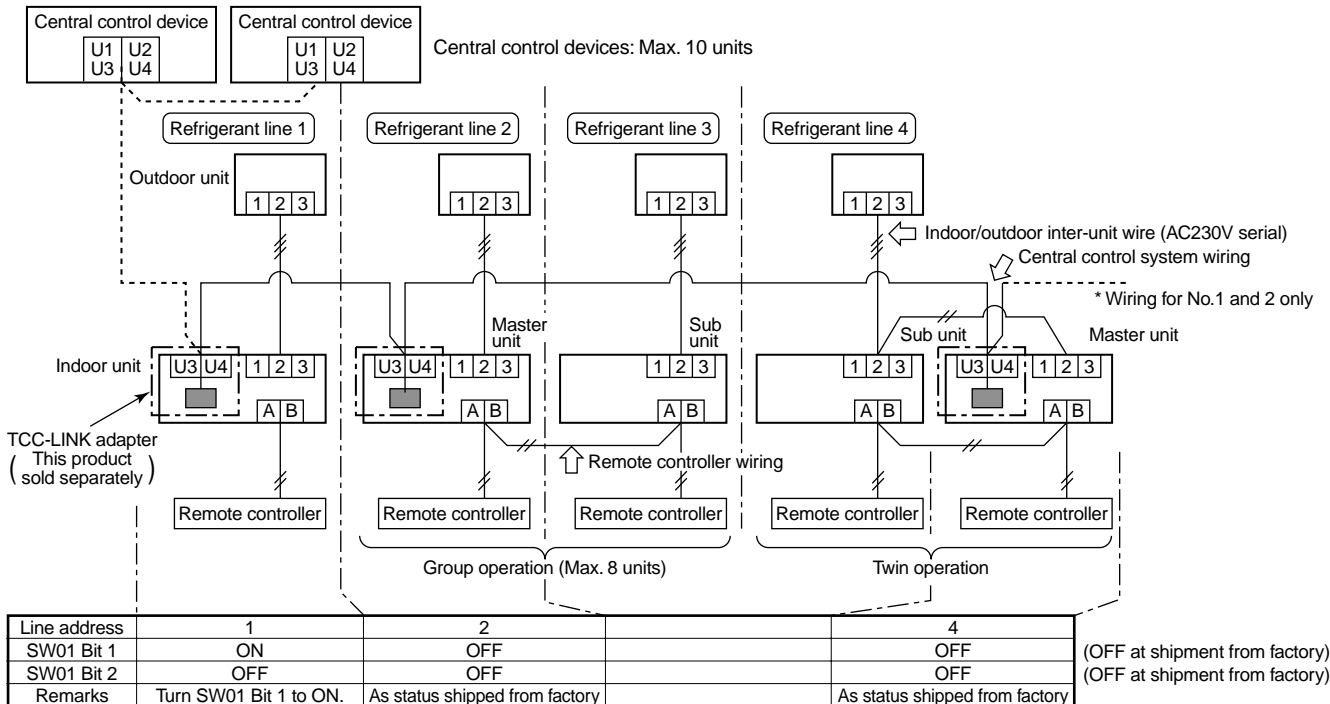

(Reference) Setup contents of switch

SW01		Terminator	Remarks
Bit 1	Bit 2		
OFF	OFF	None	Mixed with multi (Link wiring) at shipment from factory
ON	OFF	100Ω	Central control by digital inverter only
OFF	ON	75Ω	Spare
ON	ON	43Ω	Spare

6. External view of P.C. board assembly

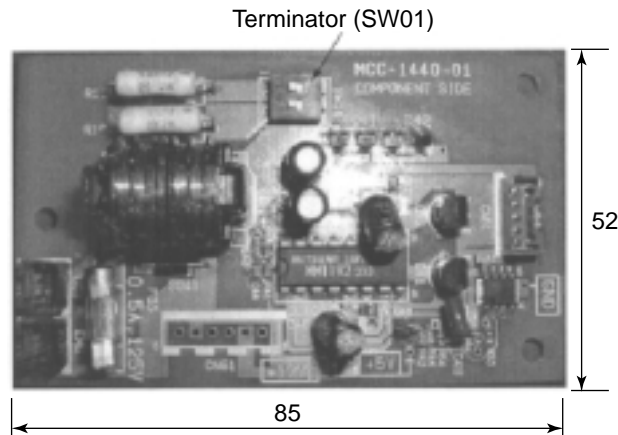

7. Address setup

In addition to set up the central control address, it is necessary to change the indoor unit number. (Line/Indoor/Group address). For details, refer to TCC-LINK Adapter Installation Manual.

12-3. How to Set up Central Control Address Number

When connecting the indoor unit to the central control remote controller using TCC-LINK adapter, it is necessary to set up the central control address number.

- The central control address number is displayed as the line No. of the central control remote controller.

1. Setup from remote controller at indoor unit side

* If you use the network adapter P.C. board, it is effective only when No. 7 of setup switch SW01 on P.C. board is turned off.

<Procedure> Perform setup while the unit stops.

1 Push + buttons for 4 seconds or more.

When group control is executed, first the unit No. **ALL** is displayed and all the indoor units in the group control are selected. In this time, fans of all the selected indoor units are turned on. (Fig. 1)
(Keep **ALL** displayed status without pushing button.)

In case of individual remote controller which is not group-controlled, Line address and Indoor unit address are displayed.

2 Using temperature setup buttons, specify item code 03.

3 Using timer time buttons, select the setup data. The setup data is shown in the table below (Table 1).

4 Push button. (OK if display goes on.)

- To change the item to be set up, return to Procedure 2.

5 Push button.

The status returns to usual stop status.

(Table 1)

Setup data	Central control address No.
0001	1
0002	2
0003	3
⋮	⋮
0064	64
0099	Unset (Setup at shipment from factory)

(Fig.1)

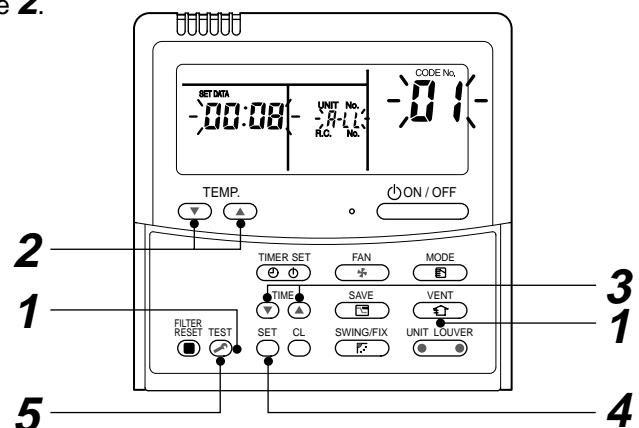

2. How to confirm the central control address (New function for AMT32 remote controller)

<Procedure> It can be confirmed even during operation or stopping.

1 Push  button for 4 seconds or more.



2 In the frame at left side of the remote controller screen, the lighting set contents are displayed.

During unset time, *0099* (At shipment from factory) is displayed.



3 After lighting display for 3 seconds, the display automatically disappears.

If any button is pushed during display, immediately the display disappears and then the pushed button is displayed.

3. How to set up type of swing <For only 4-way Discharge Cassette type>

1 Push  for 4 seconds or more during stop of the operation.

- **SETTING** flashes.

2 Push  (At the left side of the button) and select the unit to be selected.

- Every pushing the button, the unit No. changes.

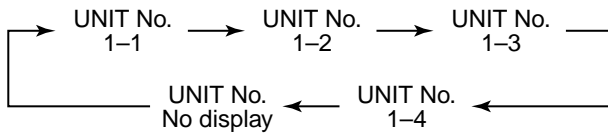

The fan of the selected unit rotates and the louver swings.

3 Using **TIMER SET**  /  buttons, select type of the swing.

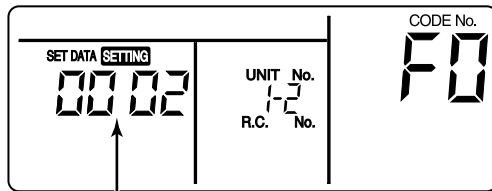

Swing setup code

Swing setup code	Louver operation
0001	Standard swing (At shipment)
0002	Dual swing
0003	Cycle swing

REQUIREMENT

- Do not set 0000. (Louver may cause a trouble.)

4 Push .

5 Push  to finish the setup.

- * Standard swing
Four louvers swing simultaneously with the same angel.

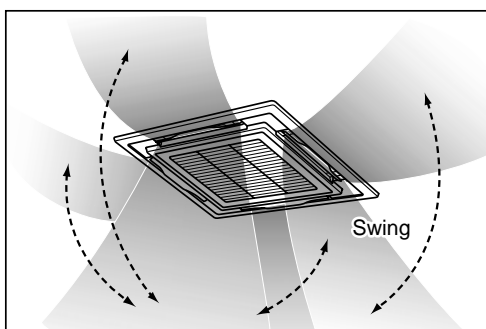

- * Dual swing
(Recommended for heating operation)
 - The adjoined louvers repeat horizontal discharge/Downward discharge alternately to clear irregularity of the temperature in heating operation.
 - The vertical discharge spreads hot air to the floor, and the horizontal discharge stirs. Both suppress the temperature irregularity.

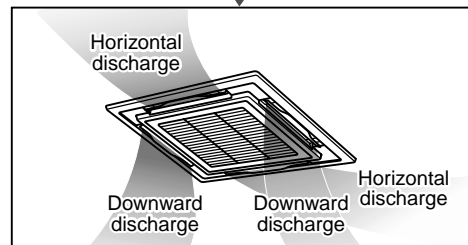
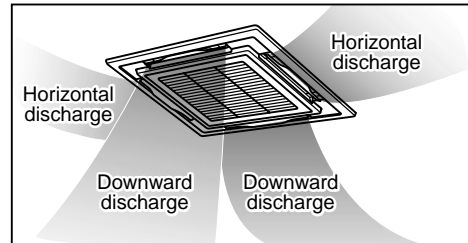

- * Cycle swing
(Recommended for cooling operation)
 - 4 louvers swing with time lag as if they heave.

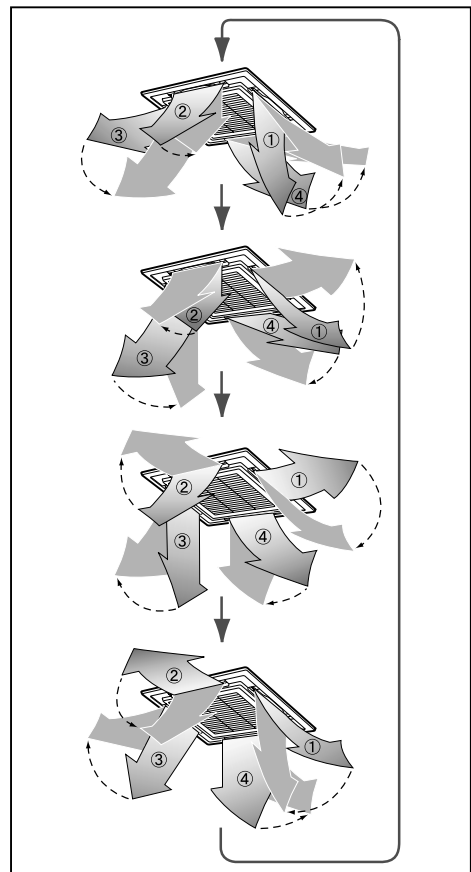

4. How to set louver lock (Louver fix)

<For only 4-way Discharge Cassette type>

1 Push **UNIT LOUVER** (At the right side of the button) for 4 seconds or more during stop of the operation.

- **SETTING** flashes.

2 Push **UNIT LOUVER** (At the left side of the button) and select the unit to be set.

- Every pushing the button, the unit No. changes.

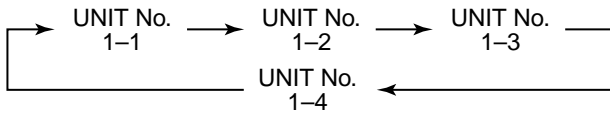

The fan of the selected unit rotates and the louver swings.

3 Push temp. set **▼** / **▲** to display the louver No. of which air direction is to be fixed.

- The selected louver swings.

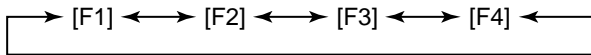

4 Push **TIMER SET** **▼** / **▲** and select air direction of the louver of which swinging you do not want.

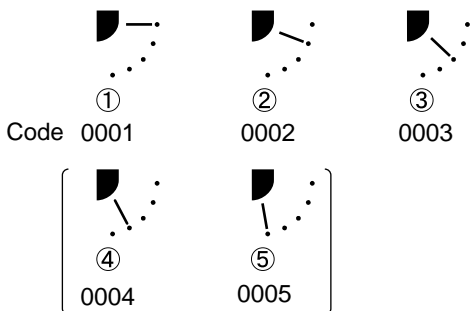

* If selecting above „ and ..., there may be fear of dewing in cooling time.

5 Push **SET** to determine the setup contents.

- When the setup was determined, **⊕** mark goes on.
- (To set continuously the louver lock of the other unit, repeat operations from 2 but from 3 to set the other louver lock in the same unit, respectively.)

6 Push **TEST** to finish the setup.

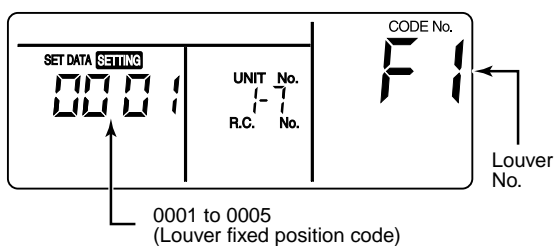

* F1 displayed at the item code on the remote controller means that the 01 louver was selected as shown in the figure.

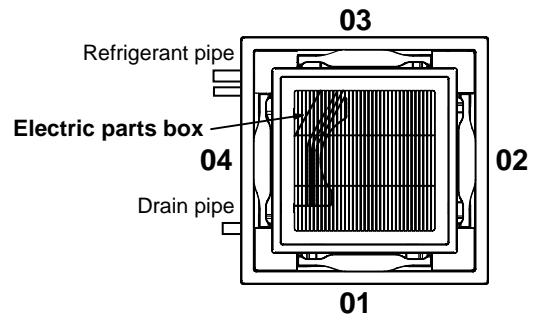

NOTIFICATION

- Even if louver lock works, the louver temporarily moves in the following cases.
 - 1) During stop
 - 2) At start of heating operation
 - 3) During defrost operation
 - 4) During thermostat OFF

5. How to clear louver lock

<For only 4-way Discharge Cassette type>

In the item 4 of the louver lock setup procedure, set the air direction to 0000.

- **⊕** mark goes off.
 - The operations from 1 to 3, 5 and 6 are same as those of the louver lock.
- Code 0000

6. How to set contents of save operation

In combination with outdoor units before 4 series, the displayed setup value exchanges, but the real operation is "75% fixed".

1 Push **SAVE** for 4 seconds or more during stop of the operation.

- **SETTING** flashes.

2 Push **UNIT LOUVER** (At the left side of the button) and select the unit to be set.

- Every pushing the button, the unit No. changes.
- The fan of the selected unit rotates and the louver swings.

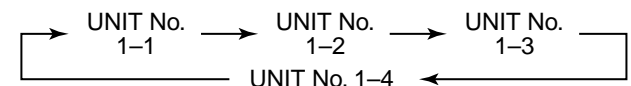

3 Determine the capacity restricted value when pushing the save button of **TIMER SET** **▼** / **▲**.

- Every pushing the button, the capacity restricted value can be set at 1% interval in the range between 100% and 50%.

* The setting at shipment is 75%.

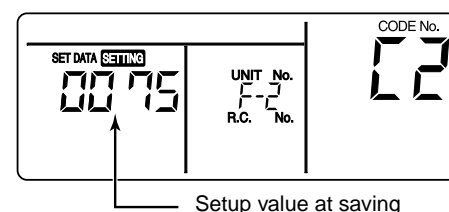

4 Push **SET** and then push **TEST** to finish the setup.

7. When installing separately sold filters

REQUIREMENT

- When you use this air conditioner for the first time, it takes approx. 5 minutes until the remote controller becomes available after power-on. This is normal.

<When power is turned on for the first time after installation>

It takes approx. 5 minutes until the remote controller becomes available.

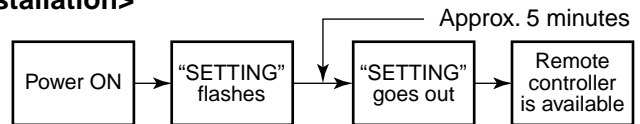

<When power is turned on for the second (or later) time>

It takes approx. 1 minute until the remote controller becomes available.

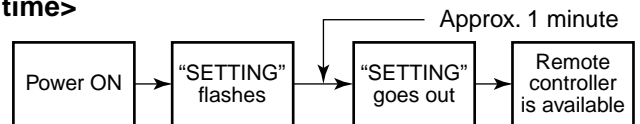

- Normal settings were made when the indoor unit was shipped from factory. Change the indoor unit settings as required.
- Use the wired remote controller to change the settings.
 - * The settings cannot be changed using the wireless remote controller, sub remote controller, or remote-controllerless system (for central remote controller only). Therefore, install the wired remote controller to change the settings.

■ Changing of settings of for applicable controls

Basic procedure for changing settings

Change the settings while the air conditioner is not working. (Be sure to stop the air conditioner before making settings.)

Procedure 1

Push button and temp. setup button simultaneously for at least 4 seconds.

After a while, the display flashes as shown in the figure. Confirm that the CODE No. is [01].

- If the CODE No. is not [01], push button to erase the display content, and repeat the procedure from the beginning. (No operation of the remote controller is accepted for a while after button is pushed.)

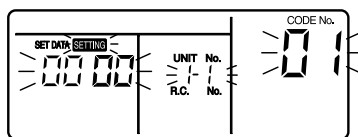

(* Display content varies with the indoor unit model.)

Procedure 2

Each time you push button, indoor unit numbers in the control group change cyclically. Select the indoor unit you want to change settings for. The fan of the selected unit runs. You can confirm the indoor unit for which you want to change settings.

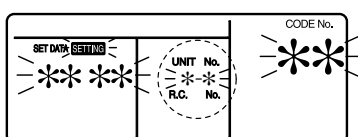

Procedure 3

Using temp. setup / buttons, specify CODE No. [**].

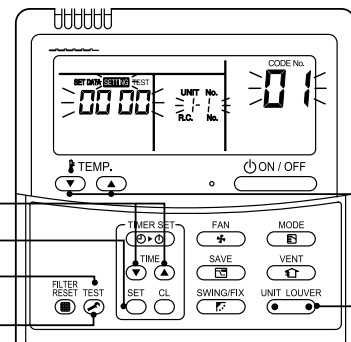
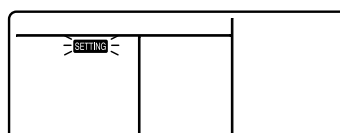

Procedure 4

Using timer time / buttons, select SET DATA [****].

Procedure 5

Push button. When the display changes from flashing to lit, the setup is completed.

- To change settings of another indoor unit, repeat from **Procedure 2**.
- To change other settings of the selected indoor unit, repeat from **Procedure 3**. Use button to clear the settings. To make settings after button was pushed, repeat from **Procedure 2**.

Procedure 6

When settings have been completed, push button to determine the settings. When button is pushed, "SETTING" flashes and then the display content disappears and the air conditioner enters the normal stop mode. (While "SETTING" is flashing, no operation of the remote controller is accepted.)

Be sure to make ceiling setting when installing separately sold filters.

- * Separately sold filters cannot be installed in an indoor unit on a high ceiling.

Follow to the basic operation procedure (1 → 2 → 3 → 4 → 5 → 6).

- For the CODE No. in **Procedure 3**, specify [5d].
- For the set data in **Procedure 4**, select the setup data of filters to be installed from the following table.

Setup data	High-ceiling setting
0000	Normal filter (Installed at factory shipping)

Setup data	High-ceiling setting
0003	High Efficiency Filter (65%) High Efficiency Filter (90%)

Installing indoor unit on high ceiling

When an indoor unit is installed on a ceiling higher than the standard height, make the high-ceiling setting for air volume adjustment.

- Take the same procedure as that in “When installing separately sold filters”.
- Select the setting data for **Procedure 4** from the “Height list of ceiling possible to be installed” table.

When wireless remote controller is used

Change the high-ceiling and filter settings with the DIP switch on the receiver section P.C. board.

For details, refer to the manual of the wireless remote controller kit.

The settings can also be changed with the switch on the indoor microcomputer P.C. board.

- * However, once the setting is changed, setting to 0001 or 0003 is possible but setting to 0000 requires a setting data change to 0000 using the wired remote controller (separately sold) with the normal switch setting (factory setting).

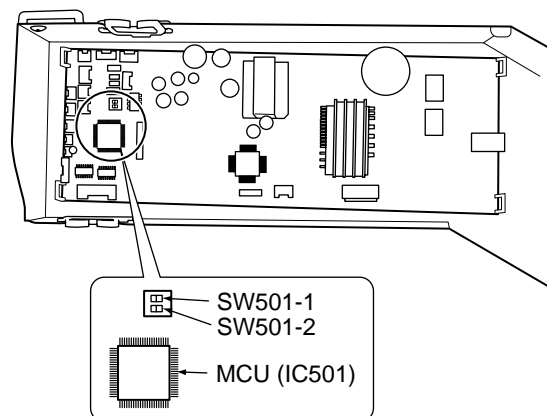

Setup data	SW501-1	SW501-2
0000 (Factory shipping)	OFF	OFF
0001	ON	OFF
0003	OFF	ON

To restore the factory settings

To return the DIP switch settings to the factory settings, set SW501-1 and SW501-2 to OFF, connect a separately sold wired remote controller, and then set the data of CODE No. [5d] to “0000” in “When installing separately sold filters” in the previous page.

12-4. Outdoor Unit

12-4-1. Refrigerant Recovery Control

The “ozone destruction coefficient” of HFC refrigerant is 0 and the discharge regulation is set as anathermal effect gas.

To this model, a switch which can perform the refrigerant recovery (pump down) by the outdoor unit is mounted so that it is easy to react against the environment at reinstalling or rejection time.

[Operation method]

- 1) Set the mode of the indoor unit to fan mode.
- 2) Set all DIP switch SW804 to OFF (Initial status) and then push the button switch SW801 for approx. 1 second. The cooling operation starts. (During this time, D805 (Green LED) flashes.) This operation finishes by 10 minutes.
- 3) After operation for 3 minutes or more, close valve at liquid side.
- 4) After recovery of refrigerant, close valve at gas side.
- 5) Push the button switch SW801 again for approx. 1 second. The outdoor unit stops.
- 6) Stop the indoor unit and then turn off the power supply.

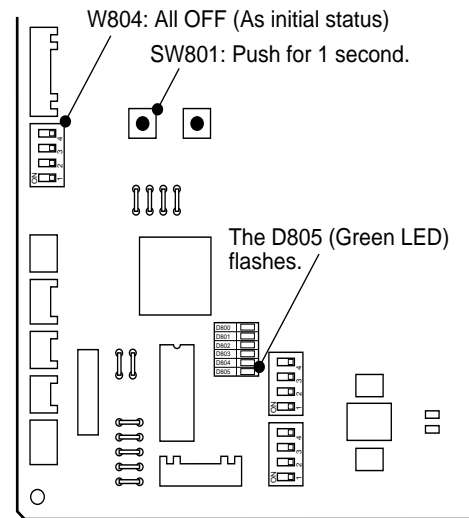

12-4-2. Various Setting on Outdoor Unit (Existing piping, Power save, Cooling-only, etc.)

The following settings are available by DIP switch setup and jumper line setup.

Function	Set position	Control contents																			
High static pressure setup	SW802 <input type="checkbox"/> High static pressure setup <input type="checkbox"/> Existing piping setup <input type="checkbox"/> Power save setup <input type="checkbox"/> Snow-proof fan control * all are OFF at shipment.	Turn the switch to ON when mounting a duct to the discharge port of the outdoor unit. Add 3 taps to the upper limit value of the outdoor fan tap. The operation is performed with (Max: Upper fan: 890 rpm / Lower fan: 910 rpm (WF)). In this case, the upper limit value of static pressure for duct is 5Pa or less on 25°C degrees and please use straight duct. In this case, the outdoor noise level may increase.																			
Existing piping setup		Turn the switch to ON when Ø19.1 is used for the existing pipe. In this case, the heating capacity may lower according to outside temp. and indoor temp. in heating operation.																			
Power save setup		Turn the switch to ON when using the power save function. The control to lower the compressor frequency (Approx. -10%) is performed by indoor heat exchanger temp. in heating operation.																			
Snow-proof fan control		When snow enters from clearance of the fan guard or heat exchanger into blast path and it is accumulated, the control to prevent generation of motor lock is validated. When outside temp. is below 0°C though the compressor stops, the outdoor fan operates with W5.																			
Defrost time change	J805, J806	The defrost interval is cut to shorten it than the standard status. For contents of control and cutting method, refer to Section 9-2-10. Defrost control.																			
Max. frequency change	J807	When it is needed to lower the maximum value of the compressor frequency, cut the jumper line. Max. frequency at cooling/heating is lowered. In this case the Max. capacity decreases. Max. frequency of compressor <table border="1" style="margin-left: 20px;"> <thead> <tr> <th rowspan="2">Model</th> <th colspan="2">RAV-SP1104</th> <th colspan="2">RAV-SP1404</th> </tr> <tr> <th>COOL</th> <th>HEAT</th> <th>COOL</th> <th>HEAT</th> </tr> </thead> <tbody> <tr> <td>Standard status</td> <td>53.4</td> <td>71.4</td> <td>64.2</td> <td>90.6</td> </tr> <tr> <td>When J807 is cut</td> <td>53.4</td> <td>64.2</td> <td>64.2</td> <td>72.0</td> </tr> </tbody> </table>	Model	RAV-SP1104		RAV-SP1404		COOL	HEAT	COOL	HEAT	Standard status	53.4	71.4	64.2	90.6	When J807 is cut	53.4	64.2	64.2	72.0
Model	RAV-SP1104			RAV-SP1404																	
	COOL	HEAT	COOL	HEAT																	
Standard status	53.4	71.4	64.2	90.6																	
When J807 is cut	53.4	64.2	64.2	72.0																	
Cooling-only setup	J808	When using the air conditioner as a cooling-only conditioner, cut the jumper line. (An air conditioner can be changed to cooling-only conditioner by “0F” of DN code on the remote controller.)																			

12-4-3. Service Support Function (LED Display, Switch Operation)

1. Outline

A various setup and operation check can be performed by DIP switches at 3 positions (SW802, SW803, SW804) and the pushdown button switches (SW800, SW801) at 2 positions.

Operation part

Part No.	Specifications	Operation contents
SW800	Pushdown button switch	Exchanges the displayed contents of LED (D800 to D804) on the outdoor control P.C. board.
SW803	DIP switch	
SW801	Pushdown button switch	Performs the specific operation to check maintenance.
SW804	DIP switch	
SW802	DIP switch	Performs various initial settings. (Refer to 12-4-2.)

Display part

Part No.	Specifications	Operation contents
D502	Orange LED	Indoor/Outdoor communication (Serial communication) signal display (Receive signal from indoor signal)
D503	Green LED	Indoor/Outdoor communication (Serial communication) signal display (Send signal from outdoor signal)
D800 to D804	Yellow LED	Error display When all SW803 are OFF, or when any of D800 to D804 goes on, LED displays that the outdoor controller detects an error. When status of SW803 is other than OFF, various indications are displayed.
D805	Green LED	Power-ON display When the power of the outdoor unit is turned on, LED goes on. When SW801 and SW804 operate the specific operation, LED flashes.

* All LED are colorless when it goes off.

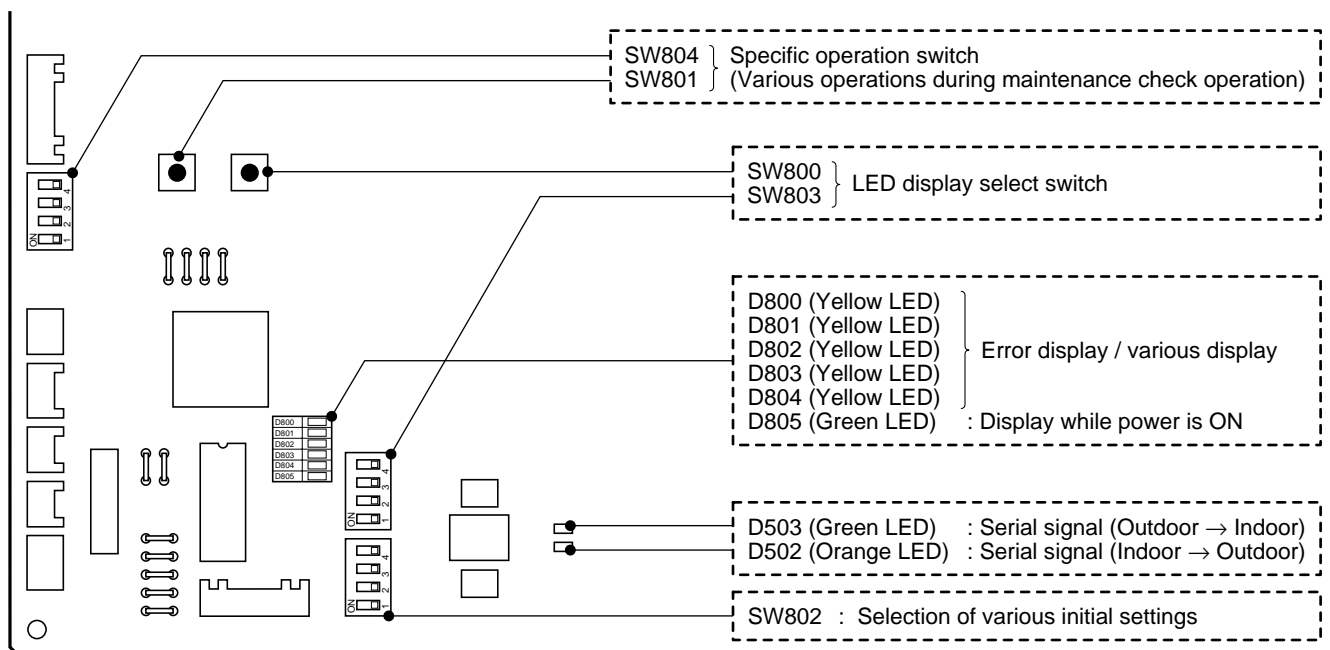

12-4-4. Others

1. Selection of LED display (SW800, SW803 operation)

1) Display selection list

The displayed contents of LED D800 to D804 on the outdoor control P.C. board can be exchanged by operation of SW803.

Switch	Function / Contents	Refer
<p>SW803</p>	<p>Error display (Error generating at present) Error generating at present is displayed. This switch goes off when an error does not generate.</p>	<p>Refer to Page 169.</p>
<p>SW803</p>	<p>Error display (The latest error: Latest error including present) After error status was cleared, the error which generated before can be confirmed by this setting. (Reconfirmation is available even if power supply was turned off once.)</p> <ul style="list-style-type: none"> • If an error generates at present, the same contents as those of error which is generating at present are displayed. • Only error of TO sensor is not displayed by this setting. (Confirm it by setting of error which is generating at present.) 	<p>Refer to Page 169.</p>
<p>TD SW803 TE SW803 TS SW803</p> <p>TO SW803 TL SW803 TH SW803</p> <p>TA SW803 TC SW803 TCJ SW803</p>	<p>Temperature sensor display The detected value of temperature sensor is displayed.</p>	<p>Refer to Page 170.</p>
<p>SW803</p>	<p>Current display The current value which flows in the outdoor unit is displayed.</p>	<p>Refer to Page 170.</p>
<p>SW803</p>	<p>Compressor operation frequency display The operation frequency of the compressor is displayed.</p>	<p>Refer to Page 170.</p>
<p>SW803</p>	<p>PMV opening display The opening of PMV (Pulse Motor Valve) is displayed.</p>	<p>Refer to Page 170.</p>

2) Error display

The error which is generating at present and the latest error (Latest error information including present) can be confirmed by lighting LED D800 to D804 on the outdoor control P.C. board.

- When all DIP switch SW803 are OFF, the status of error which is generating at present is displayed.
- <1> only of DIP switch SW803 is turned on, the error which generated before (Latest error information including present) is displayed.a)
- If there is an error, any of LED D800 to D804 goes on. (Display 1)
- When pushing the pushdown button switch SW800 for approx. 1 second, the display is exchanged. (Display 2)
- When pushing SW800 again or after 2 minutes, the status returns to that of Display ①.

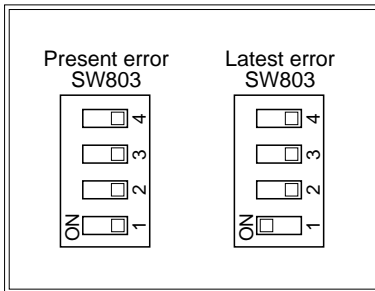

(Legend)

- D800 (Yellow)
- D801 (Yellow)
- ◎ D802 (Yellow)
- D803 (Yellow)
- D804 (Yellow)
- D805 (Green)

● : Go off, ○ : Go on, ◎ : Flash

Display 1) (Initial display)	Display 2) (SW800 operation)	Error contents	Wired remote controller Error code
●●●●●○	●●●●●○	Normal	—
○○●●○○	●●◎●●○	Discharge temp. sensor (TD) error	F04
	●◎◎●●○	Heat exchanger temp. sensor (TE) error	F06
	◎◎◎●●○	Heat exchanger temp. sensor (TL) error	F06, F07
	●●●◎●○	Outside temp. sensor (TO) error	F08
	●●◎◎●○	Suction temp. sensor (TS) error	F06, F12
	◎●◎◎●○	Heat sink temp. sensor (TH) error	F13, L29
	◎◎◎◎●○	Heat exchanger sensor (TE, TS) miswiring	F06, F15
	◎◎◎◎◎○	EEPROM error	F31, L29
●●○○○○	◎●●●●○	Compressor break down	H01
	●◎●●●○	Compressor lock	H02
	◎◎●●●○	Current detection circuit error	H03
	●●◎●●○	Case thermostat operation	H04, P04
●○○○○○	●◎●◎●○	Model unset	L10, L29
	◎●◎◎◎○	Communication error between MCU	L29
	◎◎◎◎◎○	Other error (Compressor disorder, etc.)	Error is not determined.
○○○●○○	◎◎●●●○	Discharge temp. error	P03
	◎●◎●●○	Power supply error	P04, P05
	◎◎◎●●○	Heat sink overheat error	P07, L29
	◎◎◎◎●○	Gas leak detection	P15, L29
	◎◎●●◎○	4-way valve reverse error	P19, L29
	●●◎●◎○	High pressure protective operation	P04, P20
	●◎◎●◎○	Fan system error	P22
	●◎●◎◎○	Driving element short-circuit	P26
	◎●◎◎◎○	Position detection circuit erro	P29

* As the error code displayed on the wired remote controller may differ according to type of indoor model, multiple codes are described.

3) Sensor, current, compressor operation frequency, PMV opening display

The values detected by the controller, such as temperature sensor or current value are simply confirmed.

(Legend)

- D800 (Yellow)
- D801 (Yellow)
- D802 (Yellow)

- D803 (Yellow)
- D804 (Yellow)
- D805 (Green)

● : Go off, ○ : Go on

Item setup LED display	Temperature sensor (°C)					Current (A)	Compressor operation frequency (rpm)	PMV opening (Pulse)
	TD SW803	TE SW803	TS SW803	TO SW803	TL SW803			
●●●●●○	Below -25					0 to 0.9	0 to 4	0 to 19
○●●●●○	-25 to -21					1 to 1.9	5 to 9	20 to 39
●○●●●○	-20 to -16					2 to 2.9	10 to 14	40 to 59
○○●●●○	-15 to -11					3 to 3.9	15 to 19	60 to 79
●●○●●○	-10 to -5					4 to 4.9	20 to 24	80 to 99
○●●●●○	-5 to -1					5 to 5.9	25 to 29	100 to 119
●○○●●○	0 to 4					6 to 6.9	30 to 34	120 to 139
○○○●●○	5 to 9					7 to 7.9	35 to 39	140 to 159
●●●○●○	10 to 14					8 to 8.9	40 to 44	160 to 179
○●●○●○	15 to 19					9 to 9.9	45 to 49	180 to 199
●○●○●○	20 to 24					10 to 10.9	50 to 54	200 to 219
○○●○●○	25 to 29					11 to 11.9	55 to 59	220 to 239
●●○○●○	30 to 34					12 to 12.9	60 to 64	240 to 259
○●○○●○	35 to 39					13 to 13.9	65 to 69	260 to 279
●○○○●○	40 to 44					14 to 14.9	70 to 74	280 to 299
○○○○●○	45 to 49					15 to 15.9	75 to 79	300 to 319
●●●●○	50 to 54					16 to 16.9	80 to 84	320 to 339
○●●●○	55 to 59					17 to 17.9	85 to 89	340 to 359
●○●●○	60 to 64					18 to 18.9	80 to 84	360 to 379
○○●●○	65 to 69					19 to 19.9	95 to 99	380 to 399
●●○●○	70 to 74					20 to 20.9	100 to 104	400 to 419
○●○●○	75 to 79					21 to 21.9	105 to 109	420 to 439
●○○●○	80 to 84					22 to 22.9	110 to 114	440 to 459
○○○●○	85 to 89					23 to 23.9	115 to 119	460 to 479
●●●○○	90 to 94					24 to 24.9	120 to 124	480 to 499
○●●○○	95 to 99					25 to 25.9	125 to 129	500
●○●○○	100 to 104					26 to 26.9	130 to 134	—
○○●○○	105 to 109					27 to 27.9	135 to 139	—
●●○○○	110 to 114					28 to 28.9	140 to 144	—
○●○○○	115 to 119					29 to 29.9	145 to 149	—
●○○○○	Over 120					30 to 30.9	150 to 154	—
○○○○○	Sensor error, unconnected					Over 31	Over 155	—

* As TD, TL and TH are sensors for high temperature, there is error at normal temperature or below position.

* For current value, the current for the outdoor unit only is displayed.

4) Specific operation for maintenance check (SW801, SW804)

The following specific operations for the maintenance check are performed by operation of SW801 or SW804.

- a) Select DIP switch SW804. (See table below)
- b) Push the pushdown button switch SW801 for approx. 1 second.
- c) The following functions start. While each function starts, LED D805 (Green) flashes.
- d) When pushing the pushdown button switch SW801 again for approx. 1 second, when selecting DIP switch SW804 or when the specified time of each function elapsed, each function stops and LED D805 (Green) returns to the continuous lighting.

<Specific operation>

SW804	Operation when pushdown button switch SW801 is pushed	
	Refrigerant recovery operation The outdoor unit performs cooling operation. The indoor unit does not work by this operation alone. Therefore operate the fan beforehand. (Refer → 12-4-1. Refrigerant Recovery Control)	
	Indoor cooling test run demand The cooling test run is performed. (→ Note 1)	
	Indoor heating test run demand The heating test run is performed. (→ Note 1)	
	Fan motor forced operation Drive the fan motor forcedly. When pushing SW801 again or when 2 minutes elapsed, the operation returns to the normal control.	
	(No operation especially)	[NOTE] Although these operations can be performed even during operation, basically perform operation while the unit stops. If performing this operation during driving the unit, it is dangerous because the pressure may change suddenly.
	PMV full open operation Open PMV (Pulse Motor Valve) fully. When pushing SW801 again or when 2 minutes elapsed, the operation returns to the normal control.	
	PMV full close operation Close PMV (Pulse Motor Valve) fully. When pushing SW801 again or when 2 minutes elapsed, the operation returns to the normal control.	
	PMV middle opening operation Set PMV (Pulse Motor Valve) to middle opening (250 pulses). When pushing SW801 again or when 2 minutes elapsed, the operation returns to the normal control.	

Note 1) Indoor cooling test run demand / Indoor heating test run demand
 Only when combining with the following indoor unit, cooling/heating operation can be performed from the outdoor unit.

Test run is available: Indoor unit of 4 series and after (RAV-SM***4UT-E etc.)

Test run is unavailable: Indoor units other than the above-mentioned indoor units, or indoor units other than above-mentioned indoor units are included in the twin connection.

Note 2) The forced test run by this setting cannot be cleared on the indoor remote controller.

Be sure to clear the test run by operation of the outdoor unit. (Push SW801 again for 1 second.)

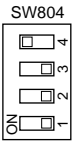
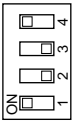
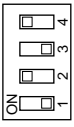
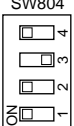
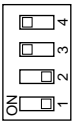
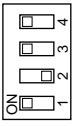
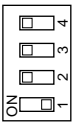
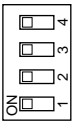
SW804	Operation when pushdown button switch SW801 is pushed	
	<p>4-way valve relay operation (For RY700, CN70 check) Turn on 4-way valve power relay (RY700). When pushing SW801 again or when 2 minutes elapsed, the operation returns to the normal control.</p> <p>[NOTE] In case of model adopting the self hold valve (RAV-SP1104AFE, RAV-SP1404T-E), the coil develops fever. Therefore do not perform this operation as coil is connected.</p>	
	<p>Self-hold valve suction operation (Exchange to heating cycle) (For RY700 RY701, RY705, CN701 check) Turn on relay RY700, RY701, RY705. (CN701 between ① and ④ : Voltage=Approx. +198 to 380V) This function works for 10 seconds and then is OFF.</p>	
	<p>Self-hold valve separation operation (Exchange to cooling cycle) Turn on relay RY700. (CN701 between 1) and 4): Voltage=Approx. -198 to 380V) This function works for 10 seconds and then is OFF.</p>	
	<p>SV valve relay operation (For RY702, CN702 check) Turn on SV valve relay (RY702). When pushing SW801 again or when 2 minutes elapsed, the operation returns to the normal control. * For RAV-SP1104 to RAV-SP1404, the part is not mounted, so do not operate.</p>	<p>[CAUTION] Although these operations can be performed even during operation, basically perform operation while the unit stops. If performing this operation during driving the unit, it is dangerous because the pressure may change suddenly.</p>
	<p>Heater output relay operation (For check RY703, CN703 check) Turn on relay for option heater (RY703). When pushing SW801 again or when 2 minutes elapsed, the operation returns to the normal control.</p>	
	<p>Outside output relay operation (RY704, CN704) Turn on relay for outside output (RY704). When pushing SW801 again or when 2 minutes elapsed, the operation returns to the normal control.</p>	
	<p>(No operation especially)</p>	
	<p>Relay operation change for outside output [CAUTION] Do not use this setting.</p>	

13. ADDRESS SETUP

13-1. Address Setup Procedure

When an outdoor unit and an indoor unit are connected, or when an outdoor unit is connected to each indoor unit respectively in the group operation even if multiple refrigerant lines are provided, the automatic address setup completes with power-ON of the outdoor unit. The operation of the remote controller is not accepted while automatic address works. (Approx. 4 to 5 minutes)

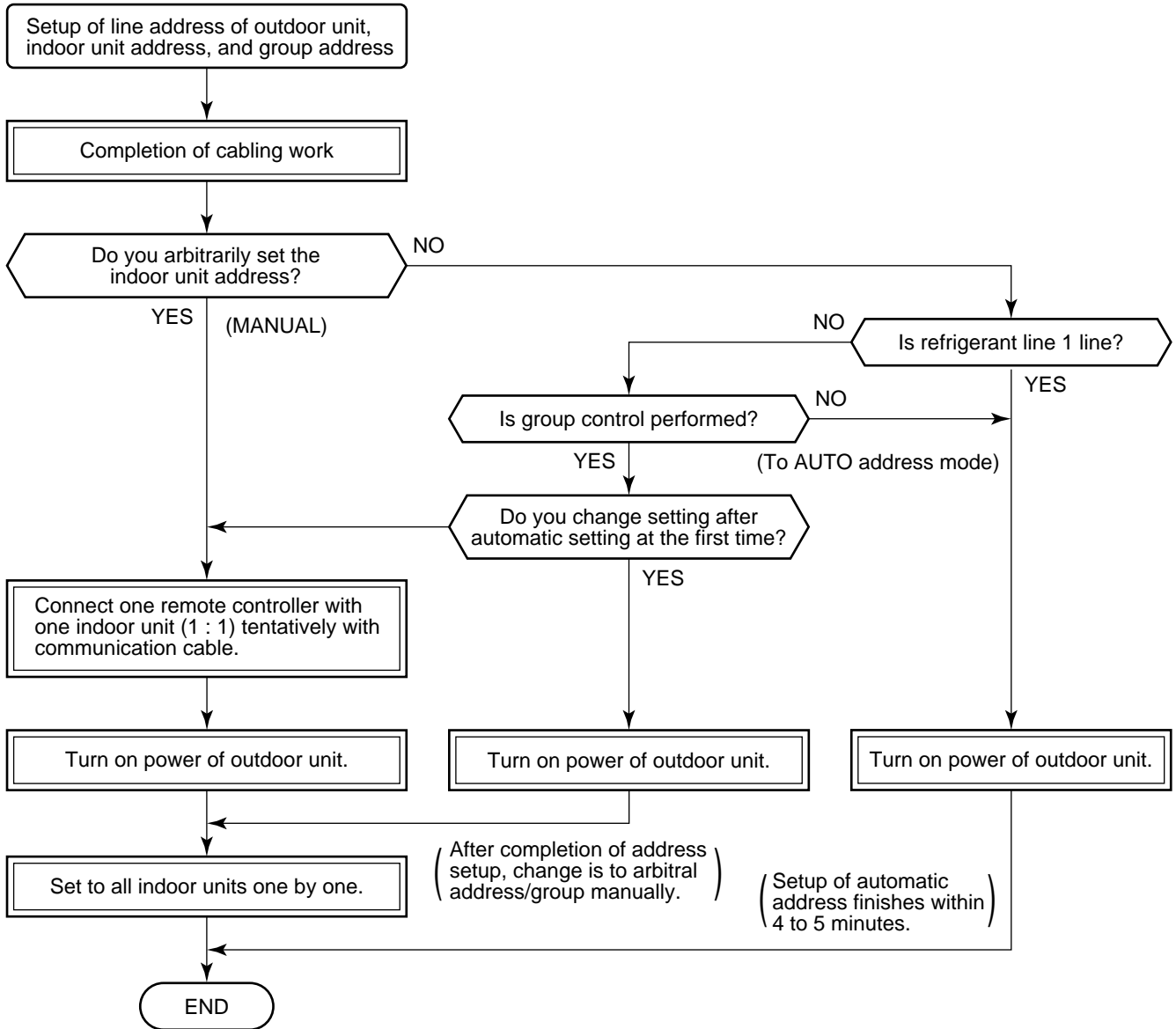

- When the following addresses are not stored in the neutral memory (IC503) on the indoor P.C. board, a test run operation cannot be performed. (Unfixed data at shipment from factory)

	Item code	Data at shipment	Setup data range
Line address	12	0099	0001 (No. 1 unit) to 0064 (No. 64 unit)
Indoor unit address	13	0099	0001 (No. 1 unit) to 0064 (No. 64 unit) Max. value of indoor units in the identical refrigerant line
Group address	14	0099	0000 : Individual (Indoor units which are not controlled in a group) 0001 : Master unit (1 indoor unit in group control) 0002 : Sub unit (Indoor units other than master unit in group control)

13-2. Address Setup & Group Control

<Terminology>

Indoor unit No. : N - n = Outdoor unit line address N (Max. 30) - Indoor unit address n (Max. 64)

Group address : 0 = Single (Not group control)
 1 = Master unit in group control
 2 = Sub unit in group control

Master unit (= 1) : The representative of multiple indoor units in group operation sends/receives signals to/from the remote controllers and sub indoor units.
 (* It has no relation with an indoor unit which communicates serially with the outdoor units.)
 The operation mode and setup temperature range are displayed on the remote controller LCD.
 (Except air direction adjustment of louver)

Sub unit (= 2) : Indoor units other than master unit in group operation
 Basically, sub units do not send/receive signals to/from the remote controllers.
 (Except errors and response to demand of service data)

Header unit (Representative unit) (Master Twin)

: This unit communicates with the indoor unit (follower) which serial-communicates with the outdoor units and sends/receives signal (Command from compressor) to/from the outdoor units as the representative of the cycle control in the indoor units of the identical line address within the minimum unit which configures one of the refrigerating cycles of Twin.

Follower unit (Subordinate unit) (Sub Twin)

: Indoor units excluding the header unit in Twin

This unit communicates with (Header) indoor unit in the identical line address and performs control synchronized with (Header) indoor unit.

This unit does not perform the signal send/receive operation with the outdoor units. :
 No judgment for serial signal error.

13-2-1. System Configuration

1. Single

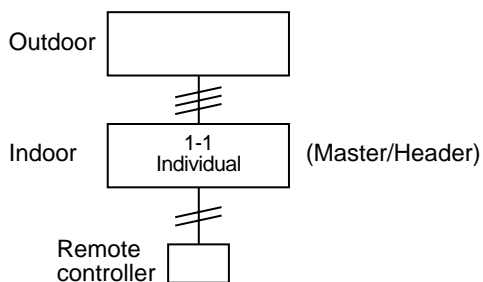

2. Twin

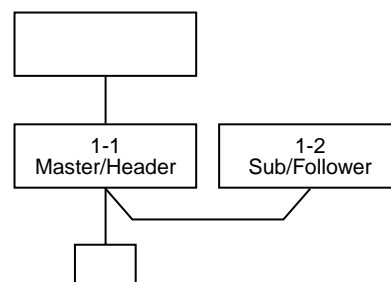

3. Single group operation

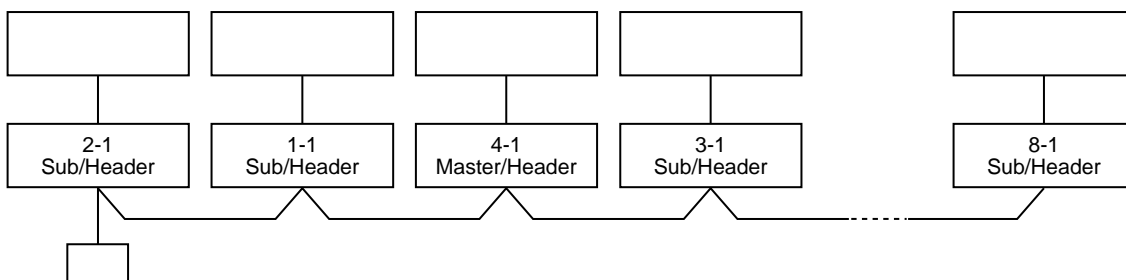

13-2-2. Automatic Address Example from Unset Address (No miswiring)

1. Standard (One outdoor unit)

1) Single

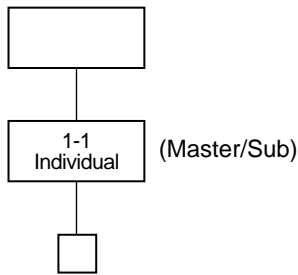

2) Group operation (Twin, Triple operation)

(Multiple outdoor units = Multiple indoor units only with serial communication)

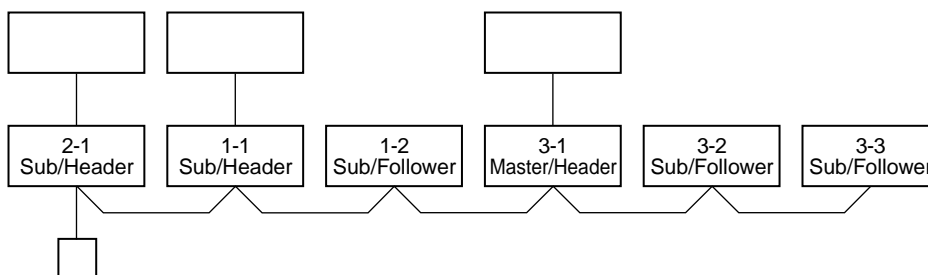

Only turning on source power supply (Automatic completion)

- Header unit: The header unit receives the indoor unit data (thermo status) of the follower (Without identical line address & indoor/outdoor serial) and then finally controls the outdoor compressor matching with its own thermo status.
The header unit sends this command information to the follower unit.
- Follower unit: The follower unit receives the indoor unit data from the header (With identical line address & indoor/outdoor serial) and then performs the thermo operation synchronized with the header unit.
The follower unit sends own thermo ON/OFF demand to the header unit.

(Example)

No. 1-1 header unit sends/receives signal to/from No. 1-2 and No. 1-3 follower units.
(It is not influenced by the line 2 or 3 address indoor unit.)

13-2-3. Automatic Address Example from Unset Address (No miswiring)

1. Standard (One outdoor unit)

1) Single

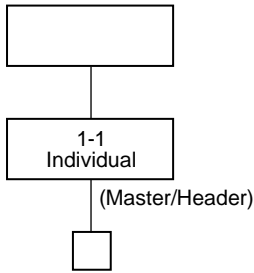

2) Twin

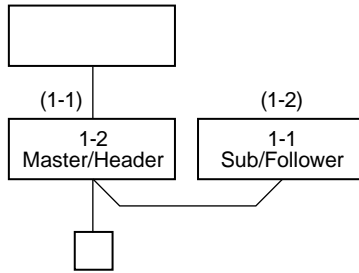

3) Triple

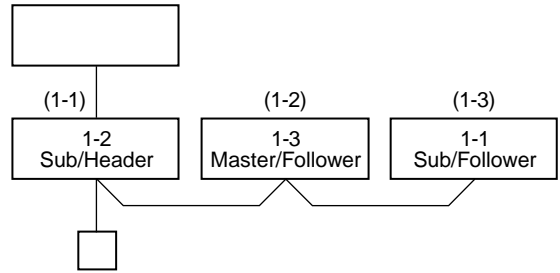

Only turning on source power supply (Automatic completion)

2. Group operation

(Multiple outdoor units = Multiple indoor units with serial communication only, without twin)

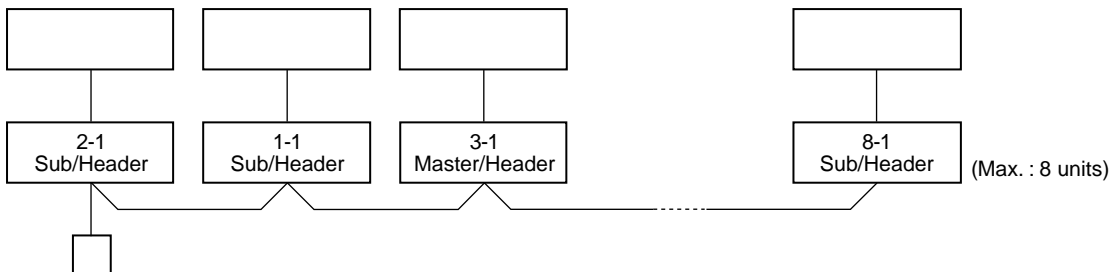

Only turning on source power supply (Automatic completion)

3. Multiple groups operation

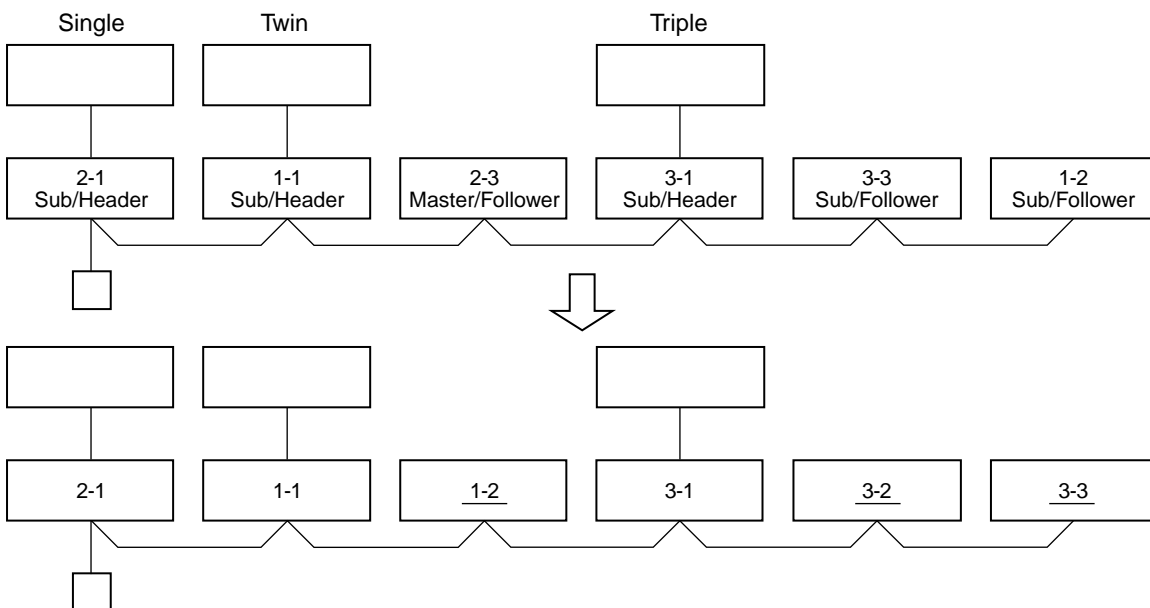

Change is necessary

Manually change addresses of the multiple follower units simultaneously from the remote controller.

13-3. Remote Controller Wiring

- Strip off approx. 9 mm the wire to be connected.
- For single system, use non polarity, 2 core wire is used for wiring of the remote controller. (0.5 mm² to 2.0 mm² wires)
- For the synchronous twin, triple system, use 2-core shield wire (Vinyl cord for microphone 0.5 to 2.0 mm²) to conform to the EMC standard.

Wiring diagram

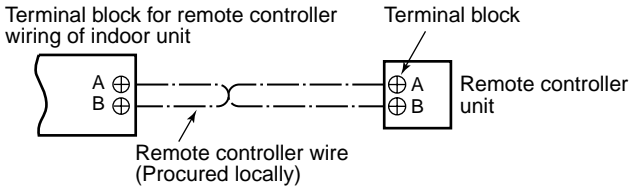

* For details of wiring/installation of the remote controller, refer to the Installation Manual enclosed with the remote controller.

<Single system>

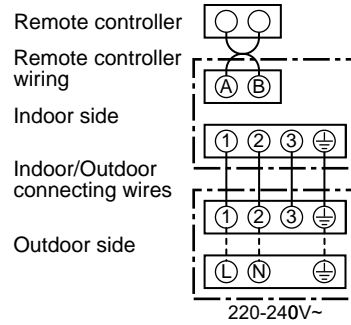

■ RAV-SP1104AT-E, RAV-SP1404AT-E

<Synchronous twin system>

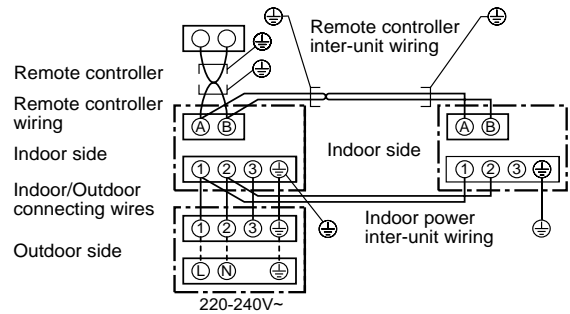

■ RAV-SM1603AT-E

⚠ WARNING

For synchronous twin and synchronous triple systems, perform the following to conform to EMC standards.

<Synchronous twin system>

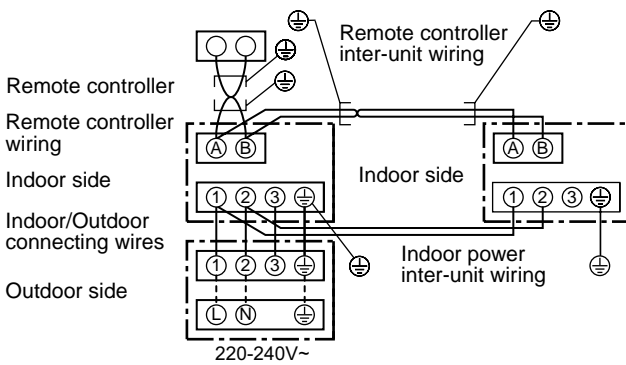

* Use 2-core shield wire (Vinyl cord for microphone 0.5 to 2.0 mm² or more) for the remote controller wiring in the synchronous triple system to prevent noise problems. Be sure to connect both ends of the shield wire to the earth.

* Connect earth wire for each indoor unit in the synchronous triple system.

<Synchronous triple system>

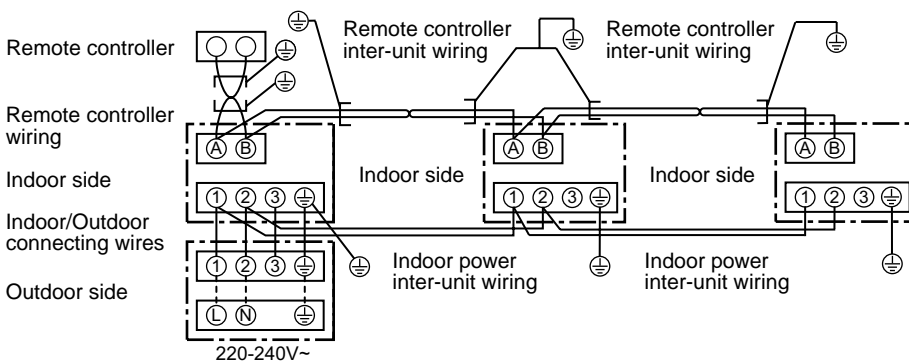

13-4. Address Setup (Manual setting from remote controller)

In case that addresses of the indoor units will be determined prior to piping work after cabling work

- Set an indoor unit per a remote controller.
- Turn on power supply.

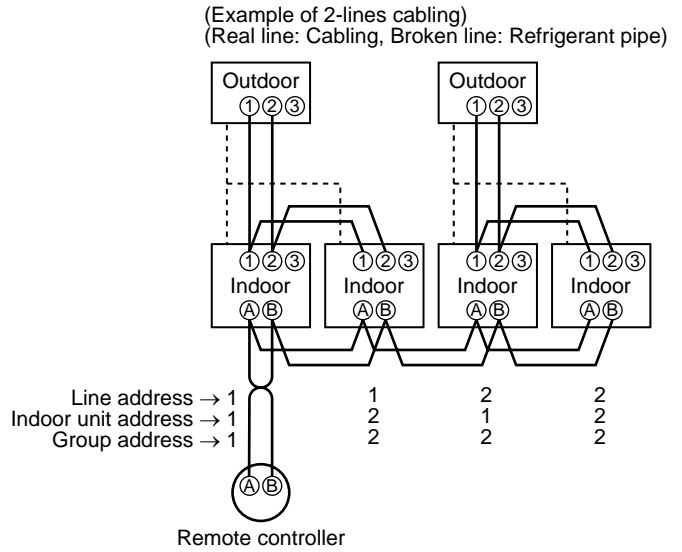

For the above example, perform setting by connecting singly the wired remote controller without remote controller inter-unit cable.

Group address
 Individual : 0000
 Master unit : 0001
 Sub unit : 0002 } In case of group control

- 1 Push **SET** + **CL** + **TEST** buttons simultaneously for 4 seconds or more.
- 2 (← Line address)
Using the temperature setup **▼** / **▲** buttons, set **12** to the item code.
- 3 Using timer time **▼** / **▲** buttons, set the line address.
- 4 Push **SET** button. (OK when display goes on.)
- 5 (← Indoor unit address)
Using the temperature setup **▼** / **▲** buttons, set **13** to the item code.
- 6 Using timer time **▼** / **▲** buttons, set 1 to the line address.
- 7 Push **SET** button. (OK when display goes on.)
- 8 (← Group address)
Using the temperature setup **▼** / **▲** buttons, set **14** to the item code.
- 9 Using timer time **▼** / **▲** buttons, set **0000** to Individual, **0001** to Master unit, and **0002** to sub unit.
- 10 Push **SET** button. (OK when display goes on.)
- 11 Push **TEST** button.
Setup completes. (The status returns to the usual stop status.)

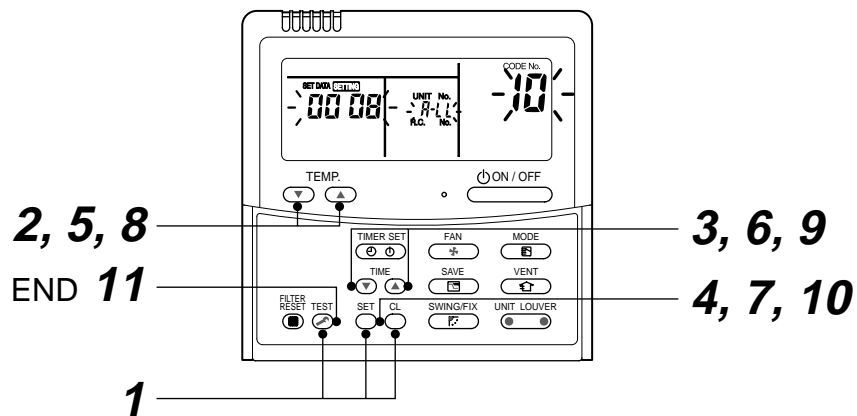

<Operation procedure>

1 → 2 → 3 → 4 → 5 → 6 → 7 → 8 → 9 → 10 → 11 END

13-5. Confirmation of Indoor Unit No. Position

1. To know the indoor unit addresses though position of the indoor unit body is recognized

- In case of individual operation (Wired remote controller : indoor unit = 1 : 1)
(Follow to the procedure during operation)

<Procedure>

1 Push  button if the unit stops.

2 Push  button.

Unit No. *1-1* is displayed on LCD.

(It disappears after several seconds.)

The displayed unit No. indicate line address and indoor unit address.

(When other indoor units are connected to the identical remote controller (Group control unit), other unit numbers are also displayed every pushing  button.

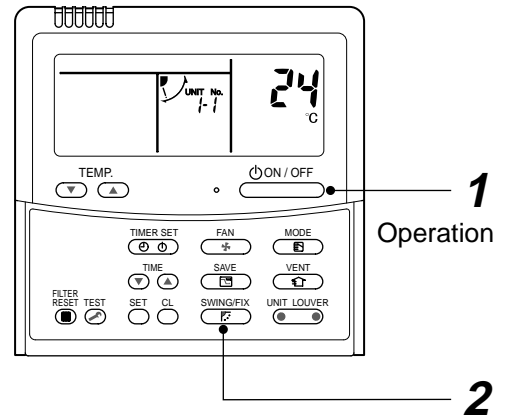

<Operation procedure>



1 → 2 END

2. To know the position of indoor unit body by address

- To confirm the unit No. in the group control
(Follow to the procedure during operation) (in this procedure, the indoor units in group control stop.)

<Procedure>

The indoor unit numbers in the group control are successively displayed, and fan, louver, and drain pump of the corresponding indoor unit are turned on.
(Follow to the procedure during operation)

1 Push  and  buttons simultaneously for 4 seconds or more.

- Unit No. *ALL* is displayed.
- Fans and louvers of all the indoor units in the group control operate.

2 Every pushing  button, the unit numbers in the group control are successively displayed.

- The unit No. displayed at the first time indicates the master unit address.
- Fan and louver of the selected indoor unit only operate.

3 Push  button to finish the procedure.
All the indoor units in the group control stop.

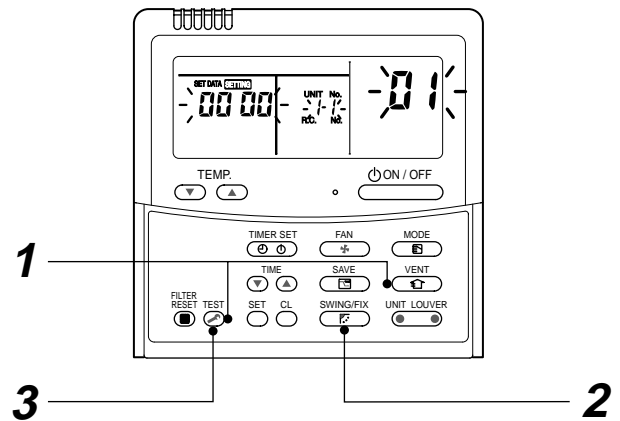

<Operation procedure>

1 → 2 → 3 END

<Maintenance/Check list>

Aiming in environmental preservation, it is strictly recommended to clean and maintain the indoor/outdoor units of the operating air conditioning system regularly to secure effective operation of the air conditioner.

It is also recommended to maintain the units once a year regularly when operating the air conditioner for a long time.

Check periodically signs of rust or scratches, etc. on coating of the outdoor units.

Repair the defective position or apply the rust resisting paint if necessary.

If an indoor unit operates for approx. 8 hours or more per day, usually it is necessary to clean the indoor/outdoor units once three months at least.

These cleaning and maintenance should be carried out by a qualified dealer.

Although the customer has to pay the charge for the maintenance, the life of the unit can be prolonged.

Failure to clean the indoor/outdoor units regularly will cause shortage of capacity, freezing, water leakage or trouble on the compressor.

Part name	Object		Contents of check	Contents of maintenance
	Indoor	Outdoor		
Heat exchanger	○	○	<ul style="list-style-type: none"> • Blocking with dust, damage check 	<ul style="list-style-type: none"> • Clean it when blocking is found.
Fan motor	○	○	<ul style="list-style-type: none"> • Audibility for sound 	<ul style="list-style-type: none"> • When abnormal sound is heard
Filter	○	—	<ul style="list-style-type: none"> • Visual check for dirt and breakage 	<ul style="list-style-type: none"> • Clean with water if dirty • Replace if any breakage
Fan	○	○	<ul style="list-style-type: none"> • Visual check for swing and balance • Check adhesion of dust and external appearance. 	<ul style="list-style-type: none"> • Replace fan when swinging or balance is remarkably poor. • If a large dust adheres, clean it with brush or water.
Suction/ Discharge grille	○	—	<ul style="list-style-type: none"> • Visual check for dirt and scratch 	<ul style="list-style-type: none"> • Repair or replace it if deformation or damage is found.
Drain pan	○	—	<ul style="list-style-type: none"> • Check blocking by dust and dirt of drain water. 	<ul style="list-style-type: none"> • Clean drain pan, Inclination check
Face panel, Louver	○	—	<ul style="list-style-type: none"> • Check dirt and scratch. 	<ul style="list-style-type: none"> • Cleaning/Coating with repair painting
External appearance	—	○	<ul style="list-style-type: none"> • Check rust and peeling of insulator • Check peeling and floating of coating film 	<ul style="list-style-type: none"> • Coating with repair painting

14. DETACHMENTS

14-1. Indoor Unit

14-1-1. 4-Way Air Discharge Cassette Type

RAV-SM564UT-E, RAV-SM804UT-E, RAV-SM1104UT-E, RAV-SM1404UT-E, RAV-SM1604UT-E

No.	Part name	Procedure	Remarks
①	Suction grille	<p style="text-align: center;">CAUTION</p> <p>Be sure to put on the gloves at disassembling work; otherwise an injury will be caused by a part, etc.</p> <p>1. Detachment</p> <ol style="list-style-type: none"> 1) Stop operation of the air conditioner and then turn off switch of the breaker. 2) Slide the 2 knobs of the suction grille inward and then hang down the suction grille. 3) Remove a strap connecting the panel and the suction grille and then remove the suction grille. <p>2. Attachment</p> <ol style="list-style-type: none"> 1) Hook the suction grille to the panel. 2) Attach strap of the suction grille to the panel as before. 3) Close the suction grille, slide the knobs outward and then fix the panel. 	
②	Electric parts cover	<p>1. Detachment</p> <ol style="list-style-type: none"> 1) Carry out work of item 1. of ①. 2) Remove the fixing screw A which fixes the electric parts cover and loosen the fixing screw B. 3) Pull down the electric parts cover, remove pin of the bell mouth and then slide it to the arrow direction in order to open the claws and the electric parts box cover. <p>2. Attachment</p> <ol style="list-style-type: none"> 1) Close the electric parts cover and slide it, hook claw of the electric parts box, hook claw of the electric parts box cover and the Dharma doll hole, and then insert pin of the bell mouth into hole of the electric parts box cover. 2) Tighten the fixing screws A and B and then fix the electric parts box cover. 3) Following to work of item 2 of ①, mount the suction grille as before. 	

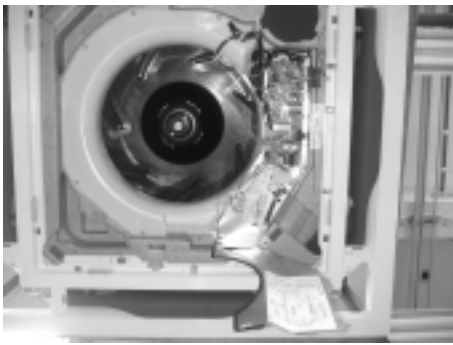
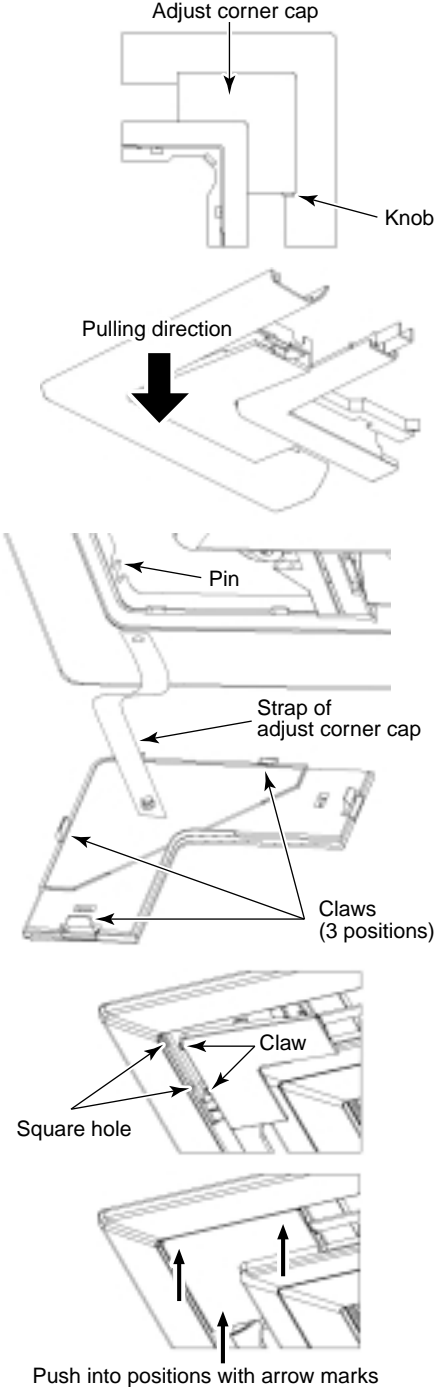
No.	Part name	Procedure	Remarks
②	Electric parts cover (Continued)		
③	Adjust corner cap	<p>1. Detachment</p> <ol style="list-style-type: none"> 1) Pull knob of the adjust corner cap to the arrow direction, remove strap of the adjust corner cap from pin of the panel and then remove all the 4 corners of the cap. <div style="border: 1px solid black; padding: 5px; margin: 10px 0;"> <p>NOTE : The knob is provided to only one side. Be sure to remove the cap of the knob side at first.</p> </div> <p>2. Attachment</p> <ol style="list-style-type: none"> 1) Hook strap of the adjust corner cap securely to pin of the ceiling panel. 2) Insert claw of the adjust corner cap into the square hole of the panel. (2 positions) 3) Push claws of the adjust corner cap into the positions indicated with arrow marks so that they fit in 3 positions. 	 <p>Adjust corner cap</p> <p>Knob</p> <p>Pulling direction</p> <p>Pin</p> <p>Strap of adjust corner cap</p> <p>Claws (3 positions)</p> <p>Square hole</p> <p>Claw</p> <p>Push into positions with arrow marks</p>

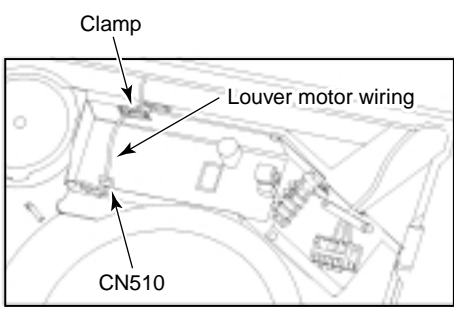
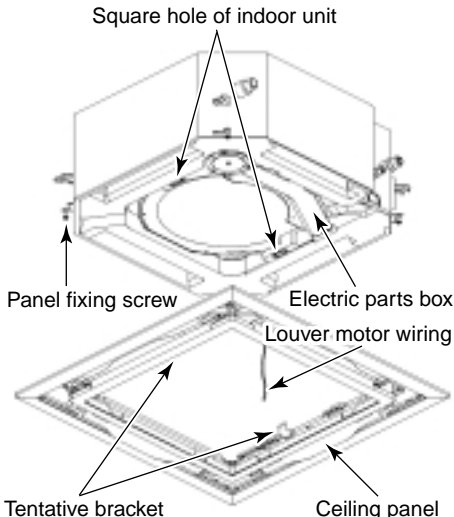
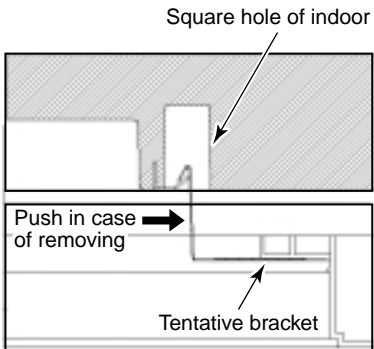
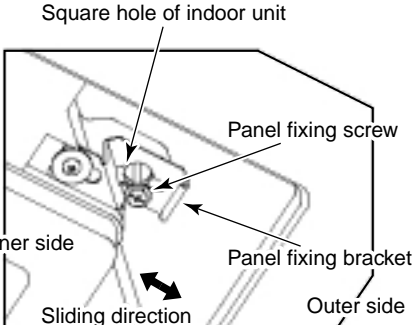
No.	Part name	Procedure	Remarks
④	Ceiling panel	<p>1. Detachment</p> <ol style="list-style-type: none"> 1) Carry out works of item 1 of ② and item 1 of ③. 2) Remove the flap connector (CN510, White, 20P) connected to the control P.C. board and then remove the lead wire from the clamp. <div style="border: 1px solid black; padding: 5px; margin: 10px 0;"> <p>NOTE : Unlock the lock of the housing part and then remove the connector.</p> </div> <ol style="list-style-type: none"> 3) Loosen the panel fixing 4 screws. 4) Slide the panel fixing brackets (4 positions) outward. 5) Push the tentative bracket outward and then remove the ceiling panel. <p>2. Attachment</p> <ol style="list-style-type: none"> 1) Insert the tentative brackets (2 positions) of the ceiling panel into square holes of the indoor unit and then hook the panel tentatively. <div style="border: 1px solid black; padding: 5px; margin: 10px 0;"> <p>NOTE : The ceiling panel has the directional properties against the indoor unit. Direct the louver motor wire to the electric parts box side of the indoor unit.</p> </div> <ol style="list-style-type: none"> 2) Pass the head of the panel fixing screw through hole of the panel fixing bracket and then slide the panel fixing bracket inward. 3) Tighten in the panel fixing screw to fix the ceiling panel. 4) Following to work of item 2 of ③, attach the adjust corner cap as before. 5) Connect the louver connector (CN510, White, 20P) as before and then fix the lead wire with clamp. 6) Following to work of item 2 of ②, mount the electric parts box cover and the suction grille as before. 	   

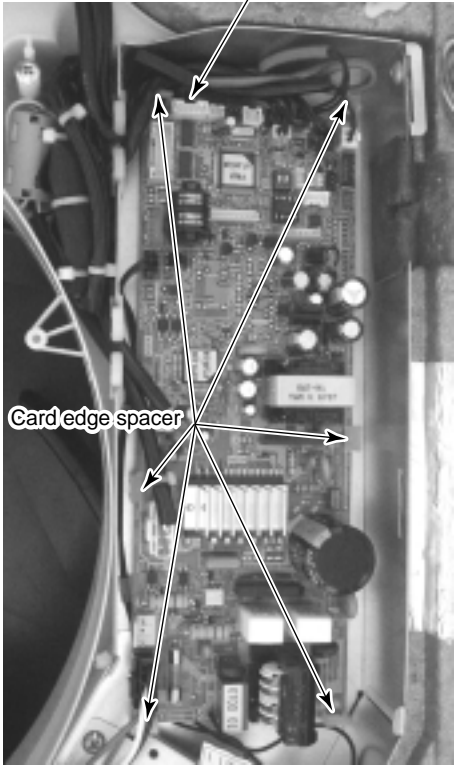

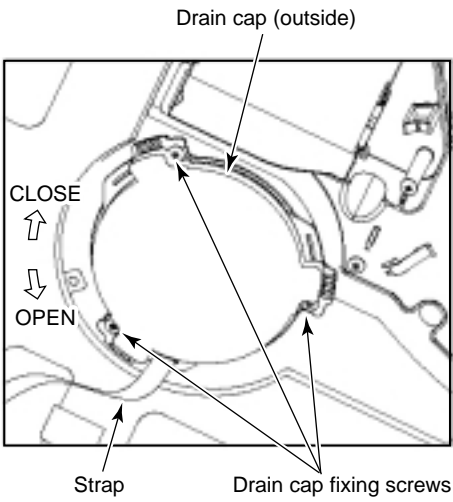
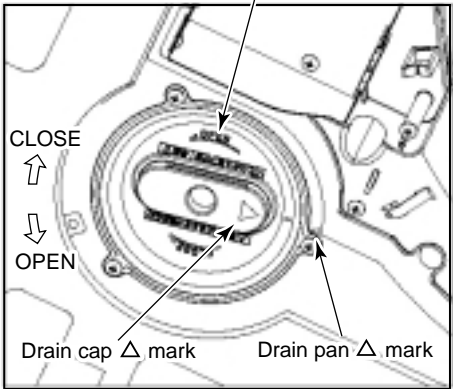
No.	Part name	Procedure	Remarks
⑤	Control P.C. board	<p>1. Detachment</p> <ol style="list-style-type: none"> 1) Carry out work of item 1 of ②. 2) Remove connectors which are connected from the control P.C. board to the other parts and then remove wiring from the clamp. <p>CN510 : Louver motor (20P, White) CN34 : Float switch (3P, Red) CN504 : Drain pump (2P, White) CN101 : TC sensor (2P, Black) CN102 : TCJ sensor (2P, Red) CN104 : Room temp. Sensor (2P, Orange) CN333 : Fan motor power supply (5P, White) CN334 : Fan motor position detection (3P, White)</p> <div style="border: 1px solid black; padding: 5px; margin: 10px 0;"> <p>NOTE : Unlock the lock of the housing part and then remove the connector.</p> </div> <ol style="list-style-type: none"> 3) Unlock the locks of the card edge spacer (6 positions) and then remove the control P.C. board. <p>2. Attachment</p> <ol style="list-style-type: none"> 1) Fix the control P.C. board to the card edge spacer (6 positions) 2) Connect the connector removed in item 1 as before and then fix the wiring with the clamp. 3) Following to work of item 2 of ②, mount the electric parts box cover and the suction grille as before. 	

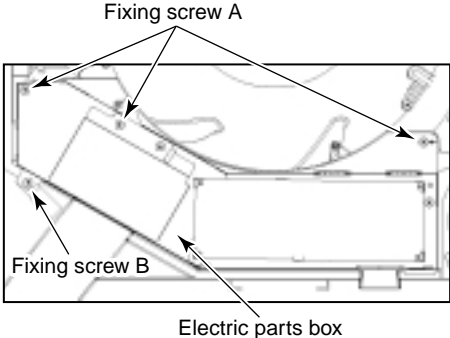
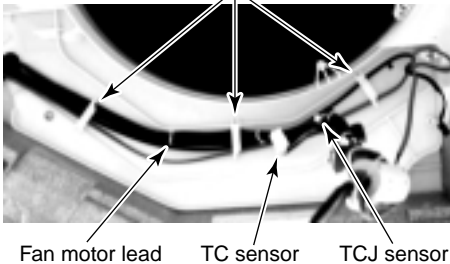
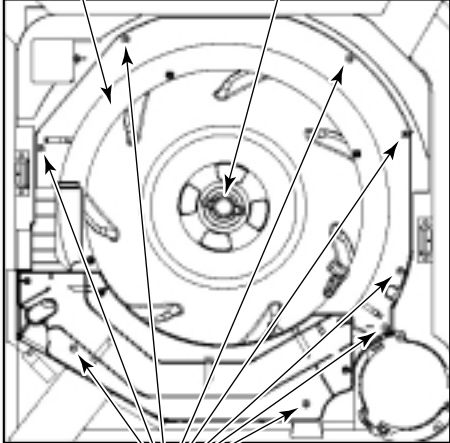
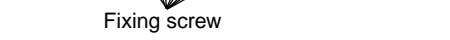
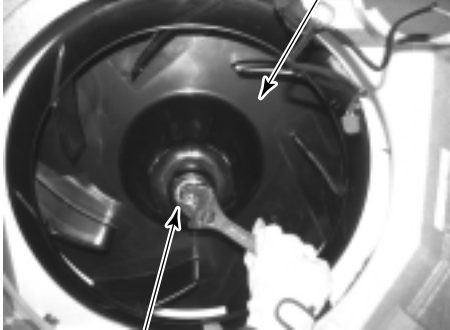
No.	Part name	Procedure	Remarks
⑥	Drain cap	<p>1. Detachment</p> <ol style="list-style-type: none"> 1) Carry out work of item 1 of ①. 2) Loosen screws (3 positions) fixing the drain cap (outside) and then turn the drain cap to the arrow mark direction to remove it. <div data-bbox="379 405 927 544" style="border: 1px solid black; padding: 5px;"> <p>NOTE : The drain cap is hung down because a strap is attached to it (outside).</p> </div> <ol style="list-style-type: none"> 3) Loosen the cap by turn the drain cap (inside) for approx. 1 turn to OPEN → direction and then drain the drain water accumulated in the drain pan. <div data-bbox="379 719 927 1021" style="border: 1px solid black; padding: 5px;"> <p>NOTE : Be sure to catch drain water using a bucket, etc. when loosening the drain cap. The insulating materials are adhered to the drain cap (outside) and opening part of the drain pan; be careful that they are not come off. If they are come off, stick them as before using double-faces tape, etc.</p> </div> <ol style="list-style-type: none"> 4) Turn the drain cap once again to OPEN → direction to remove it. <p>2. Attachment</p> <ol style="list-style-type: none"> 1) Insert the drain cap (inside), turn it to CLOSE → direction until the position where “Clashed sound” is heard and it cannot be turned more over (Position where △ mark of the drain pan matches with △ mark of the drain cap (inside)) and then fix it. <div data-bbox="379 1442 927 1744" style="border: 1px solid black; padding: 5px;"> <p>NOTE : When attaching the drain cap (inside), remove dirt attached to the packing. And tighten in it noting so that the cap is not slantingly set. If attaching the drain cap as dust or dirt is attached or the cap is set slantingly, water leakage is caused.</p> </div> <ol style="list-style-type: none"> 2) Turn the drain cap (outside) to → direction and then attach it using the fixing screw as original. 3) Following to work of item 2 of ① , mount the suction grille as before. 	 

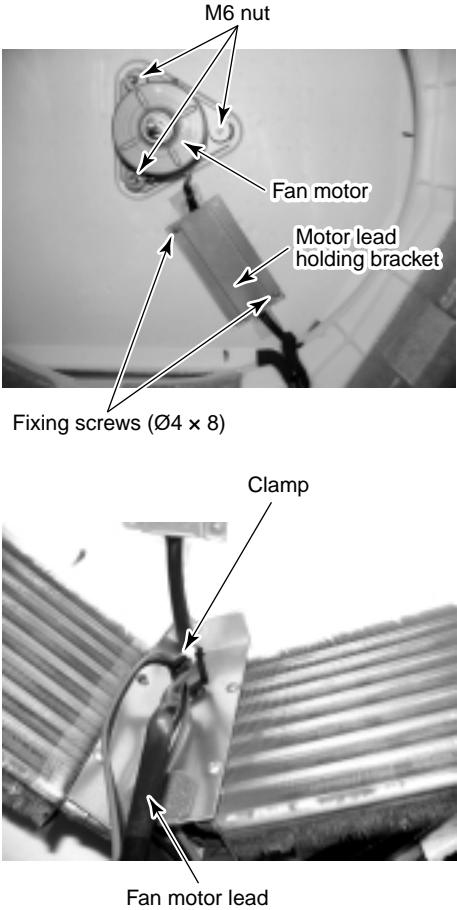
No.	Part name	Procedure	Remarks
⑦	Fan motor	<p>1. Detachment</p> <ol style="list-style-type: none"> 1) Carry out work of item 1 of ②. 2) Remove connectors which are connected from the control P.C. board to the other parts and then remove each wiring from the clamp. CN510 : Louver motor (20P, White) CN34 : Float switch (3P, Red) CN504 : Drain pump (2P, White) CN101 : TC sensor (2P, Black) CN102 : TCJ sensor (2P, Red) CN104 : Room temp. Sensor (2P, Orange) CN333 : Fan motor power supply (5P, White) CN334 : Fan motor position detection (3P, White) <div style="border: 1px solid black; padding: 5px; margin: 10px 0;"> <p>NOTE : Unlock the lock of the housing part and then remove the connector.</p> </div> <ol style="list-style-type: none"> 3) Remove the fixing screws A and B, and then remove the electric parts box. (Fixing screw A: $\varnothing 4 \times 10$, 3 pcs, Fixing screw B: $\varnothing 4 \times 8$, 1 pc.) 4) Remove the fan motor lead, TC sensor and TCJ sensor from clamp of the bell mouth. 5) Remove the fixing screws and then remove the bell mouth. ($\varnothing 4 \times 10$, 8 pcs.) 6) Remove the fixing screws and then remove the nut cap. ($\varnothing 4 \times 10$, 2 pcs.) 7) Remove the fixing nut and then remove the turbo fan. (M8 nut with flange, 1 pc.) 8) Remove the fixing screws and then remove the motor lead holding bracket. ($\varnothing 4 \times 8$, 2 pcs.) 9) Cut the bundling band and then remove it from the clamp. 10) Remove the fixing nut and then remove the fan motor. ($\varnothing 6$ nut, 3 pcs.) <p>2. Attachment</p> <ol style="list-style-type: none"> 1) Fix the parts as before in order of fan motor → motor lead holding bracket → turbo fan → nut cap → bell mouth. <div style="border: 1px solid black; padding: 5px; margin: 10px 0;"> <p>NOTE : Fix the motor lead to the clamp without slack as before using bundling band. When fixing the turbo fan, be sure to match the D-cut of the fan boss with D-cut of the motor shaft. Using a torque wrench, fix the turbo fan and tighten it to $5.4^{+0.5}_{-0.2}$ Nm.</p> </div>	    

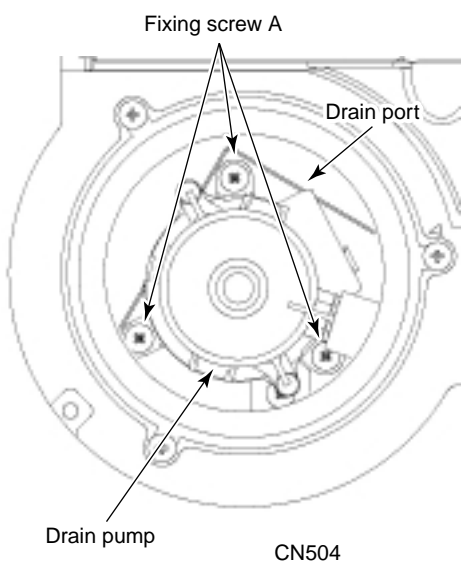
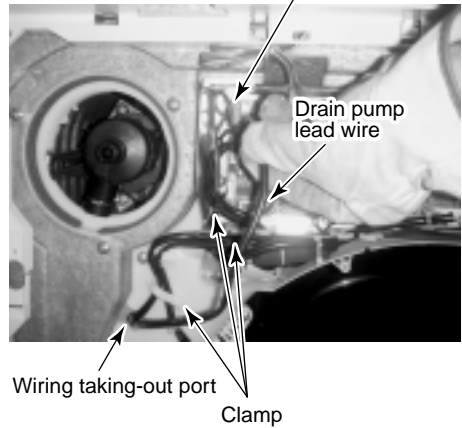
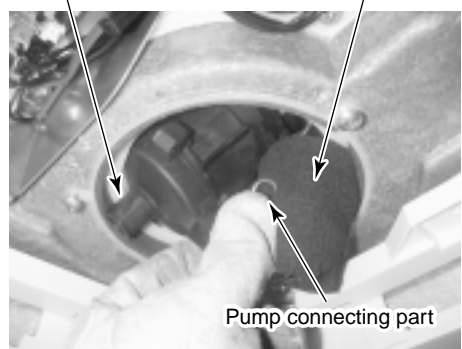
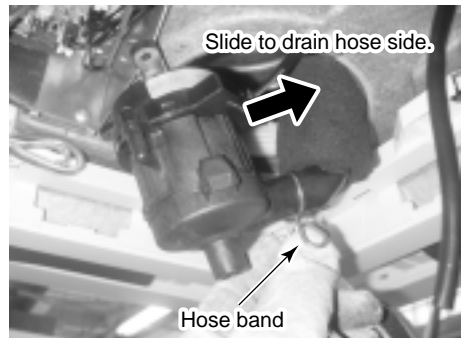
No.	Part name	Procedure	Remarks
⑦	Fan motor (Continued)	<p>2. Attachment</p> <p>2) Fix the fan motor lead, TC sensor and TCJ sensor with the clamp of the bell mouth.</p> <p>3) Mount the electric parts box with the fixing screws A and B. ($\varnothing 4 \times 10$, 3 pcs. $\varnothing 4 \times 8$, 1 pc.)</p> <p>4) Connect the connector removed in item 1 as before and then fix wiring with the clamp.</p> <p>5) Following to work of item 2 of ②, mount the electric parts box cover and the suction grille as before.</p>	 <p>M6 nut</p> <p>Fan motor</p> <p>Motor lead holding bracket</p> <p>Fixing screws ($\varnothing 4 \times 8$)</p> <p>Clamp</p> <p>Fan motor lead</p>

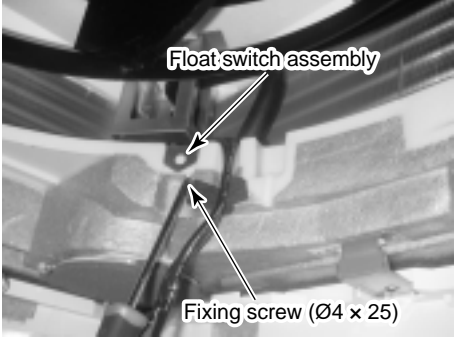
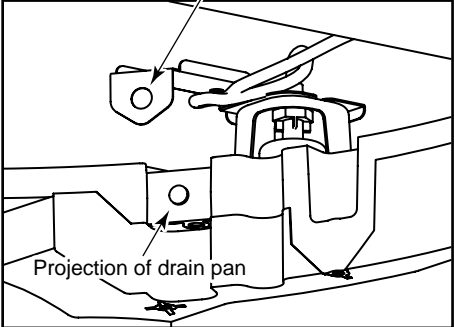
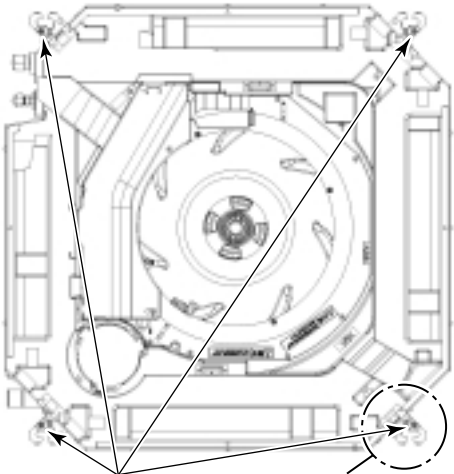
No.	Part name	Procedure	Remarks
⑧	Drain pump	<p>1. Detachment</p> <ol style="list-style-type: none"> 1) Carry out works of item 1 of ② and item 1 of ⑥. 2) Remove the drain pump connector (CN504, White, 2P) connected to the control P.C. board and then remove the lead wire from the clamp. 3) Remove the fixing screws and then remove the drain pump. (Ø4 × 10, 3 pcs.) 4) As shown in the right figure, first pull out the connecting part of the drain pump and the drain hose from the drain port and then take out the drain pump. 5) Set direction of the knob of the hose band downward, slide it from the pump connecting part to the hose side and then remove the drain hose from the drain pump. 6) Pass the connector of the drain pump lead wire through the wiring taking-out port and then take out the drain pump. <p>2. Attachment</p> <ol style="list-style-type: none"> 1) Enter your hand into the drain port and pass the connector of the drain pump lead wire through the wiring taking-out port. 2) Connect the drain hose to the drain pump as before. <div style="border: 1px solid black; padding: 5px; margin: 10px 0;"> <p>NOTE : Insert the drain hose up to the end of the drain pump connecting part, apply band to the white mark position of the hose and then set the band knob upward.</p> </div> <ol style="list-style-type: none"> 3) Return the drain pump to the indoor unit and then mount it as before using the fixing screws. (Ø4 × 10, 3 pcs.) 4) Connect the drain pump connector (CN504, White, 2P) to the control P.C. board and then fix it as before with the clamp. 5) Following to words of item 2 of ⑥ and item 2 of ②, mount the drain cap, the electric parts box cover and the suction grille as before. 	   

No.	Part name	Procedure	Remarks
⑨	Float switch assembly	<p>1. Detachment</p> <ol style="list-style-type: none"> 1) Carry out works of item 1 of ⑦ and works from 1) to 5). 2) Remove the fixing screw and then remove the float switch assembly. (Ø4 x 25, 1 pc.) <p>2. Attachment</p> <ol style="list-style-type: none"> 1) Mount the float switch assembly as before with the fixing screw. <div data-bbox="379 568 927 701" style="border: 1px solid black; padding: 5px; margin: 10px 0;"> <p>NOTE : When mounting, match hole of the float switch assembly with projection of the drain pan.</p> </div> <ol style="list-style-type: none"> 2) Mount the bell mouth as before. (Ø4 x 10, 8 pcs.) 3) Following to works of item 2 of ⑦ and works from 2) to 5), attach the parts as before. 	 <p>Float switch assembly</p> <p>Fixing screw (Ø4 x 25)</p>  <p>Hole of float switch assembly</p> <p>Projection of drain pan</p>
⑩	Drain pan	<p>1. Detachment</p> <ol style="list-style-type: none"> 1) Carry out works of item 1 of ④, item 1 of ⑥, item 1 of ⑦ and works from 2) to 5). 2) Remove the fixing screws to remove the drain pan. (Ø4 x10, 4 pcs.) <p>2. Attachment</p> <ol style="list-style-type: none"> 1) Fix parts as before in order of drain cap → drain pan → bell mouth. 2) Following to works of item 2 of ⑦ and works from 2) to 5), attach parts as before. 	 <p>Fixing screws (Ø4 x10)</p>  <p>Fixing screws (Ø4 x10)</p>

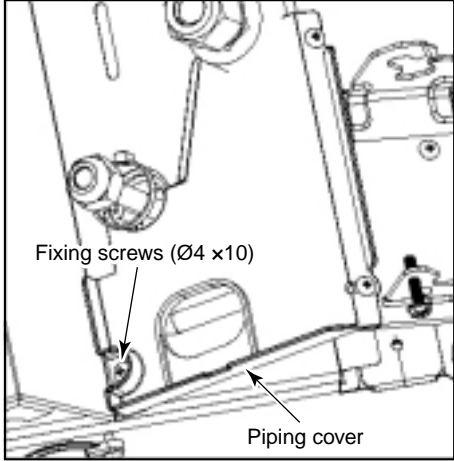
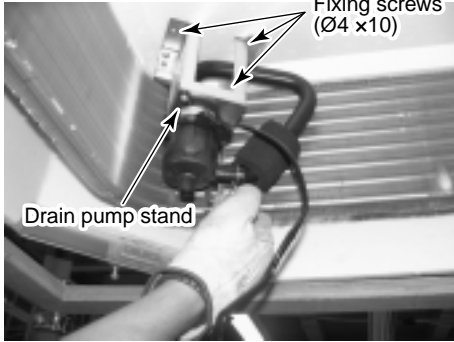
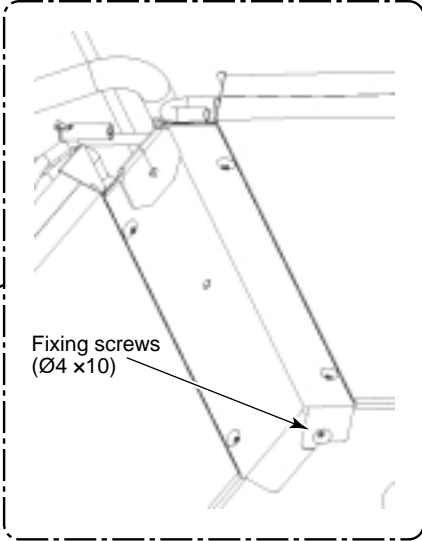
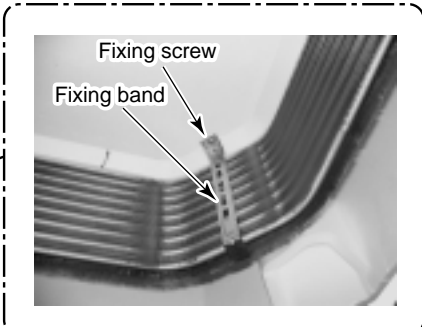
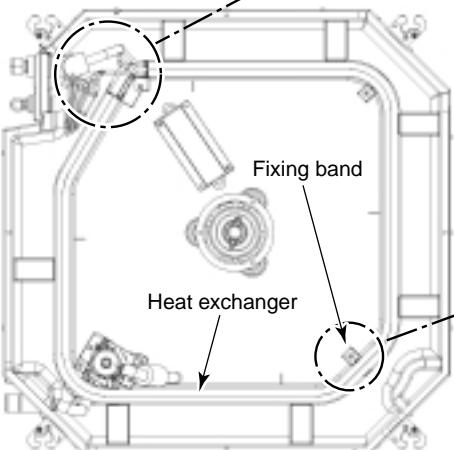
No.	Part name	Procedure	Remarks
⑪	Heat exchanger	<p>1. Detachment</p> <ol style="list-style-type: none"> 1) Recover the refrigerant gas. 2) Carry out work of item 1 of ⑩. 3) Remove refrigerant pipe at indoor unit side. 4) Remove the fixing screws and then remove the piping cover. (Ø4 x10, 3 pcs.) 5) Remove the drain hose from the drain pump and remove the fixing screws to remove the drain pump stand. (Ø4 x8, 3 pcs.) 6) While pushing the heat exchanger, remove the fixing band, fixing screws and the heat exchanger. (Ø4 x8, 3 pcs.) <p>2. Attachment</p> <ol style="list-style-type: none"> 1) Mount the heat exchanger with the fixing band and the fixing screws. (Ø4 x8, 3 pcs.) 2) Fix the parts as before in order of drain pump stand → piping cover. 3) Connect the refrigerant pipe as before and then apply vacuuming. 4) Following to work of item 2 of ⑩, attach the parts as before. 	 <p>Fixing screws (Ø4 x10)</p> <p>Piping cover</p>  <p>Drain pump stand</p> <p>Fixing screws (Ø4 x10)</p>  <p>Fixing screws (Ø4 x10)</p>  <p>Fixing screw</p> <p>Fixing band</p>  <p>Fixing band</p> <p>Heat exchanger</p>

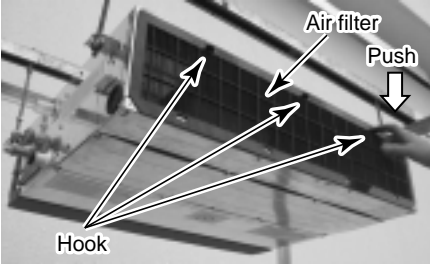
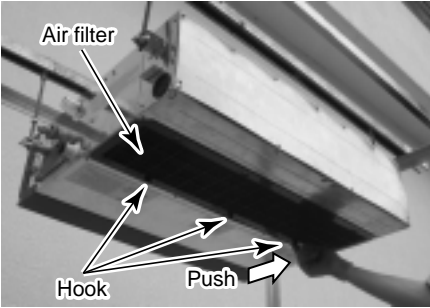
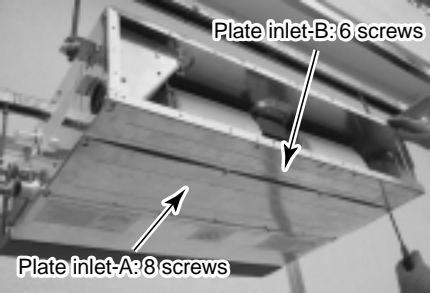
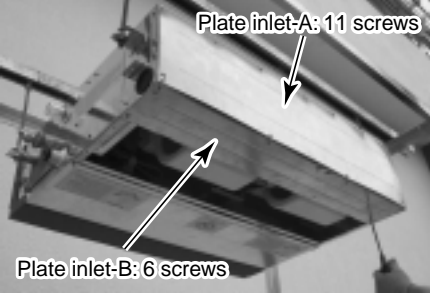

14-1-2. Slim Duct Type

RAV-SM404SDT-E, RAV-SM454SDT-E, RAV-SM564SDT-E

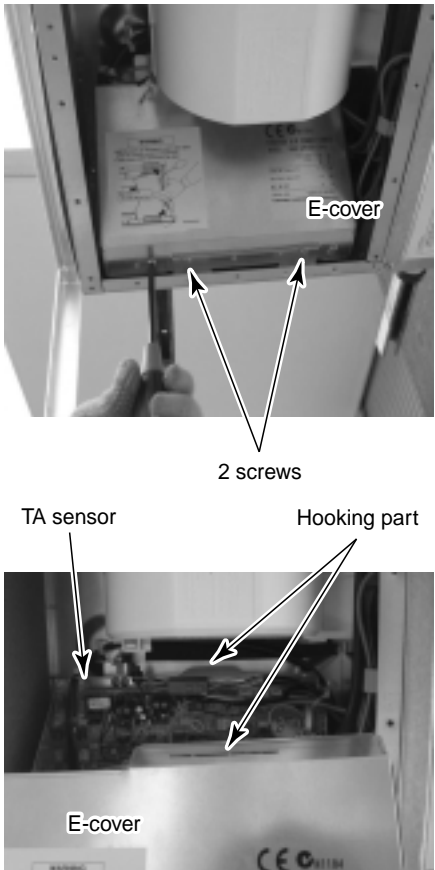
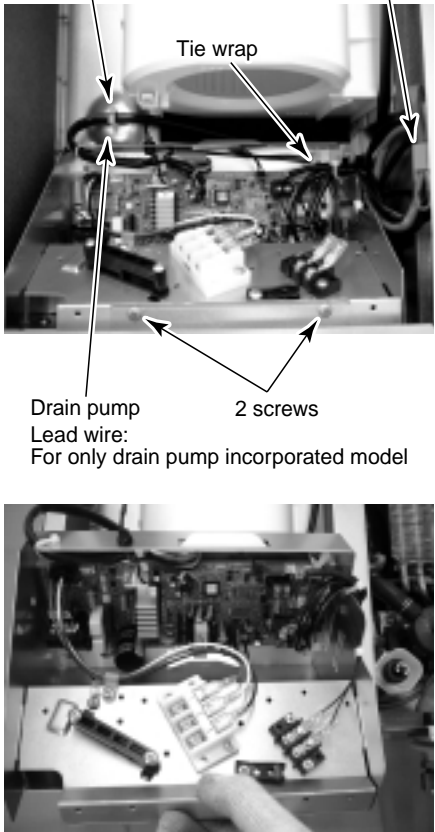
No.	Part name	Procedure	Remarks
		<p style="text-align: center;">REQUIREMENT</p> <p>Be sure to put on gloves at working; otherwise an injury may be caused by parts, etc.</p> <ul style="list-style-type: none"> Before replacement of the parts, be sure to stop operation of the air conditioner and turn off switch of the breaker. 	
①	Air Filter	<p>1. Detachment</p> <p>1) Push knobs (3 positions) of the air filter hooks toward the arrow direction to remove the air filter.</p> <p>2. Attachment</p> <p>1) Insert the air filter surely into the hooking grooves (4 positions) at the opposite side of the hooks, and then fix it to the original position.</p> <p>NOTE) In case of sucking system from bottom side, installation direction is determined. Install the air filter so that hooks are aligned at discharge side.</p>	<p>[In case of sucking system from rear side]</p>  <p>[In case of sucking system from bottom side]</p> 
②	Plate inlet-A Plate inlet-B	<p>1. Detachment</p> <p>1) Take off fixing screws while holding the plate inlet-A with hands to remove it. (Sucking system from rear side: $\varnothing 4 \times 10$, 8 pcs) (Sucking system from bottom side: $\varnothing 4 \times 10$, 11 pcs)</p> <p>2) Take off fixing screws while holding the plate inlet-B with hands to remove it. ($\varnothing 4 \times 10$, 6 pcs)</p> <p>NOTE) Be careful that sheeting metal does not fall when removing the plate inlet.</p> <p>2. Attachment</p> <p>1) Using the screws taken off in procedure 1. 2) of ②, attach the plate inlets in order of B → A while holding them not to fall down.</p>	<p>[In case of sucking system from rear side]</p>  <p>[In case of sucking system from bottom side]</p> 

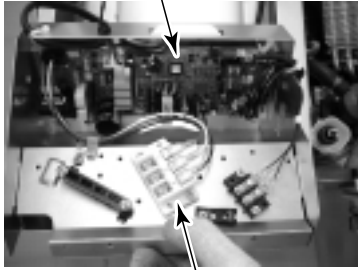
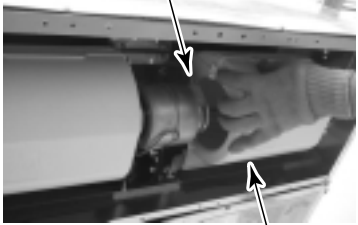
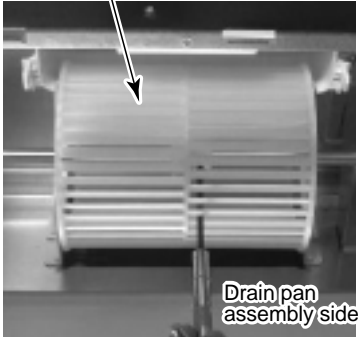
No.	Part name	Procedure	Remarks
③	E-cover	<p>1. Detachment</p> <ol style="list-style-type: none"> 1) Perform work 1. of ② . 2) Take off screws fixing E-cover, and then remove hooks of the hooking part by lifting up. (Ø4 × 10, 2 pcs) <p>2. Attachment</p> <ol style="list-style-type: none"> 1) Hang on E-cover to hooks of the hooking part so that it does not fall down. <p>NOTE) Be sure not to catch TA sensor in the E-cover; otherwise the equipment cannot operate correctly.</p> <ol style="list-style-type: none"> 2) Using the screws taken off in procedure 1. 2) of ③ , attach E-cover while holding it with hands without clearance. <p>NOTE) If there is clearance, dust may enter in the electric parts box.</p>	
④	E-box	<p>1. Detachment</p> <ol style="list-style-type: none"> 1) Perform works 1. of ② and 1. of ③ . 2) Remove clamps and tie wrap at upper part of the photo. (Drain pump incorporated model: 3 positions) (Natural drain model: 2 positions) 3) Take off screws fixing E-box. (Ø4 × 10, 2 pcs) E-box does not fall down under condition that screws are taken off. 4) Remove the E-box over sheeting metal which was fixed with screws. <p>2. Attachment</p> <ol style="list-style-type: none"> 1) Insert hooks of E-box into the hooking part of the main body. 2) Store E-box as before, and then attach it by using screws taken off in procedure 1. 3) of ④ . <p>NOTE) Be sure to fix surely as before the lead wires of which clamps and tie wrap were taken off.</p> <p>NOTE) Check that lead wires of the drain pump do not reach the fan so that they are not caught in the fan, and then fix them. (In case of drain pump incorporated model)</p>	

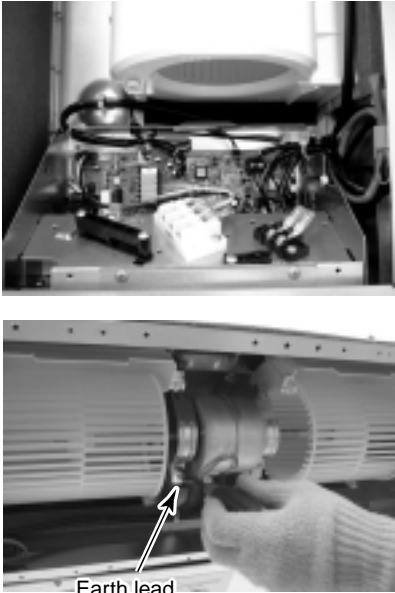

No.	Part name	Procedure	Remarks
⑤	P.C. board assembly	<p>1. Detachment</p> <p>1) Perform works 1. of ②, 1. of ③, and 1. of ④.</p> <p>2) Disconnect connectors which are connected from P.C. board assembly to other parts.</p> <p>NOTE) Unlock the lock of the housing to disconnect the connectors.</p> <p>CN41 : Remote controller terminal (2P: Blue) Remote controller terminal block: 2P</p> <p>CN67 : Power supply terminal (3P: Black)</p> <p>CN101 : TC sensor (2P: Black)</p> <p>CN102 : TCJ sensor (2P: Red)</p> <p>CN333 : Fan motor power supply (5P: White)</p> <p>CN334 : Detection of fan motor position (3P: White)</p> <p>(In case of drain pump incorporated model)</p> <p>CN34 : Float SW (3P: Red)</p> <p>CN504 : Drain pump lead (2P: White)</p> <p>3) Unlock the lock of the card edge spacer, and then remove P.C. board assembly.</p> <p>2. Attachment</p> <p>1) Attach P.C. board assembly to the card edge spacer.</p> <p>2) Using wires connect connectors as before, which were disconnected in procedure 1. 2) of ⑤ .</p> <p>NOTE) Check there is no missing or poor contact of the connectors.</p>	 <p>P.C. board assembly</p> <p>Terminal block</p>
⑥	Multi blade fan case, fan lower case, fan upper case	<p>1. Detachment</p> <p>1) Perform work 1. of ② .</p> <p>2) Take off hanging hooks at both sides of the lower fan case to remove fan lower case.</p> <p>3) Remove the upper fan case while taking off hooks of fan upper case which are hooked to the partition board.</p> <p>4) Loosen hexagonal hole screw of the multi blade fan to remove multi blade fan from the shaft. If necessary, remove multi blade fan and then remove fan upper case.</p> <p>2. Attachment</p> <p>1) Determine the position so that multi blade fan positions at the center of the fan upper case, and then fix it with hexagonal hole screw.</p> <p>NOTE) Arrange the multi blade fan so that screws position at the right side against the drain pan assembly.</p> <p>NOTE) Fix multi blade fan with torque wrench 4.9 N•m or more.</p> <p>2) Hook the lower fan case as before and attach it with hooks.</p> <p>NOTE) Finally check whether the multi blade fan turns surely and smoothly or not.</p>	 <p>Hanging hook</p> <p>Fan lower case</p>  <p>Multi blade fan</p> <p>Drain pan assembly side</p> <div data-bbox="1072 1953 1430 2047" style="border: 1px solid black; padding: 5px;"> <p>Arrange the multi blade fan so that screws position at the right side against the drain pan assembly.</p> </div>

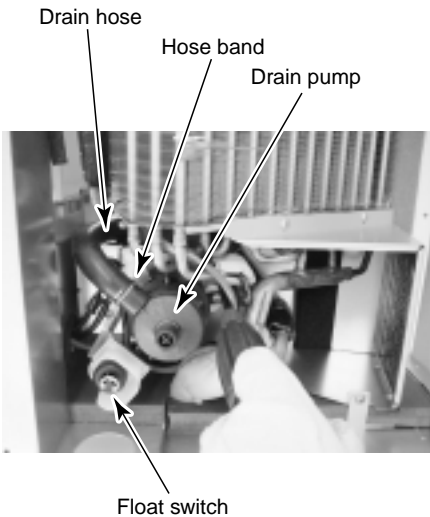
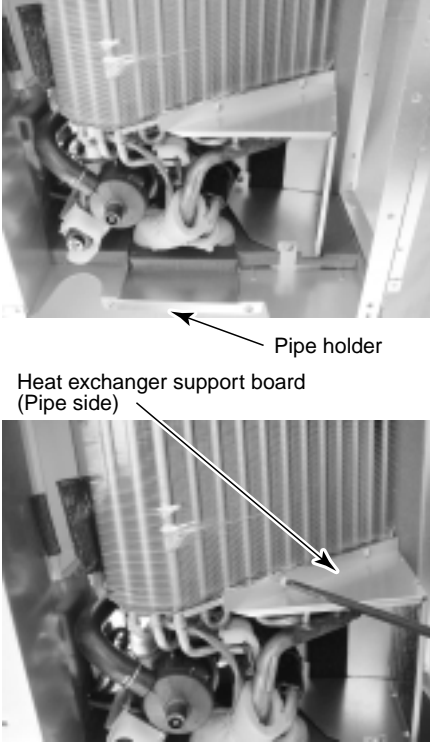
No.	Part name	Procedure	Remarks
⑦	Fan motor	<p>1. Detachment</p> <ol style="list-style-type: none"> 1) Perform works 1. of ②, 1. of ③, and 1. of ⑥. 2) Remove lead wires which are connected to the following connectors of P.C. board assembly. <p>NOTE) Unlock locks of the housing, and then remove the connectors. CN333 : Fan motor power supply (5P: White) CN334 : Detection of fan motor (3P: White) Remove tie wrap which fixes lead wires.</p> <ol style="list-style-type: none"> 3) Remove the noise filter from lead wire to detect fan motor position. 4) Take off screws of fan motor fixing bracket. Earth wires of the motor are tightened together. (Ø5 × 10, 2 pcs) Remove tie wrap which fixes the lead wires. 5) Remove fixing bracket of the fan motor by holding it with hands so that the fan motor does not fall down. <p>2. Attachment</p> <ol style="list-style-type: none"> 1) Mount the fan motor as before in order, Fan motor → Fixing bracket of fan motor → Noise filter → Lead wire process → E-cover. <p>NOTE) Check there is no missing or poor contact of the connectors. Check also that the multi blade fan turns surely and smoothly, and check together-tightening of motor earth.</p>	
⑧	Under panel Drain pan assembly	<p>1. Detachment</p> <ol style="list-style-type: none"> 1) Take off the drain cap and drain the drain water accumulated in the drain pan assembly. In case of natural drain model, drain the drain water by taking off hose band and drain hose. <p>NOTE) When taking off drain cap and drain hose, be sure receive drain water in a bucket, etc.</p> <ol style="list-style-type: none"> 2) Take off screws fixing the under panel while holding it to remove. (Ø4 × 10, 8 pcs) <p>NOTE) Be careful that sheeting metal does not fall when removing the under panel.</p> <ol style="list-style-type: none"> 3) Pull out the drain pan assy. by holding handle at lower part. <p>NOTE) When pulling out the drain pan assy, never pull out the drain socket by drawing it with hands. If doing so, water leak may be caused.</p> <ol style="list-style-type: none"> 4) Pull out it to some extent, lay hand on the bump at suction side, and then remove the drain pan assembly. <p>2. Attachment</p> <ol style="list-style-type: none"> 1) Hook and attach the drain pan assy. to the flange at discharge side, and then push in. 2) Using screws taken off in procedure 1. 2) of ⑧, attach under panel by holding with hands. 3) Attach drain cap, hose band, and drain hose as before, which were taken off in procedure 1. 1) of ⑧. <p>NOTE) Finally, be sure to check there is no water leakage from each attached part.</p>	

No.	Part name	Procedure	Remarks
⑨	Drain pump, Float switch, Drain hose	<p>1. Detachment</p> <ol style="list-style-type: none"> 1) Perform works in procedures 1. of ②, 1. of ③, 1. of ④ . 2) Disconnect lead wires which are connected to the following connectors of P.C. board assembly. <p>NOTE) Unlock locks of the housing to remove the connectors. CN34 : float SW (3P: Red) CN504 : Drain pump lead (2P: White)</p> <ol style="list-style-type: none"> 3) Loosen hose band, remove cap of the drain hose, and take off screws while holding drain pump. Remove them with care that pipes are not damaged. (Ø4 × 10, 3 pcs) 4) Take off screws while holding metal on float switch. Remove them with care so that pipes are not damaged. (Ø4 × 10, 1 pc) <p>NOTE) If the pipes are damaged, refrigerant leak may be caused. Take out them with great care.</p> <p>2. Attachment</p> <ol style="list-style-type: none"> 1) Attach ASSY sheeting metal which was removed in procedure 1. 3) of ⑨ with care that pipes are not damaged, and then fix it with screws. 2) Insert the drain hose into the inlet of drain pump, and then fix it with hose band. Arrange handle of the hose band at contrary side of heat exchanger side and at direction remote from drain pan assembly. 3) Carry out wiring as before, and then perform work of procedure 2. of ⑧ . <p>NOTE) Finally check whether they correctly operate or not.</p>	
⑩	Evaporator assembly	<p>1. Detachment</p> <ol style="list-style-type: none"> 1) Recover refrigerant, and then remove refrigerant pipes at indoor unit side. 2) Perform works of procedures 1. of ② , 1. of ③ , 1. of ④ . Remove sensors. 3) Take off screws of the pipe holder, and remove the pipe holder. (Ø4 × 10, 2 pcs) 4) Take off screws of the heat exchanger support board (Pipe side), and remove the heat exchanger support board (Pipe side). (Ø4 × 10, 4 pcs) 5) Take off screws of the heat exchanger support board (Opposite side) which fixes terminal block of the evaporator assembly. (Ø4 × 10, 2 pcs) 6) Remove the evaporator assembly. <p>2. Attachment</p> <ol style="list-style-type: none"> 1) Fasten the parts as before in order, Evaporator assembly → Pipe holder → Set sensors → Drain pan assembly → Under panel. 2) Connect the refrigerant pipe as before, and then perform vacuuming. 	

14-2. Outdoor Unit

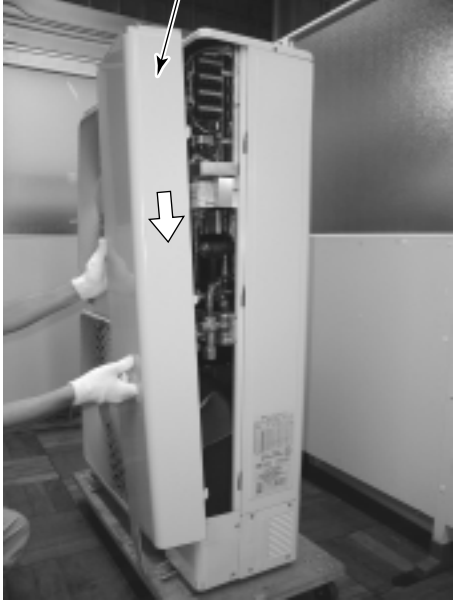
RAV-SP1104AT-E, RAV-SP1104ATZ-E, RAV-SP1104ATZG-E
RAV-SP1404AT-E, RAV-SP1404ATZ-E, RAV-SP1404ATZG-E

No.	Part name	Procedure	Remarks
①	Common procedure	<hr/> <p style="text-align: center;">CAUTION</p> <hr/> <p>Never forget to put on the gloves at working time; otherwise an injury will be caused by the parts, etc.</p> <hr/> <p>1. Detachment</p> <ol style="list-style-type: none"> 1) Stop operation of the air conditioner and then turn off switch of the breaker. 2) Remove the front panel. (Hexagonal screw $\varnothing 4 \times 10$, 2 pcs.) <ul style="list-style-type: none"> • Remove the screws and then remove the front panel by pulling it downward. 3) Remove the power supply cable and the indoor/outdoor connecting wire from the cord clamp and the terminal. 4) Remove the top plate. (Hexagonal screw $\varnothing 4 \times 10$, 5 pcs.) <p>2. Attachment</p> <ol style="list-style-type: none"> 1) Attach the top plate. (Hexagonal screw $\varnothing 4 \times 10$, 5 pcs.) 2) Connect the power supply cable and the indoor/outdoor connecting wire to the terminal and then fix them with the cord clamp. <hr/> <p style="text-align: center;">REQUIREMENT</p> <hr/> <p>For the power supply cable and the indoor/outdoor connecting wire, be sure fix them using the bundling band on the market along the crossover pipe so that they do not come to contact with the compressor, valve at gas side, pipe at gas side and discharge pipe.</p> <hr/> <ol style="list-style-type: none"> 3) Attach the front panel. (Hexagonal screw $\varnothing 4 \times 10$, 2 pcs.) 	<p style="text-align: center;">Front panel</p>  <p style="text-align: center;">Top plate</p> 

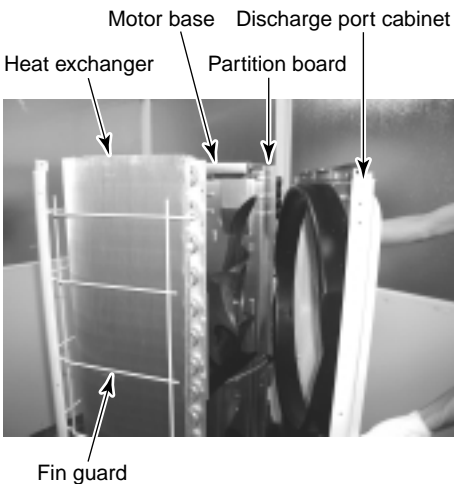
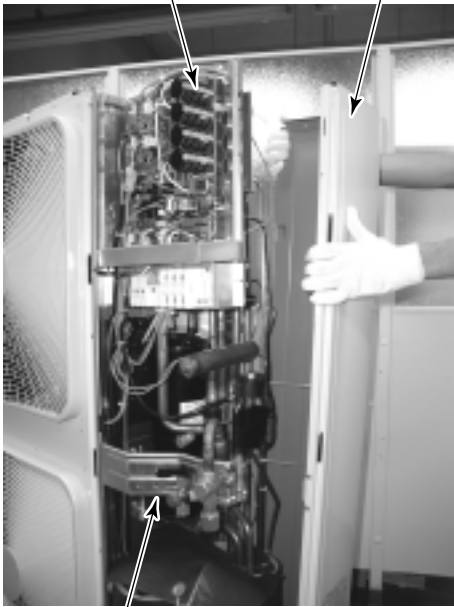
No.	Part name	Procedure	Remarks
②	Discharge port cabinet	<p>1. Detachment</p> <ol style="list-style-type: none"> 1) Carry out work of 1 of ①. 2) Remove screws for the discharge port cabinet and the partition board. (ST1T Ø4 × 8, 4 pcs.) 3) Remove screws for the discharge port cabinet and the bottom plate. (Hexagonal screw Ø4 × 10, 2 pcs.) 4) Remove screws for the discharge cabinet and the motor base. (ST1T Ø4 × 8, 2 pcs.) 5) Remove screw for the discharge cabinet and the heat exchanger. (ST1T Ø4 × 8, 1 pc.) 6) Remove screws for the discharge port cabinet and the fin guard. (Hexagonal screw Ø4 × 10, 2 pcs.) 	
③	Side cabinet	<ol style="list-style-type: none"> 1) Carry out work of 1 of ①. 2) Remove the screws which fix the inverter assembly and the side cabinet. (ST1T Ø4 × 8, 2 pcs.) 3) Remove the screws for the side cabinet and the valve fixing plate. (ST1T Ø4 × 8, 2 pcs.) 4) Remove screws for the side cabinet and the piping panel (Rear). (Hexagonal screw Ø4 × 10, 2 pcs.) 5) Remove screw for the side cabinet and the bottom plate. (Hexagonal screw Ø4 × 10, 1 pc.) 6) Remove screws for the side cabinet and the fin guard (Heat exchanger). (Hexagonal screw Ø4 × 10, 5 pcs.) 	

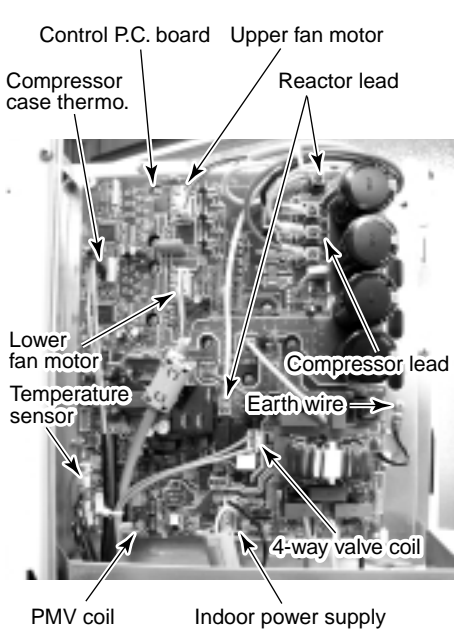
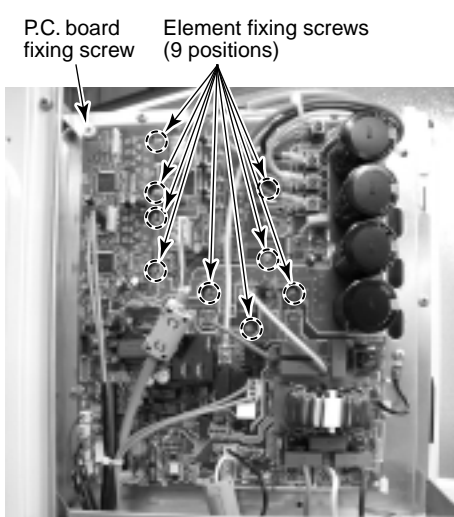
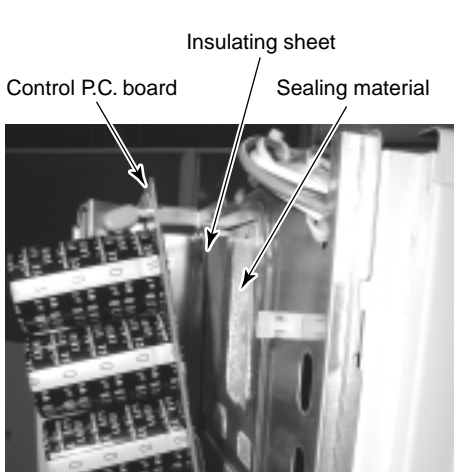
No.	Part name	Procedure	Remarks
④	Replacement of electric parts	<p>1. Control P.C. board</p> <p>1) Carry out work of 1 of ①.</p> <hr/> <p style="text-align: center;">⚠ WARNING</p> <p>Never disassemble the inverter for 1 minute after power supply has been turned off because an electric shock may be caused.</p> <hr/> <p>2) Remove the connectors connected to the control P.C. board. (Indoor power supply, Temperature sensor, PMV coil, 4-way valve coil, Compressor case thermo, Fan motor)</p> <ul style="list-style-type: none"> • Unlock the lock of the housing part and then remove the connectors. <p>3) Remove the lead wires connected to the control P.C. board.</p> <p>Compressor lead U: CN200 Red V: CN201 White W: CN202 Black</p> <p>Reactor cord CN05 White CN06 White</p> <p>4) Remove the earth wire from the control P.C. board. (Trust B tight screw Ø4 × 6, 1 pc.)</p> <p>5) Remove the fixing screws of the control P.C. board. (Screw with collar for fixing element Ø3 × 16, 9 pcs. Pan S tight screw for fixing board Ø3 × 20, 1 pc.)</p> <p>6) Remove the control P.C. board. (Supporter: 5 positions)</p> <div style="border: 1px solid black; padding: 5px; margin: 10px 0;"> <p>NOTE : Be careful to take out because there is sealing material for the heat sink.</p> </div> <p>7) Replace the control P.C. board with a new one.</p> <div style="border: 1px solid black; padding: 5px; margin: 10px 0;"> <p>NOTE :</p> <ul style="list-style-type: none"> • Be sure not to confuse for Compressor lead V (CN201 White), Reactor lead CN05 and CN06. • Be sure not to come-off of the insulating sheet. </div>	<p style="text-align: center;">Remarks</p>   

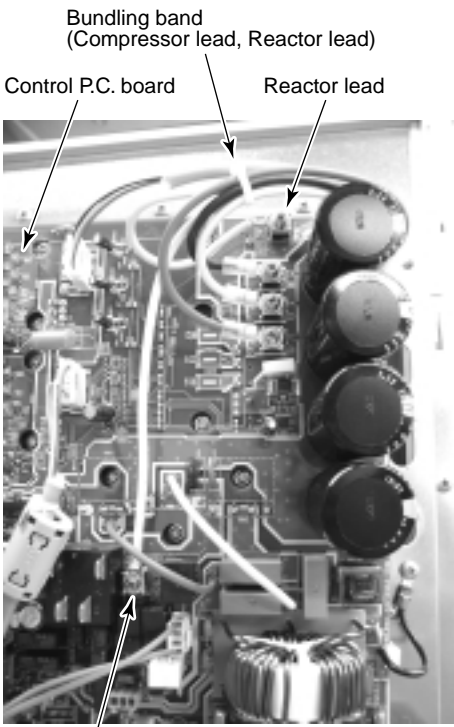
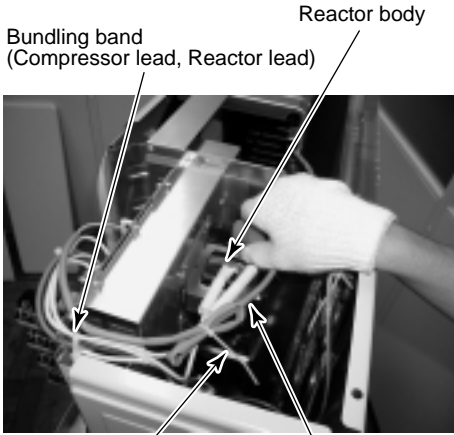
No.	Part name	Procedure	Remarks
④	Replacement of electric parts (Continued)	<p>2. Reactor</p> <ol style="list-style-type: none"> 1) Carry out work of 1 of ①. 2) Remove the reactor lead connected to the control P.C. board. CN05 White, CN06 White 3) Cut the bundling band which bundled the compressor lead and fan motor lead. 4) Remove the reactor. (Trust B tight screw, Ø4 × 6, 2 pcs.) 5) Replace the reactor with a new one. <div style="border: 1px solid black; padding: 5px; margin-top: 10px;"> <p>NOTE :</p> <p>Be sure to bundle the removed bundling band with the bundling band on the market.</p> <p>Be careful so that the fan motor lead does not come to contact with the reactor body.</p> </div>	 <p>Bundling band (Compressor lead, Reactor lead)</p> <p>Control P.C. board</p> <p>Reactor lead</p> <p>Reactor lead</p>  <p>Bundling band (Compressor lead, Reactor lead)</p> <p>Reactor body</p> <p>Bundling band (Fan motor lead, Reactor lead)</p> <p>Fan motor lead</p>

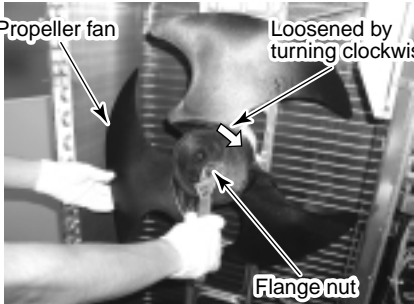
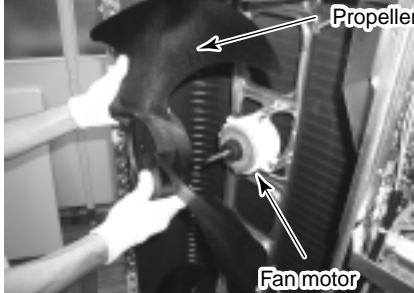
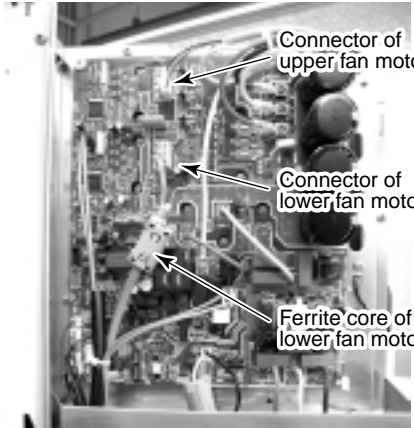
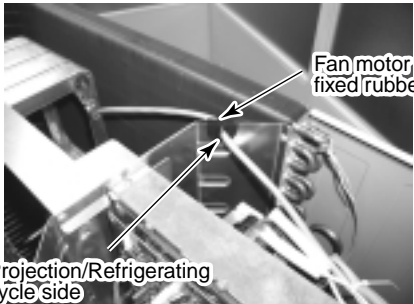
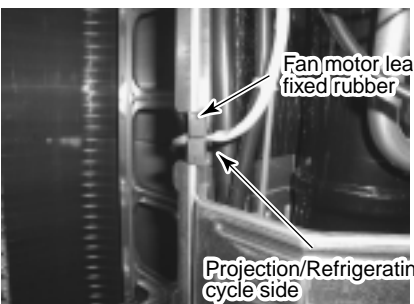
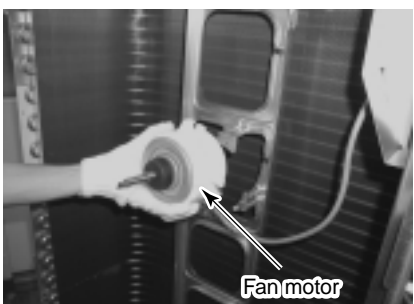

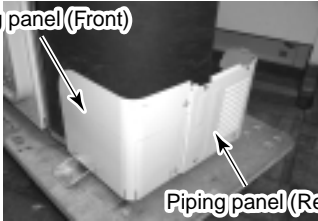
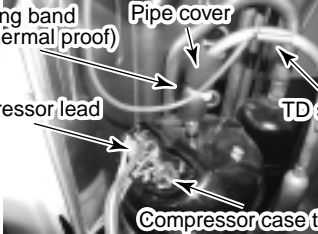
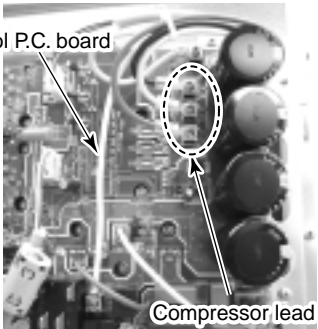
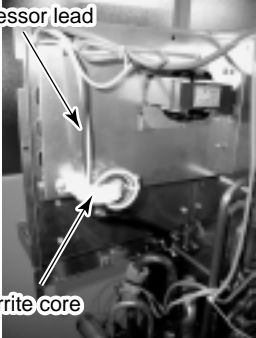
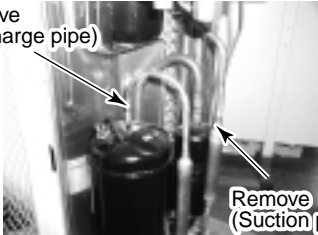
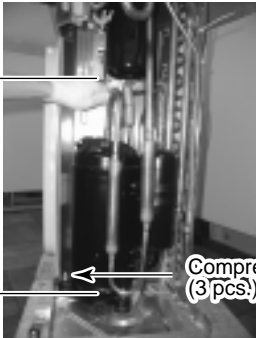
No.	Part name	Procedure	Remarks
⑤	Fan motor	<p>1) Carry out works of item 1 of ① and work of ②.</p> <p>2) Remove the flange nut fixing the fan motor and the propeller fan.</p> <ul style="list-style-type: none"> The flange nut is loosened by turning it clockwise. (When tightening it, turn it counterclockwise.) <p>3) Remove the propeller fan.</p> <p>4) Remove the connector for the fan motor from the inverter. (Remove the ferrite core of the lower fan motor because it is used.)</p> <p>5) Remove the fan motor lead from the fan motor lead fixed rubber of the penetrated part of the partition board.</p> <p>6) Remove the fixing screws (4 pieces each) while supporting the fan motor so that it does not fall down.</p> <p>* Cautions for assembling of fan motor</p> <ul style="list-style-type: none"> Tighten the flange nut with 4.95N•m (50kgf•cm). Adjust length of the fan motor lead wire at the fan motor lead fixed rubber so that the fan motor lead is not slackened; otherwise the fan motor lead may come to contact with the propeller fan. <p>Attach the fan motor lead fixed rubber to the partition board so that the projection is set at the refrigerating cycle side.</p> <ul style="list-style-type: none"> Be sure so that the reactor body does not contact with the fan motor lead. Be sure to bundle the removed bundling band with the bundling band on the market. Necessarily attach the ferrite core of the lower fan motor again. (Fix it with bundling band on the market.) <hr/> <p style="text-align: center;">REQUIREMENT</p> <p>Be sure to fix the fan motor lead to the motor base using the metal band of the motor base so that the fan motor lead does not come to contact with the propeller fan.</p> <hr/>	     

No.	Part name	Procedure	Remarks
⑥	Compressor Compressor lead	<p>1. Removal of defective compressor</p> <ol style="list-style-type: none"> 1) Recover the refrigerant gas. 2) Carry out work of item 1 of ① and work of ③. 3) Remove the piping panel (Front). Remove the piping panel (Front) and screws of the bottom plate. (Hexagonal screw Ø4 x 10, 2 pcs.) Remove screw of the piping panel (Front) and the piping panel (Rear). (Hexagonal screw Ø4 x 10, 1 pc.) 4) Remove the piping panel (Rear). Remove the piping panel (Rear) and screws of the bottom plate. (Hexagonal screw Ø4 x 10, 2 pcs.) 5) Remove the sound-insulation plate. (Upper, rolling in, rolling out) 6) Remove the terminal cover of the compressor and then remove the compressor lead and the compressor case thermo. 7) Remove TD sensor which is fixed to the discharge pipe. 8) Remove the compressor lead. (Leave the ferrite core as it is attached to the electric parts box.) Control P.C. board U : CN200 Red V : CN201 White W : CN202 Black 9) Using a burner, remove the discharge pipe and the suction pipe which are connected to the compressor. <hr/> <p style="text-align: center;">⚠ WARNING</p> <p>In case of removing the piping by broiling the welded part with a burner, if there is oil in the pipe, it may burst into flames at the moment that wax melted, so take sufficient care.</p> <hr/> <div style="border: 1px solid black; padding: 5px; margin-bottom: 10px;"> <p>CAUTION : Note so that the flame does not catch the 4-way valve and PMV. (A malfunction may be caused.)</p> </div> <ol style="list-style-type: none"> 10) Pull off the discharge pipe and the suction pipe of the refrigerating cycle upward. 11) Remove the compressor nuts which fix the compressor to the bottom plate. (3 pcs.) 12) Pull out the compressor toward you. <div style="border: 1px solid black; padding: 5px; margin-top: 10px;"> <p>CAUTION : As weight of the compressor is 20kg or more, handle it by 2 workers.</p> </div>	     

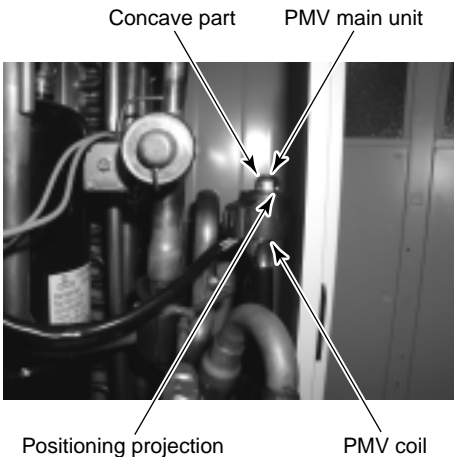
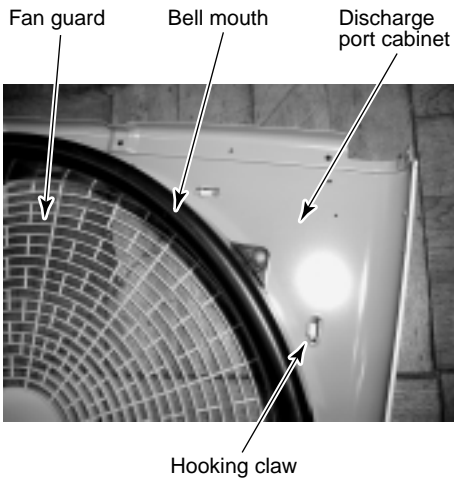



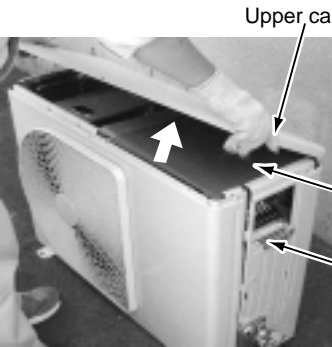
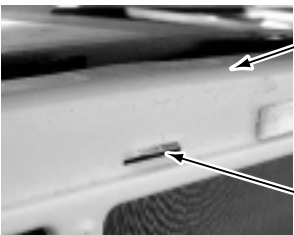

No.	Part name	Procedure	Remarks
⑥	Compressor Compressor lead (Continued)	<p>2. Mounting of compressor</p> <p>1) Mount the compressor in the reverse procedure for removal.</p> <div data-bbox="379 360 922 902" style="border: 1px solid black; padding: 5px; margin: 10px 0;"> <p>NOTE :</p> <ul style="list-style-type: none"> • After replacement of the compressor, be sure to replace the compressor lead. (Repair part code of compressor lead: 43160591) In this time, wrap the ferrite core with the compressor lead wire by 4 times. • As shown in the right figure, mount the sound-insulation plate (rolling in, rolling out) by passing through it between the compressor and the piping, and between the piping and the partition board. • Fix TD sensor by the bundling band for heat-proof on the market via the pipe cover so that TD sensor does not directly come to contact with the discharge pipe. </div> <p>3. Vacuuming</p> <p>1) Connect the vacuum pump to the charge port and the check joint of the gas pipe valve and then drive the vacuum pump.</p> <p>2) Carry out vacuuming until the vacuum low pressure gauge indicates 1 (mmHg).</p> <div data-bbox="379 1211 922 1406" style="border: 1px solid black; padding: 5px; margin: 10px 0;"> <p>NOTE :</p> <p>Before vacuuming, open PMV fully.</p> <p>If PMV is closed, vacuum may be impossible between liquid pipe valve and PMV of the outdoor unit.</p> </div> <p>Forced full-opening method of PMV</p> <ul style="list-style-type: none"> • Turn on the leakage breaker. • Turn on 1 and 3 of Dip switch SW804 on the control P.C. board of the outdoor unit. • Keep pushing SW801 on the control P.C. board of the outdoor unit for 1 second or more. • After pushing SW801 for 1 second or more, turn off the leakage breaker within 2 minutes. <p>4. Refrigerant charge</p> <p>1) Add the refrigerant amount determined by the pipe length from the charge port of the valve.</p>	<p>Wrap the ferrite core with the compressor lead wire for 4 times.</p> <div data-bbox="1013 302 1396 593"> </div> <p>0 to 50 (Compressor lead positioning standard)</p> <p>Put the end of sound-insulation plate (rolling out) on the other end at this position.</p> <p>Pass through sound-insulation plate (rolling out) between suction pipe and header pipe.</p> <div data-bbox="1013 795 1396 1086"> </div> <p>Discharge pipe</p> <p>Pass through sound-insulation plate (rolling in) between compressor and discharge pipe, suction pipe and then put the end of sound-insulation plate on the other end at this position.</p> <p>There should be no clearance between sound-insulation plate (upper) and sound-insulation plate (rolling out).</p> <div data-bbox="1061 1310 1348 1713"> </div> <p>Insert one side under cultural rivet.</p> <div data-bbox="1013 1758 1396 2049"> </div>

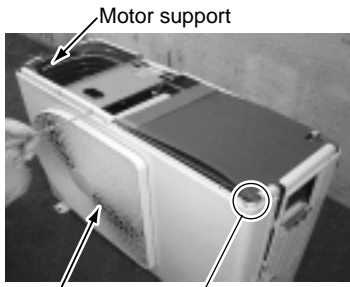
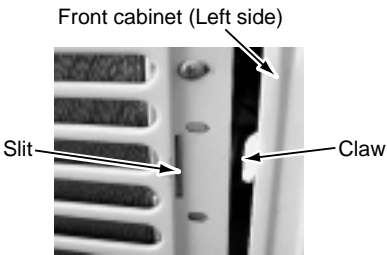
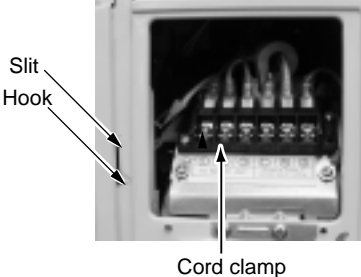
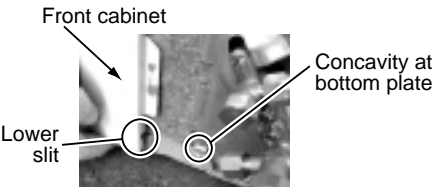

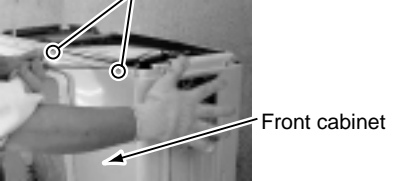
No.	Part name	Procedure	Remarks
⑦	PMV coil	<p>1. Detachment</p> <ol style="list-style-type: none"> 1) Carry out work of item 1 of ①. 2) Turn the coil while pulling upward and then remove the coil from the PMV main unit. <p>2. Attachment</p> <ol style="list-style-type: none"> 1) Surely match the positioning projection of the coil with the concave part of PMV main unit and then fix it. 	
⑧	Fan guard	<p>1. Detachment</p> <ol style="list-style-type: none"> 1) Carry out works of item 1 of ① and work of ②. <hr/> <p style="text-align: center;">REQUIREMENT</p> <p>To prevent scratch on the product, carry out the work on cardboard, cloth, etc.</p> <hr/> <ol style="list-style-type: none"> 2) Remove the discharge port cabinet and then put on it so that the fan guard side directs downward. 3) Remove the hooking claws (8 positions) of the fan guard. <p>2. Attachment</p> <ol style="list-style-type: none"> 1) Push the hooking claws (8 positions) with hands from the front side to fix the claws. <hr/> <p style="text-align: center;">REQUIREMENT</p> <p>Check that all the hooking claws are fixed at the specified positions.</p> <hr/>	



**RAV-SP404AT-E, RAV-SP404ATZ-E, RAV-SP404ATZG-E
RAV-SP454AT-E, RAV-SP454ATZ-E, RAV-SP454ATZG-E**

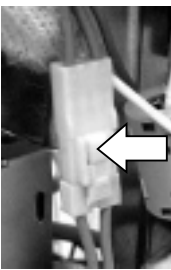

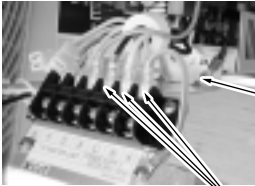
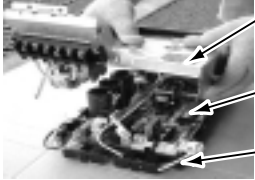
No.	Part name	Procedure	Remarks
①	Common procedure	<hr/> <p style="text-align: center;">CAUTION</p> <hr/> <p>Never forget to put on the gloves at working time, otherwise an injury will be caused by the parts, etc.</p> <hr/> <p>1. Detachment</p> <ol style="list-style-type: none"> 1) Stop operation of the air conditioner, and turn off the main switch of the breaker for air conditioner. 2) Remove the valve cover. (ST1T Ø4 × 10L, 1 pc.) <ul style="list-style-type: none"> • After removing screw, remove the valve cover pulling it downward. 3) Remove wiring cover (ST1T Ø4 × 10L, 2 pcs.), and then remove connecting cable. 4) Remove the upper cabinet. (ST1T Ø4 × 10L, 2 pcs.) <ul style="list-style-type: none"> • After taking off screws, remove the upper cabinet pulling it upward. <p>2. Attachment</p> <ol style="list-style-type: none"> 1) Attach the waterproof cover. <hr/> <p style="text-align: center;">CAUTION</p> <hr/> <p>Be sure to attach a waterproof cover. If it is not attached, there is a possibility that water enters inside of the outdoor unit.</p> <hr/> <ol style="list-style-type: none"> 2) Attach the upper cabinet. (ST1T Ø4 × 10L, 2 pcs.) <ul style="list-style-type: none"> • Hook the rear side of the upper cabinet to claw of the rear cabinet, and then put it on the front cabinet. 3) Perform cabling of connecting cables, and fix with cord clamp. (ST1T Ø4 × 10L 3 pcs.) 4) Attach the wiring cover. (ST1T Ø4 × 10L, 2 pcs.) 5) Attach the valve cover. (ST1T Ø4 × 10L, 1 pc.) <ul style="list-style-type: none"> • Insert the upper part of the upper cabinet, set hooking claw of the valve cover to the slit (at three positions) of the main body, and then attach it pushing upward. 	 <p>Valve cover</p>  <p>Wiring cover</p>  <p>Upper cabinet Water-proof cover Cord clamp</p>  <p>Rear cabinet Claw</p>

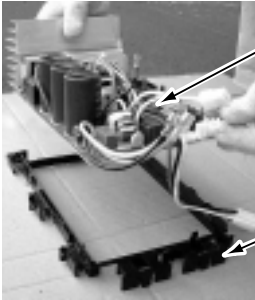
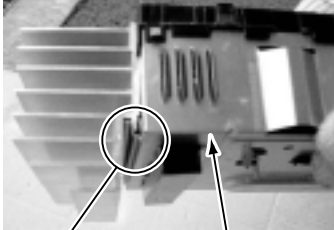
No.	Part name	Procedure	Remarks
②	Front cabinet	<p>1. Detachment</p> <ol style="list-style-type: none"> 1) Perform work of item 1 of ① . 2) Remove screws (ST1T Ø4 × 10L, 2 pcs.) of the front cabinet and the inverter cover. 3) Take off screws of the front cabinet and the bottom plate. (ST1T Ø4 × 10L 3 pcs.) 4) Take off screws of the front cabinet and the motor support. (ST1T Ø4 × 10L, 2 pcs.) <ul style="list-style-type: none"> • The left side of the front side if made to insert to the rear cabinet, so remove it pulling upward. <p>3. Attachment</p> <ol style="list-style-type: none"> 1) Insert hook at the left side of the front side into the rear cabinet. 2) Hook the lower part at the right side of the front to concavity of the bottom plate. Insert the hook of the rear cabinet into the slit of the front cabinet. 3) Attach the removed screws to the original positions. 	 <p>Motor support</p> <p>Front cabinet</p> <p>For single-phase type models, also take off this screw</p>  <p>Front cabinet (Left side)</p> <p>Slit</p> <p>Claw</p>  <p>Slit</p> <p>Hook</p> <p>Cord clamp</p>  <p>Front cabinet</p> <p>Lower slit</p> <p>Concavity at bottom plate</p>

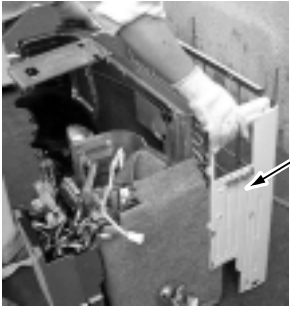
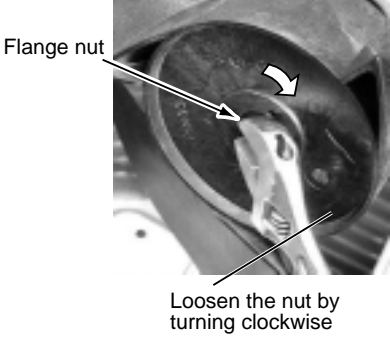
No.	Part name	Procedure	Remarks
③	Inverter assembly	<p>1. Detachment</p> <p>1) Perform work of item 1 of ① .</p> <p>2) Take off screws of the upper part of the front cabinet.</p> <ul style="list-style-type: none"> • If removing the inverter cover under this condition, P.C. board can be checked. • If there is no space in the upper part of the upper cabinet, perform work of ②. <hr/> <p style="text-align: center;">CAUTION</p> <p>Be careful to check the inverter because high-voltage circuit is incorporated in it.</p> <hr/> <p>3) Perform discharging by connecting ⊕ , ⊖ polarities by discharging resistance (approx. 100Ω, 40W) or plug of soldering iron to ⊕ , ⊖ terminals of the C14 (printed as "CAUTION HIGH VOLTAGE") electrolytic capacitor (500μF) of P.C. board.</p> <hr/> <p style="text-align: center;">WARNING</p> <p>The electrolytic capacitor may not normally discharge according to error contents and the voltage may remain. Therefore, be sure to discharge the capacitor.</p> <hr/> <p style="text-align: center;">WARNING</p> <p>For discharging, never use a screwdriver and others for short-circuiting between ⊕ and ⊖ electrodes. As the electrolytic capacitor is one with a large capacity, it is very dangerous because a large electric spark will occur.</p> <hr/> <p>4) Take off screws (ST1T Ø4 × 10L, 2 pcs.) fixing the main body and the inverter box.</p> <p>5) Remove various lead wires from the holder at upper part of the inverter box and wiring holder at right side of the terminal block.</p> <p>6) Remove the lead wire from the bundled part at left side of the terminal block.</p> <p>7) Pull the inverter box upward.</p> <p>8) Disconnect connectors of various lead wires.</p> <hr/> <p style="text-align: center;">REQUIREMENT</p> <p>As each connector has a lock mechanism, avoid to remove the connector by holding the lead wire, but by holding the connector.</p> <hr/>	 <p>Screws</p>  <p>Front cabinet</p>  <p>Inverter cover</p>  <p>Cord clamp</p>  <p>Screws</p>  <p>Plug of soldering iron</p> <p>Discharging position (Discharging period 10 seconds or more)</p>  <p>Inverter assembly</p>  <p>Remove the connectors with locking function by pushing the part indicated by the arrow mark.</p>

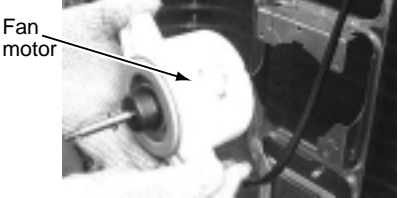
No.	Part name	Procedure	Remarks
④	Control P.C. board assembly	<p>1) Disconnect lead wires and connectors connected from the control P.C. board assembly to other parts.</p> <p>1. Lead wires</p> <ul style="list-style-type: none"> • Connection with the power terminal block: 3 wires (Black, White, Orange) • Earth wire: 1 wire (Black) <p>2. Connectors</p> <ul style="list-style-type: none"> • Connection with compressor: Remove 3P connector. • Connection with reactor: Remove the relay connectors from P07, 08 (2P, White) and P12, 13 (2P, Yellow) <p>CN300 : Outdoor fan (3P, White) CN301 : Position detection (5P, White) CN701 : 4-way valve (3P, Yellow) CN600 : TE sensor (2P, White) CN601 : TD sensor (3P, White) CN603 : TS sensor (3P, White) CN602 : TO sensor (3P, White) CN500 : Case thermo. (2P, White) CN703 : PMV (6P, White)</p> <p>2) Remove the inverter box (Metal plate).</p> <p>3) Remove the control board assembly from P.C. board base. (Remove the heat sink and the control board assembly as they are screwed.)</p> <p>NOTES:</p> <p>1. CN300, CN301 and CN701, etc. at the control board assembly side are connectors with locking function. Therefore, remove the connector while pushing the part indicated by an arrow mark.</p> <p>2. Remove 4 hooking claws of P.C. board base, and remove upward the heat sink with hands.</p> <p>4) Take off 3 screws fixing the heat sink and main control board assembly side, and replace the board with a new one.</p> <p>NOTE: When mounting a new board, check that the board is correctly set in the groove of the base holder of P.C. board base. Attach the P.C. board so that the heat sink comes securely contact with the metal sheet.</p>	 <p>Take off earth screws.</p> <p>Power line</p>  <p>Inverter box (Metal sheet)</p> <p>Control P.C. board assembly</p> <p>P.C. board base</p>  <p>Hooking claws (4 positions)</p>  <p>Control P.C. board assembly</p> <p>P.C. board base</p>  <p>Heat sink</p> <p>Inverter box (Metal sheet)</p>

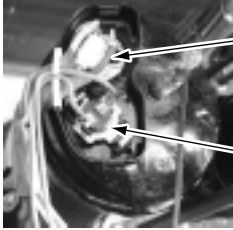
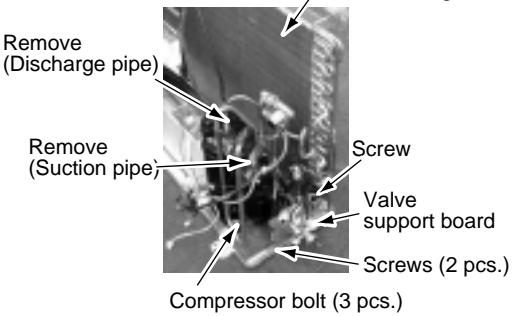
No.	Part name	Procedure	Remarks
⑤	Rear cabinet	1) Perform works of items 1 of ① and ② , ③ . 2) Take off fixed screws for the bottom plate. (ST1T Ø4 × 10L, 3 pcs.) 3) Take off fixed screws for the heat exchanger. (ST1T Ø4 × 10L, 2 pcs.) 4) Take off fixed screw for the valve mounting plate. (ST1T Ø4 × 10L, 1 pc.)	
⑥	Fan motor	1) Perform works of items 1 of ① and ② . 2) Take off the flange nut fixing the fan motor and the propeller. • Turning it clockwise, the flange nut can be loosened. (To tighten the flange nut, turn counterclockwise.) 3) Remove the propeller fan. 4) Disconnect the connector for fan motor from the inverter. 5) Take off the fixing screws (3 pcs.) holding by hands so that the fan motor does not fall. NOTE: Tighten the flange nut with torque 4.9Nm (50kgf/cm).	  

No.	Part name	Procedure	Remarks
⑦	Compressor	<p>1) Perform works of items 1 of ① and ② , ③ , ④ , ⑤ .</p> <p>2) Discharge refrigerant gas.</p> <p>3) Remove the partition plate. (ST1T Ø4 × 10L, 2 pcs.)</p> <p>4) Remove the noise-insulator.</p> <p>5) Remove the terminal covers of the compressor, and disconnect lead wires of the compressor and the compressor thermo assembly from the terminal.</p> <p>6) Remove pipes connected to the compressor with a burner.</p> <hr/> <p style="text-align: center;">CAUTION</p> <p style="text-align: center;">Pay attention to that flame does not involve 4-way valve or PMV. (If doing so, a malfunction may be caused.)</p> <hr/> <p>7) Take off the fixing screws of the bottom plate and heat exchanger. (ST1T Ø4 × 10L, 2 pcs.)</p> <p>8) Take off the fixing screws of the valve clamping plate to the bottom plate.</p> <p>9) Pull upward he refrigerating cycle.</p> <p>10)Take off nut fixing the compressor to the bottom place.</p> <hr/> <p style="text-align: center;">CAUTION</p> <p style="text-align: center;">When reconnecting the lead wires to the compressor terminals after replacement of the compressor, be sure to caulk the Faston terminal without loosening.</p> <hr/>	<p style="text-align: center;">Partition plate</p>   <p style="text-align: right;">Compressor lead</p> <p style="text-align: right;">Case thermo</p>  <p style="text-align: right;">Heat exchanger</p> <p>Remove (Discharge pipe)</p> <p>Remove (Suction pipe)</p> <p>Screw</p> <p>Valve support board</p> <p>Screws (2 pcs.)</p> <p>Compressor bolt (3 pcs.)</p>
⑧	Reactor	<p>1) Perform works of item 1 of ① and ③ .</p> <p>2) First take off two screws (ST1T Ø4 × 10L) of the reactor fixed to the reactor support.</p> <p>3) Remove the reactor support from the partition plate. (ST1T Ø4 × 10L, 4 pcs.)</p> <p>4) Take off two screws (ST1T Ø4 × 10L) directly attached to the partition plate.</p>	 <p style="text-align: center;">Reactor</p> <p style="text-align: center;">Partition plate</p> <p style="text-align: right;">Reactor support board</p>

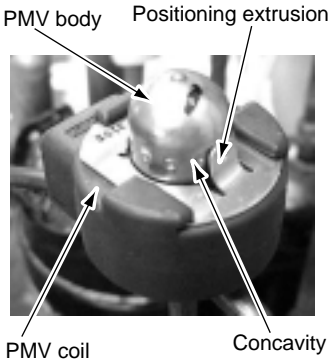
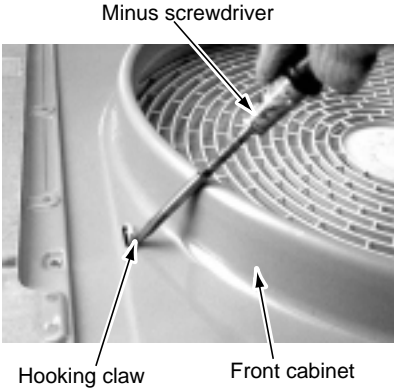
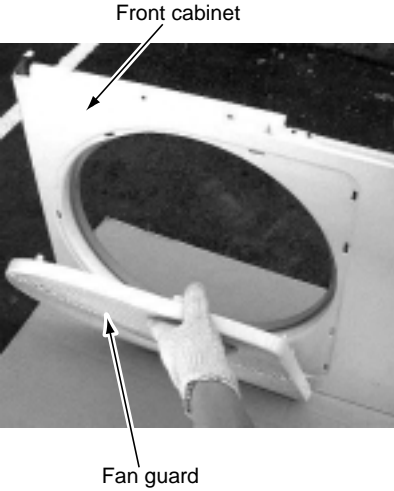
No.	Part name	Procedure	Remarks
⑨	Pulse Motor Valve (PMV) coil	<p>1. Detachment</p> <ol style="list-style-type: none"> 1) Perform works of items ① and ② . 2) Release the coil from the concavity by turning it, and remove coil from the PMV. <p>2. Attachment</p> <ol style="list-style-type: none"> 1) Put the coil deep into the bottom position. 2) Fix the coil firmly by turning it to the concavity. 	
⑩	Fan guard	<p>1. Detachment</p> <ol style="list-style-type: none"> 1) Perform works of items 1 of ① and ② . 2) Remove the front cabinet, and put it down so that fan guard side directs downward. <hr/> <p style="text-align: center;">CAUTION</p> <p>Perform works on a corrugated cardboard, cloth, etc. to prevent flaw on the product.</p> <hr/> <ol style="list-style-type: none"> 3) Remove the hooking claws by pushing with minus screwdriver along with the arrow mark in the right figure, and remove the fan guard. <p>2. Attachment</p> <ol style="list-style-type: none"> 1) Insert claws of the fan guard in the hole of the front cabinet. Push the hooking claws (10 positions) with hands and then fix the claws. <hr/> <p style="text-align: center;">CAUTION</p> <p>All the attaching works have completed. Check that all the hooking claws are fixed to the specified positions.</p> <hr/>	 

15. EXPLODED VIEWS AND PARTS LIST

15-1. Indoor Unit

15-1-1. 4-Way Air Discharge Cassette Type

RAV-SM564UT-E, RAV-SM804UT-E, RAV-SM1104UT-E, RAV-SM1404UT-E, RAV-SM1604UT-E

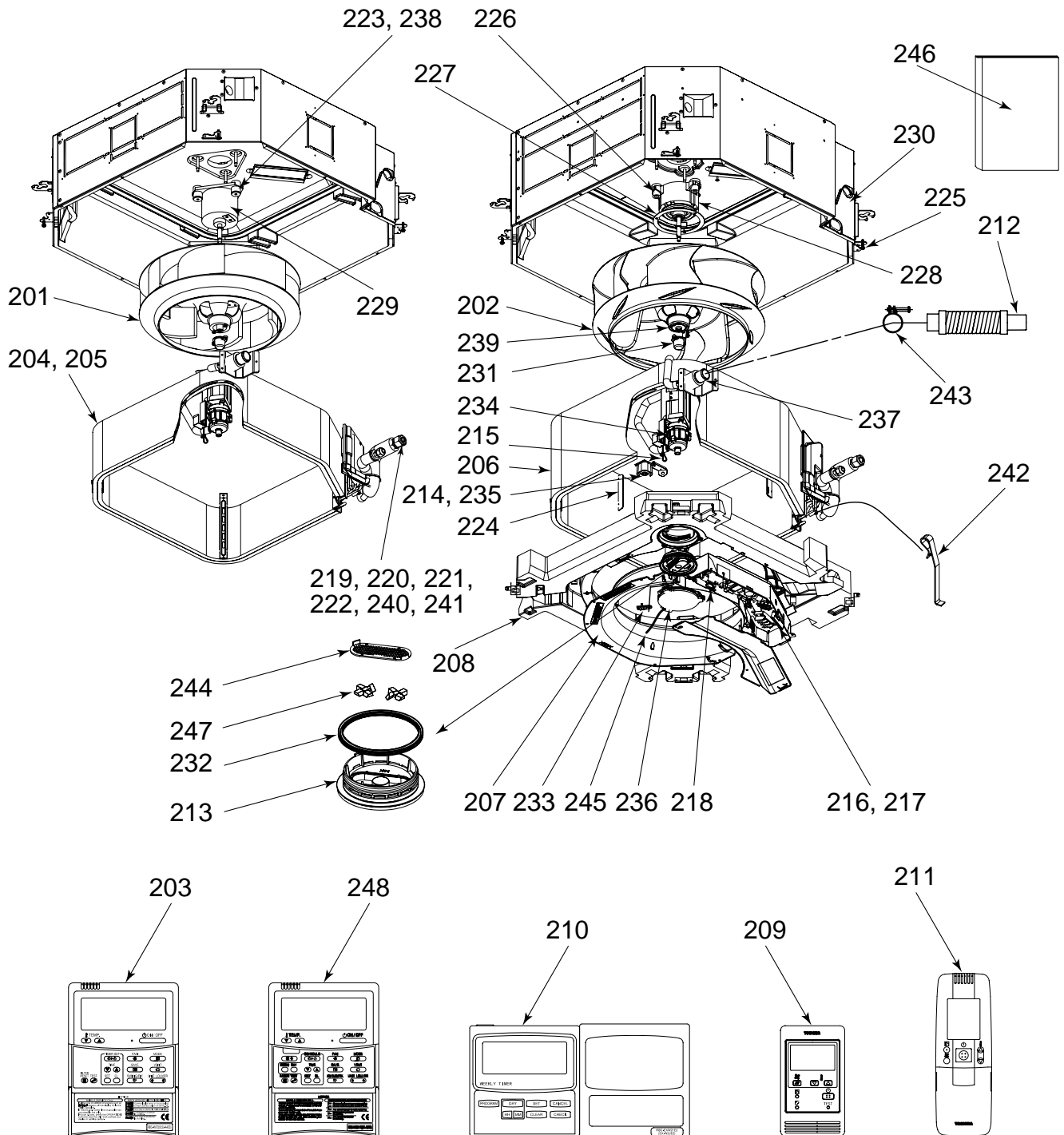

Location No.	Part No.	Description	Model Name RAV-SM				
			564UT-E	804UT-E	1104UT-E	1404UT-E	1604UT-E
201	43120248	Fan Ass'y, Turbo, ABS	1	1			
202	43120247	Fan Ass'y, Turbo, ABS			1	1	1
203	43166011	Remote Controller, SX-A4EE	1	1	1	1	
204	4314J399	Refrigeration Cycle Ass'y	1				
205	4314J400	Refrigeration Cycle Ass'y		1			
206	4314J401	Refrigeration Cycle Ass'y			1	1	1
207	43122110	Bell Mouth, ABS	1	1	1	1	1
208	43172202	Pan Ass'y, Drain	1	1	1	1	1
209	43166004	Remote Controller, SX-A11JE2	1	1	1	1	1
210	43166005	Remote Controller, EX-W2JE2	1	1	1	1	1
211	43166006	Remote Controller, WH-H1JE2	1	1	1	1	1
212	43170244	Hose, Drain, 25A	1	1	1	1	1
213	43179144	LID, Inside	1	1	1	1	1
214	43151290	Switch, Float, FS-0218-102	1	1	1	1	
215	43079249	Band, Hose	1	1	1	1	1
216	43163057	Clamp, Down, ABS	1	1	1	1	1
217	43163058	Clamp, Up, ABS	1	1	1	1	1
218	43089147	Clamp, Wire, NYLON6	3	3	3	3	3
219	43047688	Nut, Flare, 1/2 IN, RoHs	1				
220	43149352	Nut, Flare, 5/8 IN		1			1
221	43149353	Socket, 1/2"	1				
222	43149354	Socket, 5/8"		1			1
223	43139137	Rubber, Cushion	3	3			
224	43122117	Plate, Wind			4	4	4
225	43197197	Screw, Fix Panel	4	4	4	4	4
226	43139165	Rubber, Cushion			3	3	3
227	43197199	Washer			1	1	1
228	4312C038	Motor, Fan			1	1	1
229	4312C039	Motor, Fan	1	1			
230	43119497	Cover Ass'y	1	1	1	1	1
231	43139166	Cap, Nut	1	1	1	1	1
232	43179147	Gasket, VMQ	1	1	1	1	1
233	43119498	Cover, Sensor, ABS	1	1	1	1	1
234	43177010	Pump Ass'y, MDP-1401	1	1	1	1	1
235	43151299	Switch Ass'y, Float, FS-0218-102	1	1	1	1	1
236	43179145	LID Ass'y, Outside	1	1	1	1	1
237	43170254	Socket Ass'y, Drain	1	1	1	1	1
238	43197155	Washer, 25X6, 5X2T	3	3			
239	43097212	Nut	1	1	1	1	1
240	43147195	Bonnet, 1/2, IN	1				
241	43194029	Bonnet		1			1
242	43019904	Holder, Sensor, SUS	2	2			2
243	43179135	Band, Hose, 37-40	1	1	1	1	1
244	43179146	Cover, Glass	1	1	1	1	1
245	43182010	String	1	1	1	1	1
246	431S8083	Owner's Manual	1	1	1	1	1
247	43179148	Glass	1	1	1	1	1
248	43166012	Remote Controller, SX-A5EE	1	1	1	1	1

RAV-SM564UT-E, RAV-SM804UT-E, RAV-SM1104UT-E, RAV-SM1404UT-E, RAV-SM1604UT-E

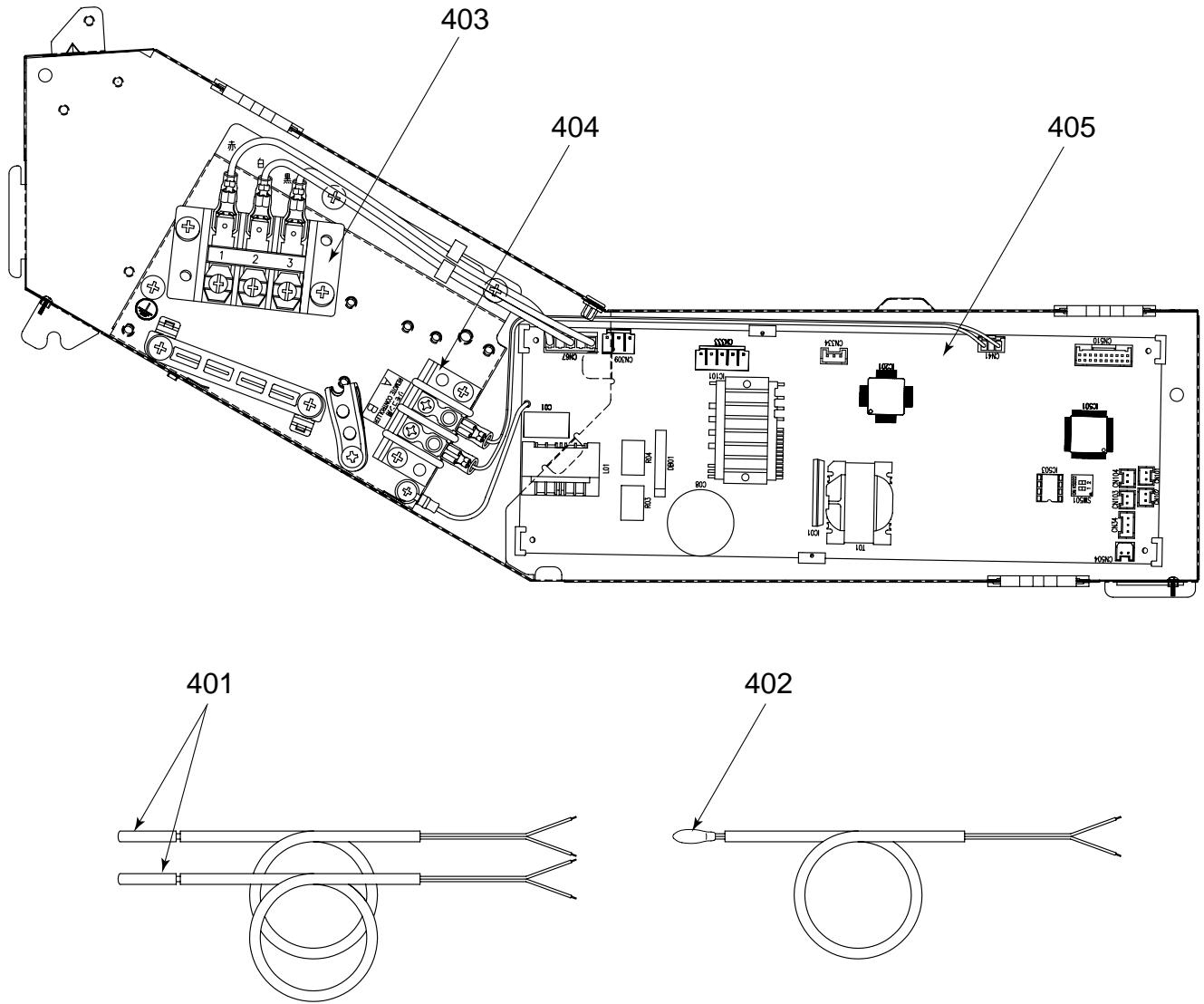

Location No.	Part No.	Description	Model Name RAV-SM	
			564UT-E / 804UT-E / 1104UT-E / 1404UT-E / 1604UT-E	
401	43050425	Sensor Ass'y, TC (F6), Service	2	
402	43050426	Sensor, TA, Service	1	
403	43160565	Terminal, Block, 3P, AC250V, 20A	1	
404	43160568	Terminal, 2P, AC30V/DC42V, 1A	1	
405	4316V355	P.C. Board Ass'y, 220-240V, MCC-1570	1	

RBC-U31PG (W, WS)-E, RBC-U31PGS (W, WS)-E

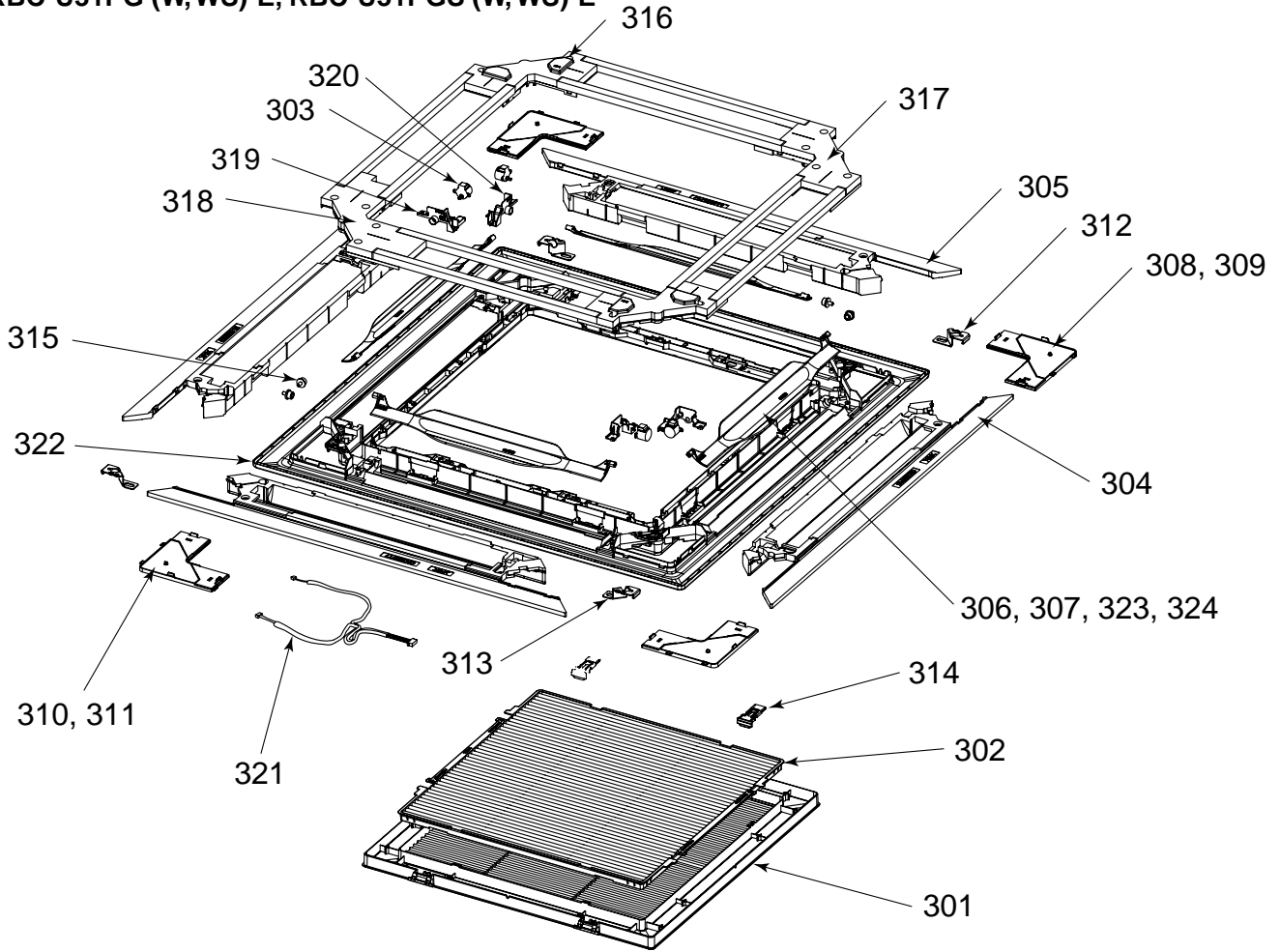

Location No.	Part No.	Description	Model Name RBC-			
			U31PG (W)-E	U31PG (WS)-E	U31PGS (W)-E	U31PGS (WS)-E
301	43409207	Grille, Air Inlet	1	1	1	1
302	43480017	Air Filter, ABS + PPNET	1	1	1	1
303	4302D003	Motor, Louver, MP24Z3N	4	4	4	4
304	43407145	Outlet, Air Form, PS-F	2	2	2	2
305	43407146	Outlet, Air Form, PS-F	2	2	2	2
306	43409212	Louver, ABS	4			
307	43409216	Louver, ABS		4		
308	43401037	Cover, Panel Ass'y	3		3	
309	43401041	Cover, Panel Ass'y		3		3
310	43401043	Cover, Panel Ass'y	1		1	
311	43401047	Cover, Panel Ass'y		1		1
312	43407148	Plate, Fix, Panel	2	2	2	2
313	43407149	Plate, Fix, Panel	2	2	2	2
314	43407150	Hook, ABS	2	2	2	2
315	43407154	Cap, AXIS, POM	4	4	4	4
316	43403010	Cover Ass'y, Motor	2	2	2	2
317	43403011	Cover Ass'y	1	1	1	1
318	43403012	Cover Ass'y	1	1	1	1
319	43407155	Fix, Motor, ABS	2	2	2	2
320	43407156	Fix, Motor, ABS	2	2	2	2
321	43460125	Lead, Motor	1	1	1	1
322	43400077	Panel, Front, PS (W)	1	1	1	1
323	43109423	Louver, ABS			4	
324	43109424	Louver, ABS				4

RBC-AX31U (W)-E, RBC-AX31U (WS)-E

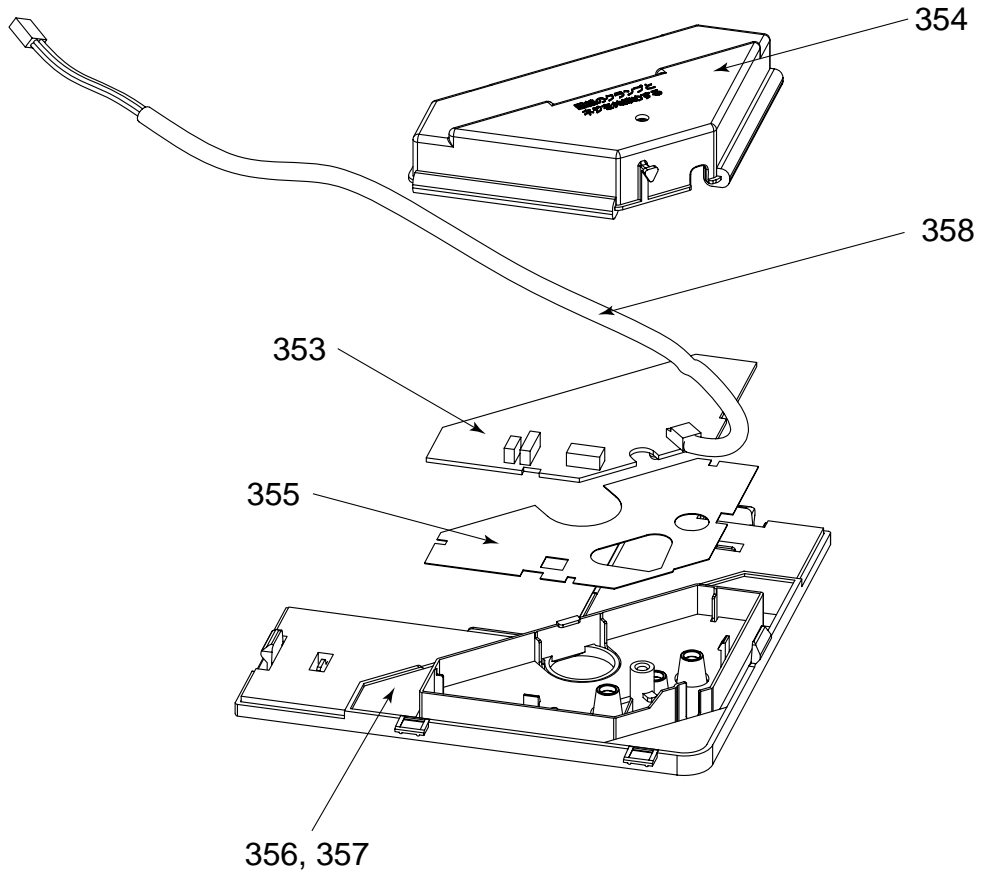

Location No.	Part No.	Description	Model Name RBC-	
			AX31U (W)-E	AX31U (WS)-E
353	43459011	P.C. Board Ass'y, Remote Receiver	1	1
354	43462010	Cover, WRS, ABS	1	1
355	43461006	Sheet, PC	1	1
356	43108018	Cover, Panel, WRS	1	
357	43108019	Cover, Panel, WRS		1
358	43460126	Lead	1	1

RAV-SM404SDT-E, RAV-SM454SDT-E, RAV-SM564SDT-EE

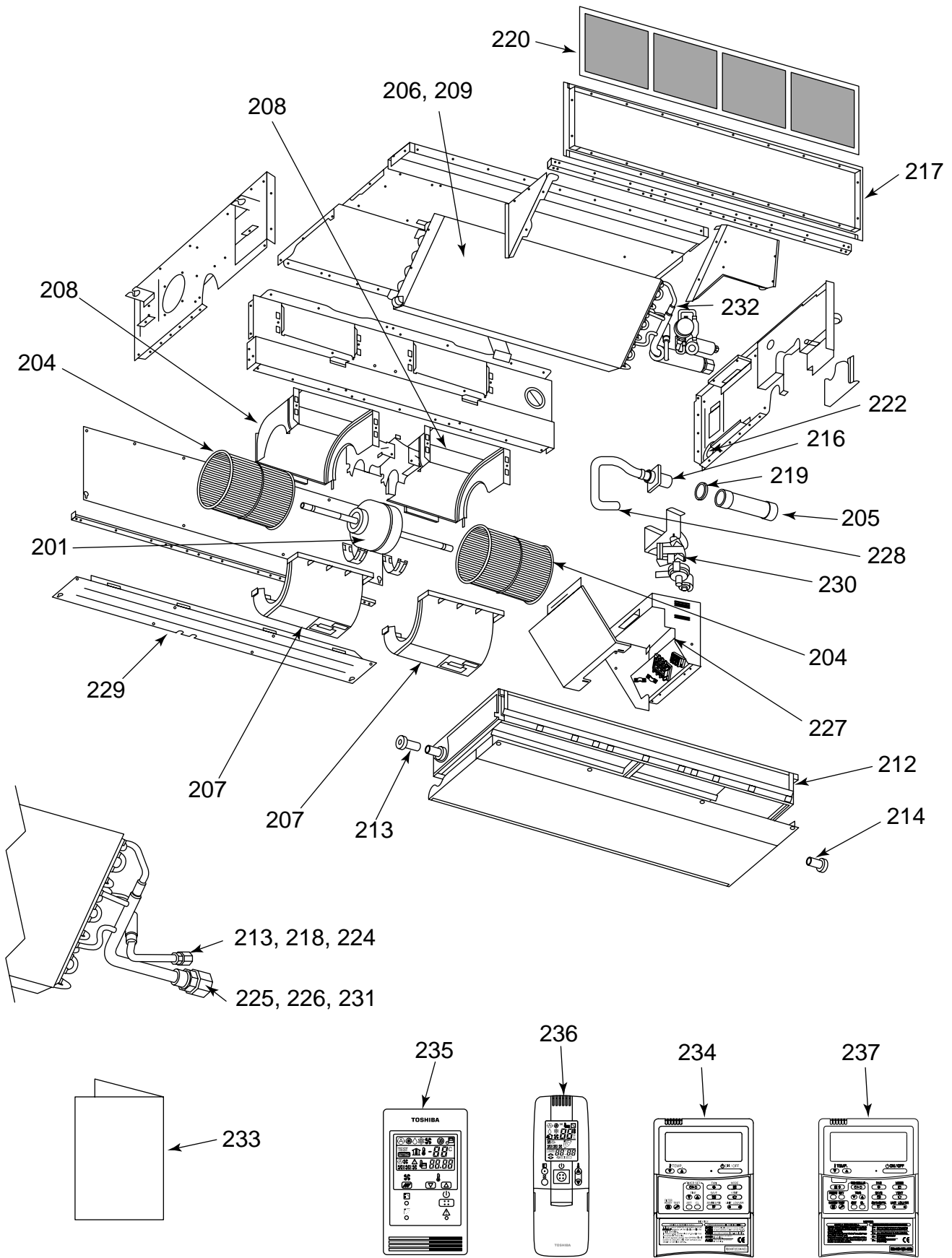

Location No.	Part No.	Description	Model Name RAV-SM		
			404SDT-E	454SDT-E	564SDT-E
201	4312C040	Motor, Fan	1	1	1
203	43120227	Fan, Multi blade	2	2	2
205	43170244	Hose, Drain	1	1	1
206	4314J402	Refrigeration Cycle Ass'y	1	1	1
207	43122084	Case, Fan, Lower	2	2	2
208	43122085	Case, Fan, Upper	2	2	2
211	43100319	Plate, Inlet-B	1	1	1
212	43172183	Pan Ass'y, Drain	1	1	1
213	43149351	Socket	1	1	1
214	43179129	Cap, Drain	2	2	2
216	43170240	Hose, Drain	1	1	1
217	43100321	Flange	1	1	1
218	43049697	Bonnet	1	1	1
219	43179135	Band, Hose	1	1	1
220	43180327	Air Filter, ABS PP	1	1	1
221	43079249	Band, Hose	1	1	1
222	43196109	Bushing	2	2	2
224	43047685	Nut, Flare, 1/4 IN	1	1	1
225	43047688	Nut, Flare, 1/2 IN	1	1	1
226	43149353	Socket, 1/2 IN	1	1	1
227	43060029	Filter, Noise	1	1	1
228	43151287	Switch, Float	1	1	1
229	43100320	Plate, Inlet-A	1	1	1
230	43177012	Pump, Drain, MDP-1401	1	1	1
231	43147195	Bonnet, 1/2 IN	1	1	1
232	43019904	Holder, Sensor SUS	2	2	2
233	431S8088	Owner's Manual	1	1	1
234	43166011	Remote controller, SX-A4EE	1	1	1
235	43166004	Remote controller, SX-A11JE2	1	1	1
236	43166006	Remote controller, WH-H1JE2	1	1	1
237	43166012	Remote controller, SX-A5EE	1	1	1

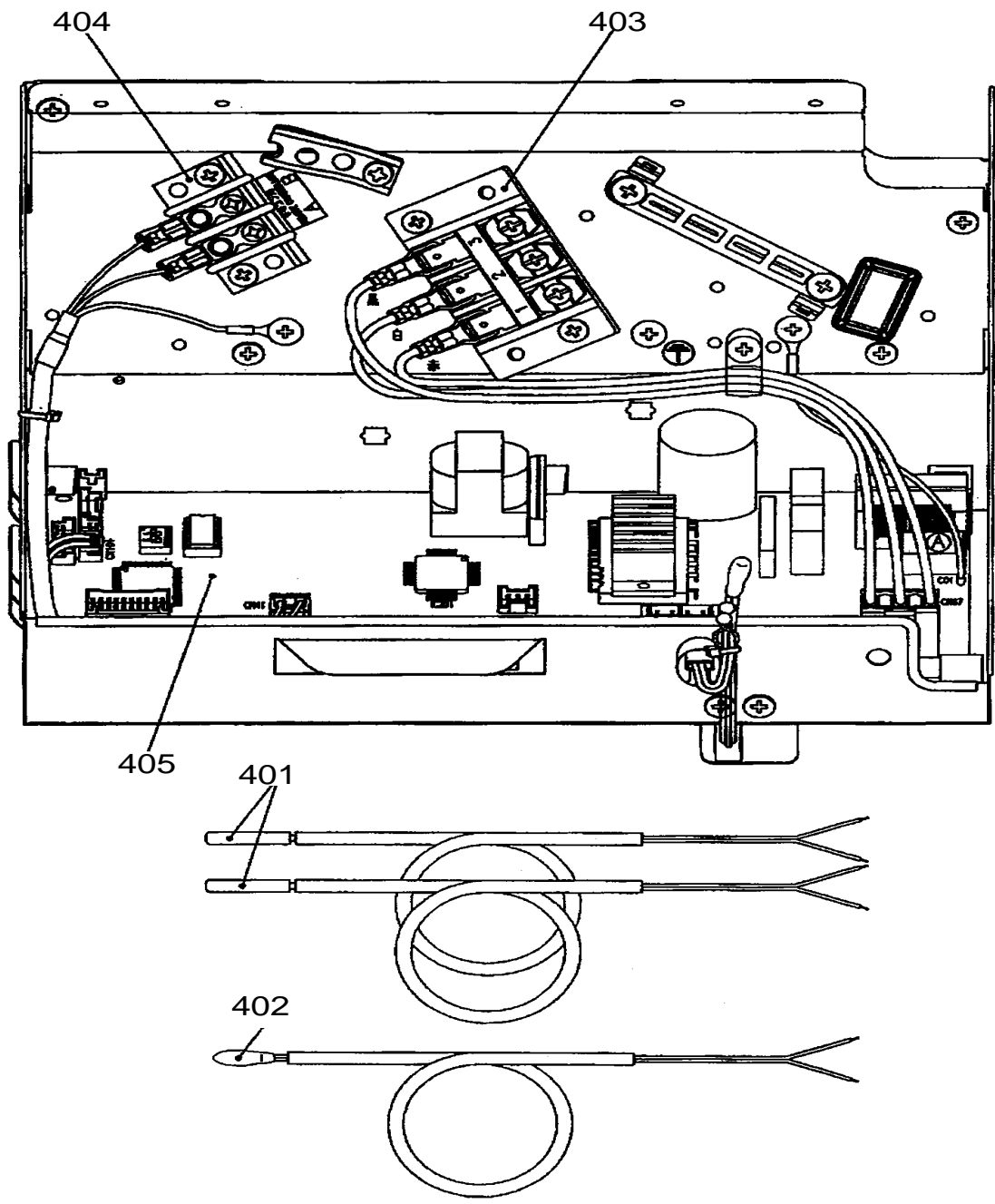

Location No.	Part No.	Description	Model Name RAV-SM		
			404SDT-E	454SDT-E	564SDT-E
401	43050425	Sensor Ass'y, Service TC (F6)	2	2	2
402	43050426	Sensor, Service	1	1	1
403	43160565	Terminal, Block, 3P, AC250V, 20A	1	1	1
404	43160568	Terminal, 2P, AC30V/DC42V, 1A	1	1	1
405	4316V368	P.C. Board Ass'y, 220-240V, MCC-1570	1	1	1

15-2. Outdoor Unit

RAV-SP1104AT-E, RAV-SP1104ATZ-E, RAV-SP1104ATZG-E
RAV-SP1404AT-E, RAV-SP1404ATZ-E, RAV-SP1404ATZG-E

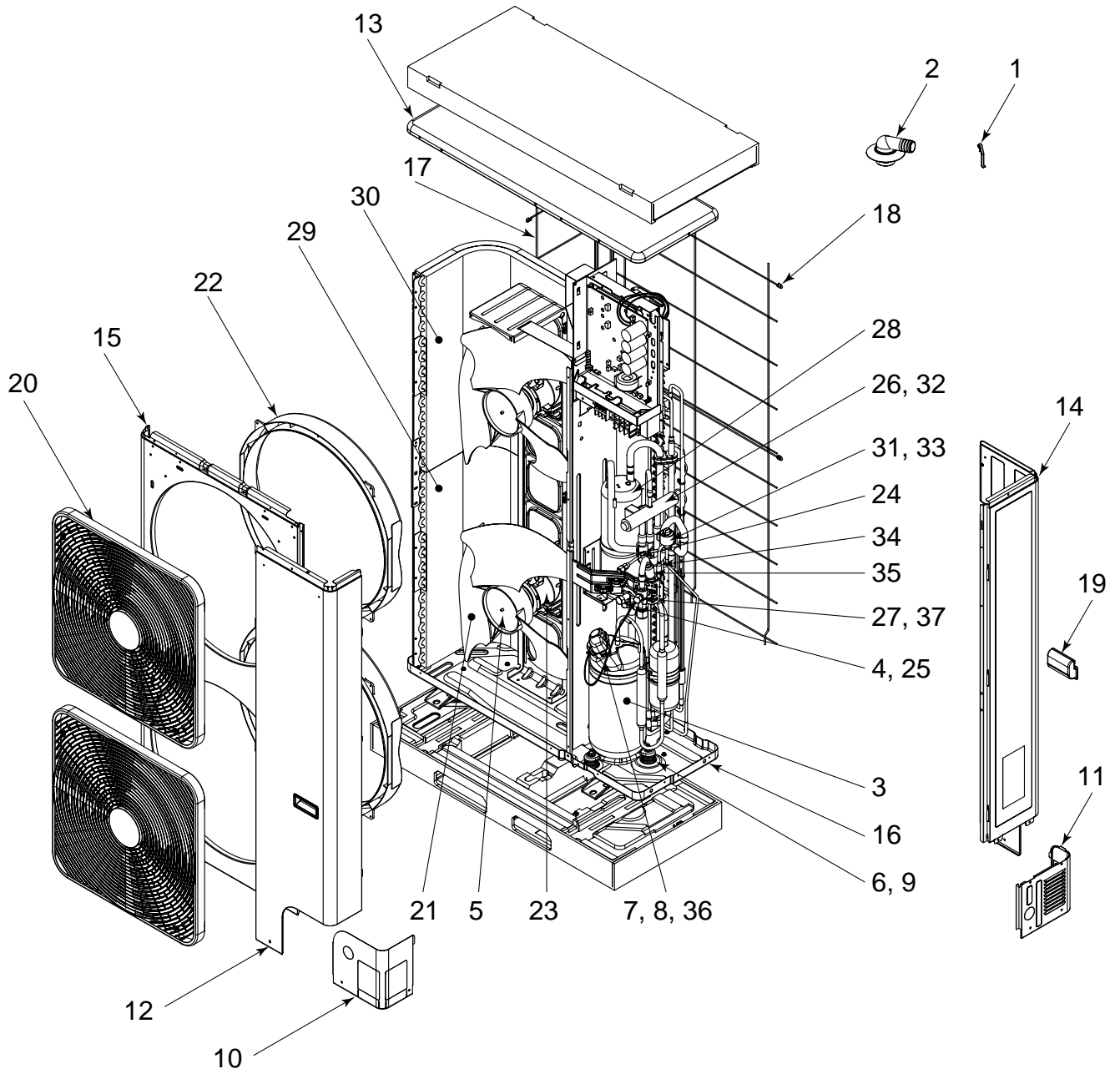

Location No.	Part No.	Description	Model Name RAV-SP					
			1104AT-E	1404AT-E	1104ATZ-E	1404ATZ-E	1104ATZG-E	1404ATZG-E
1	43019904	Holder, Sensor, SUS	3	3	3	3	3	3
2	43032441	Nipple, Drain	1	1	1	1	1	1
3	43041794	Compressor, DA422A3F-25M	1	1	1	1	1	1
4	43047246	Bonnet, 3/8 IN	1	1	1	1	1	1
5	43047669	Nut, Flange	2	2				
5	43197164	Nut, Flange, SUS304-WSB			2	2	2	2
6	43049739	Cushion, Rubber	3	3	3	3	3	3
7	43050407	Thermostat, Bimetal	1	1	1	1	1	1
8	43063317	Holder, Thermostat	1	1	1	1	1	1
9	43097212	Nut	3	3				
9	43197174	Nut, Comp., SWCH10R			3	3	3	3
10	43100437	Panel, Front, Piping	1	1	1	1	1	1
11	43100438	Panel, Back, Piping	1	1	1	1	1	1
12	43100439	Panel, Front	1	1	1	1	1	1
13	43100440	Plate, Roof	1	1	1	1	1	1
14	43100441	Panel, Side	1	1	1	1	1	1
15	43100442	Panel, Air Outlet	1	1	1	1	1	1
16	43100443	Base Ass'y	1	1	1	1	1	1
17	43107274	Guard, Fin, Side	1	1	1	1	1	1
18	43107275	Guard, Fin, Back	1	1	1	1	1	1
19	43107276	Hanger, PP	3	3	3	3	3	3
20	43109422	Guard, Fan, PP	2	2	2	2	2	2
21	43120244	Fan, Propeller, PB521, SAN-GF20	2	2	2	2	2	2
22	43122113	Bell, Mouth, PP	2	2	2	2	2	2
23	4312C037	Motor, Fan, ICF-280-A100-1	2	2	2	2	2	2
24	43146676	Joint, Check	1	1	1	1	1	1
25	43146686	Valve, Packed, 9.52	1	1	1	1	1	1
26	43146687	Valve, 4-Way, STF-0401G	1	1	1	1	1	1
27	43146724	Valve, Ball, SBV-JA5GTC-1, Rohs	1	1	1	1	1	1
28	43148170	Accumulator Ass'y, 2.5L	1	1	1	1		
28	43148188	Accumulator, 2.5L					1	1
29	4314G266	Condenser Ass'y, Down	1	1				
29	4314G267	Condenser Ass'y, Down			1	1		
29	4314G268	Condenser Ass'y, Down					1	1
30	4314G269	Condenser Ass'y, Up	1	1				
30	4314G270	Condenser Ass'y, Up			1	1		
30	4314G271	Condenser Ass'y, Up					1	1
31	4314N023	Valve, Pulse, Modulaing, UKV-25D100	1	1	1	1	1	1
32	4314N024	Coil, Valve, 4-Way, VHV-01AP552B1	1	1	1	1	1	1
33	4314N025	Coil, PMV, UKV-A038	1	1	1	1	1	1
34	4314Q031	Strainer, DIA 9.52, C1220T-H	1	1	1	1	1	1
35	4314Q032	Strainer	1	1	1	1	1	1
36	43160591	Lead Ass'y, Compressor	1	1	1	1	1	1
37	43194029	Bonnet	1	1	1	1	1	1

RAV-SP1104AT-E, RAV-SP1104ATZ-E, RAV-SP1104ATZG-E
 RAV-SP1404AT-E, RAV-SP1404ATZ-E, RAV-SP1404ATZG-E

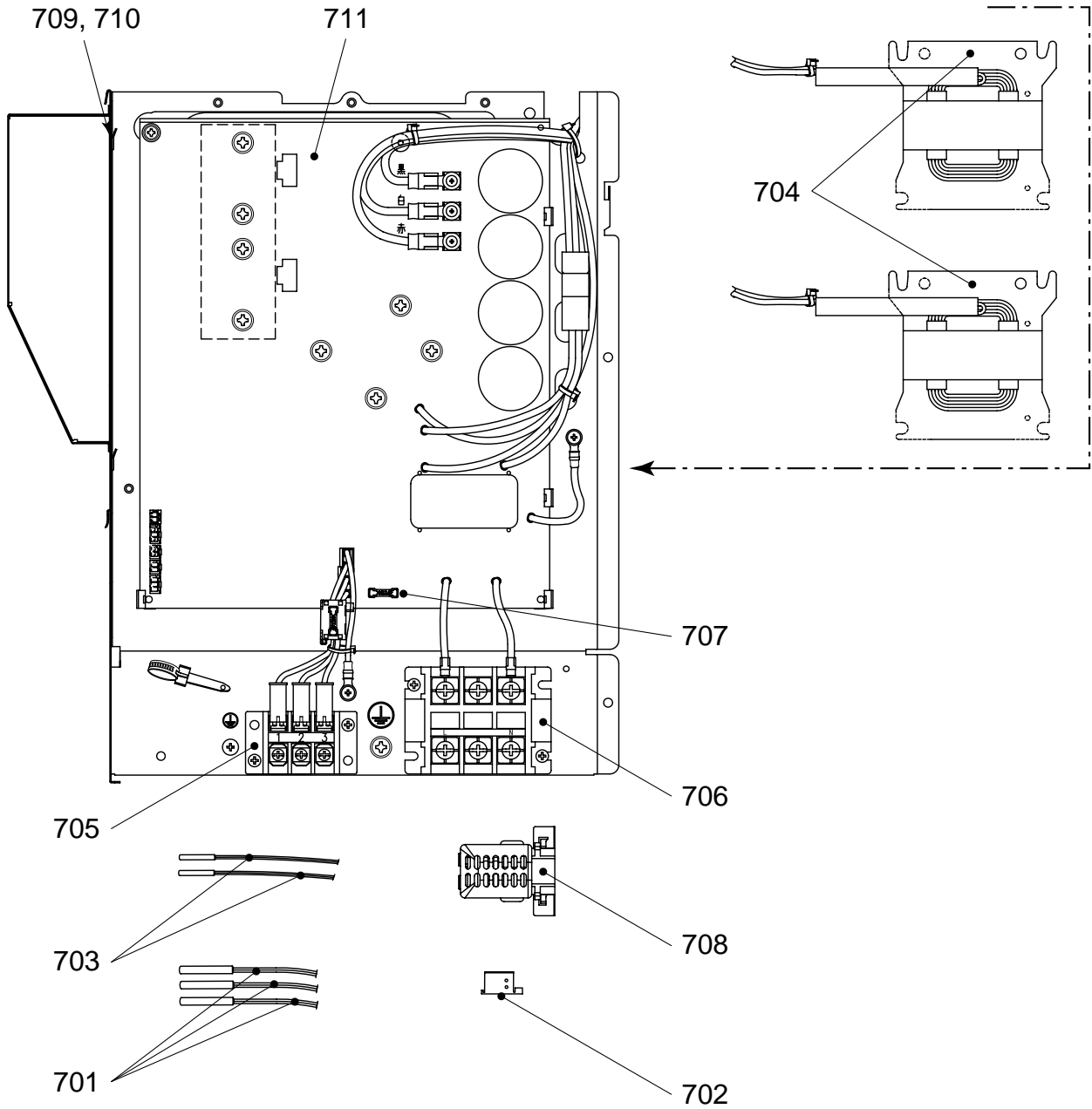

Location No.	Part No.	Description	Model Name RAV-SP					
			1104AT-E	1404AT-E	1104ATZ-E	1404ATZ-E	1104ATZG-E	1404ATZG-E
701	43050425	Sensor Ass'y, TC (F6), Service	3	3	3	3	3	3
702	43063325	Holder, Sensor, 6 - 6.35, 8	1	1	1	1	1	1
703	43150319	Sensor Ass'y, TD (F4), Service	2	2	2	2	2	2
704	43158190	Reactor, CH-62-ZT	2	2	2	2	2	2
705	43160565	Terminal Block, 3P, AC250V, 20A	1	1	1	1	1	1
706	43160581	Terminal, 3P, 60A	1	1	1	1	1	1
707	43160589	Fuse, AC250V, 10A	1	1	1	1	1	1
708	43163055	Holder, Sensor	1	1	1	1	1	1
709	43163059	Spacer (Bush), P.C. Board	1	1	1	1	1	1
710	43163060	Spacer (Collar), P.C. Board	1	1	1	1	1	1
711	4316V357	P.C. Board Ass'y, MCC-1571	1	1	1	1	1	1

RAV-SP454AT-E, RAV-SP454ATZ-E, RAV-SP454ATZG-E

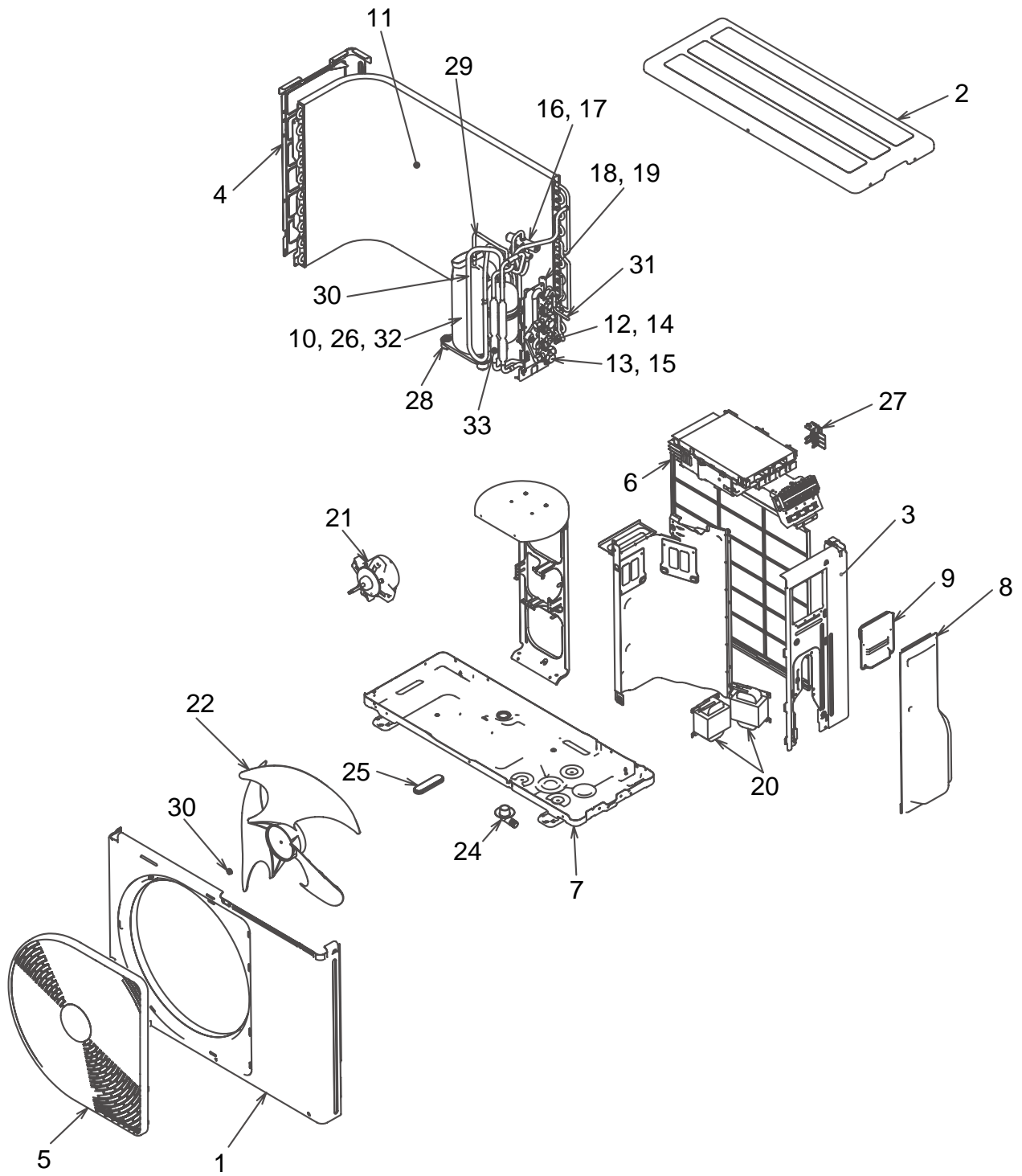

Location No.	Part No.	Description	Model Name RAV-SP					
			404AT-E	404ATZ-E	404ATZG-E	454AT-E	454ATZ-E	454ATZG-E
1	43105042	Cabinet, Front, RoHs	1	1	1	1	1	1
2	43105041	Cabinet, Upper	1	1	1	1	1	1
3	43005698	Cabinet, Side, Right, RoHs	1	1	1	1	1	1
4	43005672	Cabinet, Side, Left	1	1	1	1	1	1
5	4301V035	Guard, Fan	1	1	1	1	1	1
6	4301V053	Guard, Fin	1	1	1	1	1	1
7	43100346	Base Ass'y, RoHs	1	1	1	1	1	1
8	43119471	Caver, Valve, Packed	1	1	1	1	1	1
9	43162055	Caver, Wiring Ass'y, RoHs	1	1	1	1	1	1
10	43041786	Compressor, DA150A1F-20, RoHs	1	1	1	1	1	1
11	4314G246	Condenser Ass'y, RoHs	1			1		
11	4314G247	Condenser Ass'y, RoHs			1			1
11	4314G248	Condenser Ass'y, RoHs		1			1	
12	37546845	Valve, Packed, 6.35	1	1	1	1	1	1
13	43146680	Valve, Packed, 12.7	1	1	1	1	1	1
14	43147196	Bonnet, 1/4 IN	1	1	1	1	1	1
15	43147195	Bonnet, 1/2 IN	1	1	1	1	1	1
16	43046444	Valve, 4-WAY, STF-0108Z	1	1	1	1	1	1
17	43146722	Coil, Solenoid, STF-01A J502E1	1	1	1	1	1	1
18	43146695	Valve, Pulse, Modulating	1	1	1	1	1	1
19	37546849	Coil, PMV, CAM-MD12TF-6	1	1	1	1	1	1
20	43055521	Reactor	2	2	2	2	2	2
21	4302C068	Motor, Fan, ICF-140-43-4R	1	1	1	1	1	1
22	43020329	Fan, Propeller, PJ421	1	1	1	1	1	1
23	43047669	Nut, Flange	1			1		
23	43197164	Nut, Flange, SUS304-WSB		1	1		1	1
24	43032441	Nipple, Drain	1	1	1	1	1	1
25	43089160	Cap, Waterproof	2	2	2	2	2	2
26	43050407	Thermostat, Bimetal	1	1	1	1	1	1
27	43063339	Holder, Sensor (TO)	1	1	1	1		
28	43049749	Rubber, Cushion	3	3	3	3	3	3
29	43063321	Holder, Sensor, 4-8, 9.52	1	1	1	1	1	1
30	43063322	Holder, Sensor, 6-11.4, 12.7	1	1	1	1	1	1
31	43063325	Holder, Sensor, 6-6.35, 8	1	1	1	1	1	1
32	43063317	Holder, Thermostat	1	1	1	1	1	1
33	4314Q064	Muffler, 1/2	1	1	1	1	1	1

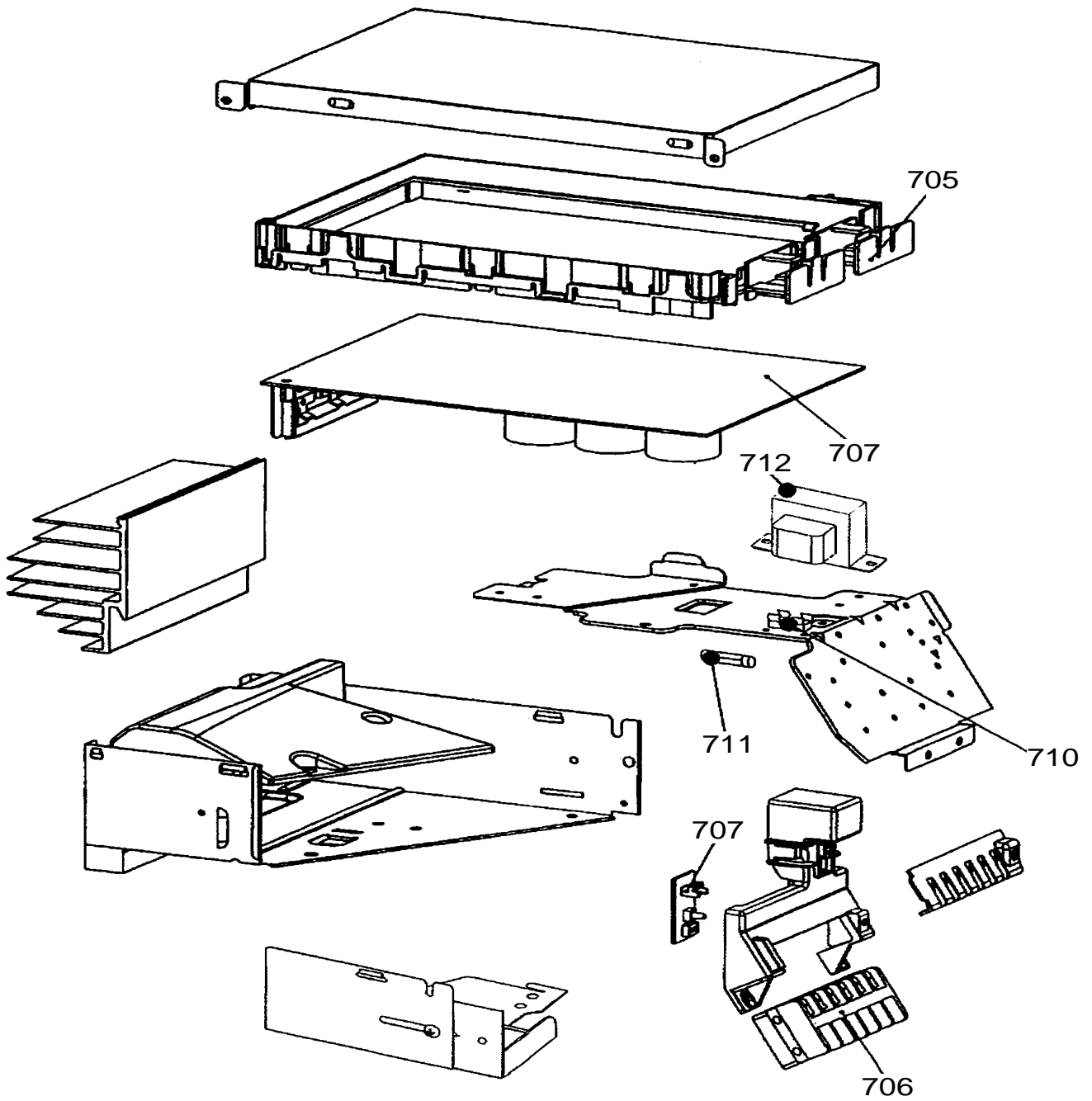

Location No.	Part No.	Description	Model Name RAV-SP					
			404AT-E	404ARZ-E	404ATZG-E	454AT-E	454ATZ-E	454ATZG-E
701	43050422	Sensor, TE	1	1	1	1	1	1
702	43050423	Sensor, TS	1	1	1	1	1	1
703	43050427	Sensor, TO	1	1	1	1	1	1
704	43050430	Sensor, TD	1	1	1	1	1	1
705	43062228	Base, P.C.board	1	1	1	1	1	1
706	43160566	Terminal, Block 6P, 20A	1	1	1	1	1	1
707	4316V293	P.C. Board Ass'y, SW, MCC-1530	1	1	1	1	1	1
708	4316V367	P.C.board Ass'y, MCC-5009	1	1	1	1	1	1
710	43160571	Fuse, Holder, 250V, 15A	1	1	1	1	1	1
711	43160590	Fuse, AC250V, 6.3A	1	1	1	1	1	1
712	43158192	Reactor	1	1	1	1	1	1

WARNINGS ON REFRIGERANT LEAKAGE

Important

Check of Concentration Limit

The room in which the air conditioner is to be installed requires a design that in the event of refrigerant gas leaking out, its concentration will not exceed a set limit.

The refrigerant R410A which is used in the air conditioner is safe, without the toxicity or combustibility of ammonia, and is not restricted by laws to be imposed which protect the ozone layer. However, since it contains more than air, it poses the risk of suffocation if its concentration should rise excessively. Suffocation from leakage of R410A is almost non-existent. With the recent increase in the number of high concentration buildings, however, the installation of multi air conditioner systems is on the increase because of the need for effective use of floor space, individual control, energy conservation by curtailing heat and carrying power etc.

Most importantly, the multi air conditioner system is able to replenish a large amount of refrigerant compared with conventional individual air conditioners. If a single unit of the multi conditioner system is to be installed in a small room, select a suitable model and installation procedure so that if the refrigerant accidentally leaks out, its concentration does not reach the limit (and in the event of an emergency, measures can be made before injury can occur).

In a room where the concentration may exceed the limit, create an opening with adjacent rooms, or install mechanical ventilation combined with a gas leak detection device.

The concentration is as given below.

$$\frac{\text{Total amount of refrigerant (kg)}}{\text{Min. volume of the indoor unit installed (m}^3\text{)}} \leq \text{Concentration limit (kg/m}^3\text{)}$$

The concentration limit of R410A which is used in multi air conditioners is 0.3kg/m³.

NOTE 1 :

If there are 2 or more refrigerating systems in a single refrigerating device, the amounts of refrigerant should be as charged in each independent device.

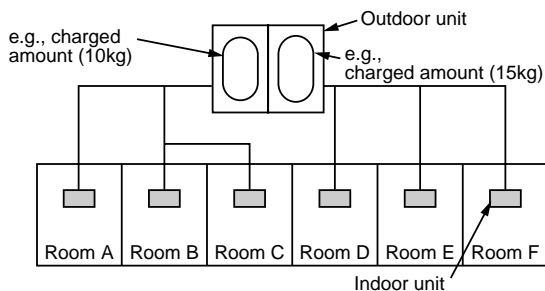

For the amount of charge in this example:

The possible amount of leaked refrigerant gas in rooms A, B and C is 10kg.

The possible amount of leaked refrigerant gas in rooms D, E and F is 15kg.

NOTE 2 :

The standards for minimum room volume are as follows.

- 1) No partition (shaded portion)

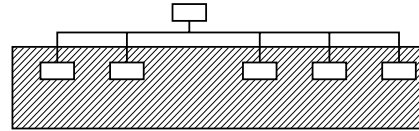

- 2) When there is an effective opening with the adjacent room for ventilation of leaking refrigerant gas (opening without a door, or an opening 0.15% or larger than the respective floor spaces at the top or bottom of the door).

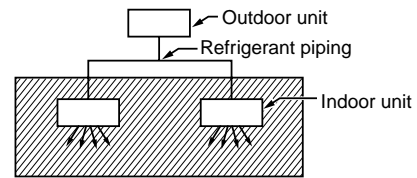

- 3) If an indoor unit is installed in each partitioned room and the refrigerant piping is interconnected, the smallest room of course becomes the object. But when a mechanical ventilation is installed interlocked with a gas leakage detector in the smallest room where the density limit is exceeded, the volume of the next smallest room becomes the object.

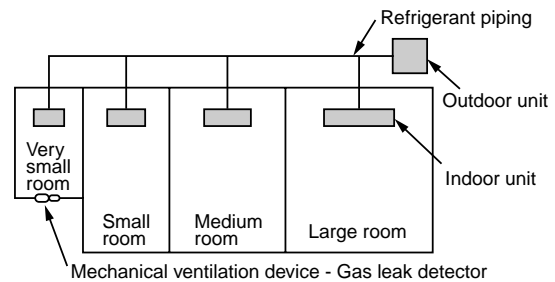

NOTE 3 :

The minimum indoor floor area compared with the amount of refrigerant is roughly as follows: (When the ceiling is 2.7m high)

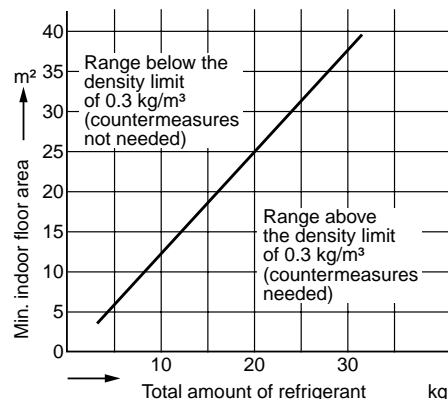

TOSHIBA CARRIER CORPORATION

23-17, TAKANAWA 3 CHOME, MINATOKU, TOKYO, 108-8580, JAPAN

Copyright © 1999 to 2007 TOSHIBA CARRIER CORPORATION, ALL Rights Reserved.