

TOSHIBA

SERVICE MANUAL

FILE NO. SVM-09036

AIR CONDITIONER

SPLIT WALL TYPE

RAS-18SKHP-ES / RAS-18S2AH-ES

RAS-24SKHP-ES / RAS-24S2AH-ES

RAS-18SKP-ES / RAS-18SA-ES

RAS-24SKP-ES / RAS-24SA-ES

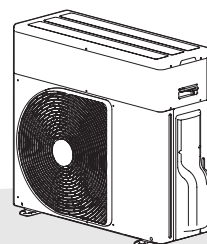

February, 2009

CONTENTS

1. SPECIFICATIONS

2. CONSTRUCTION VIEWS

- 2-1 Indoor Unit
- 2-2 Outdoor Unit

3. WIRING DIAGRAM

- 3-1 RAS-18SKP-ES / RAS-18SA-ES,
RAS-24SKP-ES / RAS-24SA-ES
- 3-2 RAS-18SKHP-ES / RAS-18S2AH-ES
RAS-24SKHP-ES / RAS-24S2AH-ES

4. SPECIFICATION OF ELECTRICAL PARTS

- 4-1 Indoor Unit (RAS-18SKP-ES, RAS-24SKP-ES)
- 4-2 Outdoor Unit (RAS-18SA-ES)
- 4-3 Outdoor Unit (RAS-24SA-ES)
- 4-4 Indoor Unit (RAS-18SKHP-ES, RAS-24SKHP-ES)
- 4-5 Outdoor Unit (RAS-18S2AH-ES)
- 4-6 Outdoor Unit (RAS-24S2AH-ES)

5. REFRIGERATION CYCLE DIAGRAM

- 5-1 RAS-18SKP-ES / RAS-18SA-ES
- 5-2 RAS-24SKP-ES / RAS-24SA-ES
- 5-3 RAS-18SKHP-ES / RAS-18S2AH-ES
- 5-4 RAS-24SKHP-ES / RAS-24S2AH-ES

6. CONTROL BLOCK DIAGRAM

- 6-1 RAS-18SKP-ES / RAS-18SA-ES,
RAS-24SKP-ES / RAS-24SA-ES
- 6-2 RAS-18SKHP-ES / RAS-18S2AH-ES
RAS-24SKHP-ES / RAS-24S2AH-ES

7. OPERATION DESCRIPTION

- 7-1 Remote control
- 7-2 Outline of Air Conditioner Control
- 7-3 Description of Operation Circuit
- 7-4 Description of Safety and Reliability Prevention Function
- 7-5 One-Touch Operation
- 7-6 Hi POWER Operation
- 7-7 QUIET Operation
- 7-8 ECO Operation
- 7-9 COMFORT SLEEP Operation
- 7-10 FILTER Check lamp
- 7-11 Auto Restart Function
- 7-12 Self-Cleaning Operation

8. INSTALLATION PROCEDURE

- 8-1 Safety Cautions
- 8-2 Installation Diagram of Indoor and Outdoor Units
- 8-3 Installation
- 8-4 Indoor Unit
- 8-5 Outdoor Unit
- 8-6 Test Operation

9. TROUBLESHOOTING CHART

- 9-1 Troubleshooting Procedure
- 9-2 Basic Check Items
- 9-3 Primary Judgement
- 9-4 Self-Diagnosis by Remote Control (Check Code)
- 9-5 How To Diagnose Faulty Parts
- 9-6 Troubleshooting for Indoor unit
- 9-7 Troubleshooting for Wiring (Interconnect cable and Serial Signal Wire)
- 9-8 Troubleshooting for P.C. Board
- 9-9 Troubleshooting for Remote Control

10. HOW TO REPLACE THE MAIN PARTS

- 10-1 Indoor Unit
- 10-2 Outdoor Unit

11. EXPLODED VIEWS AND PARTS LIST

- 11-1 Indoor Unit (E - Parts Assy)
- 11-2 Indoor Unit
- 11-3 Outdoor Unit (RAS-18SA-ES, RAS-24SA-ES)
- 11-4 Outdoor Unit (RAS-18S2AH-ES, RAS-24S2AH-ES)

1. SPECIFICATIONS

ITEM	MODEL	RAS-18SKP-ES RAS-18SA-ES		RAS-24SKP-ES RAS-24SA-ES		
		Cooling		Cooling		
Capacity	kW	220V	240V	220V	240V	
		5.30	5.35	6.80	6.85	
Power source	Phase	1 \emptyset				
	V	220 - 240				
	Hz	50				
Power consumption	W	1640	1680	2410	2450	
Power factor	%	98	97	98	93	
Running Current	A	Indoor/Outdoor	0.3/7.30	0.3/6.90	0.50/14.70	0.50/12.90
			Starting current	31		44
Moisture removal	lit/h	2.0		2.7		
Noise	Indoor (H/M+/M/L+/L)	dB		44/42/39/37/35		
	Outdoor (220-240V)	dB		45/43/41/39/37		
Refrigerant	Name of refrigerant		R410A			
	Rated amount	kg	1.65	1.70		
Refrigerant control	Capillary tube					
Interconnection pipe	Gas side size	mm	\emptyset 12.7			
	Connection type	Flare connection				
	Liquid side size	mm	\emptyset 6.35			
	Connection type	Flare connection				
	Maximum length (One way)	m	15* ¹			
	Maximum height difference	m	20* ²	25* ²		
INDOOR UNIT		RAS-18SKP-ES		RAS-24SKP-ES		
Dimensions	Height	mm	320			
	Width	mm	1050			
	Depth	mm	228			
Net weight	kg	13				
Evaporator type	Finned tube					
Indoor fan type	Cross flow fan					
Airflow volume	High fan	m ³ /h	1000	1100		
	Medium fan	m ³ /h	880	950		
	Low fan	m ³ /h	750	850		
Fan motor output	W	30				
Air filter	Honeycomb woven filter with PP frame					
OUTDOOR UNIT		RAS-18SA-ES		RAS-24SA-ES		
Dimensions	Height	mm	715			
	Width	mm	780			
	Depth	mm	290			
Net weight	kg	45	50			
Condenser type	Finned tube					
Outdoor fan type	Propeller fan					
Airflow volume	m ³ /h	2400	2550	2450	2600	
Fan motor output	W	42				
Compressor	Model	PA200X2CS-4KU1		PA270X3CS-4MU2		
	Output	W	1500	2000		
Safety device	Fuse , IOL					
Louver type	Automatic louver					
Usable outdoor temperature range	°C	15 ~ 43				

Note *1 Chargeless pipe

*2 Maximum pipe

MODEL			RAS-18SKHP-ES				RAS-24SKHP-ES			
			RAS-18S2AH-ES				RAS-24S2AH-ES			
ITEM			Cooling		Heating		Cooling		Heating	
			220V	240V	220V	240V	220V	240V	220V	240V
Capacity	kW		5.10	5.12	5.45	5.56	6.30	6.35	6.80	6.90
Power source	Phase	1Ø								
	V	220 - 240								
	Hz	50								
Power consumption	W		1540	1580	1470	1530	2190	2250	2050	2140
Power factor	%		98	96	98	97	98	93	98	93
Running Current	Indoor	A	0.30				0.30			
	Outdoor	A	6.85	6.55	6.55	6.30	9.90	9.80	9.20	9.30
Starting current	A		31				44			
Moisture removal	lit/h		2.0				2.5			
Noise	Indoor (H/M+/M/L+/L)	dB	44/42/39/37/35				45/43/41/39/37			
	Outdoor (220-240V)	dB	56-57		57-58		56-57		57-58	
Refrigerant	Name of refrigerant		R410A							
	Rated amount		1.53				1.62			
Refrigerant control			Capillary tube							
Interconnection pipe	Gas side size		Ø12.7							
	Connection type		Flare connection							
	Liquid side size		Ø6.35							
	Connection type		Flare connection							
	Maximum length (One way)		20* ²				25* ²			
	Maximum height difference		8				10			
INDOOR UNIT			RAS-18SKHP-ES				RAS-24SKHP-ES			
Dimensions	Height	mm	320							
	Width	mm	1050							
	Depth	mm	228							
Net weight	kg		13							
Evaporator type			Finned tube							
Indoor fan type			Cross flow fan							
Airflow volume	High fan	m ³ /h	1000		1000		1100		1100	
	Medium fan	m ³ /h	880		900		950		950	
	Low fan	m ³ /h	750		770		850		850	
Fan motor output	W		30							
Air filter			Honeycomb woven filter with PP frame							
OUTDOOR UNIT			RAS-18S2AH-ES				RAS-24S2AH-ES			
Dimensions	Height	mm	715				715			
	Width	mm	780				780			
	Depth	mm	290				290			
Net weight	kg		47				53			
Condenser type			Finned tube							
Outdoor fan type			Propeller fan							
Airflow volume	m ³ /h		2400	2550	2400	2550	2400	2550	2400	2550
Fan motor output	W		42							
Compressor	Model		PA200X2CS-4KU1				PA270X3CS-4MU2			
	Output		1500				2000			
Safety device			Td sensor , Fuse , IOL							
Louver type			Automatic louver							
Usable outdoor temperature range	°C		15 ~ 43		-10 ~ 24		15 ~ 43		-10 ~ 24	

Note *1 Chargeless pipe
*2 Maximum pipe

Note : 1

- Capacity is based on the following temperature conditions.

Temperature		Condition	JIS C9612	
			Cooling	Heating
Indoor unit inlet air temperature	(DB)		27°C	20°C
	(WB)		19°C	15°C
Outdoor unit inlet air temperature	(DB)		35°C	7°C
	(WB)		24°C	6°C

Note : 2

- Charge refrigerant according to the table below.

	Refrigerant	RAS-18SKP-ES / RAS-18SA-ES RAS-18SKHP-ES / RAS-18S2AH-ES	RAS-24SKP-ES / RAS-24SA-ES RAS-24SKHP-ES / RAS-24S2AH-ES
*1	No need to charge extra refrigerant	15 m or less	15 m or less
*2	Need to charge extra refrigerant	Over 15 m up to 20 m (20 g/m)	Over 15 m up to 25 m (20 g/m)

2. CONSTRUCTION VIEWS

2-1. Indoor Unit

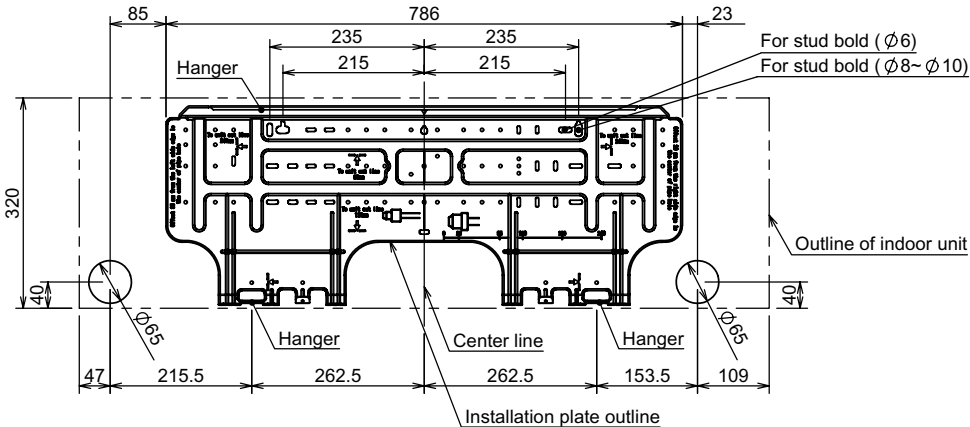
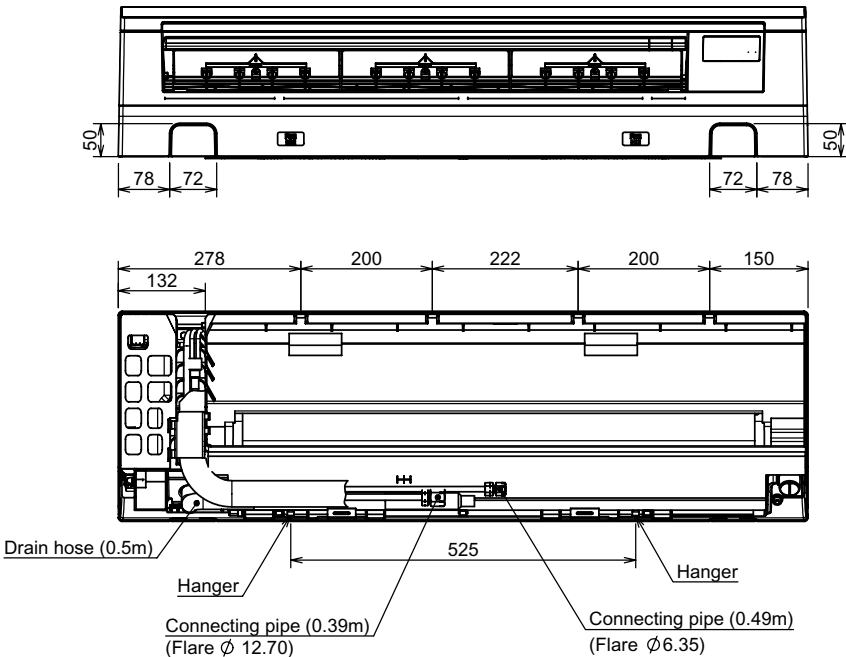
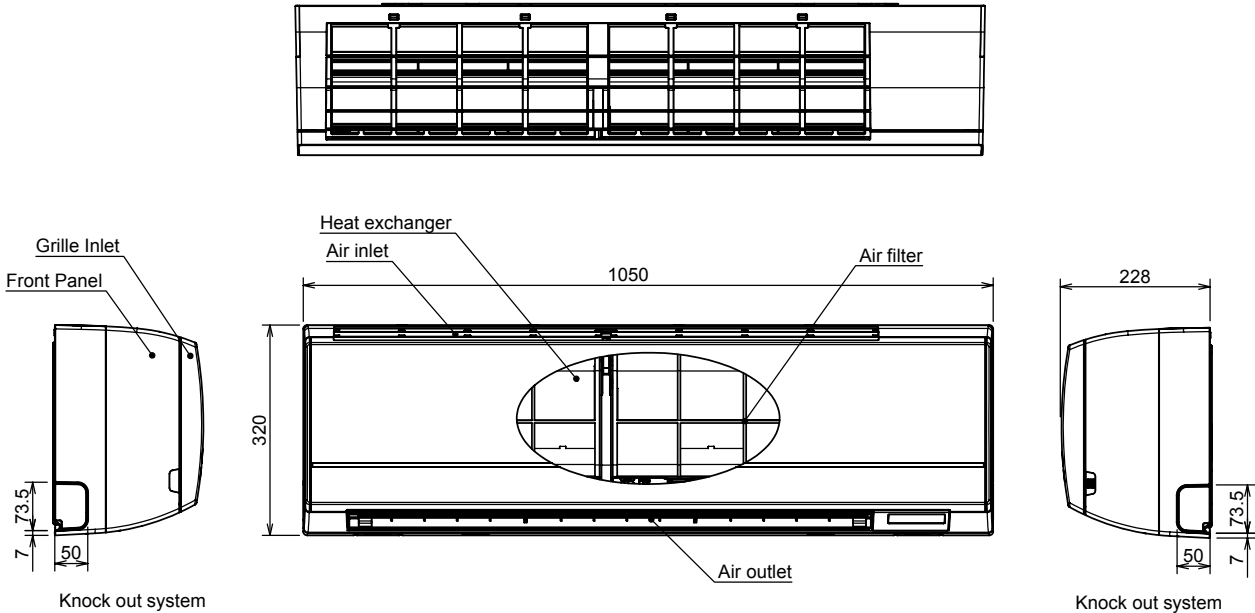

2-2. Outdoor Unit

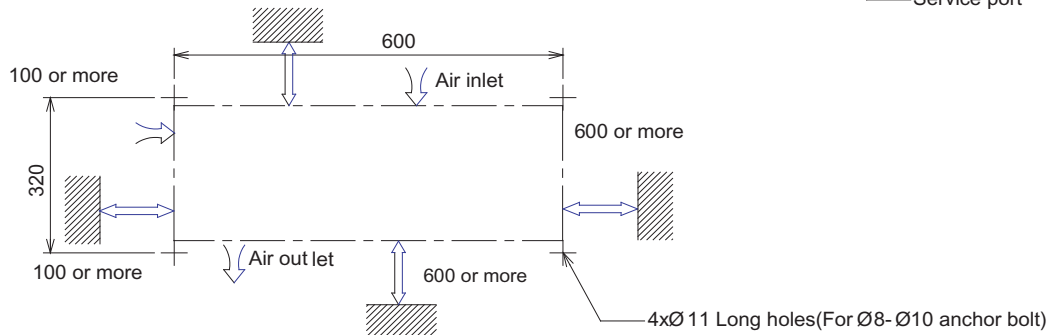
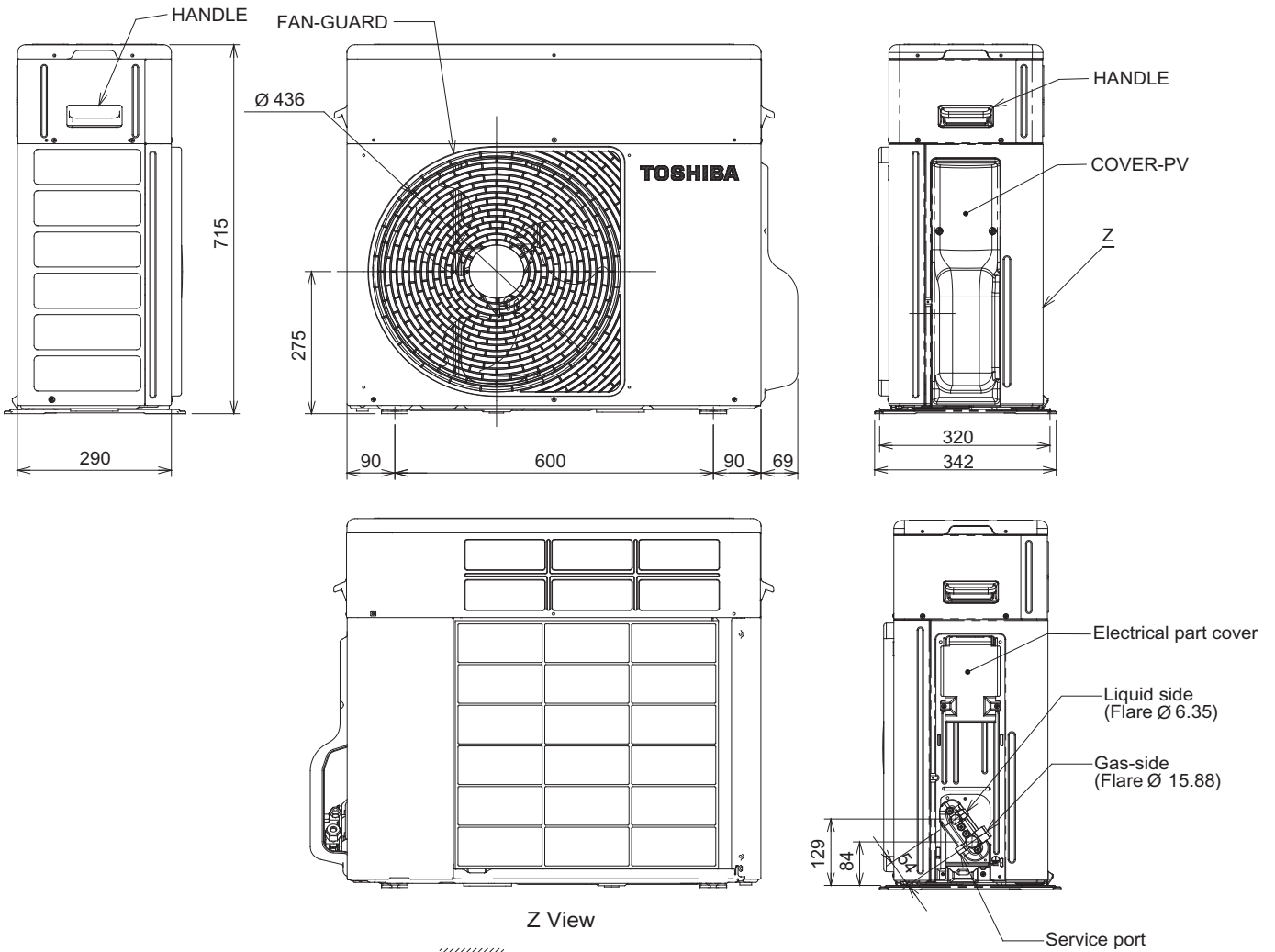
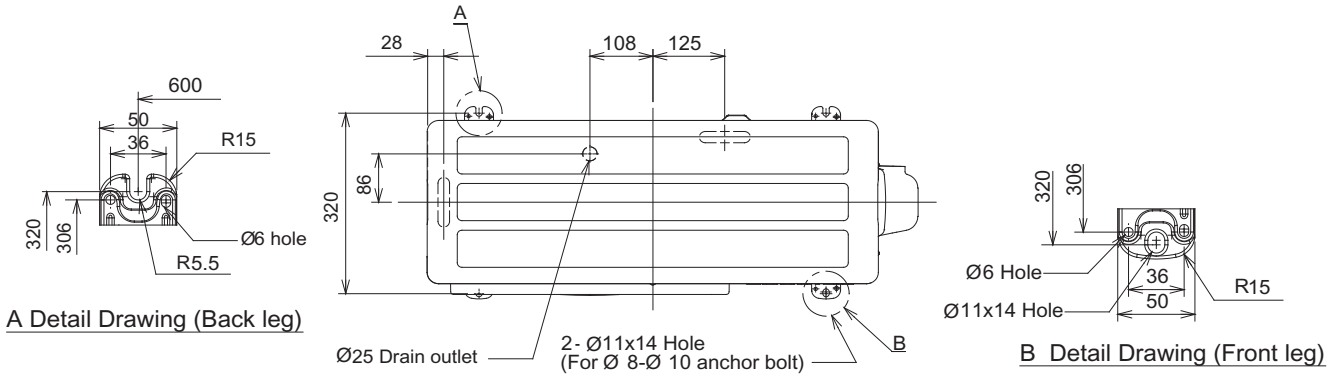

3. WIRING DIAGRAM

3-1. RAS-18SKP-ES / RAS-18SA-ES, RAS-24SKP-ES / RAS-24SA-ES

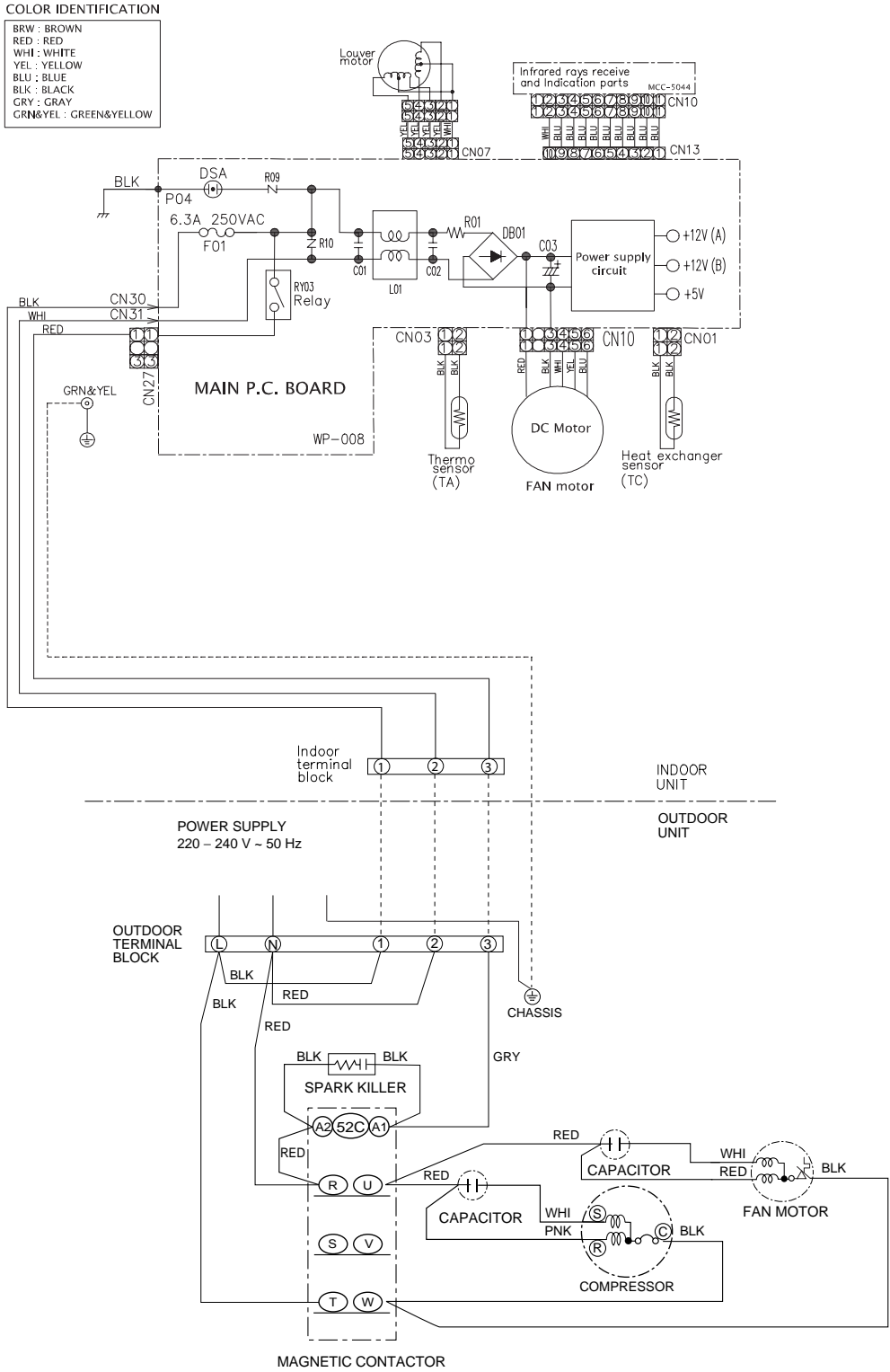

3-2. RAS-18SKHP-ES / RAS-18S2AH-ES, RAS-24SKHP-ES / RAS-24S2AH-ES

COLOR IDENTIFICATION

BRW	: BROWN
RED	: RED
WHI	: WHITE
YEL	: YELLOW
BLU	: BLUE
BLK	: BLACK
GRY	: GRAY
GRN&YEL	: GREEN&YELLOW

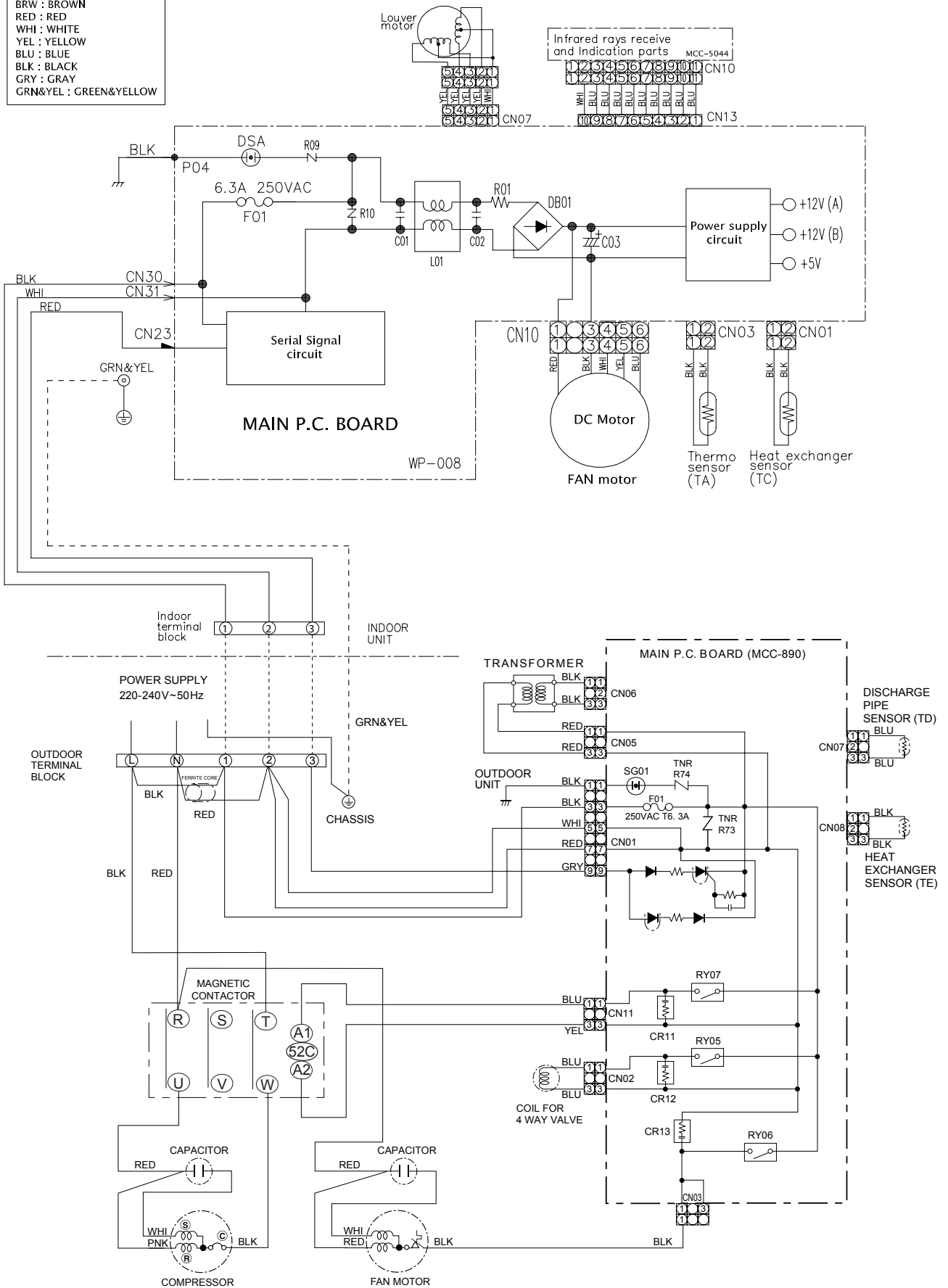

4. SPECIFICATION OF ELECTRICAL PARTS

4-1. Indoor Unit (RAS-18SKP-ES, RAS-24SKP-ES)

No.	Parts name	Type	Specifications
1	Fan motor (for indoor)	ICF-340-30-2B	DC 340V, 30W
2	Thermo sensor (TA-sensor)	————	10 k Ω at 25°C
3	Switching Transformer (T01)	SWT-77	DC7V, 12 V
4	Microcontroller	TMP87CM40ANG-6P68	
5	Heat exchanger sensor (TC-sensor)	————	10 k Ω at 25°C
6	Line filter (L01)	LC*SS11V-R06270	27mH, 600mA
7	Diode (DB01)	D3SBA60	4 A, 600 V
8	Capacitor (C03)	EKMH451VSN121MQ35S	120 μ F, 450 V
9	Fuse (F01)	BET 6.3A	6.3 A, 250 V
10	Varistor (R09, R10)	SR561K14DL	560 V
11	Resistor (R01)	RF-5TK1R8	1.8 Ω , 5W
12	Louver motor	MP24Z3T	Output (Rated) 2 W, 6 poles, 1-2 phase, DC 12 V
13	Relay : (RY03)	G5NB-1A-CA	Coil DC 12V, 16.7mA, Contact AC 250V, 1A

4-2. Outdoor Unit (RAS-18SA-ES)

No.	Parts name	Type	Specifications		
1	Compressor	PA200X2CS-4KU1	Output (Rated) 1500W, 2poles, 1 phase, 220 – 240V, 50Hz		
			Winding resistance (Ω) (at 20°C)	Red-Black 1.85	White-Black 2.62
2	Fan motor (for outdoor)	FG-240-42A	Output (Rated) 42W, 4poles, 1 phase, 220 – 240V, 50Hz		
			Winding resistance (Ω) (at 20°C)	Red-Black 128	White-Black 126
3	Running capacitor (for fan motor)	DS451305NPQB	AC 450V, 3.0 μ F		
4	Running capacitor (for compressor)	B32332I5606J063	AC 450V, 50 μ F		
5	Magnetic contactor	CLK-26J	220 – 240V, 50Hz		

4-3. Outdoor Unit (RAS-24SA-ES)

No.	Parts name	Type	Specifications		
1	Compressor	PA270X3CS-4MU2	Output (Rated) 2000W, 2poles, 1 phase, 220 – 240V, 50Hz		
			Winding resistance (Ω) (at 20°C)	Red-Black 1.37	White-Black 2.55
2	Fan motor (for outdoor)	FG-240-42A	Output (Rated) 42W, 4poles, 1 phase, 220 – 240V, 50Hz		
			Winding resistance (Ω) (at 20°C)	Red-Black 128	White-Black 126
3	Running capacitor (for fan motor)	DS451355NPQB	AC 450V, 3.5 μ F		
4	Running capacitor (for compressor)	B32332I5606J063	AC 450V, 60 μ F		
5	Magnetic contactor	CLK-35J	220 – 240V, 50Hz		

4-4. Indoor Unit (RAS-18SKHP-ES, RAS-24SKHP-ES)

No.	Parts name	Type	Specifications
1	Fan motor (for indoor)	ICF-340-30-2B	DC 340V, 30W
2	Thermo sensor (TA-sensor)	—	10 k Ω at 25°C
3	Switching Transformer (T01)	SWT-77	DC 7V, 12V
4	Microcontroller	TMP87CM40ANG-6P68	
5	Heat exchanger sensor (TC-sensor)	—	10 k Ω at 25°C
6	Line filter (L01)	LC*SS11V-R06270	27mH, 600mA
7	Diode (DB01)	D3SBA60	4 A, 600 V
8	Capacitor (C03)	EKMH451VSN121MQ35S	120 μ F, 450 V
9	Fuse (F01)	BET 6.3A	6.3 A, 250 V
10	Varistor (R09, R10)	SR561K14DL	560 V
11	Resistor (R01)	RF-5TK1R8	1.8 Ω , 5W
12	Louver motor	MP24Z3T	Output (Rated) 2 W, 6 poles, 1-2 phase, DC 12 V

4-5. Outdoor Unit (RAS-18S2AH-ES)

No.	Parts name	Type	Specifications		
1	Compressor	PA200X2CS-4KU1	Output (Rated) 1500W, 2poles, 1 phase, 220 – 240V, 50Hz		
			Winding resistance (Ω) (at 20°C)	Red-Black 1.85	White-Black 2.62
2	Fan motor (for outdoor)	FG-240-42A-1	Output (Rated) 42W, 4poles, 1 phase, 220 – 240V, 50Hz		
			Winding resistance (Ω) (at 20°C)	Red-Black 128	White-Black 126
3	Running capacitor (for fan motor)	DS451305NPQB	AC 450V, 3.0 μ F		
4	Running capacitor (for compressor)	B32332I5606J063	AC 450V, 50 μ F		
5	Solenoid coil (for 4-way valve)	VHV (STF)	AC 220 – 240V		
6	Thermo sensor	TE / TD	10k Ω at 25°C / 50k Ω at 25°C		
7	Magnetic contactor	CLK-26J	220 – 240V, 50Hz		
8	Transformer	TT-05	220 – 240V		
9	Microcomputer	TMP47C840N			
10	Varistor (R73, R74)	15G471K	470V		
11	Fuse (F01)	TSCR	T6.3A, 250V		

4-6. Outdoor Unit (RAS-24S2AH-ES)

No.	Parts name	Type	Specifications		
1	Compressor	PA270X3CS-4MU2	Output (Rated) 2000W, 2poles, 1 phase, 220 – 240V, 50Hz		
			Winding resistance (Ω) (at 20°C)	Red-Black 1.37	White-Black 2.55
2	Fan motor (for outdoor)	FG-240-42A-1	Output (Rated) 42W, 4poles, 1 phase, 220 – 240V, 50Hz		
			Winding resistance (Ω) (at 20°C)	Red-Black 128	White-Black 126
3	Running capacitor (for fan motor)	DS451305NPQB	AC 450V, 3.0 μ F		
4	Running capacitor (for compressor)	B32332I5606J063	AC 450V, 60 μ F		
5	Solenoid coil (for 4-way valve)	VHV (STF)	AC 220 ~ 240V		
6	Thermo sensor	TE / TD	10k Ω at 25°C / 50k Ω at 25°C		
7	Magnetic contactor	CLK-35J	220 ~ 240V, 50Hz		
8	Transformer	TT-05	220 ~ 240V		
9	Microcontroller	TMP47C840N			
10	Varistor (R73, R74)	15G471K	470V		
11	Fuse (F01)	TSCR	T6.3A, 250V		

5. REFRIGERATION CYCLE DIAGRAM

5-1. RAS-18SKP-ES / RAS-18SA-ES

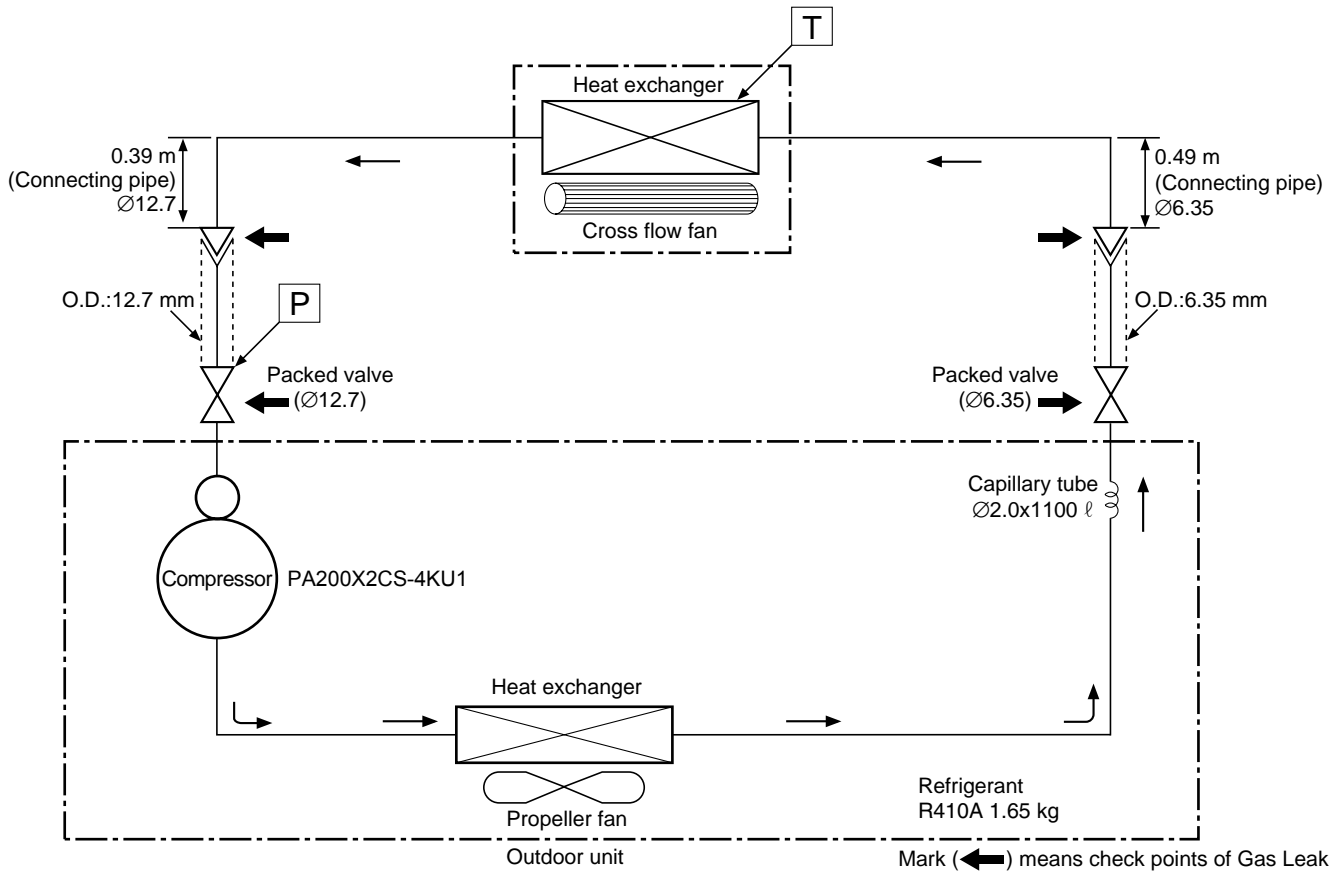

50 Hz		Standard pressure P (MPaG)	Surface temp. of heat exchanger interchanging pipe T (°C)	Fan speed (indoor)	Ambient temp. conditions DB/WB (°C)	
					Indoor	Outdoor
Cooling	Standard	0.94	10.6	High	27/19	35/24
	High temperature	1.09	15.0	High	32/23	43/26
	Low temperature	0.75	4.3	Low	21/15	21/15

Note : Measure the heat exchanger temperature at the center of U-bend. (By means of TC sensor.)

5-2. RAS-24SKP-ES / RAS-24SA-ES

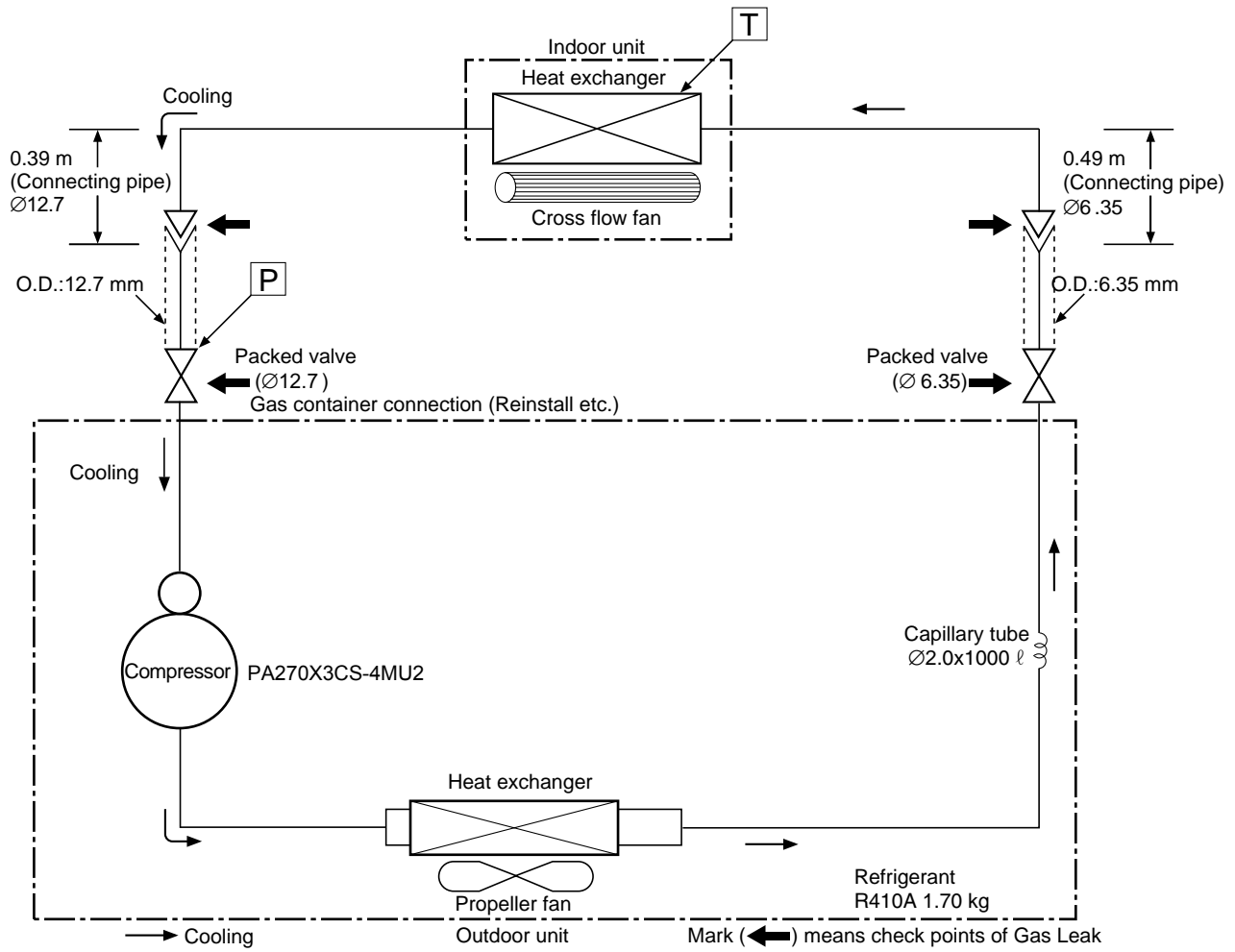

50 Hz		Standard pressure P (MPaG)	Surface temp. of heat exchanger interchanging pipe T (°C)	Fan speed (indoor)	Ambient temp. conditions DB/WB (°C)	
					Indoor	Outdoor
Cooling	Standard	0.84	13.0	High	27/19	35/24
	High temperature	1.01	17.0	High	32/23	43/26
	Low temperature	0.65	5.0	Low	21/15	21/15

Note : Measure the heat exchanger temperature at the center of U-bend. (By means of TC sensor.)

5-3. RAS-18SKHP-ES / RAS-18S2AH-ES

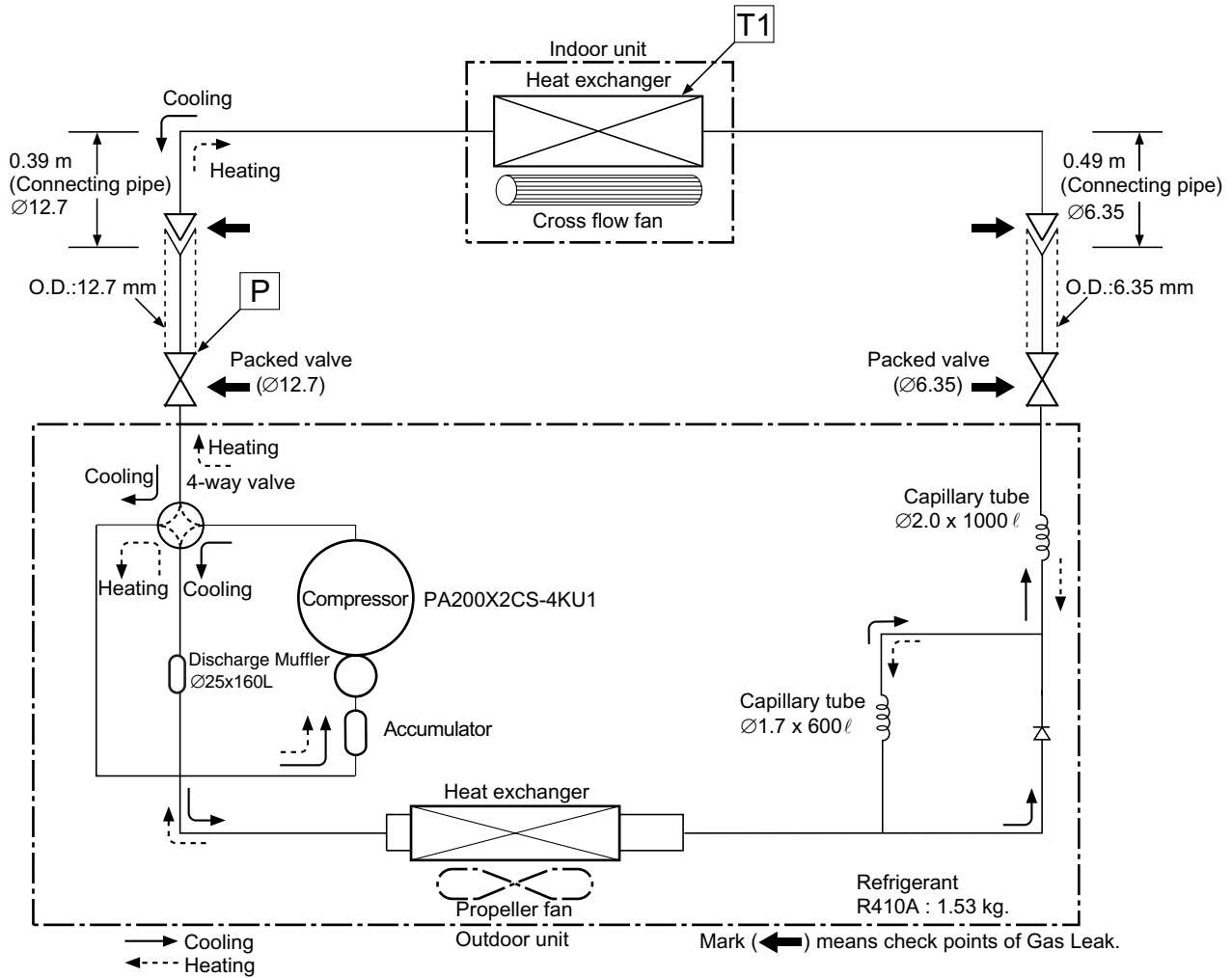

50Hz		Standard pressure P (MPaG)	Surface temp. of heat exchanger interchanging pipe T1 (°C)	Fan speed (indoor)	Ambient temp. conditions DB/WB (°C)	
					Indoor	Outdoor
Heating	Standard	2.53	44.0	High	20/15	7/6
	Overload*1	3.30 ~ 3.65	51.0 ~ 55.0	Low	27/-	24/18
	Low temperature	1.75	32.0	High	20/-	-10/-10
Cooling	Standard	0.54	11.0	High	27/19	35/24
	Overload	1.12	15.0	High	32/23	43/26
	Low temperature	0.72	4.2	Low	21/15	21/15

Note

• Measure the heat exchanger temperature at the center of U-bend. (By means of TC sensor)

*1 • During heating overload operation, a value for the high temperature limit control operation is included.

5-4. RAS-24SKHP-ES / RAS-24S2AH-ES

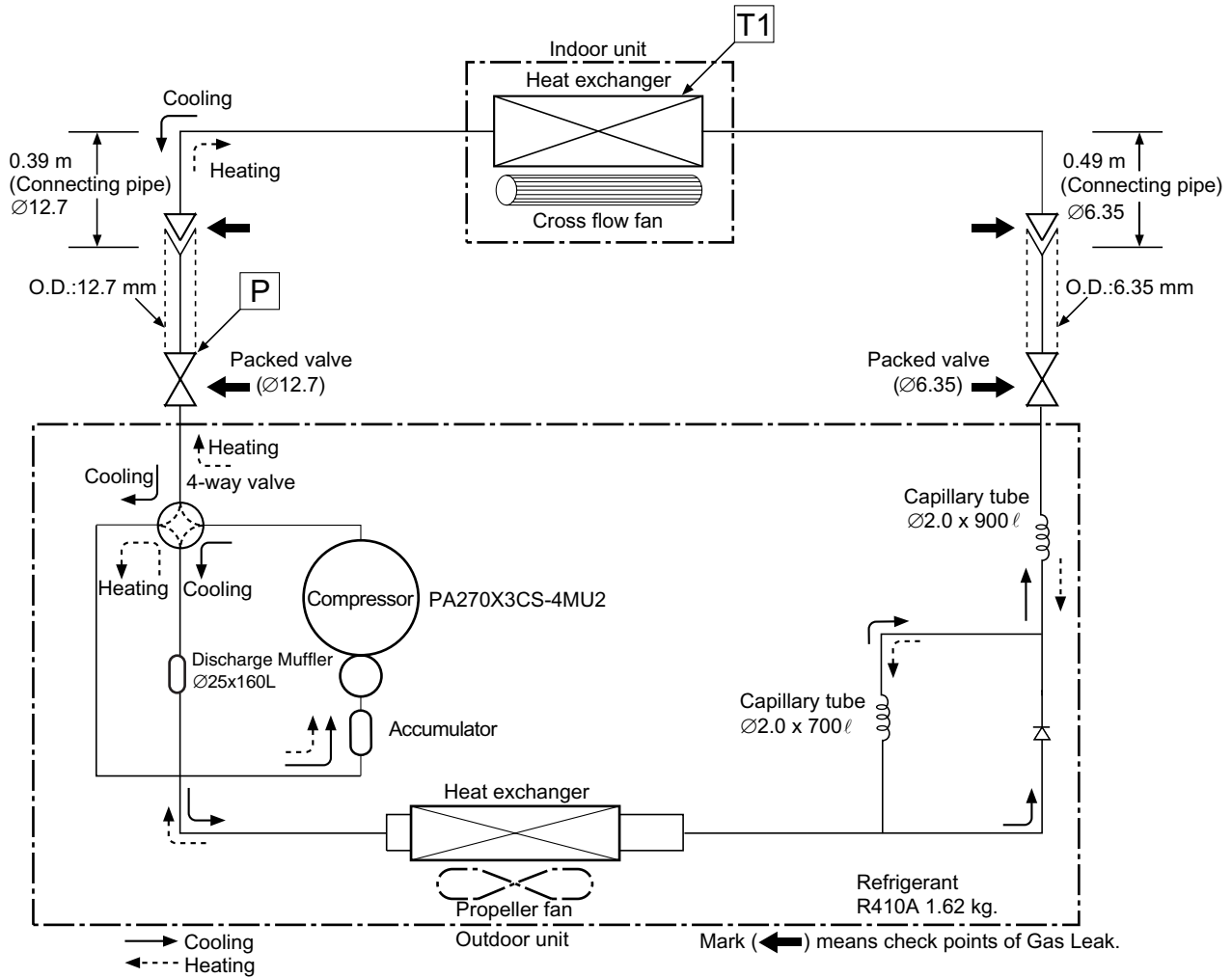

50Hz		Standard pressure P (MPaG)	Surface temp. of heat exchanger interchanging pipe T1 (°C)	Fan speed (indoor)	Ambient temp. conditions DB/WB (°C)	
					Indoor	Outdoor
Heating	Standard	2.86	45.6	High	20/15	7/6
	Overload*1	3.54 ~ 3.91	53.6 ~ 57.6	Low	27/-	24/18
	Low temperature	2.19	33.9	High	20/-	-10/-10
Cooling	Standard	0.84	10.0	High	27/19	35/24
	Overload	1.12	16.1	High	32/23	43/26
	Low temperature	0.74	2.3	Low	21/15	21/15

Note

• Measure the heat exchanger temperature at the center of U-bend. (By means of TC sensor)

*1 • During heating overload operation, a value for the high temperature limit control operation is included.

6. CONTROL BLOCK DIAGRAM

6.1 RAS-18SKP-ES / RAS-18S2A-ES, RAS-24SKP-ES / RAS-24S2A-ES

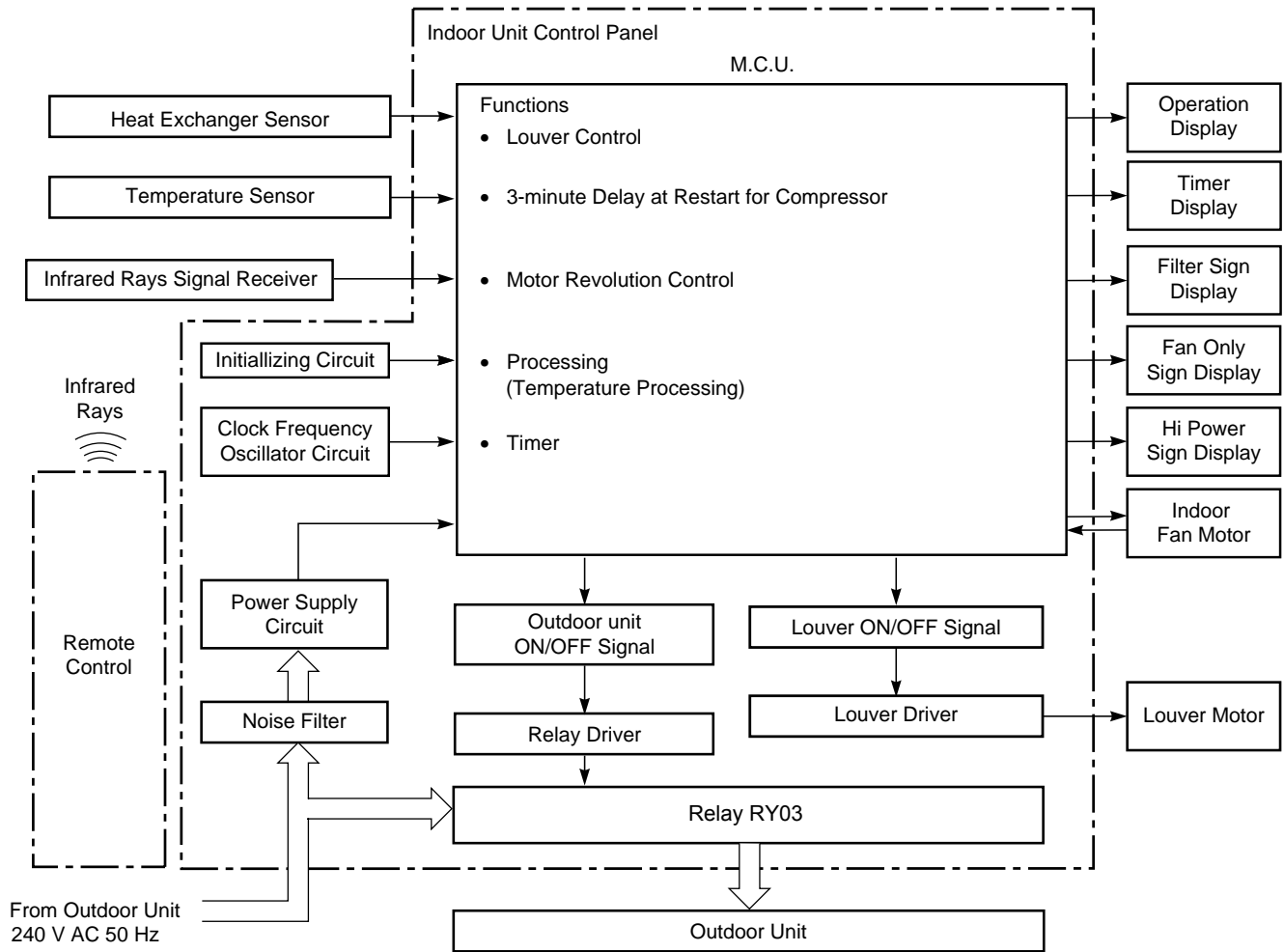

REMOTE CONTROL

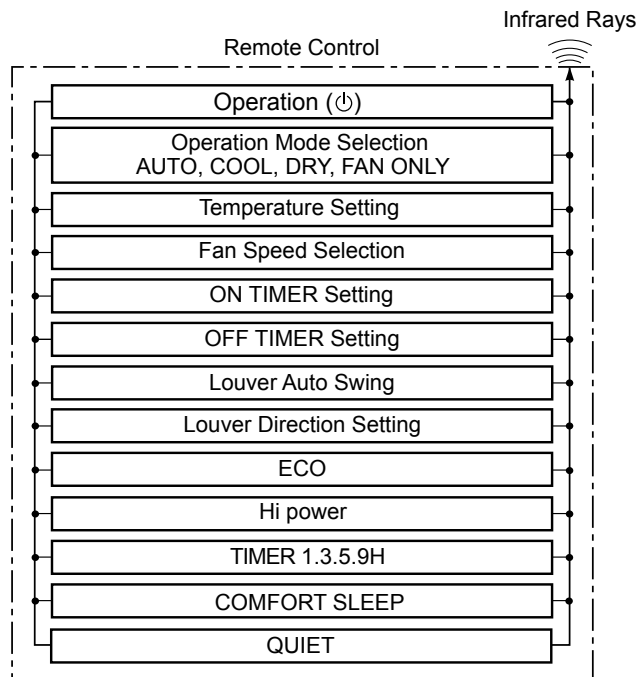

6.2 RAS-18SKHP-ES / RAS-18S2AH-ES, RAS-24SKHP-ES / RAS-24S2AH-ES

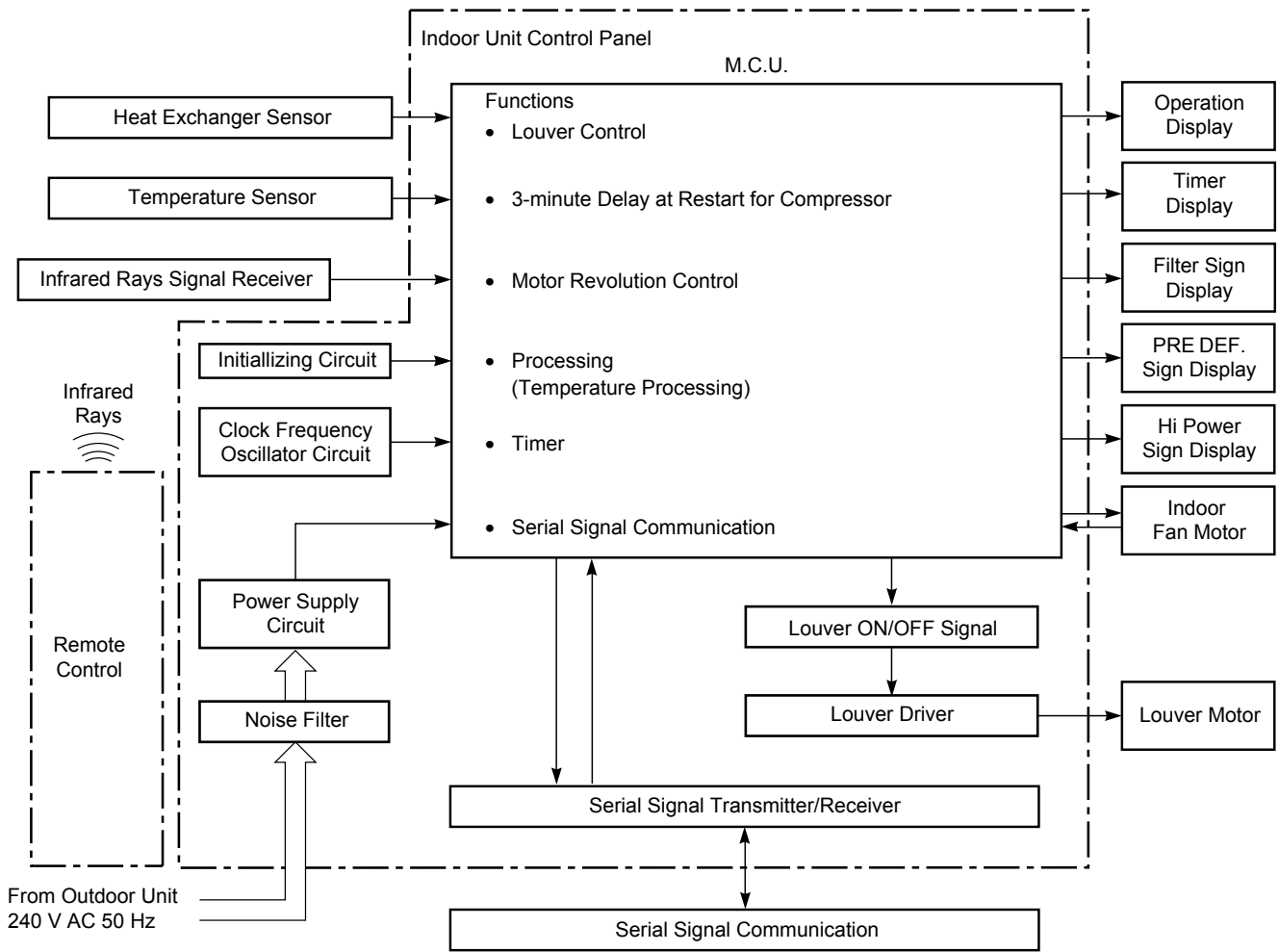

REMOTE CONTROL

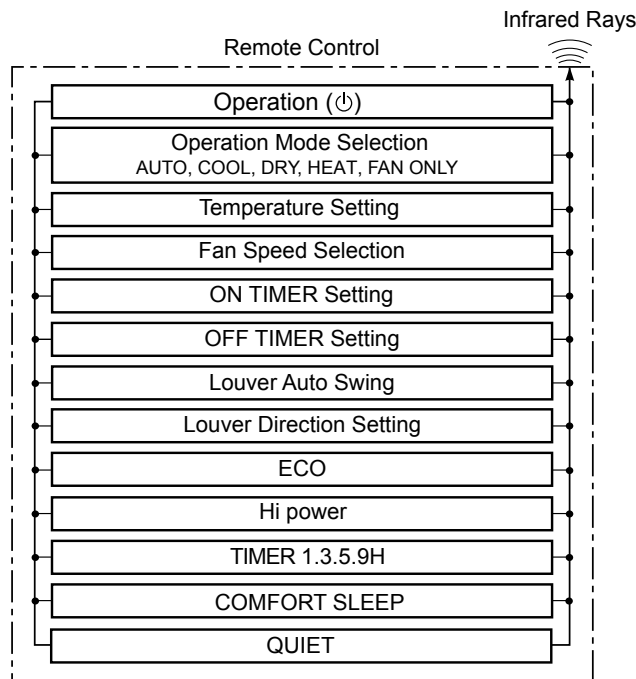

7. OPERATION DESCRIPTION

7-1. Remote control

7-1-1. Function of Push Button

- ① Infrared signal emitter
- ② Start/Stop button
- ③ Mode select button (MODE)
- ④ Temperature button (TEMP)
- ⑤ Fan speed button (FAN)
- ⑥ Swing louver button (SWING)
- ⑦ Set louver button (FIX)
- ⑧ On timer button (ON)
- ⑨ Off timer button (OFF)
- ⑩ Sleep timer button (SLEEP)
- ⑪ Timer setup button (SET)
- ⑫ Timer clear button (CLR)
- ⑬ Memory and Preset button (PRESET)
- ⑭ One Touch button (ONE-TOUCH)
- ⑮ High power button (Hi-POWER)
- ⑯ Economy button (ECO)
- ⑰ Quiet button (QUIET)
- ⑱ Comfort sleep button (COMFORT SLEEP)
- ⑲ Filter reset button (FILTER)
- ⑳ Clock Reset button (CLOCK)
- ㉑ Check button (CHK)

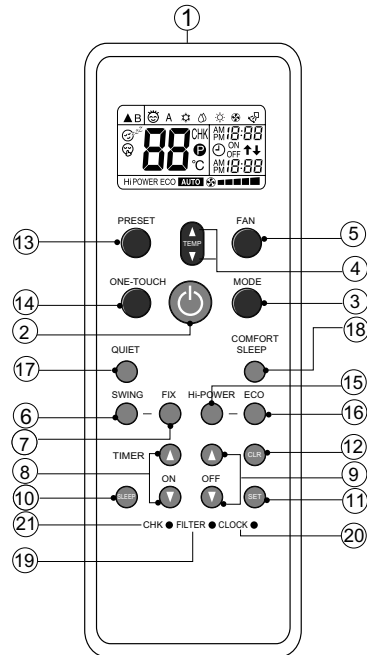





7-1-2. Display of Remote Control

All indications, except for the clock time indicator, are displayed by pressing the  button.

1. Transmission mark

This transmission mark ▲ indicates when the remote controller transmits signals to the indoor unit.







2. Mode indicator

Indicates the current operation mode.
(A : Auto,  : Cool,  : Dry,  : Heat,  : Fan only)

3. Temperature indicator

Indicates the temperature setting.
(17°C to 30°C)

4. FAN speed indicator

Indicates the selected fan speed.
AUTO or five fan speed levels
(LOW , LOW+ , MED , MED+ , HIGH ) can be shown.
Indicate Auto will be appear with Dry operation
( : Dry) only.

5. TIMER and clock time indicator

The time setting for timer operation or the clock time is indicated.
The current time is always indicated except during TIMER operation.

6. Hi-POWER indicator

Indicates when the Hi-POWER operation starts.
Press the Hi-POWER button to start and press it again to stop the operation.

7. (PRESET) indicator

Flashes for 3 seconds when the PRESET button is pressed during operation.
The  mark is shown when holding down the button for more than 3 seconds while the mark is blinks.
Press another button to turn off the mark.

8. ECO indicator

Indicates when the ECO is in activated.
Press the ECO button to start and press it again to stop operation.

9. A, B change indicator remote controller

When the remote controller switching function is set, "B" appears in the remote controller display.
(When the remote controller setting is "A", there is no indication at this position.)

10. Comfort sleep

Indicates when comfort sleep is activated.
Press comfort sleep button to selecter

11. Quiet

Indicates when quiet is activated.
Press quiet button to start and press it again to stop operation.

12. One-Touch

Indicates when one touch comfort is activated.
Press one-touch button to start the operation.

13. Swing

Indicates when louver is swing.
Press swing button to start the swing operation and press it again to stop the swing operation.

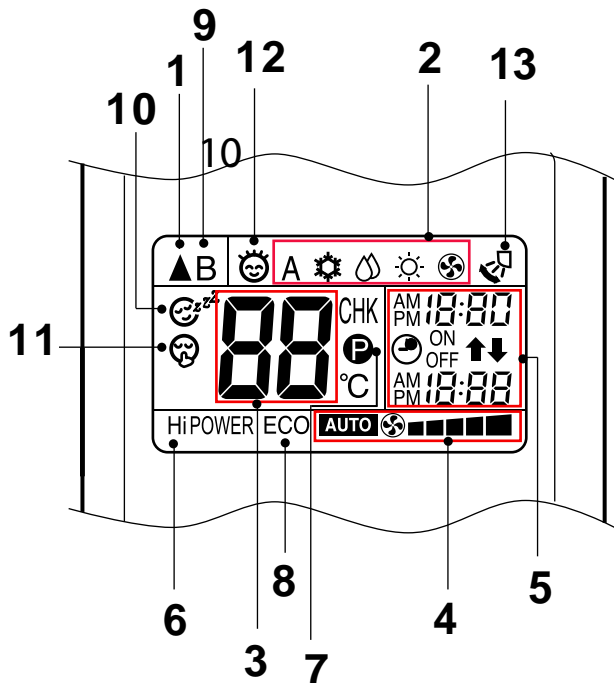

7-2. Outline of Air Conditioner Control

This is a fixed capacity type air conditioner, which uses a DC motor for an indoor fan. The DC motor drive circuit is mounted in the indoor unit. And electrical parts which operate the compressor and the outdoor fan motor, are mounted in the outdoor unit.

The air conditioner is mainly controlled by the indoor unit controller. The controller operates the indoor fan motor based upon commands transmitted by the remote control and transfers the operation commands to the outdoor unit.

The outdoor unit receives operation commands from the indoor unit, and operates the outdoor fan motor and the compressor.

(1) Role of indoor unit controller

The indoor unit controller receives the operation commands from the remote control and executes them.

- Temperature measurement at the air inlet of the indoor heat exchanger by the indoor temperature sensor
- Temperature measurement of the indoor heat exchanger by the heat exchanger sensor
- Louver motor control
- Indoor fan motor operation control
- LED display control
- Transferring of operation commands to the outdoor unit
- Receiving of information of the operation status and judging of the information or indication of error

(2) Role of outdoor unit controller

The outdoor unit controller receives the operation commands from the indoor controller and executes them.

- Compressor operation control
 - Operation control of outdoor fan motor
- } Operations according to the commands from the indoor unit

- Turning off the compressor and outdoor fan when the outdoor unit receives the shutdown command
- Defrost control in heating operation (Temperature measurement by the Indoor heat exchanger, control the four-way valve and outdoor fan motor control)

7-2-1. Louver control

(1) Vertical air flow louver

Position of vertical air flow louver is automatically controlled according to the operation mode.

Besides, position of vertical air flow louver can be arbitrarily set by pressing [FIX] button.

The louver position which is set by [FIX] button is stored in the microcomputer, and the louver is automatically set at the stored position for the next operation.

(2) Swing

If [SWING] button is pressed when the indoor unit is in operation, the vertical air flow louver starts swinging. When [SWING] button is pressed, it stops swinging.

7-2-2. Indoor Fan Control

The operation controls the fan speed at indoor unit side. The indoor fan (cross flow fan) is operated by the phase control induction motor. The fan rotates in 5 stages in MANUAL mode, and in 5 stages in AUTO mode, respectively. (Table 7-2-3)

- When setting the fan speed to L, L+, M, M+ or H on the remote controller, the operation is performed with the constant speed shown in Table 7-2-1 and Table 7-2-2

Table (7-2-1) Cooling











Indication	Fan speed
L 	Low
L+ 	(L + M) / 2
M 	Med
M+ 	(M + H) / 2
H 	High

Table (7-2-2) Heating

Indication	Fan speed
L 	Low
L+ 	(L + M) / 2
M 	Med
M+ 	(M + H) / 2
H 	High

- When setting the fan speed to AUTO on the remote controller, revolution of the fan motor is controlled to the fan speed level show in Table 7-2-3 according to the setup temperature, room temperature, and heat exchanger temperature.

Table 7-2-3 Indoor fan and air flow rate

OPERATION MODE		FAN TAP											
		Cooling		UH		H	M+	M	L+	L	L-	UL	SL
		Fan only	Dry	H	M+	M	L+	L	L-	UL	SL		
Model	RAS-18SKP-ES	rpm	1100		1050	980	900	850	750	650	550		
		Air flow volume (m ³ /h)	1000		950	880	800	800	650	550	450		
Model	RAS-24SKP-ES	rpm	1200		1125	1050	1000	950	850	700	600		
		Air flow volume (m ³ /h)	1100		1025	950	900	850	750	600	500		

OPERATION MODE		FAN TAP											
		Cooling		UH		H	M+	M	L+	L	L-	UL	SL
		Fan only	Dry	H	M+	M	L+	L	L-	UL	SL		
		Heat	UH	H	M+	M	L+	L	L-	UL	SL		
Model	RAS-18SKHP-ES	rpm	1100		1000	1000	940	870	850	850	750	640	550
		Air flow volume (m ³ /h)	1000		900	900	840	770	750	750	650	540	450
Model	RAS-24SKHP-ES	rpm	1200		1050	1050	1050	950	950	950	850	700	600
		Air flow volume (m ³ /h)	1100		950	950	950	850	850	850	750	600	500

7-3. Description of Operation Mode

- (1) When turning on the breaker, the operation lamp blinks. This means that the power is on (or the power supply is cut off.)
- (2) When pressing [⏻] button on the remote control, receiving beep sounds from the indoor unit, and the next operation is performed together with opening the vertical air flow louver.
- (3) Once the operation mode is set, it is memorized in the microcomputer so that the previous operation can be effected thereafter simply by pressing [⏻] button.

7-3-1. Fan only operation ([MODE] button on the remote control is set to the fan only operation.)

- (1) When [FAN] button is set to AUTO, the indoor fan motor operates as shown in Fig. 7-3-1. When [FAN] button is set to LOW, LOW*, MED, MED* or HIGH, the motor operates with a constant air flow.

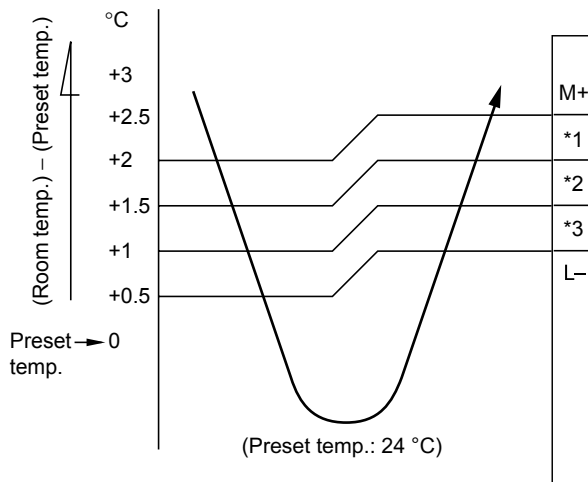

NOTE 1 : *1 : Fan speed = $(M + -L) \times 3/4 + L$
 *2 : Fan speed = $(M + -L) \times 2/4 + L$
 *3 : Fan speed = $(M + -L) \times 1/4 + L$

2 : The Hi Power, ECO and COMFORT SLEEP operation can not be set

(Linear approximation from M+ and L)

Fig. 7-3-1 Setting of air flow [FAN:AUTO]

7-3-2. Cooling operation ([MODE] button on the remote control is set to the cooling operation.)

- (1) The compressor, 4-way valve, (Heat pump model only) outdoor fan and operation display lamp are controlled as shown in Fig. 7-3-2.

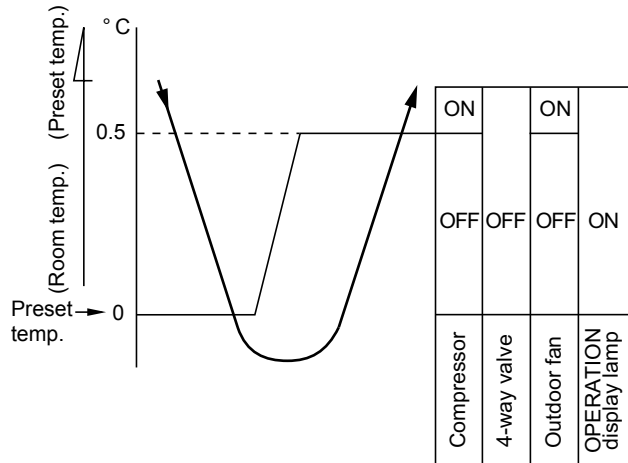
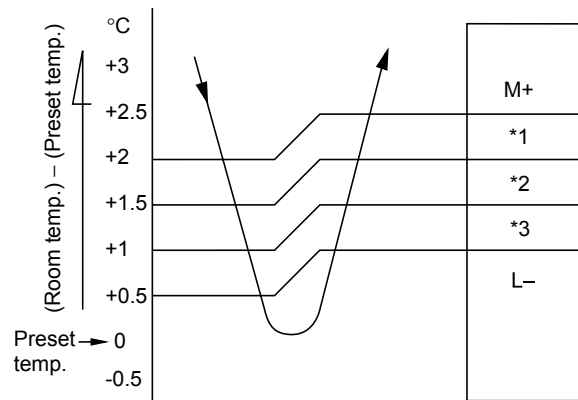

Fig. 7-3-2

- (2) When [FAN] button is set to AUTO, the indoor fan motor operates as shown in Fig. 7-3-3. When [FAN] button is set to LOW, LOW*, MED, MED* or HIGH, the motor operates with a constant air flow.



NOTE1 : *1 : Fan speed = $(M + -L) \times 3/4 + L$
 *2 : Fan speed = $(M + -L) \times 2/4 + L$
 *3 : Fan speed = $(M + -L) \times 1/4 + L$

(Linear approximation from M+ and L)

Fig. 7-3-3 Setting of air flow [FAN:AUTO]

7-3-3. Dry operation
 ([MODE] button on the remote control is set to the dry operation.)

- (1) The compressor, 4-way valve, (Heat pump model only) outdoor fan and operation display lamp are controlled as shown in Fig. 7-3-4.

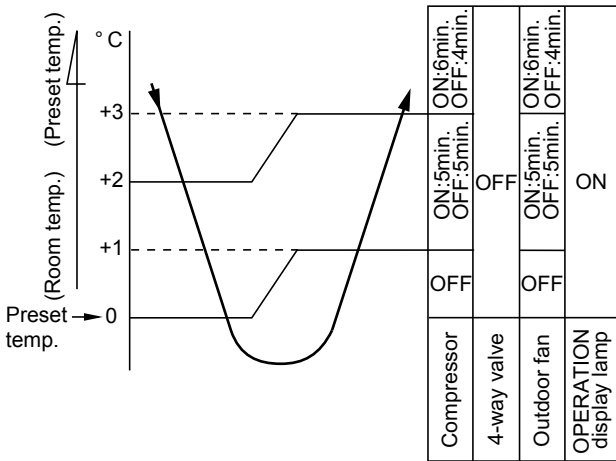

Fig. 7-3-4

7-3-4. Heating operation *Heat pump model only
 ([MODE] button on the remote control is set to the heating operation.)

- (1) The compressor, 4-way valve, outdoor fan and operation display lamp are controlled as shown in Fig. 7-3-6.

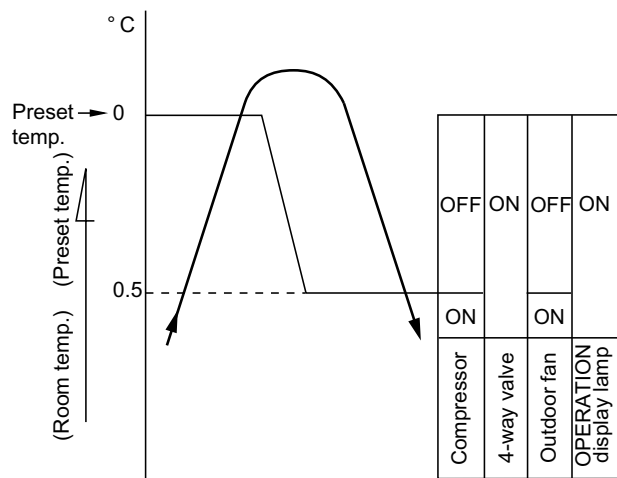

Fig. 7-3-6

- (2) The microprocessor turns the compressor on and off at the regular intervals (4 to 6 minutes). While the compressor is turning off, the indoor fan motor operates in the SUPER LOW position. The pattern of operation depending on the relation between room temperature and preset temperatures is shown in Fig. 7-3-5.

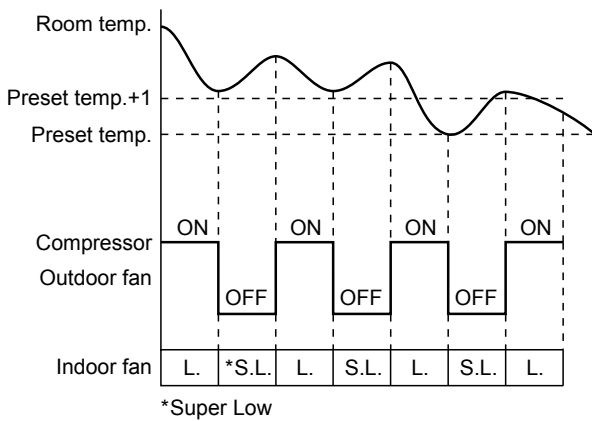
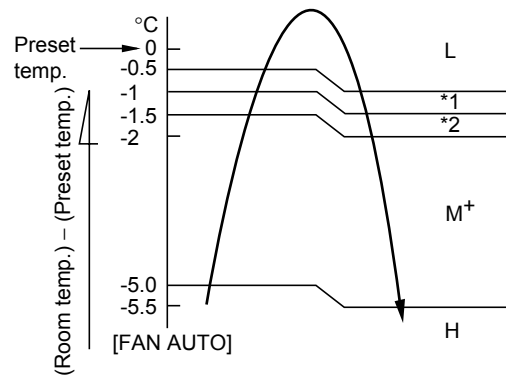

Fig. 7-3-5

- (2) When [FAN] button is set to AUTO, the indoor fan motor operates as shown in Fig. 7-3-7. When [FAN] button is set to LOW, LOW+, MED, MED+ or HIGH, the motor operates with a constant air flow.



*1 : Fan speed = (M + -L) x 1/4 + L

*2 : Fan speed = (M + -L) x 2/4 + L

*3 : Fan speed = (M + -L) x 3/4 + L

(Calculated with Linear approximation from M+ and L+)

Fig. 7-3-7

- (3) [FAN] button on the remote control is set to AUTO only.
 (4) The ECO, COMFORT SLEEP, QUIET and Hi POWER operations can not be set.

- (3) The indoor heat exchanger restricts revolving speed of the fan motor to prevent a cold draft. The upper limit of the revolving speed is shown in Fig. 7-3-8

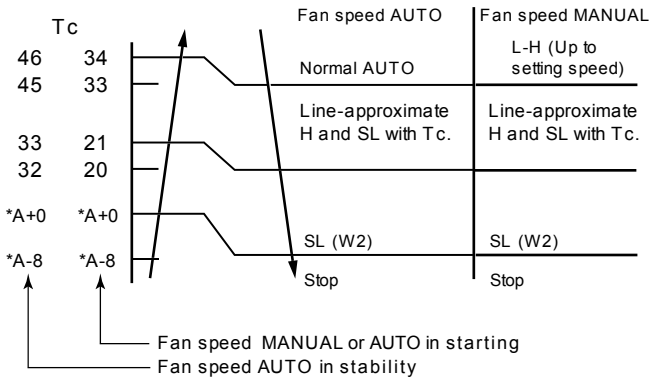

* No limitation while fan speed MANUAL mode is in stability.
 * A: When $T_{sc} \geq 24$, A is 24, and when $T_{sc} < 24$, A is T_{sc}
 T_{sc} : Set value

[In starting and in stability]

	In starting	In stability
FAN AUTO	<ul style="list-style-type: none"> Until 12 minutes passed after operation start When 12 to 25 minutes passed after operation start and room temp. is 3°C or lower than set temp. 	<ul style="list-style-type: none"> When 12 to 25 minutes passed after operation start and room temp. is than (set 3°C) between preset When 25 minutes or more passed after operation start
FAN Manual	<ul style="list-style-type: none"> Room temp. < Set temp. -4°C 	<ul style="list-style-type: none"> Room temp. \geq Set temp. -3.5°C

Fig. 7-3-8 Cold draft preventing control

7-3-5. Automatic operation

([MODE] button on the remote control is set to the automatic operation.)

- One of 3 operations (Cooling, Fan only or Heating) is selected according to difference between the preset temperature and the room temperature at which the automatic operation has started, as shown in Fig. 7-3-9. The Fan only operation continues until the room temperature reaches a level at which another mode is selected.
- Temporary Auto
 When the [RESET] button on the indoor unit is pushed, the preset temperature is fixed at 24°C and the indoor unit is controlled as shown in Fig. 7-3-9.

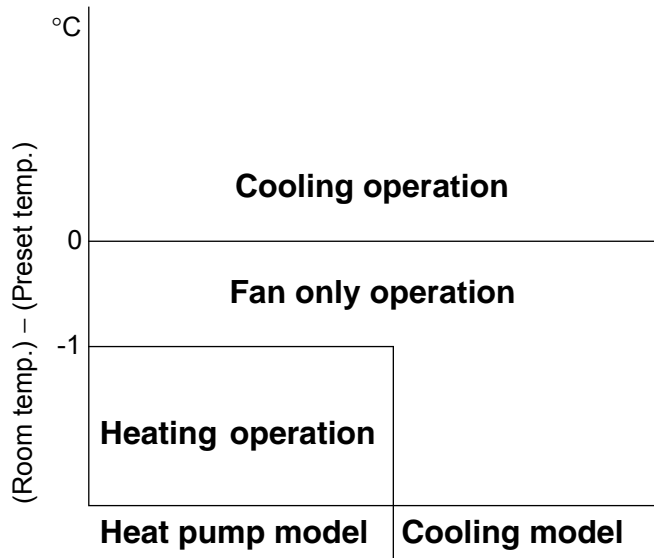

Fig. 7-3-9

- In order to prevent cold draft when compressor during heating operation. Then louver will move to upper position and fan speed will reduce or OFF.

7-4. Description of Safety and Reliability Prevention Function

7-4-1. Low-Temperature Limit Control

The microcontroller detects the indoor heat exchanger temperature to prevent the indoor heat exchanger from freezing.

The compressor and outdoor fan motor are controlled as shown in Fig. 7-4-1.

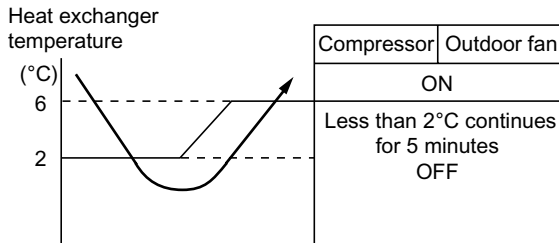

Fig. 7-4-1

7-4-2 High-Temperature Limit Control

*Heat pump model only

The microcontroller detects the indoor heat exchanger temperature to prevent pressure of a refrigerating cycle from increasing excessively.

The compressor and outdoor fan motor are controlled as shown in Fig. 7-4-2.

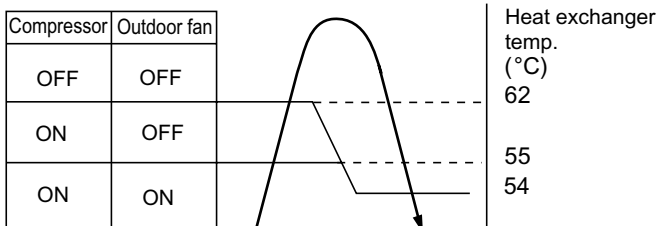

Fig. 7-4-2

7-4-3. Defrost Operation *Heat pump model only

When the indoor unit is in heating operation, if the refrigerant evaporation temperature detected by the outdoor heat exchanger sensor is under the specified temperature, the outdoor unit starts the defrosting operation. At this time, the 4-way valve relay and the outdoor fan motor are turned off. The indoor fan motor is also turned off by the cold draft preventing control of the indoor microcomputer. Then, [PRE. DEF.] lamp on the indoor unit comes on.

The defrosting operation stops and the 4-way valve relay, outdoor fan motor and the indoor fan motor are turned on automatically when the refrigerant evaporation increases to the specified temperature, or when the defrosting time is over 12 minutes.

7-4-3-1. Defrost starting condition

A-Zone : If $-10^{\circ}\text{C} > \text{Teo} \geq -18^{\circ}\text{C}$, defrost will start when.

$\text{Teo} - \text{Te} \geq 2.5^{\circ}\text{C}$ at least 20 sec or ~ 30 min after operation.

B-Zone : If $\text{Te} \leq -18^{\circ}\text{C}$, defrost start instantaneously (Suddenly) 00 ~ 25 min after operation

C-Zone : If $-2^{\circ}\text{C} \geq \text{Teo} \geq -10^{\circ}\text{C}$ defrost will start when $\text{Teo} - \text{Te} \leq -3^{\circ}\text{C}$ at least 20 sec or ~ 60 min after operation.

7-4-3-2. Defrost finish condition.

1) If $\text{Te} \geq 3^{\circ}\text{C}$ at least 60 sec --> 4 way valve on.

2) If $\text{Te} \geq 8^{\circ}\text{C}$ --> 4 way valve on.

Timing

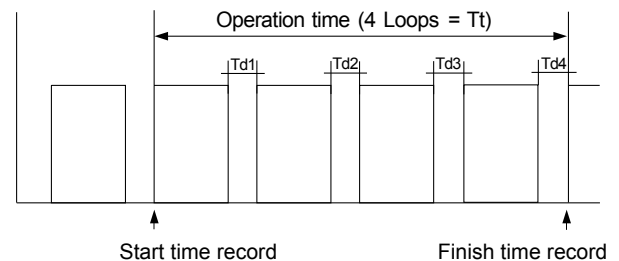

Defrost time rate : $(\text{Td}/\text{Tt}) \times 100$

Heating time rate : $(\text{Tt} - \text{Td}) \times \text{Tt}$

Fig. 7-4-3

7-5. One-Touch Operation

One touch comfort is the fully automated operation that is set according to the preferable condition in a region.

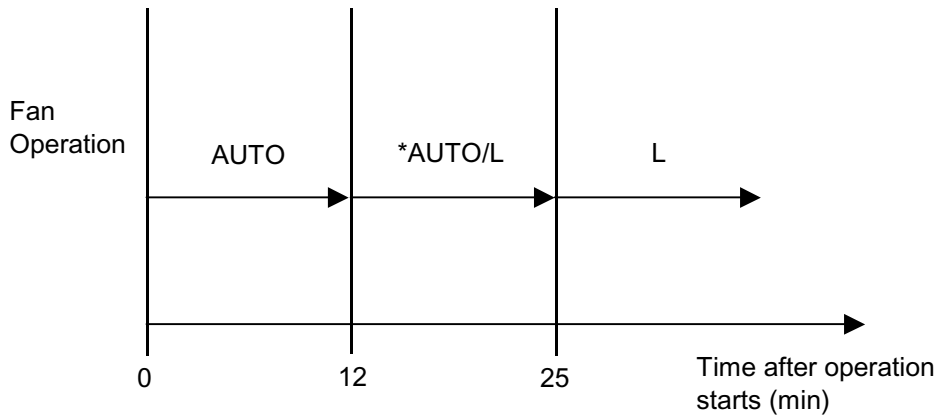

*AUTO/L : Fan operates depends on the setting temperature and room temperature.

During the One Touch Comfort mode if the indoor unit receives any signal with other operation mode, the unit will cancel the comfort mode and operates according to the signal received.

Operation description

When an indoor unit receives "One Touch Comfort Signal" from the remote controller, the indoor unit operates as following.

- 1) Air conditioner starts to operation when the signal is received, even if the air conditioner was OFF.
- 2) Operation mode is set according to room temperature, the same as AUTO mode.
- 3) Target temperature is 24°C.
- 4) Louver position is set as stored position.
- 5) Fan is controlled as diagram.

7-6. Hi POWER Operation ([Hi POWER] button on the remote control is pressed.)

When [Hi POWER] button is pressed while the indoor unit is in Auto, Cooling or Heating operation, Hi POWER mark is indicated on the display of the remote control and the unit operates as follows.

- (1) Automatic operation
 - The indoor unit operates in according to the current operation.
- (2) Cooling operation
 - The setting temperature drops 3°C.
(The value of the setting temperature on the remote control does not change.)
 - If the room temperature is higher than the setting temperature by 3.5°C or more, the horizontal louver moves to the Hi POWER position automatically. Then when the room temperature is 1°C less than the setting temperature the horizontal louver returns automatically.
 - FAN speed : [AUTO]
If the room temperature is higher than the setting temperature by 3.5°C or more, the air conditioner operates at maximum airflow level. If the room temperature is higher than the setting temperature by less than 3.5°C, the air conditioner operates at normal airflow level.
 - FAN speed : One of 5 levels
If the room temperature is higher than the setting temperature by 3.5°C or more, the air conditioner operates at higher consecutive airflow level. If the room temperature is higher than the setting temperature by less than 3.5°C, the air conditioner operates at normal airflow level.
 - The indoor unit's fan speed level increase 1 tap
- (3) Heating operation *Heat pump model only
 - The preset temperature increases 2°C,
(The value of the preset temperature on the remote control does not change.)
 - The indoor unit operates in normal heating mode except the preset temperature is higher (+2°C).
 - The indoor unit's fan speed level increase 1 tap
- (4) The Hi POWER mode can not be set in Dry or Fan only operation.
- (5) The Hi POWER mode can memorize with timer function.

7-7. QUIET Operation

When the [QUIET] button is pressed, the fan of the indoor unit will be restricted the revolving speed at speed L– until the [QUIET] button is pressed once again (cancel Quiet mode).

Quiet mode is the system which, control the revolving speed of indoor fan to work constantly at lower than speed L. In addition, noise level of indoor unit is less than usual.

Remarks :

1. Quiet mode is unable to work in dry mode.
2. Quiet mode is appropriate to work with less cooling load and less heating load condition. Because of the fan speed L– may cause not enough the cooling capacity or heating capacity.

7-8. ECO Operation.

Cooling operation

- The preset temperature will increase 1°C after the ECO mode has operated for 1 hour and the temperature will increase another 1°C after the ECO mode has operated for 2 hour. (the value of the preset temperature on the remote control does not change.)
- The indoor fan speed is depend on presetting and can change every speed after setting ECO operation.

Heating operation *Heat pump model only

- The preset temperature will drop down 1°C after the ECO mode has operated for 1 hour and the temperature will drop down another 1°C after the ECO mode has operated for 2 hour. (the value of the preset temperature on the remote control does not change.)
- The indoor fan speed is depend on presetting and can change every speed after setting ECO operation.

7-9. COMFORT SLEEP Operation

Cooling operation

- The preset temperature will increase 1°C after the comfort sleep mode has operated for 1 hour and the temperature will increase another 1°C after the comfort sleep mode has operated for 2 hour. (the value of the preset temperature on the remote control does not change)
- Press the [COMFORT SLEEP] button to select this function. The comfort sleep function will be activate together with Auto shut down function. Period of operation time can be select by re-press the [COMFORT SLEEP] button. The period of operation time are follows.



Heating mode *Heat pump model only

- The preset temperature will drop down 1°C after the comfort sleep mode has operated for 1 hour and the temperature will decrease another 1°C after the comfort sleep mode has operated for 2 hour. (The value of the preset temperature on the remote control does not change.)
- Press the [COMFORT SLEEP] button to select this function and period of operation time same as cooling mode operation.

The principles of comfort sleep mode are:

- Quietness for more comfortable. When room temperature reach setting temperature.
- Save energy by changing room temperature automatically.
- The air condition can shut down by itself automatically.

Remarks :

Comfort sleep mode will not operate in dry mode and fan only mode.

7-10. FILTER Check lamp

When the elapsed time reaches 1000 hours after air purifier operation, the FILTER indicator lights. After cleaning the filters, turn off the FILTER indicator.

How to Turn Off FILTER Indicator

Press [RESET] button on the indoor unit or press filter button on the remote control.

NOTE :

If [RESET] button is pushed while the FILTER indicator is not lit, the indoor unit will start the automatic operation.

When you want a temporary operation while the FILTER lamp lights, press [RESET] button to turn off the FILTER lamp.

7-11. Auto Restart Function

This indoor unit is equipped with an automatic restarting function which allows the unit to restart operating with the set operating conditions in the event of a power supply being accidentally shut down. The operation will resume without warning three minutes after power is restored.

This function is not set to work when shipped from the factory. Therefore it is necessary to set it to work.

7-11-1. How to Set the Auto Restart Function

To set the auto restart function, proceed as follows:

The power supply to the unit must be on ; the function will not set if the power is off.

Press the [RESET] button located in the center of the front panel continuously for three seconds.

The unit receives the signal and beeps three times.

The unit then restarts operating automatically in the event of power supply being accidentally shut down.

• When the unit is standby (Not operating)

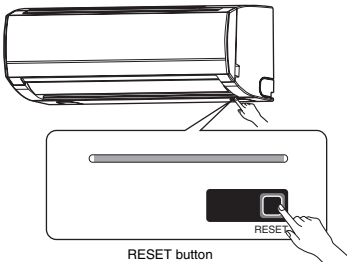
Operation	Motions
<p>Press [RESET] button for more than three seconds. (Less than 10 seconds)</p>  <p>RESET button</p>	<p>The unit is on standby.</p> <p>↓</p> <p>The unit starts to operate. The green indicator is on.</p> <p>↓ After approx. three seconds,</p> <p>The unit beeps three times and continues to operate. The green indicator blinks for 5 seconds.</p> <p>If the unit is not required to operate at this time, press [RESET] button once more or use the remote controller to turn it off.</p>

• When the unit is in operation

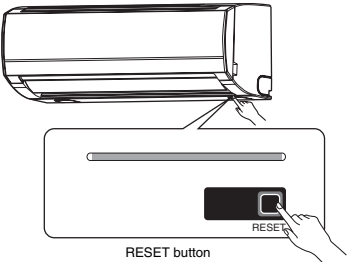
Operation	Motions
<p>Press [RESET] button for more than three seconds. (Less than 10 seconds)</p>  <p>RESET button</p>	<p>The unit is in operation. The green indicator is on.</p> <p>↓</p> <p>The unit stops operating. The green indicator is turned off.</p> <p>↓ After approx. three seconds,</p> <p>The unit beeps three times. The green indicator blinks for 5 seconds.</p> <p>If the unit is required to operate at this time, press [RESET] button once more or use the remote controller to turn it on.</p>

7-11-2. How to Cancel the Auto Restart Function

To cancel auto restart function, proceed as follows :

Repeat the setting procedure : the unit receives the signal and beeps three times.

The unit will be required to be turned on with the remote controller after the main power supply is turned off.

• When the system is on stand-by (not operating)

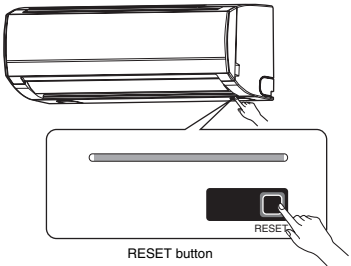
Operation	Motions
<p>Press [RESET] button for more than three seconds. (Less than 10 seconds)</p> 	<p>The unit is on standby.</p> <p style="text-align: center;">↓</p> <p>The unit starts to operate. The green indicator is on.</p> <p style="text-align: center;">↓ After approx. three seconds,</p> <p>The unit beeps three times and continues to operate.</p> <p>If the unit is not required to operate at this time, press [RESET] button once more or use the remote controller to turn it off.</p>

• When the system is operating

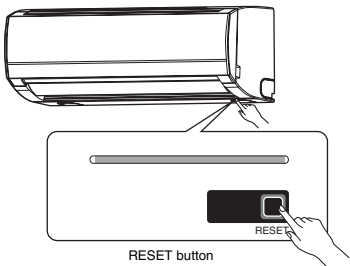
Operation	Motions
<p>Press [RESET] button for more than three seconds. (Less than 10 seconds)</p> 	<p>The unit is in operation. The green indicator is on.</p> <p style="text-align: center;">↓</p> <p>The unit stops operating. The green indicator is turned off.</p> <p style="text-align: center;">↓ After approx. three seconds,</p> <p>The unit beeps three times.</p> <p>If the unit is required to operate at this time, press [RESET] button once more or use the remote controller to turn it on.</p>

7-11-3. Power Failure During Timer Operation

When the unit is turned off because of power failure during timer operation, the timer operation is cancelled. In that case, set the timer operation again.

NOTE :

The Everyday Timer is reset while a command signal can be received from the remote controller even if it stopped due to a power failure.

7-12. Self-Cleaning Operation

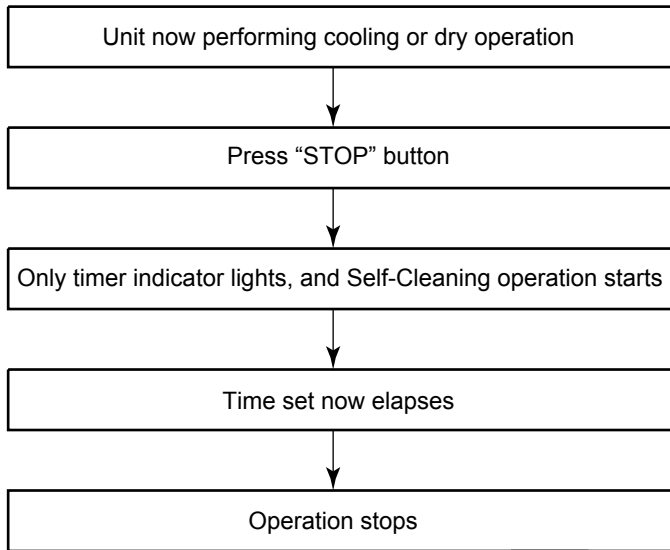

- During Self-Cleaning operations: The louver opens slightly. The indoor fan operates continuously at a speed of SL rpm.

Self-Cleaning operation times

	Operation time	Self-Cleaning operation time
Cooling: Auto (cooling) Dry	Up to 10 minutes	No Self-Cleaning operation performed (0 minutes)
	10 minutes or longer	20 mins.
Heating: Auto (heating)	No Self-Cleaning operation performed	
Auto (fan only)		
Shutdown		

- To stop an ongoing Self-Cleaning operation at any time
Press the start/stop button on the remote controller twice during the Self-Cleaning operation. [After pressing the button for the first time, press it for the second time without delay (within 10 minutes)].

1. Purpose

The Self-Cleaning operation is to minimize the growth of mold, bacteria etc. by running the fan and drying so as to keep the inside of the air conditioner clean.

Self-Cleaning operation

When the cooling or dry operation shuts down, the unit automatically starts the Self-Cleaning operation which is then performed for the specified period based on duration of the operation which was performed prior to the shutdown, after which the Self-Cleaning operation stops.

(The Self-Cleaning operation is not performed after a heating operation.)

2. Operation

- 1) When the stop signal from the remote controller or timer-off function is received, only the timer indicator light.
- 2) The period of the Self-Cleaning operation is determined by the duration of the operation performed prior to the reception of the stop code.
- 3) After the Self-Cleaning operation has been performed for the specified period, the unit stops operation.

7-12-1. Self-Cleaning diagram

Operation display	ON	OFF	OFF
FCU fan	ON rpm is depend on presetting.	ON (SL)	OFF
FCU louver	OPEN	OPEN (12.7°)	CLOSE
Timer display	ON or OFF depend on presetting of timer function.	ON	ON or OFF depend on presetting of timer function.
Compressor	ON or OFF depend on presetting per room temperature.	OFF	OFF
CDU fan	ON or OFF depend on presetting per room temperature.	OFF	OFF

Turn off by remote controller or timer-off function. Automatically turn-off.

7-12-2. Self-Cleaning function release

How to cancel Self-Cleaning function

To cancel the Self-Cleaning function, proceed as follows:

- Press [RESET] button one time or use remote control to turn on air conditioner. Display will show in green color.
- Hold down the [RESET] button for more than 20 seconds. (The air conditioner will stop suddenly when the [RESET] is pressed but keep holding it continue. The will beep 3 times in the first 3 seconds but it is not related to Self-Cleaning function)
- After holding about 20 seconds, the air conditioner will beep 5 times without any blinking of display.
- The Self-Cleaning Operation had been cancelled.

Remark

Presetting of Self-Cleaning function above, AUTO-RESTART function had been cancelled. To set AUTO-RESTART again.

How to set Self-Cleaning function

To set the Self-Cleaning function, proceed as follows.

- Press [RESET] button one time or use remote control to turn on air conditioner. Display will show in green color.
- Hold down the [RESET] button for more than 20 seconds. (The air conditioner will stop suddenly when the [RESET] is pressed but keep holding it continue. Then will beep 3 times in the first 3 seconds but it is not related to Self-Cleaning function)
- After holding about 20 seconds, the air conditioner will beep 5 times and OPERATION display blinks 5 times.
- The Self-Cleaning function had been set.

Remark

Presetting of Self-Cleaning function above, AUTO-RESTART function had been cancelled. To set AUTO-RESTART again.

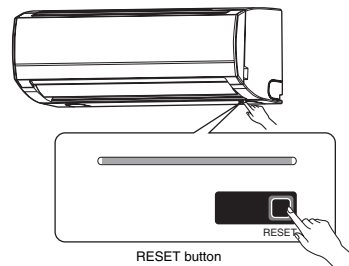

8. INSTALLATION PROCEDURE

8-1. Safety Cautions

For general public use

Power supply cord of Outdoor unit shall be more than 4 mm² (H07RN-F or 245 IEC66 : polychloroprene sheathed flexible cord) or 3.5 mm² (AWG-12).

CAUTION

To Disconnect the Appliance from the Main Power Supply.

This appliance must be connected to the main power supply by means of a circuit breaker or a switch with a contact separation of at least 3 mm.

If this is not possible, a power supply plug with earth must be used. This plug must be easily accessible after installation. The plug must be disconnected from the power supply socket in order to disconnect the appliance completely from the mains.

DANGER

- FOR USE BY QUALIFIED PERSONS ONLY.
- TURN OFF MAIN POWER SUPPLY BEFORE ATTEMPTING ANY ELECTRICAL WORK. MAKE SURE ALL POWER SWITCHES ARE OFF. FAILURE TO DO SO MAY CAUSE ELECTRIC SHOCK.
- CONNECT THE CONNECTING CABLE CORRECTLY. IF THE CONNECTING CABLE IS CONNECTED WRONGLY, ELECTRIC PARTS MAY BE DAMAGED.
- CHECK THE EARTH WIRE THAT IT IS NOT BROKEN OR DISCONNECTED BEFORE INSTALLATION.
- DO NOT INSTALL NEAR CONCENTRATIONS OF COMBUSTIBLE GAS OR GAS VAPORS. FAILURE TO FOLLOW THIS INSTRUCTION CAN RESULT IN FIRE OR EXPLOSION.
- TO PREVENT OVERHEATING THE INDOOR UNIT AND CAUSING A FIRE HAZARD, PLACE THE UNIT WELL AWAY (MORE THAN 2 M) FROM HEAT SOURCES SUCH AS RADIATORS, HEATERS, FURNACE, STOVES, ETC.
- WHEN MOVING THE AIR-CONDITIONER FOR INSTALLING IT IN ANOTHER PLACE AGAIN, BE VERY CAREFUL NOT TO GET THE SPECIFIED REFRIGERANT (R410a) WITH ANY OTHER GASEOUS BODY INTO THE REFRIGERATION CYCLE. IF AIR OR ANY OTHER GAS IS MIXED IN THE REFRIGERANT, THE GAS PRESSURE IN THE REFRIGERATION CYCLE BECOMES ABNORMALLY HIGH AND IT RESULTINGLY CAUSES BURST OF THE PIPE AND INJURIES ON PERSONS.
- IN THE EVENT THAT THE REFRIGERANT GAS LEAKS OUT OF THE PIPE DURING THE INSTALLATION WORK, IMMEDIATELY LET FRESH AIR INTO THE ROOM. IF THE REFRIGERANT GAS IS HEATED BY FIRE OR SOMETHING ELSE, IT CAUSES GENERATION OF POISONOUS GAS.

WARNING

- Never modify this unit by removing any of the safety guards or bypassing any of the safety interlock switches.
- Do not install in a place which cannot bear the weight of the unit.
Personal injury and property damage can result if the unit falls.
- Before doing the electrical work, attach an approved plug to the power supply cord.
Also, make sure the equipment is properly earthed.
- Appliance shall be installed in accordance with national wiring regulations.
If you detect any damage, do not install the unit. Contact your TOSHIBA dealer immediately.

CAUTION

- Exposure of unit to water or other moisture before installation could result in electric shock.
Do not store it in a wet basement or expose to rain or water.
- After unpacking the unit, examine it carefully for possible damage.
- Do not install in a place that can increase the vibration of the unit. Do not install in a place that can amplify the noise level of the unit or where noise and discharged air might disturb neighbors.
- To avoid personal injury, be careful when handling parts with sharp edges.
- Please read this installation manual carefully before installing the unit. It contains further important instructions for proper installation.

REQUIREMENT OF REPORT TO THE LOCAL POWER SUPPLIER

Please make absolutely sure that the installation of this appliance is reported to the local power supplier before installation. If you experience any problems, or if the installation is not accepted by the supplier, the service agency will take adequate countermeasures.

8-2. Installation Diagram of Indoor and Outdoor Units

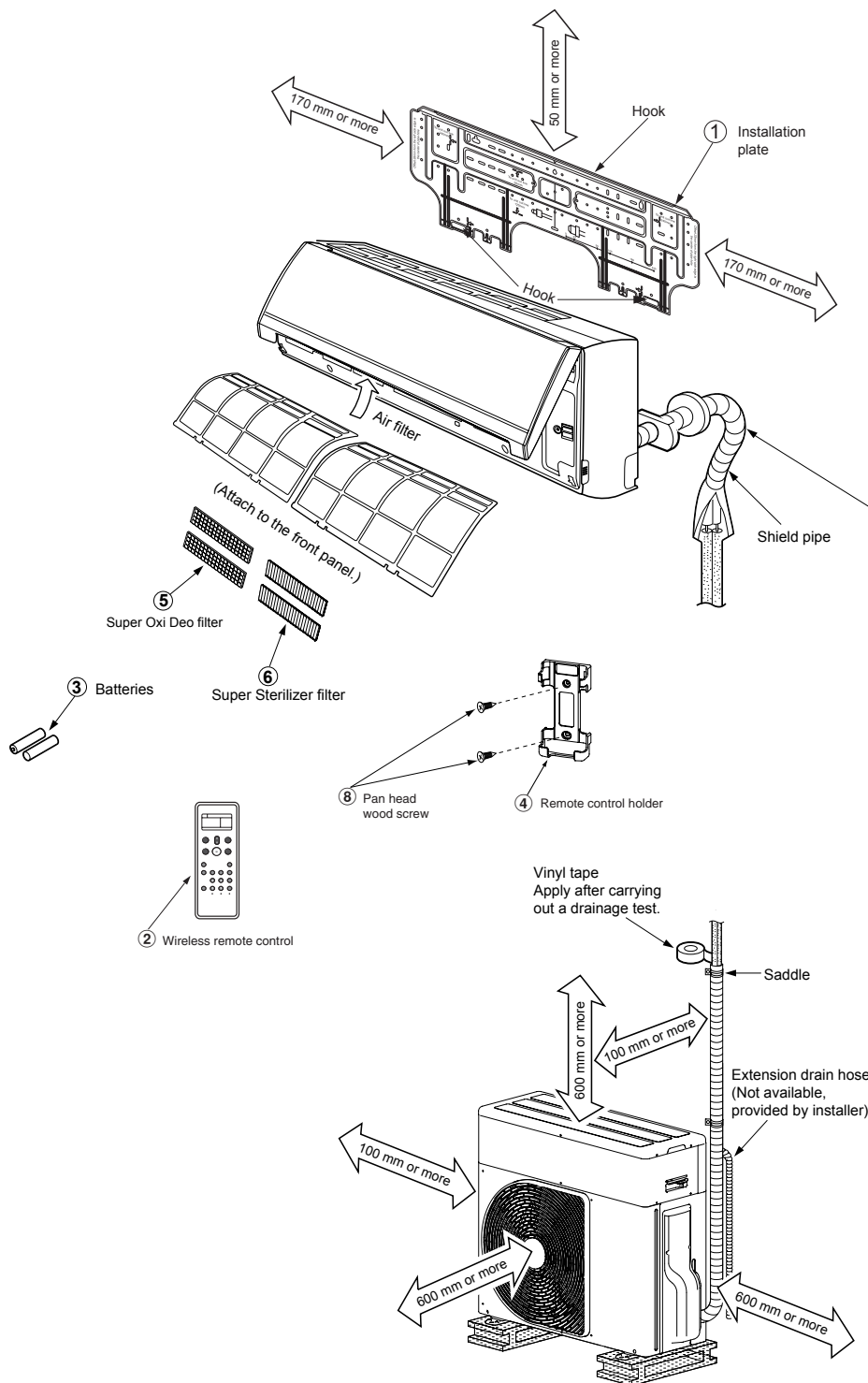

For the rear left and left piping

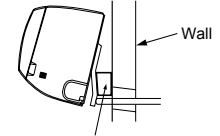

Insert the cushion between the indoor unit and wall, and tilt the indoor unit for better operation.

Do not allow the drain hose to get slack.

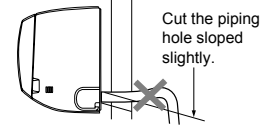

Make sure to run the drain hose sloped downward.

The auxiliary piping can be connected to the left, rear left, rear right, right, bottom right or bottom left.

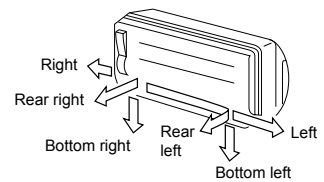

Insulate the refrigerant pipes separately with insulation, not together.

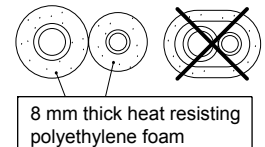

Before installing the wireless remote controller

- Loading Batteries
 1. Remove the battery cover.
 2. Insert 2 new batteries (AAA type) following the (+) and (-) positions.

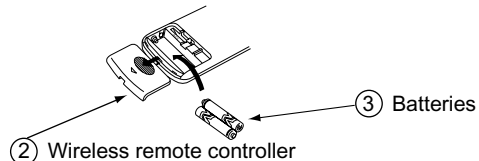

8-3. Installation

8-3-1. Optional installation parts

Part Code	Parts name	Q'ty
Ⓐ	Refrigerant piping Liquid side : $\varnothing 6.35$ mm Gas side : $\varnothing 12.7$ mm	One each
Ⓑ	Pipe insulating material (polyethylene foam, 8 mm thick)	1
Ⓒ	Putty, PVC tapes	One each

<Fixing bolt arrangement of outdoor unit>

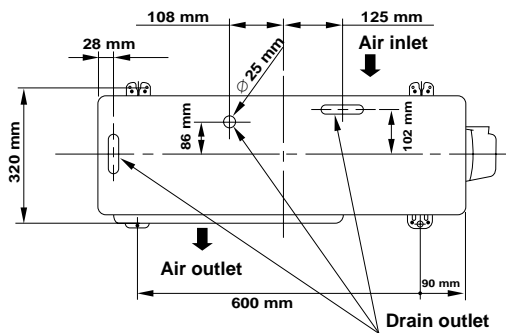

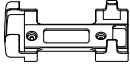

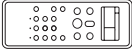



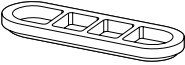



Fig. 8-3-1

- Secure the outdoor unit with fixing bolts and nuts if the unit is likely to be exposed to a strong wind.
- Use $\varnothing 8$ mm or $\varnothing 10$ mm anchor bolts and nuts.
- If it is necessary to drain the defrost water, attach drain nipple ⑪ and cap water proof ⑩ to the bottom plate of the outdoor unit before installing it.

8-3-2. Accessory and installation parts

Part No.	Part name (Q'ty)	Part No.	Part name (Q'ty)	Part No.	Part name (Q'ty)			
①	 Installation plate x 1	④	 Remote control holder x 1	⑧	 Pan head wood screw Ø3.1 x 16ℓ x 2			
②	 Wireless remote control x 1	⑤	 Super Oxi Deo filter x 2	⑨	 Screw Ø4 x 10ℓ x 2			
③	 Battery x 2	⑥	 Super Sterilizer filter x 2	⑩	 Cap water proof x 2			
Others	<table border="1"> <thead> <tr> <th>Name</th> </tr> </thead> <tbody> <tr> <td>Owner's manual</td> </tr> <tr> <td>Installation manual</td> </tr> </tbody> </table>	Name	Owner's manual	Installation manual	⑦	 Mounting screw Ø4 x 25ℓ x 6	⑪	 Drain nipple* x 1
	Name							
Owner's manual								
Installation manual								







The part marked with asterisk (*) is packaged with the outdoor unit.

3-3-3. Installation/Serviceing Tools**<Changes in the product and components>**

In the case of an air conditioner using R410A, in order to prevent any other refrigerant from being charged accidentally, the service port diameter of the outdoor unit control valve (3 way valve) has been changed.
(1/2 UNF 20 threads per inch)

- In order to increase the pressure resisting strength of the refrigerant piping, flare processing diameter and size of opposite side of flare nuts has been changed. (for copper pipes with nominal dimensions 1/2 and 5/8)

New tools for R410A

New tools for R410A	Applicable to R22 model		Changes
Gauge manifold	×		As pressure is high, it is impossible to measure by means of conventional gauge. In order to prevent any other refrigerant from being charged, each port diameter has been changed.
Charge hose	×		In order to increase pressure resisting strength, hose materials and port size have been changed (to 1/2 UNF 20 threads per inch). When purchasing a charge hose, be sure to confirm the port size.
Electronic balance for refrigerant charging	○		As pressure is high and gasification speed is fast, it is difficult to read the indicated value by means of charging cylinder, as air bubbles occur.
Torque wrench (nominal diam. 1/2, 5/8)	×		The size of opposite sides of flare nuts have been increased. Incidentally, a common wrench is used for nominal diameters 1/4 and 3/8.
Flare tool (clutch type)	○		By increasing the clamp bar's receiving hole, strength of spring in the tool has been improved.
Gauge for projection adjustment	—		Used when flare is made by using conventional flare tool.
Vacuum pump adapter	○		Connected to conventional vacuum pump. It is necessary to use an adapter to prevent vacuum pump oil from flowing back to the charge hose. The charge hose connecting part has two ports-one for conventional refrigerant (7/16 UNF 20 threads per inch) and one for R410A. If the vacuum pump oil (mineral) mixes with R410A a sludge may occur and damage the equipment.
Gas leakage detector	×		Exclusive for HFC refrigerant.

- Incidentally, the “refrigerant cylinder” comes with the refrigerant designation (R410A) and protector coating in the U. S's ARI specified rose color (ARI color code: PMS 507).
- Also, the “charge port and packing for refrigerant cylinder” require 1/2 UNF 20 threads per inch corresponding to the charge hose's port size.

8-4. Indoor Unit

8-4-1. Installation Place

- A place which provides enough spaces around the indoor unit as shown in the diagram.
- A place where there are no obstacle near the air inlet and outlet.
- A place which allows easy installation of the piping to the outdoor unit.
- A place which allows the front panel to be opened.
- The indoor unit shall be installed so that the top of the indoor unit is positioned at least 2m in height.
- Also, avoid putting anything on the top of the indoor unit.

CAUTION

- Direct sunlight on the indoor unit wireless receiver should be avoided.
- The microprocessor in the indoor unit should not be too close to r-f sources.
(For details, see the owner's manual.)

<Remote control>

- Should be placed where there are no obstacles, such as curtains, that may block the signal.
- Do not install the remote controller in a place exposed to direct sunlight or close to a heating source, such as a stove.
- Keep the remote controller at least 1 m away from the nearest TV set or stereo equipment.
(This is necessary to prevent image disturbances or noise interference.)
- The location of the remote controller should be determined as shown below.

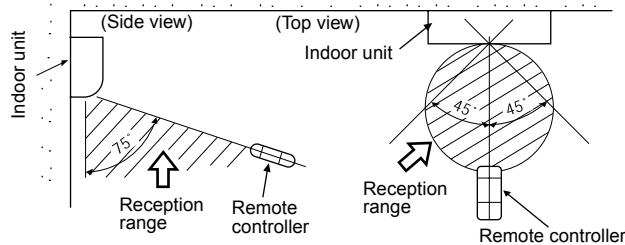

Fig. 8-4-1

8-4-2. Drilling a Hole and Mounting Installation Plate

<Drilling a hole>

When install the refrigerant pipes from the rear.

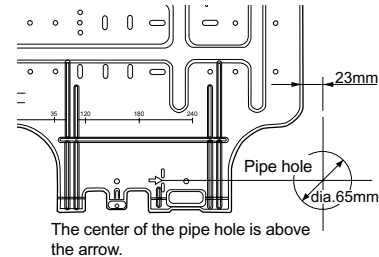

Fig. 8-4-2

1. After determining the pipe hole position on the installation plate (⇔) drill the pipe hole (Ø65 mm) at a slight downward slant to the outdoor side.

NOTE :

- When drilling into a wall that contains a metal lath, wire lath or metal plate, be sure to use a pipe hole brim ring sold separately.

<Mounting the installation plate>

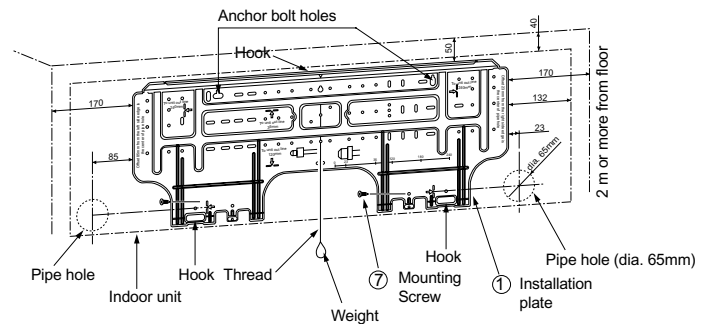

Fig. 8-4-3

<When the installation plate is directly mounted on the wall>

1. Securely fit the installation plate onto the wall by screws with the upper and lower catches, that hold the indoor unit, facing out.
2. To mount the installation plate on a concrete wall use anchor bolts. Drill the anchor bolt holes as illustrated in the above figure.
3. Install the installation plate horizontally and level.

CAUTION

When installing the installation plate with mounting screw, do not use the anchor bolt hole. Otherwise the unit may fall down and result in personal injury and property damage.

Installation plate
<Keep horizontal direction>

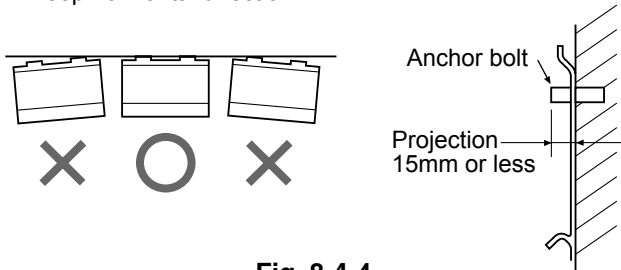

Fig. 8-4-4

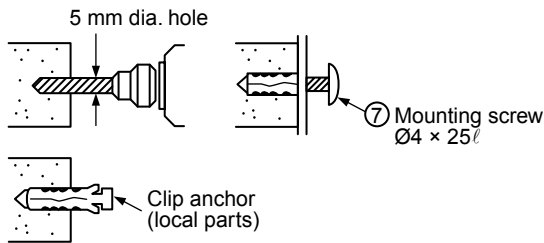

Fig. 8-4-5

CAUTION

Failure to securely install the unit may result in personal injury and/or property damage if the unit falls.

- In case of block, brick, concrete or similar type walls, drill 5 mm dia. holes in the wall.
- Insert clip anchors for the ⑦ mounting screws.

NOTE :

- Install the installation plate using mounting screws between 4 to 6, being sure to secure all four corners.

8-4-3. Electrical Work

1. The supply voltage must be the same as the rated voltage of the air conditioner.
2. Prepare a power source for the exclusive use of the air conditioner.

NOTE :

- Wire type :
More than 1.5 mm² H07RN-F or 60245IEC66.

CAUTION

- This appliance can be connected to a main circuit breaker in either of the following two ways.
 1. Connection to fixed wiring:
A switch or circuit breaker which disconnects all poles and has a contact separation of at least 3 mm must be incorporated in the fixed wiring. An approved circuit breaker or switch must be used.
 2. Connection with power supply plug:
Attach power supply plug with power cord and plug it into wall outlet. An approved power supply cord and plug must be used.

NOTE :

- Perform wiring work being sure the wire length is long enough.

8-4-4. Wiring Connection

<How to connect the connecting cable>

Wiring the connecting cable can be carried out without removing the front panel.

1. Remove the air inlet grille. Open the air inlet grille upward and pull it toward you.
2. Remove the terminal cover and cord clamp.
3. Insert the connecting cable (or as according to local regulations/codes) into the pipe hole on the wall.
4. Pull the connecting cable through the cable slot on the rear panel so that it protrudes about 15 cm out of the front.
5. Insert the connecting cable fully into the terminal block and secure it tightly with screws.
6. Tightening torque: 1.2 N•m (0.12 kgf•m)
7. Secure the connecting cable with the cord clamp.
8. Attach the terminal cover, rear plate bushing and air inlet grille on the indoor unit.

CAUTION

- Be sure to refer to the wiring system diagram labeled inside the front panel.
- Check local electrical regulations for any specific wiring instructions or limitations.

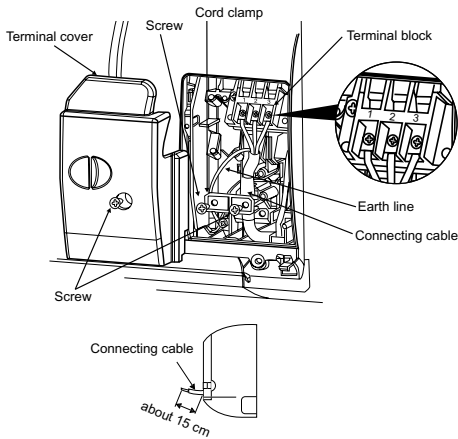
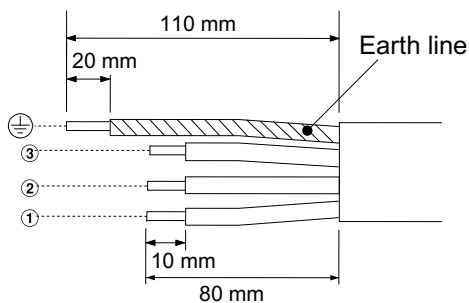

Fig. 8-4-6



Stripping length of the connecting cable

Fig. 8-4-7

NOTE :

- Use stranded wire only.
- Wire type : H07RN-F or more

8-4-5. Piping and Drain Hose Installation

<Piping and drain hose forming>

- Since condensation results in machine trouble, make sure to insulate both the connecting pipes separately. (Use polyethylene foam as insulating material.)

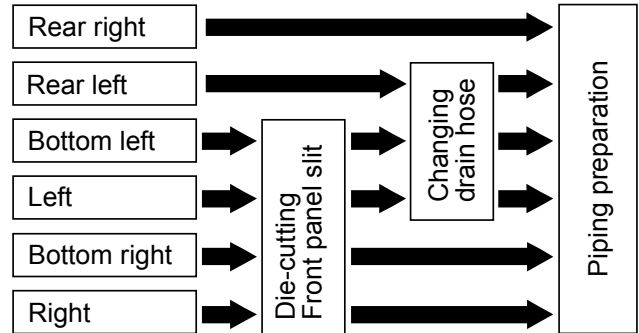

Fig. 8-4-8

1. Die-cutting front panel slit

Cut out the slit on the left or right side of the front panel for the left or right connection and the slit on the bottom left or side of the front panel for the bottom left or right connection with a pair of nippers.

2. Changing drain hose

For left connection, left-bottom connection and rear-left connection's piping, it is necessary to relocate the drain hose and drain cap.

<How to remove the drain cap>

Clip drain cap with needle-nose pliers, and pull out.

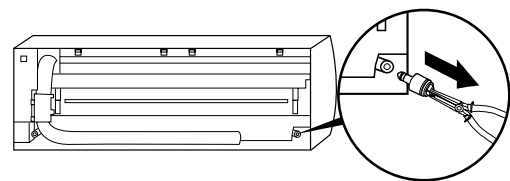

Fig. 8-4-9

<How to remove the drain hose>

The drain hose is secured in place by a screw. Remove the screw securing the drain hose, then pull out the drain hose.

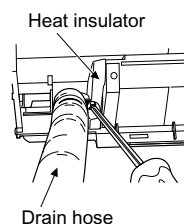

Fig. 8-4-10

<How to attach the drain cap>

1. Insert hexagonal wrench (4 mm).

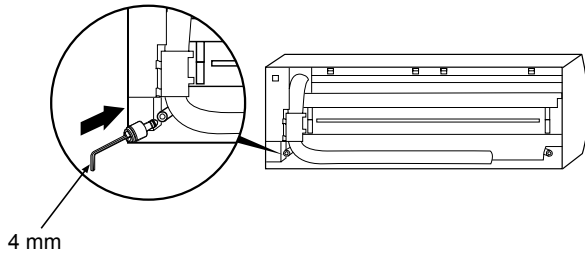

Fig. 8-4-11

2. Firmly insert drain cap.

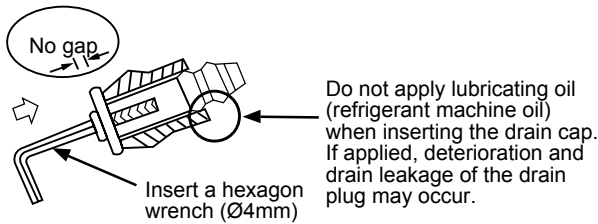

Fig. 8-4-12

<How to attach the drain hose>

Always use the original screw that secured the drain hose to the unit. If using a different screw may cause water to leak.

Insert the drain hose firmly until the connector contacts with the insulation, then secure it in place using the original screw.

CAUTION

Securely insert the drain hose and drain cap; otherwise, water may leak.

<In case of right or left piping>

- After making slits on the front panel with a knife or similar tool, cut them out with a pair of nippers or an equivalent tool.

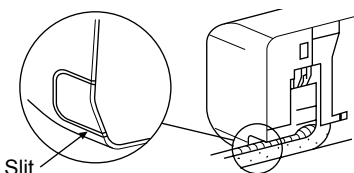

Fig. 8-4-13

<In case of bottom right or bottom left piping>

- After making slits on the front panel with a knife or similar tool, cut them out with a pair of nippers or an equivalent tool.

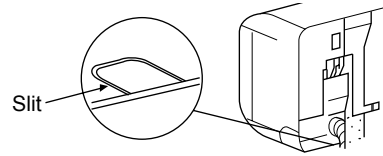

Fig. 8-4-14

<Left-hand connection with piping>

Bend the connecting pipes so that they are positioned within 43 mm above the wall surface.

If the connecting pipes are positioned more than 43 mm above the wall surface, the indoor unit may be unstable.

When bending the connecting pipe, make sure to use a spring bender to avoid crushing the pipe.

Refer to the table below for the bending radius of each connection pipe.

Outer diameter	Bending radius
6.35 mm	30 mm
12.7 mm	50 mm

To connect the pipe after installation of the unit (figure)

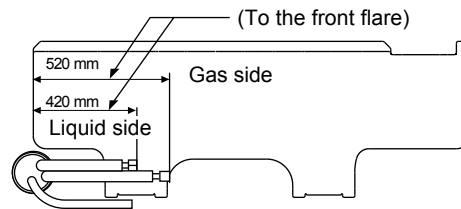

R30 or less (Ø6.35), R50 or less (Ø12.7)
Use polishing (polyethylene core or the like for bending pipe).

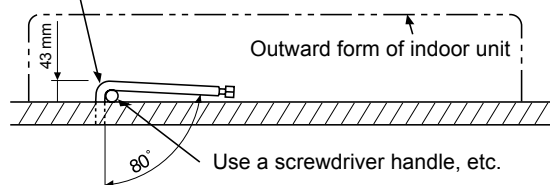

Fig. 8-4-15

NOTE :

If the pipe is incorrectly bent, the indoor unit may be unstable on the wall.

After passing the connecting pipe through the pipe hole, connect the connecting pipe to the auxiliary pipes and wrap the facing tape around them.

CAUTION

- Bind the auxiliary pipes (two) and connecting cable with facing tape tightly.
In case of leftward piping and rear-leftward piping, bind the auxiliary pipes (two) only with facing tape.

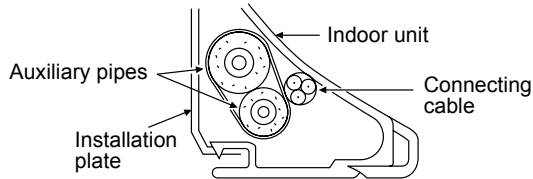

Fig. 8-4-16

- Carefully arrange the pipes so that none of the pipes stick out of the rear plate of the indoor unit.
- Carefully connect the auxiliary pipes and connecting pipes to each other and cut off the insulating tape wound on the connecting pipe to avoid double-taping at the joint, moreover, seal the joint with the vinyl tape, etc.
- Since condensation can result in machine performance trouble, be sure to insulate both connecting pipes. (Use polyethylene foam as insulating material.)
- When bending a pipe, be careful not to crush it.

8-4-6. Indoor Unit Installation

1. Pass the pipe through the hole in the wall, and hook the indoor unit on the installation plate at the upper hooks.
2. Swing the indoor unit to right and left to confirm that it is firmly hooked on the installation plate.
3. While pressing the indoor unit onto the wall, hook it at the lower part on the installation plate. Pull the indoor unit toward you to confirm that it is firmly hooked on the installation plate.

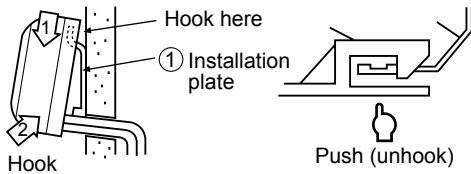

Fig. 8-4-17

- For detaching the indoor unit from the installation plate pull the indoor unit toward you while pushing the bottom up at the specified places.

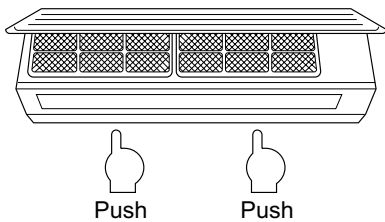

Fig. 8-4-18

Information

The lower part of indoor unit may float, due to the condition of piping and you cannot fix it to the installation plate. In that case, use the ⑨ screws provided to fix the unit and the installation plate.

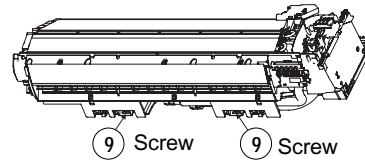

Fig. 8-4-19

8-4-7. Drainage

1. Run the drain hose at a downward sloped angle.

NOTE :

- Hole should be made at a slight downward slant on the outdoor side.

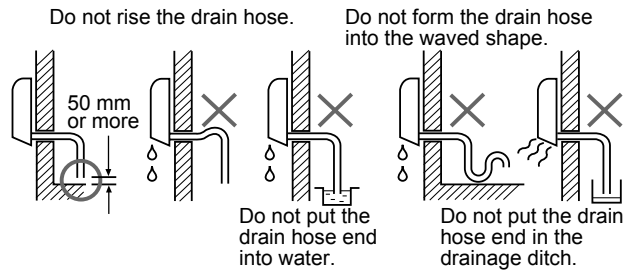

Fig. 8-4-20

2. Put water in the drain pan and make sure that the water is being drained outside.
3. When connecting extension drain hose, insulate the connection part of extension drain hose with shield pipe.

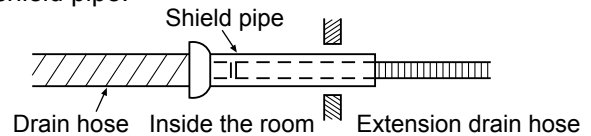
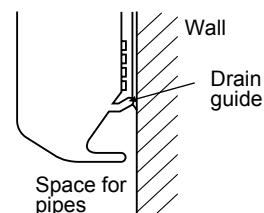

Fig. 8-4-21

CAUTION

Install the drain pipe for proper drainage. Improper drainage can result in water dripping inside the room.

This air conditioner has been designed to drain water collected from condensation which forms on the back of the indoor unit, to the drain pan. Therefore, do not locate the power cord and other parts at a high place than the drain guide.



8-5. Outdoor Unit

8-5-1. Installation place

- A place which provides the spaces around the outdoor unit as shown in the installation diagram of indoor and outdoor unit.
- A place which can bear the weight of the outdoor unit and does not allow an increase in noise level and vibration.
- A place where the operation noise and discharged air do not disturb your neighbors.
- A place which is not exposed to a strong wind.
- A place free of a leakage of combustible gases.
- A place which does not block a passage.
- When the outdoor unit is to be installed in an elevated position, be sure to secure its feet.
- An allowable length of the connecting pipe is up to 15 m. (Refer to the table of TO CHARGE REFRIGERANT for detail.)
- An allowable height level is up to 8 m.
- A place where the drain water does not raise any problem.

CAUTION

1. Install the outdoor unit without anything blocking the air discharging.
2. When the outdoor unit is installed in a place exposed always exposed to strong wind like a coast or on a high storey of a building, secure the normal fan operation using a duct or a wind shield.
3. In particularly windy areas, install the unit such as to avoid admission of wind.
4. Installation in the following places may result in trouble.

Do not install the unit in such places.

- A place full of machine oil.
- A saline-place such as the coast.
- A place full of sulfide gas.
- A place where high-frequency waves are likely to be generated as from audio equipment, welders, and medical equipment.

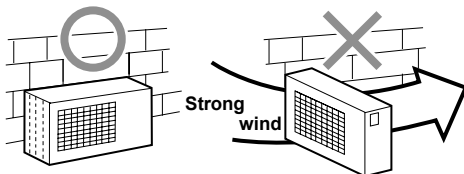

Fig. 8-5-1

8-5-2. Refrigerant piping connection

1. Cut the pipe with a pipe cutter.

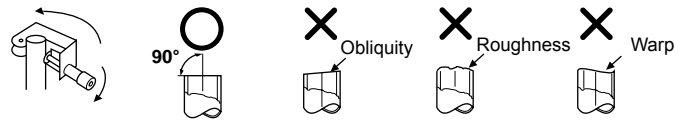

Fig. 8-5-2

2. Insert a flare nut into the pipe, and flare the pipe.

- **Projection margin in flaring : A (Unit : mm)**

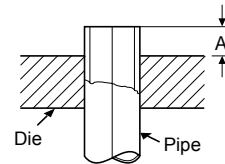

Fig. 8-5-3

Rigid (Clutch type)

Outer dia. of copper pipe	R410A tool used	Conventional tool used
6.35	0 to 0.5	1.0 to 1.5
12.70	0 to 0.5	1.0 to 1.5

Imperial (wing nut type, conventional tool)

Outer dia. of copper pipe	R410A
6.35	1.5 to 2.0
12.70	2.0 to 2.5

<Tightening connection>

Align the centers of the connecting pipes and tighten the flare nut as far as possible with your fingers. Then tighten the nut with a spanner and torque wrench as shown in the figure.

CAUTION

- Do not apply excess torque.
- Otherwise, the nut may crack depending on the conditions.

(Unit : N·m)

Outer dia. of copper pipe	Tightening torque
∅6.35 mm	16 to 18 (1.6 to 1.8 kgf·m)
∅12.70 mm	50 to 62 (5.0 to 6.2 kgf·m)

• Tightening torque of flare pipe connections

The operating pressure of R410A is higher than that of R22. (Approx. 1.6 times). It is therefore necessary to firmly tighten the flare pipe connecting sections (which connect the indoor and outdoor units) up to the specified tightening torque. Incorrect connections may cause not only a gas leakage, but also damage to the refrigerant cycle.

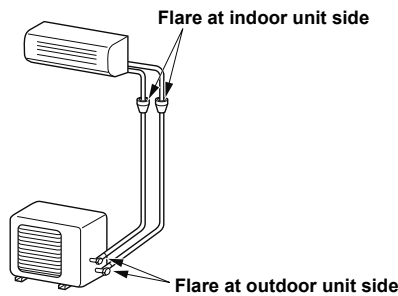

Fig. 8-5-4

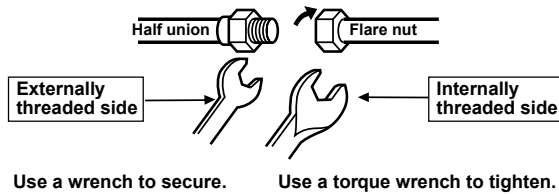

Fig. 8-5-5

CAUTION

• KEEP IMPORTANT 5 POINTS FOR PIPING WORK

- (1) Take away dust and moisture (Inside of the connecting pipes.)
- (2) Tight connection (between pipes and unit)
- (3) Evacuate the air in the connecting pipes using VACUUM PUMP.
- (4) Check gas leak (connected points)
- (5) Be save to fully open the packed valves before operation.

8-5-3. Evacuating

After the piping has been connected to the indoor unit, you can perform the air purge together at once.

AIR PURGE

Evacuate the air in the connecting pipes and in the indoor unit using a vacuum pump. Do not use the refrigerant in the outdoor unit. For details, see the manual of the vacuum pump.

<Using a vacuum pump>

Be sure to use a vacuum pump with counter-flow prevention function so that inside oil of the pump does not flow backward into pipes of the air conditioner when the pump stops. (If oil inside of the vacuum pump enters into the air conditioner, which use R410A, refrigeration cycle trouble may result.)

1. Connect the charge hose from the manifold valve to the service port of the gas side packed valve.
2. Connect the charge hose to the port of the vacuum pump.
3. Open fully the low pressure side handle of the gauge manifold valve.
4. Operate the vacuum pump to start evacuating. Perform evacuating for about 15 minutes if the piping length is 20 meters. (15 minutes for 20 meters) (assuming a pump capacity of 27 liters per minute. Then confirm that the compound pressure gauge reading is -101 kPa (-76 cmHg).
5. Close the low pressure side valve handle of gauge manifold.
6. Open fully the valve stem of the packed valves (both side of Gas and Liquid).
7. Remove the charging hose from the service port.
8. Securely tighten the caps on the packed valves.

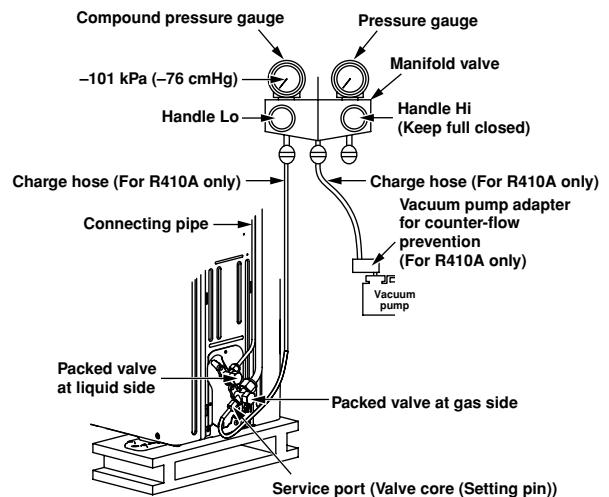

Fig. 8-5-6

TO CHARGE REFRIGERANT		
Refrigerant	24 class	18 class
No need to charge extra refrigerant	15 m or less	15 m or less
Need to charge extra refrigerant	Over 15 m up to 25 m (20 g/m)	Over 15 m up to 20 m (20 g/m)

<Packed valve handling precautions>

- Open the valve stem all the way out; but do not try to open it beyond the stopper.
- Securely tighten the valve stem cap with torque in the following table:

Gas side	Tightening torque	A
Gas side (Ø12.70 mm)	60 to 62 N·m (6.0 to 6.2 kgf·m)	4 mm
Liquid side (Ø6.35 mm)	16 to 18 N·m (1.6 to 1.8 kgf·m)	Same as Gas side
Service port	9 to 10 N·m (0.9 to 1.0 kgf·m)	

- Hexagonal wrench : A (Unit : mm)

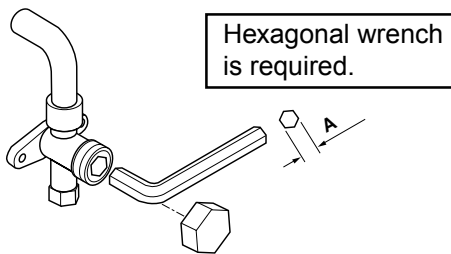

Fig. 8-5-7

8-5-4. Wiring connection

1. Remove the valve cover from the outdoor unit.
2. Connect the connecting cable to the terminal as identified with their respective matched numbers on the terminal block of indoor and outdoor unit.
3. When connecting the connecting cable to the outdoor unit terminal, make a loop as shown in the installation diagram of indoor and outdoor unit, to prevent water coming in the outdoor unit.
4. Insulate the unused cords (conductors) from any water coming in the outdoor unit. Proceed them so that they do not touch any electrical or metal parts.

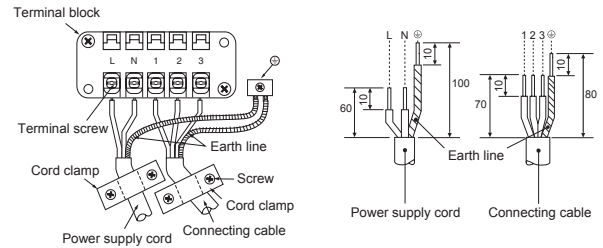

Fig. 8-5-8

Model	24 Class	18 Class
Power source	50 Hz, 220 ~ 240 V Single phase	
Maximum running current	18A	16A
Plug socket & fuse rating	20A	20A
Power cord	4 mm ² (H07R N-F or 245 IE C 66) or 3.5 mm ² (AWG -12)	

CAUTION

- Wrong wiring connection may cause some electrical parts burn out.
- Be sure to comply with local codes on running the wire from indoor unit to outdoor unit (size of wire and wiring method etc).
- Every wire must be connected firmly.

NOTE: Connecting cable

- Wire type: More than 1.5 mm² (H07RN-F or 245 IEC66) or 1.3 mm² (AWG-16)

8-6. Test Operation

8-6-1. Gas Leak Test

- Check the flare nut connections for gas leaks with a gas leak detector and/or soapy water.

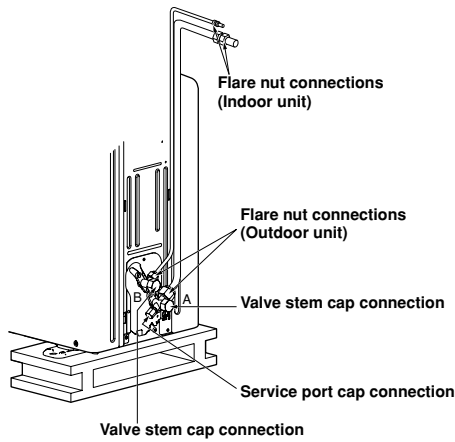

Fig. 8-6-1

8-6-2. Test Operation

To test the system, press and hold RESET button for 10 sec. (There will be one short beep.)

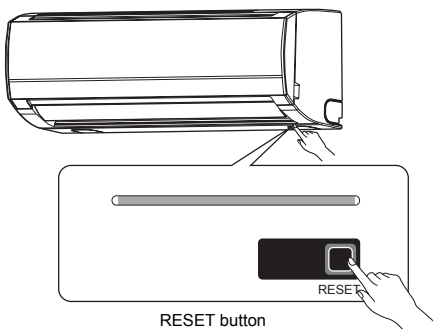

Fig. 8-6-2

8-6-3. Auto Restart Setting

This product is designed so that, after a power failure, it can restart automatically in the same operating mode as before the power failure.

Information

The product was shipped with Auto Restart function in the OFF position. Turn it ON as required.

<How to Set the Auto Restart>

- Press and hold the RESET button for about 3 seconds. After 3 seconds, three short electric beeps will be heard to inform you that the Auto Restart has been selected.
- To cancel the Auto Restart, follow the steps described in the section Auto Restart Function on Owner's Manual.

8-6-4. Remote Controller A or B Selection Setting

When two indoor units are installed in the separated rooms, it is not necessary to change the selector switches.

<Remote control A or B Selection>

- When two indoor units are installed in the same room or adjacent two rooms, if operating a unit, two units may receive the remote control signal simultaneously and operate. In this case, the operation can be preserved by setting either one indoor unit or remote control to B setting. (Both are set to A setting in factory shipment.)
- The remote control signal is not received when the settings of indoor unit and remote control are different.
- There is no relation between A setting/B setting and A room/B room when connecting the piping and cables.

<Remote Control A-B Selection>

To separate using of remote control for each indoor unit in case of 2 air conditioner are installed nearby, the remote control signal simultaneously and operate. In this

Remote Control B Setup.

1. Press RESET button on the indoor unit to turn the air conditioner ON.
2. Point the remote control at the indoor unit.
3. Push and hold CHK • button on the Remote Control by the tip of the pencil. "00" will be shown on the display.
4. Press ● MODE during pushing CHK •, "B" will show on the display and "00" will disappear and the air conditioner will turn OFF. The Remote Control B is memorized.

- Note :**
1. Repeat above step to reset Remote Control to be A.
 2. Remote Control A have not "A" display.
 3. Default setting of Remote Control from factory is A.

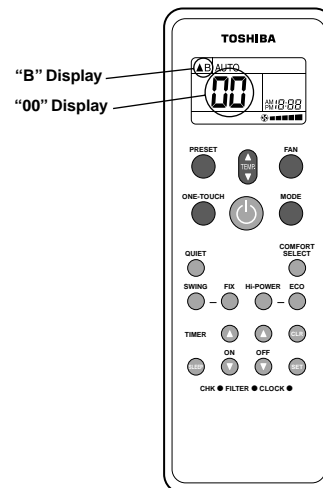

Fig. 8-6-3

9. TROUBLESHOOTING CHART

9-1. Troubleshooting Procedure :

Follow the details of **9-2. Basic Check Items**.
If there is no trouble corresponding to **9-2**, check whether or not there are faulty parts following **9-4. Self-Diagnosis by Remote Control**.

9-2. Basic Check Items

9-2-1. Power supply voltage

The line voltage must be AC 220 – 240 V. If it is not within this range, the air conditioner may not operate normally.

9-2-2. Incorrect cable connection between Indoor and outdoor units

The indoor unit is connected to the outdoor unit with 4 cables. Check that the indoor and outdoor units have been properly connected with terminals assigned the same numbers. If the connectors are not properly connected, the outdoor unit will not operate normally, or OPERATION lamp and TIMER lamp will blink (5 Hz).

9-2-3. Program control

The microcontroller operates as shown in Table 9-2-1 to control the air conditioner. If there are any operational problems, check whether or not the problems correspond to Table 9-2-1. If they correspond to the Table, they are not problems with the air conditioner, but they are indispensable operations to control and maintain the air conditioner properly.

Table 9-2-1

No.	Operation of air conditioner	Descriptions
1	When the main power supply is turned on, the OPERATION lamp on the indoor unit blinks.	The OPERATION lamp blinks to indicate that power is turned on. If the [⏻] button is pressed, the lamp stops blinking.
2	The indoor fan motor speed does not change in the Dry operation.	The indoor fan motor speed is automatically controlled in the Dry operation.
3	The compressor is not turned off even though the room temperature is in the range that the compressor is turned off.	The compressor has a function that it is not turned off for 3 minutes after it is turned on even though the room temperature is in the range that the compressor is turned off.
4	The compressor is not turned on and off even though the thermo control is operated in the Dry operation.	In the Dry operation, the compressor is turned on and off automatically at the regular intervals, independent of the thermo control.
*5	The PRE-DEF. lamp is indicated when the Heating operation starts.	The PRE-DEF. lamp is indicated during the Defrosting operation or if the indoor heat exchanger temperature is low when the Heating operation starts. At this time, the indoor fan motor stops to prevent cold air from blowing in the room.
*6	The outdoor fan motor stops in the Heating operation.	When the indoor heat exchanger temperature is high, the outdoor fan motor is stopped by the high-temperature limit control operation.
7	The compressor is not turned on even though the room temperature is in the range that the compressor is turned on.	The compressor is not turned on in the restart delay timer (3-minutes timer) operation. It is also not turned on after the power supply is turned on because of this timer operation.
8	The operation mode changes in the Automatic operation.	In Automatic operation, the room temperature is detected all time for control fan speed and the operation mode is changed every 15 minutes according to difference between the room temperature and the preset temperature.
9	The Fan only operation continues in the Automatic operation.	When the room temperature is in the range (Preset temperature \pm 1°C), the Fan only operation is selected.
10	The ECO operation or Hi-POWER operation does not work.	These operations do not work when the unit is in the Dry operation or Fan only operation.
11	When [Hi POWER] button is pressed, the display on the remote control does not change at all.	The display on the remote control does not change when [Hi POWER] button is pressed. However the microcontroller gives commands to change the preset temperature and air flow level.

Note *5 and *6 are for Heat pump model :

9-3. Primary Judgement

9-3-1. Role of indoor unit controller

The indoor unit controller receives the operation commands from the remote control and executes them.

- Temperature measurement at the air outlet of the indoor heat exchanger by the indoor temperature sensor
- Temperature setting of the indoor heat exchanger by the heat exchanger sensor
- Louver motor control
- Indoor fan motor operation control
- LED display control
- Transferring of operation commands to the outdoor unit

9-3-2. Failure diagnosis

The indoor unit diagnoses the operation condition and indicates the information of the self-diagnosis with the lamps on the display panel of the indoor unit.

Table 9-3-1

	Lamps	Self-diagnosis
A	OPERATION lamp is blinking. (1 Hz)	Power failure (when the power supply is turning on)
B	OPERATION lamp is blinking. (5 Hz)	Thermo sensor (TA) short or break
C	OPERATION lamp is blinking. (5 Hz)	Heat exchanger sensor (TC) short or break
D	OPERATION lamp is blinking. (5 Hz)	Indoor fan motor lock or failure
E	OPERATION lamp is blinking. (5 Hz)	Indoor P.C. board failure
F	OPERATION and TIMER lamps are blinking. (5 Hz)	Wrong wiring of connecting cable
G	OPERATION, TIMER and PRE-DEF. (or FAN ONLY for cooling only model) lamps are blinking.	Cycle failure <ul style="list-style-type: none"> • Gas shortage or other refrigerant cycle trouble • Heat exchanger sensor open, break or short • Overload relay or thermostat trouble of compressor

Table 9-3-2 Diagnosis by detective operation

Symptom	Check		Primary judgement
The remote control does not work.	Turn off the power supply once, then turn it on. Try to operate the remote control.	The remote control still does not work.	The indoor unit (and/or remote control) is/are defective.
		The remote control works.	OK.
The outdoor fan does not rotate.	The compressor operates.		The outdoor unit (Outdoor fan motor) is defective.
	The compressor does not operate.		An internal part of the compressor or P.C. board is defective.

9-4. Self-Diagnosis by Remote Controller (Check Code)

1. If the lamps are indicated as shown B to E in Table 9-3-1, execute the self-diagnosis by the remote controller.
2. When the remote controller is set to the service mode, the indoor controller diagnoses the operation condition and indicates the information of the self-diagnosis on the display of the remote controller with the check codes. If a fault is detected, all lamps on the indoor unit will flash at 5Hz and it will beep for 10 seconds (Beep, Beep, Beep ...). The timer lamp usually flashes (5Hz) during self-diagnosis.

9-4-1. How to Use Remote Controller in Service Mode

1 Press [CHECK] button with a tip of pencil to set the remote controller to the service mode.

- “00” is indicated on the display of the remote controller.

2 Press [ON▲] or [OFF▲] button

If there is no fault with a code, the indoor unit will beep once (Beep) and the display of the remote controller will change as follows :

00 → 01 → 02 ... 1d → 1E → 33

- The TIMER indicator of the indoor unit flashes continuously. (5 times per 1 sec.)
- Check the unit with all 52 check codes (00 to 33) as shown in Table-11-4-1.
- Press [ON▼] or [OFF▼] button to change the check code backward.

If there is a fault, the indoor unit will beep for 10 seconds (Beep, Beep, Beep...).

Note the check code on the display of the remote controller.

- 2-digits alphanumeric will be indicated on the display.
- All indicators on the indoor unit will flash. (5 times per 1 sec.)

3 Press [CLR] button. After service finish for clear service code in memory.

- "7F" is indicated on the display of the remote control.

4 Press [⏻] button to release the service mode.

- The display of the remote controller returns to as it was before service mode was engaged.

Alphanumeric characters are used for the check codes.

5 is 5.	6 is 6.
A is A.	b is B.
C is C.	d is D.

Fig. 9-4-1

Table 9-4-1

Block level		Diagnosis function				Judgement and action
Check code	Block	Check code	Symptom	Unit status	Condition	
00	Indoor P.C. board	0C	The indoor thermo sensor (TA) is defective. Disconnection or short-circuit	Operation continues.	The lamp on the indoor unit blinks when error is detected.	1. Check the indoor thermo sensor (TA). 2. Check the indoor P.C. board.
		0d	The indoor heat exchanger sensor (TC) is defective. Disconnection or short-circuit	Operation continues.	The lamp on the indoor unit blinks when error is detected.	1. Check the indoor heat exchanger sensor (TC). 2. Check the indoor P.C. board.
		11	The indoor fan motor or its circuit is defective.	All off	The lamp on the indoor unit blinks when error is detected.	1. Check the connector circuit of the indoor fan motor (CN10). 2. Check the indoor fan motor. 3. Check the indoor P.C. board.
		12	The part other than the above parts on the indoor P.C. board is defective. EEPROM access error	Operation continues.	The lamp on the indoor unit blinks when error is detected.	1. Check the indoor P.C. board. (EEPROM and peripheral circuits)
		21	IOL operation	All off	The lamp on the indoor unit blinks when error is detected.	Overload operation of refrigerating cycle
01	Cable connection	04	The serial signals can not be transmitted and received between indoor and outdoor units. • The crossover wire is connected wrongly. • The serial signal transmitting circuit on the outdoor P.C. board is defective. • The serial signal receiving circuit on the indoor P.C. board is defective.	Operation continues.	The lamp on the indoor unit blinks when error is detected.	1. In the case of the outdoor unit not operating at all; • Check the crossover cable and connect it properly. • Check the outdoor P.C. board. 2. In the case of the outdoor unit operating normally; • Check whether or not both of serial LED (Green) and serial LED (Orange) is blinking. If the serial LED (Green) is not blinking, check the outdoor P.C. board. If the serial LED (Orange) is not blinking, check the indoor P.C. board.
		05	The operation command signals are not transmitted from the indoor unit to the outdoor unit.	Operation continues.	The lamp on the indoor unit blinks when error is detected. And it returns to the normal condition when recovering from errors.	If the operation command signals continue to be transmitted between 2 and 3 of the indoor terminal block, replace the outdoor P.C. board.
02	Outdoor P.C. board	18	The outdoor thermo sensor (TE) is defective. Disconnection or short-circuit	All off	The lamp on the indoor unit blinks when error is detected.	1. Check the outdoor thermo sensor (TE). 2. Check the outdoor P.C. board.
		19	The outdoor heat exchanger (TD) sensor is defective. Disconnection or short-circuit	All off	The lamp on the indoor unit blinks when error is detected.	1. Check the outdoor heat exchanger sensor (TD). 2. Check the outdoor P.C. board.
03	Other parts (including compressor)	07	The reply serial signal has been transmitted when starting the unit, but stops being transmitted shortly after. 1. Compressor thermo operation • Gas shortage • Gas leak 2. Instantaneous power failure	Operation continues.	The lamp on the indoor unit blinks when error is detected. And it returns to the normal condition when recovering from errors.	1. Repeatedly turn the indoor unit on and off with the interval of approx. 10 to 40 minutes. (The check code is not indicated during operation.) And supply gas. (Check gas leak.) 2. The indoor unit operates normally during the check. If the reply serial signal continues to be transmitted between 2 and 3 of the indoor terminal block, replace the outdoor P.C. board. If the signal stops between them, replace the indoor P.C. board.
		1E	The discharge temperature is over 120°C.	All off	The lamp on the indoor unit blinks when error is detected.	1. Check the heat exchanger sensor (TD). 2. Gas purging
		20	The IOL operation is defective.	All off	The lamp on the indoor unit blinks when error is detected.	When turning on the unit, the normal phase (RST) is detected but T-R waveform has not been detected for 120 seconds or more.

9-5. How To Diagnose Faulty Parts

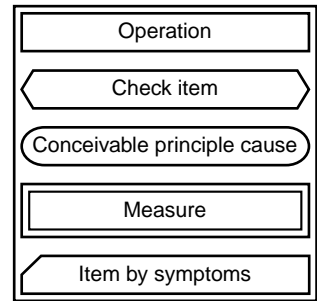

[04 Serial signal error] (Heat pump model)

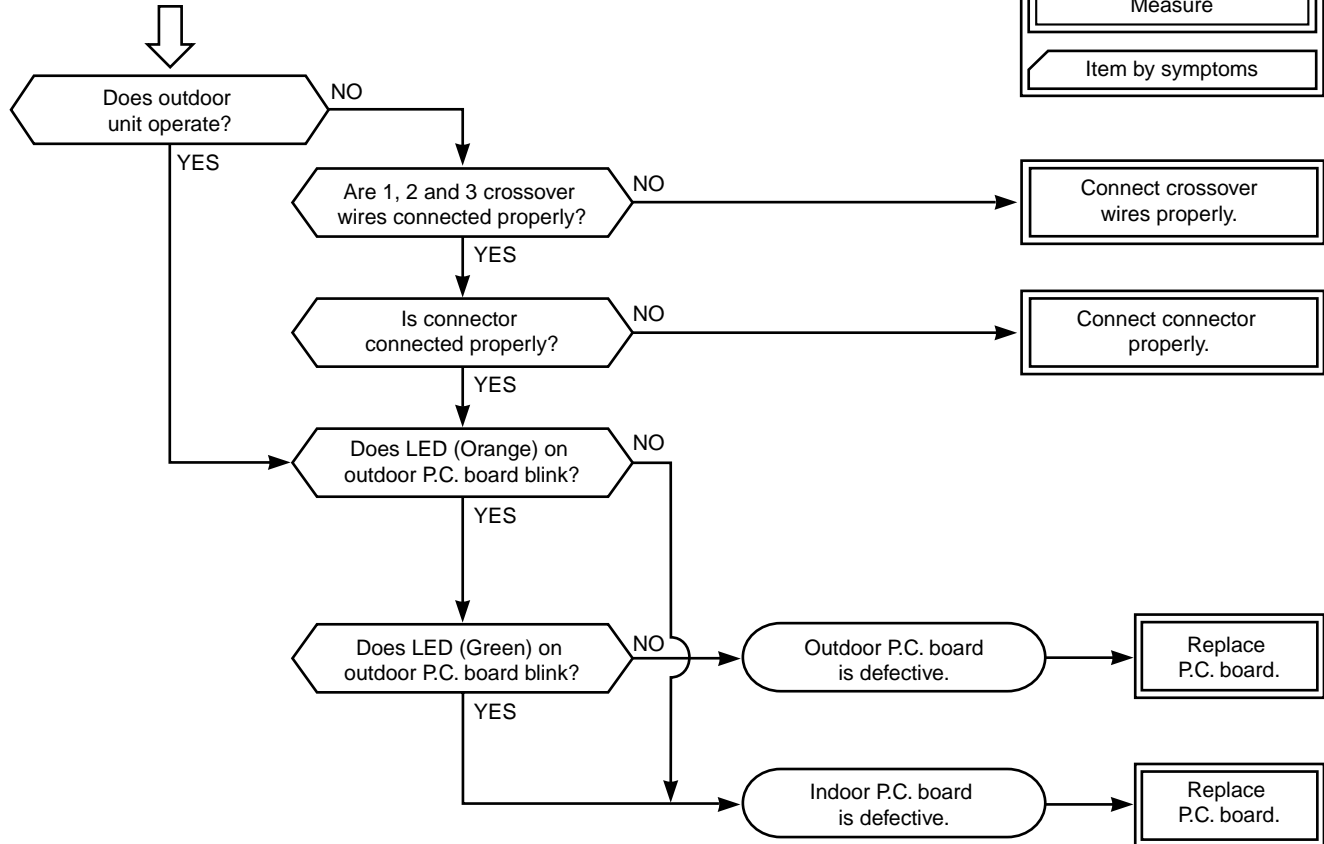

[08 Four-way valve error] (Heat pump model)

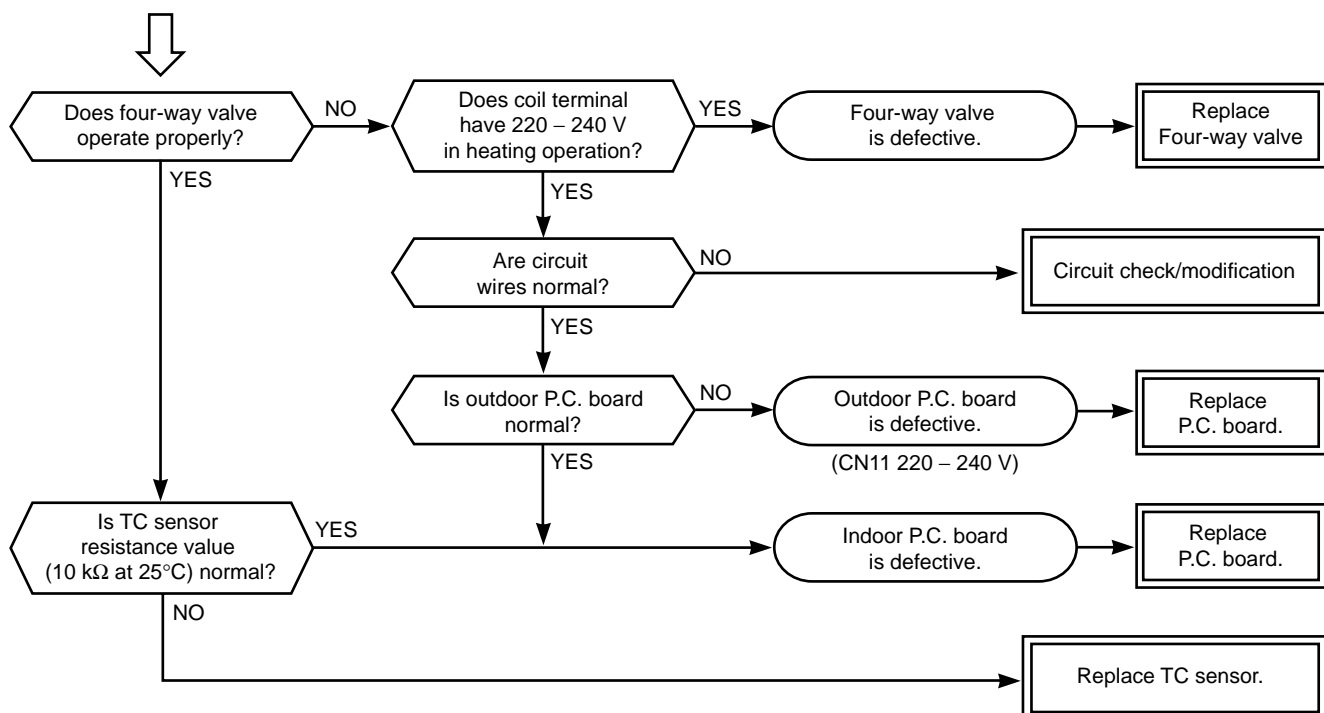

[09 Other cycle error] (1) (Heat pump model)

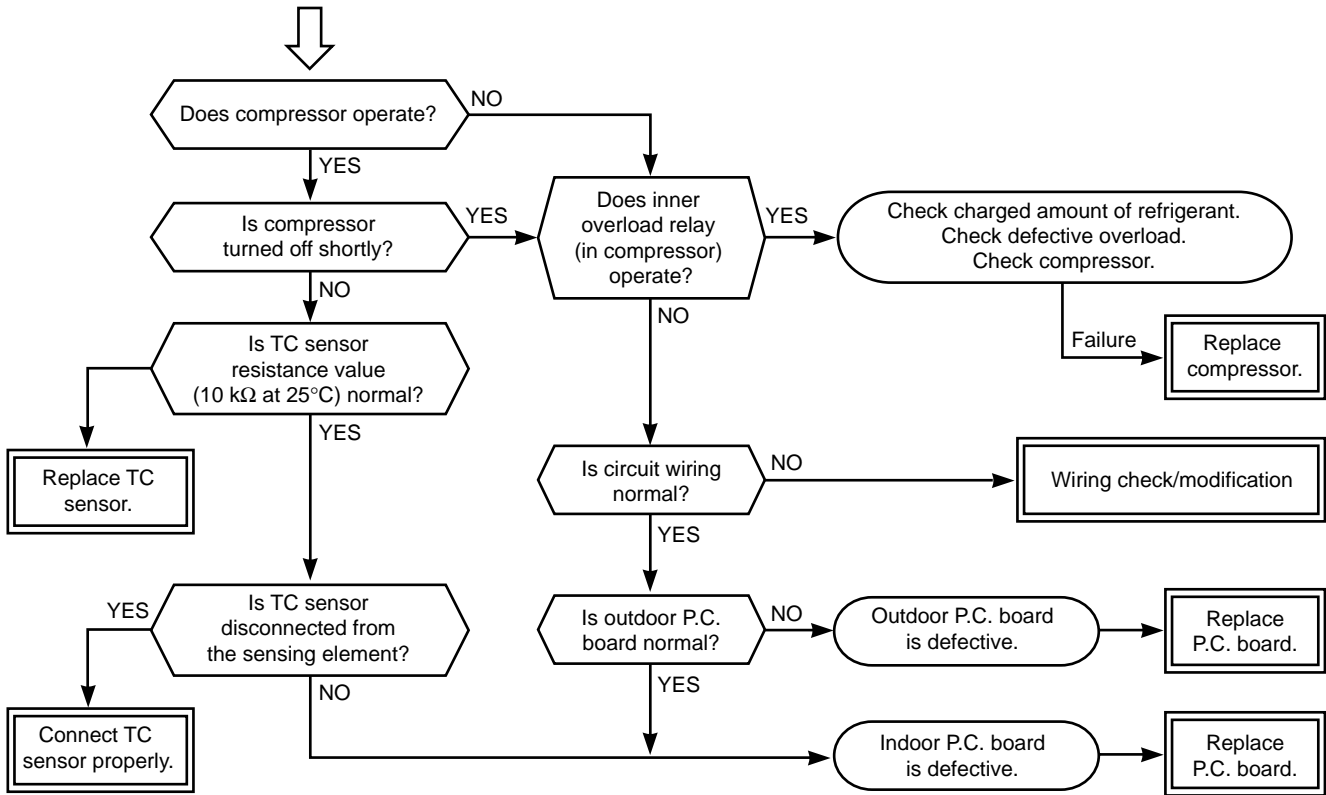

[09 Other cycle error] (2)

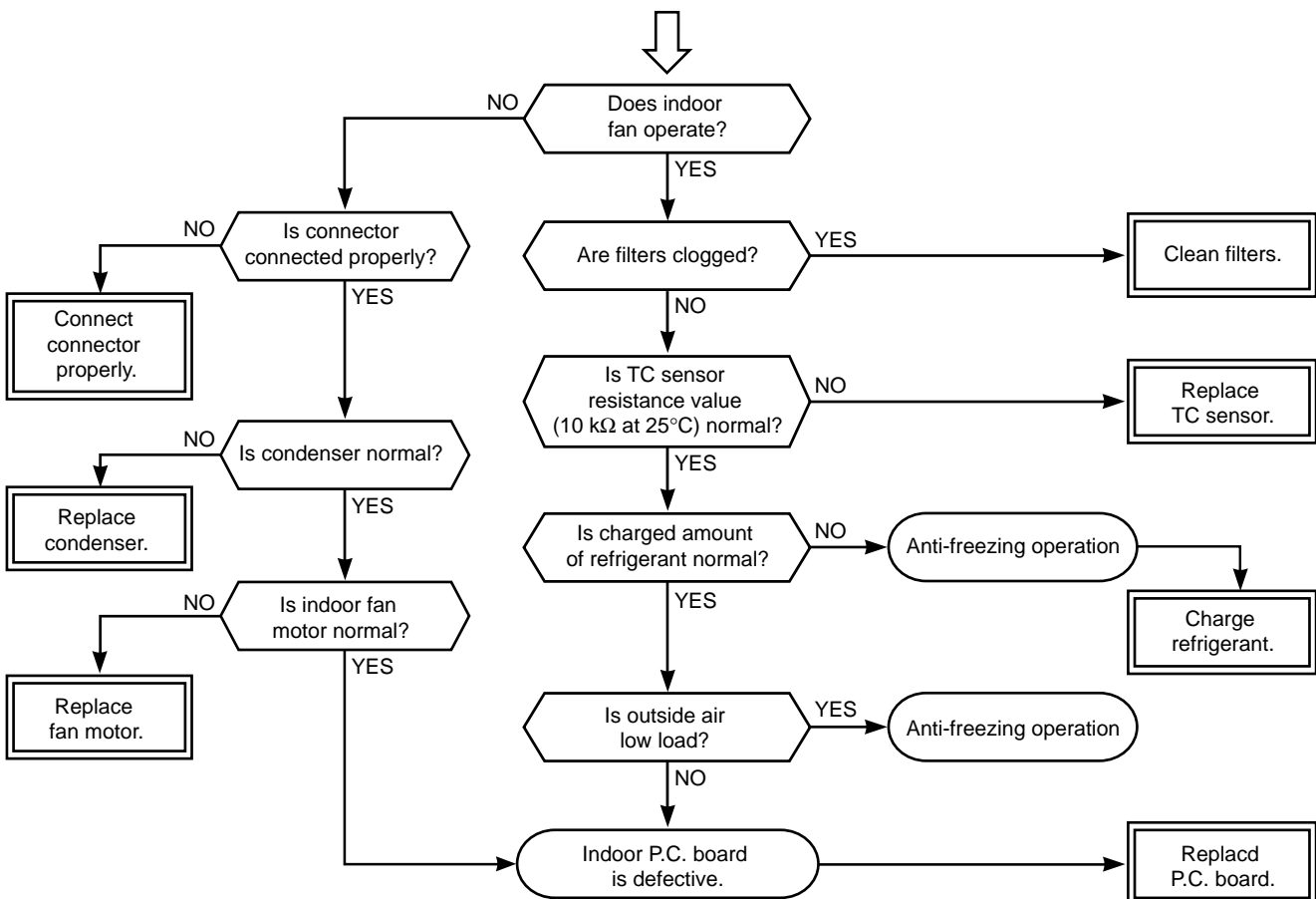

[0C Indoor TA sensor error]

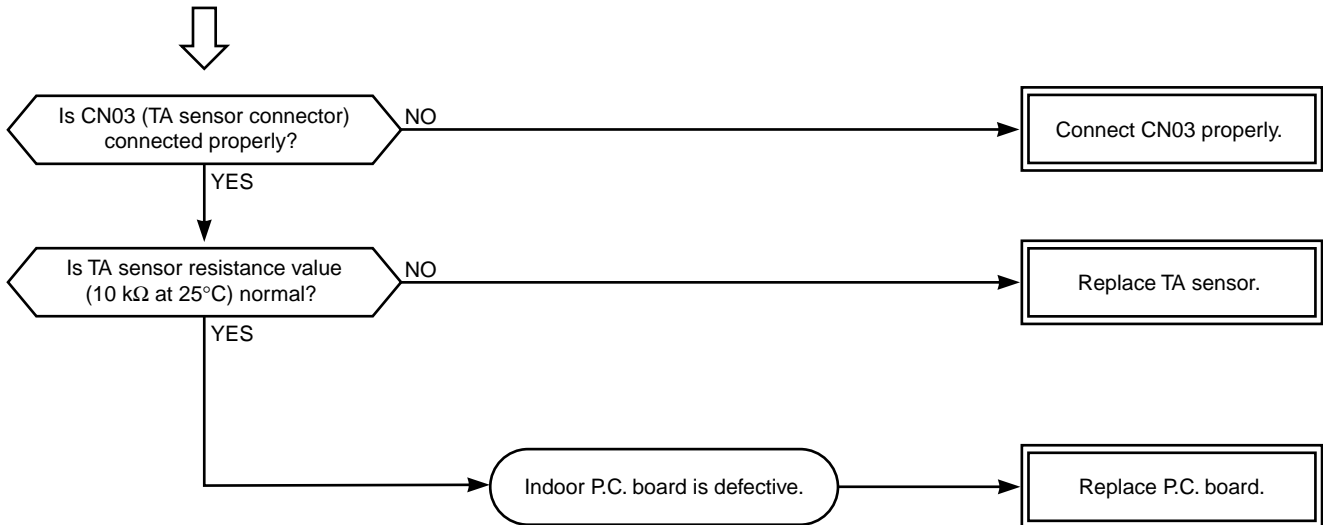

[0d Indoor TC sensor error]

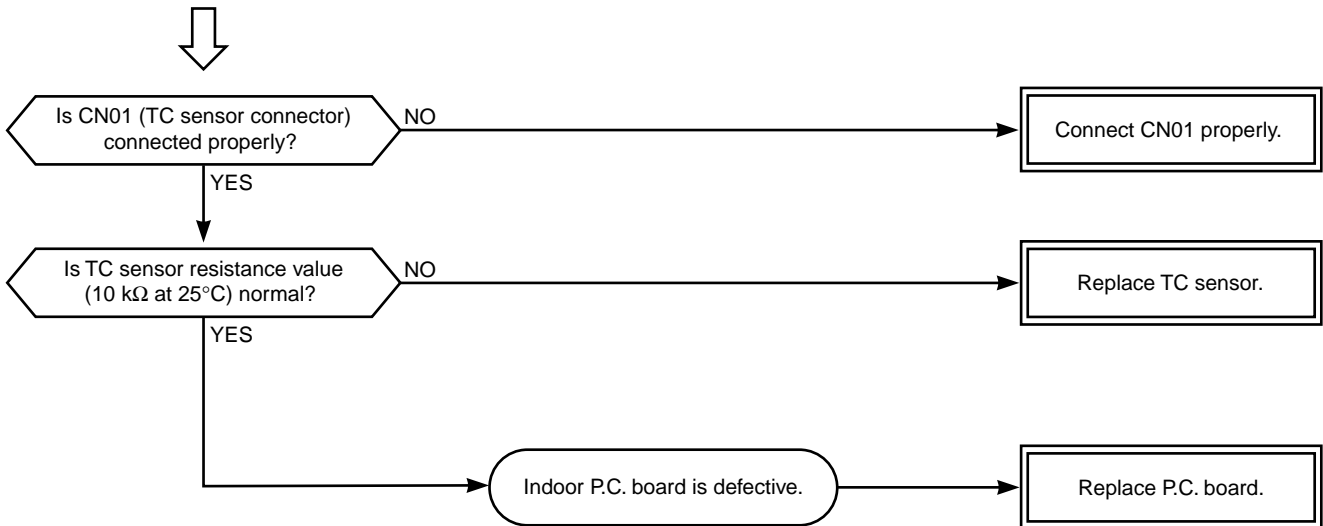

[18 outdoor TE sensor error] (Heat pump model)

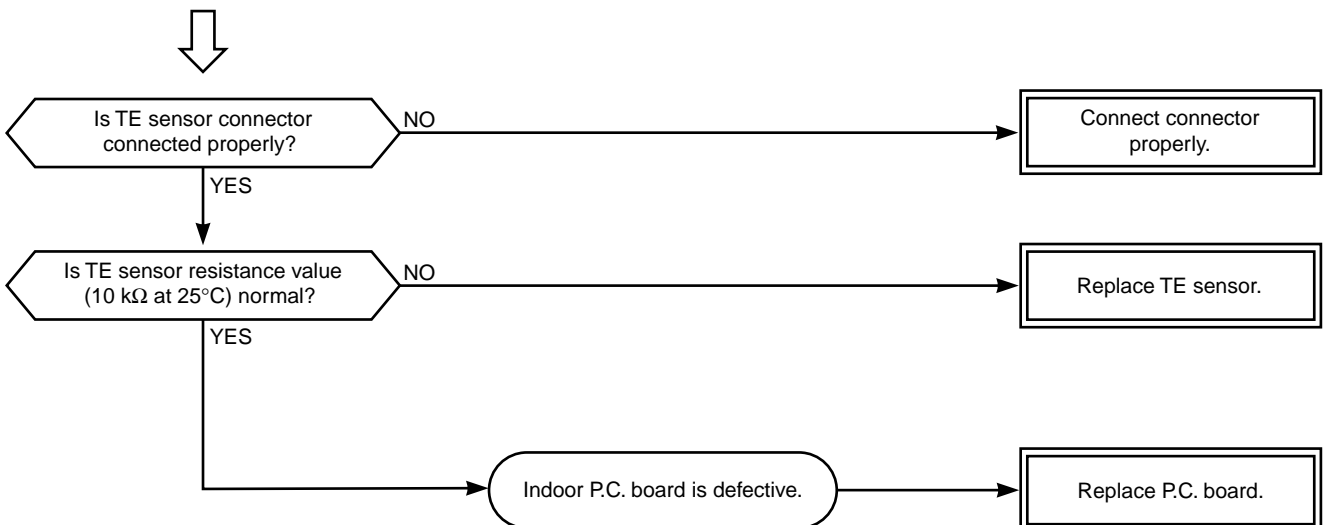

[19 outdoor TD sensor error] (Heat pump model)

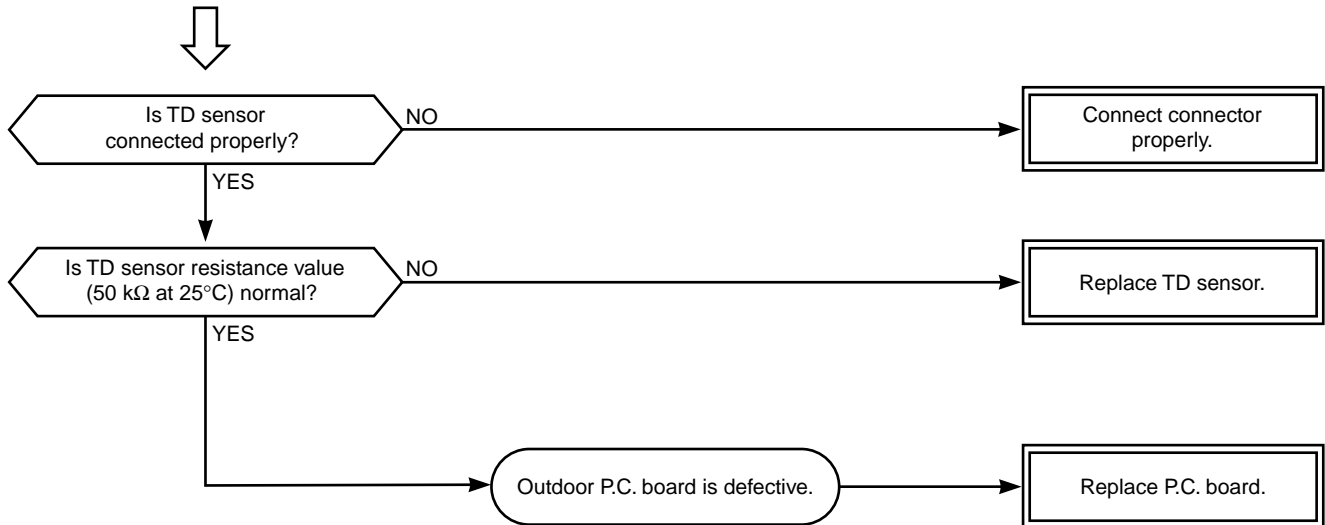

[1E Discharge temp. error] (Heat pump model)

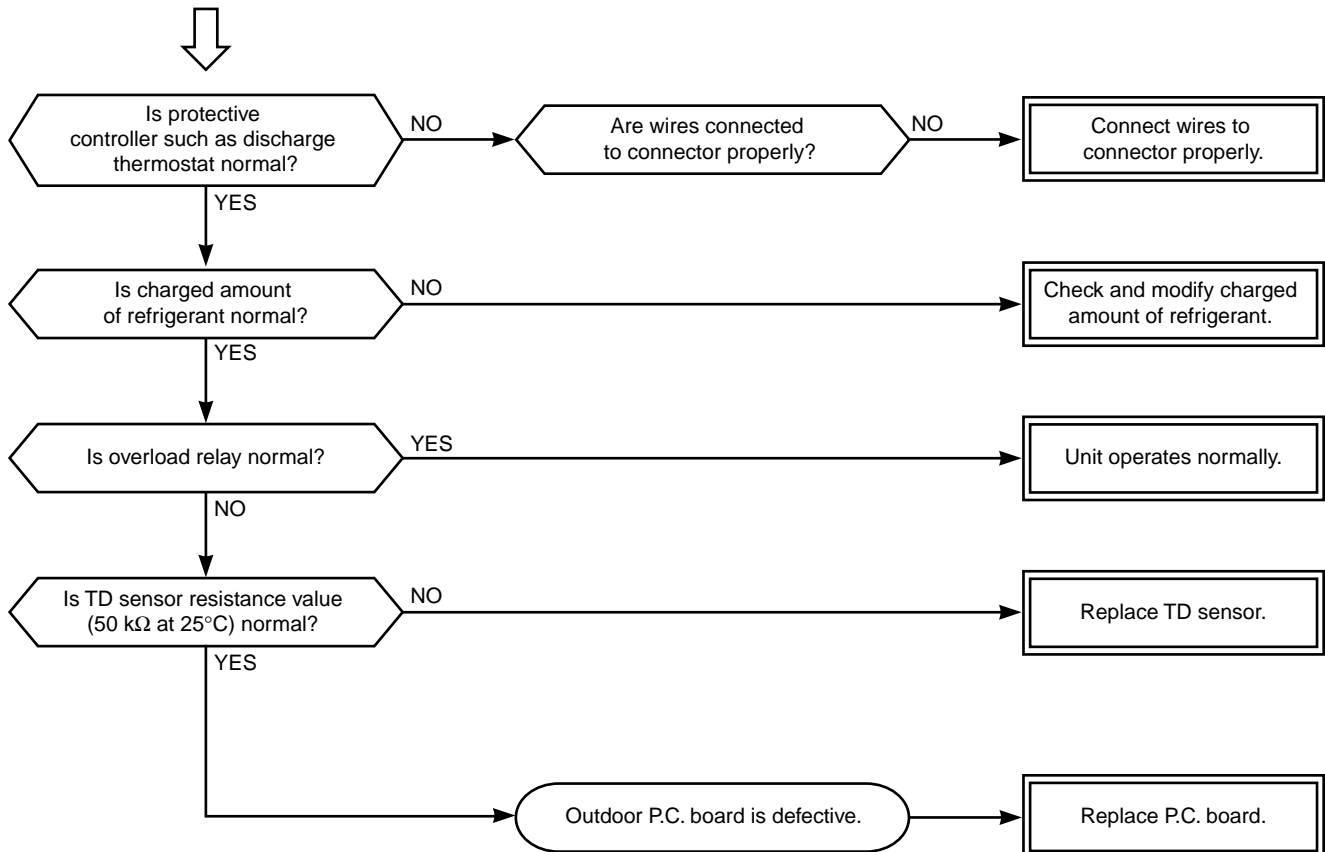

9-6. Troubleshooting for Indoor unit

9-6-1. Power can not be turned on. (The unit does not operate at all.)

<Primar check>

- (1) Is the supply voltage normal?
- (2) Is the connection to the AC output OK?
- (3) Is the fuse (F01) blown?

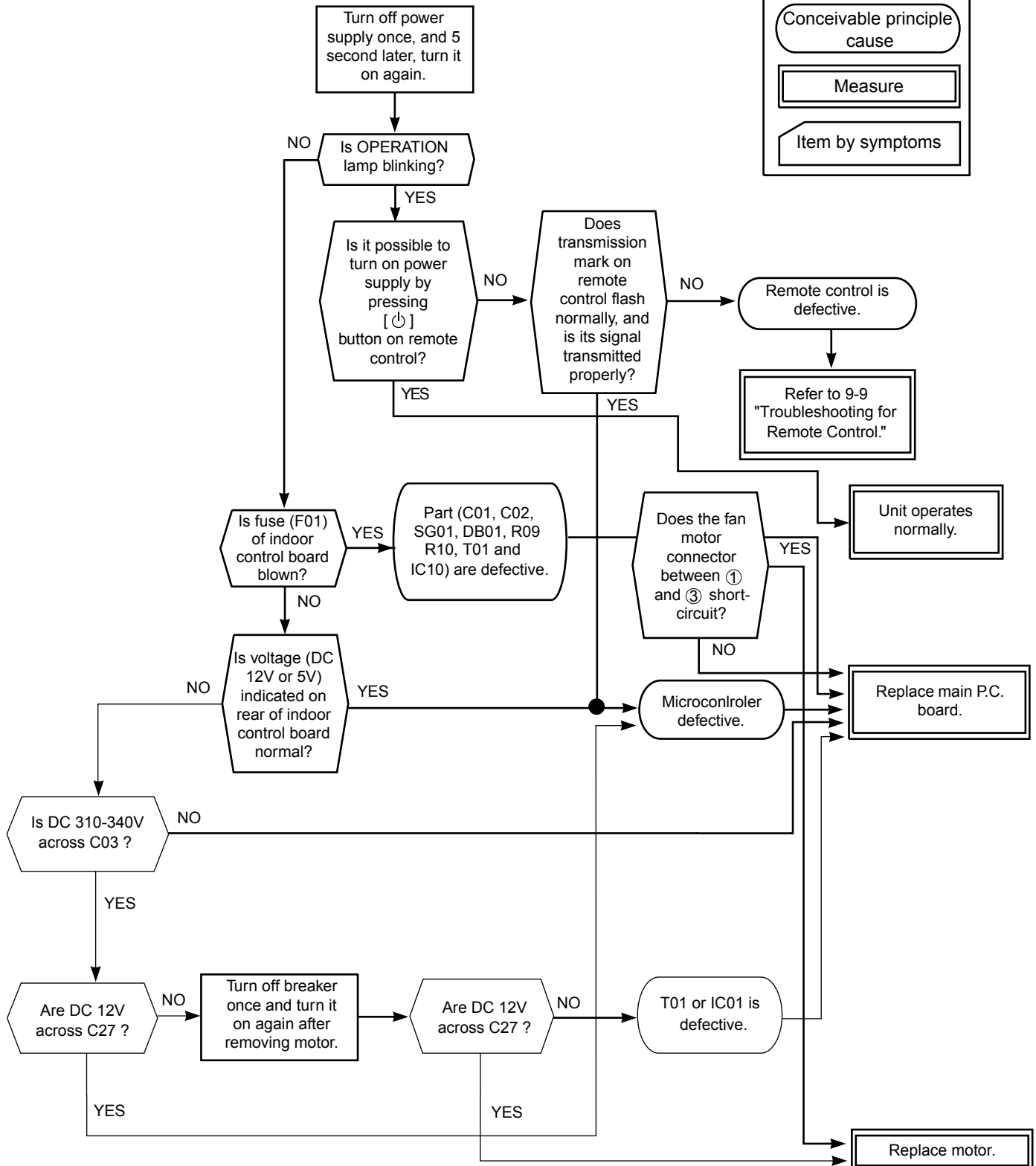
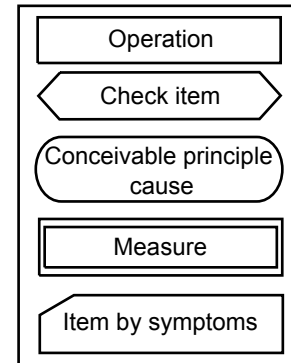

9-6-2. Only indoor fan motor does not operate.

<Primary check>

- (1) Is it possible to detect the power supply voltage (200 – 240 V) between ① and ② on the terminal block?
- (2) Does the indoor fan motor operate in cooling operation?
(In heating operation, the indoor fan motor does not operate for approximately 5 minutes after it is turned on, to prevent a cold air from blowing in.)

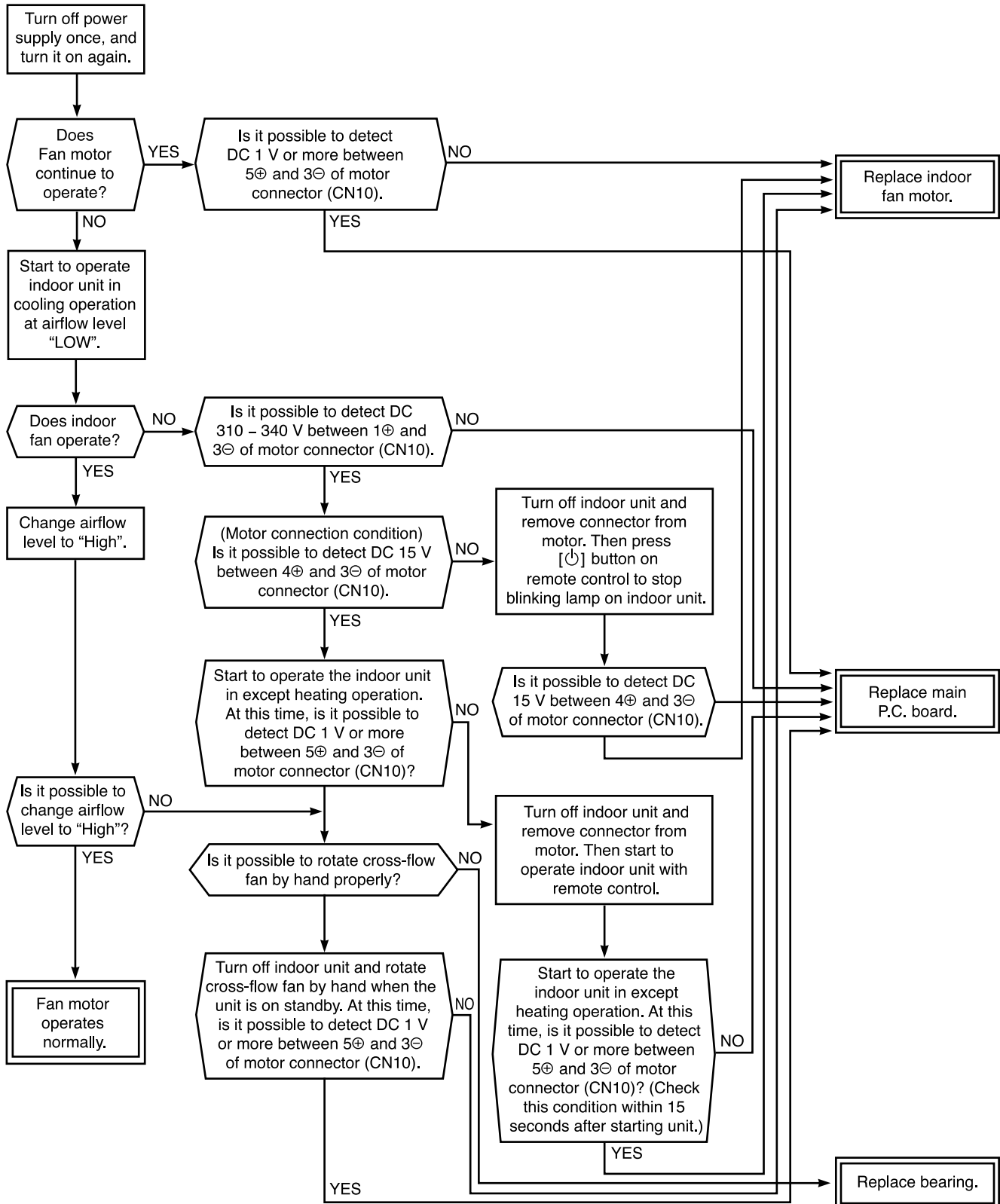

9-6-3. Compressor does not operate.

<Primary check>

- (1) Is the preset temperature higher than the room temperature in cooling operation?
- (2) Is the crossover cable connected properly?

RAS-18,24SKP-ES

<Inspection procedure>

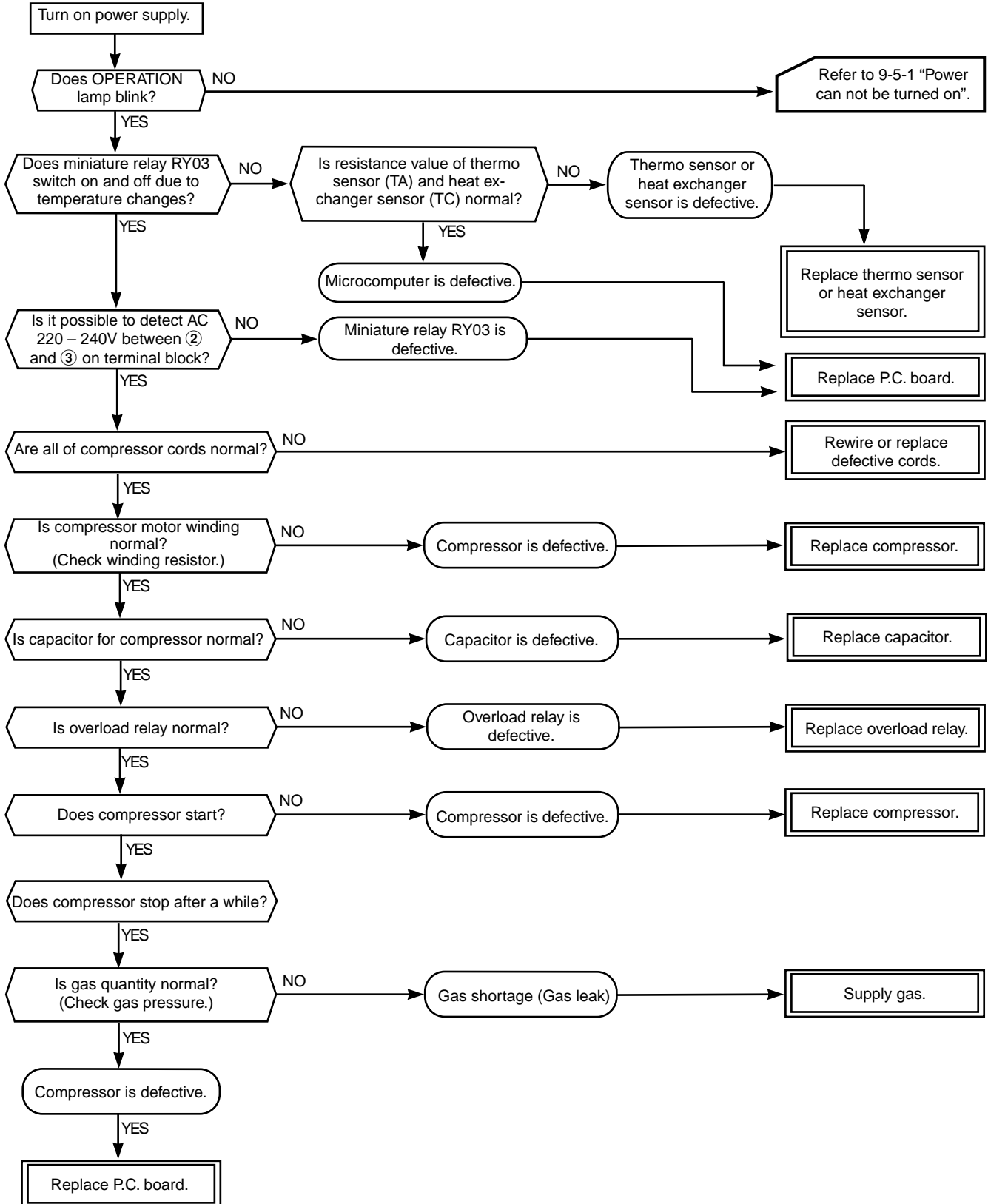

RAS-18,24SKHP-ES

<Inspection procedure>

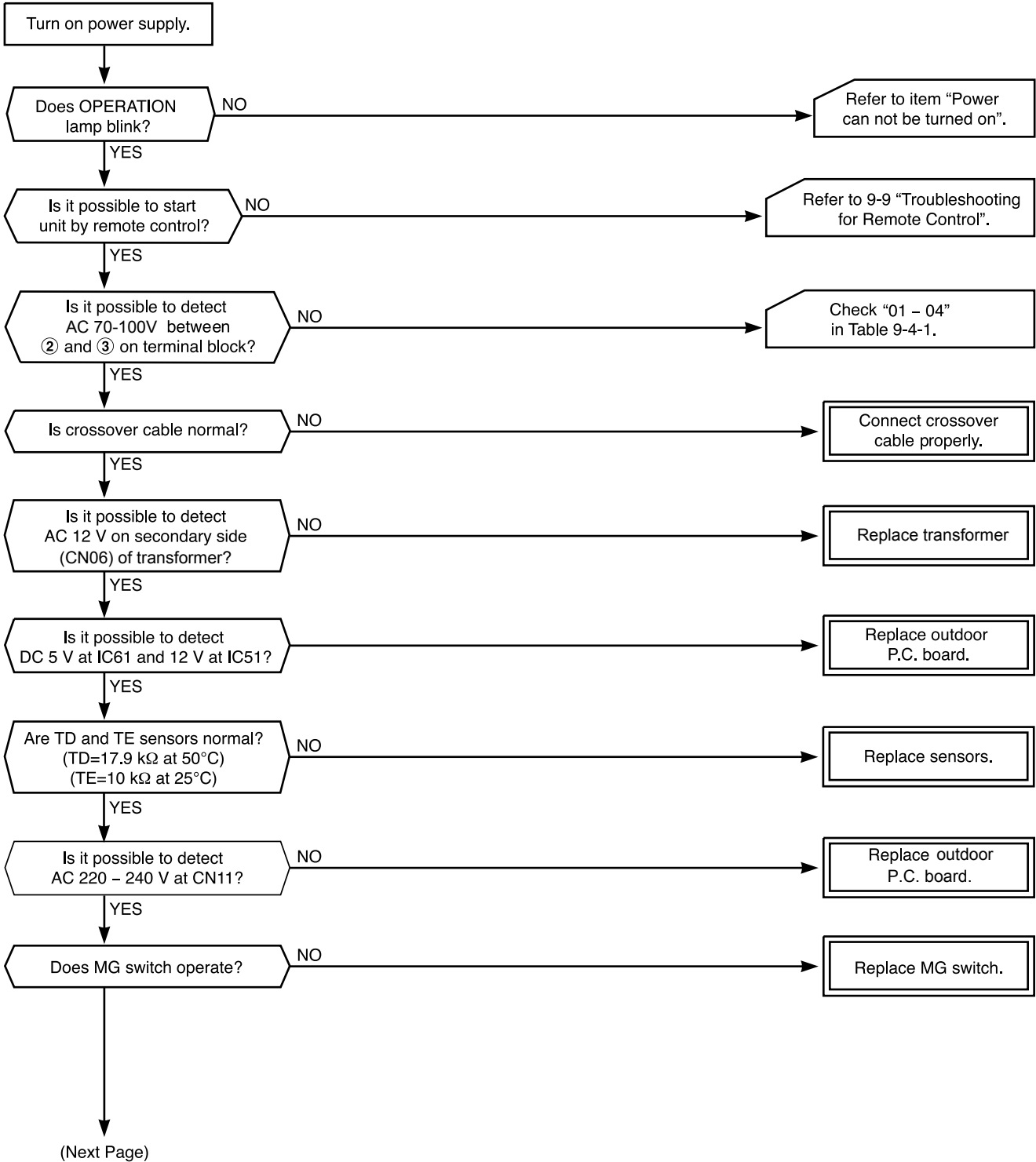

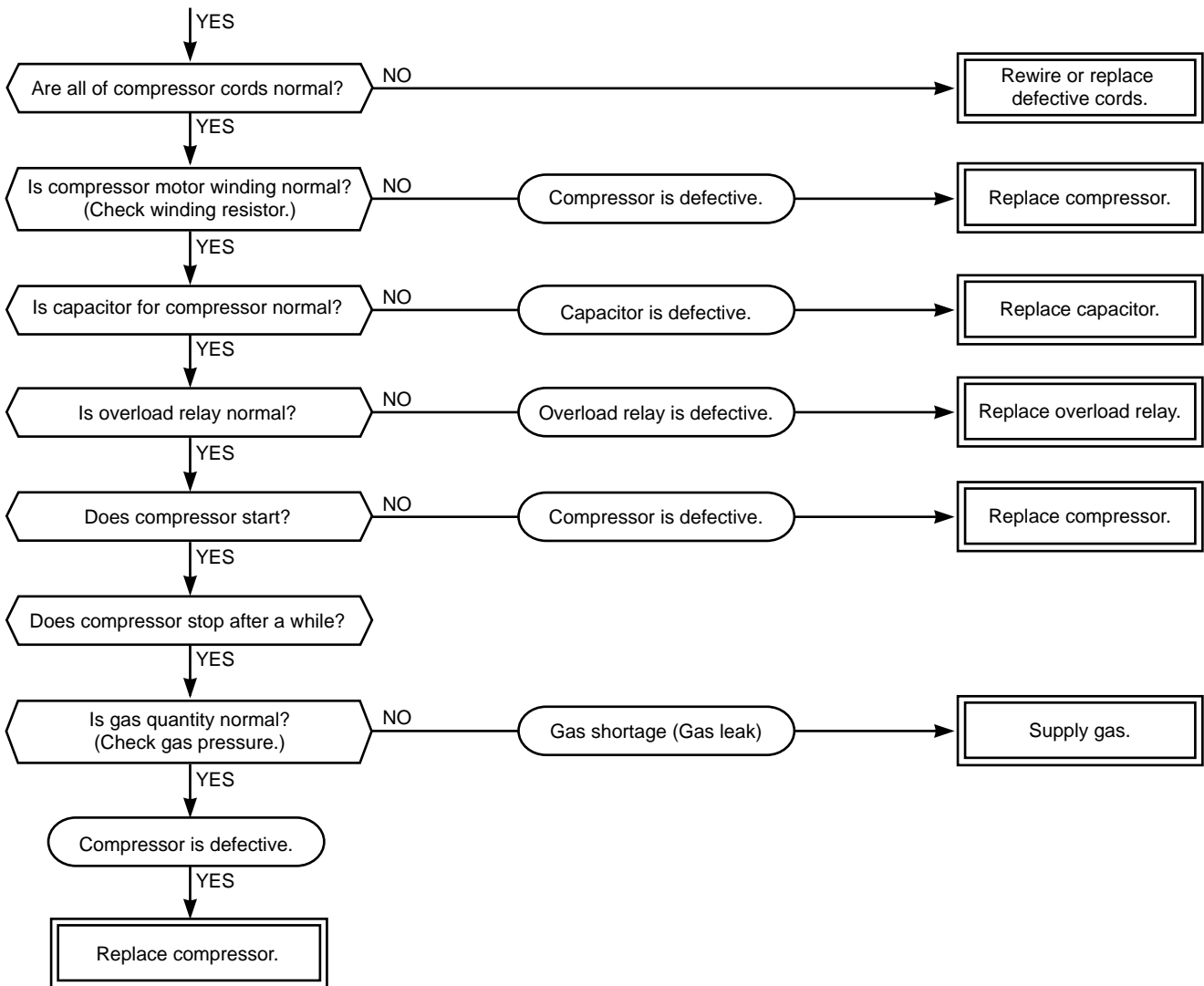

9-7. Troubleshooting for Wiring (Interconnect cable and Serial Signal Wire)

9-7-1. Outdoor unit does not operate.

<Inspection procedure>

- (1) Is the voltage between ① and ② of the indoor terminal block varied?
- (2) Are signals from the indoor unit to the outdoor unit transmitted correctly based upon the following diagram?

NOTE:

Measure the voltage for 2 minutes and 30 seconds after starting the unit.

RAS-18SKP-ES and RAS-24SKP-ES

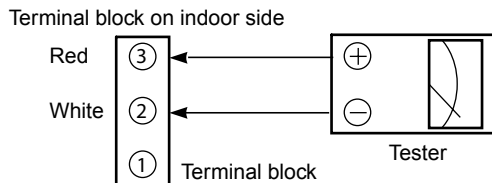

Normal condition : After start operated about 2 minutes and 30 seconds. Voltage between ② and ③ of the indoor's Terminal block should be equal AC 220 ~ 240V

Abnormal condition : Don't found voltage AC 220 ~ 240V from terminal block (0V)

RAS-18SKHP-ES and RAS-24SKHP-ES

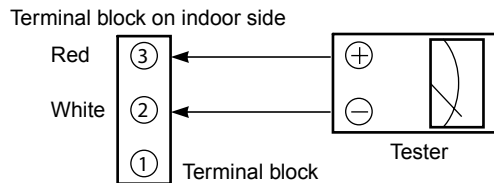

Normal condition : Voltage varied between AC70 ~ 100V

Abnormal condition : Voltage does not vary.

9-7-2. Outdoor unit stops a while after starting the unit.

<Confirmation procedure> Select one of 3 cases below and follow the procedure.

- (1) The outdoor unit stops between 10 and 20 minutes passed after starting and it takes 10 minutes or more to restart the unit.

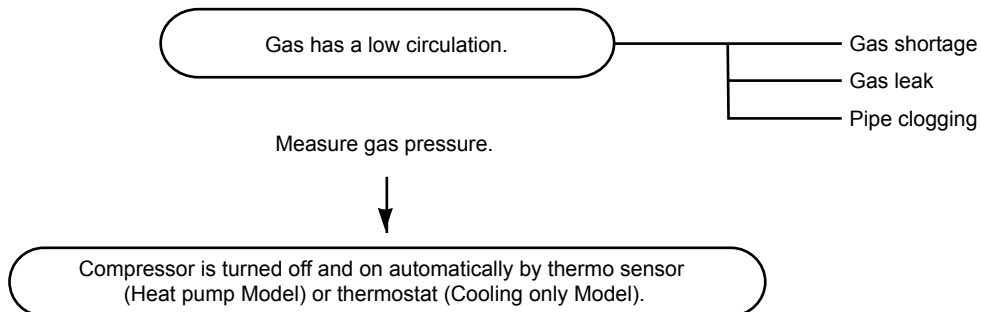

- (2) The outdoor unit stops once, it would not operate until the power is turned on again.



- (3) The outdoor unit stops between 10 minutes to 1 hour after starting and a check code is indicated on the remote control. (Check code 03-1E : Refer to Table 9-4-1.)

9-8. Troubleshooting for P.C. board**9-8-1. How to check indoor P.C. board****<Cautions for handling P.C. board>**

- (1) When removing the front panel and the P.C. board, be sure to turn off the power supply.
- (2) When removing the P.C. board, hold the edge of the P.C. board and do not apply force to the parts.
- (3) When connecting or disconnecting the connectors on the P.C. board, hold the housing. Do not pull at lead wires.

<Inspection procedure>

- (1) If the P.C. board is defective, check for disconnection, burn or discoloration of the copper foil pattern of the P.C. board.
- (2) The P.C. board consists of the following 2 parts:
 - a. Main P.C. board parts.**
Power relay, indoor fan motor drive circuit and control circuit, C.P.U. and peripheral circuits, buzzer drive circuit and buzzer. .C. board are defective.
 - b. Infrared rays parts:**er to Table 9-8-2.)
Infrared rays receiving circuit .C. board is defective.

Check the defects of the P.C. board with Table 9-8-1.

RAS-18,24SKHP-ES

Table 9-8-1 Inspection procedure

No.	Procedure	Check points	Causes
1	Turn off the power supply and remove the P.C. board assembly from electric parts base. Remove the connecting cables from the terminal block.	Check whether or not the fuse (F01) is blown.	Impluse voltage was applied or the indoor fan motor short-circuited.
2	Remove the connector of the motor and turn on the power supply. If OPERATION lamp blinks (once per second), it is not necessary to check steps (1 to 3) in the right next column.	Check power supply voltage; 1. Between CN30 and CN31 (220 – 240 V AC) : Except 2. Between + and – of C03 (DC310 – 340 V) 3. Between 12 V and GND 4. Between 5 V and GND	1. The terminal block or the crossover cable is connected wrongly. 2. The capacitor (C01 and C02) line filter (L01), resistor (R09), or the diode (DB01) is defective. 3. C27, T01 and IC01 are defective. 4. IC10, C30, C11 or T01 are defective.
3	Press [⏻] button once to start the unit. (Do not set the mode to Fan Only or On-Timer operation).	Check power supply voltage; 1. Between CN31 and CN23 (AC70 ~ 100V)	IC03 or IC04 are defectice.
4	Shorten the line of the restart delay timer and start unit.	Check whether or not all lamps (OPERATION, TIMER, PRE.-DEF. (or FAN ONLY), FILTER and Hi Power) are indicated for 3 seconds and then return to normal 3 seconds later.	The lamps are defective or the housing assembly (CN13) is defective.
5	Press [⏻] button once to start the unit. • Shorten the time of the restart delay timer. • Set the operation mode to COOL. • Set the fan speed level to AUTO. • Set the preset temperature must lower than the room temperature. (The unit (compressor) operates continuously in the above condition.)	1. Check whether or not the compressor operates. 2. Check whether or not the OPERATION lamp blinks.	1. The temperature of the indoor heat exchanger is extremely low. 2. The connection of the heat exchanger sensor is loose. (The connector is disconnected.) (CN01) 3. The heat exchanger sensor and the P.C. board are defective. (Refer to Table 9-8-2.) 4. The main P.C. board is defective.

No.	Procedure	Check points	Causes
6	<p>If the above condition (No. 5) still continues, start the unit in the following condition.</p> <ul style="list-style-type: none"> • Set the operation mode to HEAT. • Set the preset temperature must higher than room temperature. 	<ol style="list-style-type: none"> 1. Check whether or not the compressor operates. 2. Check whether or not the OPERATION lamp blinks. 	<ol style="list-style-type: none"> 1. The temperature of the indoor heat exchanger is extremely high. 2. The connector of the heat exchanger sensor short-circuited. (CN01) 3. The heat exchanger sensor and the P.C. board are defective. (Refer to Table 9-8-2.) 4. The main P.C. board is defective.
7	<p>Connect the motor connector to the main P.C. board and turn on the power supply. Start the unit in the following condition.</p> <ul style="list-style-type: none"> • Set the operation mode to FAN. • Set the fan speed level to HIGH. <p>(The unit (compressor) operates continuously in the above condition.)</p>	<ol style="list-style-type: none"> 1. Check it is impossible to detect the voltage (DC 12 V) between ⑥ and ③ of the motor terminals. 2. The motor does not operate. (But it is possible to receive the signal from the remote control.) 3. The motor rotates but vibrates strongly. 	<ol style="list-style-type: none"> 1. The indoor fan motor is defective. (Protected operation of P.C. board) 2. The connection of the motor connector is loose. 3. The P.C. board is defective.

RAS-18,24SKP-ES

Table 9-7-1 Inspection procedure

No.	Procedure	Check points	Causes
1	Turn off the power supply and remove the P.C. board assembly from electric parts base. Remove the connecting cables from the terminal block.	Check whether or not the fuse (F01) is blown.	Impulse voltage was applied or the indoor fan motor short-circuited.
2	Remove the connector of the motor and turn on the power supply. If OPERATION lamp blinks (once per second), it is not necessary to check steps (1 to 3) in the right next column.	Check power supply voltage; 1. Between CN30 and CN31 (220 – 240 V AC) : Except 2. Between + and – of C03 (DC310 – 340 V) 3. Between 12 V and GND 4. Between 5 V and GND	1. The terminal block or the crossover cable is connected wrongly. 2. The capacitor (C01 and C02) LINE filter (L01), resistor (R09, R10), or the diode (DB01) is defective. 3. C27, T01 and IC01 are defective. 4. IC10, C30, C11 or T01 are defective.
3	Press [⏻] button once to start the unit. (Do not set the mode to Fan Only or On-Timer operation).	Check power supply voltage; 1. Between collector of Q08 and GND (for relay coil (DC12 V)) 2. Between ② and ③ of terminal block for connecting cable	1. The wire of the relay coil (RY03) comes down or the relay drive (Q08) is defective. 2. CN27 or RY03 is connected wrongly.
4	Shorten the line of the restart delay timer and start unit.	Check whether or not all lamps (OPERATION, Auto restart, TIMER, FILTER and Hi-power) are indicated for 3 seconds and they return to normal 3 seconds later.	The lamps are defective or the housing assembly (CN13) is defective.
5	Press [⏻] button once to start the unit. • Shorten the time of the restart delay timer. • Set the operation mode to COOL. • Set the fan speed level to AUTO. • Set the preset temperature must lower than the room temperature. (The unit (compressor) operates continuously in the above condition.)	1. Check whether or not the compressor operates. 2. Check whether or not the OPERATION lamp blinks.	1. The temperature of the indoor heat exchanger is extremely low. 2. The connection of the heat exchanger sensor is loose. (The connector is disconnected.) (CN01) 3. The heat exchanger sensor and the P.C. board are defective. (Refer to Table 9-7-2.) 4. The main P.C. board is defective.
6	Connect the motor connector to the main P.C. board and turn on the power supply. Start the unit in the following condition. • Set the operation mode to FAN. • Set the fan speed level to HIGH. (The unit (compressor) operates continuously in the above condition.)	1. Check it is impossible to detect the voltage (DC 12 V) between 6 and 3 of the motor terminals. 2. The motor does not operate. (But it is possible to receive the signal from the remote control.) 3. The motor rotates but vibrates strongly.	1. The indoor fan motor is defective. (Protected operation of P.C. board) 2. The connection of the motor connector is loose. 3. The P.C. board is defective.

Table 9-8-2. Approximate resistance value of thermo sensor(k Ω)

Temperature	0°C	10°C	20°C	25°C	30°C
Resistance value	33.8	20.35	12.59	10.00	7.99

9-8-2. How to shorten time of restart delay timer

- 1 Press [SET] button while pressing [CHECK] button with a tip of a pencil.
- 2 Then press [ON] button to transmit the signal to the indoor unit.

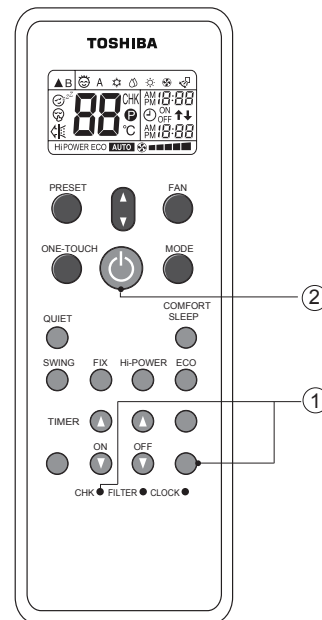
**9-8-3. How to set/cancel self cleaning function**

The self cleaning function is set from a factory. To cancel this function, should keep press the RESET button on Indoor unit for 20 seconds till can hear the long combination sound and repeat the same procedure when need to set.

9-9. Troubleshooting for Remote Control

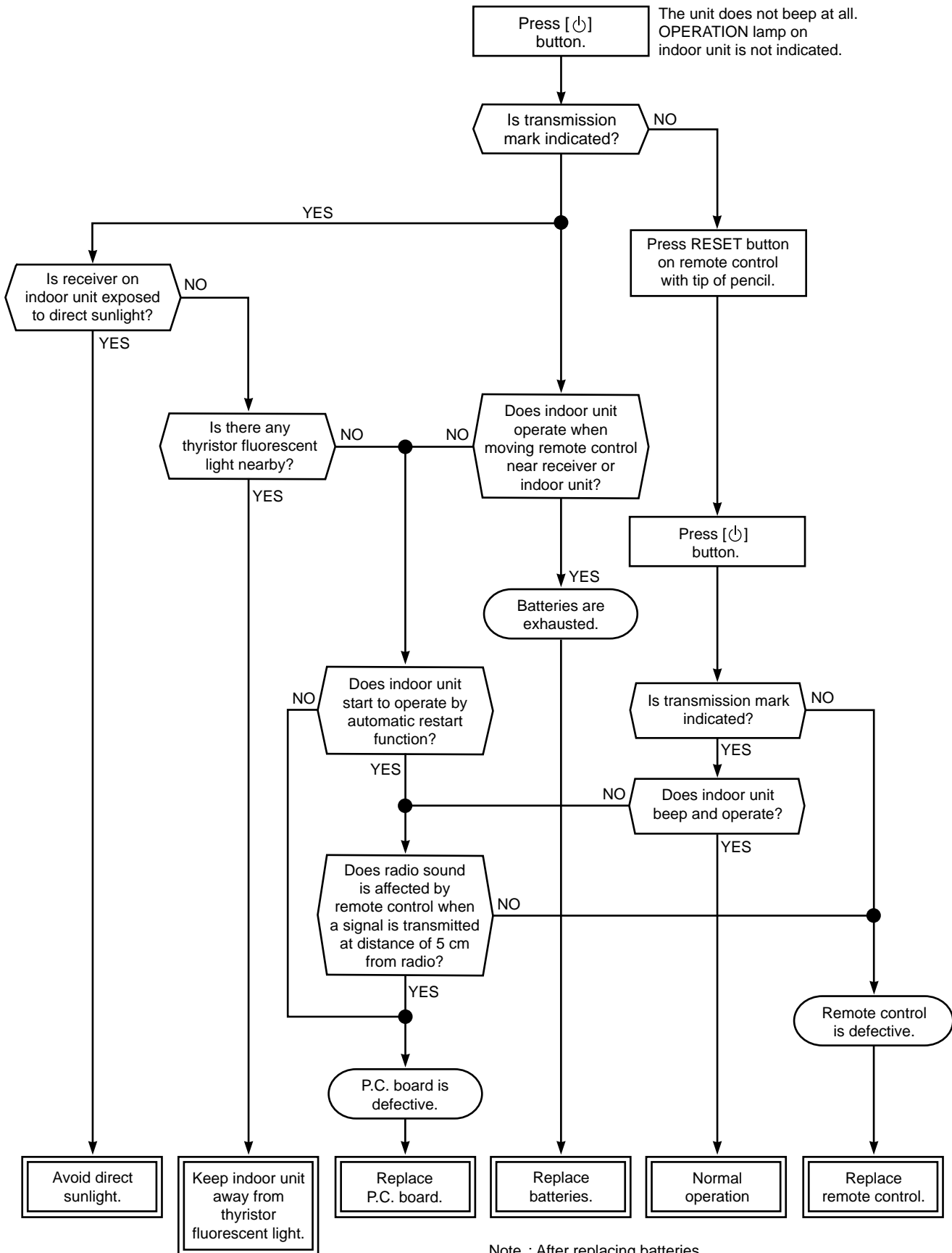

Note : After replacing batteries, press the RESET button with a tip of a pencil.

10. HOW TO REPLACE THE MAIN PARTS

WARNING



- Since high voltages pass through the electrical parts, turn off the power without fail before proceeding with the repairs.
Electric shocks may occur if the power plug is not disconnected.
- After the repairs have been completed (after the front panel and cabinet have been installed), perform a test run, and check for smoking, unusual sounds and other abnormalities.
If this check is omitted, a fire and/or electric shocks may occur.
Before proceeding with the test run, install the front panel and cabinet.
- Ensure that the following steps are taken when doing repairs on the refrigerating cycle.
 1. Do not allow any naked flames in the surrounding area.
If a gas stove or other appliance is being used, extinguish the flames before proceeding.
If the flames are not extinguished, they may ignite any oil mixed with the refrigerant gas.
 2. Do not use welding equipment in an airtight room.
Carbon monoxide poisoning may result if the room is not properly ventilated.
 3. Do not bring welding equipment near flammable objects.
Flames from the equipment may cause the flammable objects to catch fire.
- **If keeping the power on is absolutely unavoidable while doing a job such as inspecting the circuitry, wear rubber gloves to avoid contact with the live parts.**
Electric shocks may be received if the live parts are touched.
High-voltage circuits are contained inside this unit.
Proceed very carefully when conducting checks since directly touching the parts on the control circuit board may result in electric shocks.

10-1. Indoor Unit

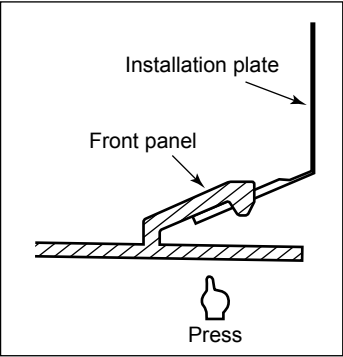
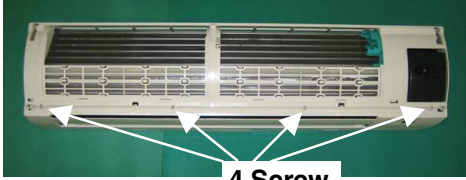
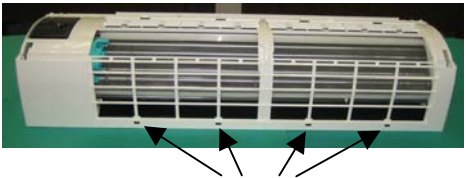
No.	Part name	Procedures	Remarks
①	Front panel	1) Stop operation of the air conditioner and turn off its main power supply. 2) Open the air inlet grille, push the arm toward the outside, and remove the grille. 3) Remove the left and right air filters.	

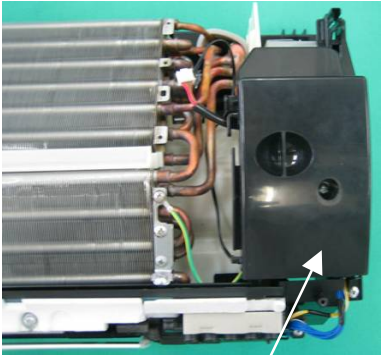
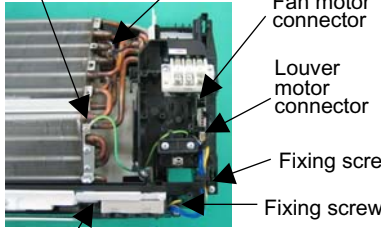
No.	Part name	Procedures	Remarks
①	Front panel	<p>4) Press "PUSH" part under the front panel and remove hooks of the front panel from the installation plate.</p> <p>5) Remove the front panel fixing screws. (4 pcs.)</p> <p>6) Take off four hooks of panel from rear side.</p>  <p><How to assemble the front panel></p> <p>1) Press three center positions and two lower center positions of the air outlet, and then hang the hanging hooks (4 pcs.) at the top side of the front panel to the rear plate.</p> <p>2) Tighten four screws.</p> <ul style="list-style-type: none"> • Incomplete hanging or incomplete pressing may cause a dewdrops. 	  

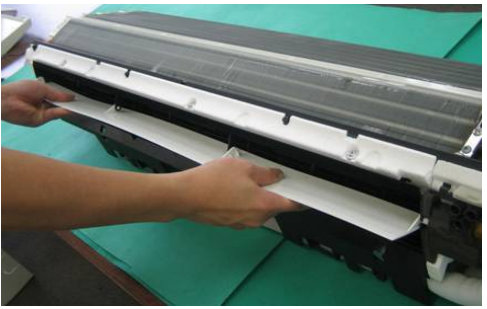
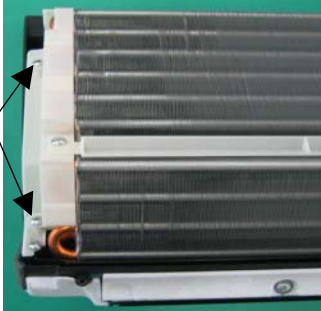
No.	Part name	Procedures	Remarks
②	Electric parts box assembly	<p>1) Remove screw of earth lead attached to the end plate of the evaporator.</p> <p>2) Remove the lead wire cover, and remove connector for the fan motor and connector for the louver motor from the electric parts box assembly.</p> <p>3) Pull out TC sensor from sensor holder of the evaporator.</p> <p>4) Disengage the display unit by simply pushing at the top of the display unit.</p> <p>5) Remove the fixing screw that secures the electric parts box assembly, LED assembly and remove the assembly.</p> <p><How to assemble the electric parts box></p> <p>1) Hook the top part of the electric parts box assembly onto the claws on the back body, and secure it using the fixing screw. Now attach the display unit. Connect the connectors for the fan motor and louver motor.</p> <p>2) Secure the grounding wire using the fixing screw. Insert the TC sensor into the sensor holder.</p> <p>* Be absolutely sure to loop the grounding wire and TC sensor leads once at the bottom.</p>	 <p>Electric part box cover</p>  <p>Earth Screw TC sensor Fan motor connector Louver motor connector Fixing screw Fixing screw LED assembly</p>

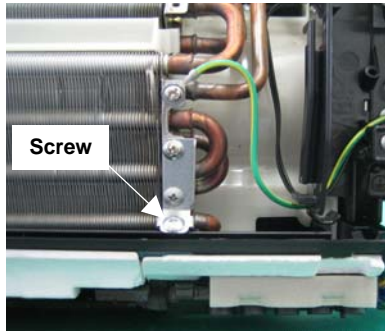

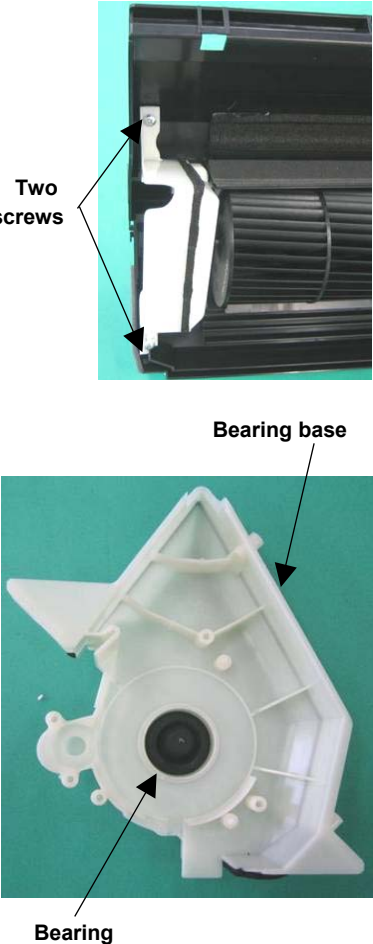

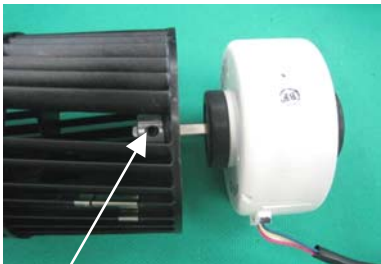
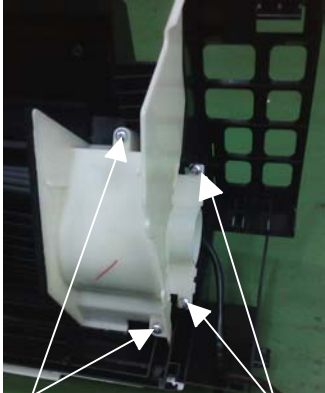
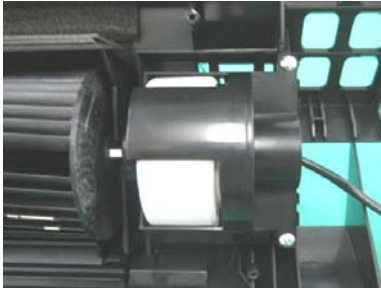
No.	Part name	Procedures	Remarks
③	Horizontal louver	1) Remove shaft of the horizontal louver from the back body. (First remove the left shaft, and then remove other shafts while sliding the horizontal louver leftward.)	
④	Evaporator (Heat exchanger)	1) Follow to the procedure in the item ② . 2) Remove the pipe holder from the rear side of the main unit. 3) Remove two fixing screws at the left side of the end plate of the heat exchanger.  4) Remove two fixing screw on the heat exchange fixing holder to separate the heat exchange from the back body.	  

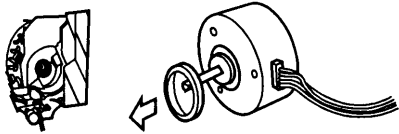
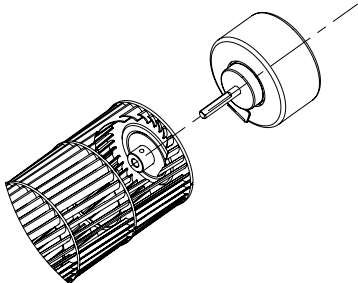
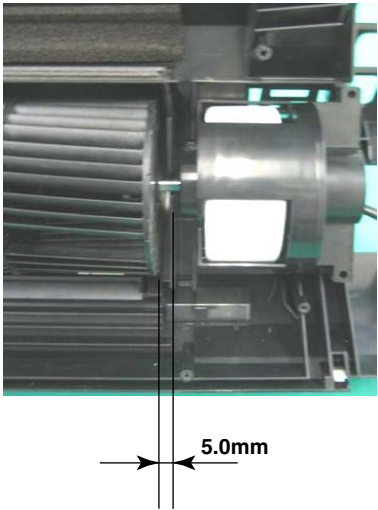
No.	Part name	Procedures	Remarks
⑤	Bearing	<p>1) Follow to the procedure in the item ④.</p> <p>2) Remove the two screws used to secure the bearing base.</p> <p>3) Remove the bearing base.</p> <p><Caution at assembling></p> <ul style="list-style-type: none"> • If the bearing is out from the housing, push it into the specified position and then incorporate it in the main body. 	 <p>The top photograph shows a close-up of the bearing base being removed from a housing. Two screws are indicated by arrows and labeled "Two screws".</p> <p>The bottom photograph shows the bearing base and bearing separated. An arrow points to the "Bearing base" and another arrow points to the "Bearing".</p>

No.	Part name	Procedures	Remarks
⑥	Fan motor	<p>1) Follow to the procedure till item ④.</p> <p>2) Loosen the set screw of the cross flow fan.</p> <p>3) Remove two fixing screws of the motor cover and them remove the motor cover.</p> <p>4) Remove two more fixing screws of the motor band and remove the motor band.</p> <p>5) Pull the fan motor outward.</p>	 <p>Set screw</p>  <p>Two screws on motor cover Two screws on motor band</p> 

No.	Part name	Procedures	Remarks
⑦	Cross flow fan	<p><Caution at reassembling></p> <p>1) To incorporate the fan motor, remove the fan motor rubber (at shaft core side), incorporate the motor into the position in the following figure, and then install the fan motor.</p> <ul style="list-style-type: none"> • Install the cross flow fan so that the right end of the 1st joint from the right of the cross flow fan is set keeping 5 mm from wall of rear plate of the main unit. • Holding the set screw, install the cross flow fan so that U-groove of the fan motor comes to the mounting hole of the set screw.  <ul style="list-style-type: none"> • Perform positioning of the fan motor as follows: • When assembling the fan motor, the fan motor must be installed in such a way that the fan motor leads will be taken out is positioned at the bottom front. • After assembling the two fixing screw of the motor band (right) into the main body, position the fan motor, insert it, and then secure the motor band (right) using the two fixing screws. 	

10-2. Outdoor Unit

No.	Part name	Procedures	Remarks
j	Common procedure	<ol style="list-style-type: none"> 1) Stop the operation of the air conditioner and turn off its main power supply or remove the power supply cord. 2) Remove the packed valve cover and the electrical parts cover (2 screws \varnothing 4 x 10L) 3) Remove 2 cord clamps (4 screws \varnothing 4 x 16L) and disconnect the power supply cord and connecting cable after removing 6 screws on the terminal block and 1 ground screw on the electrical parts base. 4) Remove the top cabinet. (7 screws \varnothing 4 x 10L) (Pulling out upward) 5) Remove the top cabinet. (2 screws \varnothing 4 x 10L) (Pull the front right portion toward you, and remove it pulling out upward) 	<div style="display: flex; flex-direction: column; align-items: center;"> <div style="display: flex; justify-content: space-between; width: 100%;"> Front cabinet Top cabinet </div>  <div style="display: flex; justify-content: space-between; width: 100%;"> 2 screws \varnothing 4 x 10L Side cabinet </div> <p>Packed valve cover</p> <p>2 Cord clamps</p>  <p>4 screws \varnothing 4 x 16L</p>  <p>7 screws \varnothing 4 x 10L</p>  <p>Front cabinet</p> </div>

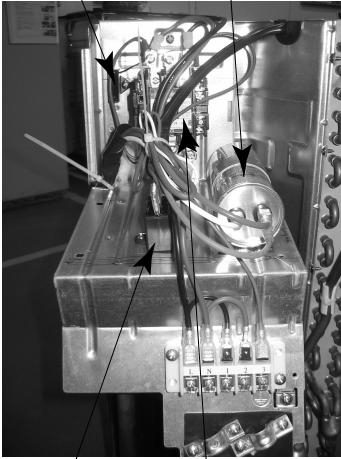
No.	Part name	Procedures	Remarks
②	Running capacitor for compressor	1) Perform the common procedure ① 2) Remove the capacitor band. (1 screw $\varnothing 4 \times 10L$) 3) Disconnect the lead wires from the capacitor terminal.	 <p data-bbox="1089 246 1446 289">Spark killer Running capacitor for compressor</p> <p data-bbox="1089 800 1446 842">Running capacitor for fan motor Magnetic contactor</p> <p data-bbox="1159 863 1344 885">(For 18, 24 Cooling)</p>
③	Running capacitor for fan motor	1) Perform the common procedure ① 2) Remove the fixing screw. (1 screw $\varnothing 4 \times 10L$) 3) Disconnect the lead wires from the capacitor terminal.	
④	Magnetic contactor	1) Perform the common procedure ① 2) Remove the fixing screw. (2 screws $\varnothing 4 \times 18L$) 3) Disconnect the lead wires from the terminal.	
⑤	Spark killer	1) Perform the common procedure ① 2) Remove the fixing screw. (1 screws $\varnothing 4 \times 10L$) 3) Disconnect the lead wires from the terminal.	

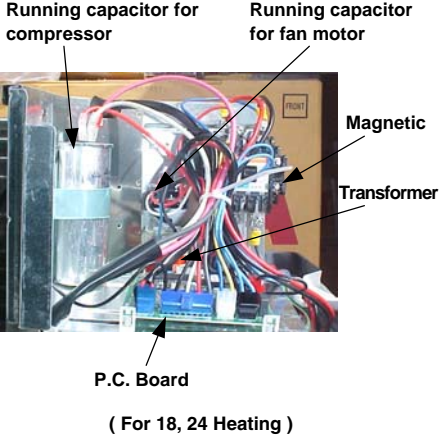
No.	Part name	Procedures	Remarks
②	Running capacitor for compressor	1) Perform the common procedure ① 2) Remove the capacitor band. (1 screw Ø4 x 10L) 3) Disconnect the lead wires from the capacitor terminal.	 <p>(For 18, 24 Heating)</p>
③	Running capacitor for fan motor	1) Perform the common procedure ① 2) Remove the fixing screw. (1 screw Ø4 x 10L) 3) Disconnect the lead wires from the capacitor terminal.	
④	Magnetic contactor	1) Perform the common procedure ① 2) Remove the fixing screw. (2 screws Ø4 x 18L) 3) Disconnect the lead wires from the terminal.	
⑤	Transformer	1) Perform the common procedure ① 2) Remove the fixing screw. (2 screws Ø4 x 10L) 3) Disconnect the housing from the P.C. Board.	
⑥	Transformer	1) Perform the common procedure ① 2) Disconnect the lead wires from the P.C. Board. 3) Remove P.C.Board after unhooking 4 clams.	

11. EXPLODED VIEWS AND PARTS LIST

11-1. Indoor Unit (E-Parts Assy)

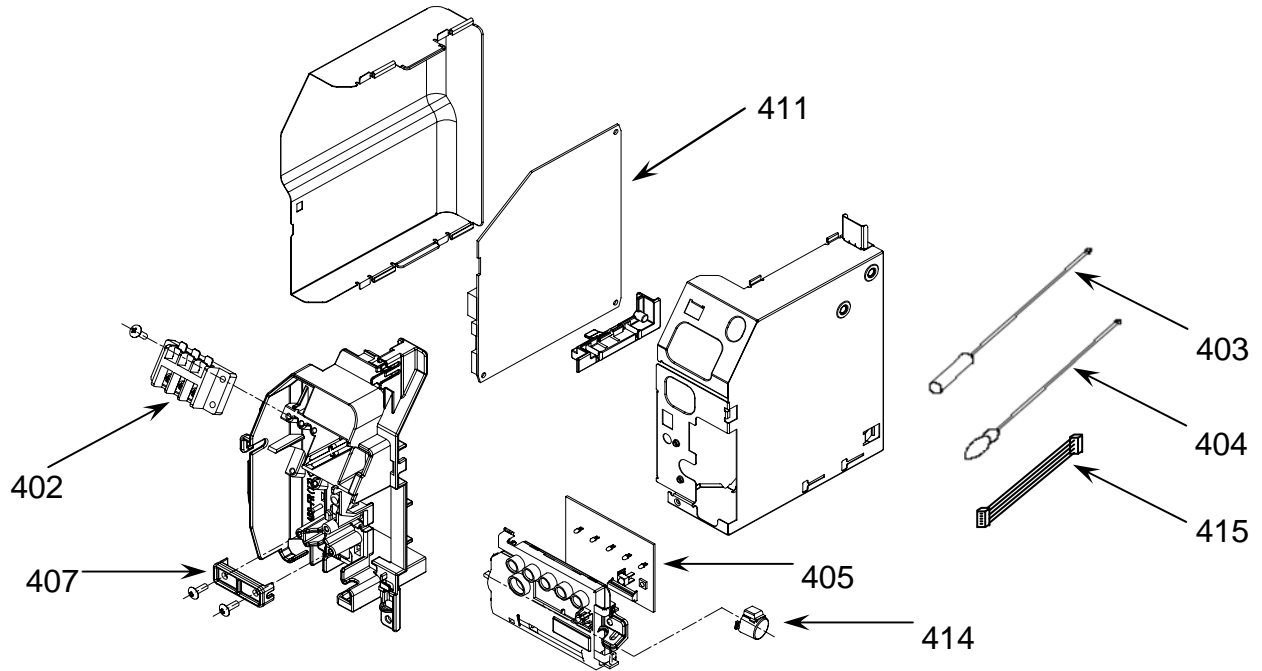

Location No.	Part No.	Description	Location No.	Part No.	Description
402	43T60331	TERMINAL; 3P	411	43T69820	PC BOARD (For RAS-18SKP-ES)
403	43T50004	SENSOR; HEAT EXCHANGER	411	43T69821	PC BOARD (For RAS-24SKP-ES)
404	43T69005	SENSOR; THERMOSTAT	411	43T69822	PC BOARD (For RAS-24SKHP-ES)
405	43T69736	PC BOARD ASSY; WRS-LED	414	43T69747	ASM-STEPPING-MOTOR
407	43T62003	CORD CLAMP	415	43T60386	MOTOR CORD
411	43T69816	PC BOARD (For RAS-18SKHP-ES)			

11-2. Indoor Unit

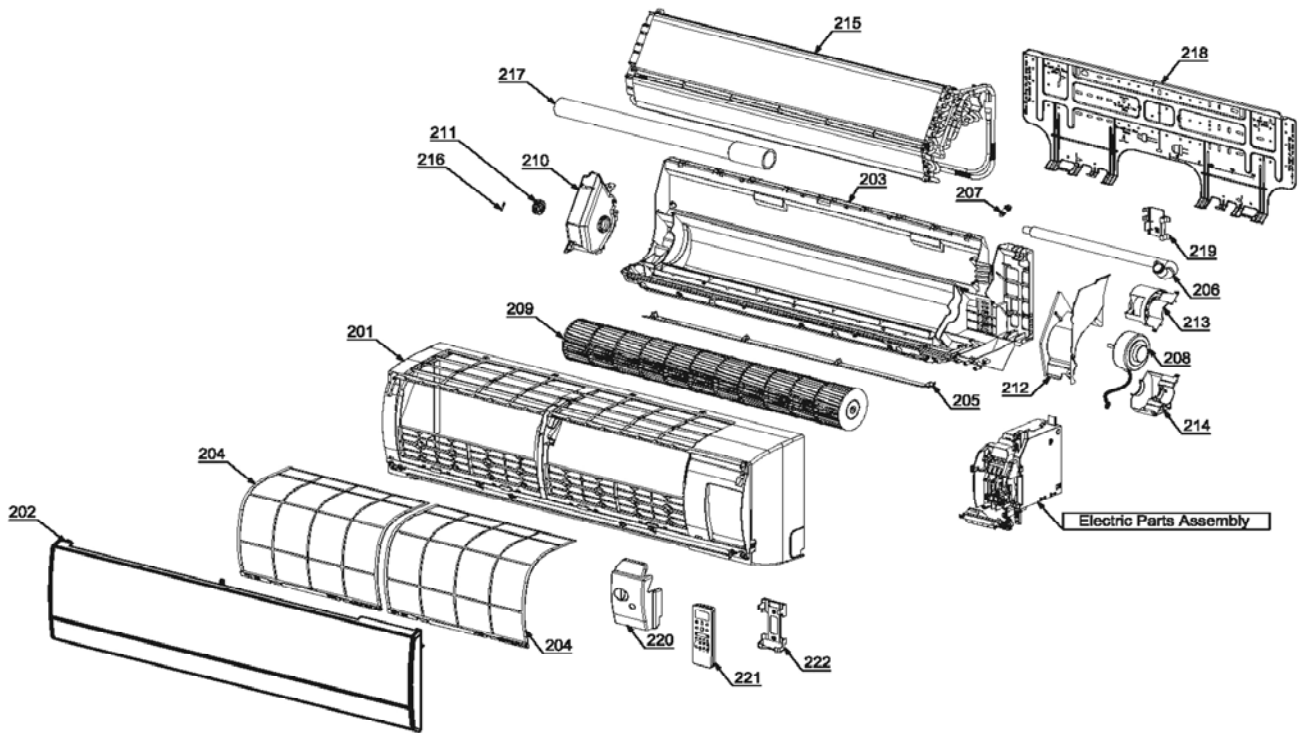

Location No.	Part No.	Description	Location No.	Part No.	Description
201	43T00524	FRONT PANEL ASSY (For RAS-18,24SKP-ES)	211	43T22312	BEARING ASSY, MOLD
201	43T00525	FRONT PANEL ASSY (For RAS-18,24SKHP-ES)	212	43T39020	BAND, MOTOR, LEFT
202	43T09445	GRILLE OF AIR INLET ASSY	213	43T39022	BAND, MOTOR, RIGHT UP
203	43T03374	BACK BODY ASSY (For RAS-18,24SKP-ES)	214	43T39023	BAND, MOTOR, RIGHT DOWN
203	43T03377	BACK BODY ASSY (For RAS-18,24SKHP-ES)	215	43T44429	REFRIGERANT CYCLE ASSEMBLY
204	43T80019	AIR FILTER	216	43T19333	HOLDER, SENSOR
205	43T09040	LOUVER, HORIZONTAL	217	43T49010	PIPE, SHIELD
206	43T70313	HOSE, DRAIN	218	43T82008	PLATE, INSTALLATION
207	43T79313	CAP, DRAIN	219	43T49043	HOLDER, PIPE
208	43T21371	MOTOR, FAN	220	43T62031	COVER, TERMINAL
209	43T20016	FAN, ASSY, CROSS FLOW	221	43T69615	WIRELESS REMOTE CONTROL (For RAS-18,24SKHP-ES)
210	43T39335	BASE BEARING ASSY	221	43T69616	WIRELESS REMOTE CONTROL (For RAS-18,24SKP-ES)
			222	43T83003	HOLDER, REMOTE CONTROL

11-3. Outdoor Unit (RAS-18SA-ES, RAS-24SA-ES)

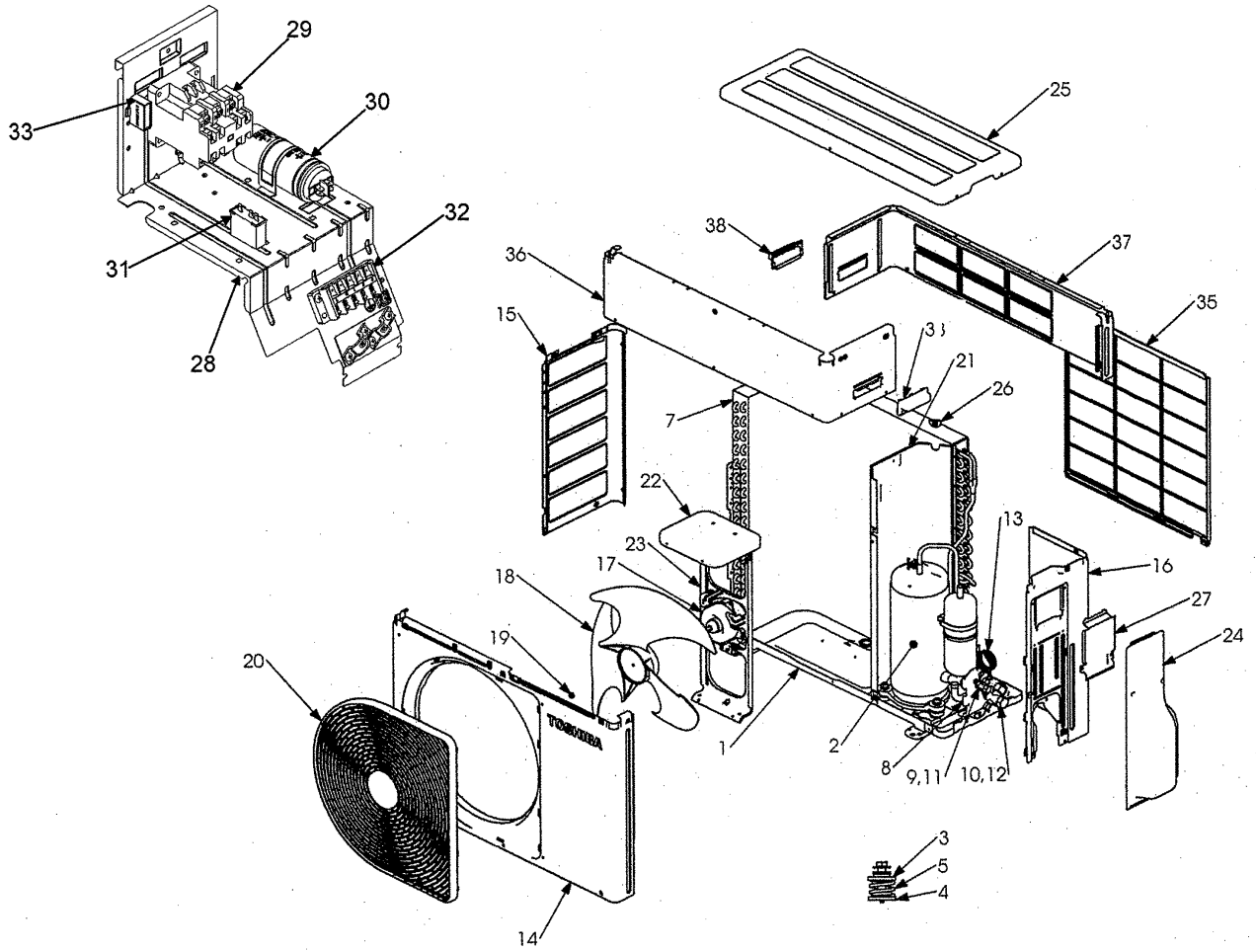

Location No.	Part No.	Description	Location No.	Part No.	Description
1	43T42324	BASE PLATE ASSEMBLY	21	43T04302	PARTITION
2	43T41427	COMPRESSOR;PA200X2CS-4KU1 (For RAS-18SA-ES)	22	43T39333	MOTOR BASE CONNECTION PLATE
2	43T41428	COMPRESSOR;PA270X3CS-4MU2 (For RAS-24SA-ES)	23	43T39318	MOTOR BASE
3	43T49011	SPRING BASE(UPPER)	24	43T19330	PACKED VALVE COVER
4	43T49336	SPRING BASE (LOWER)	25	43T00521	UPPER CABINET ASSEMBLY
5	43T49019	SPRING; BUFFER	26	43T96305	BUSHING
7	43T43439	CONDENSER ASSEMBLY (For RAS-18SA-ES)	27	43T62330	ELECTRIC PART COVER ASSEMBLY
7	43T43440	CONDENSER ASSEMBLY (For RAS-24SA-ES)	28	43T61311	ELECTRIC PARTS BASE
8	43T00448	FIXING PLATE VALVE	29	43T52312	SWITCH;MAGNET; CLK-26J-S649 (For RAS-18SA-ES)
9	43T46332	VALVE;PACKED 6.35 DIA	29	43T52309	SWITCH;MAGNET; CLK-35J-S649 (For RAS-24SA-ES)
10	43T46335	VALVE;PACKED 12.7 DIA (H4)	30	43T55352	MF CAPACITOR (For RAS-18SA-ES)
11	43T47331	BONNET, 6.35 DIA	30	43T55354	MF CAPACITOR (For RAS-24SA-ES)
12	43T47333	BONNET, 12.70 DIA	31	43T55321	CAPACITOR;PLASTIC-FILM (For RAS-24SA-ES)
13	43T47013	CAPILLARY TUBE; 2.0 DIA	31	43T55341	CAPACITOR;PLASTIC-FILM (For RAS-18SA-ES)
14	43T00468	FRONT CABINET	32	43T60387	TERMINAL BLOCK;5P
15	43T00474	LEFT CABINET	33	43T33002	SPARK-KILLER
16	43T00454	RIGHT CABINET	35	43T19331	FIN GUARD
17	43T21377	FAN MOTOR;AC220-240V 50Hz	36	43T00456	UPPER FRONT CABINET; A
18	43T20319	PROPELLER FAN	37	43T00457	UPPER FRONT CABINET; B
19	43T47001	NUT FLANGE	38	43T71301	HANDLE
20	43T19329	FAN GUARD			

11-4. Outdoor Unit (RAS-18S2AH-ES, RAS-24S2AH-ES)

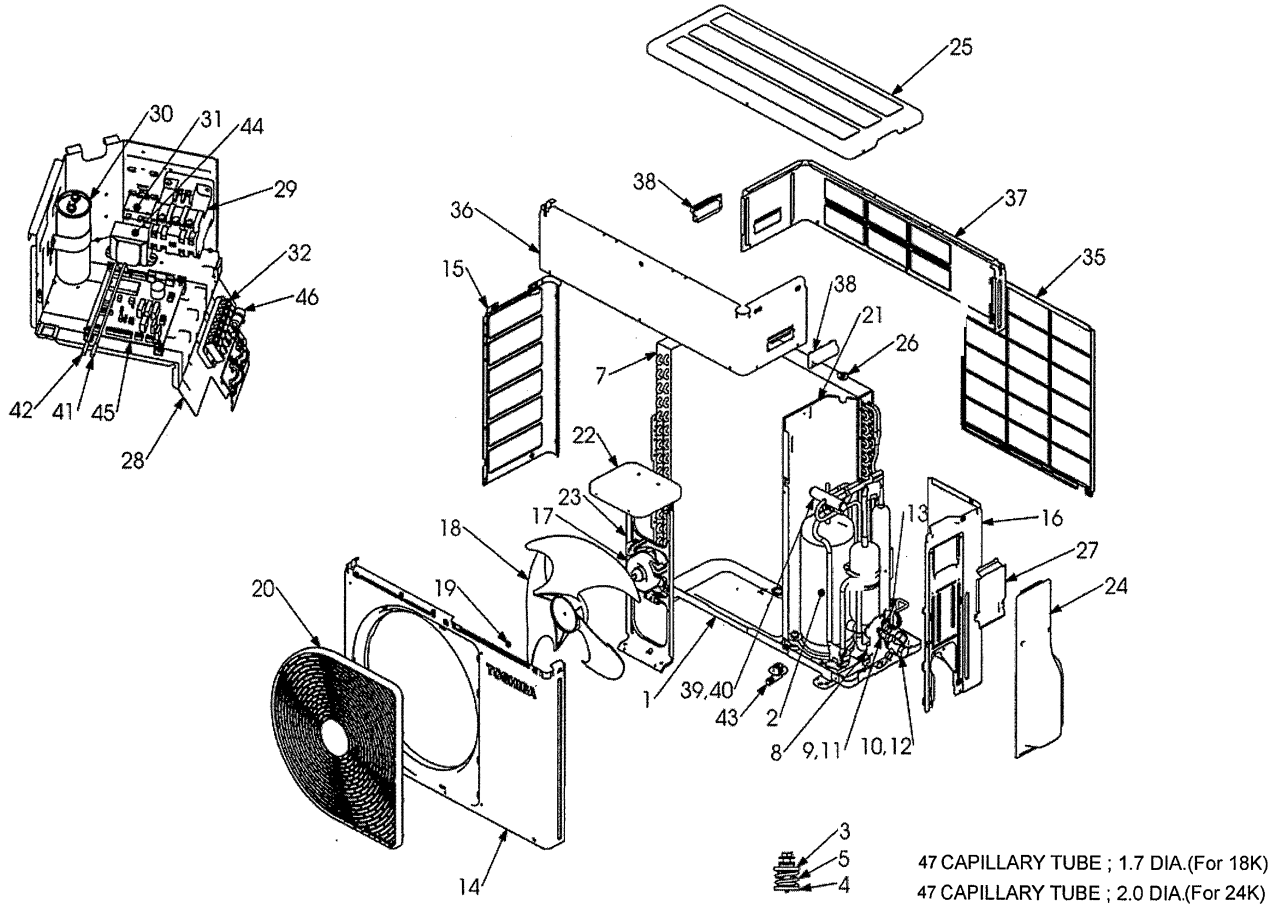

Location No.	Part No.	Description	Location No.	Part No.	Description
1	43T42324	BASE PLATE ASSEMBLY	26	43T96305	BUSHING
2	43T41427	COMPRESSOR;PA200X2CS-4KU1 (For RAS-18S2AH-ES)	27	43T62330	ELECTRIC PART COVER ASSEMBLY
2	43T41428	COMPRESSOR;PA270X3CS-4MU2 (For RAS-24S2AH-ES)	28	43T61306	ELECTRIC PARTS BASE
3	43T49011	SPRING BASE(UPPER)	29	43T52309	SWITCH;MAGNET; CLK-35J-S649 (For RAS-24S2AH-ES)
4	43T49336	SPRING BASE (LOWER)	29	43T52312	SWITCH;MAGNET; CLK-26J-S649 (For RAS-18S2AH-ES)
5	43T49019	SPRING; BUFFER	30	43T55352	MF CAPACITOR (For RAS-18S2AH-ES)
7	43T43391	CONDENSER ASSEMBLY	30	43T55354	MF CAPACITOR (For RAS-24S2AH-ES)
8	43T00448	FIXING PLATE VALVE	31	43T55341	CAPACITOR;PLASTIC-FILM
9	43T46332	VALVE;PACKED 6.35 DIA	32	43T60387	TERMINAL BLOCK;5P
10	43T46335	VALVE;PACKED 12.7 DIA (H4)	35	43T19331	FIN GUARD
11	43T47331	BONNET, 6.35 DIA	36	43T00456	UPPER FRONT CABINET; A
12	43T47333	BONNET, 12.70 DIA	37	43T00457	UPPER FRONT CABINET; B
13	43T47013	CAPILLARY TUBE; 2.0 DIA	38	43T71301	HANDLE
14	43T00468	FRONT CABINET	39	43T46337	4 WAY VALVE
15	43T00474	LEFT CABINET	40	43T46339	COIL;V-4WAY;AC220-240V 50Hz
16	43T00454	RIGHT CABINET	41	43T50322	SENSOR; TC
17	43T21378	FAN MOTOR;AC220-240V 50Hz	42	43T50323	SENSOR; TD
18	43T20319	PROPELLER FAN	43	43T79305	DRAIN NIPPLE
19	43T47001	NUT FLANGE	44	43T58301	TRANSFORMER; TT-05
20	43T19329	FAN GUARD	45	43T69580	PC BOARD
21	43T04302	PARTITION	46	43T60325	FILTER;CLAMP
22	43T39333	MOTOR BASE CONNECTION PLATE	47	43T47013	CAPILLARY TUBE; 2.0DIA (For RAS-24S2AH-ES)
23	43T39318	MOTOR BASE	47	43T47014	CAPILLARY TUBE; 1.7DIA (For RAS-18S2AH-ES)
24	43T19330	PACKED VALVE COVER			
25	43T00521	UPPER CABINET ASSEMBLY			

TOSHIBA CARRIER (THAILAND) CO., LTD.

144/9 MOO 5, BANGKADI INDUSTRIAL PARK, TIVANON ROAD, TAMBOL BANGKADI,
AMPHUR MUANG, PATHUMTHANI 12000, THAILAND.