

PXDM6A / PXDM10A

Multipurpose controller for variable voltage 3 ~ fans

Operating Instructions



Software version: D2499A from Version 02.03

Content

1	General notes	5
1.1	Structure of the operating instructions	5
1.2	Target group	5
1.3	Exclusion of liability	5
1.4	Copyright	5
2	Safety instructions	5
2.1	Intended use	5
2.2	Explanations of symbols	5
2.3	Product safety	6
2.4	Requirements placed on the personnel / due diligence	6
2.5	Start-up and during operation	6
2.6	Work on the device	6
2.7	Modifications / interventions in the device	7
2.8	Operator's obligation of diligence	7
2.9	Employment of external personnel	7
3	Product overview	7
3.1	Operational area	7
3.2	Maintenance	7
3.3	Transport	7
3.4	Storage	8
3.5	Disposal / recycling	8
4	Mounting	8
4.1	General notes	8
4.2	Minimum space requirement	8
4.3	Outdoor installation	8
4.4	Installation location for agriculture	9
4.5	Temperature influences during commissioning	9
5	Electrical installation	9
5.1	Safety precautions	9
5.2	EMC-compatible installation	9
5.2.1	Motor cable	9
5.2.2	Signal cable	9
5.2.3	Harmonics current for devices ≤ 16 A	9
5.3	Mains connection	10
5.3.1	Line voltage	10
5.3.2	Required quality attributes for the mains voltage	10
5.3.3	Operating in IT-System	10
5.4	Residual-current-operated protective device	10
5.5	Motor connection	10
5.5.1	Running noise	10
5.6	Motor protection	11
5.7	Signal connection or sensor connection to analog inputs (Analog In 1, Analog In 2) ..	11
5.8	Output voltage 0 - 10 V (Analog Out)	11
5.9	Voltage supply for external devices (+24 V, GND)	11
5.10	Add-on module type Z-Modul-B Part-No. 380052	12
5.11	Digital inputs (D1, D2)	12
5.12	Relay outputs (K1, K2)	12
5.13	Communication	12
5.13.1	Networking via MODBUS-RTU	12
5.13.2	RS-485 - network design and interface parameter	12

5.13.3	USB-interface	13
5.13.4	LON® Bus system is possible via add-on module	13
5.14	Potential at control voltage connections	13
6	Controls and Menu	14
6.1	Multipurpose LC display and keyboard	14
6.2	Menu operation	14
6.3	Menu structure	15
6.4	Example for programming mode 2.01 in “Base setup”	15
7	Base setup	16
7.1	Select operation mode	16
7.2	External Setpoint / External speed setting in manual operation	17
8	Start-up	18
8.1	Prerequisites for commissioning	18
8.2	Procedure for commissioning	18
8.3	Menu Mode 4.02	18
9	Programming	19
9.1	Speed controller 1.01	19
9.1.1	Base setup 1.01	19
9.1.2	Setting for operation 1.01	19
9.2	Temperature control 2.01... 2.05	20
9.2.1	Basic setting 2.01... 2.05	20
9.2.2	Settings for operation modes 2.01... 2.05	21
9.2.3	Functional diagrams temperature control	22
9.2.4	Additional for mode 2.03 : Signal output 0 - 10 V	23
9.2.5	For mode 2.03 : Relay output for Heating or Cooling	24
9.2.6	For mode 2.03 Relay output for temperature monitoring	25
9.3	Pressure control for condensers refrigeration 3.01... 3.04	26
9.3.1	Base setup 3.01... 3.04	26
9.3.2	Setting for operation modes 3.01... 3.04	27
9.3.3	Functional diagrams pressure control condensers	28
9.4	Pressure control airconditioning 4.01... 4.03	29
9.4.1	Base setup 4.01... 4.03	29
9.4.2	Setting for operation modes 4.01... 4.03	30
9.5	Volume control 5.01 and 5.02	31
9.5.1	Basic setting 5.01 and 5.02	31
9.5.2	Setting for operation modes 5.01... 5.02	32
9.6	Air velocity control 6.01	33
9.6.1	Base setup 6.01	33
9.6.2	Settings for operation modes 6.01	34
9.7	Menu group Start	35
9.8	Menu group Info	35
9.9	Controller Setup	36
9.9.1	PIN protection activate, PIN 0010	36
9.9.2	PIN protection activate, PIN 1234	36
9.9.3	Save user settings restore with PIN 9090	37
9.9.4	Sensor Alarm ON / OFF	37
9.9.5	Limit	37
9.9.6	Minimum speed cut off	38
9.9.7	Second Group	38
9.9.8	Reverse action of the control function	39
9.9.9	Controller configuration	39
9.9.10	Data on the total control deviation	40
9.10	IO Setup	40
9.10.1	Analog-Output “A”	40

9.10.2	Digital inputs “D1” / “D2”	41
9.10.2.1	Menu overview	41
9.10.2.2	Enable ON/OFF function 1D	42
9.10.2.3	External fault Function 2D	42
9.10.2.4	Limit ON / OFF, Function 3D	42
9.10.2.5	Switch over Input signal “E1” / “E2”, Function 4D	43
9.10.2.6	Set 1/2 or Setpoint 1/2, Function 5D	43
9.10.2.7	Intern / Extern Function 6D	44
9.10.2.8	Automatic control / speed manual, Function 7D (mode 2.01)	45
9.10.2.9	Reverse action of control function (2.01), Function 8D	45
9.10.2.10	Reset, Function 10D	45
9.10.2.11	Setting Max. Speed ON / OFF function 11D	46
9.10.2.12	Motorheating ON / OFF, Function 12D	46
9.10.2.13	“Freeze function” = maintain momentary modulation value, Function 14D	46
9.10.3	Inverting analog inputs “E1” / “E2”	47
9.10.4	Function and inverting for relay outputs “K1” and “K2”	47
9.10.5	Programming Add-on module type Z-Modul-B	49
9.10.6	Networking via MODBUS	49
9.11	Limits	50
9.11.1	Limit indication depending on modulation	50
9.11.2	Limit indication depending on setting or sensor signal	51
9.11.3	Limit indication depending on (offset) to Setpoint	52
9.12	Motor Setup	53
9.12.1	Adjusting of CosPhi for motor	53
9.12.2	Setting for Rampup time and Rampdown time	53
9.12.3	Suppression of speeds	54
9.12.4	Motorheating	54
10	Menu tables	55
10.1	Menus of operating modes	55
10.2	Possible allocation of the IOs, PINs	60
11	Diagnostics menu	62
12	Events / Fault signals	63
12.1	Display and query of events and malfunctions	63
12.2	Messages and trouble shooting	64
13	Enclosure	66
13.1	Technical data	66
13.1.1	Performance reduction during elevated ambient temperatures	67
13.2	Connection diagram	68
13.2.1	Connection suggestion for several motors with motor protection unit type STDT	69
13.3	Dimensions [mm]	69
13.4	Index	70
13.5	Manufacturer reference	71

1 General notes

1.1 Structure of the operating instructions

**Before installation and start-up, read this manual carefully to ensure correct use!
We emphasize that these operating instructions apply to specific units only, and are in no way valid for the complete system!**

Use these operating instructions to work safely with and on the device. They contain safety instructions that must be complied with as well as information that is required for failure-free operation of the device.

Keep these operating instructions together with the device. It must be ensured that all persons that are to work on the device can refer to the operating instructions at any time.

Keep the operating instructions for continued use. They must be passed-on to all successive owners, users and final customers.

1.2 Target group

The operating instructions address persons entrusted with planning, installation, commissioning and maintenance and servicing and who have the corresponding qualifications and skills for their job.

1.3 Exclusion of liability

Concurrence between the contents of these operating instructions and the described hardware and software in the device has been examined. It is still possible that non-compliances exist; no guarantee is assumed for complete conformity. To allow for future developments, construction methods and technical data given are subject to alteration. We do not accept any liability for possible errors or omissions in the information contained in data, illustrations or drawings provided.

We accept no liability for damage caused by misuse, incorrect use, improper use or as a consequence of unauthorized repairs or modifications.

1.4 Copyright

These operating instructions contain copyright protected information. The operating instructions may be neither completely nor partially photocopied, reproduced, translated or put on data medium without previous explicit consent. Infringements are liable for damages. All rights reserved, including those that arise through patent issue or registration on a utility model.

2 Safety instructions

This chapter contains instructions to prevent personal injury and property damage. These instructions do not lay claim to completeness. In case of questions and problems, please consult our company technicians.

2.1 Intended use

The equipment is to be used solely for the purposes specified and confirmed in the order. Other uses which do not coincide with, or which exceed those specified will be deemed unauthorised unless contractually agreed. Damages resulting from such unauthorised uses will not be the liability of the manufacturer. The user will assume sole liability.

Reading these operating instructions and complying with all contained instructions - especially the safety notifications contained therein - are considered part of intended use. To consider is also the manual of attached components. Not the manufacturer, rather the operator of the device is liable for any personal harm or material damage arising from non-intended use!



2.2 Explanations of symbols

Safety instructions are highlighted with warning triangles and are depicted according to the degree of hazard as follows.



Attention!

General hazardous area. Death or severe injury or significant property damage can occur if the corresponding precautions are not taken!

	Danger due to electric current Warning of dangerous voltage or dangerous current.
	Information Important additional information and advice for user.

2.3 Product safety

The device conforms to the state of the art at the time of delivery and is fundamentally considered to be reliable. The device and its accessories must only be used in a flawless condition and installed and operated in compliance with the assembly instructions and/or operating instructions. Operating outside the device's technical specifications (☞ rating plate and attachment / technical data) can lead to a defect in the device and additional damage!

In the case of a malfunction or a failure of the equipment check all functions with alarms in order to prevent injury to persons or property. Note possibility of back-up operation. If used in intensive animal environments, any malfunctions in the air supply must be detected as soon as possible to prevent the development of a life-threatening situation for the animals. The design and installation of the system must comply with local regulations and directives. In Germany these include DIN VDE 0100, the animal protection and the keeping of working animals ordinance and the pig-keeping ordinance etc. Also note the instructions of AEL, DLG, VdS.

2.4 Requirements placed on the personnel / due diligence

Persons entrusted with the planning, installation, commissioning and maintenance and servicing in connection with the frequency inverter must have the corresponding qualifications and skills for these jobs.

In addition, they must be knowledgeable about the safety regulations, EU directives, rules for the prevention of accidents and the corresponding national as well as regional and in-house regulations. Personnel to be trained or instructed and apprentices are only permitted to work on the device under the supervision of an experienced person. This also applies to personnel undergoing general training. Comply with the legal minimum age.

This device is not intended to be used by people (including children) who have restricted mental, sensory or intellectual abilities or who have a lack of experience and/or knowledge.

2.5 Start-up and during operation



Attention!

- During commissioning, unexpected and hazardous conditions can arise in the entire installation due to defective adjustments, defective components or incorrect electrical connections. Remove all persons and objects from the hazardous area.
- During operation, the device must be closed or installed in a control cabinet. Fuses may only be replaced by new ones and must not be repaired or bypassed. The data for the maximum line fuse are to be considered absolutely (☞ Technical data). Use only fuses specified in schematic diagrams.
- Any faults detected in the electric system/modules/operating equipment must be corrected immediately. If these faults are not corrected, the device/system is potentially very dangerous. The device/system must therefore not be operated when it is faulty.
- Pay attention to smooth, low vibration running of the motor/fan, the appropriate instructions in the drive documentation must be observed!

2.6 Work on the device



Information

Mounting, electrical connection, and start-up operation may only be carried out by an electrical specialist in accordance with electrotechnical regulations (e.g. EN 50110 or EN 60204)!

**Danger due to electric current**

It is generally forbidden to carry out work on electrical live parts. Protection class of the device when open is IP 00! It is possible to touch hazardous voltages directly!

The safe isolation from the supply must be checked using a **two-pole** voltage detector.

**Attention!**

Automatically restart after a power failure or mains disconnection!

2.7 Modifications / interventions in the device

**Attention!**

For reasons of safety, no unauthorized interventions or modifications may be made on the device. All planned modifications must be authorized by the manufacturer in writing.

Only use the manufacturer's original spare parts / wearing parts / accessories. These parts are specially designed for this device. If parts from other sources are used, there is no guarantee that they are designed and produced for the proper loads and with the required level of safety. Parts and special equipment not supplied by the manufacturer are not approved for use.

2.8 Operator's obligation of diligence

- The contractor or owner must also ensure that the electric systems and equipment are operated and maintained in accordance with electro-technical regulations.
- The owner is obliged to ensure that the device are operated in perfect working order only.
- The device may only be used as intended (☞ "Application").
- You must periodically examine the safety equipment for their properly functioning condition.
- The assembly instructions and/or operating instructions are always readily available at the location where the device is being used, are complete and are in legible condition.
- These persons are regularly instructed in all applicable questions regarding occupational safety and environmental protection and are knowledgeable regarding the assembly instructions and/or operating instructions and, especially, are familiar with the safety instructions contained therein.
- All safety and warning notices attached to the device are never removed and remain legible.

2.9 Employment of external personnel

Maintenance and service work are frequently carried out by external employees who often do not recognize the specific situations and the thus resulting dangers. These persons must be comprehensively informed about the hazards in their area of activity.

You must monitor their working methods in order to intervene in good time if necessary.

3 Product overview

3.1 Operational area

The controller described is used for continuous speed adjustment on variable voltage 3~ motors used to drive ventilators or pumps.

3.2 Maintenance

The device must be checked for soiling and, if necessary, cleaned in periodic intervals.

3.3 Transport

- The device is packed ex factory to suit the transport method previously agreed.
- Always use the original packaging materials when transporting the device.
- Avoid shocks and impacts to the device during the transport.
- During manual handling the human lifting and carrying restrictions must be observed and adhered to.

3.4 Storage

- The device must be stored in its original packaging in a dry and weather-proof room.
- Avoid exposure to extreme heat and cold.
- Avoid over-long storage periods (we recommend a maximum of one year).

3.5 Disposal / recycling

Disposal must be carried out professionally and environmentally friendly in accordance with the legal stipulations.

4 Mounting

4.1 General notes



Attention!

The following points must be complied with during the mechanical installation to avoid causing a defect in the device due to assembly errors or environmental influences:

- Before installation remove the device from the packing and check for any possible shipping damage!
- Assemble the device on a clean and stable base. Do not distort during assembly! Use the appropriate mounting devices for proper installation of the unit!
- Do not mount equipment on vibrating base!
- When mounted onto lightweight walls, there must be no impermissibly high vibrations or shock loads. Any banging shut of doors that are integrated into these lightweight walls, can result in extremely high shock loads. Therefore, we advise you to decouple the devices from the wall.
- Do not allow drilling chips, screws and other foreign bodies to reach the device interior!
- The device should be installed in a location where it will not be disturbed, but at the same time can be easily accessed!
- Depending on the housing model use supplied stoppers for cable inlets, cut off necessary cable inlets respectively to the cable diameter. Or alternative use cable inlet for cable glands. Any cable ducts openings not used must be sealed!
- Care must be taken to avoid direct radiation from the sun!
- The device is designed for vertical installation (cable inlet down). A horizontal or reclined installation is only permissible after technical release of the manufacturer!
- Be sure to observe proper heat dissipation (☞ Technical data, heat dissipation).

4.2 Minimum space requirement

In order to ensure sufficient ventilation of the device, clearance on all sides of at least 50 mm has to be maintained to the housing walls, switch cabinet doors, wiring ducts, etc. The same clearance applies to the installation of several devices next to each other.

When installing several devices on top of each other, the danger of reciprocal heating exists. This layout is only then permissible when the air suctioned from the upper unit does not become warmer than the permissible ambient temperature (☞ Technical data). I.e., a correspondingly larger clearance or thermal shielding is required.

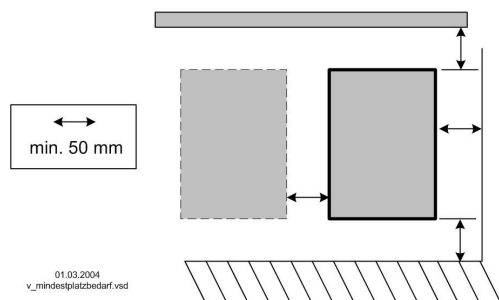

4.3 Outdoor installation

Outdoor installation is possible up to -20 °C when the controller supply is not switched off. Installation must be protected from the effects of weather as much as possible, including protection from direct sunlight!

4.4 Installation location for agriculture

In order to avoid damage caused by ammoniac vapours, the controller shall not be installed in the stable, but rather in an outhouse wherever possible.

4.5 Temperature influences during commissioning

Avoid condensation in the controller and functional faults attributable to condensation by storing the controller at room temperature!

5 Electrical installation

5.1 Safety precautions



Danger due to electric current

- Work on electric components may only be carried out by trained electricians or by persons instructed in electricity under the supervision of an electrician in accordance with electrical engineering regulations.
- It is forbidden to carry out work on electrically live parts.
- A second person must always be present when working on energized parts or lines who disconnects in case of emergency.
- Inspect electrical equipment periodically: retighten loose connections – immediately replace damaged lines and cables.
- Always keep switch cabinets and all electrical supply facilities locked. Access is only allowed for authorized persons using a key or special tool.
- Operating the device with the housing cover removed is prohibited because energized, exposed parts are present inside the device. Disregarding this regulation can lead to severe personal injury.
- The required protective earth connection is established using screws between the housing parts in metal terminal space covers and housing casings. Commissioning is only permissible after these screws have been properly attached!
- Metal screwed-connections are not permitted in plastic housing parts because there is no potential equalization.
- Never clean electrical equipment with water or similar liquids.



Information

The respective connections are represented in the enclosure of this manual (☞ Connection diagram)!

5.2 EMC-compatible installation

5.2.1 Motor cable

The applicable standard for interference emissions is EN 61000-6-3. Compliance with this standard is achieved through the use of an unscreened motor feed cable.

5.2.2 Signal cable

Pay attention to sufficient distance from powerlines and motor wires to prevent interferences. The control cable may not be longer than 30 m. Screened control cables must be used when the cable length is longer than 20 m. When using a shielded cable connect the shielding to one side only, i.e. only to the control unit with the protective ground (keep cable short and with as little inductance as possible!).

5.2.3 Harmonics current for devices ≤ 16 A

According to EN 61000-3-2 the devices are to be classified as “professional” devices. The application is therefore limited to use by trade, certain vocations or industries.

Connection to a low voltage supply (public networks) is allowed insofar as this has been clarified with the respective energy supply company responsible.

Note: up to a maximum current of approx. 4 A, the limits are adhered to with no restrictions.

Exception for Germany: An energy provider follows the technical connection conditions of the TAB2007, in which case the use of phase angle controlled devices up to a rating of 3.4 kVA per phase is allowed.

5.3 Mains connection

5.3.1 Line voltage

Power from the mains is connected to terminals: PE, L1, L2, L3 and N. Here, it must be strictly observed that the mains voltage lies within the allowable tolerance specifications (☞ Technical data and nameplate affixed to the side).

The neutral conductor connection “N” is only for the leakage currents` s reduction. It is of no significance for the fuction of the device. The connection is not applicable for power supply networks without a neutral conductor.

5.3.2 Required quality attributes for the mains voltage



Danger due to electric current

The mains voltage must comply with the EN 50160 quality characteristics and the defined standard voltages in IEC 60038!

5.3.3 Operating in IT-System

In the IT-System the neutral point of voltage supply is not grounded; in the case of a short-circuit between a phase (e.g. “L1”) and protective earth “PE” becomes the protective earth potential = “L1”.

In order to ensure a trouble free operation in this case:

1. the “GND” potential of the control ports have to be connected with the protective grounding potential.
2. the “N” lead must not be connected.

As consequence of the connection between “GND” potential of the control ports with protective earth potential, the following must be considered (exception floating relay contacts):

1. connection only with wires, suitable for mains voltage and surrounding area.
2. connection with suitable isolated amplifiers only.

5.4 Residual-current-operated protective device



Danger due to electric current

Owing to possible leakage currents occurring when the device is switched on, it is advisable to use short-time-delayed current-operated circuit-breakers. This prevents any triggering by mistake.

Plants without neutral conductor connection ☞ Mains connection.

5.5 Motor connection

The motor leads are connected to the terminals: PE, U, V, W. Several fans can be connected to the controller-the maximum total current of all motors (maximum rated current for electronic control of the voltage) must not exceed the current rating for the controller.

If the maximum control current for electronic voltage regulation is not known, a supplementary of the rated motor current must be made.

Typical is this for 2- and 4-pole motors at approx. 25 %, for 6-pole motors at approx. 20 %, for 8- and 10-pole motors at approx. 15 % and higher pole motors at approx. 5 %.

When controlling motors from other manufacturers, the controllability and the maximum current for electronic voltage regulation should be requested from the manufacturer.



Information

It is recommended that a separate motor protection unit be foreseen for each fan.

5.5.1 Running noise

When controlling ventilators using electronic voltage regulators, motor noise can occur (due to the system), which can be troublesome.

On fast running ventilators with a high level of air noise, this noise is relatively low. On slow running ventilators with a low level of air noise, this noise may be dominant in the lower speed range due to the occurrence of resonance.

For systems where noise is critical, we recommend using our frequency inverters with integrated sinusoidal filter.

5.6 Motor protection

Motor protection is possible by connecting thermostats “TB” (thermal contacts) or thermistors “TP” (PTC).

- When several motors are connected ensure that the thermal contacts “TB” or PTC resistors “TP” are always connected in series. A maximum of six individual thermistors (DIN 44081 or DIN 44082) may be connected in series to a single device. Depending on the motor type, at least two or three individual sensors are built in.
- Monitoring of motors in Ex zones is not permissible. For systems of this type, an additional posistor tripping unit is required, with disconnection via a separate motor protection circuit.

The unit switches off when a connected thermostat or thermistor has tripped the circuit (interruption between both terminals “TB/TP” or “TK/PTC”). The unit then remains switched off. A programmed fault-indicating relay is triggering.



Display during motor fault

Possibilities for re-starting after the drive has cooled down terminals “TB/TP” or “TK/PTC” by:

- By switching the mains voltage off and then on again.
- By simultaneously depressing the three keys: **P**, **▲**, **▼** (if a fault is indicated).
- By digital input for remote (enable ON/OFF) or by Reset-input (☞ IO Setup - Digital Inputs).



Attention!

- **An outside voltage may never be connected to the terminals “TB/TP” and/or “TK/PTC”!**
- If a bypass circuit is installed, or in the “100%” position on devices with a main switch, the motor protection inside the controller has no function. In this case, additional motor monitoring may be required.

5.7 Signal connection or sensor connection to analog inputs (Analog In 1, Analog In 2)

The unit has two analog inputs: Analog In 1 **[E1]** and Analog In 2 **[E2]**

The connection is independent of the programmed operating mode and from the sensor signal employed.

- When connecting **passive** temperature sensors TF.. (KTY81-210) or PT1000 at terminals “E1 / T” and/or “E2 / T” must be paid attention to no polarity.
For a high interference immunity a capacitor must be connected directly to the sensor (1 nF parallel). With temperature sensors type TF.. (KTY81-210) a capacitor is integrated.
- When connecting **active** sensors at the terminals “E1 / GND” and/or “E2 / GND” attention must be paid to correct polarity, a 24 V DC power supply is integrated.
- For sensors in two-wire-technology (4 - 20 mA signal), the connection is made on the “E1 / 24 V” and/or “E2 / 24 V”, “GND” terminal is omitted.



Attention!

Never apply line voltage to analog inputs!

5.8 Output voltage 0 - 10 V (Analog Out)

The analog outputs 0 - 10 V can be allocated with various functions (☞ IO Setup: Analog output “A”). Connection to terminal “A” - “GND” = “Analog Out” (I_{\max} 10 mA).

It is not permissible to connect outputs of several devices to each other!

5.9 Voltage supply for external devices (+24 V, GND)

A voltage supply is integrated for external devices, e.g., for a sensor. “+24 V” Output voltage tolerance +/- 20 %. Max. load current 120 mA (for connection to an external “AXG..” terminal minus approx. 50 mA).

During an overload or short-circuit (24 V - GND), the control voltage (and thus the device) is disconnected. Automatic start after elimination of the cause of error.

It is not permissible to connect outputs of several devices to each other!

5.10 Add-on module type Z-Modul-B Part-No. 380052

The expansion module can be retrofitted. This could be necessary if the analog and digital inputs and outputs are not sufficient for certain applications. The board is easy to install into the device and is connected with the control device via a plug. Program the additional inputs and outputs in "IO Setup".

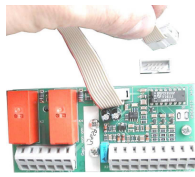

Add-on module type Z-Modul-B

- 1x analogue input 0-10 V ($R_i > 100\text{ k}\Omega$) for external Set point
- 1x output 0 - 10 V ($I_{\max} 10\text{ mA}$)
- 3x digital-inputs, Activation via floating contacts
- 2x relay outputs (contact load 2 A 250 V AC)

5.11 Digital inputs (D1, D2)

Various functions can be allocated to the digital inputs "D1" and "D2" (☞ IO Setup: Functions summary of the digital inputs). Activation via floating contacts (a low voltage of ca. 24 V DC is connected).



Attention!

Never apply line voltage to the digital input!
It is not permissible to connect inputs of several devices to each other!

5.12 Relay outputs (K1, K2)

Various functions can be allocated to the relay outputs "K1" and "K2" (☞ IO Setup: function and inverting relays outputs). Max. contact rating ☞ technical data and connection diagram. Connection of the floating contacts of relay "K1" to the terminals 11, 14, 12. Connection of the floating contacts of relay "K2" to the terminals 21, 24, 22.

5.13 Communication

5.13.1 Networking via MODBUS-RTU

The device comes equipped with a RS-485 interface for networking via MODBUS. Connection at: "A (D+)", "B (D-)" and "GND".

The address must be set in the "IO Setup" menu.



Information

A maximum of 64 members can be directly connected to one another, and another 63 members via a repeater.

5.13.2 RS-485 - network design and interface parameter

Please ensure the correct connection; i.e. "A (D+)" must always be connected to "A (D+)" of the next devices. The same applies to "B (D-)" .

In addition, a "GND" connection must be established, as dissimilar potential (over 10 V!) will lead to the destruction of the RS-485 interface (e.g. lightning).

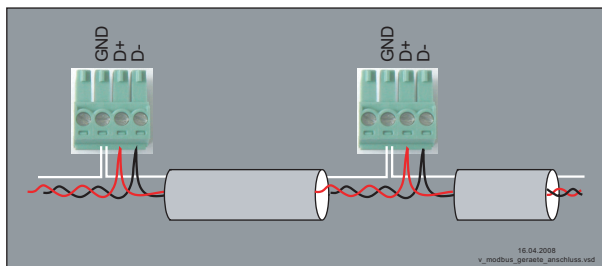

general example for MODBUS device connection

The data line must be connected from one device to the next. No other type of wiring is allowed!
Always use only two wires of one lead (twisted pair) for the connection.

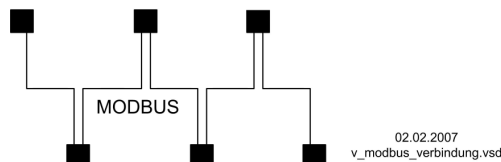

Examples for MODBUS connection

Recommended wire types

1. CAT5 / CAT7 cables
2. J-Y (St) 2x2x0.6 (telephone wire)
3. AWG22 (2x2 twisted pair)

When using telephone flex with four cable cores, we recommend the following allocation:
 "A (D+)" = red, "B (D-)" = black, "GND" = white



Information

- Pay attention to sufficient distance from powerlines and motor wires (min. 20 cm)
- Do not use wire shield
- Except the data link "A (D+)", "B (D-)" and "GND"- connection may no further cable cores of the data line be used.
- Max. allowed wire length 1000 m (CAT5/7 500 m)

Default interface parameter

Baudrate	=	19200
Bits	=	8
Parity	=	Even (None, exception of devices agriculture)
Stop bits	=	1
Handshake	=	none



Information

If any matters are unclear, please contact our V-STE support department for control systems - ventilation technology. The information sheet "Network structure of MODBUS" R-TIL08_01 contains detailed information about "MODBUS".

5.13.3 USB-interface

Over the USB-interface if necessary a software update can be made. For this a consultation with our V-STE support department for control systems-ventilation technology is necessary. For communication with a PC (Virtual COMM Port) we make the necessary programs available on request.

5.13.4 LON® Bus system is possible via add-on module

Connection to the LON® bus system is possible via add-on module type "Z-Modul-L" (Part-No. 380053). Communication to controller via the RS-485 interface, FTT-10A transceiver.

5.14 Potential at control voltage connections

The control voltage connections (< 50 V) relate to the joint GND potential (Exception: Relay contacts are potential free). There is a potential separation between the control voltage connections and the protective earth. It must be ensured that the maximum external voltage at the control voltage connections cannot exceed 50V (between "GND" terminals and "PE" protective earth). If necessary, a connection to the protective earth potential can be established, install bridge between "GND" terminal and the "PE" connection (terminal for screening).

6 Controls and Menu

6.1 Multipurpose LC display and keyboard

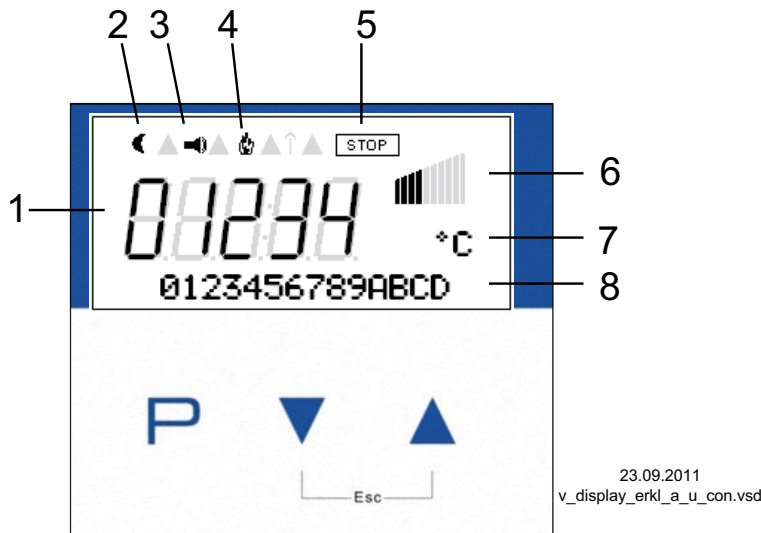

1. Numeric display 5 digit
2. Moon-Symbol for set point 2
3. Alarm-Symbol (fault indication)
4. Fire-Symbol (heating operation)
5. STOP-Symbol (enable)
6. Bargraph Fanlevel
7. Text line 3 figures (display unit, etc.)
8. Text line 16 figures (display text menu.)

- P** Program key and open menu
- ▼** Menu selection, reduce value
- ▲** Menu selection, increase value
- ▼ + ▲** ESC-key combination, Escape = leave menu

6.2 Menu operation

Display after turning on the mains voltage.
 Display for Swedish menu language = "S" (as delivered).
 Switch-over between "Start" and actual value with the key shortcut for Escape
 ((Esc = ▼ + ▲).



P ↓ ↑ ESC

By pushing the **P** key one reaches the menu item "START".



▲ ▼

One moves up and down within the menu group using the arrow keys.



In the menu point "Language" display language can be selected.

One returns to the menu group "Start" using the ESC (**▼ + ▲**) shortcut keys.

6.3 Menu structure

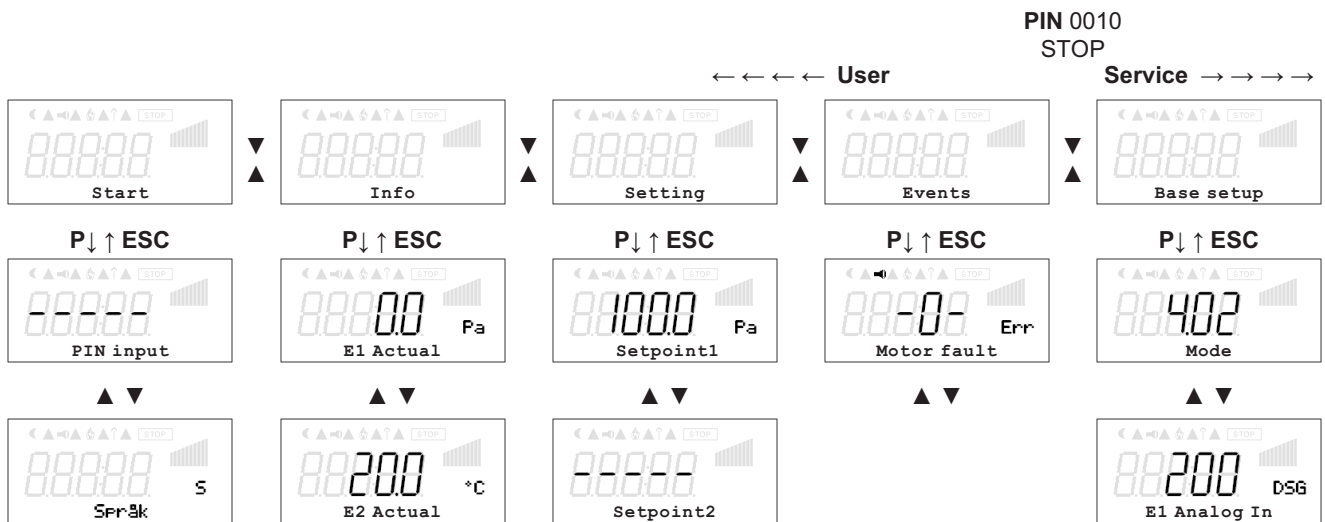

Menu dependent on device type

Selection of the menu group (e.g. Base setup) to the right through the ▼-key, to the left through the ▲-key.
 You can go to the menu items in the menu groups (e.g. mode of operation) by using the P key. Use the arrow keys to move up and down within the menu group.
 The menu groups consist of one area for the user (user menu) and one area for installation (service). The service area can be protected against unauthorized access by using a PIN.
 In order to simplify the initial start-up operation, the service level is enabled at first (i.e., not protected by the PIN 0010 (see Controller Setup, PIN protection = OFF)). If PIN protection is activated (ON), the service menu remains enabled after input of PIN 0010 as long as one is pressing keys. If no keys are pressed for ca. 15 minutes, the PIN is automatically erased, i.e. the service level is blocked.
 To make adjustments, press the P key after selecting the menu item. If the previously set value starts to flash, it can be adjusted with the ▼ + ▲ keys and then saved with the P key. To exit the menu without making any changes, use the “Esc” short-key, i.e., the originally set values remain.



Information

After installation of the device has been carried out, PIN protection should be activated (see Controller Setup)!

6.4 Example for programming mode 2.01 in “Base setup”

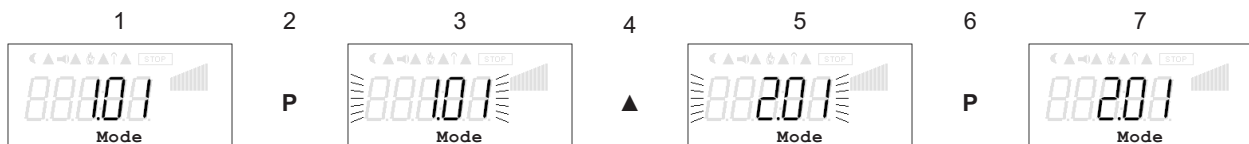

7 Base setup

7.1 Select operation mode



Information

Simple installation is possible through the selection of the preprogrammed mode of operation. This determines the basic function of the device.

The controller configuration is carried out automatically when selecting the application-specific operating modes. The factory defaults for each operating mode are based on many years of experience and represent values suitable for a wide range of applications. In exceptional cases, these can be adjusted individually (☞ **Controller setup: “Controller configuration”**).

The purpose of the device is to reach and maintain the target values set. To accomplish this, the measured actual value (sensor value) is compared with the adjusted target value, and the controlled value (modulation) is deduced from this.

Mode	Signal or Sensor (input)	Function
1.01	Signal 0 - 10 V	Speed controller, two step operation (factory setting)
2.01	Sensor TF..(E1)	Temperature control airconditioning and refrigeration. (preset set-point 20.0 °C, P-band 5 K)
2.02	Sensor TF..(E2)	Temperature control depending on outdoor temperature (preset set-point 5.0 °C, - P-band 20 K)
2.03	Sensor TF..(E1)	Temperature control with additional functions (shutter and heating)
2.04	1x Sensor TF..(E1) 1x Sensor TF..(E2)	Temperature control with two sensors, comparison or average
2.05	1x Sensor TF..(E1) 1x Sensor TF..(E2)	Temperature control with two sensors differential temperature
3.01	Sensor MBG.. (E1)	Pressure control condensers (refrigeration)
3.02	Sensor MBG..(E1)	Pressure control for condensers with input for refrigerant
3.03	1x Sensor MBG..(E1) 1x Sensor MBG..(E2)	Pressure control for two circuit condensers
3.04	1x Sensor MBG..(E1) 1x Sensor MBG..(E2)	Pressure control for two circuit condensers with input for refrigerant
4.01	Sensor DSG..(E1)	Pressure control for ventilation systems
4.02	1x Sensor DSG..(E1) 1x Sensor TF..(E2)	Pressure control depending on outdoor temperature Default settings as delivered
4.03	1x Sensor DSG..(E1) 1x BUS RS 485	Pressure control depending on outdoor temperature, MODBUS for outdoor temperature and remote control by central operating device type AXE-200
5.01	Sensor DSG..(E1)	Volume control (constant) for ventilation systems
5.02	1x Sensor DSG..(E1) 1x Sensor TF..(E2)	Volume control with setpoint depending on outdoor temperature
6.01	Sensor MAL..(E1)	Air velocity control e.g. clean room



Information

The devices described in these instructions are supplied with a default setting of **4.02** (pressure regulation with external temperature compensation) and a menu language of Swedish. The Save basic user settings ☞ “PIN9091” or “Save user setup” function is used for this purpose.

When “PIN9095” is entered, the device is reset to the factory defaults, with operating mode 1.01 and English as the menu language!

Mode and Signal to E1, E2

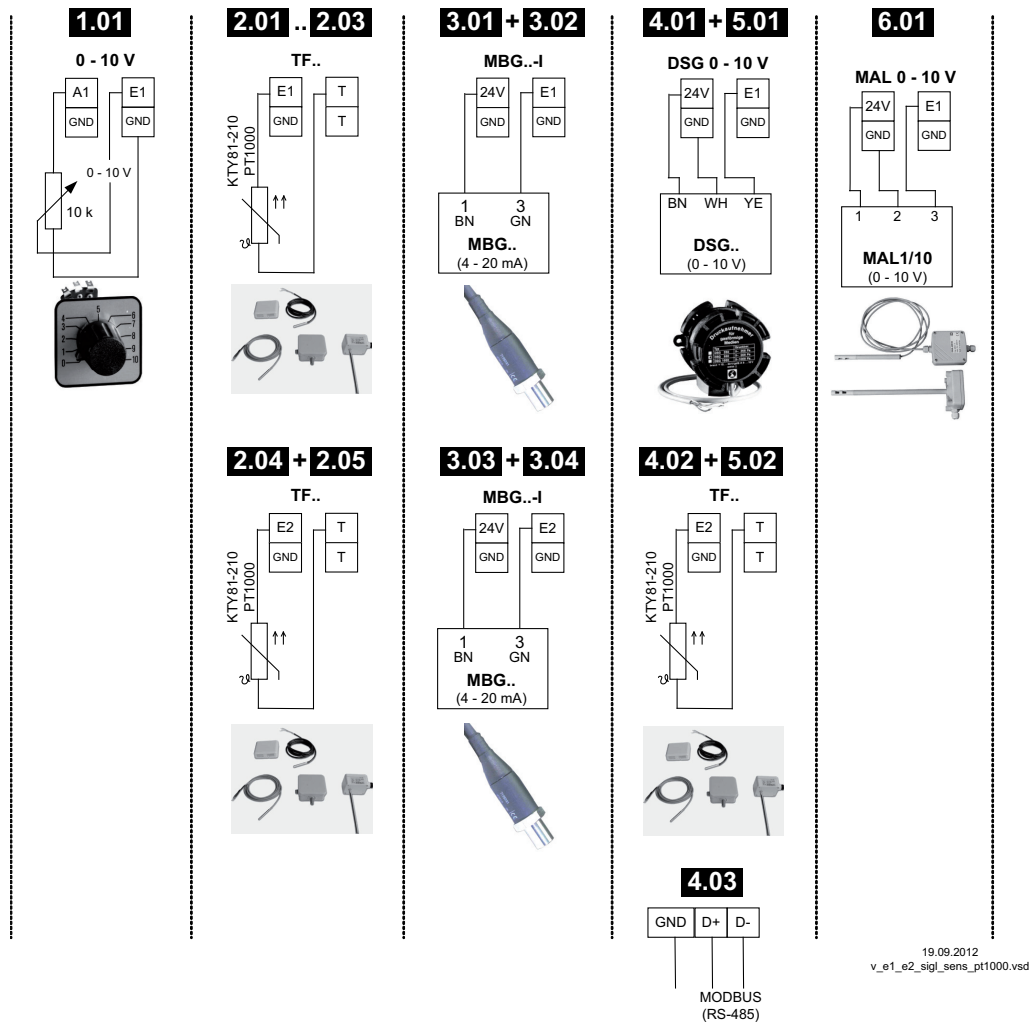

7.2 External Setpoint / External speed setting in manual operation

External Setpoint or external manual operation is possible by 0 - 10 V (0 - 20 mA, 4 - 20 mA) signal at terminals “E2” and “GND”. “E2” configuration in base setup. For Potentiometer Analog Out1 (terminal “A1”) program to function **[1A]** = “+10 V” (like factory setting **[IO Setup]**). If a second sensor is connected at input 2, external Setpoint or speed setting in manual operation is possible with additional modul “Z-Modul-B” (input E3 **[IO Setup]** / programming additional modul type Z-Modul-B). E2 Analog In = factory setting 0 - 10 V

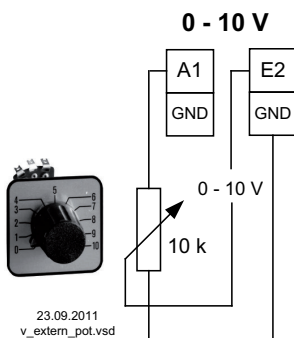

External Setpoint via external signal instead of “Setpoint 1”. The “external Setpoint” function must be activated in base setup **[1E]** for “E2 function”. The active external Setpoint value is displayed in the “info” menu group.

External speed setting in manual operation. The “external manual operation” function must be activated in the basic settings **[2E]** for “E2 function”. Switchover between settings on the device and external manual operation via the digital input (**[IO Setup]**: “Control / manual operation” **[7D]**).

8 Start-up

8.1 Prerequisites for commissioning



Attention!

1. You must mount and connect the device in accordance with the operating instructions.
2. Double check that all connections are correct.
3. The mains voltage must match the information on the rating plate.
4. The rated current on the rating plate will not be exceeded.
5. Make sure that no persons or objects are in the fan's hazardous area.

8.2 Procedure for commissioning

Sequence	Setting
1	If necessary, set the menu language in Menu group “Start” . (Default setting Swedish: “ Språk S ”)
2	Set the operating mode using the Basic settings menu group (default setting 4.02 = Pressure regulation with external temperature compensation). Attention! When saving the operating mode, the respective preset factory operating-mode setting is loaded. That means, the settings you have made, e.g., in “Motor Setup” are lost. An exception: the menu language setting remains preserved.
3	Setting CosPhi for optimal operation (☞ motor data)









8.3 Menu Mode **4.02**

Start	Info	Setting	Events	Base setup	Controller Setup	IO Setup	Limits	Motor Setup	Diagnostic
----- PIN input	0.0 Pa E1 Actual	100.0 Pa Setpoint1	-0- Motor fault	4.02 Mode	OFF PIN Protec- tion	[1A] A Function	OFF Level. Function	0.80 CosPhi	OTC 00012:56:- 15
GB Lan- guage	23.9 °C E2 Actual	----- Setpoint2	-1- overload	200 DSG E1 Analog In	OFF Set protec- tion	0.0 V A min.	----- Level min.	20 sec Rampup time	OTM 00010:56:- 11
OFF Reset	100.0 Pa Setpoint1	100.0 Pa Pband	-2- External error	----- E1 Deci- mals	OFF Save User Setup	10.0 V A max.	----- Level max.	20 sec Rampdown time	27.4 °C Heatsink
4.02 Mode	100.0 Pa Setpoint control	0 % Min. Speed	-3- Sensor 2	----- E1 Unit	-- OFF Alarm sen- sors	OFF A Inverting	----- Level Delay	OFF Suppres- sion1	32.4 °C Heatsink
1.13 Ucontrol	100 % Modulation	100 % Max. Speed		0.0 Pa E1 Offset	----- Limit	OFF D1 Func- tion	OFF Lmt E1 Function	----- Range1 min.	29.5 °C E1 - KTY
				6E E2 Func- tion	OFF Msc0	----- D1 Invert- ing	----- Lmt E1 min	----- Range1 max.	0.00 mA E1-Current

9 Programming

9.1 Speed controller **1.01**

9.1.1 Base setup **1.01**

 <p>Base setup</p>	<p>Base setup</p>
 <p>Mode</p>	<p>Mode Factory setting Mode: 1.01</p>
 <p>E1 Analog In</p>	<p>E1 Analog In Selection: 0 - 20 mA, 4 - 20 mA, Bus (Inverting  IO Setup) Factory setting: 0 - 10 V</p>
 <p>E2 Function</p>	<p>E2 Function (only for special applications) Analog input 2 "E2" factory set at "OFF". For operation with a second signal and switch over via floating contact set function for "E2" to 1E ( IO Setup: function 4D). For operation with a second signal and automatic control at the higher level. Set "E2" Function to 4E.</p>
 <p>E2 Analog In</p>	<p>E2 Analog In As long as no allocation has been carried out display: ----- Selection: 0 - 20 mA, 4 - 20 mA, Bus (Inverting  IO Setup) Factory setting: 0 - 10 V</p>

9.1.2 Setting for operation **1.01**







 <p>Setting</p>	<p>Setting</p>
 <p>Set Intern1</p>	<p>Set Intern1 Setting range Manual speed setting: 0...100 % Factory setting: 80 %</p>
 <p>Set Intern2</p>	<p>Set Intern2 Setting "Set Intern2" e.g. reduced value for night operation. Switch over intern 1/2 by external contact (as long as no allocation is carried out: Display: -----  IO Setup).</p>
 <p>Min. Speed</p>	<p>Minimal Speed Setting range: 0...100 % Factory setting: 0 %</p>
 <p>Max. Speed</p>	<p>Maximal Speed Setting range: 100 % - "Min. Speed" Factory setting: 100 %</p>
 <p>Set external1</p>	<p>Set external1 "ON" (factory setting) = speed setting by external Signal "OFF" = Setting "Set Intern1"</p>

Diagram setting signal and output voltage (Idealized principle diagram)



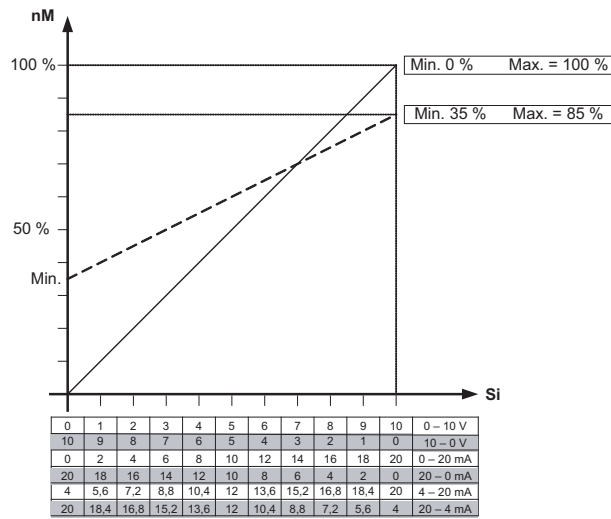

09.05.2007
v_motor_101.vsd

nM Motor speed
Si Signal

9.2 Temperature control 2.01... 2.05



9.2.1 Basic setting 2.01... 2.05





	<p>Base setup</p>
	<p>Mode Mode selection e.g. 2.01</p>
	<p>E1 Analog In In all group 2 operating modes (2.01, 2.02, 2.03,) “E1 Analog In” factory set to “KTY” (sensors type TF..) at terminals “E1” and “T1” (measuring range: -50.0...+150 °C).</p> <p>Alternative selection sensor</p> <ul style="list-style-type: none"> • PT1000 at terminals “E1” and “T1” (measuring range -50.0...+150 °C) • MTG-120V active sensor with 0 - 10 V output at terminals “E1” and “GND” (measuring range: -10...+120 °C) <p>Alternative selection signal at terminals “E1” and “GND”: 0 - 10 V, 0 - 20 mA, 4 - 20 mA. The sensor measurement range must be entered in order to display the actual value correctly. Example with a 0 - 10 V sensor and 0 - 100 °C measurement range: E1 Analog In = 0 - 10 V, E1 Min. = 0.0 °C, E1 Max. = 100.0 °C, E1 Decimally = 1, E1 Unit = °C</p>
	<p>E1 Offset Sensor calibration with calibrated comparison device</p>

 <p>E2 Function</p>	<p>E2 Function (only for special applications)</p> <ul style="list-style-type: none"> Function 1E = External Setpoint e.g. via external signal (0 - 10 V) instead of "Setpoint1" <ul style="list-style-type: none"> For sensor type "E1 Analog In" = "KTY or PT1000": 0 - 10 V $\hat{=}$ -50.0...+150 °C. For sensors with active signal: 0 - 10 V $\hat{=}$ 0 - 100 % sensor measuring range.
 <p>E2 Analog In</p>	<ul style="list-style-type: none"> Function 2E = External manual operation via external signal (0 - 10 V). Switch over between settings on the device and external manual operation via digital input (IO Setup: function 7D). Function 7E Measurement value = Measurement value e.g. for limit indication, display in Info menu "E2 Actual".
<p>Modes with two sensors</p> <p>The function is automatically jointly programmed in operating modes using 2 sensors. The second analog input is thus allocated and additional function allocations are not possible.</p> <ul style="list-style-type: none"> 2.04 E2 Function at 4E preprogrammed = comparison value with control to higher temperature. Alternative: average of 2 measuring points for this must be reprogrammed on function 3E preprogrammed sensor: type "KTY". 2.05 E2 Function at 5E preprogrammed = regulation on difference temperature between sensor 1 and sensor 2. Preprogrammed sensor type "KTY". 	

9.2.2 Settings for operation modes 2.01... 2.05

- 2.01** Temperature control simple
- 2.02** Temperature control depending on outdoor temperature (Special function: Sensor connection at "E2", display and setting under "E1").
- 2.03** Temperature control with pre-programmed additional functions (heating, shutter, temperature monitoring).
- 2.04** Temperature control with 2 sensors
 Comparison with control to higher value "E2 Function" set to comparison **4E**. Display during operation: "Control value"
 Alternative: Average calculation of 2 measuring places "E2 Function" set to **3E**. Display during operation: "Average E1 / E2"
- 2.05** Temperature control with 2 sensors, regulation on difference temperature.
 Display during operation: "Value of E1 - E2" in K, "E1" = reference temperatur, "E2" causes positiv (E2 < E1) or negative (E2 > E1) difference.

 <p>Setting</p>	<p>Setting</p>
 <p>Setpoint1</p>	<p>Setpoint1</p> <p>Setting range: with passive sensor type "KTY", "PT1000": -50.0...150.0 °C Factory setting: 2.01, 2.03, 2.04: 20.0 °C at 2.02: 5.0 °C at 2.05: 0.0 °C Setting range: at active sensor type "MTG-120V": -10.0...+120.0 °C Factory setting: 2.01 - 2.05: 55.0 °C</p>
 <p>Setpoint2</p>	<p>Setpoint2</p> <p>Setting "Setpoint 2" e.g. reduced value for night operation. Switch over Setpoint 1/2 by external contact (as long as no allocation is carried out: Display: ---- IOSetup).</p>

	<p>Pband Narrow control range = Short control times Wide control range = Longer control times and more stable control</p> <p>Passive sensor type “KTY”, “PT1000” Setting range: 0 - 200.0 K (Kelvin) Factory setting: 5.0 K, (at 2.02: 20.0 K)</p> <p>active Sensor type “MTG-120V” Setting range: -10.0...+120.0 K Factory setting: 65.0 K</p>
	<p>Minimal Speed Setting range: 0...100 % Factory setting: 0 %</p>
	<p>Maximal Speed Setting range: 100 %... “Min. Speed” Factory setting: 100 %</p>
	<p>Manual mode “OFF” = automatic control as function of the set parameters (Factory setting) “ON” = automatic control without function, speed setting in menu “Speed manual”</p>
	<p>Speed Manual mode Manual speed setting without influence by the external signal. Activation by menu “Manual mode” or external contact at digital input (☞ IO Setup). Setting range: 0...100 % Factory setting: 100 % For information about deactivated regulation the adjusted value for manual speed is indicated alternating with the actual value.</p>

9.2.3 Functional diagrams temperature control

Example 1: Temperature control in factory setting “Cooling function” (Idealized principle diagram)

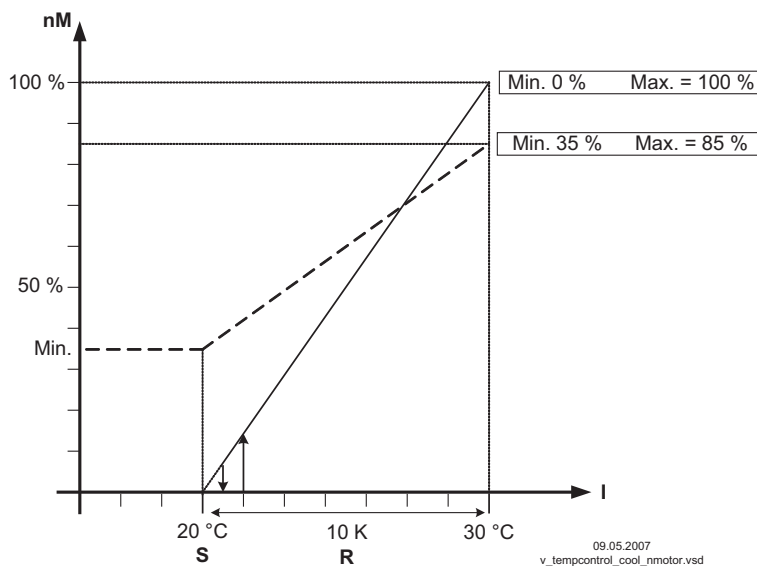

(Controller Setup: “Val > Set = n+” to “ON”)

- nM Motor speed
- S Setpoint
- R Pband
- I Actual value

Example 2: Temperature control in “Heating function” (Idealized principle diagram)

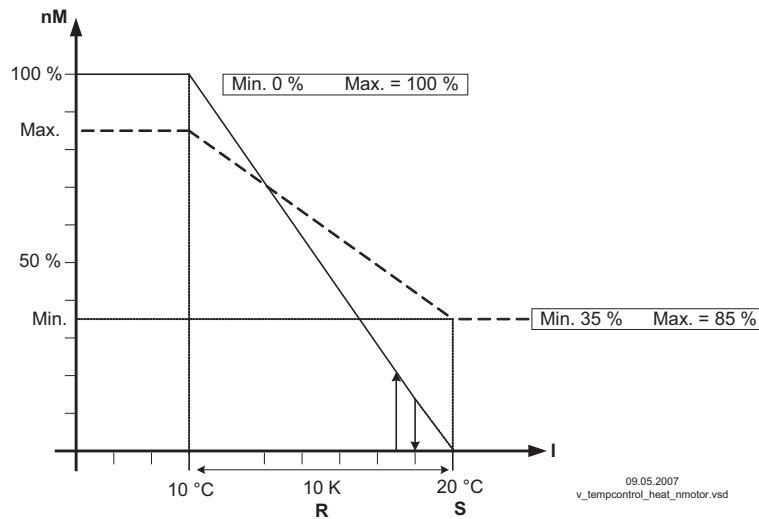

(Controller Setup: “Val > Set = n+” to “OFF”)

- nM Motor speed
- S Setpoint
- R Pband
- I Actual value

9.2.4 Additional for mode **2.03**: Signal output 0 - 10 V

The 0 - 10 V output signal can, e.g., be used for triggering a shutter or heating.

	<p>Offset AnalogOut</p> <p>The target value for this output is the target value (Setpoint) for the ventilation “offset” setting.</p> <p>Adjustment: range +/- 10 K relative to the active Setpoint.</p> <p>Example for triggering a shutter servomotor: At factory setting “0 K” = synchronous operation.</p> <p>The analog output is factory set to increasing activation during increasing temperature. Reprogramming to “Heating function”, i.e., increasing modulation during decreasing temperature is possible (IO Setup).</p>
	<p>Pband AnalogOut</p> <p>Pband AnalogOut = separately adjustable range of control (P-band) for 0 - 10 V output</p> <p>Setting range: 0...102.0 K</p> <p>Factory setting: 2.0 K</p>
	<p>Min. AnalogOut</p> <p>Min. AnalogOut = Minimal output voltage</p> <p>Setting range: 0...100 % = 0 - 10 V</p> <p>Factory setting: 0 %</p>
	<p>Max. AnalogOut</p> <p>Max. AnalogOut = Maximal output voltage,</p> <p>Setting range: 100...0 % = 10 - 0 V</p> <p>Factory setting: 0.0 K</p>

Example for signal out 0 - 10 V (IO Setup: "A function" = [6A])

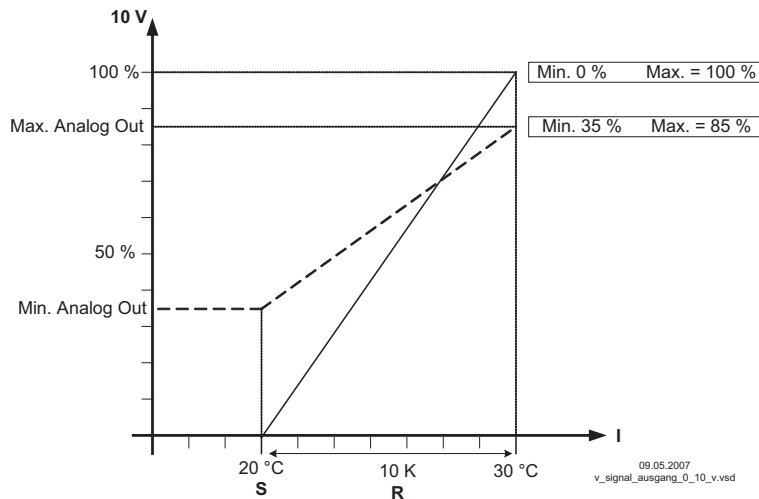

Example: Setpoint ventilation 25.0 °C, Offset -5.0 K, Pband 10.0 K

- S Setpoint Ventilation +/- Offset
- R Pband
- I Actual value

9.2.5 For mode 2.03: Relay output for Heating or Cooling

	<p>OffsetDigitalOut Offset Digital Out = Offset for relay output ("K2" is pre-programmed by the factory). The relay operating point deviates by the adjusted offset of the Setpoint of the ventilation (if relay "K2" not inverted, terminal "21"- "24" bridged). Setting range: -10.0...+10.0 K Factory setting: -1.0 K</p> <ul style="list-style-type: none"> • "0.0 K" set, i.e. heating "ON" when: actual value = Setpoint • During negative offset value heating "ON" when: actual value = Setpoint - offset • During positive offset value heating "ON" when: actual value = Setpoint + offset
	<p>Hyst.DigitalOut Switching hysteresis of the relay Setting range: 0...10 K, Factory setting: 1.0 K (Kelvin)</p>

Temperature variation with factory setting [9K] in IO Setup e. g. for controlling a Heating.

If the ambient temperature is lower than the set operating point, the heating remains switched on. If the ambient temperature exceeds the set operating point of the heating by 2 K (Kelvin), the heating is switched off. I.e., the release point is situated at the hysteresis value over the operating point.

Example:
 Setpoint 15.0 °C, Offset +5.0 K, Hysteresis 2.0 K

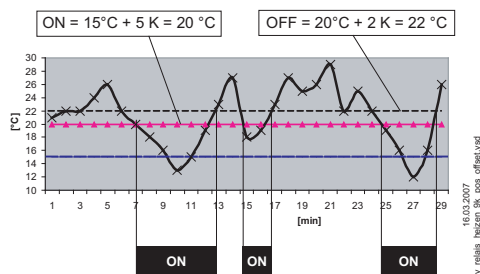

Example:
 Setpoint 20.0 °C, Offset -5.0 K, Hysteresis 2.0 K

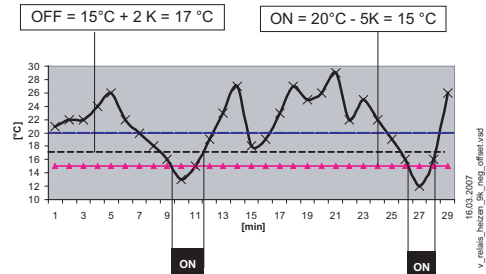

The activated heating is indicated over the fire symbol in the display.

Temperature variation with reprogramming to 10K for “K2” in IO Setup, e.g., for activation of the Cooling

Example:
Setpoint 15.0 °C, Offset +5.0 K, Hysteresis 2.0 K

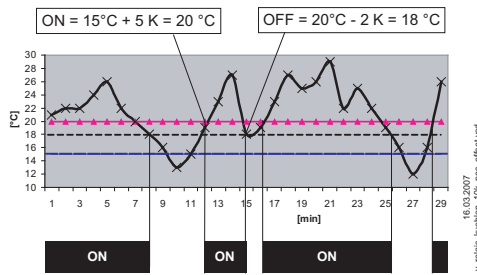

If the ambient temperature is higher than the set operating point, the cooling remains switched on. If the ambient temperature falls below the set operating point of the cooling by 2 K (Kelvin), it is switched off. I.e., the OFF point is situated at the hysteresis value under the ON point.

9.2.6 For mode 2.03 Relay output for temperature monitoring

If the set value for the “minimum alarm” is not reached or the set value for the “maximum alarm” is exceeded, a message is generated via the alarm symbol in the display. In addition, „Lmt E1 min“ is displayed alternately with the actual value for the minimum alarm and Lmt E1 max for the „Maximum alarm“. An external message follows via the factory-assigned “K1” relay. (IO Setup: K1 function = 2K).

	<p>Alarm Minimum Setting range: OFF / -50...150.0 °C Factory setting: 0.0 °C</p>
	<p>Alarm Maximum Setting range: OFF / -26.9...150.0 °C Factory setting: 40.0 °C</p>









Example for display if falling below setting “Alarm Minimum” alternating to the actual value display.
Relay “K1” disengages (if not inverted).



Example for display if exceeding setting “Alarm Maximum” alternating to the actual value display
Relay “K1” disengages (if not inverted).

9.3 Pressure control for condensers refrigeration 3.01... 3.04

9.3.1 Base setup 3.01... 3.04









	<p>Base setup</p>
	<p>Mode Mode selection e.g. 3.01</p>
	<p>E1 Analog In For all Modes in Group 3 (3.01, 3.02, 3.03, ...) "E1 Analog In" factory setting to "MBG-30I". (measuring range 0...30 bar) proportional output 4 - 20 mA Selection sensor: MBG-30I, MBG-50I, DSF2-25 Alternative selection signal: 0 - 10 V, 4 - 20 mA. The sensor measurement range must be entered in order to display the actual value correctly. Example 0 - 10 V sensor and measuring range 0 - 20 bar: E1 Analog In = 0 - 10 V, E1 Min. = 0.0 bar, E1 Max. = 20.0 bar, E1 Decimals = 1, E1 Unit = bar</p>
	<p>E1 Offset Sensor calibration with calibrated comparison device</p>
	<p>E1 Refrigerant With 3.02 and 3.04 operating modes with input of the refrigerant, the device automatically calculates the corresponding temperature for the measured pressure. The settings for offset, target value and the controlling range are then carried out in °C or K. Calculation for relative pressure (differential measurement of pressure relative to ambient pressure). No further settings are necessary for pressure sensors model e.g. "MBG-30I" or "MBG-50I" (measurement range 0 - 30 bar or 0 - 50 bar). In the case of sensors with other measurement ranges, the "E1 Min. value" and the "E1 Max. Value". Setting in "bar" although unit display is in "°C"!</p>
	<p>E2 Function (only for special applications)</p> <ul style="list-style-type: none"> External setpoint = Function 1E by external signal (0 - 10 V) instead of "Setpoint 1". 0 - 10 V \triangleq 0 - 100 % sensor measuring range. External manual operation via external signal (0 - 10 V) = Function 2E Switch over between settings on the device and external manual operation via digital input (IO Setup: function 7D). Measurement value = function 7E e.g. for limit indication, display in Info menu "E2 Actual". <p>Modes 3.03 and 3.04 with two sensors The function is automatically jointly programmed in operating modes using 2 sensors. The second analog input is thus allocated and additional function allocations are not possible. With 3.03 and 3.04 E2 Function at 4E preprogrammed = comparison value with control to higher value (two circuit condensers).</p>

Selection of the refrigerants:

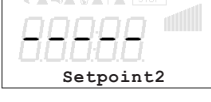
R12	R13	R13b1	R22	R23	R32	R114	R134a	R142B
R227	R401	R401A	R401B	R402	R402A	R402B	R404A	R407A
R407B	R407C	R410A	R500	R502	R503	R507	R717	

9.3.2 Setting for operation modes **3.01... 3.04**

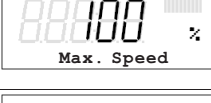
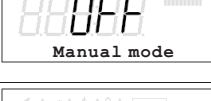
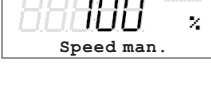
- 3.01** Pressure control condensers, setting Setpoint in bar
- 3.02** Pressure control for condensers with input for refrigerant, Setpoint in °C
- 3.03** Two sensors for dual circuit condenser. Automatic regulation to the highest pressure (selection amplifier integrated) operation display: “Control value”, Setpoint in bar
- 3.04** Two sensors for dual circuit condenser with input for refrigerant automatic regulation to the highest pressure (selection amplifier). Setpoint in °C , also for different refrigerants suitably there comparison of the temperatures. Display during operation: “Control value ”

 <p>Setting</p>	<p>Setting</p>
 <p>Setpoint1</p>	<p>Setpoint1 3.01 and 3.03 Setting range: in measuring range of sensor, factory setting: 12.0 bar 3.02 and 3.04 Setting range: dependent on the selected refrigerant, factory setting: 35.0°C</p>
 <p>Setpoint1</p>	
 <p>Setpoint2</p>	<p>Setpoint2 Setting “Setpoint 2” e.g. reduced value for night operation. Switch over Setpoint 1/2 by external contact (as long as no allocation is carried out: Display:  IO Setup).</p>
 <p>Pband</p>	<p>Pband Narrow control range = Short control times Wide control range = Longer control times and more stable control 3.01 and 3.03 Setting range: in measuring range of sensor, factory setting: 5.0 bar 3.02 and 3.04 Setting range: dependent on the selected refrigerant and in measuring range of sensor, factory setting: 7.0 K</p>
 <p>Pband</p>	
 <p>Min. Speed</p>	<p>Minimal Speed Setting range: 0...100 % Factory setting: 0 %</p>
 <p>Max. Speed</p>	<p>Maximal Speed Setting range: 100 %... “Min. Speed” Factory setting: 100 %</p>
 <p>Manual mode</p>	<p>Manual mode “OFF” = automatic control as function of the set parameters (Factory setting) “ON” = automatic control without function, speed setting in menu “Speed manual”</p>
 <p>Speed man.</p>	<p>Speed Manual mode Manual speed setting without influence by the external signal. Activation by menu “Manual mode” or external contact at digital input ( IO Setup). Setting range: 0...100 % Factory setting: 100 %</p>
	<p>For information about deactivated regulation the adjusted value for manual speed is indicated alternating with the actual value.</p>

9.3.3 Functional diagrams pressure control condensers

Functional diagram for Mode **3.01** and **3.03** (Idealized principle diagram)

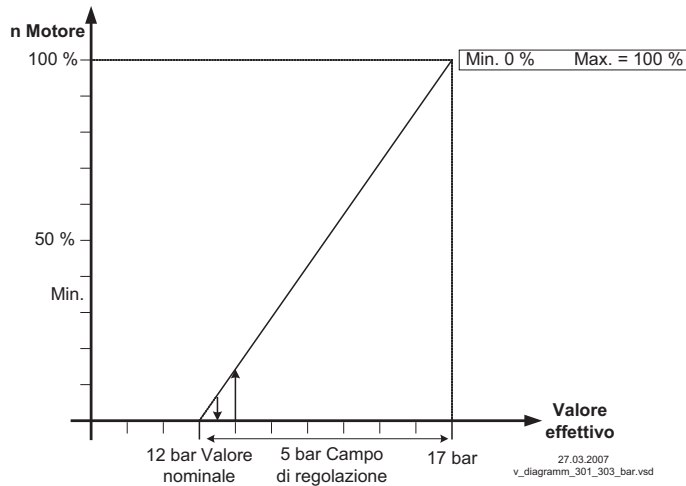

nM Motor speed
S Setpoint
R Pband
I Actual value

Functional diagram for Mode **3.02** and **3.04** (Idealized principle diagram)

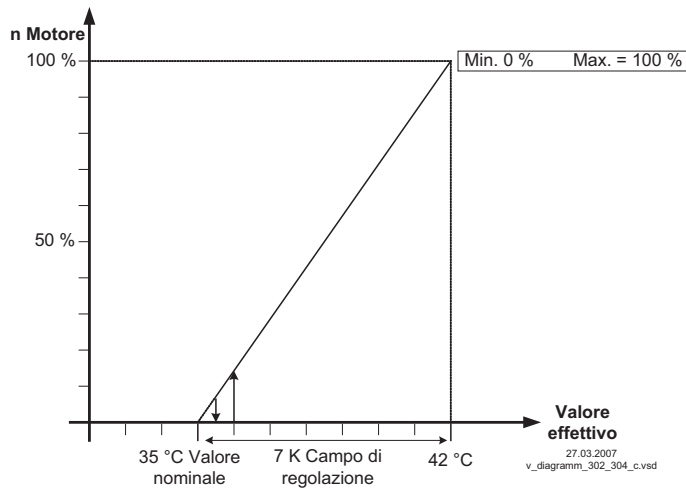

nM Motor speed
S Setpoint
R Pband
I Actual value







Information

The factory default presets must be adapted to match the system conditions by a competent person.









9.4 Pressure control airconditioning 4.01... 4.03

9.4.1 Base setup 4.01... 4.03

	<p>Base setup</p>
	<p>Mode Mode selection e.g. 4.01</p>
	<p>E1 Analog In In all group 2 operating modes 4 (4.01, 4.02, 4.03, ...) "E1 Analog In" factory setting "DSG200". Selection sensor type: "DSG 50", "DSG100*", "DSG200", "DSG300*", "DSG500", "DSG1000", "DSG2000", "DSG4000", "DSG6000" (* no standard type). With the use of not pre-programmed sensor types further settings are necessary. Example with a 0 - 10 V sensor and 0 - 400 Pa measurement range (proportional output signal): E1 Analog In = 0 - 10 V, E1 Min. = 0.0 Pa, E1 Max. = 400 Pa, E1 Dezimal = 1, E1 unit = Pa</p>
	<p>E1 Offset Sensor calibration with calibrated comparison device</p>
	<p>E2 Function (only for special applications)</p> <ul style="list-style-type: none"> • External setpoint = Function 1E by external signal (0 - 10 V) instead of "Setpoint 1". 0 - 10 V $\hat{=}$ 0 - 100 % sensor measuring range. • External manual operation via external signal (0 - 10 V) = Function 2E Switch over between settings on the device and external manual operation via digital input (IO Setup: function 7D). • Measurement value = function 7E e.g. for limit indication, display in Info menu "E2 Actual." <p>Modes 4.02 and 4.03 with two sensors The function is automatically jointly programmed in operating modes using 2 sensors. The second analog input is thus allocated and additional function allocations are not possible. For 4.02 E2 Function at 6E preprogrammed = sensor for setpoint lowering. Preprogrammed sensor type "KTY" For 4.03 E2 Function at 6E preprogrammed = sensor for setpoint lowering. - preprogrammed sensor type "BUS" - measuring range -35.0...+65.0 °C In "IO Setup": For enable "ON" / "OFF" via Bus: - D1 function = 1D - D1 Busmode = "ON" For switch over setpoint 1 / 2 via Bus: - D2 function = 5D, - D2 Busmode = "ON"</p>

9.4.2 Setting for operation modes **4.01**... **4.03**

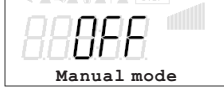
- **4.01** pressure control, setpoint in Pa
- **4.02** and **4.03** Pressure control for ventilation systems setpoint depending on outdoor temperature

 <p>Setting</p>	<p>Setting</p>
 <p>Setpoint1</p>	<p>Setpoint1 Setting range: in measuring range of sensor Factory setting: 100 Pa</p>
 <p>Setpoint2</p>	<p>Setpoint2 Setting "Setpoint 2" e.g. reduced value for night operation. Switch over Setpoint 1/2 by external contact (as long as no allocation is carried out: Display: [----] IO Setup).</p>
 <p>Pband</p>	<p>Pband Narrow control range = Short control times Wide control range = Longer control times and more stable control Setting range: in measuring range of sensor Factory setting: 100 Pa</p>
 <p>Min. Speed</p>	<p>Minimal Speed Setting range: 0...100 % Factory setting: 0 %</p>
 <p>Max. Speed</p>	<p>Maximal Speed Setting range: 100 %... "Min. Speed" Factory setting: 100 %</p>
 <p>Manual mode</p>	<p>Manual mode "OFF" = automatic control as function of the set parameters (Factory setting) "ON" = automatic control without function, speed setting in menu "Speed manual"</p>
 <p>Speed man.</p>	<p>Speed Manual mode Manual speed setting without influence by the external signal. Activation by menu "Manual mode" or external contact at digital input (IO Setup). Setting range: 0...100 % Factory setting: 100 % For information about deactivated regulation the adjusted value for manual speed is indicated alternating with the actual value.</p>

Additional menu item for mode 4.02 and 4.03 with outside-temperature dependent target-setpoint.

Outside-temperature dependent target-setpoint

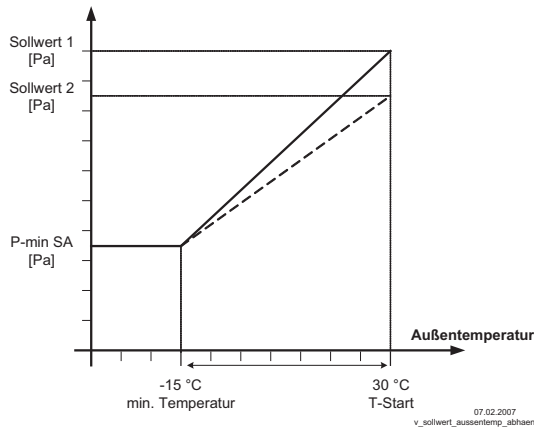

An outside temperature compensation can be activated (sensor connection “E2” = “Analog In 2”) when being operated as a pressure regulation device.

An optimal building climate, e.g., can be achieved through this. Through this function, the set and active “Setpoint 1” or “Setpoint 2” is automatically changed proportional to the measured outside temperature (Info: “Setpoint control”).



- S1 Setpoint1
- S2 Setpoint2
- P-Min SA Minimum pressure
- T-min Minimum temperature
- T-Start Setpoint reducing will start below this outside temperature
- AT Outdoor temperature

	<p>T-Band SA Temperature range in which the setpoint change continuously with outside temperature</p>
	<p>T-Start SA Setpoint reducing will start below this outside temperature</p>
	<p>P-Min SA Minimum pressure for very low outside temperature</p>

9.5 Volume control 5.01 and 5.02









9.5.1 Basic setting 5.01 and 5.02

	<p>Base setup</p>
	<p>Mode Mode selection e.g. 5.01</p>
	<p>E1 Analog In In all group operating modes 5 (5.01 and 5.02) “E1 Analog In” factory setting “DSG200.” Selection sensor measuring range: “DSG 50”, * “DSG100”, “DSG200”, * “DSG300”, “DSG500”, “DSG1000”, “DSG2000”, “DSG4000”, “DSG6000” (* no standard type).</p>
	<p>K Factor Input of the “K factor” dependent on the fan (inlet duct). setting range: 0...7.000 Factory setting: 75</p>

	<p>E1 Offset Sensor calibration with calibrated comparison device</p>
	<p>E2 Function (only for special applications)</p> <ul style="list-style-type: none"> External setpoint = Function 1E by external signal (0 - 10 V) instead of “Setpoint 1”. 0 - 10 V $\hat{=}$ 0 - 100 % setting range External manual operation via external signal (0 - 10 V) = Function 2E Switch over between settings on the device and external manual operation via digital input (IO Setup: function 7D). Measurement value = function 7E e.g. for limit indication, display in Info menu “E2 Actual” <p>Modes 5.02 with two sensors Modes with two sensors The function is automatically jointly programmed in operating modes using 2 sensors. The second analog input is thus allocated and additional function allocations are not possible. For 5.02 E2 Function at 6E preprogrammed = sensor for setpoint lowering. Pre-programmed sensor type “KTY”.</p>

9.5.2 Setting for operation modes 5.01... 5.02

- **5.01** Volume control, Setpoint in m³/h
- **5.02** Volume control for ventilation systems setpoint depending on outdoor temperature.

	<p>Setting</p>
	<p>Setpoint1 Setpoint in m³/h (m³/s) Setting range: depending on measuring range of sensor and “K factor” Factory setting: 530 m³/h</p>
	<p>Setpoint2 Setting “Setpoint 2” e.g. reduced value for night operation. Switch over Setpoint 1/2 by external contact (as long as no allocation is carried out: Display: ---- IO Setup).</p>
	<p>Pband Narrow control range = Short control times Wide control range = Longer control times and more stable control Setting range: depending on measuring range of sensor and “K factor” Factory setting: 530 m³/h</p>
	<p>Minimal Speed Setting range: 0...100 % Factory setting: 0 %</p>
	<p>Maximal Speed Setting range: 100 %... “Min. Speed” Factory setting: 100 %</p>
	<p>Manual mode “OFF” = automatic control as function of the set parameters (Factory setting) “ON” = automatic control without function, speed setting in menu “Speed manual”</p>
	<p>Speed Manual mode Manual speed setting without influence by the external signal. Activation by menu “Manual mode” or external contact at digital input (IO Setup). Setting range: 0...100 % Factory setting: 100 % For information about deactivated regulation the adjusted value for manual speed is indicated alternating with the actual value.</p>

Additional menu item for mode 5.02 with outside-temperature dependent target-setpoint

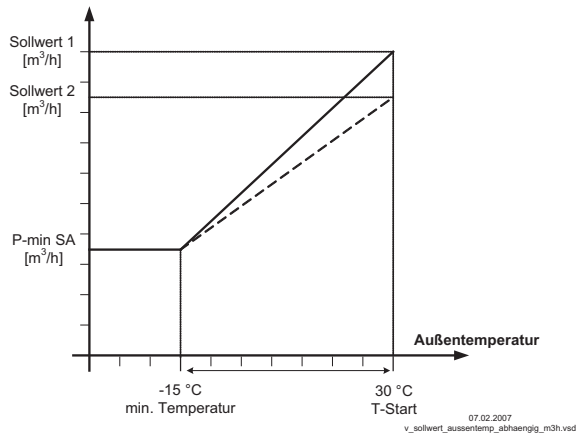

Outside-temperature dependent target-setpoint



An outside temperature compensation can be activated (sensor connection “E2” to “Analog In 2”) when being operated as a air volume regulation device.





An optimal building climate, e.g., can be achieved through this. Through this function, the set and active Setpoint 1/2 is automatically changed proportional to the measured outside temperature (Info: “Setpoint control”).

- S1 Setpoint1
- S2 Setpoint2
- P-Min SA Minimum air volume
- T-min Minimum temperature
- T-Start Setpoint reducing will start below this outside temperature
- AT Outdoor temperature

 <p>T-Band SA</p>	<p>T-Band SA Temperature range in which the setpoint change continuously with outside temperature</p>
 <p>T-Start SA</p>	<p>T-Start SA Setpoint reducing will start below this outside temperature</p>
 <p>P-Min SA</p>	<p>P-Min SA Minimum pressure for very low outside temperature</p>









9.6 Air velocity control 6.01

9.6.1 Base setup 6.01





 <p>Base setup</p>	<p>Base setup</p>
 <p>Mode</p>	<p>Mode Mode selection 6.01</p>
 <p>E1 Analog In</p>	<p>E1 Analog In For mode 6.01 “E1 Analog In” factory setting to “MAL1” Selection sensor measuring range: MAL1, MAL10 Alternative selection signal: 0 - 10 V, 0 - 20 mA, 4 - 20 mA. The sensor measurement range must be entered in order to display the actual value correctly. Example with a 0 - 10 V sensor and 0 - 5 m/s measurement range (proportional output signal). E1 Analog In = 0 - 10 V, E1 Min. = 0.0 m/s, E1 Max. = 5.0 m/s, E1 Decimals = 1, E1 Unit = m/s</p>
 <p>E1 Offset</p>	<p>Sensor calibration with calibrated comparison device</p>

	<p>E2 Function (only for special applications)</p> <ul style="list-style-type: none"> • External setpoint = Function [1E] by external signal (0 - 10 V) instead of “Setpoint 1”. 0 - 10 V $\hat{=}$ 0 - 100 % setting range • External manual operation via external signal (0 - 10 V) = Function [2E] Switch over between settings on the device and external manual operation via digital input (☞ IO Setup: function [7D]). • Measurement value = function [7E] e.g. for limit indication, display in Info menu “E2 Actual.”
---	--

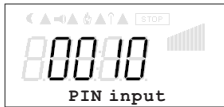

9.6.2 Settings for operation modes **6.01**



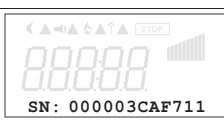

	<p>Setting</p>
	<p>Setpoint1 Setting range: in measuring range of sensor Factory setting: 0.50 m/s</p>
	<p>Setpoint2 Setting “Setpoint 2” e.g. reduced value for night operation. Switch over Setpoint 1/2 by external contact (as long as no allocation is carried out: Display: [-----] ☞ IOSetup).</p>
	<p>Pband Narrow control range = Short control times Wide control range = Longer control times and more stable control Setting range: in measuring range of sensor Factory setting: 0.50 m/s</p>
	<p>Minimal Speed Setting range: 0...100 % Factory setting: 0 %</p>
	<p>Maximal Speed Setting range: 100 %... “Min. Speed” Factory setting: 100 %</p>
	<p>Manual mode “OFF” = automatic control as function of the set parameters (Factory setting) “ON” = automatic control without function, speed setting in menu “Speed manual”</p>
	<p>Speed Manual mode Manual speed setting without influence by the external signal. Activation by menu “Manual mode” or external contact at digital input (☞ IO Setup). Setting range: 0...100 % Factory setting: 100 % For information about deactivated regulation the adjusted value for manual speed is indicated alternating with the actual value.</p>

9.7 Menu group Start

	<p>Start</p>
	<p>PIN input The service menu for the installation can be protected against unintentional changes by a pin code. With further pin codes putting back to pre-setting is possible.</p>
	<p>PIN 0010 Opening service menu, if PIN-protection activated</p>
	<p>PIN 1234 Opening "setting". if "set protection" = "ON" (☞ Controller Setup)</p>
	<p>PIN 9090 Restore user setting</p>
	<p>PIN 9091 Save user setting (corresponds function "Save user setup" = "ON"☞ Controller Setup)</p>
	<p>PIN 9095 Restore factory setting = delivery status</p>
	<p>Language Menu language by the factory set to English. In this menu different national languages can be selected (GB = English, D = German ...).</p>
	<p>Reset Complete re-start of the device</p>
	<p>Mode Query of the operating mode (e.g. 1.01 for speed controller)</p>
	<p>Device name Display of device name and software version</p>
	<p>Individual unit number (Menu dependent on device type available)</p>

9.8 Menu group Info

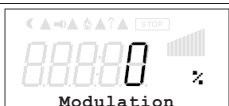
	<p>Menu group Info</p>
<p>Info for mode speed controller 1.01</p>	
	<p>Device modulation. In addition to the bar chart, the level of the output voltage with the connected load is indicated as a percentage.</p>
	<p>Display of the currently active default signal. The percentage corresponds to the internal actuation of the power component under consideration of the settings "Min. speed" and "Max. speed". 0 - 100 % \triangleq 0 - 10 V, 10 - 0 V, 0 - 20 mA, 20 - 0 mA, 4 - 20 mA, 20 - 4 mA</p>
<p>Display:</p>	<p>The device operates at:</p>

	“Set external1”	Signal to “E1” / “GND”
	“Set external2”	Signal to “E2” / “GND”
	“Set Intern1”	Menu “Set Intern1”
	“Set Intern2”	Menu “Set Intern2”
Info for mode controller 2.01... 6.01		
	Current actual value measured on the sensor 1. Depending sensor-type in: mbr, m ³ /s, m/s, Pa, %, bar, m ³ /h, °C, V, mA, etc.	
	For operation with two sensors display for “2 actual”. If function not active, display <input type="text" value="-----"/>	
	Display of the active target value at which the device operates. “Setpoint1” Menu “Setting” “Setpoint2” Menu “Setting” “Ext. Setpoint” = setting by external signal 0-10 V. With activated manual mode the display constantly changes between actual value and value for manual mode.	
	Device modulation. In addition to the bar chart, the level of the output voltage with the connected load is indicated as a percentage.	
	Momentarily status for minimum speed cut off “ON” = switch off, if Setpoint (+/- “Min. speed cut off”) is reached. “OFF” = no switch off that means operation with minimum rate of air.	

9.9 Controller Setup

	Menu group Controller Setup
---	------------------------------------

9.9.1 PIN protection activate, PIN 0010

	The adjustments for the installation in the service level can be protected against unintentional modifications. To do this, activate the “PIN protection” = “ON”. In order to simplify the initial start-up operation, the service level in the factory setting is free = “OFF” i.e. accessible without PIN 0010 .
---	--



Information

After installation of the device has been carried out, “PIN-Protection” should be activated = “ON”

9.9.2 PIN protection activate, PIN 1234

	The “Settings” menu for the user’s basic settings (Setpoint, default value, min, max ..) are freely accessible when using the factory settings (i.e. without “PIN”). If necessary, these can also be protected against unauthorized modifications by using a “ PIN 1234 ”. For this, the settings protection must be programmed to “ON”. The settings menu is then no longer visible without inputting a PIN!
Function only in combination with activated PIN-Protection!	

9.9.3 Save user settings restore with PIN 9090



The individually made device configurations (User Settings) can be saved and, with the corresponding PIN input (9091), can be reestablished.
By entering **PIN 9090** the individually made device configurations can be reestablished (Start - PIN Input).



Information

By entering “PIN 9095” in the “PIN” menu in the “start” menu-group, the device is entirely reset to the pre-delivery condition.
Any changes that have been made to the settings are thus lost!

9.9.4 Sensor Alarm ON / OFF

Function only in controller mode (2.01)!

For “E1 Analog In” and if activated for sensor 2 “E2 Analog In”.

In case of an interruption or short-circuit in the sensor conductor, or in case of measured values that lie outside of the device’s measurement range, a time-delayed fault indication takes place.

	<p>With “Alarm Sensors” = “OFF” (factory setting). Indicated sensor disturbances are displayed as “Message” alternating to the actual value and stored in the menu of “Events”.</p>	
	<p>With “AlarmSensors” = “ON” are indicated sensor disturbances as “Alarm” alternating to the actual value and stored in the menu of “Events”. Indication via relays is possible (IO Setup / function relay outputs).</p>	

9.9.5 Limit

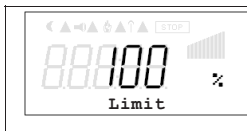

After allocation of a digital input (IO Setup) an adjustable limitation of the modulation can be activated via a digital input (“D1”, “D2”, ..).
As long as no allocation has been carried out “IO Setup”. Display: -----

“Limit value” = max. possible modulation (e.g. speed reduction during night operation by time switch).
Setting range: “Limit” = “n-max” up to “n-min”.
Factory setting: 100 % $\hat{=}$ max. modulation, i. e. no limit.
Setting depending on device type in: % or rpm.

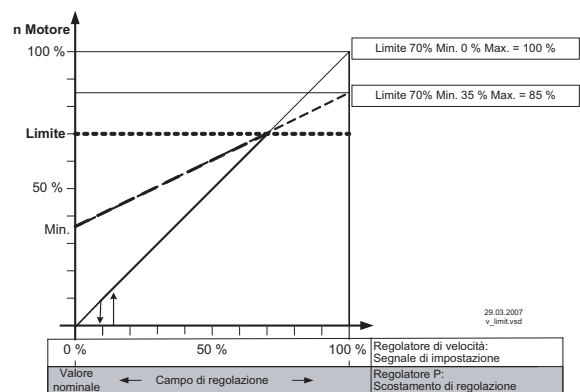

Limit (idealized principle diagram)

- nM* Motor speed
- L* Limit
- S* Setpoint
- R* Pband
- D* Speed controller: setting signal
- P* P-controller: control deviation

9.9.6 Minimum speed cut off



This function is primarily significant for installation of the device as a pure P Controller in refrigeration and air-conditioning technology.
For operation mode speed controller **1.01** without function!

Msc0 = OFF (factory setting)

If no "Min. speed" is adjusted, the fan stops with reaching the desired value.
If "Min. speed" is adjusted (e.g. 20%), then no disconnection of the fan takes place. I.e., always a minimum ventilation is ensured (fan does not go under setting "Min. speed").

Msc0. e.g. -2.0 K

It takes place a disconnection from setting "Min. speed" to "0", if the given difference is reached related to the desired value.
At a plus value (+) before reaching the desired value
At a minus value (-) after falling below the desired value.

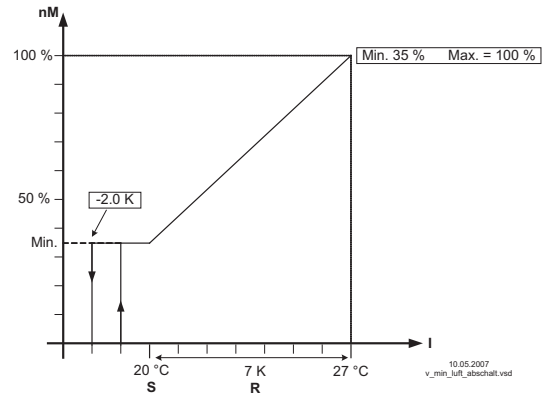

Minimum speed cut off (idealized principle diagram)

nM Motor speed
S Setpoint
R Pband
I Actual value

9.9.7 Second Group



Second group "indirectly controlled" (picture A)

Analog output "AnalogOut 1" in IO Setup function **5A** = group control is programmed. This output is employed as the default signal for a speed controller. If the default signal or the regulation deviation exceeds the group 2 switch-on point, group 1 is reduced to "n-min group 2". Starting here, both groups run parallel at maximum power.



Second group "100 % energized" (picture B)

Relay output (K1 or K2) in IO Setup function **8K** = group control is programmed. A contactor is triggered via this relay contact, which directly switches the fans of the second group to mains voltage. If the default signal or the regulation deviation exceeds the "Group 2 ON value" switch-on point, the relay for the second group switches on and the speed of the first group is lowered to an adjustable minimum value. After that, the speed of the first group increases back up to maximum.

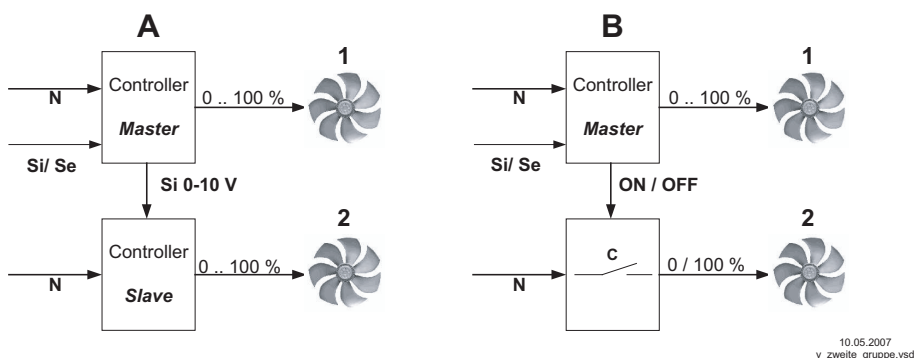

N Line
Si Signal
Se Sensor
C Contactor

9.9.8 Reverse action of the control function

	<p>For the effect of the regulation there are two functions:</p> <ul style="list-style-type: none"> • ON for “Val > Set = n+” $\hat{=}$ increasing Fanlevel for increasing actual value over Setpoint. • OFF for “Val > Set = n+” $\hat{=}$ increasing Fanlevel for decreasing actual value below Setpoint. <p>For special applications an external switch over of the control function is possible (☞ IO Setup).</p>
--	--

<p>Factory setting depending on selected mode</p> <table border="1"> <thead> <tr> <th>Mode</th> <th>Controller function</th> </tr> </thead> <tbody> <tr> <td>1.01</td> <td>non</td> </tr> <tr> <td>2.01...</td> <td>ON</td> </tr> <tr> <td>3.01...</td> <td>ON</td> </tr> <tr> <td>4.01...</td> <td>OFF</td> </tr> <tr> <td>5.01...</td> <td>OFF</td> </tr> <tr> <td>6.01...</td> <td>OFF</td> </tr> </tbody> </table>	Mode	Controller function	1.01	non	2.01...	ON	3.01...	ON	4.01...	OFF	5.01...	OFF	6.01...	OFF	<p>Example for temperature control (Idealized principle diagram)</p> <p> <i>nM</i> Motor speed <i>R</i> Pband <i>S</i> Setpoint <i>I</i> Actual value OFF for Val > Set = n+ = heating function ON for Val > Set = n+ = cooling function </p>
Mode	Controller function														
1.01	non														
2.01...	ON														
3.01...	ON														
4.01...	OFF														
5.01...	OFF														
6.01...	OFF														

9.9.9 Controller configuration

The “controller configuration” is automatically carried out during selection of the application related mode of operation (Base setup). The factory presets in accordance with the mode of operation are based on many years of experience, which is suitable for many applications. Under special circumstances, these can be individually adapted (☞ Menu group “setting”).

	<p>The type of control determines the method with which the controlled value behaves in case of a difference between the target and current values. For this, the control technology has standard algorithms, which consist of a combination of three methods:</p> <p>Selection P, PID:</p> <ul style="list-style-type: none"> • P control (Proportional component, proportion of the absolute deviation) • I control (Integral component, proportion of the sum of all deviations) • D control (Differential component, proportion of the last difference)
--	--

With pure P controllers (controller type **P**), the following described settings do not have any function. If needed, the most suitable combination for the respective control system can be determined from these proportions.

	<p>P-component = reaction time Setting range: 0 - 200 % smaller = more slowly bigger = faster</p>
	<p>I-component = accuracy, correction time Setting range: 0 - 200 % bigger = faster smaller = more slowly</p>
	<p>D-component More “D-component” causes more stability by a clean actual value signal with shorter correction times By a actual value signal with a superposition should be done to attitude without “D-component” → 0 % Setting range: 0 - 200 % value smaller = less “D-component” value higher = more “D-component”</p>

	<p>Integration time = correction time Setting range: 0 - 200 % smaller = faster bigger = more slowly</p>
---	--





9.9.10 Data on the total control deviation

The total control deviation is comprised of the sum of the control deviations for performance quantities and work quantities combined and refers to the specified areas.
 In direct reference to the acquired input and controlled variables, the maximum deviation to the target value is $< \pm 5\%$. By activating the menu-assisted adjustment, the total control deviation can be reduced to a value of $< \pm 1\%$.
 For indirect reference of the acquired input value to the controlled variable, i.e., two physical variables still need to be converted, the deviation can be reduced to $< \pm 5\%$ through adjustment.
 In the case of an internal default value through the integrated or external terminal, the control deviation remains at $< \pm 0.5\%$.

9.10 IO Setup

	<p>Menu group IO Setup</p>
---	-----------------------------------

9.10.1 Analog-Output “A”

	<p>The analog outputs 0 - 10 V can be allocated with various functions. Terminals “A” - “GND” = Analog Out (I_{max} 10 mA)</p>
	<p>With the attitudes “A min” and “A max” the characteristic of the output voltage can be adapted. Setting range: “A min.” = 0 - 5 V, “A max.” = 10 - 5 V Factory setting: “A min.” = 0 V, “A max.” = 10 V</p>
	
	<p>With the attitudes “A Inverting” the output voltage can be inverted. Factory setting: “A Inverting” = “OFF”</p>

Function	Description
OFF	without function
1A	Constant voltage +10 V (factory setting)
2A	Proportional the internal control of modulation with consideration “Min. speed” and “Max. speed” setting. <ul style="list-style-type: none"> for enable “OFF” it goes back to 0 V for motor fault the output signal remains for a slave controller (“Master-Slave” combination).
3A	proportional input “E1”
4A	proportional input “E2”
5A	Group control (☞ Controller Setup - second group)
6A	Control output 2 increasing modulation at actual value > Set = cooling (only mode 2.03 temperature controller with additional functions).
7A	Control output 2 increasing modulation at actual value < Set (Heating) only mode 2.03 temperature controller with additional functions).

A1 Function “A min.” and “A max.”

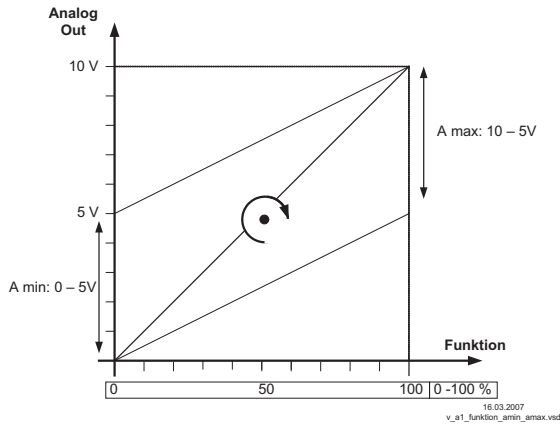

A1 Function **3A** / **4A**

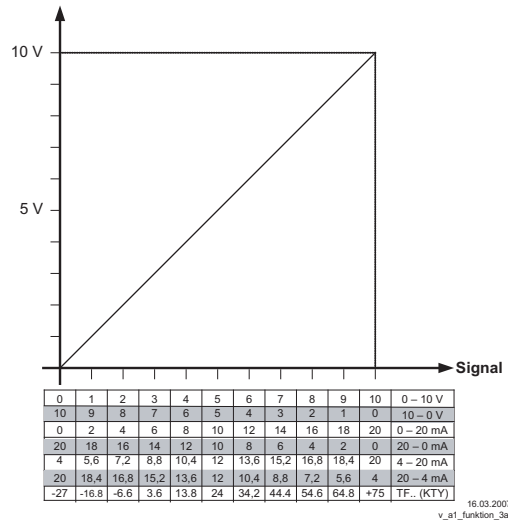

9.10.2 Digital inputs “D1” / “D2”

9.10.2.1 Menu overview

	The digital inputs Digital In 1 (D1) and Digital In 2 (D2) can be allocated with various functions. Activation via floating contacts (a low voltage of approx. 24 V DC is connected).
	Inverting “D1” and “D2” possible
	With networking the digital inputs can be replaced by control over bus. With mode of operation 4.03 pre-setting of “D1” and “D2” is ON .



Attention!
Never apply line voltage to the digital input!

Function	Description
OFF	No function (factory setting)
1D	Enable (remote control) “ON” / “OFF”
2D	External error
3D	“Limit” ON / OFF
4D	Switch over “E1” / “E2”
For mode speed controller 1.01	
5D	Switch over “Set Intern1” / “Set Intern2”
6D	Switch over “Intern” / “Extern”
For modes as controller higher 2.01	
5D	Switch over “Setpoint1” / “Setpoint2”
6D	Switch over “Intern” / “Extern”
7D	Switch over “automatic control” / “Speed manual”
8D	Switch over control function (e.g. “heating” / “cooling”)

10D	“Reset”
11D	Setting Max. Speed “ON” / “OFF”
12D	Motorheating ON / OFF (not for 1~ voltage controller)
13D	Reverse direction of rotation “right-hand” / “left-hand” (only for frequency inverter with 3 ~ output)
14D	“Freeze function” = maintain momentary modulation value

9.10.2.2 Enable ON/OFF function [1D]

Remote ON/OFF (electronic disconnection) and Reset after a motor malfunction via floating contact. The power section is electronically disconnected. Operation of the device is still possible after pressing the “Esc” hotkey combination in switched-off condition. Signal- in and outputs remain active.

- A programmed operating indicator relay (factory set “K1 function” = [1K]) reports the switch-off.
- A programmed alarm relay (factory set “K2 function” = [2K]) does not report the switch-off.

	<p>Display STOP for switch OFF</p> <ul style="list-style-type: none"> • Controller “ON” for closed contact (factory setting). • Controller “OFF” with opened contact <p>When inverting in reverse i.e. equipment “OFF” with closed contact.</p>	<p>10.05.2007 v_1d_freigabe_d1_d1.vsd</p> <p>Contact at digital input e.g. “Digital In 1”</p>
--	--	---



Attention!
No disconnection when turned off (no isolation in accordance with VBG4 §6)!

9.10.2.3 External fault Function [2D]

Connecting an external alarm indication (via floating contact). The device continues to work unchanged during an external indication to the digital input; the alarm symbol appears in the display. This indication can be issued via the relay contacts (K1, K2) (IO Setup function K1, K2). Example for connecting an external alarm indication e.g. to digital input “Digital In 1”

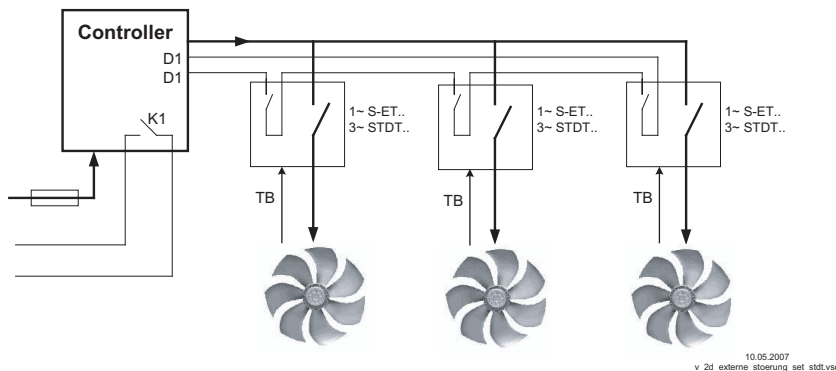

- Indication during closed contact (factory setting): “D1 Inverting” = “OFF”
- Indication during opened contact: “D1 Inverting” = “ON”

	<p>Alarm symbol for indication “External fault”</p>
--	---

9.10.2.4 Limit ON / OFF, Function [3D]

The value for “Limit” adjusted in the Controller Setup, is activated over a digital input.

Contact e.g. at digital input “Digital In 1” (depending on device type at terminals “D1” - “D1” or “D1” - “24 V”).
 For “D1” Inverting “OFF”, limitation active at closed contact.

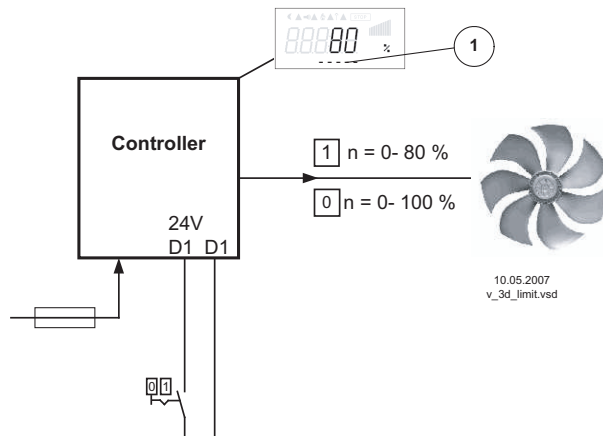

1 Setting “Limit” (depending on device type in: %, Hz, rpm)

9.10.2.5 Switch over Input signal “E1” / “E2”, Function 4D

Switch over between Input signal 1 (Analog In 1 terminal “E1”) and input signal 2 (Analog In 2 terminal “E2”).

Contact e.g. at digital input “Digital In 1” (depending on device type at terminals “D1” - “D1” or “D1” - “24 V”).

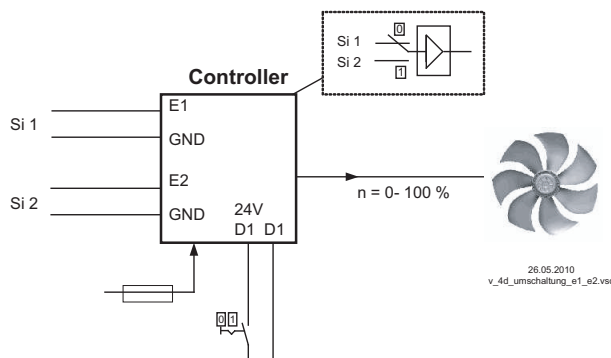

Si 1 Signal 1
 Si 2 Signal 2

For mode speed controller (1.01) Base setup for “E2 Analog In”: 1E necessary.

For modes controller (higher 2.01 ..) Base setup for “E2 Analog In”: 7E necessary (as far as otherwise does not occupy).

9.10.2.6 Set 1/2 or Setpoint 1/2, Function 5D

Switch over between “Set Intern1” and “Set Intern2” (for speed controller 1.01)

Contact e.g. at digital input “Digital In 1” (depending on device type at terminals “D1” - “D1” or “D1” - “24 V”).

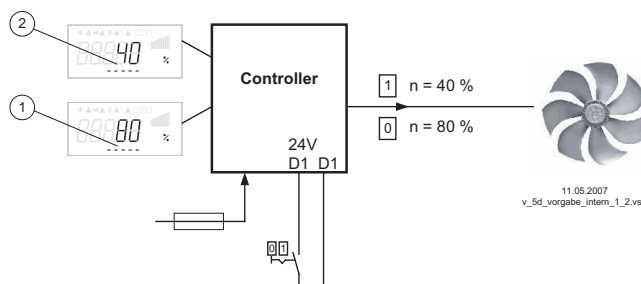

1 Setting “Set Intern1” (depending on device type in: %, Hz, rpm)
 2 Setting “Set Intern2” (depending on device type in: %, Hz, rpm)

- “D1 Inverting” = “OFF”: “Set Intern1” at opened contact / “Set Intern2” at closed contact.
- “D1 Inverting” = “ON”: “Set Intern1” at closed contact / “Set Intern2” at opened contact.

	<p>Operation with “Set Intern2” is signaled by the moon symbol for reduced operation. “Set extern1” under “settings” must be programmed to “OFF”.</p>
---	---

Switch over between “Setpoint1” and “Setpoint2” (for modes as controller higher **2.01**)

Contact e.g. at digital input “Digital In 1” (depending on device type at terminals “D1” - “D1” or “D1” - “24 V”).

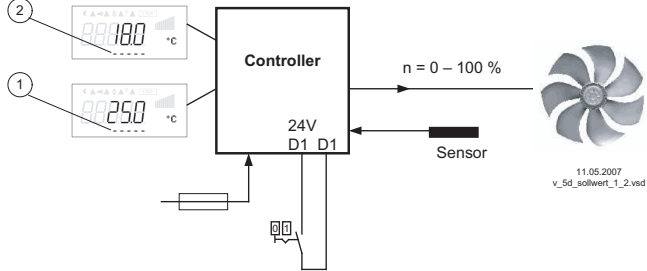

1 Setting “Setpoint1”
2 Setting “Setpoint2”

- “D1 Inverting” = “OFF”: “Setpoint1” = 18 °C at opened contact / “Setpoint2” = 25 °C at closed contact.
- “D1 Inverting” = “ON”: “Setpoint1” = 18 °C at closed contact / “Setpoint2” = 25 °C at opened contact.

	<p>Operation with “Setpoint2” is signaled by the moon symbol for reduced operation.</p>
---	---

9.10.2.7 Intern / Extern Function [6D]

Switch over between Set Intern and Set Extern (for mode speed controller **1.01**). “Set extern1” under settings must be programmed to “OFF”.

Contact e.g. at digital input “Digital In 1” (depending on device type at terminals “D1” - “D1” or “D1” - “24 V”).

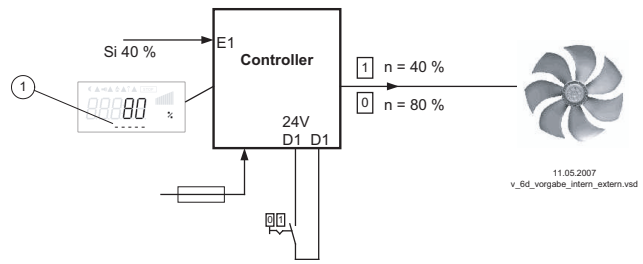

Si Signal
1 Setting “Set Intern1” (depending on device type in: %, Hz, rpm)

- “D1 Inverting” = “OFF”: “Set Intern1” at opened contact / “Setting Extern” at closed contact.
- “D1 Inverting” = “ON”: “Set Intern1” at closed contact / “Set Extern” at opened contact.

“Setpoint1” / “external Setpoint” (modes **2.01**)

Under Base setup “E2 function” programmed to function **[1E]** for “external setpoint” .

Contact at digital input e.g. “Digital In 1” = “D1” - “D1”

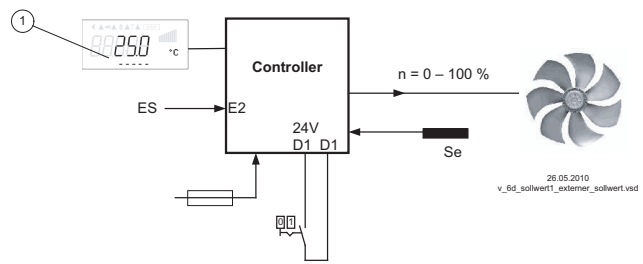

1 Setting “Setpoint1”
ES External Setpoint e.g. 5 V Δ 23.8°C
Se Sensor

- “D1 Inverting” = “ON”: Setting at the unit at opened contact / Signal Extern at closed contact
- “D1 Inverting” = “OFF”: Setting at the unit at closed contact / Signal Extern at opened contact

9.10.2.8 Automatic control / speed manual, Function [7D] (mode 2.01)

Switch over between automatic control to set target value (depending on the activation: “Setpoint1”, “Setpoint2”) and the default for “manual operation” set at the device.
 If for Analog In 2 “E2 function” is programmed to [2E] switch over between “Setpoint1” or “Setpoint2” and external manual operation. With activated manual mode the display constantly changes between “actual value” and value for “manual mode”.
 Contact at digital input e.g. “Digital In 1”

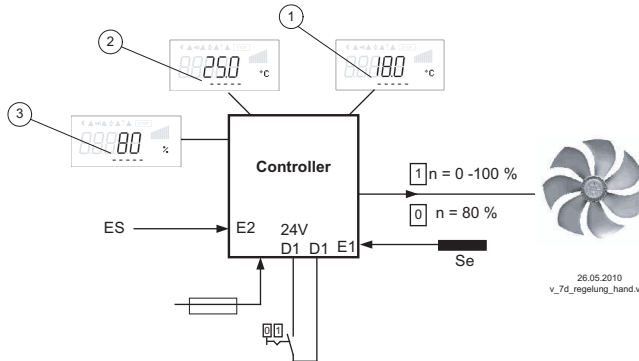

- “D1 Inverting” = “OFF” Automatic control at opened contact / manual operation at closed contact.
- “D1 Inverting” = “ON”: Automatic control at closed contact / manual operation at opened contact.

1 Setting “Setpoint1”
 2 Setting “Setpoint2”
 3 Setting “Speed manual” (depending on device type in: %, Hz, rpm)
 EH Signal for Manual mode extern, E2 Function = [2E]
 Se Sensor

9.10.2.9 Reverse action of control function (2.01), Function [8D]

Switchover between: Increasing modulation during increasing actual-value and increasing modulation during sinking actual-value.
 The factory presets for the “Control function” are dependent on the selected mode of operation (☞ Controller Setup - reverse operation of the control function).
 When switching over via a digital input, the device works with the opposite function than the one set there!

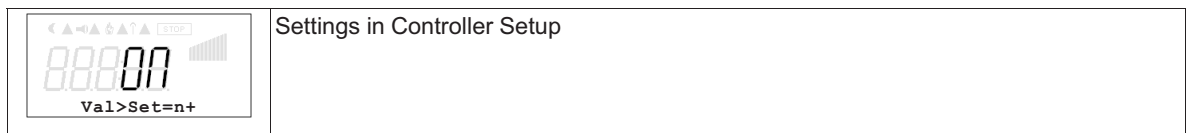

9.10.2.10 Reset, Function [10D]

Reset after motor fault by using a non-locking reset key. The unit switches off when interruption between both “TB/TP” or “TK/PTC” terminals, the unit then remains switched off (“motor fault” see ☞ motor protection). Re-starting after the drive has cooled down (terminals “TB/TP”- or “TK/PTC” bridged) by non-locking reset key possible.

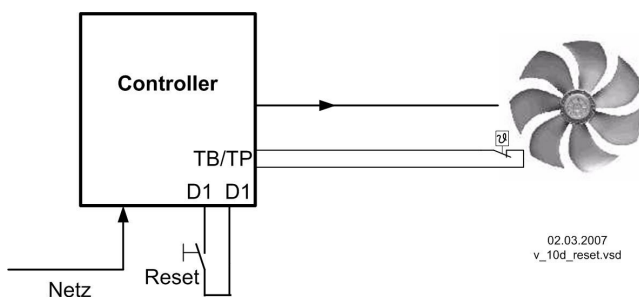

- For “D1 Inverting” = “OFF” both terminals “D1”- “D1” in normal operation interrupted. Reset after fault by short close.(For “Inverting” = “ON” reverse function).

Contact at digital input e.g. “Digital In 1”

9.10.2.11 Setting Max. Speed ON / OFF function [11D]

The value for “Max Speed” adjusted in menu “Settings”, is activated over a digital input. I.e. the unit works independently of the controller function firm with this value.
 Contact e.g. at digital input “Digital In 1” (depending on device type at terminals “D1” - “D1” or “D1” - “24 V”).

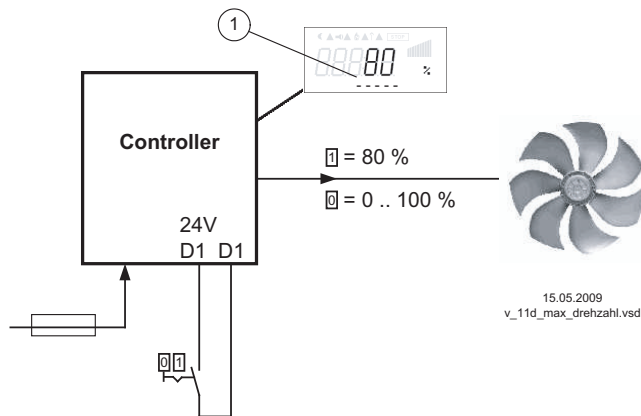

- “D1 Inverting” = “OFF”: “Max. Speed” active at closed contact
- “D1 Inverting” = “ON”: “Max. Speed” active at opened contact

1 Setting “Max. Speed” (depending on device type in: %, Hz, rpm)

9.10.2.12 Motorheating ON / OFF, Function [12D]

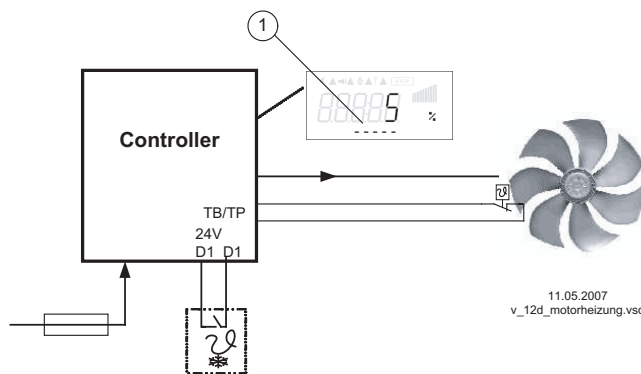

The motor heating can be activated over a digital input.
 E.g. over a freeze protection thermostats at digital input “Digital In 1” (depending on device type at terminals “D1” - “D1” or “D1” - “24 V”).

1 Setting “Motorheating”

Motor heating automatically active at closed contact, if no modulation of the controller is present (for “D1” = Inverting “OFF”).

The height of the “heating voltage” is set in “Motor Setup”.

Setting range: 5...50 %

Factory setting: 5 %

	The activated motor heating is indicated alternating with the actual value.
--	---

9.10.2.13 “Freeze function” = maintain momentary modulation value, Function [14D]

The device continues to work so long independently of the controller function with the momentary value of the modulation and / or speed as activated over the digital input.

	Message indicated alternating with the active value “Freeze Function”
--	---

Contact at digital input e.g. “Digital In 1”

“D1 Inverting” = “OFF”: “Freeze function” at closed contact activ

“D1 Inverting” = “ON”: “Freeze function” at opened contact activ

9.10.3 Inverting analog inputs “E1” / “E2”

After programming the signal or sensor type, an inversion of the inputs can be carried out.



Factory setting for Inverting inputs = “OFF” (if input activated) (signal: 0 - 10 V, 0 - 20 mA, 4 - 20 mA).

For activation using inverted default signals or sensors with inverted output signals proportional to the measurement range, switch inverting to “ON” (Signal: 10 - 0 V, 20 - 0 mA, 20 - 4 mA).

Example: mode speed controller, setting by external signal

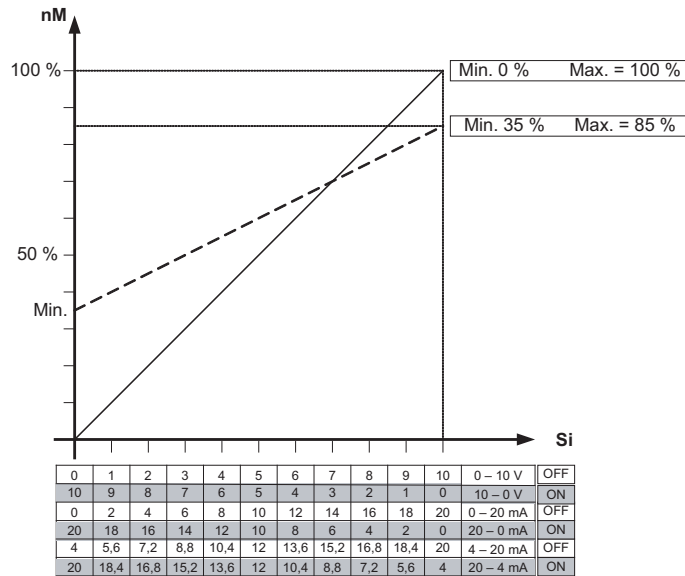

11.05.2007
v_invertierung_anlaog_eingaenge.vsd

nM Motor speed
Si Signal
OFF Inverting = OFF
ON Inverting = ON

9.10.4 Function and inverting for relay outputs “K1” and “K2”

Various functions can be allocated to the relay outputs “K1” and “K2”. In case of the same function allocation for “K1” and “K2”, these work parallel.

The factory preset is the inversion of relay “K1” and “K2” to “OFF” (if a function has been programmed).

Switch to “ON” for inversion (switch-time response depends on the allocated function). Fundamentally, the relays can only become operative if the electronic’s voltage supply is functioning. At least 2 current phases must be present!

Function	Description
OFF	No function Relays remain always de-energized
1K	Operating indication (factory setting for “K1”, non inverting). Operation without fault, reports enable “OFF”

2K	Fault indication (factory setting for "K2", non inverting). Energized for operation without fault, for enable "OFF" not energized. De-energized at line, motor and controller fault, Sensor fault dependent on programming, external fault at digital input.
3K	External fault separate with message at digital input (factory setting if terminals bridged)
4K	Limit modulation Over or falling below limits for modulation
5K	Limit "E1" When over or falling below limits for input signal "E1"
6K	Limit "E2" When over or falling below limits for input signal "E2"
8K	Group control (Group 2) Switching on fans depending on modulation
12K *	Group control (Group 3) Switching on fans depending on modulation
13K *	Group control (Group 4) Switching on fans depending on modulation
	For modes as controller higher 2.01
7K	Setpoint Offset Deviation between actual value and setpoint to high
	For modes as temperature controller with additional functions 2.03
9K	Heating function Switch ON point: temperature = Setpoint +/- Offset Switch OFF point: Temperature around hysteresis over switch ON point
10K	Cooling function Switch ON point: temperature = Setpoint +/- Offset Switch OFF point: Temperature around hysteresis below switch ON point

* Function depending on the version of the software available

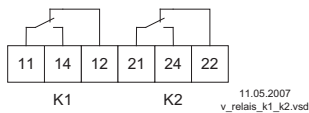

- K1** 1 = energized, terminals 11-14 bridged
0 = de-energized, terminals 11-12 bridged
- K2** 1 = energized, terminals 21-24 bridged
0 = de-energized, terminals 21-22 bridged

Function	Controller status	K1/ K2	
		1 = energized 0 = de-energized	
		Inverting	
		OFF	ON
1K	Operation without fault, line supply okay	1	0
2K	Fault with indication by relay	0	1
3K	Ext. Fault at digital input for external fault	1	0
4K	Over or falling below limits for modulation	1	0
5K	over or falling below limits for input signal "E1"	1	0
6K	over or falling below limits for input signal "E2"	1	0
7K	setpoint deviation to high	1	0
8K	Activation of second group	1	0
12K	Activation of third group	1	0
13K	Activation of fourth group	1	0

9.10.5 Programming Add-on module type Z-Modul-B

Program the additional inputs and outputs likewise in “IO Setup”.

After connecting the module, the settings menus are automatically expanded to include the additional inputs and outputs.

- 1 x analog input 0 - 10 V. For mode **1.01** without function, starting from **2.01** funktion **1E** or **2E** possible.
 - Function **1E** for external target value function.
 - Function **2E** for external manual operation.
- 1 x output 0 - 10 V (A2 / GND), Function programmable, e.g., for: Fixed voltage, proportional level control, proportional input signal, group control, drive 2.
- 3x digital inputs (D3 / GND, D4 / GND, D5 / GND) function programmable, e.g.: Enable (ON / OFF), external malfunction, output limitation, input 1/2, target value 1/2, internal/external preset, controller / manual operation, control-function reversal (“heating” / “cooling”).
- 2 x relay outputs (“K3” and “K4”) Function programmable, e.g., for: Status signals, alarm indications, external malfunctions at the digital input, level-control threshold, input signal threshold, offset threshold (deviation between current and target value), group control.

Parameter	Factory setting	User Setting
A2 Function	1A	
A2 min.	0.0 V	
A2 max.	10.0 V	
A2 Inverting	OFF	
D3 Function	OFF	
D3 Inverting	----	
D4 Function	OFF	
D4 Inverting	----	
D5 Function	OFF	
D5 Inverting	----	
E3 Function	OFF	
E3 Inverting	----	
K3 Function	OFF	
K3 Inverting	----	
K4 Function	OFF	
K4 Inverting	----	

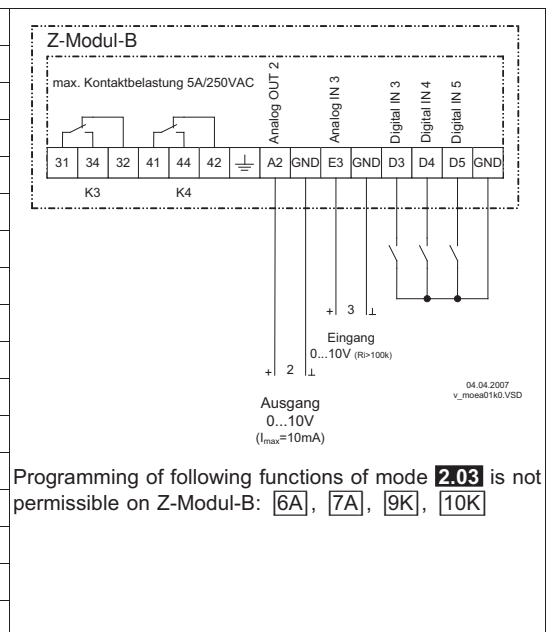

9.10.6 Networking via MODBUS

It is possible to network several devices with each other. The device uses the MODBUS-RTU as the protocol for the RS-485 interface.

The device address (Device-ID) is factory set to the highest available MODBUS address: 247

This address is reserved for operation with an external terminal model AXG.. and should not be occupied with anything else.

	<p>Bus Address</p> <p>The addresses of the individual units must be continuously numbered beginning with “1”. No address may be allocated twice. MODBUS address adjustable from 1-247. Address 247 = preprogrammed for an external terminal.</p>
	<p>Addressing</p> <p>Switch addressing to “ON” before setting “address”.</p>





Reading and writing parameters

The device supports reading and writing processes for MODBUS Holding Registers. The start address is 0; the number of registers depends on the device. If the allowable start address or number is exceeded, the device answers with an exception code. The description of the register is device dependent and can be requested from service for the device/version concerned.

9.11 Limits

	Menu group Limits
---	--------------------------

9.11.1 Limit indication depending on modulation

	Following functions can be allocated to the limit indication	
	OFF	without function
	1L	Indication with the centralized fault of a programmed relay (IO allocation Function $\boxed{2K}$). Warning symbol in display, "AL" code in events memory.
	2L	Is merely displayed in the events menu as message "msg".
In the IO setup, a separate relay can be allocated independent of these settings.		
	If the modulation exceeds the set "Level max" value, this is reported until the set value "Level min" has been undercut. Setting range "Modulation min.": "Min. Speed" - "Modulation max." Setting range "Modulation max.": "Modulation min." - "Max. Speed"	
	The indication is delayed by the time set in "Display delay".	
	Time delay exceeding "Level max." up to indication by relay and alarm symbol. Setting range: 0 - 120 sec. Factory setting: 2 sec.	

Example indication by relay "K1":

not inverted

IO Setup: K1 Function = 4K
IO Setup: K1 Inverting = OFF

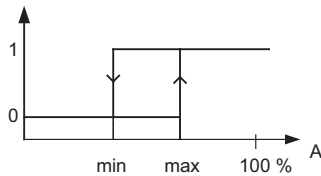

Inverting

IO Setup: K1 Function = 4K
IO Setup: K1 Inverting = OFF

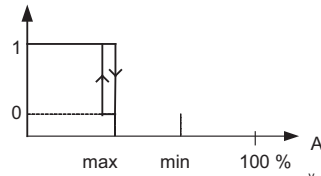
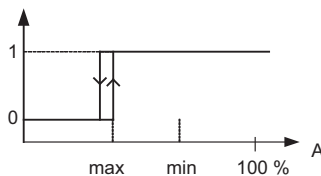
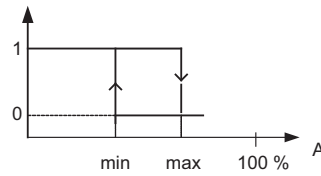





A Modulation

A Modulation

If "Level min." is higher than "Level max.", the "Level max." switching point is without hysteresi.

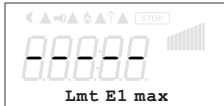
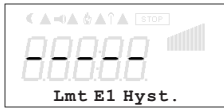
9.11.2 Limit indication depending on setting or sensor signal

	<p>Following functions can be allocated to the limit indication</p>
<p>OFF without function</p>	<p>1L Indication with the centralized fault of a programmed relay (IO allocation Function [2K]). Warning symbol in display, "AL" code in events memory.</p>
<p>2L Is merely displayed in the events menu as message "msg".</p>	<p>In the IO setup, a separate relay can be allocated independent of these settings.</p>
	<p>Both values for E1 ("E1 min" and "E1 max") can be set independent of each other and act on a relay together if correspondingly programmed. If a function is activated or if a relay is allocated, both settings ("min" and "max") are initially at "OFF". Work can be carried out with one as well as with both limit indicators.</p>
	<p>The same setting applies to "E2 Min." and "E2 Max.", described below for "E1". Undercutting the signal ("E1 min"). If the signal undercuts the set value "E1 min", this is reported until the set value (plus adjustable hysteresis) has been exceeded once again. Exceeding the signal ("E1 max"). If the signal exceeds the set value "E1 max", this is reported until the set value (minus hysteresis) has been undercut once again.</p>
	<p>E1 Hysteresis Hysteresis adjustment in the unit of measure of the programmed input signal.</p>
	<p>E1 Delay Time delay exceeding "Level max." up to indication by relay and alarm symbol. Setting range: 0 - 120 sec. Factory setting: 2 sec.</p>



Information

Always adjust the value for the maximum input signal higher than the value for the minimum input signal!
E1 Max. > E1 Min.

Example for a limit indication of default signal or sensor signal to "Analog In 1"

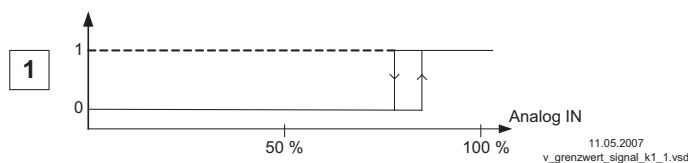

Settings:

- E1 Max.: 80 %
- E1 Min.: OFF
- switching hysteresis 5 % (from 100 %)

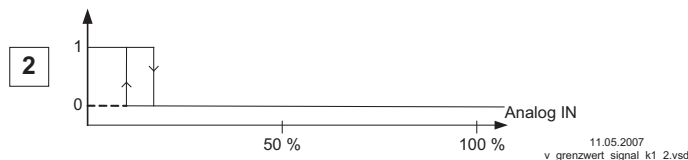

Settings:

- E1 Min.: 20 %
- E1 Max.: OFF
- switching hysteresis 5 % (from 100 %)

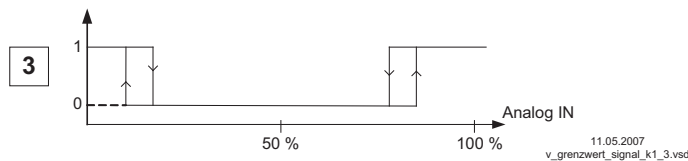







Settings:

- E1 Min.: 20 %
- E1 Max.: 80 %
- switching hysteresis 5 % (from 100 %)

Terminal "E1" and "GND" alarm via relay "K1" (non-inverted) IO Setup → K1 function: [5K] = limit indicators

9.11.3 Limit indication depending on (offset) to Setpoint

In operating modes as a controller (via **2.01**), two limit indicators can be carried out based on the set target value (Setpoint) and measured actual value (on E1).

 <p>Offset Function</p>	<p>Following functions can be allocated to the limit indication</p> <table border="1"> <tr> <td>OFF</td> <td>without function</td> </tr> <tr> <td>1L</td> <td>Indication with the centralized fault of a programmed relay (IO allocation function [2K]) warning symbol in display, "AL" code in events memory.</td> </tr> <tr> <td>2L</td> <td>Is merely displayed in the events menu as message "msg".</td> </tr> </table> <p>In the IO setup, a separate relay can be allocated independent of these settings.</p>	OFF	without function	1L	Indication with the centralized fault of a programmed relay (IO allocation function [2K]) warning symbol in display, "AL" code in events memory.	2L	Is merely displayed in the events menu as message "msg".
OFF	without function						
1L	Indication with the centralized fault of a programmed relay (IO allocation function [2K]) warning symbol in display, "AL" code in events memory.						
2L	Is merely displayed in the events menu as message "msg".						
 <p>Offset 1</p>	<p>Offset 1, Offset 2</p> <p>Both values for Offset 1 and Offset 2 can be set independent of each other and act on a relay together if correspondingly programmed. If a function is activated or if a relay is allocated both settings (Offset 1 and Offset 2) are initially at "OFF".</p> <p>Work can be carried out with one as well as with both limit indicators.</p>						
 <p>Offset 2</p>	<p>"Offset 1" for alarm in case of an exceeding of the max. deviation between actual and target.</p> <p>Switch ON point: actual value = Setpoint +/- offset Switch OFF point: Actual value by hysteresis under the switch-on point</p>						
 <p>Offset Hyst.</p>	<p>"Offset 2" for alarm in case of an undercutting of the max. deviation between actual and target</p> <p>Switch ON point: actual value = Setpoint +/- offset Switch OFF point: Actual value by hysteresis over the switch-on point</p>						
 <p>Offset Del.</p>	<p>Offset Hysteresis</p> <p>Hysteresis switch-on point: In temperature regulation + / - 10 K, otherwise sensors 10 % of measurement range</p>						
 <p>Offset Del.</p>	<p>Offset Delay</p> <p>Time delay until indication through relay and alarm symbol.</p> <p>Setting range: 0 - 120 sec. Factory setting: 2 sec.</p>						

Example for temperature regulation; for other modes of operation settings in corresponding sensor unit.

Offset 1 for alarm during exceeding

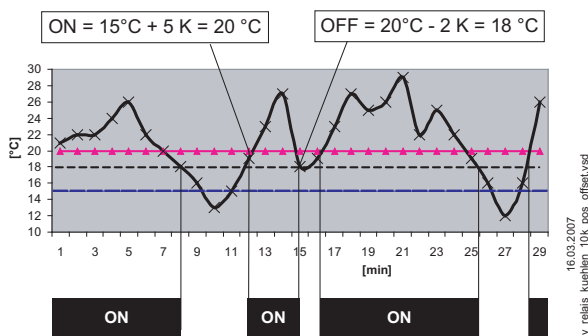

Example: Setpoint 15.0 °C, Offset +5.0 K, Hysteresis 2.0 K

Offset 2 for alarm during undercutting

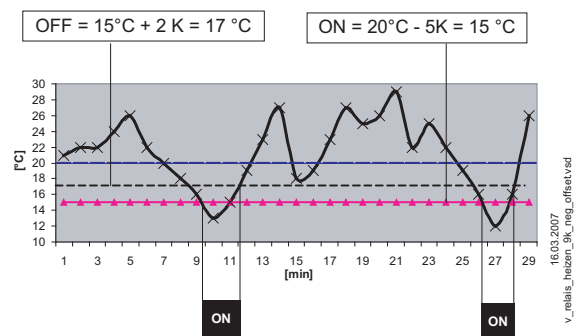

Example: Setpoint 15.0° C, Offset -5.0 K, Hysteresis 2.0 K

9.12 Motor Setup

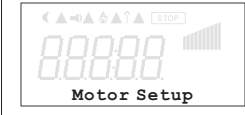
	<p>Menu group Motor Setup</p>
---	--------------------------------------

9.12.1 Adjusting of CosPhi for motor



The control device is set to CosPhi = 0.80 at the factory. For optimal control response, the CosPhi of the installed motor must be entered (see specification on the type identification tag of the motor).

	<p>CosPhi</p> <p>The output voltage of the unit depends on the inductance of the motor (CosPhi). If the CosPhi of the motor is smaller than the set value, the maximum output voltage is reached in speed controller mode below the maximum input signal (<10 V / 20 mA). For mode as controller (P-controller) at a system control deviation which is too low. If the CosPhi of the motor is significantly greater than the set value, the maximum output voltage may not be reached under certain circumstances. If a noise filter is connected at the output of the control device, calibration takes place by means of the associated noise filter condensers (CosPhi almost "1"). Setting of CosPhi for operation with noise filter: recommendation 0.95 Setting range: 0.00...1.00 Factory setting: 0.80</p>
---	---

9.12.2 Setting for Rampup time and Rampdown time

By separate menus for Rampup time and Rampdown time an adjustment is possible to individual system conditions.

This function is switched behind the actual controller function.

	<p>Rampup time</p> <p>Time setting in which the automatic controller output from 0 % to 100 % rises. Setting range: 0...250 sec. Factory setting: 10 / 20 / 30 / 40 sec. (depending on device type)</p>
	<p>Rampdown time</p> <p>Time setting in which the automatic controller output from 100 % to 0 % reduces. Setting range: 0...250 sec. Factory setting: 10 / 20 / 30 / 40 sec. (depending on device type)</p>

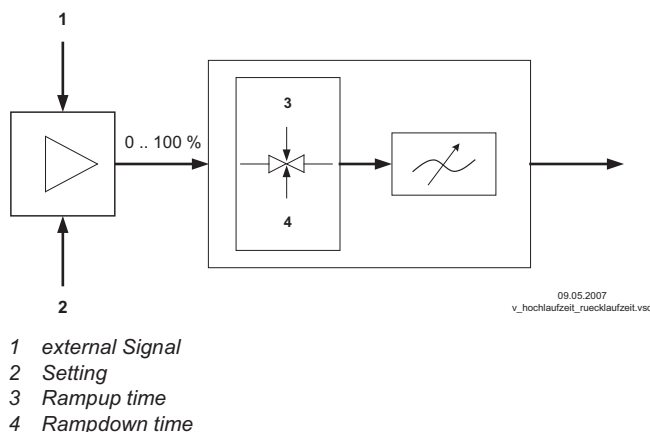

9.12.3 Suppression of speeds

Suppression of up to three speed ranges.

Under certain circumstances, it is possible to prevent disturbing noises that can arise at certain speeds due to resonances.

Example for suppression of 2 ranges (Idealized principle diagram)

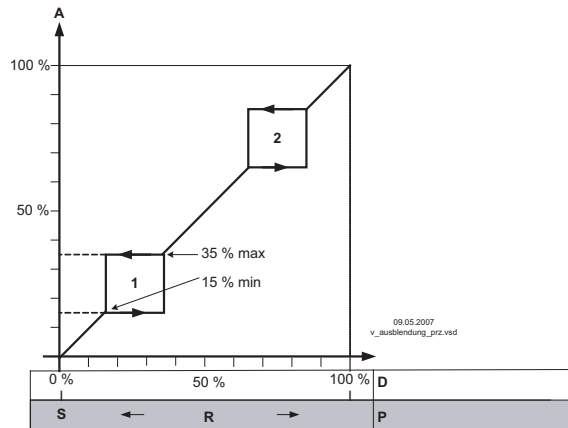

Setting depending on device type in: %, Hz, rpm

- A Modulation
- S Setpoint
- R Pband
- D Speed controller: setting signal
- P P-controller: control deviation

	→	Factory setting no suppression active = "OFF"	→	
	→	Setting for "Range1 min." Setting range: "Shutdown Freq." - "Range 1 max."	→	
	→	Setting for "Range1 max." Setting range: "Range 1 max." - "Max. Frequency"	→	
	→	Identical procedures for Suppression2 and Suppression3, as far as desired	→	etc.

9.12.4 Motorheating

In order to avoid a sticking or a freezing of standing fans in cold environment, the "motor heating system" can be switched on.

Set the voltage in % that is applied to the 2 phases when the heating function is active.

Setting range: 5...50 %

Factory setting: 5 %

This impresses a current that cannot cause the fan to rotate. The required voltage to prevent freezing depends on the ambient conditions and the technical data of the connected motors. Test the settings you have made under realistic conditions. The higher the output voltage adjustment, the greater the arising heating output (power loss) in the motor. The „motor heating“ or „standstill motor heating“ can only be active if no modulation is present due to closed-loop control. The motor heating can also be activated through the enable function (function [1D] for a digital input) during shutdown. To exclude overheating, motor protection is required through the temperature monitor integrated in the motor (☞ Motor protection). The heating function is shut down if the motor protection function in the controller is activated.

10 Menu tables

10.1 Menues of operating modes

Mode	1.01	2.01 2.03 2.04	2.02	2.05	3.01 3.02	3.03 3.04	4.01 4.02 4.03	5.01 5.02	6.01	User Setting
Parameter	Factory setting									
Start										
PIN input	-----	-----	-----	-----	-----	-----	-----	-----	-----	
Language	GB	GB	GB	GB	GB	GB	GB	GB	GB	
Reset	OFF	OFF	OFF	OFF	OFF	OFF	OFF	OFF	OFF	
Mode	1.01	2.01 2.03 2.04	2.02	2.05	3.01 3.02	3.03 3.04	4.01 4.02 4.03	5.01 5.02	6.01	
Ucontrol	1.13	1.13	1.13	1.13	1.13	1.13	1.13	1.13	1.13	
Info										
E1-E2 actual				-2.4 °C						
Control value		2.04 = 30.0 °C				12.0 bar 22.6 °C				
E1 Actual		30.0 °C	30.0 °C	30.0 °C	10.0 bar 9.5 °C	10.0 bar 9.5 °C	88.7 Pa	712 m ³ h	0.45 m/s	
E2 Actual		----- 2.04 = 30.0 °C	-----	30.0 °C	-----	10.0 bar 9.5 °C	----- 4.02, 4.03 = 21.0 °C	----- 5.02 = 21.0 °C	-----	
Setpoint1		20.0 °C	5.0 °C	0.0 °C	12.0 bar 35.0°C	12.0 bar 35.0°C	100 Pa	530 m ³ h	0.50 m/s	
Setpoint control							4.02, 4.03 = 100 Pa	5.02 = 530 m ³ h		
Modulation	0 %	0 %	0 %	0 %	0 %	0 %	0 %	0 %	0 %	
Set external1	0 %									
Msc0		OFF	OFF	OFF	OFF	OFF	OFF	OFF	OFF	
Setting										
Set Intern1	80 %									
Set Intern2	-----									
Setpoint1		20.0 °C	5.0 °C	0.0 °C	12.0 bar 35.0°C	12.0 bar 35.0°C	100 Pa	530 m ³ h	0.50 m/s	
Setpoint2		-----	-----	-----	-----	-----	----- 4.03 = 100 Pa	-----	-----	
Pband		5.0 K	20.0 K	5.0 K	5.0 bar 7.0 K	5.0 bar 7.0 K	100 Pa	530 m ³ h	0.50 m/s	
Min. Speed	0 %	0 %	0 %	0 %	0 %	0 %	0 %	0 %	0 %	
Max. Speed	100 %	100 %	100 %	100 %	100 %	100 %	100 %	100 %	100 %	
Set external1	ON									
Manual mode		OFF	OFF	OFF	OFF	OFF	OFF	OFF	OFF	
Speed man.		100 %	100 %	100 %	100 %	100 %	100 %	100 %	100 %	
Offset AnalogOut		2.03 = 0.0 K								
Pband AnalogOut		2.03 = 2.0 K								

Mode	1.01	2.01 2.03 2.04	2.02	2.05	3.01 3.02	3.03 3.04	4.01 4.02 4.03	5.01 5.02	6.01	User Setting
	Factory setting									
Min. AnalogOut		2.03 = 0 %								
Max. AnalogOut		2.03 = 100 %								
OffsetDigitalOut		2.03 = - 1.0 K								
Hyst.DigitalOut		2.03 = 1.0 K								
Alarm Minimum		2.03 = 0.0 °C								
Alarm Maximum		2.03 = 40.0 °C								
T-Band SA							4.02 + 4.03 = 30.0 K	5.02 = 30.0 K		
T-Start SA							4.02 + 4.03 = 15.0 °C	5.02 = 15.0 °C		
P-Min SA							4.02 + 4.03 = 70.0 Pa	5.02 = 70.0 m ³ /h		
Events										
Base setup										
Mode	1.01	2.01 2.03 2.04	2.02	2.05	3.01 3.02	3.03 3.04	4.01 4.02 4.03	5.01 5.02	6.01	
E1 Analog In	0 - 10 V	TF	TF	TF	0-30 MBG	0-30 MBG	DSG200	DSG200	0-1 MAL	
E1 Refrigerant					3.02 = R503	3.04 = R503				
E1 K-Factor								75		
E1 Min.		-----	-----	-----	-----	-----	-----	-----	-----	
E1 Max.		-----	-----	-----	-----	-----	-----	-----	-----	
E1 Decimals		-----	-----	-----	-----	-----	-----	-----	-----	
E1 Unit		-----	-----	-----	-----	-----	-----	-----	-----	
E1 Offset		0.0 K	0.0 K	0.0 K	0.00 bar 0.0 K	0.00 bar 0.0 K	0.0 Pa	0.0 Pa	0.0 m/s	
E2 Function	OFF	OFF 2.04 = 4E	OFF	5E	OFF	4E	OFF 4.02 + 4.03 = 6E	OFF 5.02 = 6E	OFF	
E2 Analog In	-----	----- 2.04 = TF	-----	TF	-----	0-30 MBG	----- 4.02 = TF 4.03 = Bus	----- 5.02 = TF	-----	
E2 Refrigerant					3.02 = -- ---	3.04 = R503				
E2 K-Factor								5.01 = 75		

Mode	1.01	2.01 2.03 2.04	2.02	2.05	3.01 3.02	3.03 3.04	4.01 4.02 4.03	5.01 5.02	6.01	User Setting
	Factory setting									
E2 Min.		-----	-----	-----	-----	-----	----- 4.03 = -- 35.0 °C	-----	-----	
E2 Max.		-----	-----	-----	-----	-----	----- 4.03 = 65.0 °C	-----	-----	
E2 Decimals		-----	-----	-----	-----	-----	----- 4.03 = 1	-----	-----	
E2 Unit		-----	-----	-----	-----	-----	----- 4.03 = °C	-----	-----	
E2 Offset		----- 2.04 = 0.0 K	-----	0.0 K	-----	0.00 bar 0.0 K	----- 4.02 + 4.03 = 0.0 K	----- 5.02 = 0.0 K	-----	
Controller Setup										
PIN Protection	OFF	OFF	OFF	OFF	OFF	OFF	OFF	OFF	OFF	
Set protection	OFF	OFF	OFF	OFF	OFF	OFF	OFF	OFF	OFF	
Save User Setup	OFF	OFF	OFF	OFF	OFF	OFF	OFF	OFF	OFF	
Alarm sensors		OFF	OFF	OFF	OFF	OFF	OFF	OFF	OFF	
Limit	-----	-----	-----	-----	-----	-----	-----	-----	-----	
Min. speed cut off		OFF	OFF	OFF	OFF	OFF	OFF	OFF	OFF	
Group 2 ON value	-----	-----	-----	-----	-----	-----	-----	-----	-----	
nmin at Group2	-----	-----	-----	-----	-----	-----	-----	-----	-----	
Val > Set=n+		ON	ON	ON	ON	ON	OFF	OFF	OFF	
Type of control		P	P	P	P	P	Pid	Pid	Pid	
KP		50 %	50 %	50 %	50 %	50 %	50 %	50 %	50 %	
KI		50 %	50 %	50 %	50 %	50 %	50 %	50 %	50 %	
KD		50 %	50 %	50 %	50 %	50 %	50 %	50 %	50 %	
TI		0 %	0 %	0 %	0 %	0 %	0 %	0 %	0 %	
IO Setup										
A Function	1A	1A (2.03 = 6A)	1A	1A	1A	1A	1A	1A	1A	
A min.	0.0 V	0.0 V	0.0 V	0.0 V	0.0 V	0.0 V	0.0 V	0.0 V	0.0 V	
A max.	10.0 V	10.0 V	10.0 V	10.0 V	10.0 V	10.0 V	10.0 V	10.0 V	10.0 V	
A Inverting	OFF	OFF	OFF	OFF	OFF	OFF	OFF	OFF	OFF	
A2* Function	1A	1A	1A	1A	1A	1A	1A	1A	1A	
A2* min.	0.0 V	0.0 V	0.0 V	0.0 V	0.0 V	0.0 V	0.0 V	0.0 V	0.0 V	
A2* max.	10.0 V	10.0 V	10.0 V	10.0 V	10.0 V	10.0 V	10.0 V	10.0 V	10.0 V	
A2* Inverting	OFF	OFF	OFF	OFF	OFF	OFF	OFF	OFF	OFF	
D1 Function	OFF	OFF	OFF	OFF	OFF	OFF	OFF 4.03 = 1D	OFF	OFF	
D1 Inverting	-----	-----	-----	-----	-----	-----	----- 4.03 = OFF	-----	-----	
D1 Busmode	-----	-----	-----	-----	-----	-----	----- 4.03 = ON	-----	-----	

Mode	1.01	2.01 2.03 2.04	2.02	2.05	3.01 3.02	3.03 3.04	4.01 4.02 4.03	5.01 5.02	6.01	User Setting
	Factory setting									
D2 Function	OFF	OFF	OFF	OFF	OFF	OFF	OFF 4.03 = 5D	OFF	OFF	
D2 Inverting	-----	-----	-----	-----	-----	-----	----- 4.03 = OFF	-----	-----	
D2 Busmode	-----	-----	-----	-----	-----	-----	----- 4.03 = ON	-----	-----	
D3* Function	OFF	OFF	OFF	OFF	OFF	OFF	OFF	OFF	OFF	
D3* Inverting	-----	-----	-----	-----	-----	-----	-----	-----	-----	
D4* Function	OFF	OFF	OFF	OFF	OFF	OFF	OFF	OFF	OFF	
D4* Inverting	-----	-----	-----	-----	-----	-----	-----	-----	-----	
D5* Function	OFF	OFF	OFF	OFF	OFF	OFF	OFF	OFF	OFF	
D5* Inverting	-----	-----	-----	-----	-----	-----	-----	-----	-----	
E1 Inverting	OFF	OFF	OFF	OFF	OFF	OFF	OFF	OFF	OFF	
E2 Inverting	-----	----- 2.04 = OFF	-----	OFF	-----	OFF	----- 4.02 + 4.03 = OFF	----- 5.02 = OFF	OFF	
E3* Function	OFF	OFF	OFF	OFF	OFF	OFF	OFF	OFF	OFF	
E3* Inverting	-----	-----	-----	-----	-----	-----	-----	-----	-----	
K1 Function	1K	1K (2.03 = 2K)	1K	1K	1K	1K	1K	1K	1K	
K1 Inverting	OFF	OFF	OFF	OFF	OFF	OFF	OFF	OFF	OFF	
K2 Function	2K	2K (2.03 = 9K)	2K	2K	2K	2K	2K	2K	2K	
K2 Inverting	OFF	OFF	OFF	OFF	OFF	OFF	OFF	OFF	OFF	
K3* Function	OFF	OFF	OFF	OFF	OFF	OFF	OFF	OFF	OFF	
K3* Inverting	-----	-----	-----	-----	-----	-----	-----	-----	-----	
K4* Function	OFF	OFF	OFF	OFF	OFF	OFF	OFF	OFF	OFF	
K4* Inverting	-----	-----	-----	-----	-----	-----	-----	-----	-----	
Bus Address	247	247	247	247	247	247	247	247	247	
Addressing	OFF	OFF	OFF	OFF	OFF	OFF	OFF	OFF	OFF	
Limits										
Level Function	OFF	OFF	OFF	OFF	OFF	OFF	OFF	OFF	OFF	
Level min.	-----	-----	-----	-----	-----	-----	-----	-----	-----	
Level max.	-----	-----	-----	-----	-----	-----	-----	-----	-----	
Level Delay	-----	-----	-----	-----	-----	-----	-----	-----	-----	
Lmt E1 Function	OFF	2.03 = 1L	OFF	OFF	OFF	OFF	OFF	OFF	OFF	
Lmt E1 min	-----	2.03 = 0.0 °C	-----	-----	-----	-----	-----	-----	-----	
Lmt E1 max.	-----	2.03 = 40.0 °C	-----	-----	-----	-----	-----	-----	-----	
Lmt E1 Hyst.	-----	2.03 = 1.0 K	-----	-----	-----	-----	-----	-----	-----	
Lmt E1 Del.	-----	2.03 = 2 sec.	-----	-----	-----	-----	-----	-----	-----	
Lmt E2 Function	-----	2.03 = OFF	-----	-----	-----	-----	-----	-----	-----	

Mode	1.01	2.01 2.03 2.04	2.02	2.05	3.01 3.02	3.03 3.04	4.01 4.02 4.03	5.01 5.02	6.01	User Setting
	Factory setting									
Lmt E2 min.	-----	-----	-----	-----	-----	-----	-----	-----	-----	
Lmt E3 max.	-----	-----	-----	-----	-----	-----	-----	-----	-----	
Lmt E2 Hyst.	-----	-----	-----	-----	-----	-----	-----	-----	-----	
Lmt E2 Del.	-----	-----	-----	-----	-----	-----	-----	-----	-----	
Offset Function		OFF	OFF	OFF	OFF	OFF	OFF	OFF	OFF	
Offset 1		-----	-----	-----	-----	-----	-----	-----	-----	
Offset 2		-----	-----	-----	-----	-----	-----	-----	-----	
Offset Hyst.		-----	-----	-----	-----	-----	-----	-----	-----	
Offset Del.		-----	-----	-----	-----	-----	-----	-----	-----	
Motor Setup										
CosPhi	0.80	0.80	0.80	0.80	0.80	0.80	0.80	0.80	0.80	
Rampup time	20 sec	20 sec	20 sec	20 sec	20 sec	20 sec	20 sec	20 sec	20 sec	
Rampdown time	20 sec	20 sec	20 sec	20 sec	20 sec	20 sec	20 sec	20 sec	20 sec	
Suppression1	OFF	OFF	OFF	OFF	OFF	OFF	OFF	OFF	OFF	
Range1 min.	-----	-----	-----	-----	-----	-----	-----	-----	-----	
Range1 max.	-----	-----	-----	-----	-----	-----	-----	-----	-----	
Suppression2	OFF	OFF	OFF	OFF	OFF	OFF	OFF	OFF	OFF	
Range2 min.	-----	-----	-----	-----	-----	-----	-----	-----	-----	
Range2 max.	-----	-----	-----	-----	-----	-----	-----	-----	-----	
Suppression3	-----	-----	-----	-----	-----	-----	-----	-----	-----	
Range3 min.	OFF	OFF	OFF	OFF	OFF	OFF	OFF	OFF	OFF	
Range3 max.	-----	-----	-----	-----	-----	-----	-----	-----	-----	
Motorheating	-----	-----	-----	-----	-----	-----	-----	-----	-----	
Diagnostic										
OTC	000056:- 46:13	000056:- 46:13	000056:- 46:13	000056:- 46:13	000056:- 46:13	000056:- 46:13	000056:- 46:13	000056:- 46:13	000056:- 46:13	000056:- 46:13
OTM	000056:- 46:13	000056:- 46:13	000056:- 46:13	000056:- 46:13	000056:- 46:13	000056:- 46:13	000056:- 46:13	000056:- 46:13	000056:- 46:13	000056:- 46:13
Heatsink	28.8 °C	28.8 °C	28.8 °C	28.8 °C	28.8 °C	28.8 °C	28.8 °C	28.8 °C	28.8 °C	
E1-KTY	20.0 °C	20.0 °C	20.0 °C	20.0 °C	20.0 °C	20.0 °C	20.0 °C	20.0 °C	20.0 °C	
E1-Current	0.00 mA	0.00 mA	0.00 mA	0.00 mA	0.00 mA	0.00 mA	0.00 mA	0.00 mA	0.00 mA	
E1-Voltage	0.00 V	0.00 V	0.00 V	0.00 V	0.00 V	0.00 V	0.00 V	0.00 V	0.00 V	
E2-KTY	20.0 °C	20.0 °C	20.0 °C	20.0 °C	20.0 °C	20.0 °C	20.0 °C	20.0 °C	20.0 °C	
E2-Current	0.00 mA	0.00 mA	0.00 mA	0.00 mA	0.00 mA	0.00 mA	0.00 mA	0.00 mA	0.00 mA	
E2-Voltage	0.00 V	0.00 V	0.00 V	0.00 V	0.00 V	0.00 V	0.00 V	0.00 V	0.00 V	
E3*	0.00 V	0.00 V	0.00 V	0.00 V	0.00 V	0.00 V	0.00 V	0.00 V	0.00 V	
D1	ON	ON	ON	ON	ON	ON	ON	ON	ON	
D2	ON	ON	ON	ON	ON	ON	ON	ON	ON	
D3*	ON	ON	ON	ON	ON	ON	ON	ON	ON	
D4*	ON	ON	ON	ON	ON	ON	ON	ON	ON	
D5*	ON	ON	ON	ON	ON	ON	ON	ON	ON	
K1	OFF	OFF	OFF	OFF	OFF	OFF	OFF	OFF	OFF	
K2	ON	ON	ON	ON	ON	ON	ON	ON	ON	
K3*	OFF	OFF	OFF	OFF	OFF	OFF	OFF	OFF	OFF	
K4*	OFF	OFF	OFF	OFF	OFF	OFF	OFF	OFF	OFF	

* IO option Add-on module type Z-Modul-B

10.2 Possible allocation of the IOs, PINs

Analog outputs A / A2

Function	Description function A / A2
1A	Constant voltage +10 V
2A	proportional level control
3A	proportional input E1
4A	proportional input E2
5A	Group control
6A	only 2.03 Cooling function (not for Z-Modul-B)
7A	only 2.03 Heating function (not for Z-Modul-B)

Digital inputs D1..D5

Function	Description function D1..D5
OFF	No function (factory setting)
1D	Enable (remote control) "ON" / "OFF"
2D	External error
3D	"Limit" ON / OFF
4D	Switch over "E1" / "E2"
	For mode speed controller 1.01
5D	Switch over "Set Intern1" / "Set Intern2"
6D	Switch over "Intern" / "Extern"
	For modes as controller from 2.01
5D	Switch over "Setpoint1" / "Setpoint2"
6D	Switch over "Intern" / "Extern"
7D	Switch over "automatic control" / "Speed manual"
8D	Switch over control function (e.g. "heating" / "cooling")
	For all modes
10D	"Reset"
11D	Setting Max. Speed "ON" / "OFF"
12D	Motorheating ON / OFF (not Acontrol)
13D	Reverse direction of rotation "right-hand" / "left-hand" (only for frequency inverter with 3 ~ output)
14D	"Freeze function" = maintain momentary modulation value

Analog inputs E2 / E3

Function	Description Function E2
1E	external Setpoint
2E	external manual mode
3E	Sensor average to E1
4E	Sensor comparison to E1
5E	Sensor difference to E1
6E	Sensor for Setpoint
7E	Measurement
Function	Description Function E3
1E	0 - 10 V external Setpoint
2E	External Manual mode

Digital outputs K1..K4

Function	Description function K1, K2 ,K3*, K4*
OFF	No function Relays remain always de-energized
1K	Operating indication (factory setting for “K1”, non inverting). Operation without fault, reports enable “OFF”
2K	Fault indication (factory setting for “K2”, non inverting). Energized for operation without fault, for enable “OFF” not energized. De-energized at line, motor and controller fault, Sensor fault dependent on programming, external fault at digital input.
3K	External fault separate with message at digital input (factory setting if terminals bridged)
4K	Limit modulation Over or falling below limits for modulation
5K	Limit “E1” When over or falling below limits for input signal “E1”
6K	Limit “E2” When over or falling below limits for input signal “E2”
8K	Group control (Group 2) Switching on fans depending on modulation
12K *	Group control (Group 3) Switching on fans depending on modulation
13K *	Group control (Group 4) Switching on fans depending on modulation
	For modes as controller from 2.01
7K	Setpoint Offset Deviation between actual value and setpoint to high
	For modes as temperature controller with additional functions 2.03
9K	Heating function Switch ON point: temperature = Setpoint +/- Offset Switch OFF point: Temperature around hysteresis over switch ON point
10K	Cooling function Switch ON point: temperature = Setpoint +/- Offset Switch OFF point: Temperature around hysteresis below switch ON point

* Function depending on the version of the software available















Limits GW E1, GW E2











Function	Description function GW E1, GW E2
OFF	without function
1L	Indication with the centralized fault of a programmed relay (IO allocation Function 2K). Warning symbol in display, “AL” code in events memory.
2L	Is merely displayed in the events menu as message “msg”.

PINs

PIN	Function
PIN 0010	Opening service menu, if PIN-protection activated
PIN 1234	Opening “setting”. if “set protection” = “ON” (☞ Controller Setup)
PIN 9090	Restore user setting
PIN 9091	Save user setting (corresponds function “Save user setup” = “ON”☞ Controller Setup)
PIN 9095	Restore factory setting = delivery status

11 Diagnostics menu



	<p>The diagnostics menu supplies information about the momentary operating condition of the device.</p>
	<p>O = Operation, T = Time, C = Controller The time counting runs, as soon as mains voltage is connected (without fault). If events step on (Motor fault, External Error, etc.), the period of operation is stored at this time (📄 Events).</p>
	<p>O = Operation, T = Time, M = Motor The time counting runs as soon as a modulation of the controller is present</p>
	<p>Display of the internal temperature of the power semiconductor. At a temperature of approx. 95° C, the device switches off and switches back on after cooling off to approx. 65° C.</p>
	
	<p>Signal height at analog input E1 (Analog In 1)</p>
	
	
	<p>Signal height at analog input E2 (Analog In 2)</p>
	
	<p>Signal height at analog input E3 (Analog In 3*)</p>
	<p>Status digital input 1 (Digital In 1) OFF = terminals D1 - D1 bridged ↔ ON = terminals D1 - D1 not bridged</p>
	<p>Status digital input 2 (Digital In 2) OFF = terminals D2 - D2 bridged ↔ ON = terminals D2 - D2 not bridged</p>
	<p>Status digital input 3 (Digital In 3*) OFF = terminals D3 - GND bridged ↔ ON = terminals D3 - GND not bridged</p>

	Status digital input 4 (Digital In 4*) OFF = terminals D4 - GND bridged ↔ ON = terminals D4 - GND not bridged
	Status digital input 5 (Digital In 5*) OFF = terminals D5 - GND bridged ↔ ON = terminals D5 - GND not bridged
	OFF = relay K1 de-energized: terminals 11 - 12 bridged ON = relay K1 energized: terminals 11 - 14 bridged
	OFF = relay K2 de-energized: terminals 21 - 22 bridged ON = relay K2 energized: terminals 21 - 24 bridged
	OFF = relay K3* de-energized: terminals 31 - 32 bridged ON = relay K3* energized: terminals 31 - 34 bridged
	OFF = relay K4* de-energized: terminals 41 - 42 bridged ON = relay K4* energized: terminals 41 - 44 bridged
	Display of measured period length (supply frequency) between L1 - L2
	Display of measured period length (supply frequency) between L2 - L3
	Display of measured period length (supply frequency) between L3 - L1
	Display of measured period length (supply frequency)

* When operating together with the “Z-Modul-B” type expansion module, the diagnosis menu is automatically expanded to include the additional inputs and outputs.

12 Events / Fault signals

12.1 Display and query of events and malfunctions

	Events during operation can lead to a malfunctioning of the device. The last 10 (0 - 9) events and malfunctions are stored in the “Events” menu group (position “0” = most recent event).
Essemple for possible events	The device differentiates between 3 types of events:
	1. Messages with code [Msg] Message sensor fault for information, for Alarm sensor deactivated.

	<p>2. Alarms with code AL Events during which the device automatically restarts operation after the cause of the malfunction has been remedied (e.g. mains failure), or remains in operation (e.g. externally-trunked centralized fault).</p>
	<p>3. Error with code Err Events that lead to a disconnection of the controlled output (e.g. excess motor temperature). Restarting is only possible after a reset (locked).</p>



Controllers period of operation at time of message:
 With the **P** key can be switched between description of the message and the Controllers period of operation at this time.
 E.G. on place 3 which is past message **motor fault**.







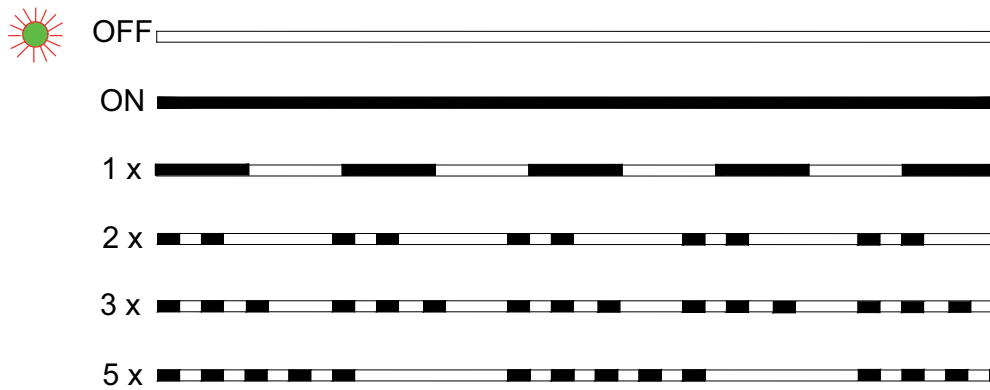

12.2 Messages and trouble shooting

A momentary pending alarm or error message is indicated by a blinking indicator and appears alternately with the standard display.
 Operating conditions are indicated by the internal status LED with flashing code.
 internal State LED



15.09.2011
 v_flash_explain_1_2_3_5.VSD

Display	Code*	LED Code	Relais switches**		Cause	Reaction of Controller
			internal	Operation		
		OFF				Adjustment Line voltage available? Unit switch OFF and automatically ON when the voltage has been restored check internal controller fuse (so far available)
	Err	5		X	X	Failure by a line phase unstable mains supply Unit switches OFF and automatically ON again during intact voltage supply. check line supply and internal controller fuse (so far available)
		1		X	-	No enable Switch OFF by external contact (function [1D] = enable programmed for Digital In)
	AL	-		-	-	fault in Eprom works with defaults

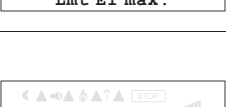
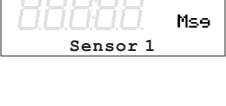
Display	Code*	LED Code	Relais switches**		Cause	Reaction of Controller	
			internal	Operation		Fault	Adjustment
	AL	-	-	-	X	fault EEP damaged	works with defaults
	AL	-	X	X	X	EEP data incorrectly	controller runs with the read settings
	AL	3			X	power semiconductor too hot	Switch OFF at 95°C, switch ON when cooled down to 65°C. Check temperature in controller, Check cooling of the controller
	AL	-	-	-	selectable	Alarm from external contact	Device continues working unchanged check contacts
	AL	-	-	-	selectable	Limit indication minimum Actual value below setting "Alarm Minimum" (Input "E1")	Device continues working unchanged
	AL	-	-	-	selectable	Limit indication maximum Actual value above setting "Alarm Maximum" (Input "E1")	Check setting and sensor
	Msg or. AL*	6	selectable	selectable		Interruption / short circuit in the sensor leads or sensor values measured are outside measuring range	The device works with minimal or maximum modulation depending on whether there is a short-circuit or an interruption, and on the programmed mode of operation. Check sensor
	Err	2	X	X	X	A connected thermostat or thermistor has tripped the circuit or interruption between both terminals "TB/TP" or "TK/PTC"	The unit then remains switched off. A programmed operating and fault-indicating relay is triggering Check motor and connection then reset

*Code: Err = Error AI = Alarm Msg = Message
 ** Relais switches dependent on programmed function

13 Enclosure

13.1 Technical data

The information on the rating plate is valid for a maximum ambient temperature of 40 °C.

Type	Part.-No.	Rated current for 40 °C	Line fuse max.	Integrated semicon- ductor fuse	Heat dissipation max. approx.	Weight
		{1}	{2}	{3}	{1}	
		[A]	[A]	[Part.-No.]	[W]	[kg]
Line voltage 3 ~ 208...415 V, (-10 %...+ 6 %) 50/60 Hz						
PXDM6A	18620 (304594-42)	6	10	FF20 A 6x32 mm (00089798)	30	2.25
PXDM10A	18621 (304595-42)	10	16		50	2.75

{1} for mains voltage 400 V / 50 Hz, values for different specifications on request

{2} Max. supply side line fuse according to DIN EN 60204-1 classification VDE0113 chapter 1.

{3} Integrated semiconductor fuse in device (no line safety switch).

Maximum cross section for line and motor connection	2.5 mm ²
Stepless controlled output voltage	approx. 20...100 % of connected line voltage
Min. motor current	for PXDM6: 0.2 A, for PXDM10: 0.5 A
Input resistance for sensor or signal set for the rotational speed	for 0 - 10 V input: R _i >100 kΩ for 4 - 20 mA input: R _i = 250 Ω
Voltage supply e.g. for sensors	+24 V ±20 %, I _{max} 120 mA
Output (0 - 10 V)	I _{max} 10 mA (short-circuit-proof)
Contact rating of the internal relay	max. AC 250 V 2 A
Max. permissible ambient temperature	40 °C (up to 55 °C with derating)
Min. permissible ambient temperature	0 °C (if mains voltage is not switched off up to -20 °C)
Max. permissible installation height	0...4000 m amsl above 1000 m amsl the rated current is to be reduced by 5 % / 1000 m
Permissible rel. humidity	85 % no condensation
Electromagnetic compatibility for the standard voltage 230 / 400 V according to DIN IEC 60038	Interference emission EN 61000-6-3 (domestic household applications)
	Interference immunity EN 61000-6-2 (industrial applications)
Max. leakage current according to the defined networks of DIN EN 60990	< 3.5 mA
Harmonics current	According EN 61000-3-2 (for a "professional device") ☞ Electrical installation / harmonics current

13.1.1 Performance reduction during elevated ambient temperatures

The maximum permissible ambient temperature for the device is 40 °C or 50 °C depending on version. Up to this temperature, loading (maximum continuous current) with the specified rated current is possible.

The removal of heat in the unit due to power dissipation is dependent on the ambient temperature, so the maximum load has to be reduced if the ambient temperature is higher than 40 °C or 50 °C! For each degree higher the load has to be reduced approx. 2.2%.

The average value measured during a 24 h period must be 5 K under the max. ambient temperature. For installation in a switch cabinet, the device's dissipation and its possible affect on the ambient temperature must be taken into consideration (☞ Technical data)!

Maximum load for ambient temperatures higher 40 °C for versions with internal fuses

Type	Rated current for 40 °C	max. current load for 45 °C	max. current load for 50 °C	max. current load for 55 °C
	[A]	[A]	[A]	[A]
PXDM6A	6	5.5	5.0	4.5
PXDM10A	10	10,0	9.0	8.0

13.2 Connection diagram

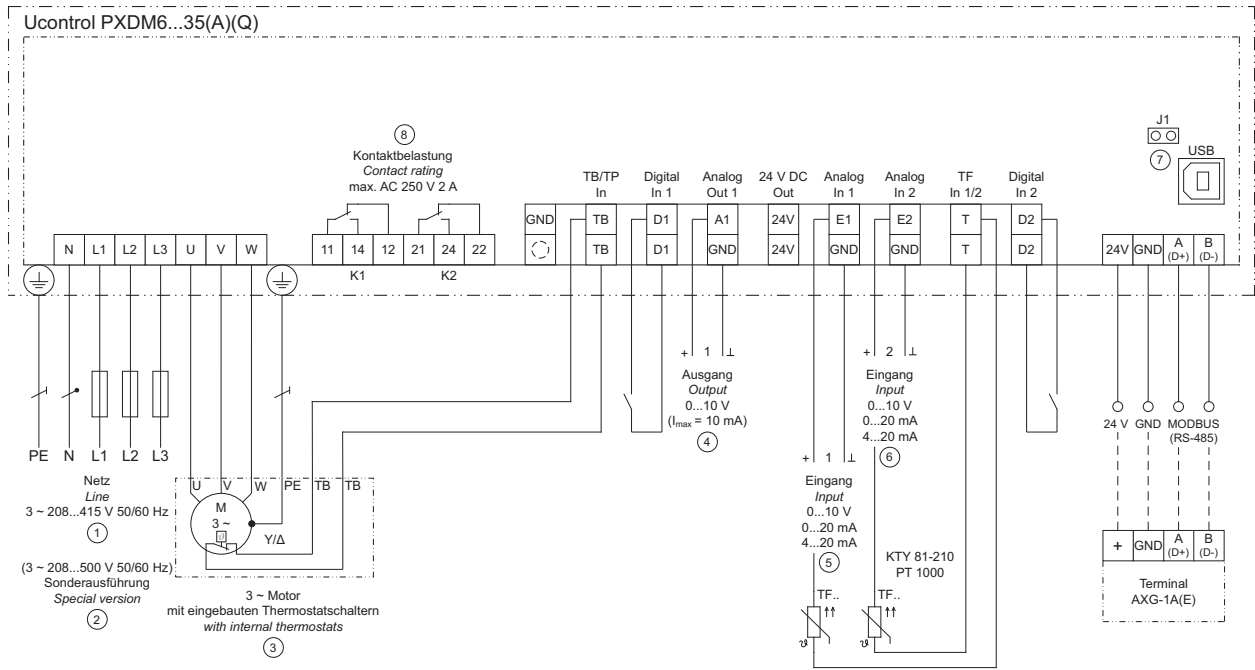

PDUN20K0
02.08.2011

- 1 Line 3 ~ 208...415 V, 50/60 Hz
- 2 Special version for line 3 ~ 208...500 V, 50/60 Hz
- 3 3~ Motor with internal thermostats
- 4 Output 0...10 V ($I_{max} = 10 \text{ mA}$)
- 5 Input 1: 0...10 V, 0...20 mA, 4...20 mA, TF...(KTY)
- 6 Eingang 2: 0...10 V, 0...20 mA, 4...20 mA, TF...(KTY)
- 7 USB-interface
- 9 Contact rating max. AC 250 V 5 A

Connection examples

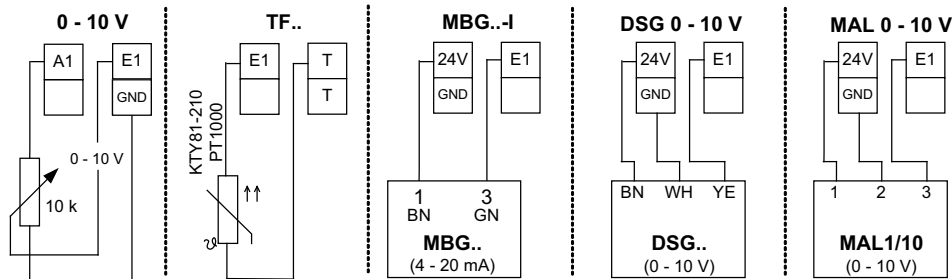

19.09.2012
v_sensoren_e1_t1_anschliplan.vsd

13.2.1 Connection suggestion for several motors with motor protection unit type STDT

- Full motor protection by switch-off when activating the attached thermostat switches “TB”. Reset after malfunction by key press.
- Line protection: A thermal over current sensor and a magnetic short circuit releasing elements are the parts of the integral line protection. Adjustment to the thermal overcurrent sensor to the max. permissible current of the connected cable (max. line fuse 80 A).
- No cut-off if the mains supply is interrupted

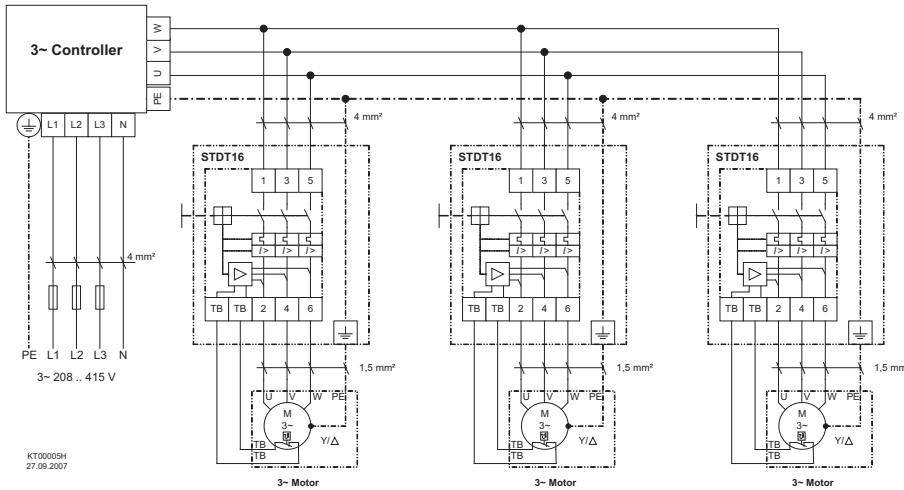

Consider max. terminal load Operating Instructions!
 (General example, data for the connection of the controller dependent on the used type of device)

13.3 Dimensions [mm]

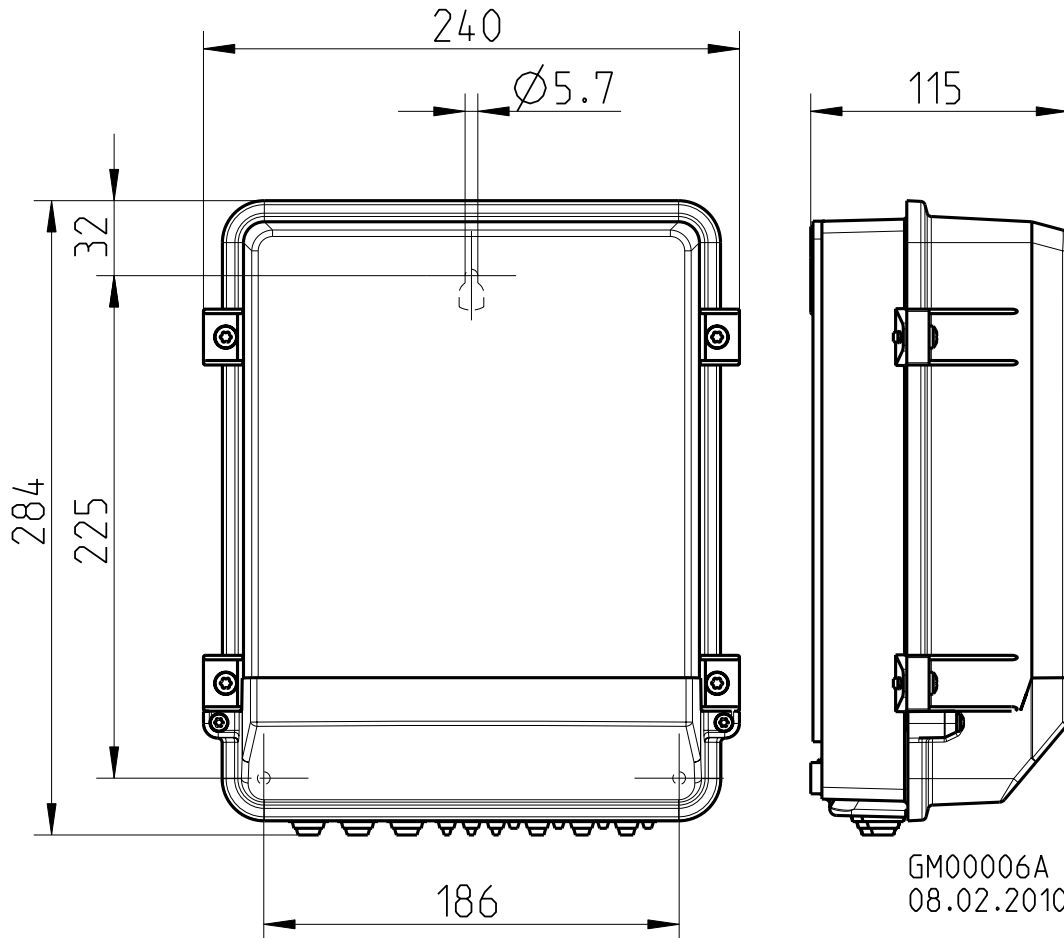

13.4 Index

A		motor feed cable	9
address	49	motor leads	10
Average calculation	21	Motor protection	11
		motor protection unit	10
B		O	
Base setup	39	Outdoor installation	8
		outputs 0 - 10 V	11
C		P	
control cable	9	P-component	39
current-operated circuit-breakers	10	pin code	35
		PIN input	35
D		PIN protection	36
D-component	39	PT1000	11
diagnostics menu	62	PTC	11
Digital inputs	41	R	
DSG	29	Rampdown time	53
		Rampup time	53
E		refrigerant	27
Enable	42	Relay outputs	12
Events	63	Reset	42
Ex zones	11	Reset	45
External Setpoint	17	resonances	54
		S	
G		Suppression	54
group control	38	T	
		Technical data	4, 66
H		two-wire-technology	11
Holding Registers	49	U	
		user settings	37
I		V	
I-component	39	voltage regulation	10
Input resistance	66		
K			
K Factor	31		
L			
leakage current	66		
Limit	37		
Limits	50		
line fuse	66		
LON®	13		
M			
mains is connected	10		
MAL1, MAL10	33		
maximum control current	10		
MBG-30I, MBG-50I	26		
Minimum space requirement	8		
Minimum speed cut off	38		
MODBUS	12		
Mode	16		

13.5 Manufacturer reference

Our products are manufactured in accordance with the relevant international regulations. If you have any questions concerning the use of our products or plan special uses, please contact:

Systemair
Industrievägen 3
73930 Skinnskatteberg
Telefon:+46 (0) 222 440 00
Telefax:+46 (0) 222 440 99
mailbox@systemair.se
www.systemair.se