

## OPERATION AND INSTALLATION

Instantaneous water heating cylinder

- » SBS 601 W
- » SBS 801 W
- » SBS 1001 W
- » SBS 1501 W
- » SBS 601 W SOL
- » SBS 801 W SOL
- » SBS 1001 W SOL
- » SBS 1501 W SOL

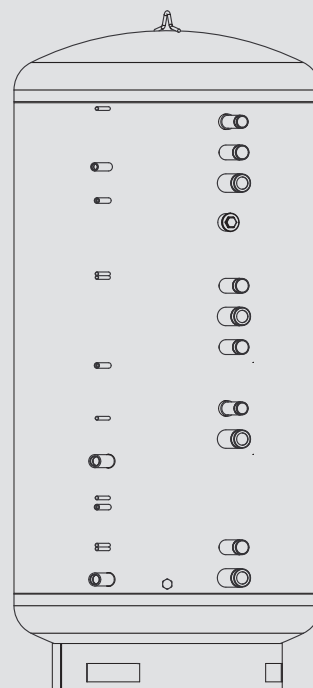

**STIEBEL ELTRON**

**OPERATION**

<b>1. General information</b>	<b>15</b>
1.1 Document information	15
1.2 Safety instructions	15
1.3 Other symbols in this documentation	15
1.4 Units of measurement	16
<b>2. Safety</b>	<b>16</b>
2.1 Intended use	16
2.2 Safety information	16
2.3 Test symbols	16
<b>3. Appliance description</b>	<b>16</b>
<b>4. Cleaning, care and maintenance</b>	<b>16</b>
4.1 Scaling	16
<b>5. Troubleshooting</b>	<b>16</b>

**INSTALLATION**

<b>6. Safety</b>	<b>17</b>
6.1 General safety instructions	17
6.2 Instructions, standards and regulations	17
6.3 Water installation	17
<b>7. Appliance description</b>	<b>17</b>
7.1 Standard delivery	17
7.2 Accessories	17
<b>8. Assembly</b>	<b>17</b>
8.1 Installation location	17
8.2 Transport	17
8.3 Assembly	18
<b>9. Commissioning</b>	<b>18</b>
<b>10. Taking the appliance out of use</b>	<b>18</b>
<b>11. Recommissioning</b>	<b>18</b>
<b>12. Appliance handover</b>	<b>19</b>
<b>13. Troubleshooting</b>	<b>19</b>
13.1 Fault table	19
<b>14. Maintenance</b>	<b>19</b>
14.1 Checking the safety valve	19
14.2 Draining the appliance	19
<b>15. Specification</b>	<b>20</b>
15.1 Dimensions and connections	20
15.2 Data table	25

**GUARANTEE**

**ENVIRONMENT AND RECYCLING**

# OPERATION

## 1. General information

### 1.1 Document information

The chapter "Operation" is intended for the equipment user and the heating contractor.

The chapter "Installation" is intended for the heating contractor.



**Note**

Read these instructions carefully before using the appliance and retain them for future reference. Pass on the instructions, if required, to a new user.

### 1.2 Safety instructions

#### 1.2.1 Structure of safety instructions



**KEYWORD Type of risk**

Here, possible consequences are listed that may result from failure to observe the safety instructions.

► Steps to prevent the risk are listed.

#### 1.2.2 Symbols, type of risk

Symbol	Type of risk
	Injury
	Electrocution
	Burns (burns, scalding)

#### 1.2.3 Keywords

KEYWORD	Meaning
DANGER	Failure to observe this information will result in serious injury or death.
WARNING	Failure to observe this information may result in serious injury or death.
CAUTION	Failure to observe this information may result in non-serious or minor injury.

### 1.3 Other symbols in this documentation





**Note**

General information is identified by the symbol shown on the left.

► Read these texts carefully.

# Operation

## Safety

Symbol	Meaning
	Material damage (Appliance and consequential losses, environmental pollution)
	Appliance disposal

- ▶ This symbol indicates that you have to do something. The action you need to take is described step by step.

### 1.4 Units of measurement



#### Note

All measurements are given in mm unless stated otherwise.

## 2. Safety

### 2.1 Intended use

This appliance is designed for the storage of heating water and for DHW heating. A glycol/water mixture of up to 60 % is permitted if only dezincification-resistant metals, glycol-resistant gaskets and diaphragm expansion vessels suitable for glycol are used throughout the installation.

Any other or additional use is inappropriate, in particular usage with alternative storage media. Observation of these instructions and of instructions for any accessories used is also part of the correct use of this appliance..

### 2.2 Safety information



#### WARNING Burns

There is a risk of scalding at outlet temperatures in excess of 43 °C.



#### WARNING Injury

The appliance may be used by children aged 8 and up and persons with reduced physical, sensory or mental capabilities or a lack of experience and know-how provided that they are supervised or they have been instructed on how to use the appliance safely and have understood the resulting risks. Children must never play with the appliance. Children must never clean the appliance or perform user maintenance unless they are supervised.



#### Material damage

The appliance is under pressure. During the heating process, expansion water will drip from the safety valve. If water continues to drip when heating is completed, please inform your heating contractor.

### 2.3 Test symbols

See type plate on the appliance.

## 3. Appliance description

The appliance combines DHW heating and a buffer cylinder for the hydraulic separation of heating system and heat pump. The DHW is heated via a corrugated stainless steel internal indirect coil that functions like an instantaneous water heater. The volume of the cylinder is an energy store for DHW heating.

The appliance is ideally suited to operation with a heat pump. In addition, a threaded immersion heater and an auxiliary heat source can be connected.

### SBS W SOL

These appliance types are also equipped with an internal indirect coil for solar DHW heating and central heating backup.

## 4. Cleaning, care and maintenance

- ▶ Have the function of the safety assembly and electrical safety of the fitted special accessories regularly checked by a heating contractor/electrician.
- ▶ Never use abrasive or corrosive cleaning agents. A damp cloth is sufficient for cleaning the appliance.

### 4.1 Scaling

- ▶ Almost every type of water deposits limescale at high temperatures. This settles inside the appliance and affects both the performance and service life. If a flanged immersion heater is installed, the heating elements must be descaled from time to time. A heating contractor who knows the local water quality will tell you when the next service is due.
- ▶ Check the taps regularly. You can remove limescale deposits at the tap outlets using commercially available descaling agents.
- ▶ Regularly activate the safety valve to prevent it from becoming blocked e.g. by limescale deposits.

## 5. Troubleshooting

Fault	Cause	Remedy
The outlet flow rate is low.	The perlator in the tap or shower head is scaled up or contaminated.	Clean and/or descale the perlator or the shower head.

If you cannot remedy the fault, notify your heating contractor. To facilitate and speed up your enquiry, please provide the serial number from the type plate (no. 000000-0000-000000):

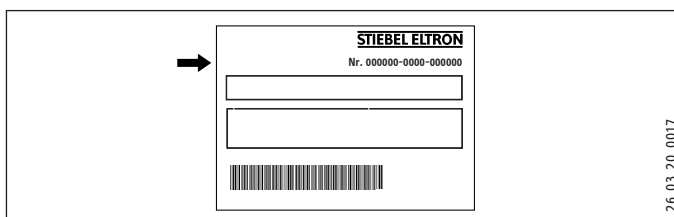

# INSTALLATION

## 6. Safety

Only qualified contractors should carry out installation, commissioning, maintenance and repair of the appliance.

### 6.1 General safety instructions

We can only guarantee trouble-free function and operational reliability if original spare parts intended for the appliance are used.

### 6.2 Instructions, standards and regulations



#### Note

Observe all applicable national and regional regulations and instructions.

### 6.3 Water installation

#### 6.3.1 Cold water line

Steel or copper pipes or plastic pipework are approved materials.



#### Material damage

A safety valve is required.

#### 6.3.2 DHW line

Copper, stainless steel or plastic pipework are approved materials.



#### Material damage

Beim gleichzeitigen Einsatz von Kunststoff-Rohrsystemen  
If a flanged immersion heater is fitted and plastic pipe-work systems are used at the same time, observe the maximum permissible temperature / the maximum permissible pressure in chapter "Specification / Data table".



#### Material damage

Operate the appliance only with pressure-tested taps and valves.

## 7. Appliance description

### 7.1 Standard delivery

Delivered with the appliance:

- 2x heat conducting paste
- additional type plate

### 7.2 Accessories

Depending on the static pressure, safety assemblies and pressure reducing valves are available. These type-tested safety assemblies protect the appliance against unacceptable excess pressure.

Flanged immersion heaters, circulation set and thermal insulation are available as accessories.

## 8. Assembly

### 8.1 Installation location

- ▶ Ensure the floor has a sufficient load bearing capacity (see chapter "Specification / Data table").
- ▶ Ensure the floor is level.
- ▶ Check the height of the room and of the unit when tilted (see chapter "Specification / Data table").

#### Minimum clearances

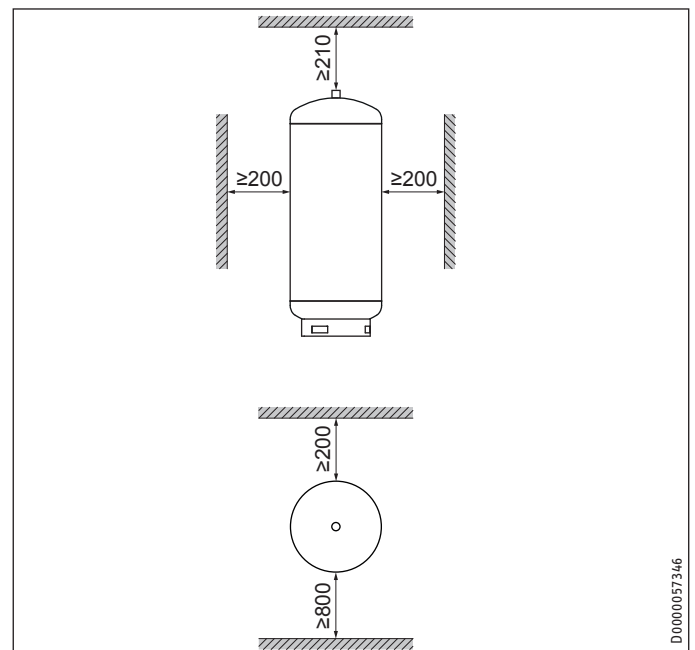

- ▶ Maintain the minimum clearances.

### 8.2 Transport

The lifting eye can be fitted to the top of the appliance to assist handling.

### 8.3 Assembly

#### 8.3.1 Fitting the thermal insulation, if appropriate.

- ▶ Position the appliance in its intended site.

# Installation

## Commissioning

- ▶ Fit the thermal insulation according to the instructions supplied. For this, ensure that there is enough space for the installation task. You can then link the appliance into the heating and DHW system.

### 8.3.2 Installing the manual air vent valve

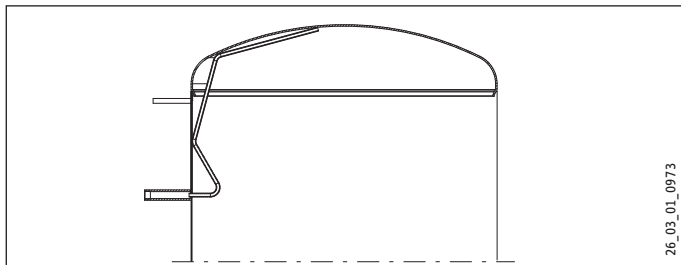

- ▶ Install a manual air vent valve at the air vent valve connection.

### 8.3.3 Fitting the water connection and the safety assembly

**!** **Material damage**  
Carry out all water connection and installation work in accordance with regulations.

- ▶ Flush the line thoroughly.
- ▶ Observe the information in the installation instructions of the safety assembly.
- ▶ Connect the DHW outlet and the cold water inlet lines with the safety assembly. Bear in mind that, depending on the static pressure, you may also need a pressure reducing valve. Connect the hydraulic connections with flat gaskets.
- ▶ Size the drain so that water can drain off unimpeded when the safety valve is fully opened. The blow-off aperture of the safety valve must remain open towards the atmosphere.
- ▶ Fit the blow-off line of the safety assembly with a constant slope.

### 8.3.4 Inserting the temperature sensors

- ▶ Apply heat conducting paste to the temperature sensors.
- ▶ Insert the temperature sensors as far as they will go into the connections for HP return sensor and HP DHW sensor (see chapter „Specification / Dimensions and connections“).

## 9. Commissioning

- ▶ Open a downstream draw-off point until the appliance has filled up and the pipes are free of air.
- ▶ Vent the indirect coils after filling the heat pump system.
- ▶ Fit the accessories and check them if necessary.
- ▶ Check the function of the safety valve.

### 9.3.1 Water quality, solar circuit

A glycol/water mixture of up to 60 % is permitted for the indirect coil in the solar circuit if only dezincification-resistant metals, glycol-resistant gaskets and diaphragm expansion vessels suitable for glycol are used throughout the installation.

### 9.3.2 Oxygen diffusion

**!** **Material losses**  
Avoid open heating systems and plastic pipes in under-floor heating systems which are permeable to oxygen.

In underfloor heating systems with plastic pipes that are permeable to oxygen and in open vented heating systems, oxygen diffusion may lead to corrosion on the steel components of the heating system (e.g. on the indirect coil of the DHW cylinder, on buffer cylinders, steel heating elements or steel pipes).

**!** **Material losses**  
The products of corrosion (e.g. rusty sludge) can settle in the heating system components and can result in a lower output or fault shutdowns due to reduced cross-sections.

**!** **Material losses**  
Avoid open vented solar thermal systems and plastic pipes which are permeable to oxygen.

With plastic pipes that are permeable to oxygen, oxygen diffusion may lead to corrosion on the steel components of the solar thermal system (e.g. on the indirect coil of the DHW cylinder).

## 10. Taking the appliance out of use

- ▶ Disconnect the appliance from the mains at the MCB/fuse in the fuse box.
- ▶ Drain the appliance. See chapter “Maintenance / Draining the appliance”.

## 11. Recommissioning

See chapter “Commissioning”.

## 12. Appliance handover

- ▶ Explain the appliance function to users and familiarise them with its operation.
- ▶ Make users aware of potential dangers, especially the risk of scalding.
- ▶ Hand over these instructions.

## 13. Troubleshooting

### 13.1 Fault table

Fault	Cause	Remedy
The safety valve drips when the heating is switched off.	The valve seat is contaminated.	Clean the valve seat.

## 14. Maintenance



### WARNING Electrocutation

Carry out all electrical connection and installation work in accordance with relevant regulations.

If you need to drain the appliance, observe chapter “Draining the appliance”.

### 14.1 Checking the safety valve

- ▶ Regularly vent the safety valve on the safety assembly until a full water jet is discharged.

### 14.2 Draining the appliance



### WARNING Burns

Hot water may escape during the draining process.

If the heating system is not in operation and the installation location is not protected against frost, the appliance and connected system must be emptied.

- ▶ For draining the appliance, remove the thermal insulation around the drain connector.
- ▶ Close the shut-off valve in the cold water line.
- ▶ Open the hot water taps on all draw-off points.
- ▶ Drain the appliance via the drain valve of the safety assembly.

## 15. Specification

### 15.1 Dimensions and connections

#### Recommended connection allocation SBS 601 W | SBS 601 W SOL

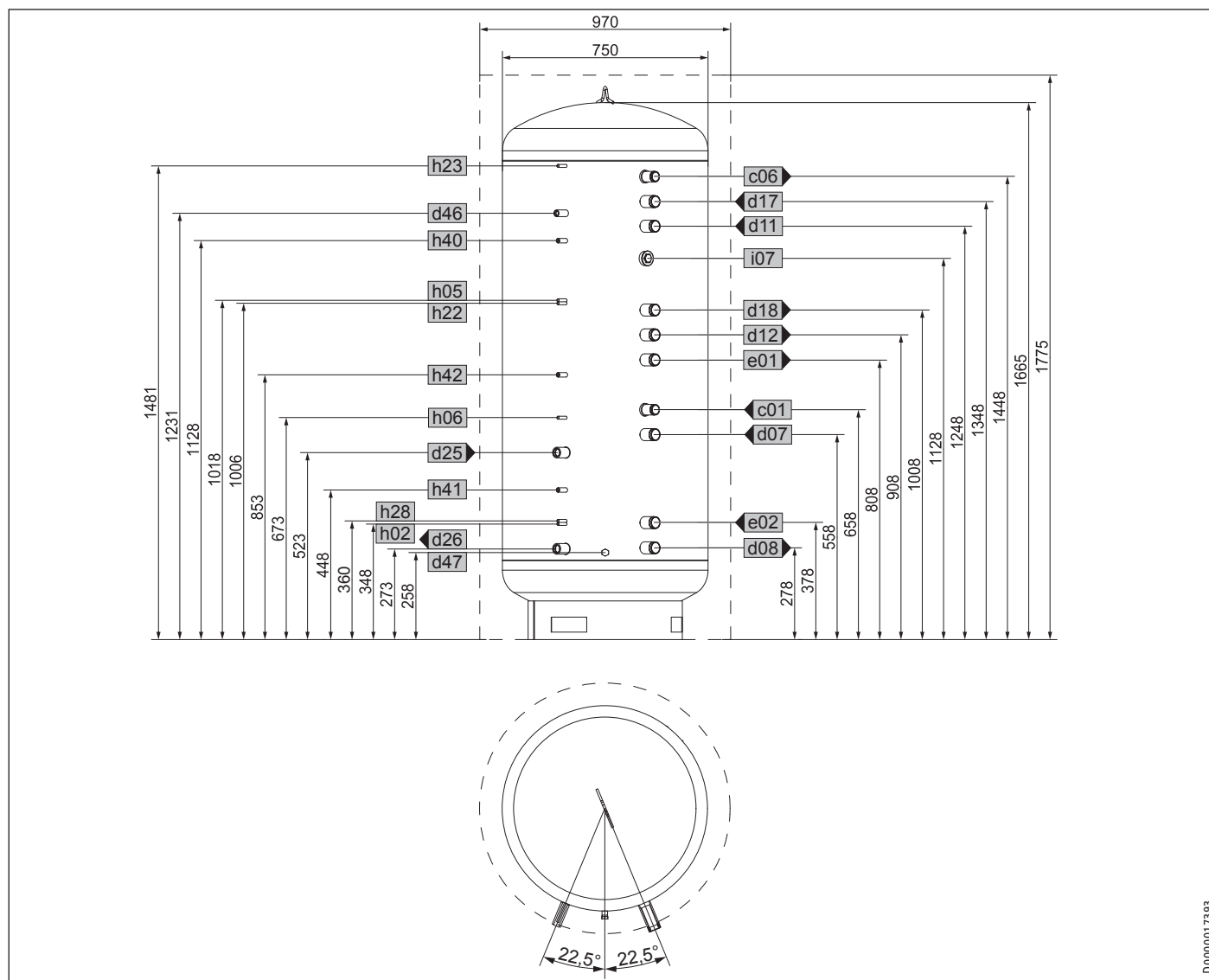

D0000017393

			SBS 601 W	SBS 601 W SOL
c01	Cold water inlet	Male thread	G 1 1/4 A	G 1 1/4 A
c06	DHW outlet	Male thread	G 1 1/4 A	G 1 1/4 A
d07	Heat pump heating flow	Male thread	G 1 1/2 A	G 1 1/2 A
d08	Heat pump heating return	Male thread	G 1 1/2 A	G 1 1/2 A
d11	Heat pump DHW flow	Male thread	G 1 1/2 A	G 1 1/2 A
d12	Heat pump DHW return	Male thread	G 1 1/2 A	G 1 1/2 A
d17	Flow 2nd heat source	Male thread	G 1 1/2 A	G 1 1/2 A
d18	Return 2nd heat source	Male thread	G 1 1/2 A	G 1 1/2 A
d25	Solar flow	Female thread		G 1
d26	Solar return	Female thread		G 1
d46	Ventilation	Female thread	G 1/2	G 1/2
d47	Drain	Male thread	G 3/4 A	G 3/4 A

			SBS 601 W	SBS 601 W SOL
e01	Heating flow	Male thread	G 1 1/2 A	G 1 1/2 A
e02	Heating return	Male thread	G 1 1/2 A	G 1 1/2 A
h02	Sensor heat pump return	Diameter	mm 9.5	9.5
h05	Sensor heat pump DHW	Diameter	mm 9.5	9.5
h06	Sensor heat pump DHW opt.	Diameter	mm 9.5	9.5
h22	Sensor heat source	Diameter	mm 9.5	9.5
h23	Sensor heat source opt.	Diameter	mm 9.5	9.5
h28	Sensor solar cylinder	Diameter	mm	9.5
h40	Thermometer DHW	Diameter	mm 14.5	14.5
h41	Thermometer solar	Diameter	mm	14.5
h42	Thermometer heating	Diameter	mm 14.5	14.5
i07	Electric emergency/booster heater	Female thread	G 1 1/2	G 1 1/2

If the system configuration is different, the connection allocation can be changed.

# Installation Specification

## Recommended connection allocation SBS 801 W | SBS 801 W SOL

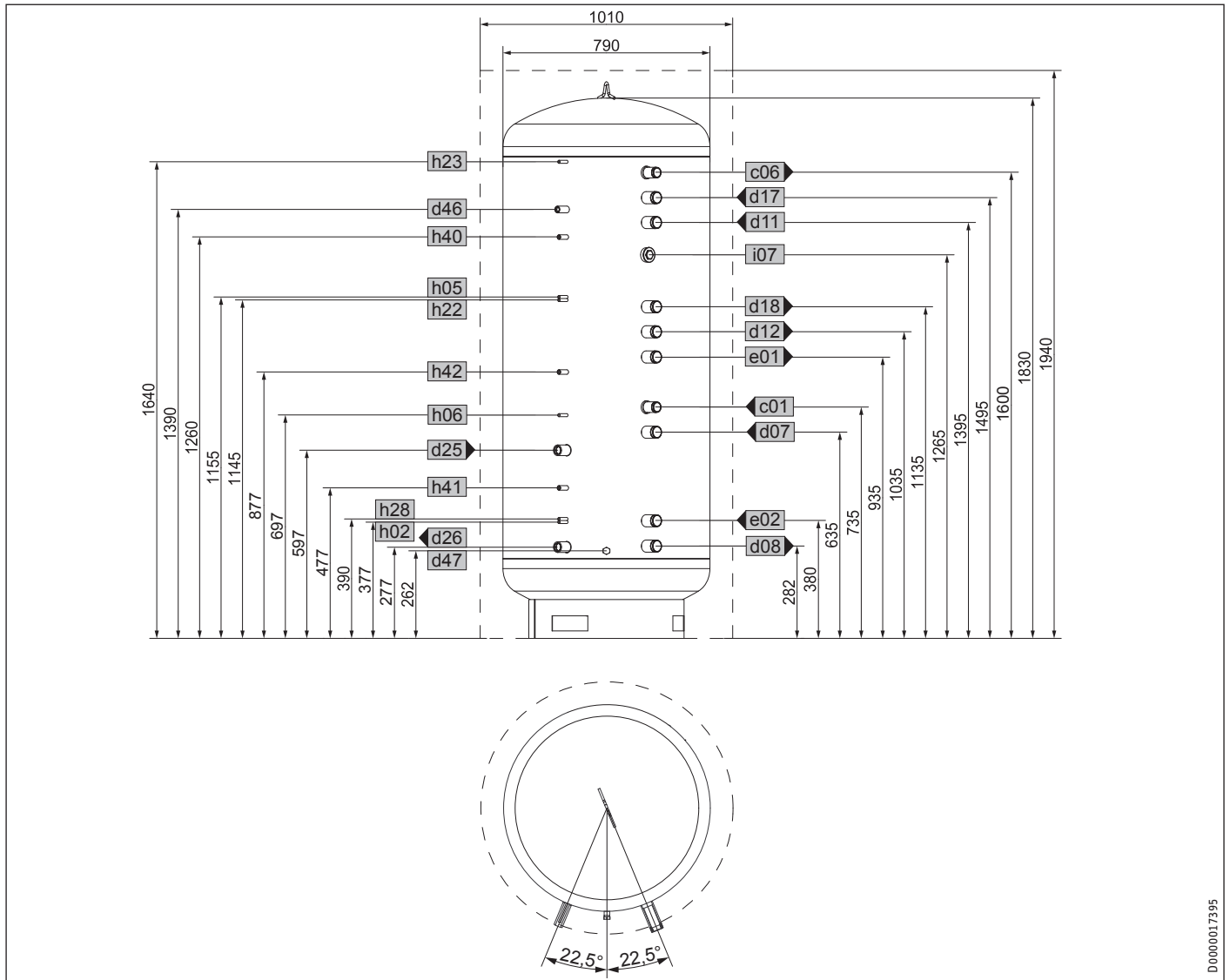

ENGLISH

D0000017395

			SBS 801 W	SBS 801 W SOL				SBS 801 W	SBS 801 W SOL	
c01	Cold water inlet	Male thread	G 1 1/4 A	G 1 1/4 A	h02	Sensor heat pump return	Diameter	mm	9.5	9.5
c06	DHW outlet	Male thread	G 1 1/4 A	G 1 1/4 A	h05	Sensor heat pump DHW	Diameter	mm	9.5	9.5
d07	Heat pump heating flow	Male thread	G 1 1/2 A	G 1 1/2 A	h06	Sensor heat pump DHW opt.	Diameter	mm	9.5	9.5
d08	Heat pump heating return	Male thread	G 1 1/2 A	G 1 1/2 A	h22	Sensor heat source	Diameter	mm	9.5	9.5
d11	Heat pump DHW flow	Male thread	G 1 1/2 A	G 1 1/2 A	h23	Sensor heat source opt.	Diameter	mm	9.5	9.5
d12	Heat pump DHW return	Male thread	G 1 1/2 A	G 1 1/2 A	h28	Sensor solar cylinder	Diameter	mm		9.5
d17	Flow 2nd heat source	Male thread	G 1 1/2 A	G 1 1/2 A	h40	Thermometer DHW	Diameter	mm	14.5	14.5
d18	Return 2nd heat source	Male thread	G 1 1/2 A	G 1 1/2 A	h41	Thermometer solar	Diameter	mm		14.5
d25	Solar flow	Female thread		G 1	h42	Thermometer heating	Diameter	mm	14.5	14.5
d26	Solar return	Female thread		G 1	i07	Electric emergency/booster heater	Female thread		G 1 1/2	G 1 1/2
d46	Ventilation	Female thread	G 1/2	G 1/2						
d47	Drain	Male thread	G 3/4 A	G 3/4 A						
e01	Heating flow	Male thread	G 1 1/2 A	G 1 1/2 A						
e02	Heating return	Male thread	G 1 1/2 A	G 1 1/2 A						

If the system configuration is different, the connection allocation can be changed.



# Installation Specification

## Recommended connection allocation 1001 W | SBS 1001 W SOL

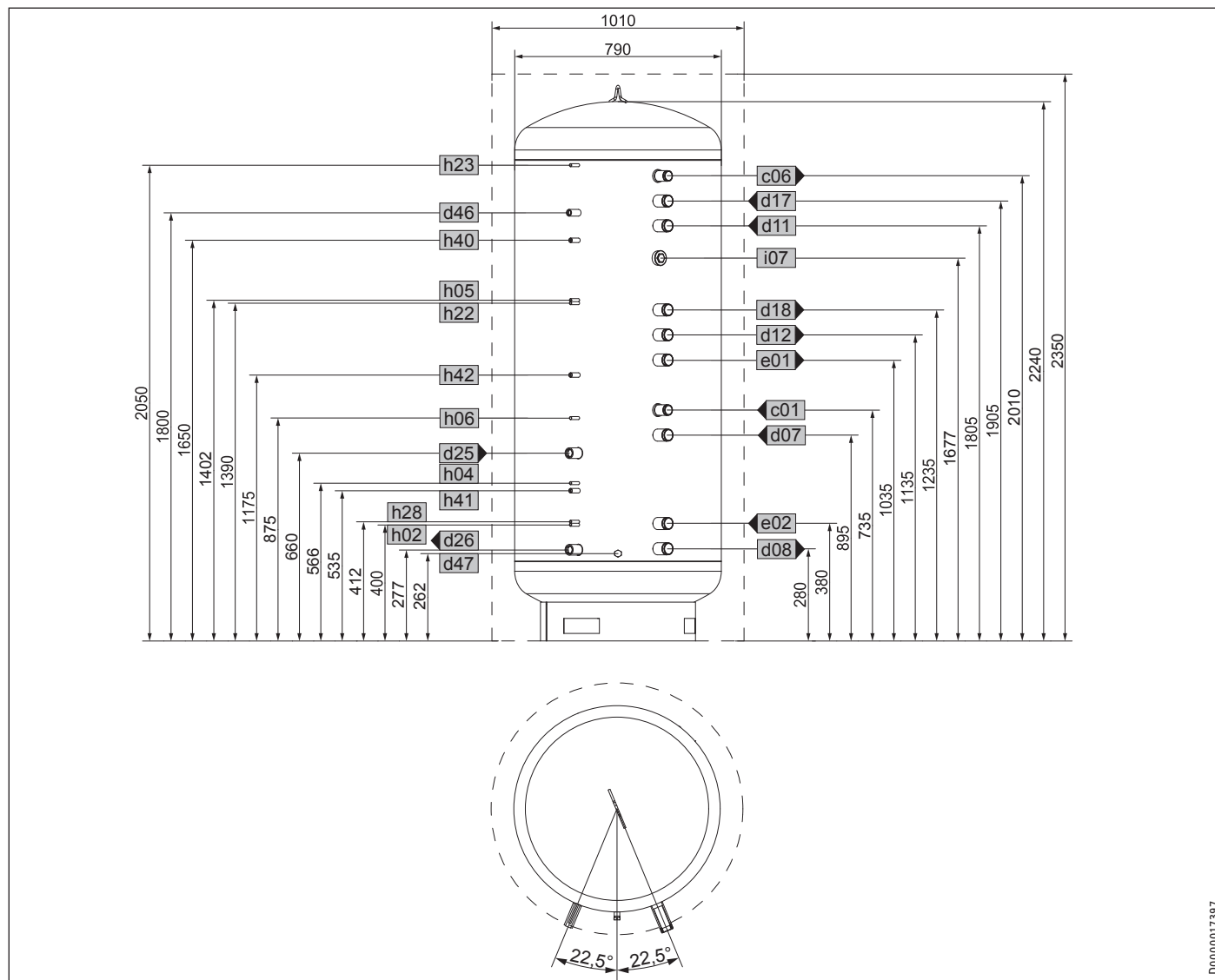

D0000017397

			SBS 1001 W	SBS 1001 W SOL
c01	Cold water inlet	Male thread	G 1 1/4 A	G 1 1/4 A
c06	DHW outlet	Male thread	G 1 1/4 A	G 1 1/4 A
d07	Heat pump heating flow	Male thread	G 1 1/2 A	G 1 1/2 A
d08	Heat pump heating return	Male thread	G 1 1/2 A	G 1 1/2 A
d11	Heat pump DHW flow	Male thread	G 1 1/2 A	G 1 1/2 A
d12	Heat pump DHW return	Male thread	G 1 1/2 A	G 1 1/2 A
d17	Flow 2nd heat source	Male thread	G 1 1/2 A	G 1 1/2 A
d18	Return 2nd heat source	Male thread	G 1 1/2 A	G 1 1/2 A
d25	Solar flow	Female thread		G 1
d26	Solar return	Female thread		G 1
d46	Ventilation	Female thread	G 1/2	G 1/2
d47	Drain	Male thread	G 3/4 A	G 3/4 A
e01	Heating flow	Male thread	G 1 1/2 A	G 1 1/2 A
e02	Heating return	Male thread	G 1 1/2 A	G 1 1/2 A

			SBS 1001 W	SBS 1001 W SOL
h02	Sensor heat pump return	Diameter	mm	9.5
h04	Sensor heat pump return optional	Diameter	mm	9.5
h05	Sensor heat pump DHW	Diameter	mm	9.5
h06	Sensor heat pump DHW opt.	Diameter	mm	9.5
h22	Sensor heat source	Diameter	mm	9.5
h23	Sensor heat source opt.	Diameter	mm	9.5
h28	Sensor solar cylinder	Diameter	mm	9.5
h40	Thermometer DHW	Diameter	mm	14.5
h41	Thermometer solar	Diameter	mm	14.5
h42	Thermometer heating	Diameter	mm	14.5
i07	Electric emergency/booster heater	Female thread		G 1 1/2

If the system configuration is different, the connection allocation can be changed.

# Installation Specification

## Recommended connection allocation SBS 1501 W | SBS 1501 W SOL

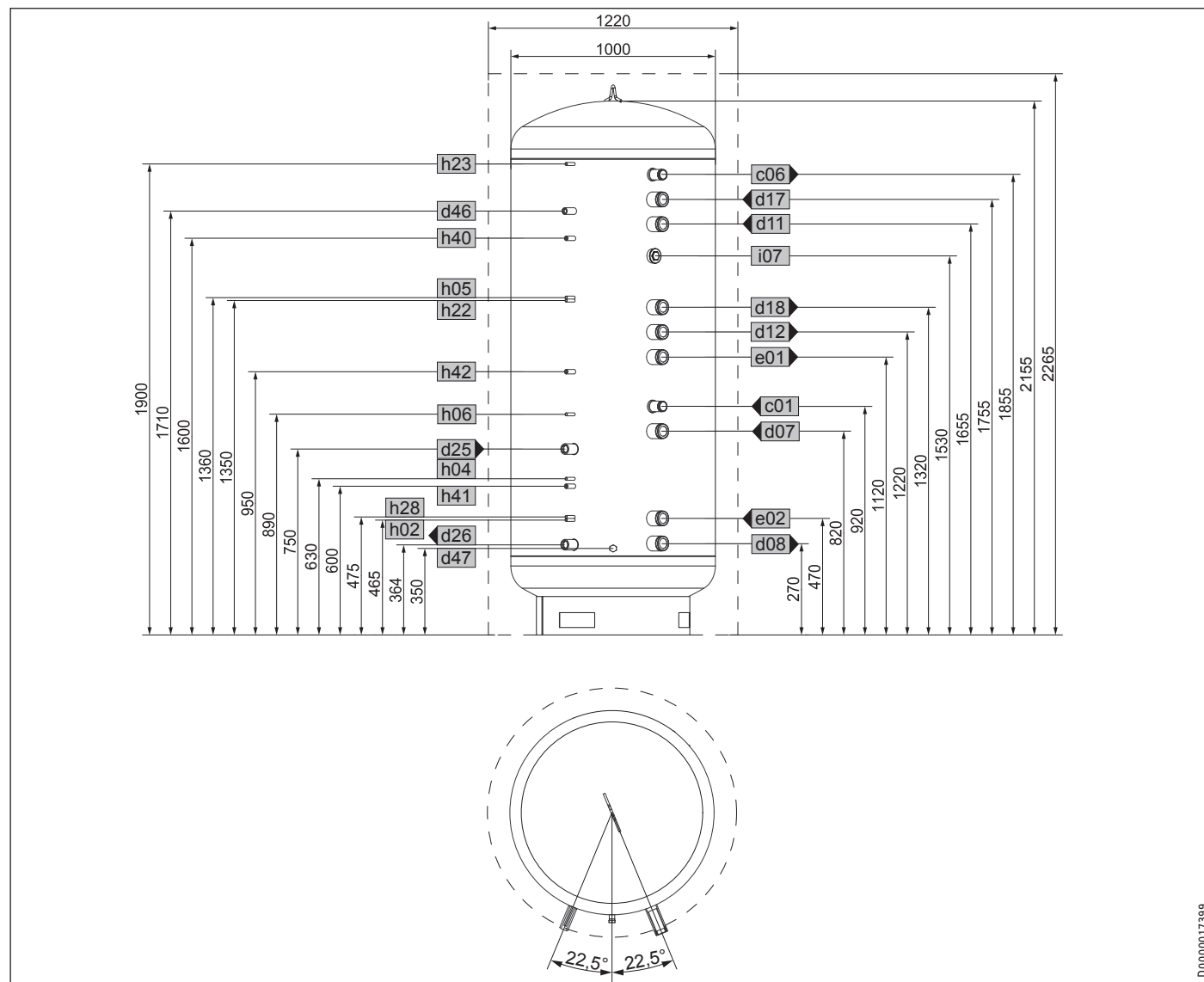

ENGLISH

D0000017399

		SBS 1501 W		SBS 1501 W SOL				SBS 1501 W		SBS 1501 W SOL	
c01	Cold water inlet	Male thread	G 1 1/4 A	G 1 1/4 A							
c06	DHW outlet	Male thread	G 1 1/4 A	G 1 1/4 A							
d07	Heat pump heating flow	Male thread	G 2 A	G 2 A							
d08	Heat pump heating return	Male thread	G 2 A	G 2 A							
d11	Heat pump DHW flow	Male thread	G 2 A	G 2 A							
d12	Heat pump DHW return	Male thread	G 2 A	G 2 A							
d17	Flow 2nd heat source	Male thread	G 2 A	G 2 A							
d18	Return 2nd heat source	Male thread	G 2 A	G 2 A							
d25	Solar flow	Female thread		G 1							
d26	Solar return	Female thread		G 1							
d46	Ventilation	Female thread	G 1/2	G 1/2							
d47	Drain	Male thread	G 3/4 A	G 3/4 A							
e01	Heating flow	Male thread	G 2 A	G 2 A							
e02	Heating return	Male thread	G 2 A	G 2 A							
h02	Sensor heat pump return	Diameter	mm	9.5	9.5						
h04	Sensor heat pump return optional	Diameter	mm	9.5	9.5						
h05	Sensor heat pump DHW	Diameter	mm	9.5	9.5						
h06	Sensor heat pump DHW opt.	Diameter	mm	9.5	9.5						
h22	Sensor heat source	Diameter	mm	9.5	9.5						
h23	Sensor heat source opt.	Diameter	mm	9.5	9.5						
h28	Sensor solar cylinder	Diameter	mm		9.5						
h40	Thermometer DHW	Diameter	mm	14.5	14.5						
h41	Thermometer solar	Diameter	mm		14.5						
h42	Thermometer heating	Diameter	mm	14.5	14.5						
i07	Electric emergency/booster heater	Female thread	G 1 1/2	G 1 1/2							

If the system configuration is different, the connection allocation can be changed.

# Installation Specification

## SBS W

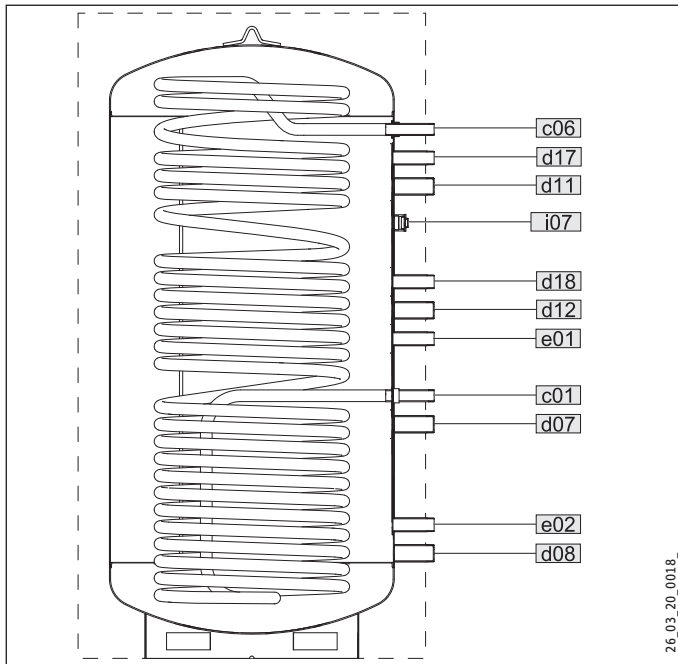

- c01 Cold water inlet
- c06 DHW outlet
- d07 Heat pump heating flow
- d08 Heat pump heating return
- d11 Heat pump DHW flow
- d12 Heat pump DHW return
- d17 Flow 2nd heat source

## Also with the SBS W SOL

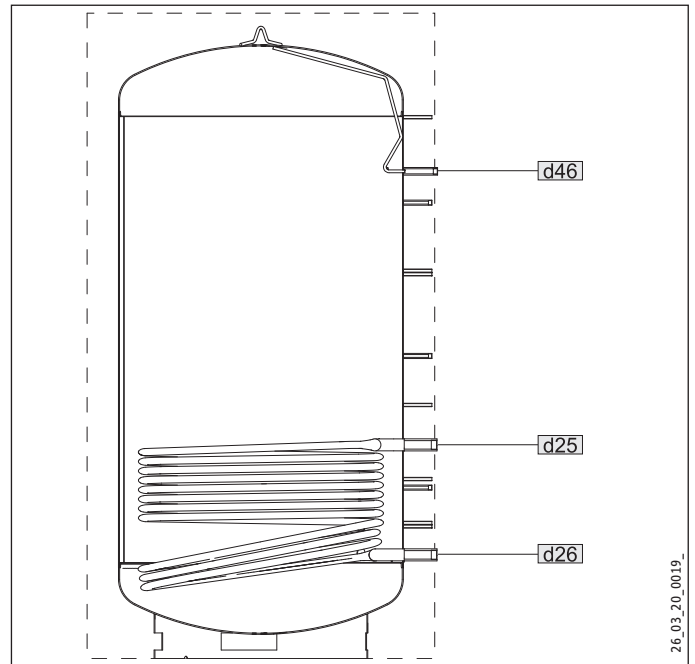

- d18 Return 2nd heat source
- d25 Solar flow
- d26 Solar return
- d46 Ventilation
- d47 Drain
- e01 Heating flow
- e02 Heating return

## 15.2 Data table

		SBS 601 W	SBS 801 W	SBS 1001 W	SBS 1501 W	SBS 601 W SOL	SBS 801 W SOL	SBS 1001 W SOL	SBS 1501 W SOL
		229980	229981	229982	229983	229984	229985	229986	229987
<b>Hydraulic data</b>									
Rated capacity	l	613	759	941	1430	599	740	916	1399
Capacity, lower indirect coil	l					11.6	14.9	19.8	23.6
Content, indirect coil, DHW	l	31.2	33.9	45.4	52.1	31.2	33.9	45.4	52.1
Surface area, lower indirect coil	m <sup>2</sup>					1.5	2.4	3.2	3.7
Surface area, DHW indirect coil	m <sup>2</sup>	6.0	6.5	8.7	10.0	6.0	6.5	8.7	10.0
Pressure drop at 1.0 m <sup>3</sup> /h, indirect coil, bottom	hPa					4	28	35	40
Pressure drop at 10/25/40 l/min	hPa	33 / 264 / -	35 / 284 / -	47 / 378 / 1023	53 / 432 / 1168	33 / 264 / -	35 / 284 / -	47 / 378 / 1023	53 / 432 / 1168
<b>Application limits</b>									
Maximum charge / discharge flow rate with zoning	m <sup>3</sup> /h	1.8	2.0	2.4	3.0	1.8	2.0	2.4	3.0
Maximum charge / discharge flow rate without zoning	m <sup>3</sup> /h	5.0	5.0	5.0	8.0	5.0	5.0	5.0	8.0
Max. permissible pressure	MPa	0.3	0.3	0.3	0.3	0.3	0.3	0.3	0.3
Test pressure	MPa	0.45	0.45	0.45	0.45	0.45	0.45	0.45	0.45
Max. permissible pressure, DHW	MPa	1.0	1.0	1.0	1.0	1.0	1.0	1.0	1.0
Max. permissible temperature	°C	95	95	95	95	95	95	95	95
Max. recommended collector aperture area	m <sup>2</sup>					12	16	20	30
<b>Dimensions</b>									
Height	mm	1665	1830	2240	2155	1665	1830	2240	2155
Height incl. thermal insulation	mm	1775	1940	2350	2265	1775	1940	2350	2265
Diameter	mm	750	790	790	1000	750	790	790	1000
Diameter incl. thermal insulation	mm	970	1010	1010	1220	970	1010	1010	1220
Height of unit when tilted	mm	1840	1880	2285	2225	1840	1880	2285	2225
<b>Weights</b>									
Weight (wet)	kg	735	949	1175	1738	780	1175	1221	1794
Weight (dry)	kg	135	150	175	236	180	195	220	291

## Guarantee

The guarantee conditions of our German companies do not apply to appliances acquired outside of Germany. In countries where our subsidiaries sell our products a guarantee can only be issued by those subsidiaries. Such guarantee is only granted if the subsidiary has issued its own terms of guarantee. No other guarantee will be granted.

We shall not provide any guarantee for appliances acquired in countries where we have no subsidiary to sell our products. This will not affect warranties issued by any importers.

## Environment and recycling

We would ask you to help protect the environment. After use, dispose of the various materials in accordance with national regulations.