



Gruppo di pressione con 2 pompe verticali multistadio acciaio inox completo di basamento con antivibranti, collettore di aspirazione e di mandata, valvola a sfera, valvola di non ritorno, con o senza 2 serbatoi a membrana.

Quadro elettrico completo di:

- Interruttore generale
- Interruttore magnetotermico

Circuito ausiliario in bassa tensione completo di trasformatore e fusibili di protezione.

Impieghi: Per l'approvvigionamento d'acqua con aspirazione da pozzi.

Per aumentare la pressione disponibile da una rete di distribuzione.

Pressure group with 2 multi multistage stainless steel vertical pumps complete with basement with antivibration device, suction and delivery manifold, ball valve and non-return valve, available with or without 2 membrane tanks.

Electric box complete with:

- general switch
- thermic switch

Low tension ancillary circuit complete with transformer and protecting cut-outs.

Application: For water supply from wells and to increase pressure from a water system.

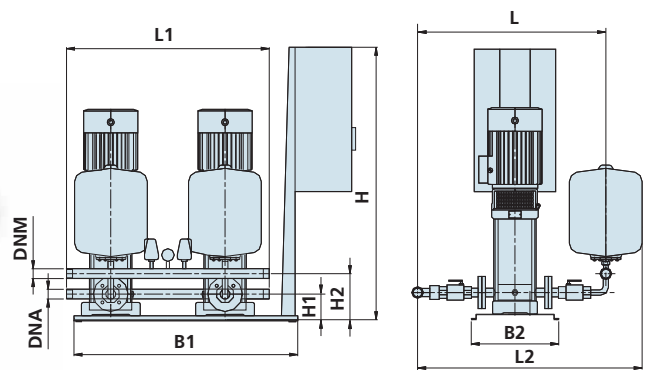

Monofase Single-phase	Trifase Three-phase	Potenza nominale Nominal power		Portata Capacity	Misura Size	Collettori Collector		Dimensioni (mm) - Dimensions (mm)								
		kW	HP			DNA	DNM	B1	B2	H	H1	H2	L	L1	L2	
230V ~ 50Hz	230/400V ~ 50Hz			l/min	bar											
VSM 2-7	VS 2-7	0,75+0,75	1+1	50+50	2,5÷4	G 1" 1/2	G 1" 1/2	800	340	990	160	260	650	495	820	
VSM 2-11	VS 2-11	1,1+1,1	1,5+1,5	60+60	3,5÷5	G 1" 1/2	G 1" 1/2	800	340	990	160	260	650	495	820	
VSM 4-6	VS 4-6	1,1+1,1	1,5+1,5	80+80	2,5÷4	G 2"	G 2"	800	340	990	160	260	670	495	840	
VSM 4-8	VS 4-8	1,5+1,5	2+2	100+100	3,5÷5	G 2"	G 2"	800	340	990	160	260	670	495	840	
	VS 4-12	2,2+2,2	3+3	120+120	4÷6	G 2"	G 2"	800	340	990	160	260	670	495	840	
	VS 8-6	2,2+2,2	3+3	120+120	3,5÷5	G 2" 1/2	G 2" 1/2	1100	500	1040	240	350	740	495	900	
	VS 8-8	3+3	4+4	140+140	4÷6	G 2" 1/2	G 2" 1/2	1100	500	1040	240	350	740	495	900	
	VS 8-10	4+4	5,5+5,5	150+150	5÷7	G 2" 1/2	G 2" 1/2	1100	500	1040	240	350	740	495	900	
	VS 8-15	5,5+5,5	7,5+7,5	160+160	6,5÷8	G 2" 1/2	G 2" 1/2	1100	500	1040	240	350	740	495	900	
	VS 8-19	7,5+7,5	10+10	200+200	6,5÷8	G 2" 1/2	G 2" 1/2	1100	500	1040	240	350	740	495	900	

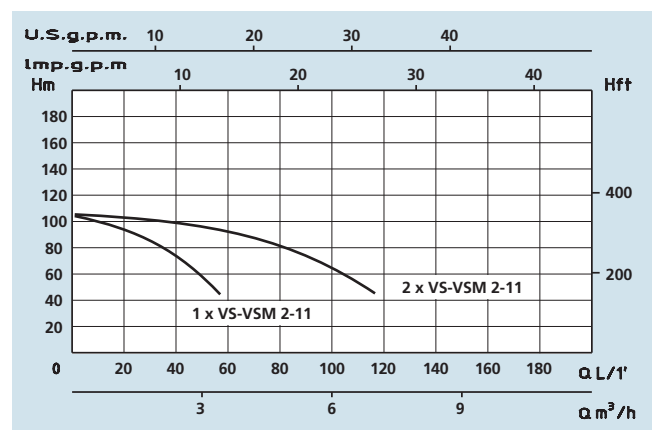
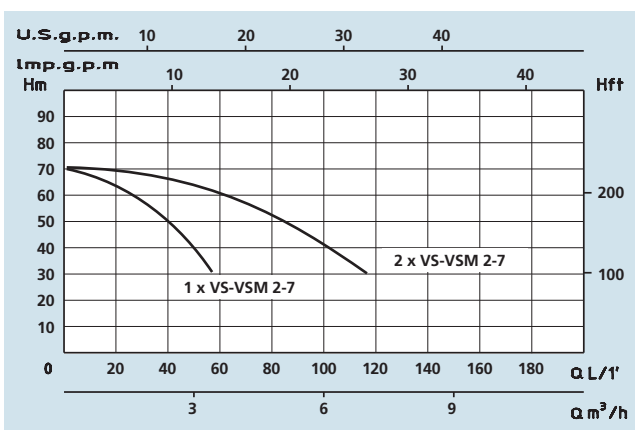

GRUPPI CON POMPE VERTICALI MULTISTADIO ACCIAIO INOX PRESSURE SYSTEM WITH MULTISTAGE STAINLESS STEEL VERTICAL PUMPS

VS

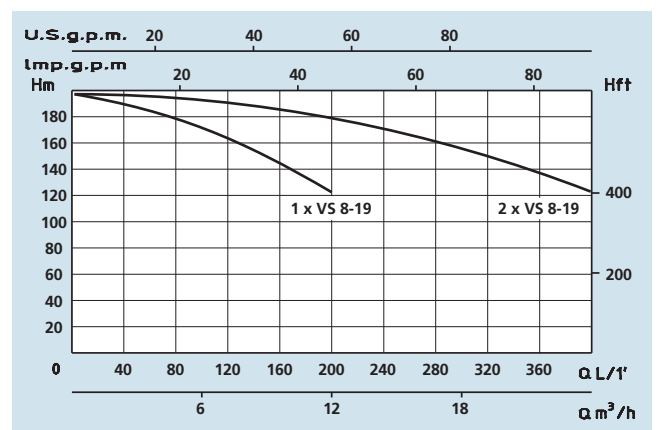
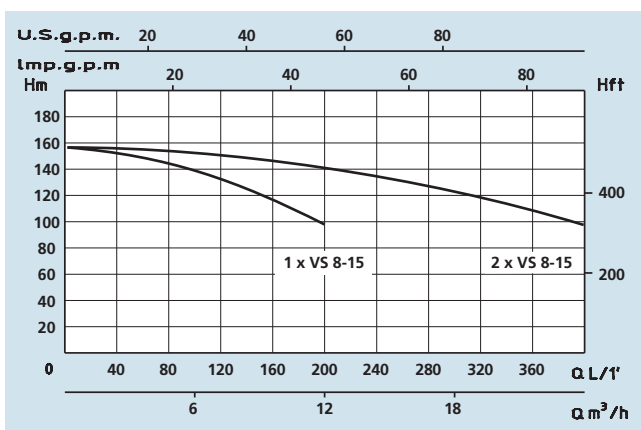
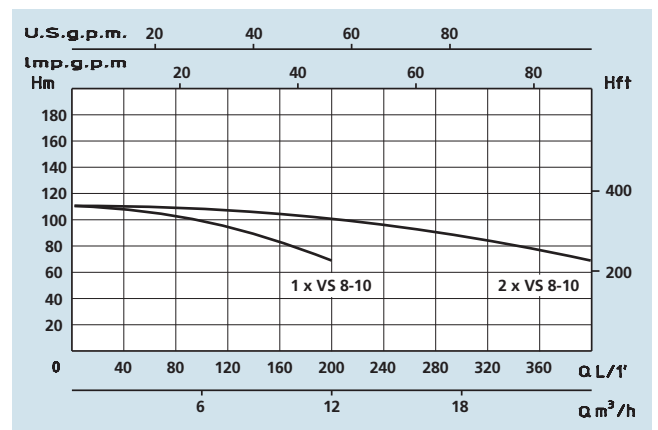
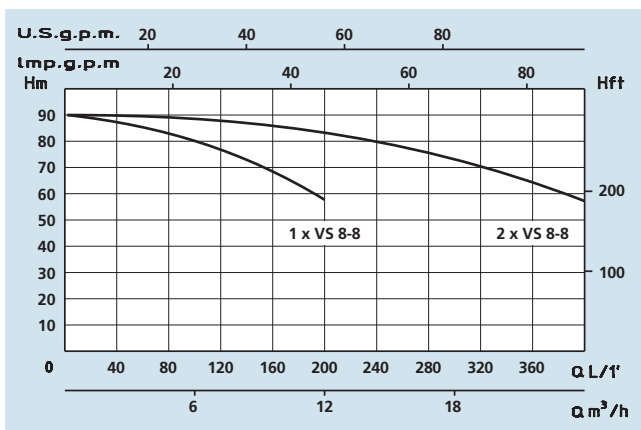
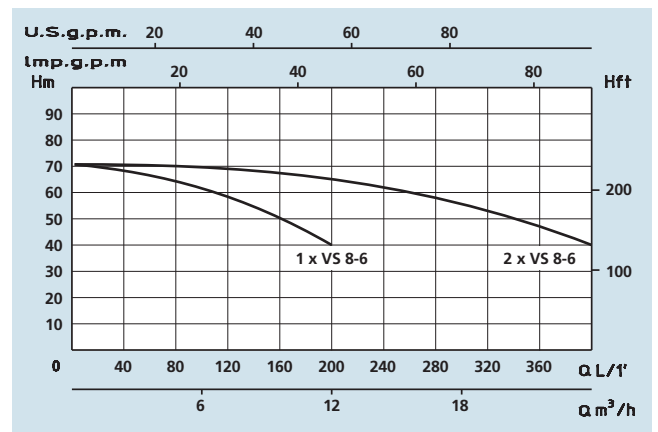
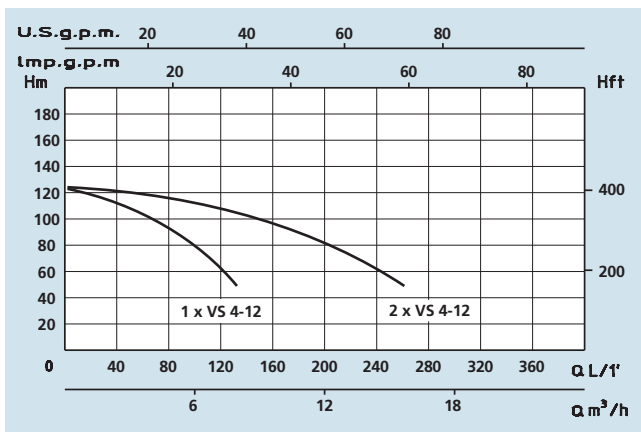
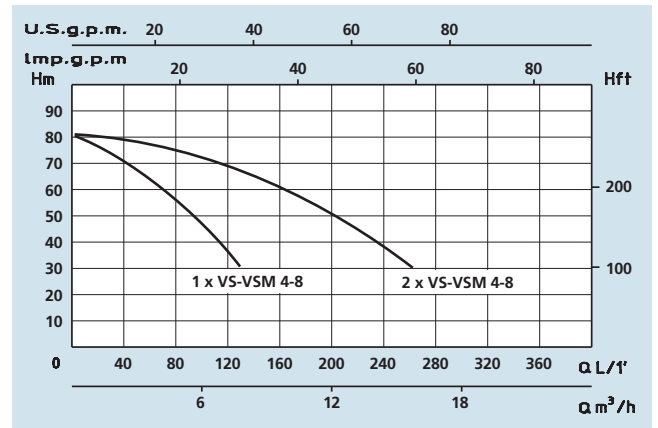
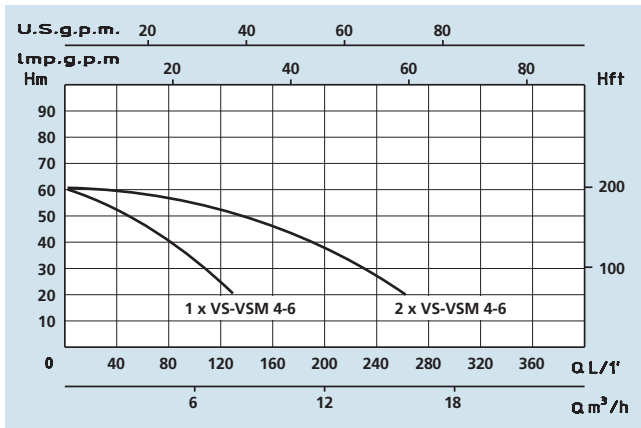



Gruppo di pressione con 2 pompe verticali multistadio acciaio inox completo di basamento con antivibranti, collettore di aspirazione e di mandata, valvola a sfera, valvola di non ritorno, con o senza 2 serbatoi a membrana.

Quadro elettrico completo di:

- Interruttore generale
- Interruttore magnetotermico

Circuito ausiliario in bassa tensione completo di trasformatore e fusibili di protezione.

Impieghi: Per l'approvvigionamento d'acqua con aspirazione da pozzi.

Per aumentare la pressione disponibile da una rete di distribuzione.

Pressure group with 2 multi multistage stainless steel vertical pumps complete with basement with antivibration device, suction and delivery manifold, ball valve and non-return valve, available with or without 2 membrane tanks.

Electric box complete with:

- general switch
- thermic switch

Low tension ancillary circuit complete with transformer and protecting cut-outs.

Application: For water supply from wells and to increase pressure from a water system.

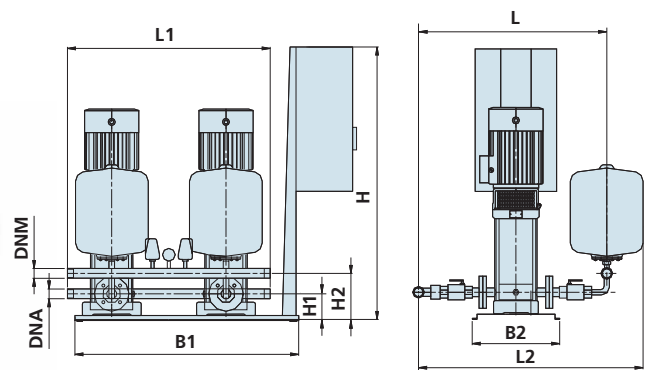

Trifase Three-phase	Potenza nominale Nominal power		Portata Capacity	Misura Size	Collettori Collector		Dimensioni (mm) - Dimensions (mm)							
	kW	HP			DNA	DNM	B1	B2	H	H1	H2	L	L1	L2
230/400V ~ 50Hz			l/min	bar										
VS 16-4	4+4	5,5+5,5	140+140	2,5÷4	G 3"	G 2"1/2	1100	500	1040	250	360	760	495	920
VS 16-6	5,5+5,5	7,5+7,5	160+160	3,5÷5	G 3"	G 2"1/2	1100	500	1040	250	360	760	495	920
VS 16-8	7,5+7,5	10+10	200+200	4÷6	G 3"	G 2"1/2	1100	500	1040	250	360	760	495	920
VS 20-5	5,5+5,5	7,5+7,5	300+300	3,5÷5	G 3"	G 2"1/2	1100	500	1040	250	360	760	495	920
VS 20-7	7,5+7,5	10+10	300+300	4÷6	G 3"	G 2"1/2	1100	500	1040	250	360	760	495	920
VS 20-10	11+11	15+15	350+350	6,5÷8	G 3"	G 2"1/2	1100	500	1040	250	360	760	495	920
VS 32-4	7,5+7,5	10+10	250+250	4÷6	G 4"	G 4"	1100	500	1040	280	390	800	495	960
VS 32-5	11+11	15+15	300+300	5÷7	G 4"	G 4"	1100	500	1040	280	390	800	495	960
VS 32-6	11+11	15+15	350+350	6,5÷8	G 4"	G 4"	1100	500	1040	280	390	800	495	960
VS 42-3	11+11	15+15	400+400	5÷7	G 6"	G 6"	1100	500	1040	320	430	850	495	1010

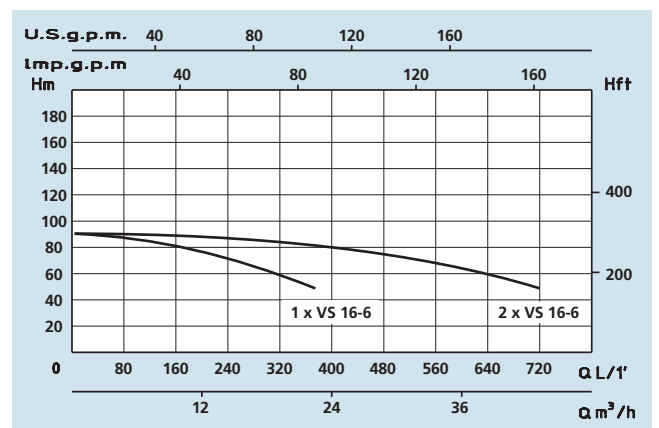
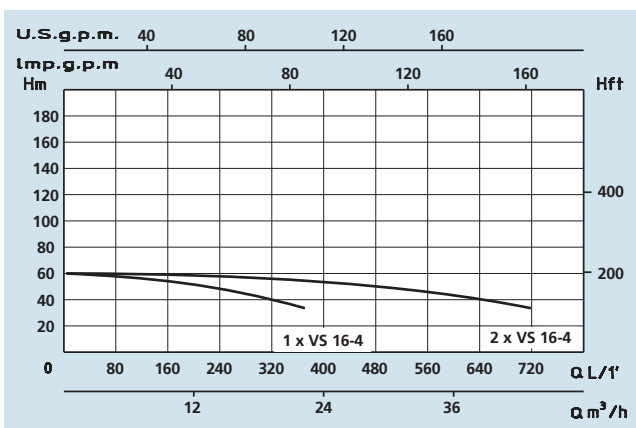

GRUPPI CON POMPE VERTICALI MULTISTADIO ACCIAIO INOX PRESSURE SYSTEM WITH MULTISTAGE STAINLESS STEEL VERTICAL PUMPS

VS

