



TECHNICAL & SERVICE MANUAL



SAP-K181GJH + SAP-C181GH
SAP-K241GJH + SAP-C241GH

FILE NO.

Destination: General area (50Hz)

SPLIT SYSTEM AIR CONDITIONER

Indoor Model No.	Product Code No.
SAP-K181GJH-S	1 852 068 02
SAP-K241GJH-S	1 852 068 03

Outdoor Model No.	Product Code No.
SAP-C181GH-S	1 852 068 04
SAP-C241GH-S	1 852 068 05

Indoor Unit

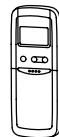
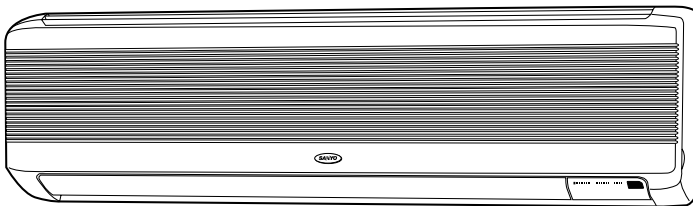

SAP-K181GJH
SAP-K241GJH

Outdoor Unit

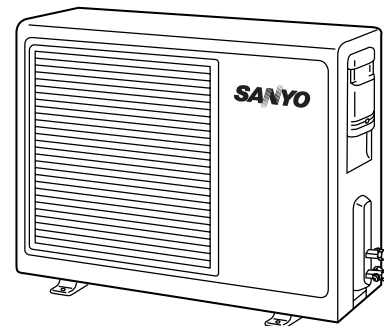

SAP-C181GH
SAP-C241GH

REFERENCE NO. SM700439

Important!

Please Read Before Starting

This air conditioning system meets strict safety and operating standards. As the installer or service person, it is an important part of your job to install or service the system so it operates safely and efficiently.

For safe installation and trouble-free operation, you must:

- Carefully read this instruction booklet before beginning.
- Follow each installation or repair step exactly as shown.
- Observe all local, state, and national electrical codes.
- Pay close attention to all warning and caution notices given in this manual.



WARNING

This symbol refers to a hazard or unsafe practice which can result in severe personal injury or death.



CAUTION

This symbol refers to a hazard or unsafe practice which can result in personal injury or product or property damage.

If Necessary, Get Help

These instructions are all you need for most installation sites and maintenance conditions. If you require help for a special problem, contact our sales/service outlet or your certified dealer for additional instructions.

In Case of Improper Installation

The manufacturer shall in no way be responsible for improper installation or maintenance service, including failure to follow the instructions in this document.

Special Precautions

WARNING

When Wiring



ELECTRICAL SHOCK CAN CAUSE SEVERE PERSONAL INJURY OR DEATH. ONLY A QUALIFIED, EXPERIENCED ELECTRICIAN SHOULD ATTEMPT TO WIRE THIS SYSTEM.

- Do not supply power to the unit until all wiring and tubing are completed or reconnected and checked.
- Highly dangerous electrical voltages are used in this system. Carefully refer to the wiring diagram and these instructions when wiring. Improper connections and inadequate grounding can cause accidental injury or death.
- Ground the unit following local electrical codes.
- Connect all wiring tightly. Loose wiring may cause overheating at connection points and a possible fire hazard.

When Transporting

Be careful when picking up and moving the indoor and outdoor units. Get a partner to help, and bend your knees when lifting to reduce strain on your back. Sharp edges or thin aluminum fins on the air conditioner can cut your fingers.

When Installing...

...In a Ceiling or Wall

Make sure the ceiling/wall is strong enough to hold the unit's weight. It may be necessary to construct a strong wood or metal frame to provide added support.

...In a Room

Properly insulate any tubing run inside a room to prevent "sweating" that can cause dripping and water damage to walls and floors.

...In Moist or Uneven Locations

Use a raised concrete pad or concrete blocks to provide a solid, level foundation for the outdoor unit. This prevents water damage and abnormal vibration.

...In an Area with High Winds

Securely anchor the outdoor unit down with bolts and a metal frame. Provide a suitable air baffle.

...In a Snowy Area (for Heat Pump-type Systems)

Install the outdoor unit on a raised platform that is higher than drifting snow. Provide snow vents.

When Connecting Refrigerant Tubing

- Use the flare method for connecting tubing.
- Apply refrigerant lubricant to the matching surfaces of the flare and union tubes before connecting them, then tighten the nut with a torque wrench for a leak-free connection.
- Check carefully for leaks before starting the test run.

When Servicing

- Turn the power off at the main power box (mains) before opening the unit to check or repair electrical parts and wiring.
- Keep your fingers and clothing away from any moving parts.
- Clean up the site after you finish, remembering to check that no metal scraps or bits of wiring have been left inside the unit being serviced.

Others



CAUTION

- Ventilate any enclosed areas when installing or testing the refrigeration system. Escaped refrigerant gas, on contact with fire or heat, can produce dangerously toxic gas.
- Confirm upon completing installation that no refrigerant gas is leaking. If escaped gas comes in contact with a stove, gas water heater, electric room heater or other heat source, it can produce dangerously toxic gas.

Table of Contents

	Page
1. OPERATING RANGE	1
2. SPECIFICATIONS	
2-1. Unit Specifications	2
2-2. Major Component Specifications	4
2-3. Other Component Specifications	8
3. DIMENSIONAL DATA	9
4. REFRIGERANT FLOW DIAGRAM	12
5. PERFORMANCE DATA	
5-1. Performance charts	13
5-2. Air Throw Distance Chart	15
5-3. Cooling Capacity	16
5-4. Heating Capacity	18
6. ELECTRICAL DATA	
6-1. Electrical Characteristics	19
6-2. Electric Wiring Diagram	21
7. INSTALLATION INSTRUCTIONS	
7-1. Installation Site Selection	24
7-2. Remote Control Unit Installation Position	26
7-3. Wiring instructions	27
8. FUNCTION	
8-1. Room Temperature Control	28
8-2. Dry Operation	30
8-3. Automatic Switching between Cooling and Heating	30
8-4. Freeze Prevention	31
8-5. Overload Prevention	31
8-6. Cold draft Prevention	32
8-7. Defrosting Operation	33
8-8. Outdoor Fan Speed Control	34
9. TROUBLESHOOTING	
9-1. Check before and after troubleshooting	35
9-2. Air conditioner does not operate	36
9-3. Some part of air conditioner does not operate	40
9-4. Air conditioner operates, but abnormalities are observed	42
9-5. If a sensor is defective	44
10. CHECKING ELECTRICAL COMPONENTS	
10-1. Measurement of Insulation Resistance	45
10-2. Checking Continuity of Fuse on PCB Ass'y	46
10-3. Checking Motor Capacitor	46
APPENDIX INSTRUCTION MANUAL	47

1. OPERATING RANGE

	Temperature	Indoor Air Intake Temp.	Outdoor Air Intake Temp.
Cooling	Maximum	32°C D.B. / 23°C W.B.	43°C D.B.
	Minimum	19°C D.B. / 14°C W.B.	19°C D.B.
Heating	Maximum	27°C D.B.	24°C D.B. / 18°C W.B.
	Minimum	16°C D.B.	- 8°C D.B. / - 9°C W.B.

2. SPECIFICATIONS

2-1. Unit Specifications

Indoor Unit **SAP-K181GJH**
 Outdoor Unit **SAP-C181GH**

Power Source				220 - 240 V Single phase 50Hz				
Voltage rating		V		220 / 230 / 240				
Performance			Cooling		Heating			
	Capacity	kW		5.00 / 5.00 / 5.05				
		BTU/h		17,100 / 17,100 / 17,200		19,500 / 19,600 / 19,800		
	Air circulation (High)		m ³ /h		760			
Moisture removal (High)		Liters/h		2.7		—		
Electrical Rating	Available voltage range		V		198 to 264			
	Running amperes		A		10.4 / 10.4 / 10.6		8.9 / 9.1 / 9.4	
	Power input		W		2,150 / 2,200 / 2,250		1,830 / 1,880 / 1,960	
	Power factor		%		94 / 92 / 88		93 / 90 / 87	
	C.O.P.		W/W		2.33 / 2.27 / 2.24		3.11 / 3.06 / 2.96	
	Compressor locked rotor amperes		A		45 / 46 / 48			
Features	Controls / Temperature control			Microprocessor / I.C. thermostat				
	Control unit			Wireless remote control unit				
	Timer			1-hour OFF / 12-hour ON or OFF				
	Fan speeds		Indoor / Outdoor	3 and Auto / Auto (Hi, Lo)				
	Airflow direction (Indoor)		Horizontal	Manual				
			Vertical	Auto				
	Air filter			Washable, Anti-Mold				
	Compressor			Rotary (Hermetic)				
	Refrigerant / Amount charged at shipment		g	R22 / 1,330				
	Refrigerant control			Capillary tube				
	Operation sound		Indoor – Hi / Me / Lo	dB-A	45 / 41 / 36		45 / 41 / 36	
			Outdoor – Hi	dB-A	53		53	
	Refrigerant tubing connections			Flare type				
	Max. allowable tubing length at shipment		m		7.5			
	Refrigerant tube diameter		Narrow tube	mm (in.)	6.35 (1/4)			
Wide tube			mm (in.)	12.7 (1/2)				
Refrigerant tube kit / Accessories			Optional / Hanging wall bracket					
Dimensions & Weight	Unit dimensions		Height	mm	Indoor Unit	285	Outdoor Unit	630
			Width		mm		995	810
			Depth		mm		196	275
	Package dimensions		Height	mm	276	704		
			Width		mm		1,070	953
			Depth		mm		363	369
	Weight		Net	kg	12.0	50.0		
			Shipping	kg	15.0	54.5		
	Shipping volume		m ³		0.11	0.25		

DATA SUBJECT TO CHANGE WITHOUT NOTICE.

Remarks: Rating conditions are:

- Cooling: Indoor air temperature 27°C D.B. / 19°C W.B.
- Outdoor air temperature 35°C D.B. / 24°C W.B.
- Heating: Indoor air temperature 20°C D.B.
- Outdoor air temperature 7°C D.B. / 6°C W.B.

Indoor Unit **SAP-K241GJH**
 Outdoor Unit **SAP-C241GH**

Power Source		220 - 240 V Single phase 50Hz		
Voltage rating		V 220 / 230 / 240		
Performance	Capacity	kW	Cooling 6.40 / 6.40 / 6.40 Heating 7.20 / 7.20 / 7.30	
		BTU/h	21,800 / 21,800 / 21,800 24,600 / 24,600 / 24,900	
	Air circulation (High)	m ³ /h	830	
	Moisture removal (High)	Liters/h	3.3 —	
Electrical Rating	Available voltage range	V	198 to 264	
	Running amperes	A	13.3 / 13.2 / 13.1 12.9 / 12.7 / 12.9	
	Power input	W	2,780 / 2,780 / 2,820 2,680 / 2,710 / 2,780	
	Power factor	%	95 / 92 / 90 94 / 93 / 90	
	C.O.P.	W/W	2.30 / 2.30 / 2.27 2.69 / 2.66 / 2.63	
	Compressor locked rotor amperes	A	67 / 70 / 73	
Features	Controls / Temperature control		Microprocessor / I.C. thermostat	
	Control unit		Wireless remote control unit	
	Timer		1-hour OFF / 12-hour ON or OFF	
	Fan speeds Indoor / Outdoor		3 and Auto / Auto (Hi, Lo)	
	Airflow direction (Indoor)	Horizontal		Manual
		Vertical		Auto
	Air filter		Washable, Anti-Mold	
	Compressor		Rotary (Hermetic)	
	Refrigerant / Amount charged at shipment		g R22 / 1,675	
	Refrigerant control		Capillary tube	
	Operation sound	Indoor – Hi / Me / Lo	dB-A	48 / 45 / 41 48 / 45 / 41
		Outdoor – Hi	dB-A	55 56
	Refrigerant tubing connections		Flare type	
	Max. allowable tubing length at shipment		m	10
Refrigerant tube diameter	Narrow tube	mm (in.)	6.35 (1/4)	
	Wide tube	mm (in.)	15.88 (5/8)	
Refrigerant tube kit / Accessories		Optional / Hanging wall bracket		
Dimensions & Weight	Unit dimensions	Height	mm	Indoor Unit 285 Outdoor Unit 630
		Width	mm	995 810
		Depth	mm	196 275
	Package dimensions	Height	mm	276 704
		Width	mm	1,070 953
		Depth	mm	363 369
	Weight	Net	kg	12.0 58.0
		Shipping	kg	15.0 61.0
	Shipping volume		m ³	0.11 0.25

DATA SUBJECT TO CHANGE WITHOUT NOTICE.

Remarks: Rating conditions are:
 Cooling: Indoor air temperature 27°C D.B. / 19°C W.B.
 Outdoor air temperature 35°C D.B. / 24°C W.B.
 Heating: Indoor air temperature 20°C D.B.
 Outdoor air temperature 7°C D.B. / 6°C W.B.

2-2. Major Component Specifications

2-2-1. Indoor Unit

Indoor Unit **SAP-K181GJH**

Controller PCB	Part No.		POW-K181GJH		
	Controls		Microprocessor		
	Control circuit fuse		250 V – 3.15 A		
Remote Control Unit			RCS-7HS1E		
Fan & Fan Motor	Type		Cross-flow		
	Q'ty ... Dia. and length		mm	1 ... ø88 / L746	
	Fan motor model ... Q'ty		UF2-31A5P-S ... 1		
	No. of poles Hi rpm (Heat / Cool)		2 ... 1,335 / 1,215		
	Nominal output		W	30	
	Coil resistance (Ambient temp. 20°C)		Ω	WHT – BRN : 133.7 WHT – PNK : 168.4 - : - - : - - : -	
	Safety devices	Type	Internal protector		
		Operating temp.	Open °C	130 ± 8	
	Run capacitor		Close	Automatic reclosing	
			μF	2.0	
		VAC	440		
Flap Motor	Type		Stepping motor		
	Model		MP24GA2		
	Rating		DC 12 V		
	Coil resistance (Ambient temp. 20°C)		kΩ	Each terminals (1-2, 1-3, 1-4, 1-5) 400 : ± 7%	
Heat Exch. Coil	Coil		Aluminum plate fin / Copper tube		
	Rows		2		
	Fin pitch		mm	1.3	
	Face area		m ²	0.156	

DATA SUBJECT TO CHANGE WITHOUT NOTICE.

Indoor Unit **SAP-K241GJH**

Circuit Board Assy.	Part No.			POW-K241GJH
	Controls			Microprocessor
	Control circuit fuse			250 V – 3.15 A
Remote Control Unit				RCS-7HS1E
Fan & Fan Motor	Type			Cross-flow
	Q'ty ... Dia. and length		mm	1 ... ø88 / L746
	Fan motor model ... Q'ty			UF2-31A5P-S ... 1
	No. of poles Hi rpm (Heat / Cool)			2 ... 1,425 / 1,410
	Nominal output		W	30
	Coil resistance (Ambient temp. 20°C)		Ω	WHT – BRN : 133.7 WHT – PNK : 168.4 - : - - : - - : -
	Safety devices	Type		Internal protector
		Operating temp.	Open °C	130 ± 8
	Run capacitor	Close		Automatic reclosing
				2.0 440
Flap Motor	Type			Stepping motor
	Model			MP24GA2
	Rating			DC 12 V
	Coil resistance (Ambient temp. 20°C)		kΩ	Each terminals (1-2, 1-3, 1-4, 1-5) 400 : ± 7%
Heat Exch. Coil	Coil			Aluminum plate fin / Copper tube
	Rows			2
	Fin pitch		mm	1.3
	Face area		m2	0.156

DATA SUBJECT TO CHANGE WITHOUT NOTICE.

2-2-2. Outdoor Unit

Outdoor Unit **SAP-C181GH**

Controller PCB				POW-C186GH	
Compressor	Type			Rotary (Hermetic)	
	Compressor model			C-2R170H5T 80827445	
	Nominal output			W 1,700	
	Compressor oil ... Amount			cc SUNISO 4GSD-T ... 750	
	Coil resistance (Ambient temp. 25°C)			Ω C - R : 1.35 C - S : 3.42	
	Safety devices	Type			Internal protector
		Overload relay			—
		Operating temp.	Open	°C	170 ± 5
			Close	°C	105 ± 11
	Operating amp. (Ambient temp. 25°C)			Trip in 6 to 16 sec. at 40 A	
	Run capacitor			μF 40.0 VAC 400	
	Crank case heater			240V 30W	
Fan & Fan Motor	Type			Propeller	
	Q'ty ... Dia.			mm 1 ... ø 420	
	Fan motor model ... Q'ty			KFG6S-51A5PA-S ... 1	
	No. of poles ... rpm (230 V, High)			6 ... 870	
	Nominal output			W 50	
	Coil resistance (Ambient temp. 20°C)			Ω WHT - BRN : 67.1 WHT - YEL : 68.1 YEL - PNK : 15.7	
	Safety devices	Type			Internal protector
		Operating temp.	Open	°C	130 ± 8
	Close				Automatic reclosing
	Run capacitor			μF 4.0 VAC 440	
Heat Exch. Coil	Coil			Aluminum plate fin / Copper tube	
	Rows			1	
	Fin pitch			mm 1.4	
	Face area			m ² 0.485	
External Finish				Acrylic baked-on enamel finish	

DATA SUBJECT TO CHANGE WITHOUT NOTICE.

Outdoor Unit **SAP-C241GH**

Circuit Board Ass'y				POW-C186GH		
Compressor	Type			Rotary (Hermetic)		
	Compressor model			C-R221H5Q 80687345		
	Nominal output			W	2,200	
	Compressor oil ... Amount			cc	SUNISO 4GSD-T ... 750	
	Coil resistance (Ambient temp. 25°C)			Ω	C - R : 0.78 C - S : 2.41	
	Safety devices	Type			Internal protector	External (OLR)
		Overload relay			—	OL-D24
		Operating temp.	Open	°C	Automatic opening	150 ± 5
			Close	°C	Automatic reclosing	63 ± 11
	Operating amp. (Ambient temp. 25°C)			—	Trip in 6 to 16 sec. at 59 A	
	Run capacitor			μF	40.0	
			VAC	400		
Crank case heater			240V 30W			
Fan & Fan Motor	Type			Propeller		
	Q'ty ... Dia.			mm	1 ... ø 420	
	Fan motor model ... Q'ty			KFG4S-51B5P-S ... 1		
	No. of poles ... rpm (230 V, High)			4 ... 980		
	Nominal output			W	50	
	Coil resistance (Ambient temp. 20°C)			Ω	WHT - BRN : 54.7 WHT - YEL : 33.6 YEL - PNK : 17.0	
	Safety devices	Type			Internal protector	
		Operating temp.	Open	°C	130 ± 8	
	Close			Automatic reclosing		
	Run capacitor			μF	5.0	
			VAC	440		
Heat Exch. Coil	Coil			Aluminum plate fin / Copper tube		
	Rows			2		
	Fin pitch			mm	1.2	
	Face area			m ²	0.497	
External Finish				Acrylic baked-on enamel finish		

DATA SUBJECT TO CHANGE WITHOUT NOTICE.

2-3. Other Component Specifications

Indoor Unit **SAP-K181GJH**
SAP-K241GJH

Transformer (TR)		ATR-J105	
Rating	Primary	AC 230V, 50Hz	
	Secondary	19V, 0.526A	
	Capacity	10VA	
Coil resistance	Ω (at 21°C)	Primary (WHT – WHT):	205 \pm 10%
		Secondary (BRN – BRN):	2.0 \pm 10%
Thermal cut-off temp.		150°C	

Thermistor (Coil sensor)		DTN-TKS131B	
Resistance	k Ω	0°C	15.0 \pm 2%

Thermistor (Room sensor)		DTN-TKS142B	
Resistance	k Ω	25°C	5.0 \pm 3%

Outdoor Unit **SAP-C181GH**
SAP-C241GH

Power Relay (PR)		G4F-1123T-US	
Coil rating		DC 24V	
Coil resistance	Ω (at 20°C)	640 \pm 10%	
Contact rating		AC 240V, 20A	

Starting Relay (SR)		AMVL300A	
Coil rating		AC 300V, 50Hz	
Coil resistance	k Ω (at 23°C)	13.3 \pm 2%	
Contact rating		20A AC	
Operating voltage		AC 185 – 217V, 50Hz	
Return voltage		AC 60 – 120V, 50Hz	

Thermostat (Defrost thermo. 23D)		TRS02-12MSR	
Operating temp.	°C	ON	12 \pm 2
		Diff.	8 deg. below

Thermostat (Fan Speed Control 23S)		MQT5S	
Switching temp.	°C	high \rightarrow LOW	28.5°C \pm 1.5
		low \rightarrow HIGH	31.5°C \pm 2
Contact rating		AC 220V, 3A	

4-way Valve (Solenoid coil)		LB64012 (Coil), V26-110B (Valve)	
Coil rating		AC 220-240V, 50/60Hz, 6W	
Coil resistance	Ω (at 20°C)	2,000 \pm 7%	

3. DIMENSIONAL DATA

Indoor Unit **SAP-K181GJH**
 SAP-K241GJH

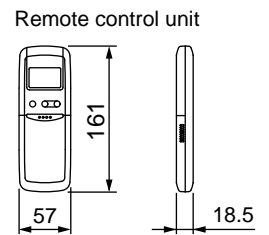
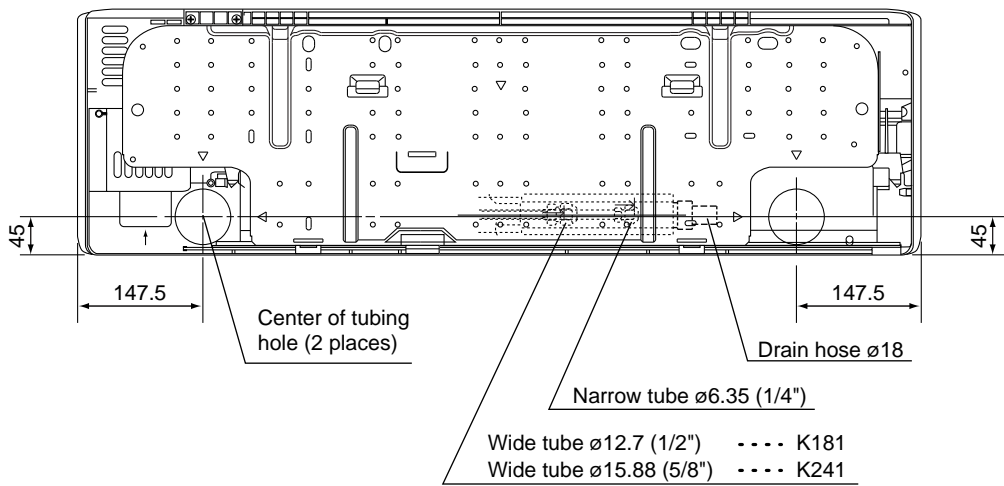
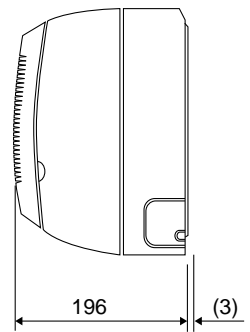
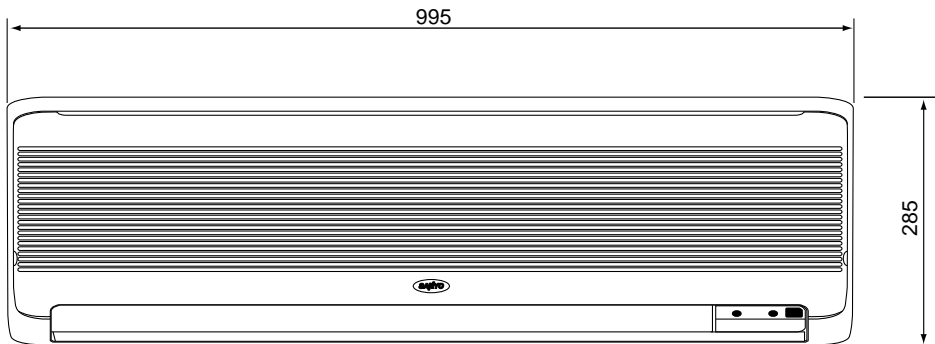
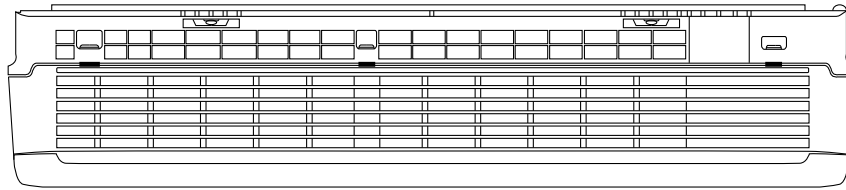

Unit : mm

Outdoor Unit **SAP-C181GH**

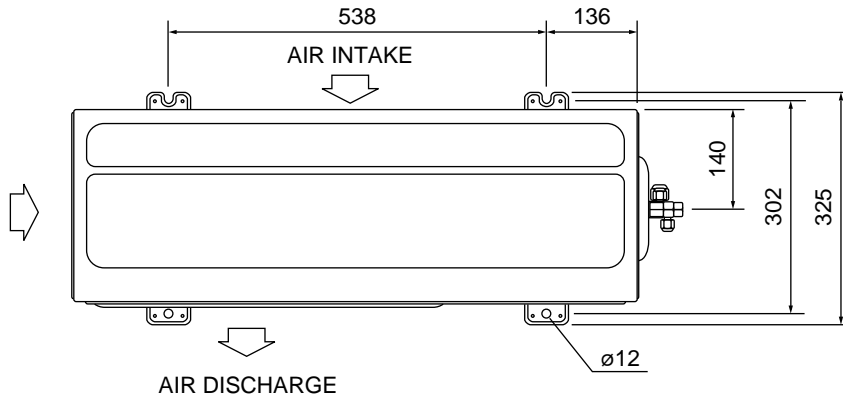

Wide tube service valve
 $\phi 12.7$ (1/2")

Narrow tube service valve
 $\phi 6.35$ (1/4")

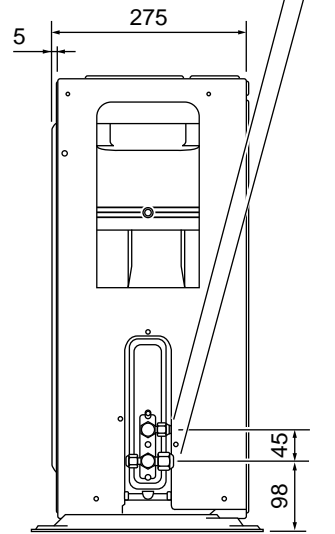
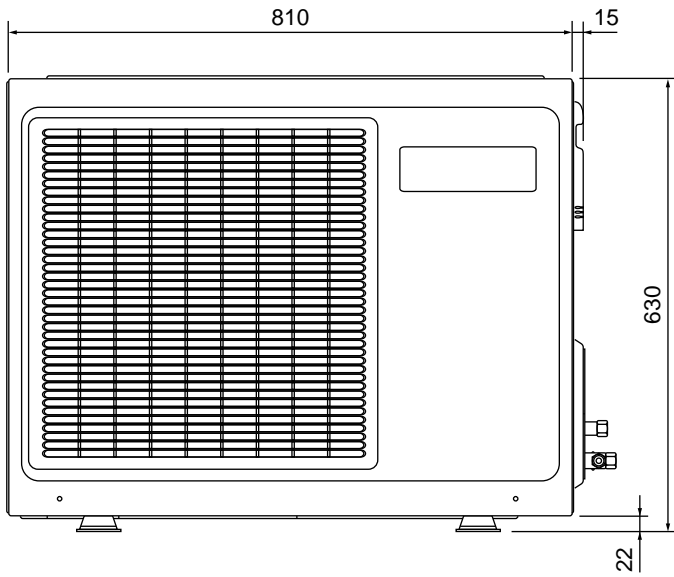

Unit : mm

Outdoor Unit : SAP-C241GH

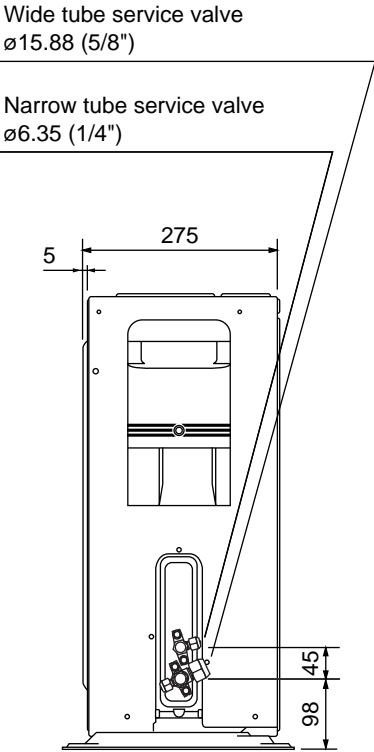
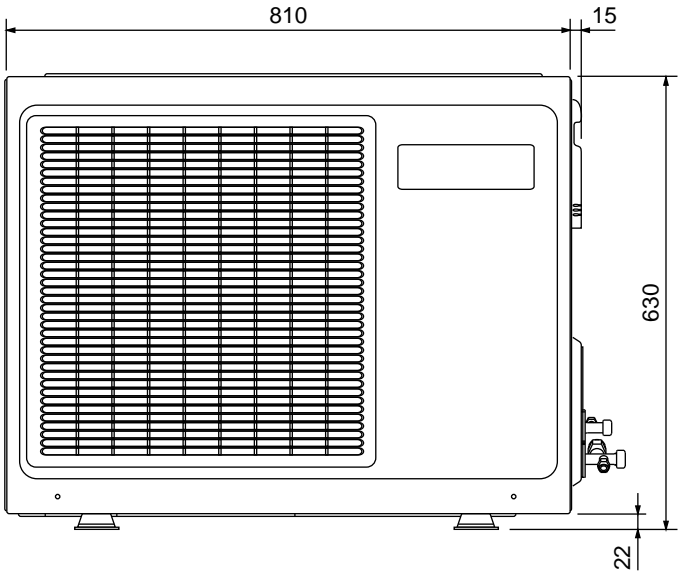
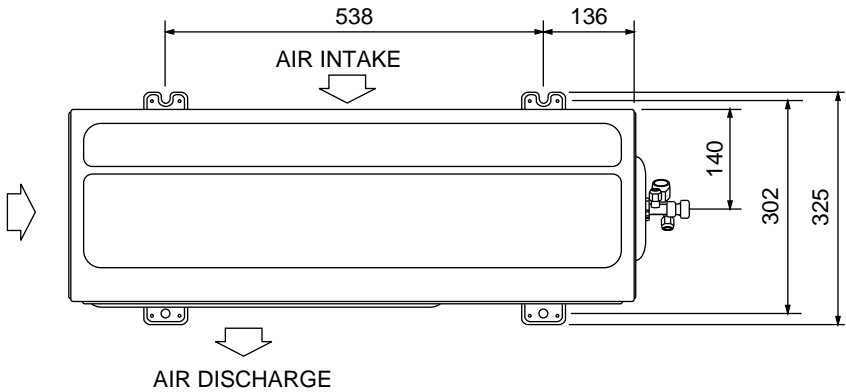

Unit : mm

4. REFRIGERANT FLOW DIAGRAM

Indoor Unit

SAP-K181GJH

Outdoor Unit

SAP-C181GH

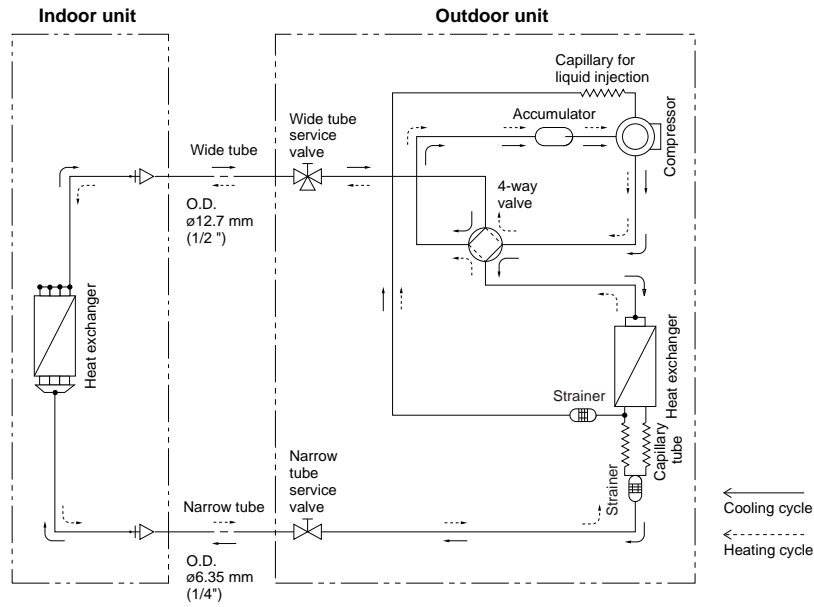

Indoor Unit

SAP-K241GJH

Outdoor Unit

SAP-C241GH

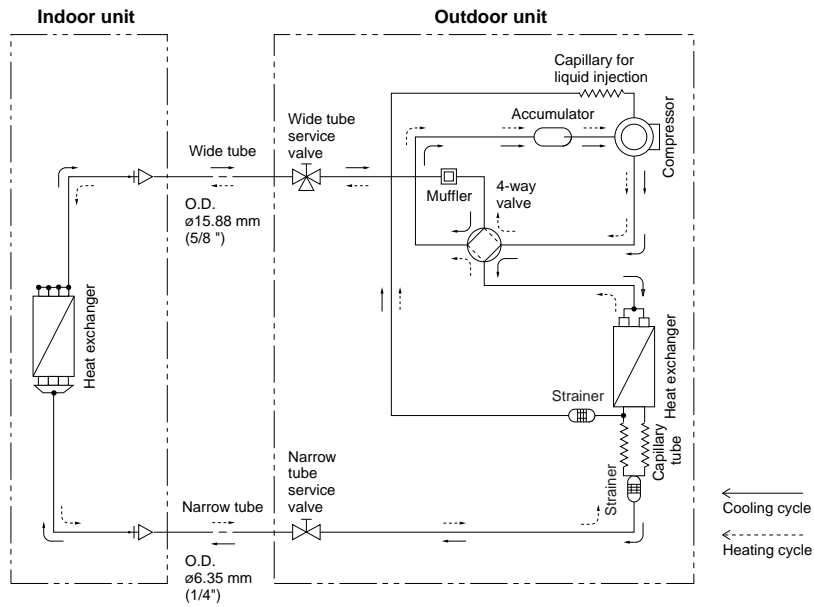

Insulation of Refrigerant Tubing

IMPORTANT

Because capillary tubing is used in the outdoor unit, both the wide and narrow tubes of this air conditioner become cold. To prevent heat loss and wet floors due to dripping of condensation, **both tubes must be well insulated** with a proper insulation material. The thickness of the insulation should be a min. 8 mm.



CAUTION

After a tube has been insulated, never try to bend it into a narrow curve because it can cause the tube to break or crack.

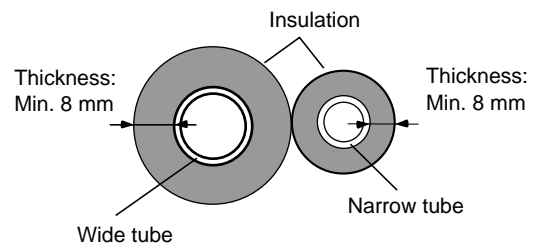

5. PERFORMANCE DATA

5-1. Performance charts

Indoor Unit **SAP-K181GJH**
 Outdoor Unit **SAP-C181GH**

■ Cooling Characteristics

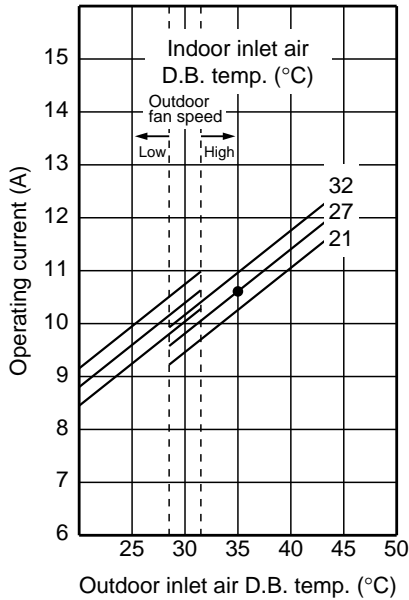

■ Heating Characteristics

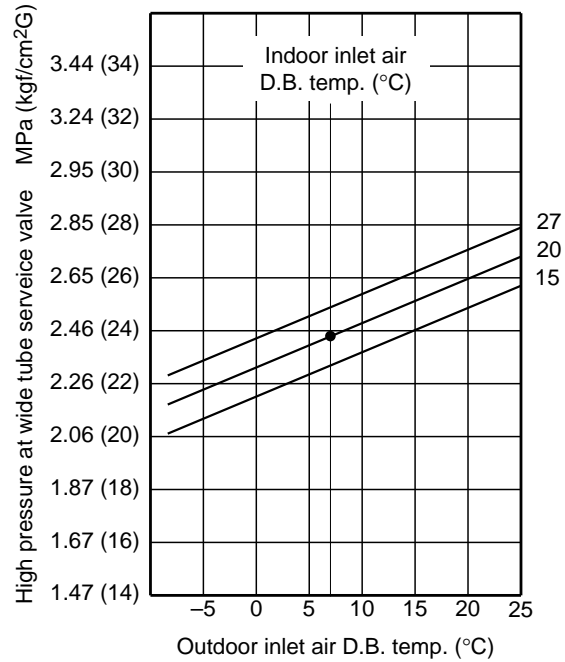
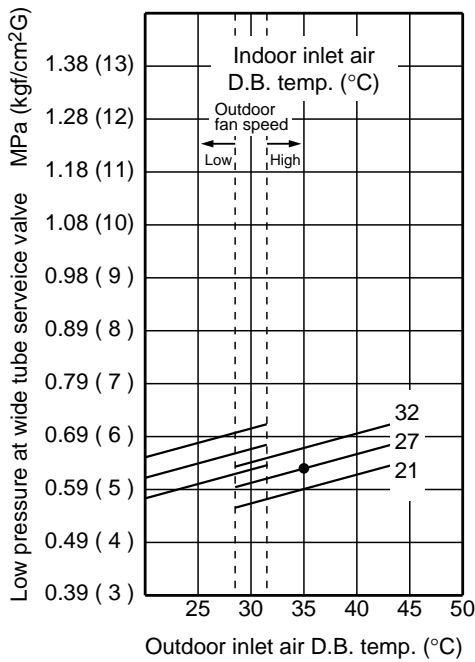
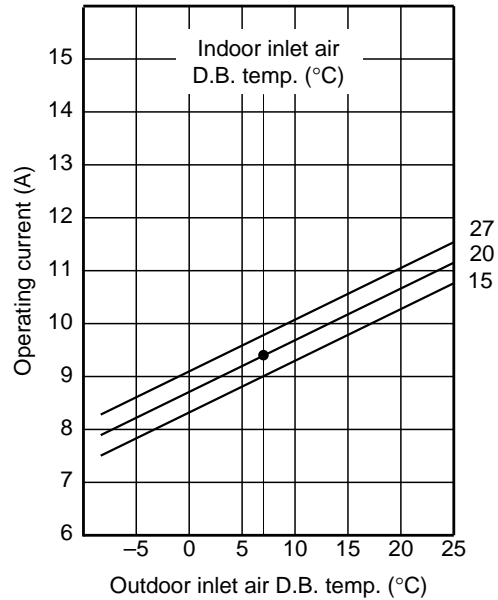

NOTE

Overload prevention operates to protect the air conditioner when outdoor ambient temperature reaches extremely high in heating mode. (Refer to “8-5 Overload prevention”)

● Points of Rating condition

Black dots in above charts indicate the following rating conditions.

Cooling: Indoor air temperature 27°C D.B./19°C W.B.
 Outdoor air temperature 35°C D.B./24°C W.B.

Heating: Indoor air temperature 20°C D.B.
 Outdoor air temperature 7°C D.B./6°C W.B.

Indoor Unit **SAP-K241GJH**
 Outdoor Unit **SAP-C241GH**

■ Cooling Characteristics

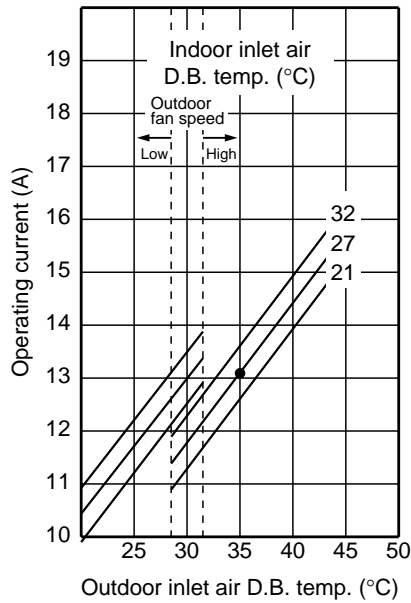

■ Heating Characteristics

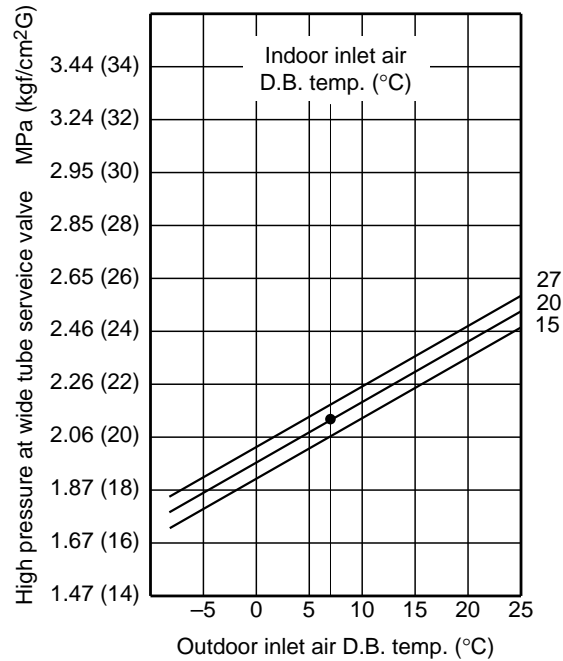
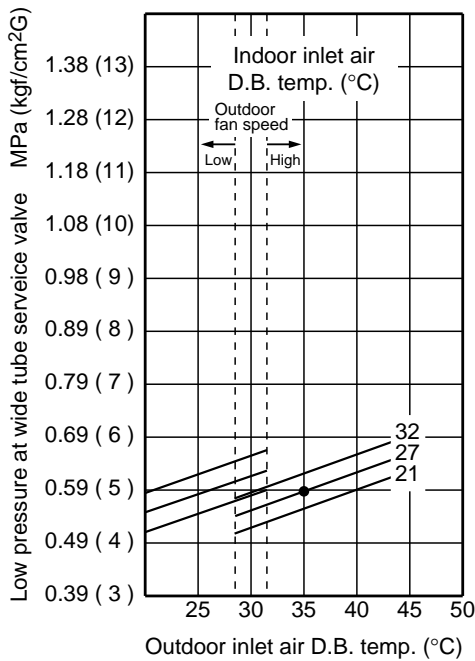
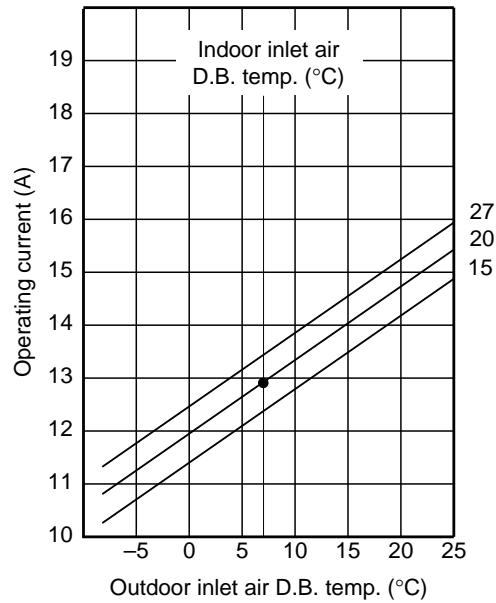

NOTE

Overload prevention operates to protect the air conditioner when outdoor ambient temperature reaches extremely high in heating mode. (Refer to “8-5 Overload prevention”)

● Points of Rating condition

Black dots in above charts indicate the following rating conditions.

Cooling: Indoor air temperature 27°C D.B./19°C W.B.
 Outdoor air temperature 35°C D.B./24°C W.B.

Heating: Indoor air temperature 20°C D.B.
 Outdoor air temperature 7°C D.B./6°C W.B.

5-2. Air Throw Distance Chart

Indoor Unit **SAP-K181GJH**

Room air temp. : 27°C

Fan speed : High

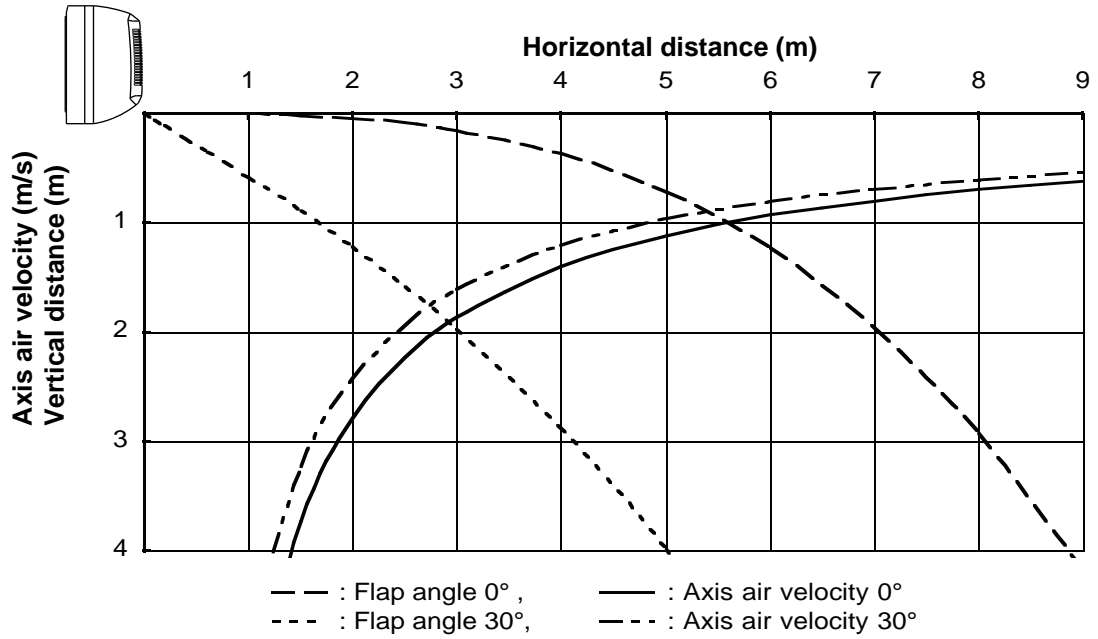

Indoor Unit **SAP-K241GJH**

Room air temp. : 27°C

Fan speed : High

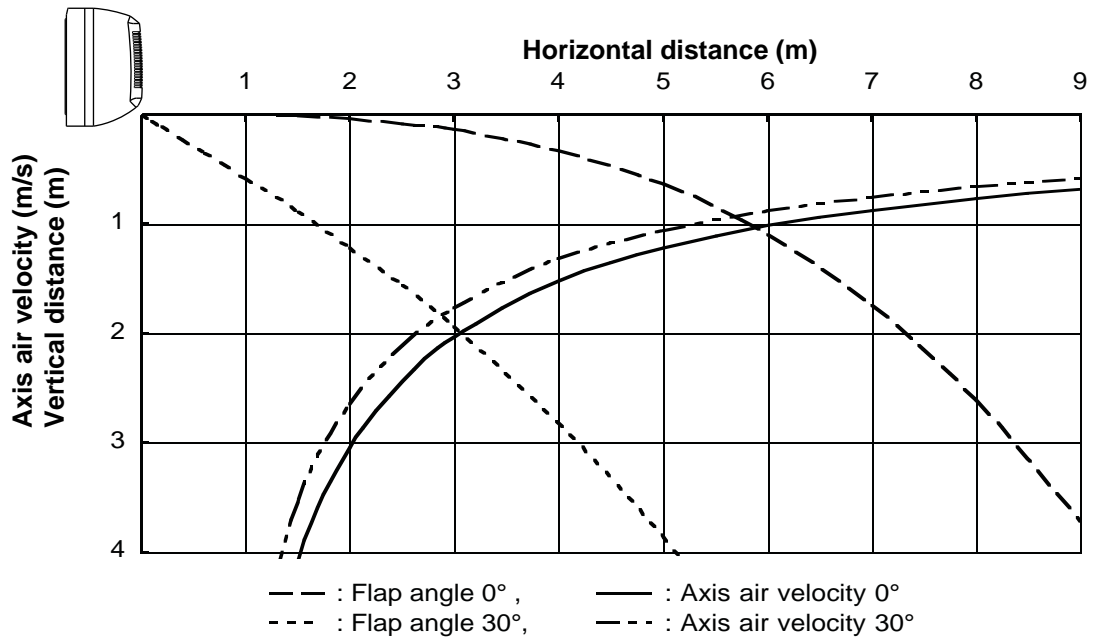

5-3. Cooling Capacity

Indoor Unit **SAP-K181GJH**
 Outdoor Unit **SAP-C181GH**

240V Single Phase 50Hz

RATING CAPACITY		5.05 kW				
AIR FLOW RATE		760 m ³ /h				
EVAPORATOR		CONDENSER				
ENT. TEMP. °C		OUTDOOR AMBIENT TEMP. °C				
W.B.	D.B.		30	35	40	43
15		TC	4.65	4.42	4.16	3.83
		CM	1.81	1.94	2.13	2.37
	21	SHC	3.09	2.97	2.83	2.66
	23	SHC	3.44	3.32	3.18	3.02
	25	SHC	3.80	3.68	3.54	3.37
	27	SHC	4.15	4.03	3.89	3.73
	29	SHC	4.51	4.39	4.16	3.83
	31	SHC	4.65	4.42	4.16	3.83
17		TC	4.98	4.75	4.46	4.11
		CM	1.86	2.00	2.18	2.43
	21	SHC	2.72	2.61	2.47	2.30
	23	SHC	3.08	2.96	2.82	2.65
	25	SHC	3.43	3.32	3.18	3.01
	27	SHC	3.79	3.67	3.53	3.36
	29	SHC	4.14	4.03	3.89	3.72
	31	SHC	4.50	4.38	4.24	4.07
19		TC	5.30	# 5.05	4.75	4.37
		CM	1.92	2.06	2.25	2.50
	21	SHC	2.34	2.22	2.08	1.92
	23	SHC	2.69	2.58	2.44	2.27
	25	SHC	3.05	2.93	2.79	2.63
	27	SHC	3.40	3.29	3.15	2.98
	29	SHC	3.76	3.64	3.50	3.34
	31	SHC	4.11	4.00	3.86	3.69
21		TC	5.62	5.35	5.03	4.63
		CM	1.97	2.12	2.31	2.57
	23	SHC	2.30	2.19	2.05	1.88
	25	SHC	2.66	2.54	2.40	2.24
	27	SHC	3.01	2.90	2.76	2.59
	29	SHC	3.37	3.25	3.11	2.95
23		TC	5.95	5.62	5.26	4.89
		CM	2.02	2.17	2.37	2.63
	25	SHC	2.24	2.10	1.97	1.83
	27	SHC	2.59	2.46	2.32	2.18
	29	SHC	2.95	2.81	2.67	2.54
	31	SHC	3.30	3.17	3.03	2.89

TC : Total Cooling Capacity (kW)

SHC : Sensible Heat Capacity (kW)

CM : Compressor Input (kW)

Rating conditions (#Mark) are

Outdoor Ambient Temp. 35°C D.B.

Indoor Unit Entering Air Temp. 27°C D.B. / 19°C W.B.

Indoor Unit **SAP-K241GJH**
 Outdoor Unit **SAP-C241GH**

240V Single Phase 50Hz

RATING CAPACITY		6.40 kW				
AIR FLOW RATE		830 m ³ /h				
EVAPORATOR		CONDENSER				
ENT. TEMP. °C		OUTDOOR AMBIENT TEMP. °C				
W.B.	D.B.		30	35	40	43
15		TC	5.89	5.61	5.27	4.85
		CM	2.26	2.42	2.65	2.97
	21	SHC	3.82	3.66	3.46	3.24
	23	SHC	4.20	4.04	3.84	3.62
	25	SHC	4.58	4.42	4.22	4.00
	27	SHC	4.96	4.80	4.60	4.38
	29	SHC	5.34	5.18	4.99	4.76
	31	SHC	5.72	5.56	5.27	4.85
17		TC	6.32	6.02	5.66	5.20
		CM	2.32	2.49	2.73	3.04
	21	SHC	3.43	3.27	3.08	2.85
	23	SHC	3.81	3.65	3.46	3.23
	25	SHC	4.19	4.03	3.84	3.61
	27	SHC	4.57	4.41	4.22	3.99
	29	SHC	4.95	4.79	4.60	4.37
	31	SHC	5.33	5.17	4.98	4.75
19		TC	6.72	# 6.40	6.02	5.54
		CM	2.39	2.57	2.81	3.13
	21	SHC	3.02	2.85	2.66	2.44
	23	SHC	3.40	3.23	3.05	2.82
	25	SHC	3.78	3.61	3.43	3.20
	27	SHC	4.16	3.99	3.81	3.58
	29	SHC	4.54	4.37	4.19	3.96
	31	SHC	4.92	4.76	4.57	4.34
21		TC	7.12	6.78	6.38	5.87
		CM	2.46	2.64	2.89	3.21
	23	SHC	2.97	2.81	2.62	2.40
	25	SHC	3.35	3.19	3.00	2.78
	27	SHC	3.73	3.57	3.38	3.16
	29	SHC	4.11	3.95	3.76	3.54
23		TC	7.55	7.12	6.67	6.20
		CM	2.52	2.71	2.96	3.29
	25	SHC	2.89	2.71	2.51	2.32
	27	SHC	3.27	3.09	2.89	2.70
	29	SHC	3.65	3.47	3.27	3.09
	31	SHC	4.03	3.85	3.65	3.47

TC : Total Cooling Capacity (kW)

SHC : Sensible Heat Capacity (kW)

CM : Compressor Input (kW)

Rating conditions (#Mark) are

Outdoor Ambient Temp. 35°C D.B.

Indoor Unit Entering Air Temp. 27°C D.B. / 19°C W.B.

5-4. Heating Capacity

Indoor Unit **SAP-K181GJH** **SAP-K241GJH**
Outdoor Unit **SAP-C181GH** **SAP-C241GH**

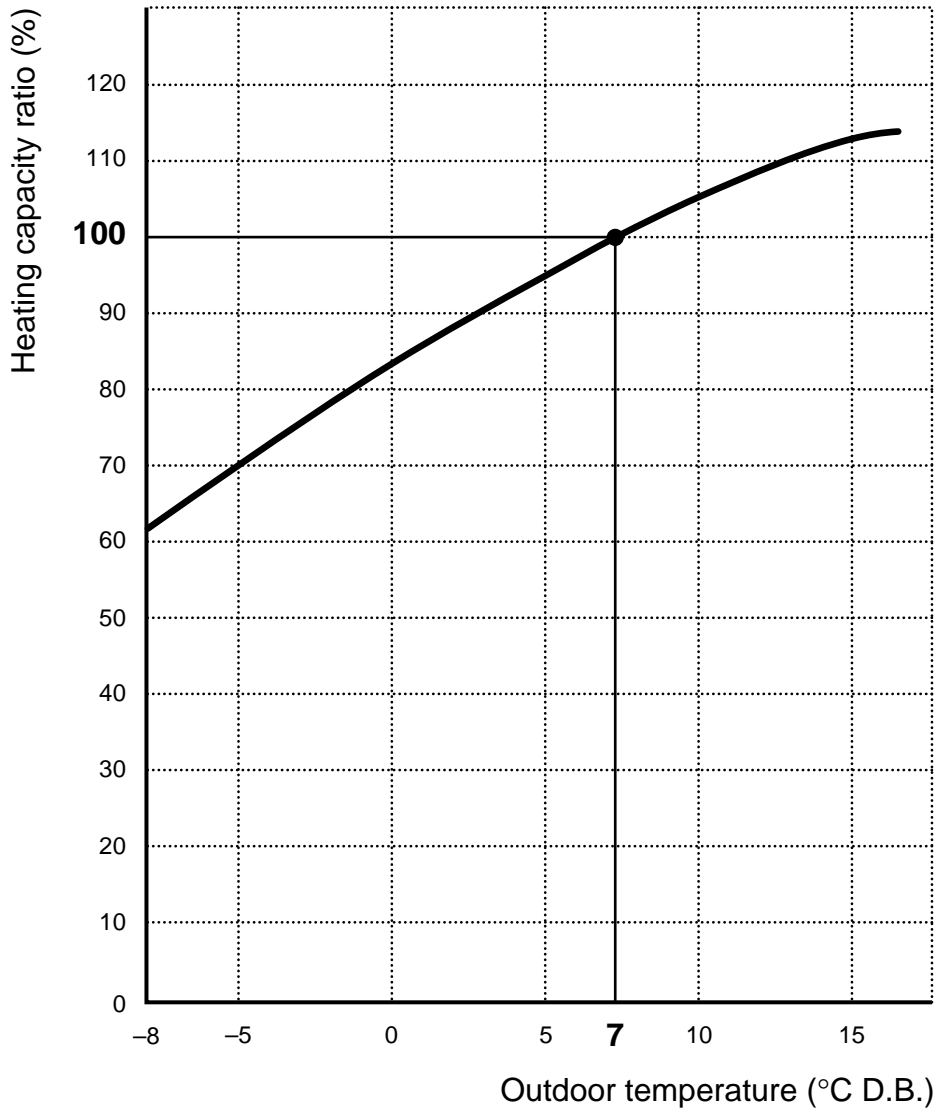

NOTE

- 1) ●... Point of Rating condition
Black dot in the chart indicate the following rating condition.
Indoor : 20°C D.B.
Outdoor : 7°C D.B. / 6°C W.B.
- 2) Above characteristics indicate instantaneous operation, which does not take into account defrost operation.
- 3) Fan speed : High
- 4) Because this air conditioner heats a room by drawing in the heat of the outside air (heat pump system), the heating efficiency will fall off when the outdoor temperature is very low. If sufficient heat cannot be obtained with this air conditioner, use another heating appliance in conjunction with it.

6. ELECTRICAL DATA

6-1. Electrical Characteristics

Indoor Unit **SAP-K181GJH**
 Outdoor Unit **SAP-C181GH**

COOLING

			Indoor Unit	Outdoor Unit		Complete Unit
			Fan Motor	Fan Motor	Compressor	
Performance at			220 / 240V Single phase 50Hz			
Rating Conditions	Running Amps.	A	0.37 / 0.38	0.48 / 0.50	9.55 / 9.72	10.4 / 10.6
	Power Input	kW	0.070 / 0.073	0.106 / 0.119	1.974 / 2.058	2.15 / 2.25
Full Load Conditions	Running Amps.	A	0.37 / 0.38	0.48 / 0.50	12.05 / 11.62	12.9 / 12.5
	Power Input	kW	0.070 / 0.073	0.106 / 0.119	2.564 / 2.628	2.74 / 2.82

Rating Conditions : Indoor Air Temperature 27°C D.B. / 19°C W.B.
 Outdoor Air Temperature 35°C D.B.

Full Load Conditions : Indoor Air Temperature 32°C D.B. / 23°C W.B.
 Outdoor Air Temperature 43°C D.B.

HEATING

			Indoor Unit	Outdoor Unit		Complete Unit
			Fan Motor	Fan Motor	Compressor	
Performance at			220 / 240V Single phase 50Hz			
Rating Conditions	Running Amps.	A	0.37 / 0.38	0.48 / 0.50	8.05 / 8.52	8.9 / 9.4
	Power Input	kW	0.070 / 0.073	0.106 / 0.119	1.654 / 1.768	1.83 / 1.96
Full Load Conditions	Running Amps.	A	0.37 / 0.38	0.48 / 0.50	10.15 / 10.32	11.0 / 11.2
	Power Input	kW	0.070 / 0.073	0.106 / 0.119	2.144 / 2.238	2.32 / 2.43

Rating Conditions : Indoor Air Temperature 20°C D.B.
 Outdoor Air Temperature 7°C D.B. / 6°C W.B.

Full Load Conditions : Indoor Air Temperature 27°C D.B.
 Outdoor Air Temperature 24°C D.B. / 18°C W.B.

Indoor Unit **SAP-K241GJH**
 Outdoor Unit **SAP-C241GH**

COOLING

			Indoor Unit	Outdoor Unit		Complete Unit
			Fan Motor	Fan Motor	Compressor	
Performance at			220 / 240V Single phase 50Hz			
Rating Conditions	Running Amps.	A	0.39 / 0.40	0.69 / 0.73	12.22 / 11.97	13.3 / 13.1
	Power Input	kW	0.075 / 0.080	0.152 / 0.174	2.553 / 2.566	2.78 / 2.82
Full Load Conditions	Running Amps.	A	0.39 / 0.40	0.69 / 0.73	15.62 / 14.77	16.7 / 15.9
	Power Input	kW	0.075 / 0.080	0.152 / 0.174	3.293 / 3.286	3.52 / 3.54

Rating Conditions : Indoor Air Temperature 27°C D.B. / 19°C W.B.
 Outdoor Air Temperature 35°C D.B.
 Full Load Conditions : Indoor Air Temperature 32°C D.B. / 23°C W.B.
 Outdoor Air Temperature 43°C D.B.

HEATING

			Indoor Unit	Outdoor Unit		Complete Unit
			Fan Motor	Fan Motor	Compressor	
Performance at			220 / 240V Single phase 50Hz			
Rating Conditions	Running Amps.	A	0.39 / 0.40	0.69 / 0.73	11.82 / 11.77	12.9 / 12.9
	Power Input	kW	0.075 / 0.080	0.152 / 0.174	2.453 / 2.526	2.68 / 2.78
Full Load Conditions	Running Amps.	A	0.39 / 0.40	0.69 / 0.73	15.72 / 15.27	16.8 / 16.4
	Power Input	kW	0.075 / 0.080	0.152 / 0.174	3.293 / 3.366	3.52 / 3.62

Rating Conditions : Indoor Air Temperature 20°C D.B.
 Outdoor Air Temperature 7°C D.B. / 6°C W.B.
 Full Load Conditions : Indoor Air Temperature 27°C D.B.
 Outdoor Air Temperature 24°C D.B. / 18°C W.B.

6-2. Electric Wiring Diagrams

Indoor Unit

SAP-K181GJH
SAP-K241GJH



WARNING

To avoid electrical shock hazard, be sure to disconnect power before checking, servicing and/or cleaning any electrical parts.

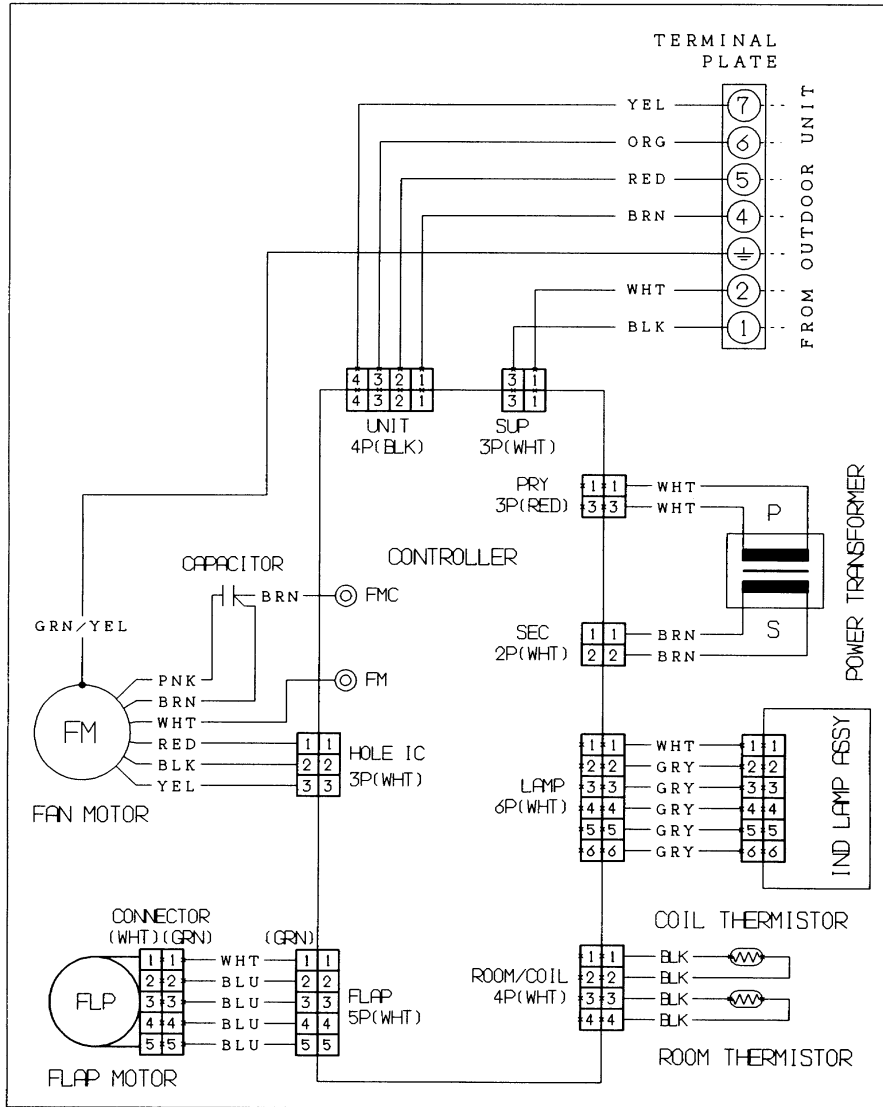

8512-5253-568XX-0



WARNING

To avoid electrical shock hazard, be sure to disconnect power before checking, servicing and/or cleaning any electrical parts.

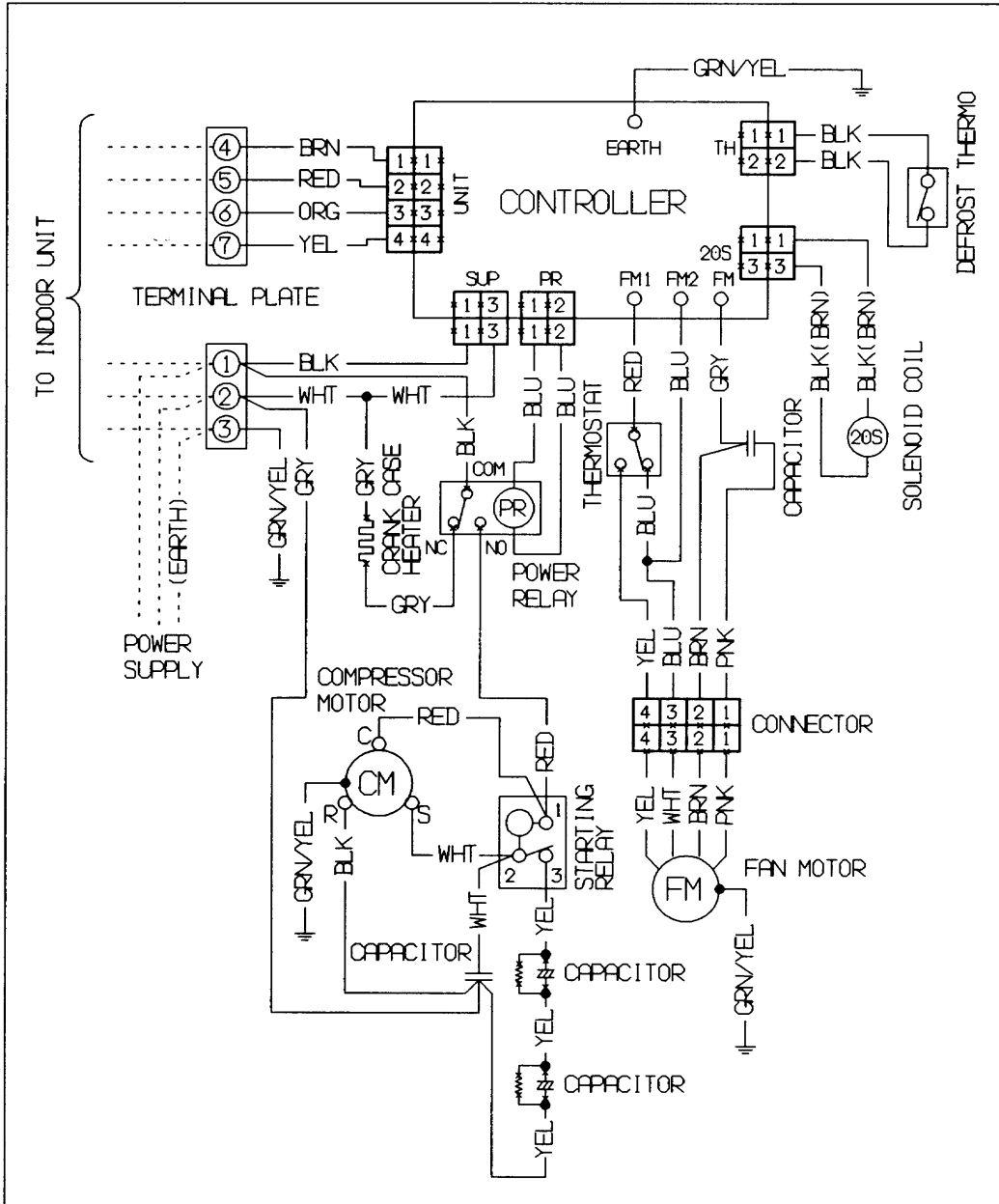

8512-5253-280XX-1



WARNING

To avoid electrical shock hazard, be sure to disconnect power before checking, servicing and/or cleaning any electrical parts.

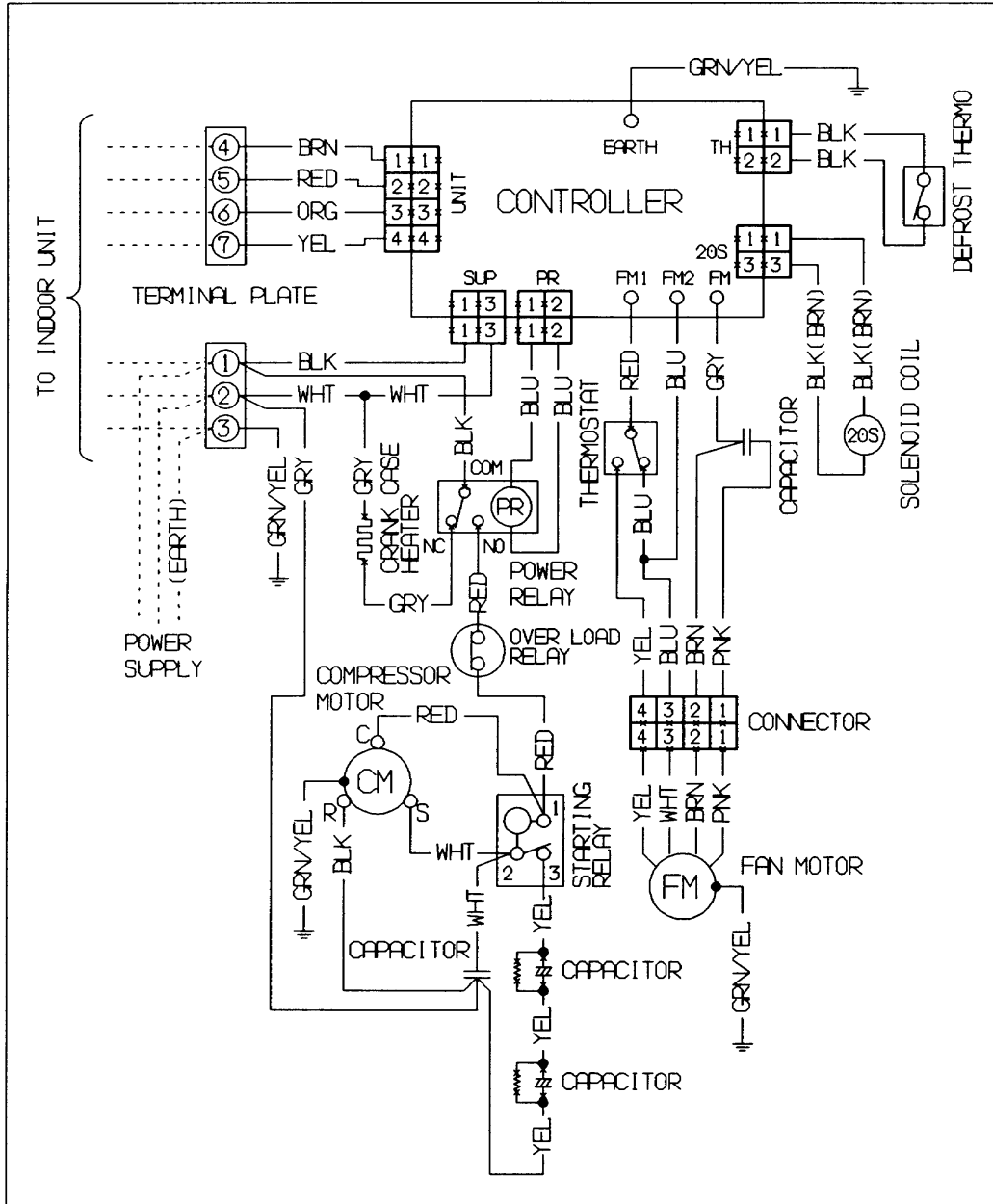

8512-5253-502XX-0

7. INSTALLATION INSTRUCTIONS

7-1. Installation Site Selection

Indoor Unit



WARNING

To prevent abnormal heat generation and the possibility of fire, don't place obstacles, enclosures and grills in front of or surrounding the air conditioner in a way that may block air flow.

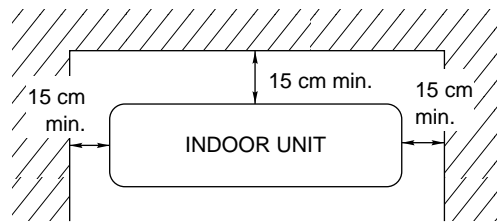

Front View
Fig.1

AVOID:

- direct sunlight.
- nearby heat sources that may affect performance of the unit.
- areas where leakage of flammable gas may be expected.
- places where large amounts of oil mist exist.

DO:

- select an appropriate position from which every corner of the room can be uniformly air-conditioned. (High on a wall is best)
- select a location that will hold the weight of the unit.
- select a location where tubing and drain pipe have the shortest run to the outside.
- allow room for operation and maintenance as well as unrestricted air flow around the unit. (Fig. 1)
- install the unit within the maximum elevation difference (H) above or below the outdoor unit and within a total tubing length (L) from the outdoor unit as detailed Table 1 and Fig. 2a.

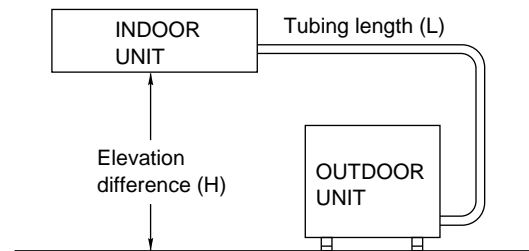

Fig. 2a



CAUTION

For stable operation of the air conditioner, do not install wall-mounted type indoor units less than 1.5m from floor level.

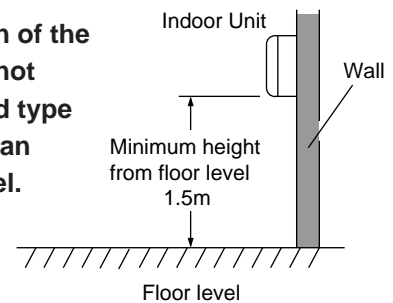

Fig. 2b

Table 1

Model	Max. Allowable Tubing Length at Shipment (m)	Limit of Tubing Length (L) (m)	Limit of Elevation Difference (H) (m)	Required Amount of Additional Refrigerant (g/m)*
C181	7.5	20	7	25
C241	10	30		

* If total tubing length becomes 7.5 to 20 m (max.) or 10 to 30 m (max.), charge additional refrigerant (R22) by 25 g/m. No additional charge of compressor oil is necessary.

Outdoor Unit

AVOID:

- heat sources, exhaust fans, etc. (Fig. 3)
- damp, humid or uneven locations.

DO:

- choose a place as cool as possible.
- choose a place that is well ventilated.
- allow enough room around the unit for air intake/exhaust and possible maintenance. (Figs. 4b and 4c)
- provide a solid base (concrete block, 10 × 40 cm beams or equal), a minimum of 10 cm above ground level to reduce humidity and protect the unit against possible water damage and decreased service life. (Fig.5b)
- use lug bolts or equal to bolt down unit, reducing vibration and noise.

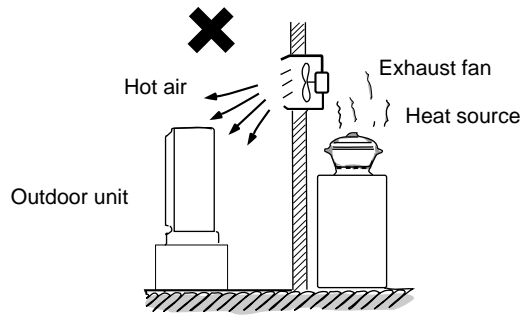
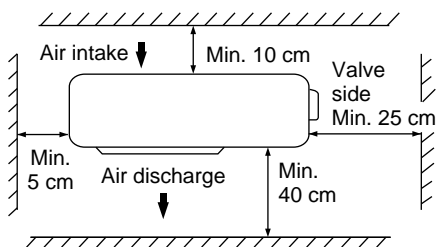

Fig. 3

Required space around the unit.



Top View

Fig. 4b

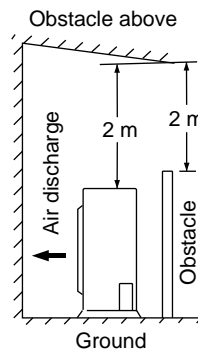

Side View

Fig. 4c

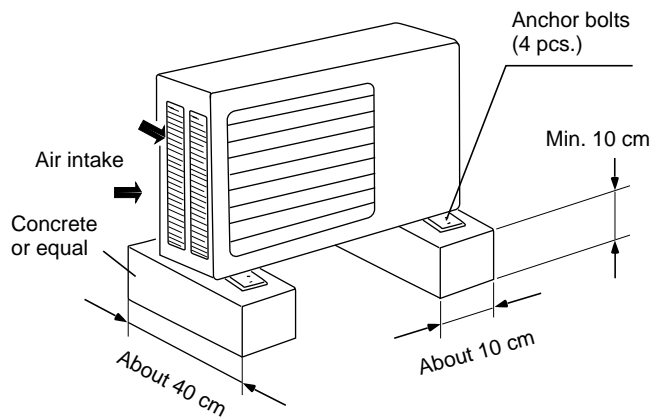

Fig. 5b

7-2. Remote Control Unit Installation Position

The remote control unit can be operated from either a non-fixed position or a wall-mounted position.

To ensure that the air conditioner operates correctly, do not install the remote control unit in the following places:

- In direct sunlight
- Behind a curtain or other place where it is covered
- More than 8 m away from the air conditioner
- In the path of the air conditioner's airstream
- Where it may become extremely hot or cold
- Where it may be subject to electrical or magnetic interference

Mounting on a Wall

a) Removable mounting

- 1) Momentarily hold the remote control unit at the desired mounting position.
- 2) Confirm that the air conditioner responds correctly when you press keys on the remote control from that position.
- 3) After confirming correct operation, use a screwdriver to screw the supplied special mounting screw into the wall. (Fig.6a)
- 4) Hang the remote control unit from the mounting screw.

b) Non-removable mounting

- 1) Momentarily hold the remote control unit at the desired mounting position.
- 2) Confirm that the air conditioner responds correctly when you press keys on the remote control from that position.
- 3) After confirming correct operation, use a screwdriver to screw the supplied special mounting screw into the wall. (Fig.6a)
- 4) Remove the remote control cover by sliding it downward.
- 5) Remove the batteries of the remote control unit.
- 6) Use a screwdriver to screw the remote control unit securing screw into the wall through the hole in the battery compartment. (Fig.6b)
- 7) Replace the batteries.
- 8) Again confirm that the remote control unit operates correctly.

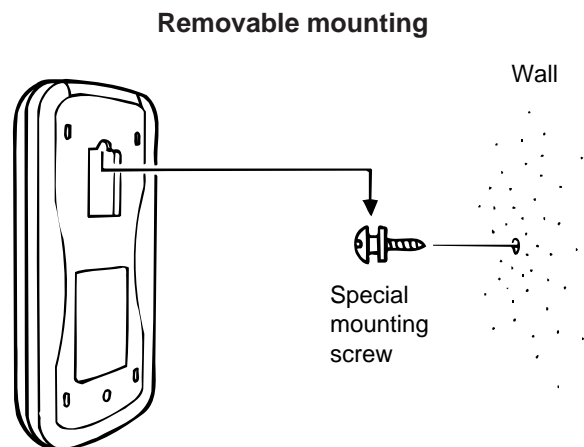

Fig.6a

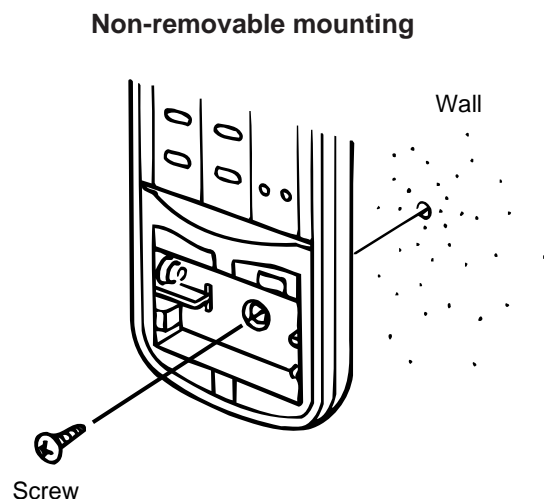

Fig.6b

7-3. Recommended Wire Length and Size

Regulations on wiring diameter differ from locality to locality. For field wiring requirements, please refer to your local electrical codes. Carefully observe these regulations when carrying out the installation.

NOTE

Refer to the WIRING SYSTEM DIAGRAM for the meaning of "A", "B" and "C" in Table 2.

Table 2 lists recommended wire lengths and cross section area for power supply systems.

Table 2

Model	Cross-Sectional Area (mm ²)	(A) Power Supply Wiring Length (m)					(B) Power Line	(C) Control Line	Fuse or Circuit Breaker Capacity
		2 (#14)	3.5 (#12)	5.5 (#10)	8 (#8)	14 (#6)	2 (#14)	0.75 (#18)	
C181		18	27	—	—	—	20	20	20 A
C241		—	16	27	41	72			30 A

... AWG (American Wire Gauge)

WIRING SYSTEM DIAGRAM

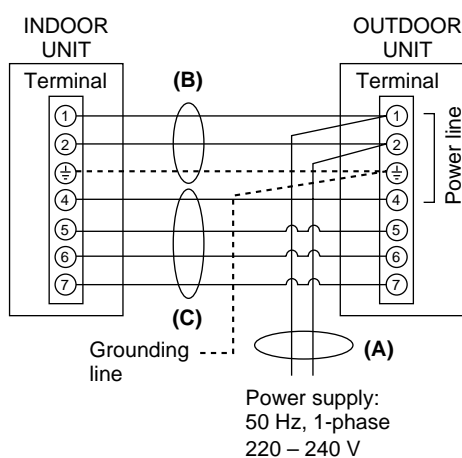

WARNING

- Be sure to comply with local codes on running the wire from the indoor unit to the outdoor unit (size of wire and wiring method, etc.).
- Each wire must be firmly connected.
- No wire should be allowed to touch refrigerant tubing, the compressor, or any moving part.



WARNING

To avoid the risk of electric shock, each air conditioner unit must be grounded.



CAUTION

- Be sure to connect the power supply line to the outdoor unit as shown in the wiring diagram. The indoor unit draws its power from the outdoor unit.

8. FUNCTION

8-1. Room Temperature Control

■ Cooling

- Room temperature control is obtained by cycling the compressor ON and OFF under control of the room temperature sensor in the remote control unit.
- The room temperature (and other information) is transmitted every 3 minutes by the remote control unit to the controller in the indoor unit.

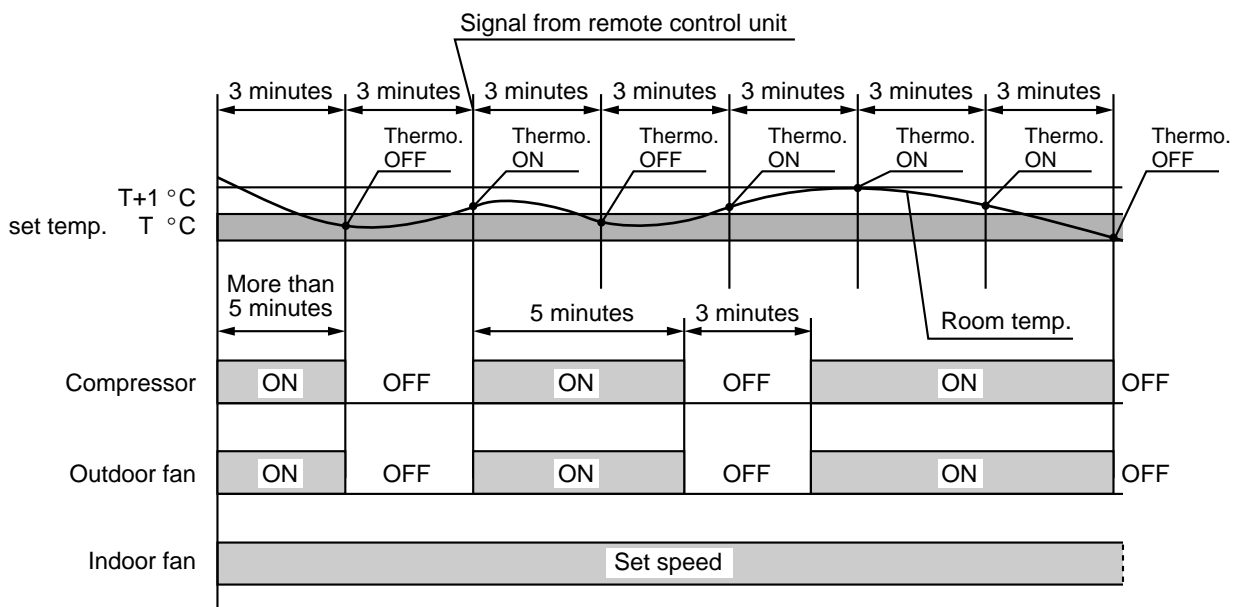

- The control circuit will not attempt to turn the compressor ON until the compressor has been OFF for at least 3 minutes. To protect the compressor from stalling out when trying to start against the high side refrigerant pressure, the control circuit has a built-in automatic time delay to allow the internal pressure to equalize.
- As a protective measure, the control circuit switches the compressor OFF after 5 minutes or more of compressor operation.
- Thermo. ON : When the room temperature is above $T + 1^{\circ}\text{C}$ ($T^{\circ}\text{C}$ is set temperature).
Compressor → ON
- Thermo. OFF : When the room temperature is equal to or below set temperature $T^{\circ}\text{C}$.
Compressor → OFF

■ Heating

- Room temperature control is obtained by cycling the compressor ON and OFF under control of the room temperature sensor in the remote control unit.
- The room temperature (and other information) is transmitted every 3 minutes by the remote control unit to the controller in the indoor unit.

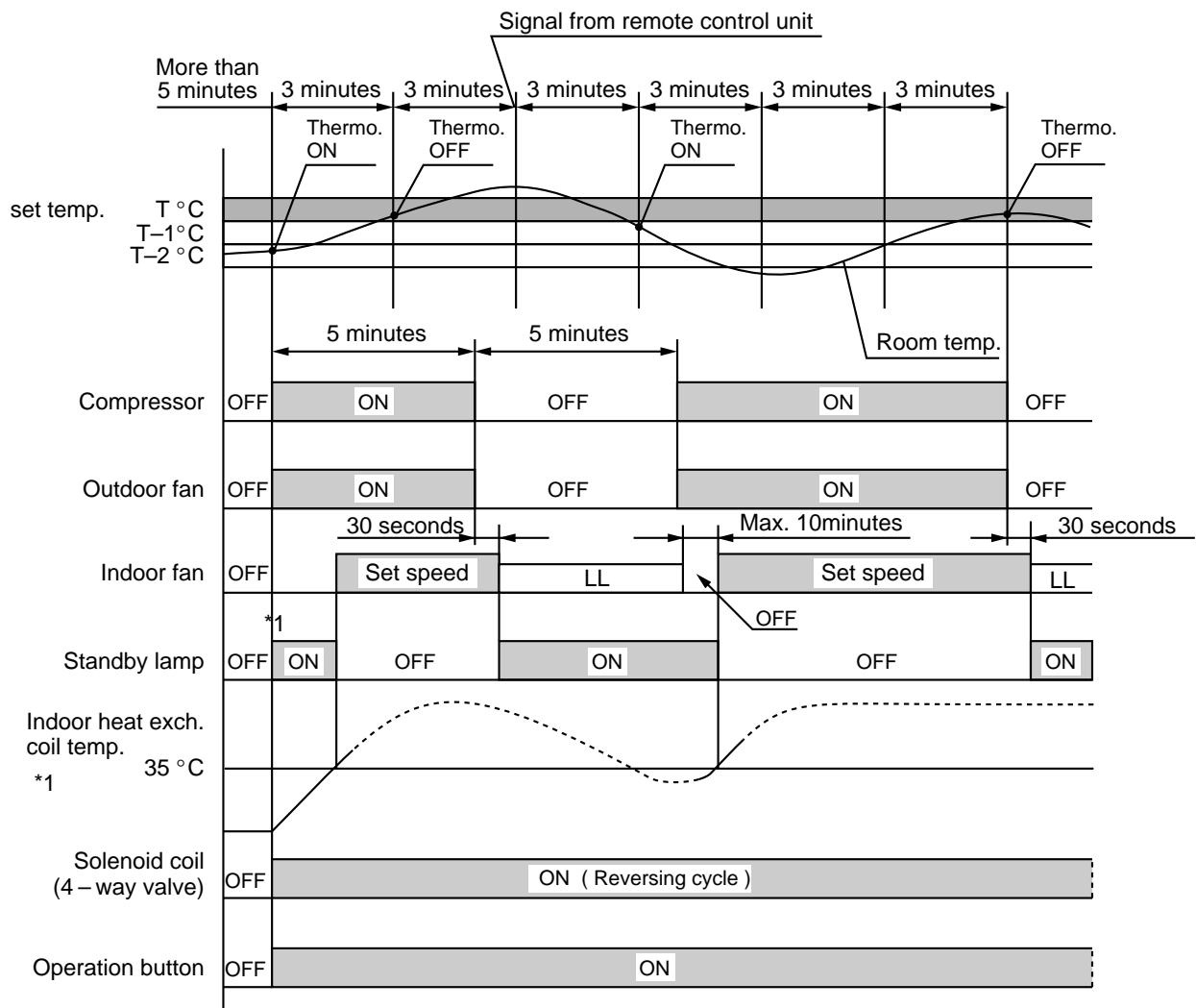

- The control circuit will not attempt to turn the compressor ON until the compressor has been OFF for at least 5 minutes. To protect the compressor from stalling out when trying to start against the high side refrigerant pressure, the control circuit has a built-in automatic time delay to allow the internal pressure to equalize.
- As a protective measure, the control circuit switches the compressor OFF after 5 minutes or more of compressor operation.
- Thermo. ON : When the room temperature is below $T - 1$ °C (T °C is set temperature).
Compressor → ON
- Thermo. OFF : When the room temperature is equal to or above set temperature T °C.
Compressor → OFF

NOTE

*1: Refer to "8-6 Cold Draft Prevention".

8-2. Dry Operation (Dehumidification)

- Dry operation uses the ability of the cooling cycle to remove moisture from the air, but by running at low level to dehumidify without greatly reducing the room temperature. The air conditioner repeats the cycle of turning ON and OFF automatically as shown in the chart below according to the room temperature.

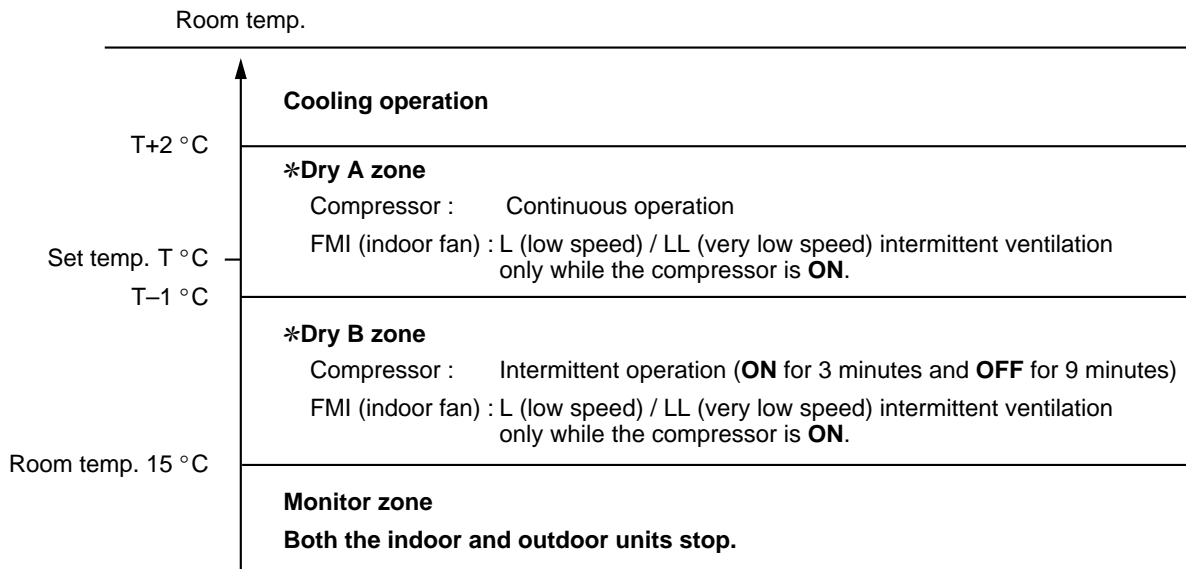

NOTE

- Intermittent ventilation occurs by switching the indoor fan speed between L ↔ LL.
- Dry operation does not occur when the room temperature is under 15°C, which is the monitor zone.
- When the compressor stops, the indoor fan stops as well.

8-3. Automatic Switching between Cooling and Heating

- When AUTO mode is selected, the microprocessor calculates the difference between the set temperature and the room temperature, and automatically switches to COOLING or HEATING mode to maintain the desired temperature.

Room temp. \geq Set temp. → COOL

Room temp. $<$ Set temp. → HEAT

This means that if the room temperature is **higher than** or **equal to** the set temperature, **COOLING** operation begins. If the room temperature is **lower than** the set temperature, **HEATING** operation begins.

8-4. Freeze Prevention (Cooling)

- This function prevents freezing of the indoor heat exchange coil.
- When the compressor has been running for 10 minutes or more and the temperature of the indoor heat exchange coil falls below -1°C , the control circuit stops the compressor for at least 6 minutes. The compressor does not start again until the temperature rises above 8°C or 6 minutes has elapsed.

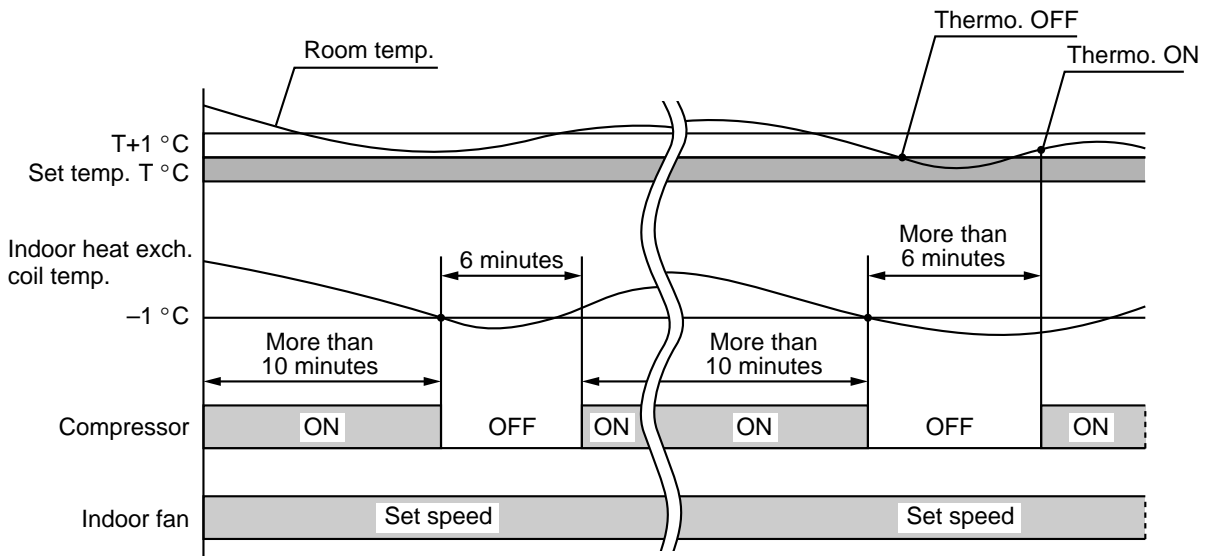

8-5. Overload Prevention (Heating)

- This function prevents overheating of the indoor heat exchange coil.
- When the temperature of the indoor heat exchange coil rises above 59°C , and if the indoor fan is L (low speed), then the fan speed changes from L (low speed) to M (medium speed).
- When the temperature of the indoor heat exchange coil rises above 61°C , the outdoor fan stops.

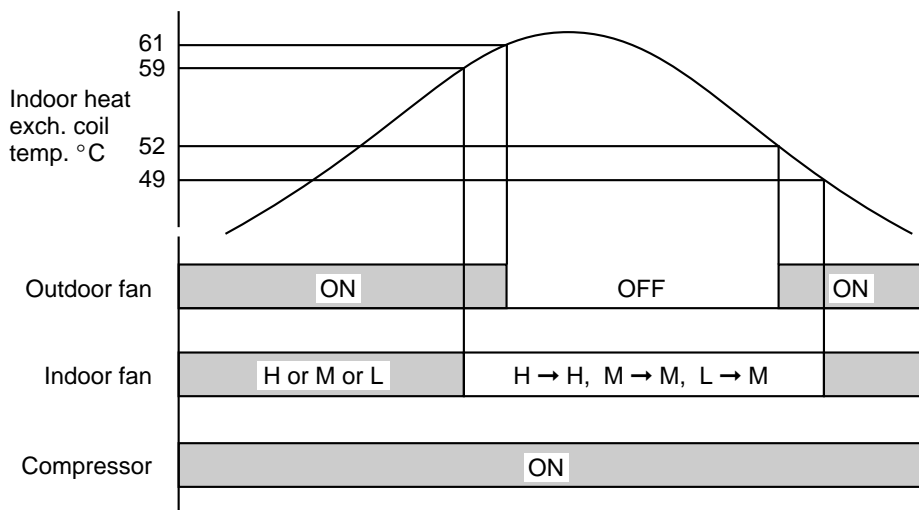

8-6. Cold draft Prevention (Heating)

- This function controls indoor fan speed so a strong draft of cold air will not blow out before the indoor heat exchange coil have sufficiently warmed up.
- STANDBY lamp on front of the indoor unit lights up when this function is working.
- when 10 minutes has elapsed, the fan speed is automatically switched to set speed regardless of indoor heat exchange coil temperature.

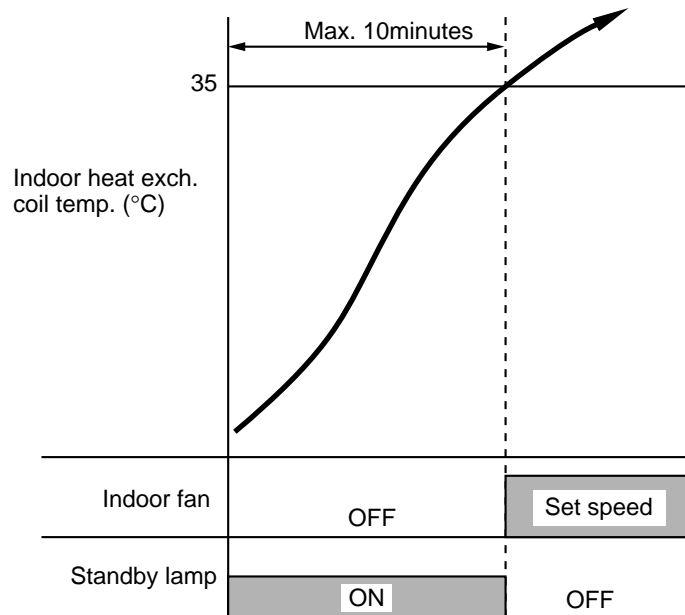

8-7. Defrosting Operation (Heating)

■ Defrosting Flowchart

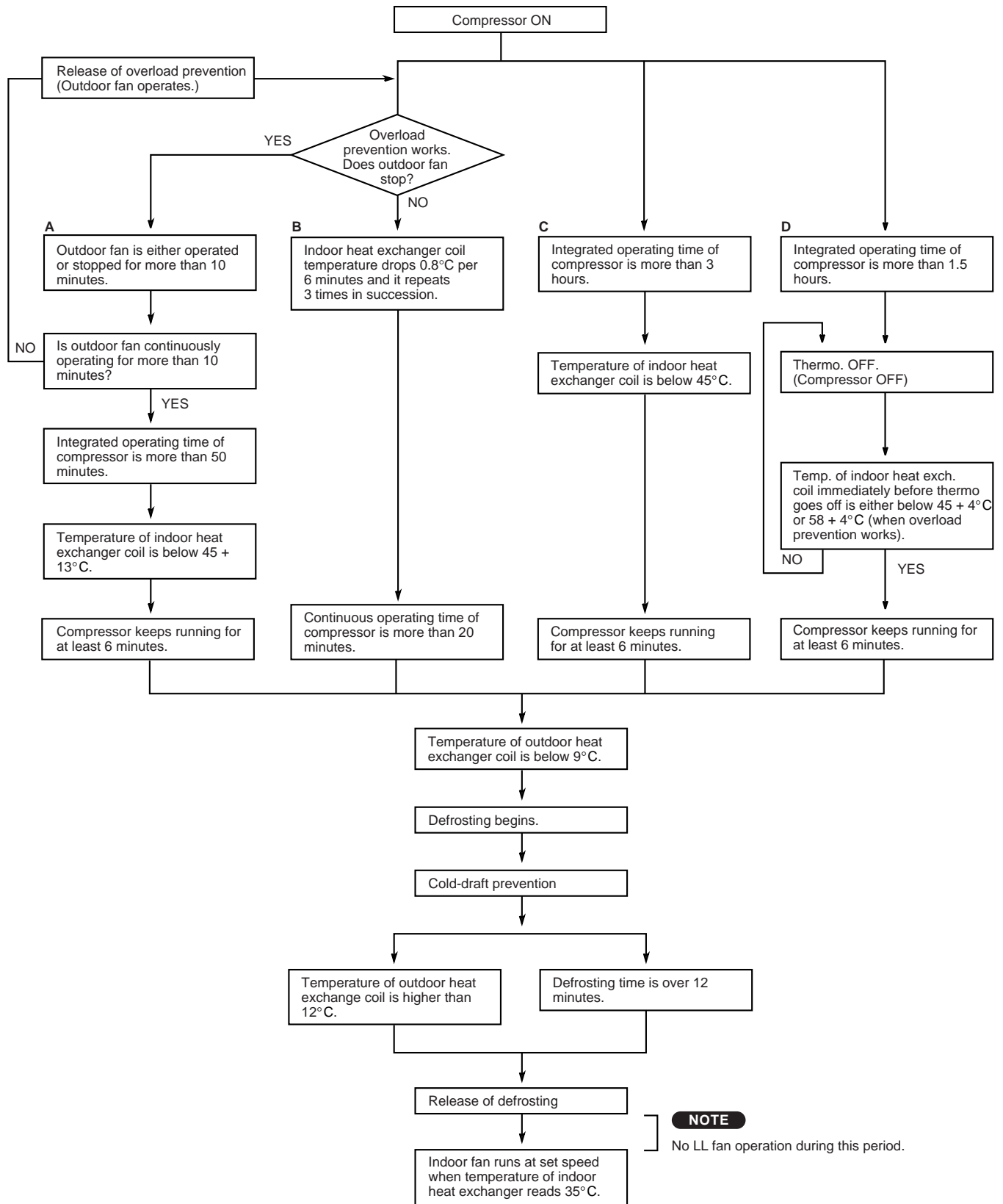

■ Defrosting Mode Timing Chart

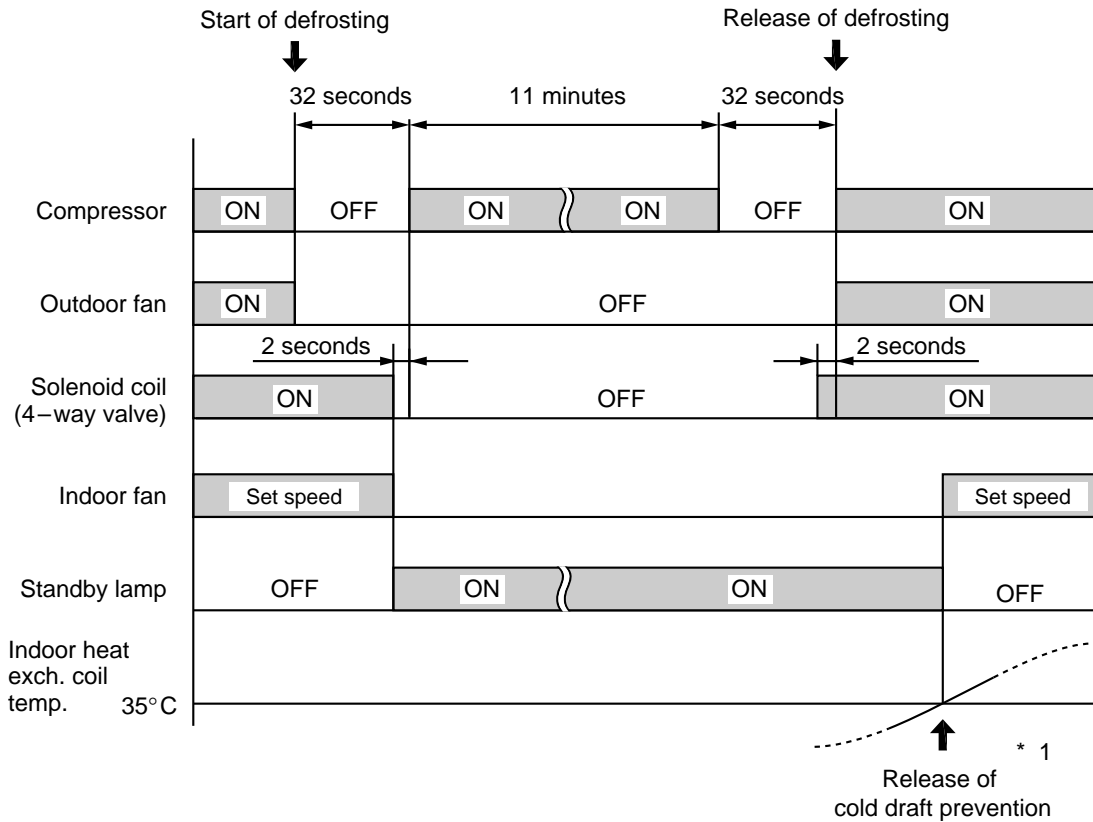

NOTE

*1: Refer to "8-6 Cold Draft Prevention".

8-8. Outdoor Fan Speed Control (Cooling and Dry Operation)

- To optimize performance of the air conditioner, the outdoor fan speed is switched automatically according to the outdoor temperature.
- If the outdoor air temperature falls below 28.5°C, the fan speed switches to LOW.
- If the outdoor air temperature rises above 31.5°C, the fan speed switches to HIGH.
- This function does not become active in heating operation.

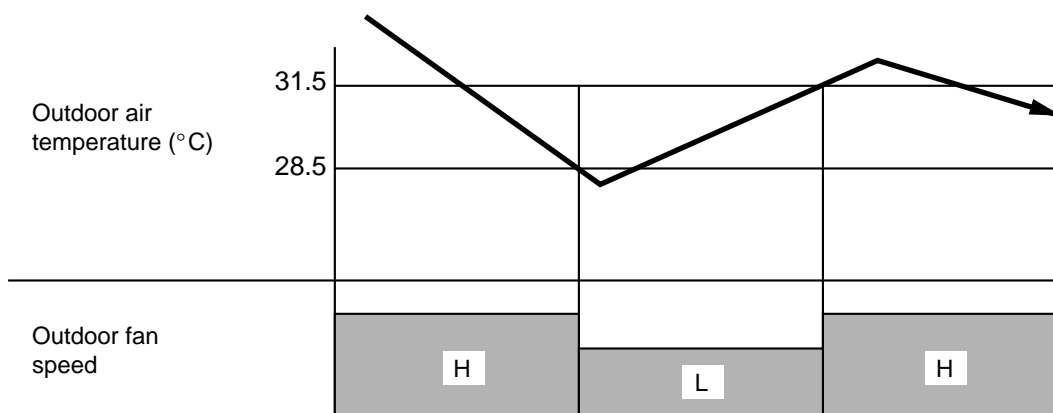

9. TROUBLESHOOTING

9-1. Check before and after troubleshooting



WARNING

Hazardous voltage can cause **ELECTRIC SHOCK** or **DEATH**. Disconnect power or turn off circuit breaker before you start checking or servicing.

9-1-1. Check power supply wiring.

- Check that power supply wires are correctly connected to terminals **No. 1** and **No. 2** on the terminal plate in the outdoor unit.

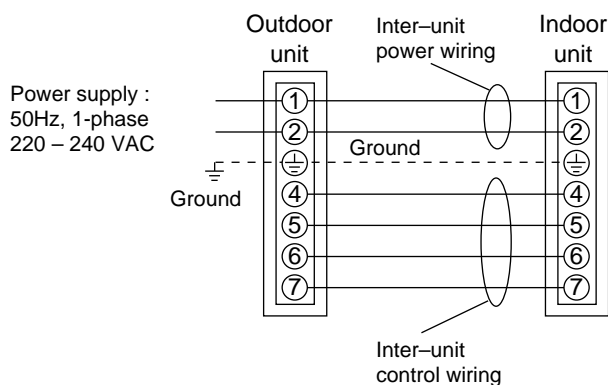

9-1-2. Check inter-unit wiring.

- Check that inter-unit wiring is correctly connected to the indoor unit from the outdoor unit.

9-1-3. Check power supply.

- Check that voltage is in specified range ($\pm 10\%$ of the rating).
- Check that power is being supplied.

9-1-4. Check lead wires and connectors in indoor and outdoor units.

- Check that coating of lead wires is not damaged.
- Check that lead wires and connectors are firmly connected.
- Check that wiring is correct.

9-2. Air conditioner does not operate.

9-2-1. Circuit breaker trips (or fuse blows).

A. When the circuit breaker is set to ON, it is tripped soon. (Resetting is not possible.)

- There is a possibility of ground fault.
- Check insulation resistance.

If resistance value is $2M\Omega$ or less, insulation is defective ("NO").

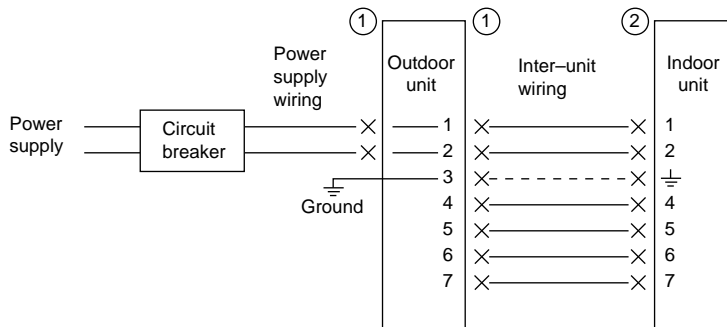

WARNING

* Set circuit breaker to OFF.

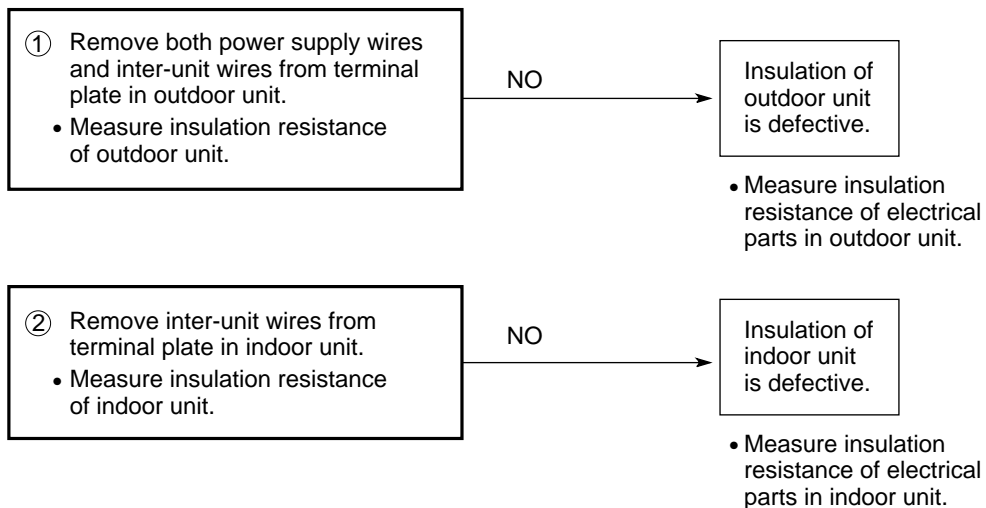

B. Circuit breaker trips in several minutes after turning the air conditioner on.

- There is a possibility of short circuit.

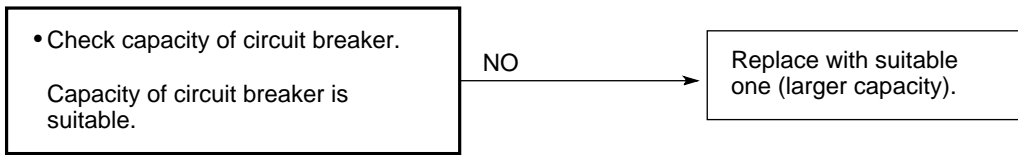

In case of Heating operation :

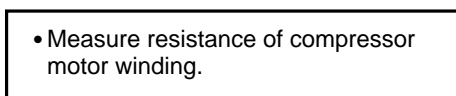
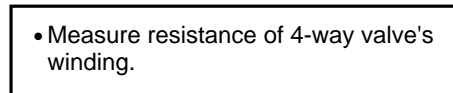
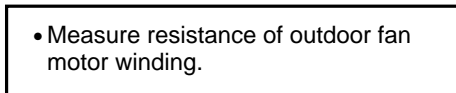

9-2-2. Neither indoor nor outdoor unit runs.

A. Power is not supplied.

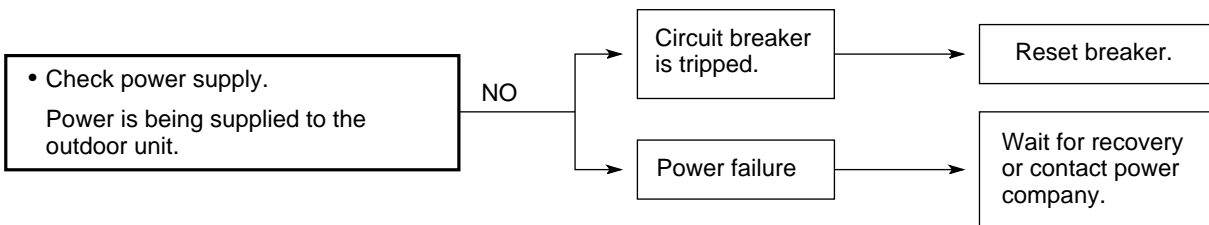

B. Check "OPERATION selector" switch in the indoor unit.

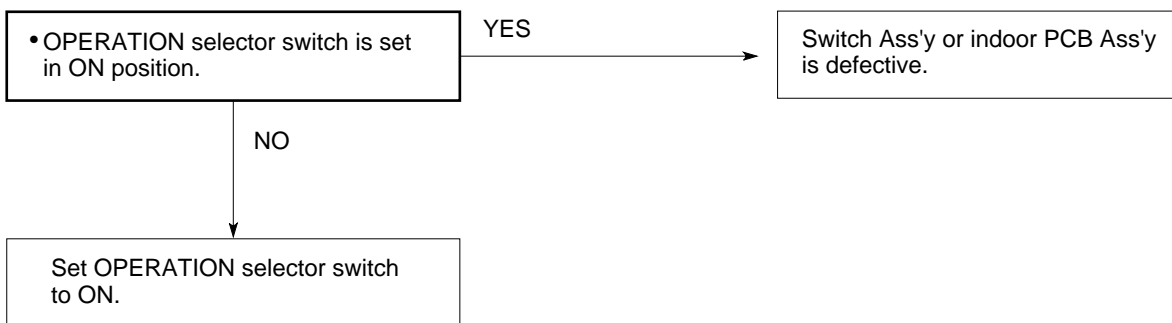

C. Check remote control unit.

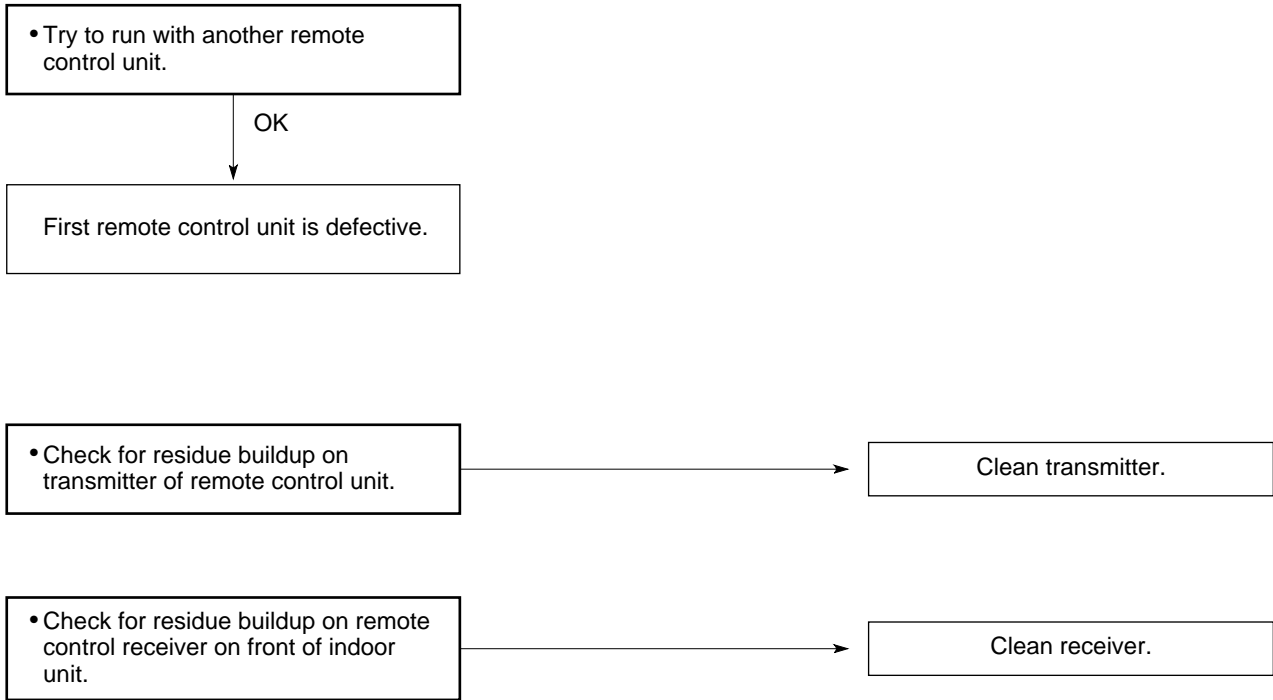

D. Check fuse on the indoor PCB Ass'y.

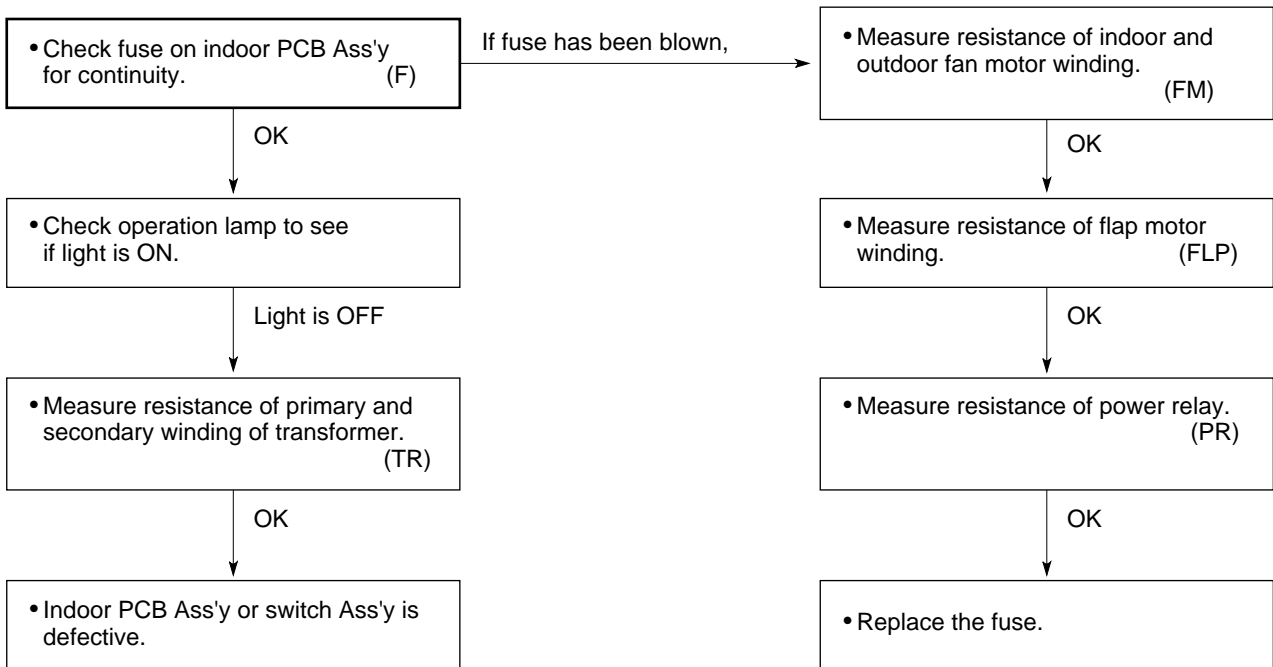

E. Check TIMER on the remote control unit.



9-2-3. Only outdoor unit does not run.

A. Check setting temperature.

COOL

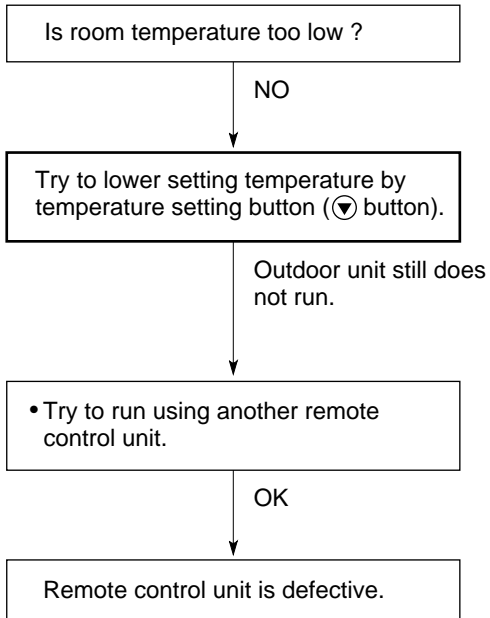

HEAT

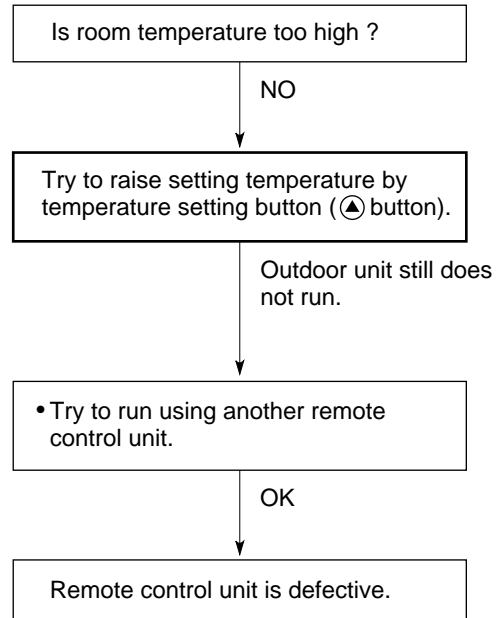

B. Check PCB Ass'y in either indoor or outdoor unit.

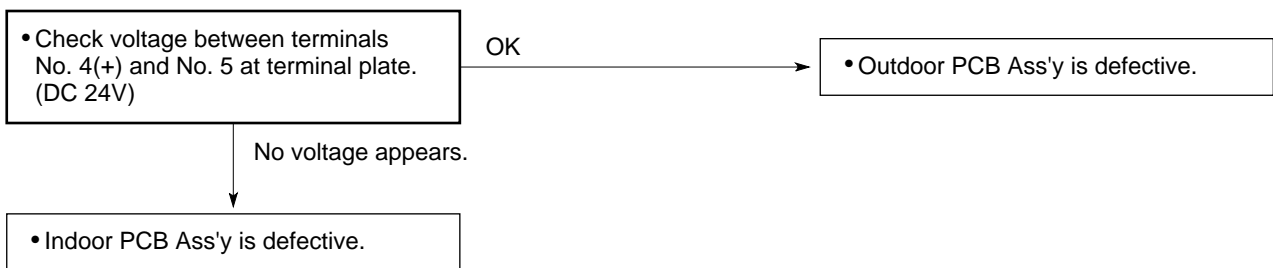

9-2-4. Only indoor unit does not run.

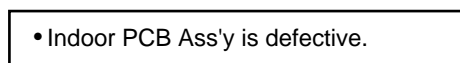

9-3. Some part of air conditioner does not operate.

9-3-1. Only indoor fan does not run.

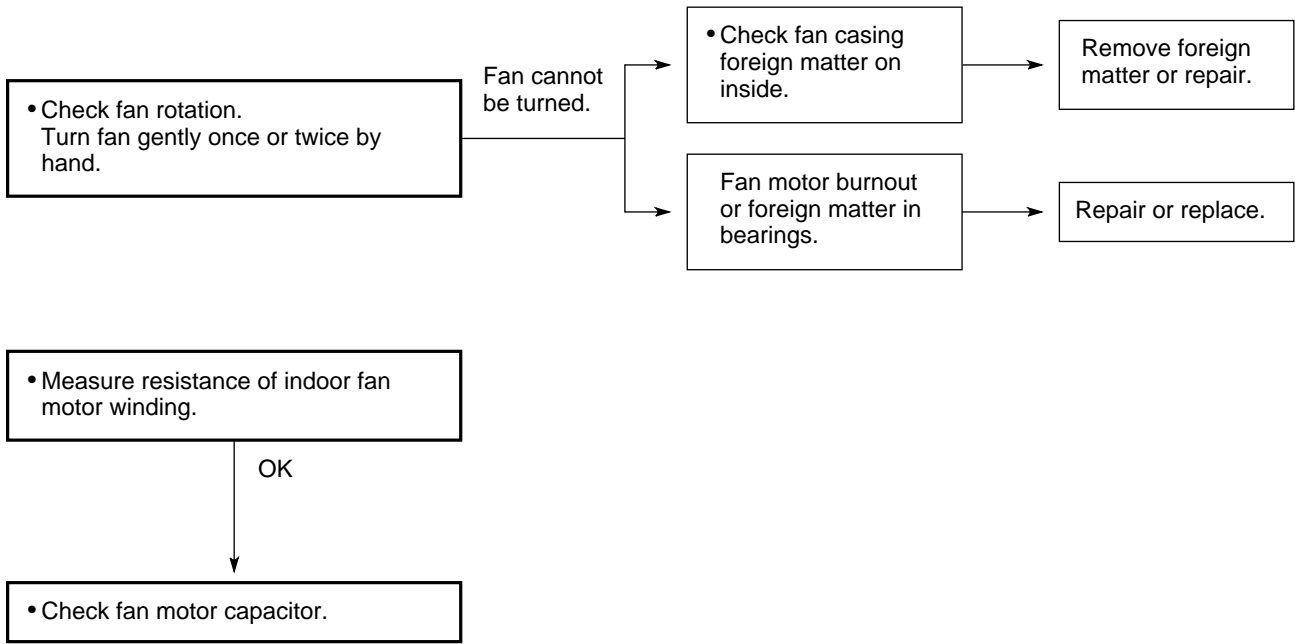

9-3-2. Only flap motor does not run.

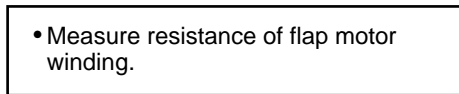

9-3-3. Function of outdoor fan speed control does not work properly.

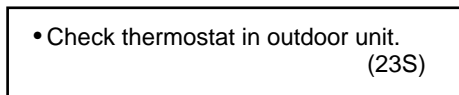

Refer to "8-8 Outdoor Fan Speed Control".

9-3-4. Only outdoor fan does not run.

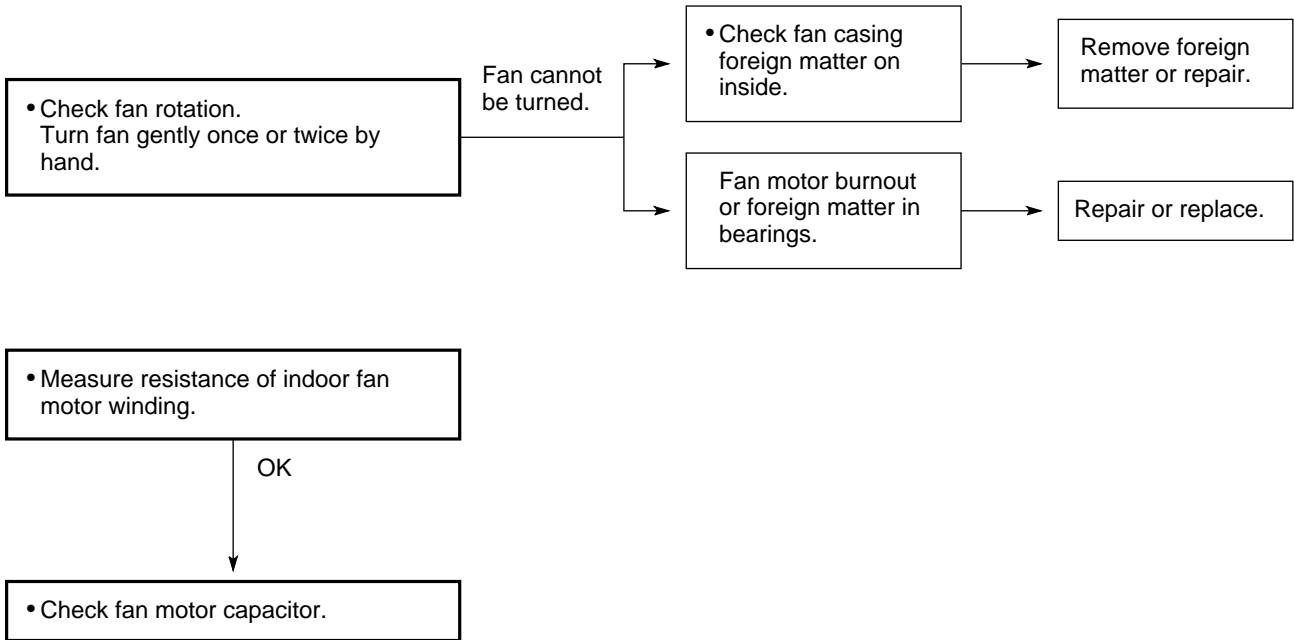

9-3-5. Only compressor does not run.

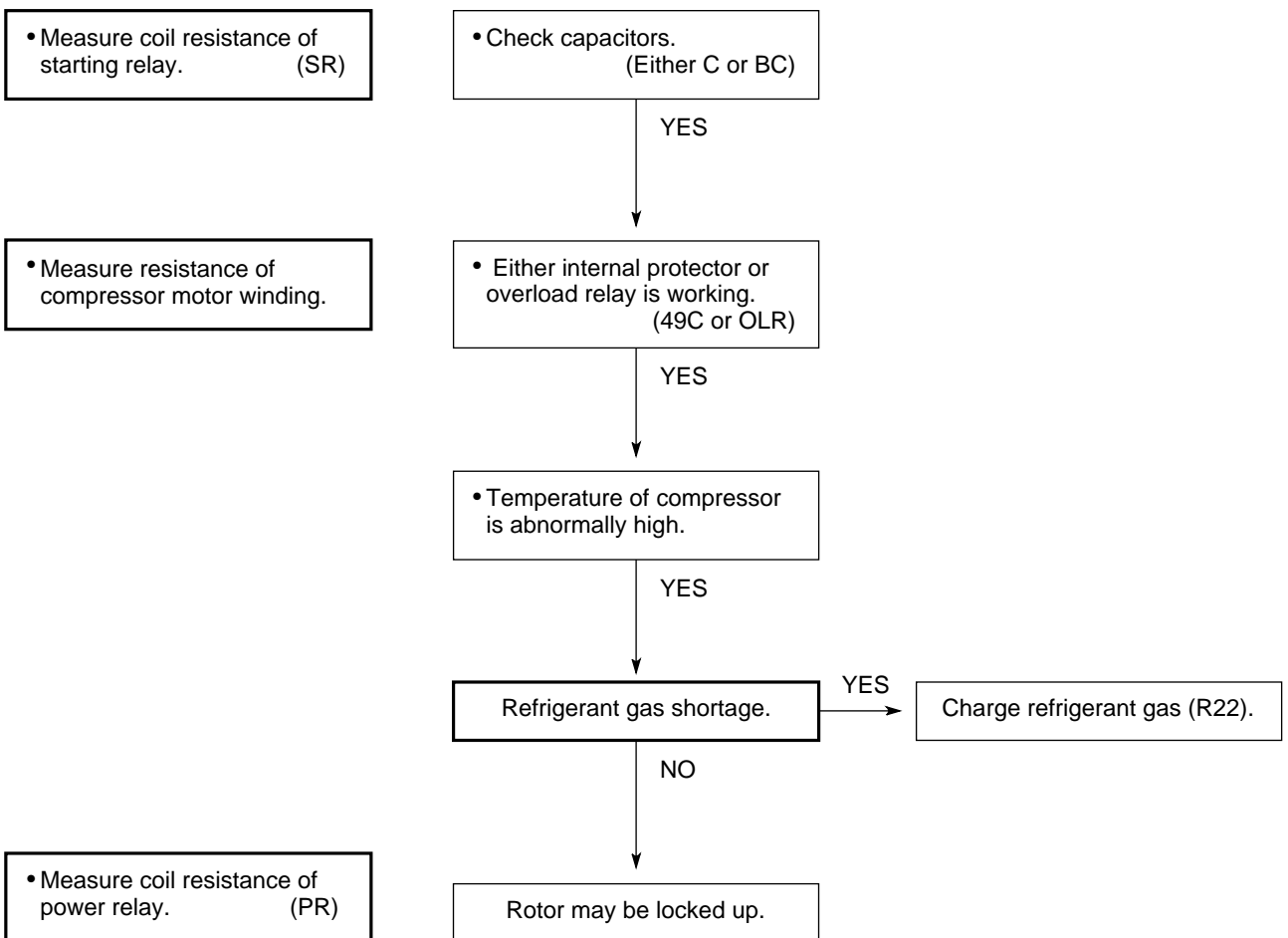

9-4. Air conditioner operates, but abnormalities are observed.

9-4-1. Operation does not switch from HEAT to COOL (or COOL to HEAT).

• Remote control unit may be defective.

Receiver in switch Ass'y may be defective.

• Measure resistance of 4-way valve's winding.

COOL → HEAT

• Check voltage between terminals No. 4(+) and No. 6 at terminal plate. (DC 24V)

OK

Outdoor PCB Ass'y is defective.

No voltage appears.

• Indoor PCB Ass'y is defective.

HEAT → COOL

• Check voltage between terminals No. 4(+) and No. 6 at terminal plate. (0V)

9-4-2. Poor cooling or heating.

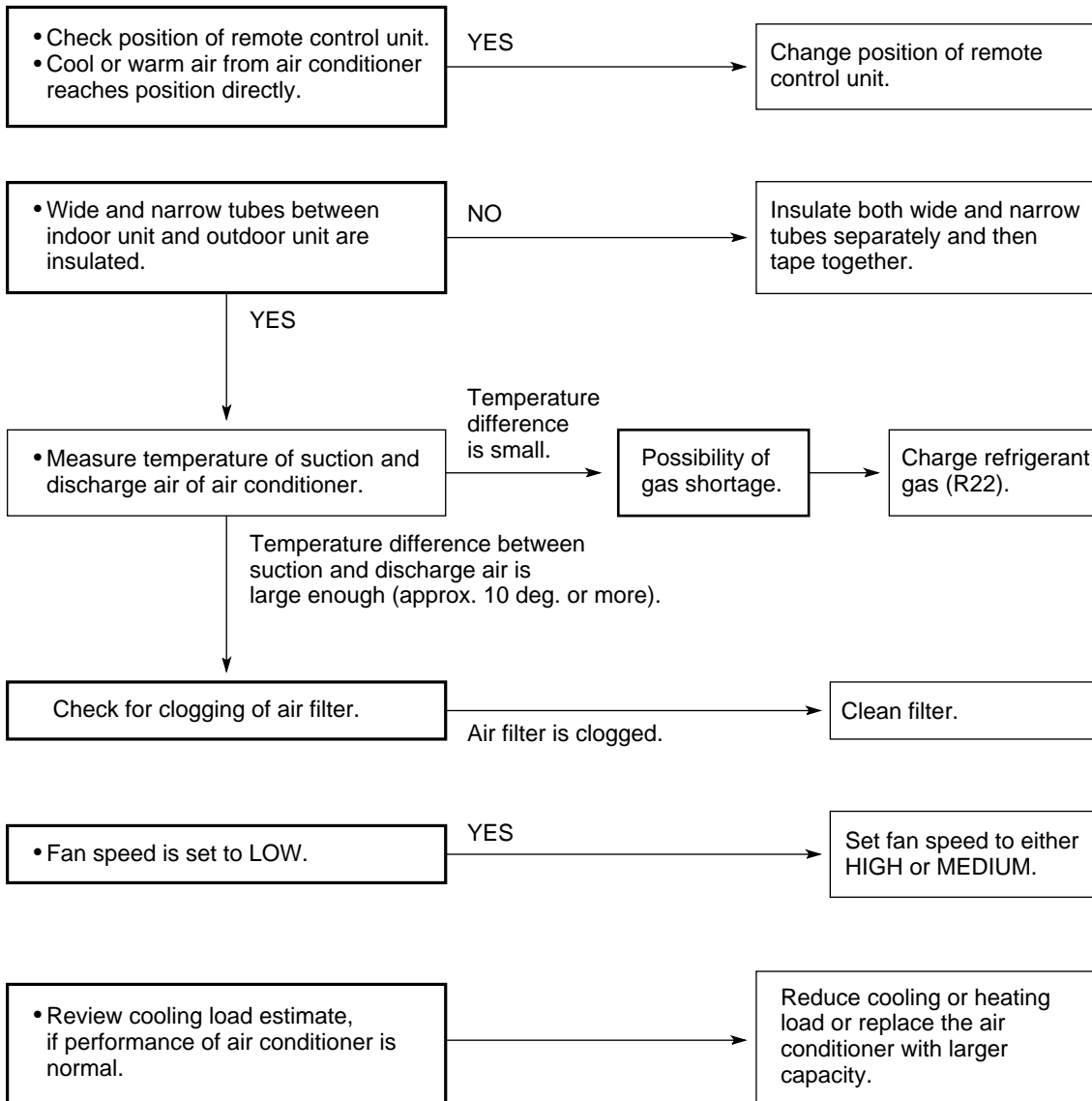

9-4-3. Excessive cooling or heating.

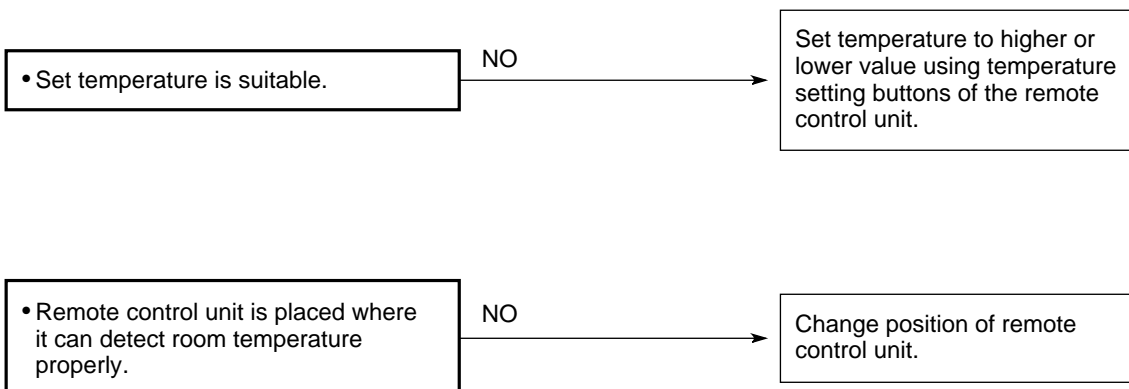

9-5. If a sensor is defective.

9-5-1. Indoor coil temp. thermistor (TH1) is defective.

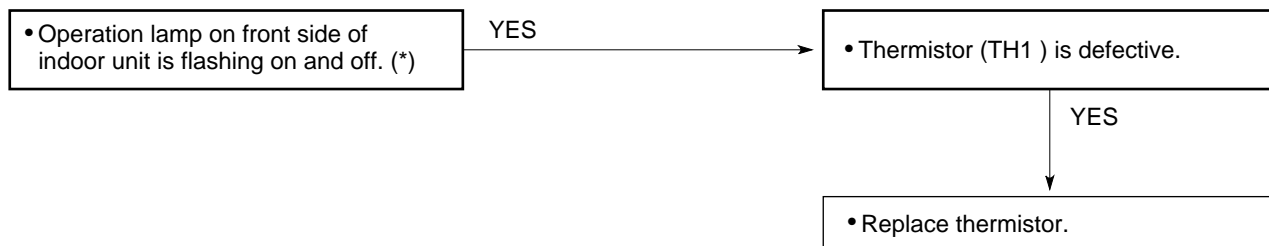

NOTE Alarm Signal (*)

Operation lamp on the front side of the indoor unit will flash on and off when the indoor coil thermistor is defective. At the same time the outdoor unit will stop. Indoor unit will operate only for ventilation.

9-5-2. Room temp. thermistor (TH2) is defective.

A. Open

When thermistor opens, the air conditioner will be in the following conditions as the controller tries to detect extremely low room temperature.

- a) In Cooling mode: The air conditioner soon stops and will not start again. (Thermo.OFF) Neither outdoor fan nor compressor runs.
- b) In Heating mode: The air conditioner continues to operate (Thermo.ON). Both the outdoor fan and compressor do not stop. As a result, the room becomes too warm.

B. Short

When thermistor is short, the air conditioner will be in the following conditions as the controller tries to detect extremely high room temperature.

- a) In Cooling mode: The air conditioner continues to operate (Thermo.ON). Both the outdoor fan and compressor do not stop. As a result, the room becomes too cold.
- b) In Heating mode: The air conditioner soon stops and will not start again (Thermo.OFF). Neither outdoor fan nor compressor runs.

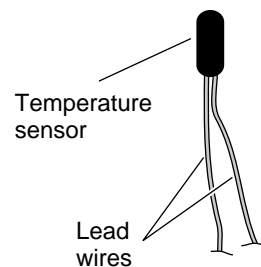

Thermistor Structure

NOTE

Definition of Open or Short Circuit of Sensor (Thermistor)

Open ... A lead wire is broken or disconnected or the circuit inside the temperature sensor is open .

Short ... The protective cover of a lead wire has been damaged, and the exposed wire is touching another metal part, or both lead wires have become exposed and are touching each other. Alternatively, the circuit inside the temperature sensor is closed.

10. CHECKING ELECTRICAL COMPONENTS

10-1. Measurement of Insulation Resistance

- The insulation is in good condition if the resistance exceeds $2M\Omega$.

10-1-1. Power Supply Wires

Clamp the ground wire of the power supply wires with the lead clip of the insulation resistance tester and measure the resistance by placing a probe on either of the power wires. (Fig. 1)

Then measure the resistance between the ground wire and the other power wire. (Fig. 1)

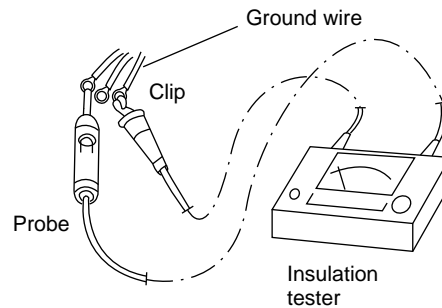

Fig. 1

10-1-2. Indoor Unit

Clamp an aluminum plate fin or copper tube with the lead clip of the insulation resistance tester and measure the resistance by placing a probe on each terminal screw on the terminal plate. (Fig. 2)

Note that the ground line terminal should be skipped for the check.

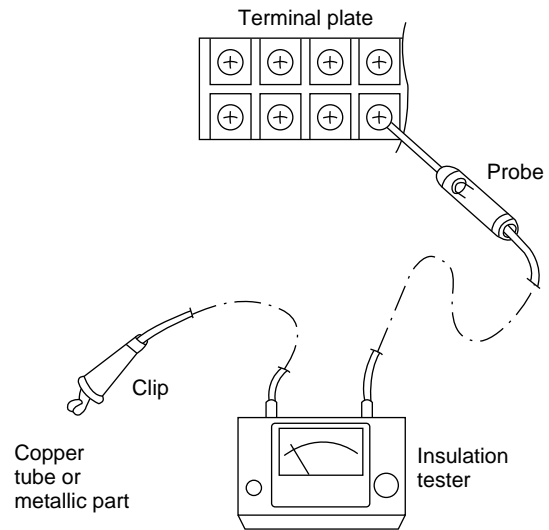

Fig. 2

10-1-3. Outdoor Unit

Clamp a metallic part of the unit with the lead clip of the insulation resistance tester and measure the resistance by placing a probe on each terminal screw where power supply lines are connected on the terminal plate. (Fig. 2)

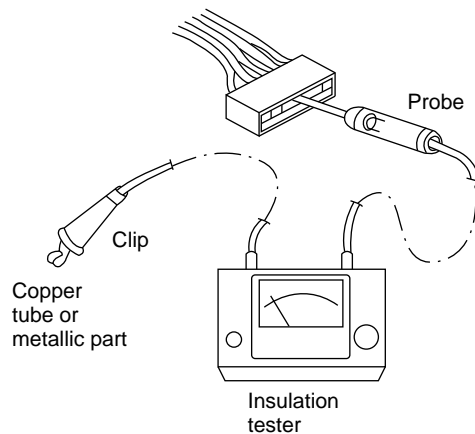

Fig. 3

10-1-4. Measurement of Insulation Resistance for Electrical Parts

Disconnect the lead wires of the desired electric part from terminal plate, capacitor, etc. Similarly disconnect the connector. Then measure the insulation resistance. (Figs. 3 and 4)

NOTE

Refer to Electric Wiring Diagram.

If the probe cannot enter the poles because the hole is too narrow then use a probe with a thinner pin.

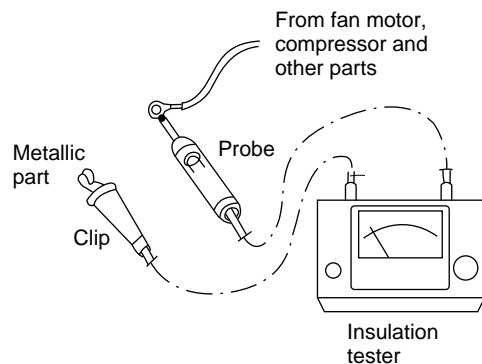

Fig. 4

10-2. Checking Continuity of Fuse on PCB Ass'y

- Remove the PCB Ass'y from the electrical component box. Then pull out the fuse from the PCB Ass'y. (Fig. 5)
- Check for continuity using a multimeter as shown in Fig. 6.

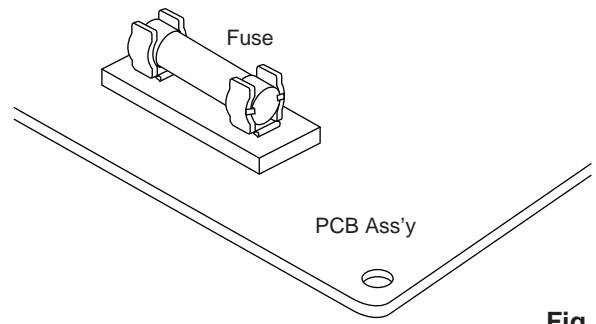

Fig. 5

10-3. Checking Motor Capacitor

Remove the lead wires from the capacitor terminals, and then place a probe on the capacitor terminals as shown in Fig. 7. Observe the deflection of the pointer, setting the resistance measuring range of the multimeter to the maximum value.

The capacitor is “good” if the pointer bounces to a great extent and then gradually returns to its original position.

The range of deflection and deflection time differ according to the capacity of the capacitor.

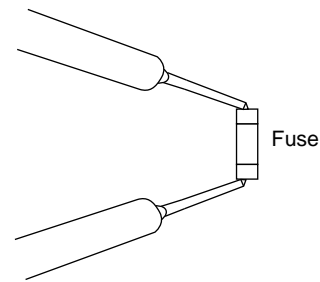

Fig. 6

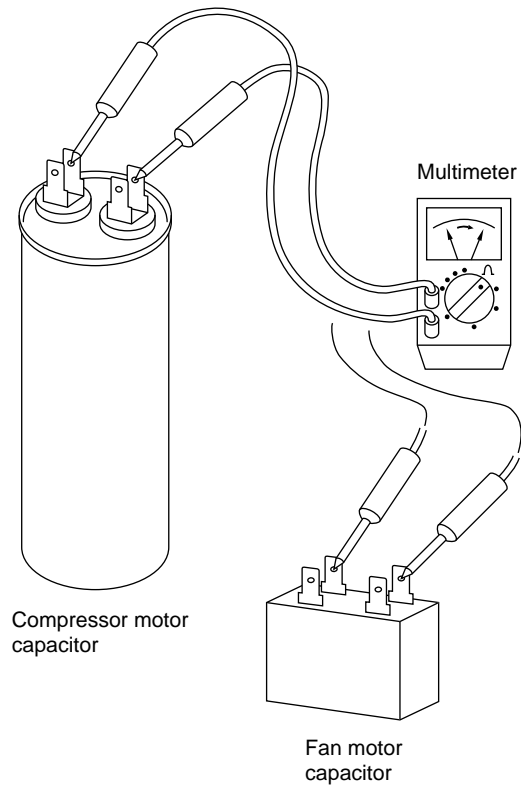

Fig. 7

APPENDIX INSTRUCTION MANUAL

SAP-K181GJH + SAP-C181GH
SAP-K241GJH + SAP-C241GH

Features

This air conditioner is equipped with cooling, heating and drying functions. Details on these functions are provided below; refer to these descriptions when using the air conditioner.

- **Compact Size**
This model is smaller than its predecessors and yet offers the same capabilities.
- **Microprocessor Controlled Operation**
The interior compartment of the remote control unit contains several features to facilitate automatic operation, easy logically displayed for easy use.
- **Simple One-touch Wireless Remote Control**
The remote control unit has several features to facilitate automatic operation.
- **12-Hour ON or OFF Timer**
This timer can be set to automatically turn the unit on or off at any time within a 12 hour period.
- **1-Hour OFF Timer**
This timer can be set to automatically turn off the unit at any time after one hour.
- **Night Setback**
Pressing this button changes the setting of the room temperature thermostat, allowing you to set the temperature at whatever level that you find comfortable.
- **Automatic and 3-step Fan Speed**
Auto/High/Medium/Low
- **Air Sweep Control**
This function moves a flap up and down in the air outlet, directing air in a sweeping motion around the room and providing comfort in every corner.
- **Automatic Switching between Cooling and Heating**
This unit automatically switches between cooling operation and heating operation according to the difference between the room temperature and the temperature setting.
- **Hot Start Heating System**
Right from the start, the air is warm and comfortable. This system prevents any cold blasts at the beginning while the heat pump is warming up, or even defrosting.
- **Automatic Restart Function for Power Failure**
Even when power failure occurs, preset programmed operation can be reactivated once power resumes.
- **Anti-Mold Filter**
This unit is equipped with an anti-mold filter that inhibits the growth of mold and bacteria.
- **Optional Air Clean Filter**
An air filter that uses activated charcoal to eliminate unpleasant odors and clean the air is available (sold separately).

Contents

	Page
Features.....	2
Product Information.....	3
Alert Symbols.....	3
Installation Location.....	4
Electrical Requirements.....	4
Safety Instructions	4
Names of Parts.....	5
Using the Remote Control Unit.....	10
Operation with the Remote Control Unit	12
1. Automatic Operation	12
2. Manual Operation	13
3. Adjusting the Fan Speed.....	14
4. Night Setback Mode	15
Special Remarks	17
Using the 12-Hour ON and OFF Timer	18
Using the 1-Hour OFF Timer.....	20
Adjusting the Airflow Direction	21
Operation without the Remote Control Unit.....	22
Care and Cleaning.....	22
Troubleshooting	25
Tips for Energy Saving	25

EG

Product Information

If you have problems or questions concerning your Air Conditioner, you will need the following information. Model and serial numbers are on the nameplate on the bottom of the cabinet.

Model No. _____ Serial No. _____

Date of purchase _____

Dealer's address _____

Phone number _____

Alert Symbols

The following symbols used in this manual, alert you to potentially dangerous conditions to users, service personnel or the appliance:



WARNING

This symbol refers to a hazard or unsafe practice which can result in severe personal injury or death.



CAUTION

This symbol refers to a hazard or unsafe practice which can result in personal injury or product or property damage.

Installation Location

- We recommend that this air conditioner be installed properly by qualified installation technicians in accordance with the Installation Instructions provided with the unit.
- Before installation, check that the voltage of the electric supply in your home or office is the same as the voltage shown on the nameplate.



WARNING

- Do not install this air conditioner where there are fumes or flammable gases, or in an extremely humid space such as a greenhouse.
- Do not install the air conditioner where excessively high heat-generating objects are placed.

Avoid: To protect the air conditioner from heavy corrosion, avoid installing the outdoor unit where salty sea water can splash directly onto it or in sulphurous air near a spa.

Electrical Requirements

1. All wiring must conform to the local electrical codes. Consult your dealer or a qualified electrician for details.
 2. Each unit must be properly grounded with a ground (or earth) wire or through the supply wiring.
 3. Wiring must be done by a qualified electrician.
-

Safety Instructions

- Read this Instruction Manual carefully before using this air conditioner. If you still have any difficulties or problems, consult your dealer for help.
- This air conditioner is designed to give you comfortable room conditions. Use this only for its intended purpose as described in this Instruction Manual.



WARNING

- Never use or store gasoline or other flammable vapor or liquid near the air conditioner — it is very dangerous.
- This air conditioner has no ventilator for intaking fresh air from outdoors. You must open doors or windows frequently when you use gas or oil heating appliances in the same room, which consume a lot of oxygen from the air. Otherwise there is a risk of suffocation in an extreme case.



CAUTION

- Do not turn the air conditioner on and off from the power mains switch. Use the ON/OFF operation button.
- Do not stick anything into the air outlet of the outdoor unit. This is dangerous because the fan is rotating at high speed.
- Do not let children play with the air conditioner.
- Do not cool or heat the room too much if babies or invalids are present.

Names of Parts

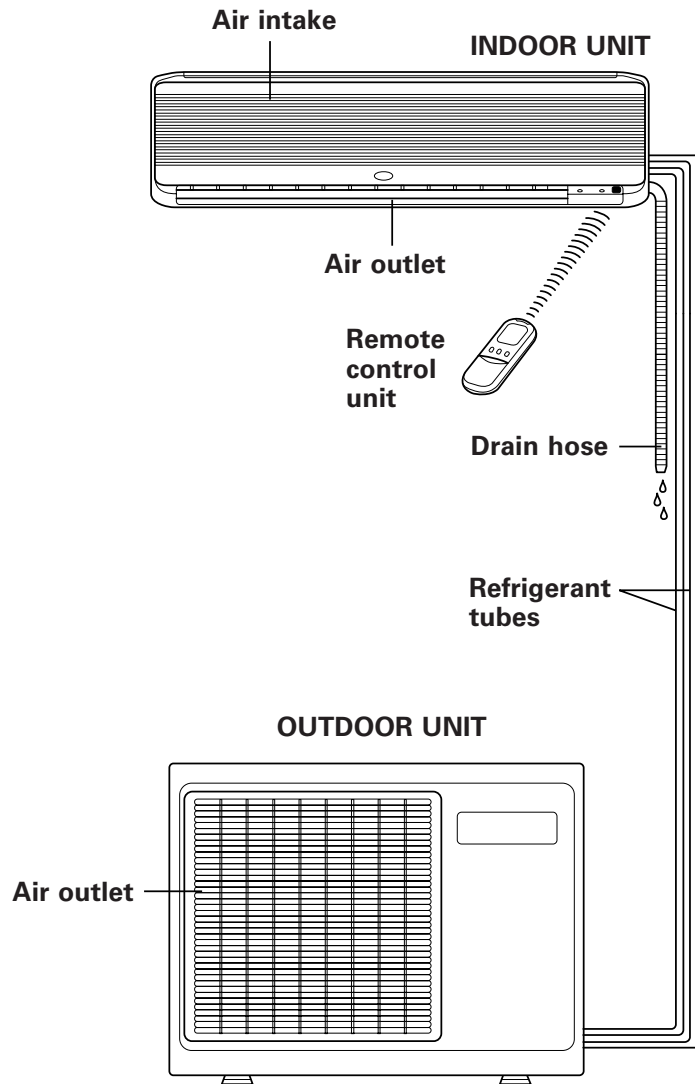

NOTE This illustration is based on the external view of a standard model. Consequently, the shape may differ from that of the air conditioner which you have selected.

This air conditioner consists of an indoor unit and an outdoor unit. You can control the air conditioner with the remote control unit.

Air Intake	Air from the room is drawn into this section and passes through air filters which remove dust.
Air Outlet	Conditioned air is blown out of the air conditioner through the air outlet.
Remote Control Unit	The wireless remote control unit controls power ON/OFF, operation mode selection, temperature, fan speed, timer setting, and air sweeping.
Refrigerant Tubes	The indoor and outdoor units are connected by copper tubes through which refrigerant gas flows.
Drain Hose	Moisture in the room condenses and drains off through this hose.
Outdoor (Condensing) Unit	The outdoor unit contains the compressor, fan motor, heat exchanger coil, and other electrical components.

Unit Display and Operation Selector





IMPORTANT

Avoid using radio equipment such as mobile phone near (within 1 m of) the indoor unit. Some radio equipment may cause the unit to malfunction.

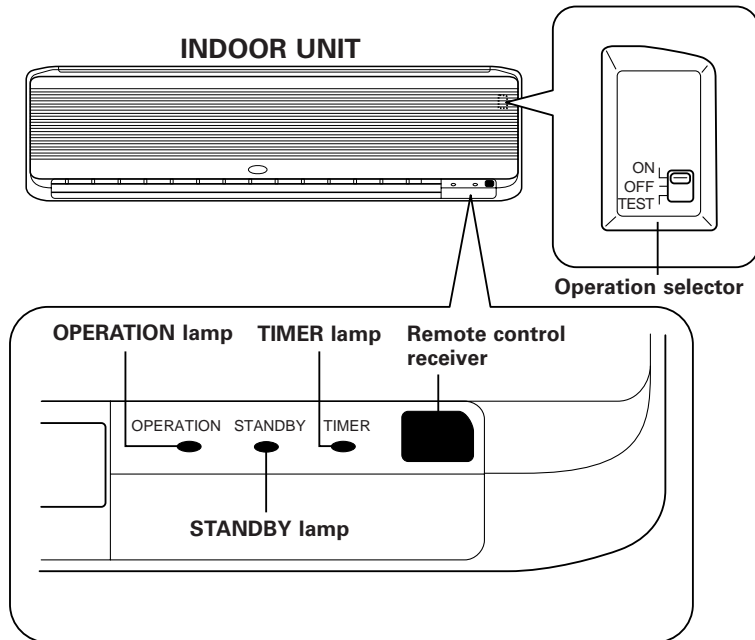
If the trouble occurs, disconnect power and restart the air conditioner after a few minutes.



<p>REMOTE CONTROL receiver</p>	<p>This section picks up infrared signals from the remote control unit (transmitter).</p>
<p>Operation selector ON position</p>	<p>This position is for operating the air conditioner with the wireless remote control unit. Set the selector normally in this position.</p>
<p>OFF position</p>  <p>WARNING</p>	<p>Switch the selector to the OFF position if you are not going to use the air conditioner for a few days or longer.</p> <p>The OFF position does not disconnect the power. Use the main power switch to turn off power completely.</p>
<p>TEST position</p>  <p>CAUTION</p>	<p>This position is used only when servicing the air conditioner.</p> <p>Do not set at the TEST position for normal operation.</p>
<p>OPERATION lamp</p>	<p>This lamp lights when the system is in the continuous DRY and COOL mode.</p>
<p>STANDBY lamp</p>	<p>This lamp lights during the warm up period for heating and when the system is defrosting. To keep a constant room temperature, the air conditioner continues to supply a gentle breeze during warm up or when the heating operation is interrupted by the thermostat.</p>
<p>TIMER lamp</p>	<p>This lamp lights when the system is being controlled by the timer.</p>

Remote Control Unit (Display)

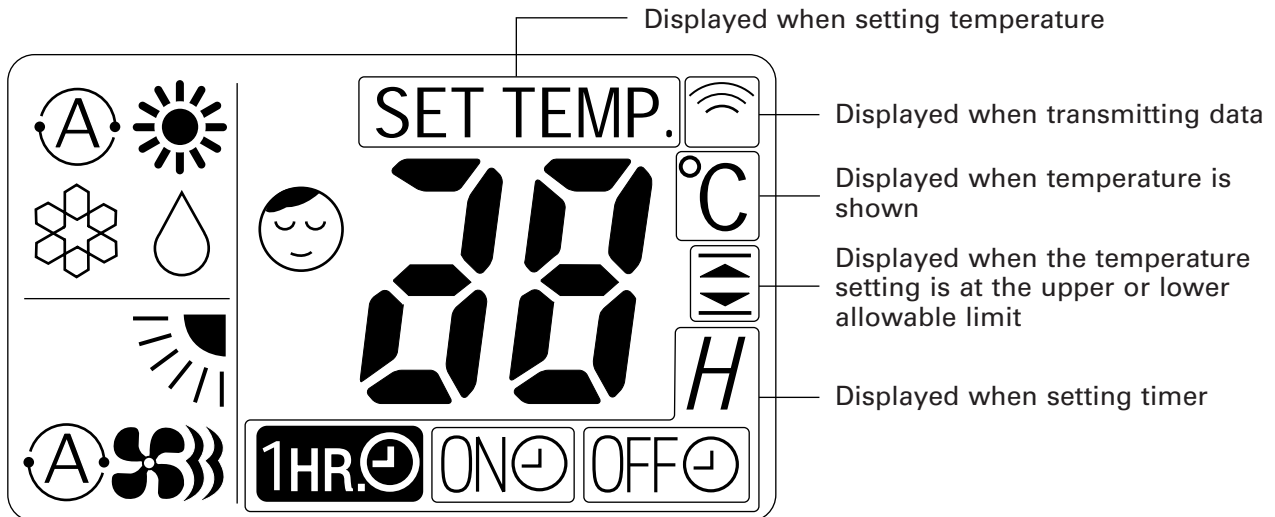

Symbols

(1) Operation mode

AUTO.....	
COOL.....	
HEAT.....	
MILD DRY.....	

(2) Fan speed

Automatic operation.....	
HIGH.....	
MEDIUM.....	
LOW.....	

(3) Set temperature

16–30°C
When set to 28°C.....



(4) Timer

12-hour ON Timer.....



12-hour OFF Timer.....



1-hour OFF Timer.....



(5) NIGHT SETBACK.....



(6) Confirmation of transmission.....



(7) Flap angle indication.....



(8) Sweep indication.....





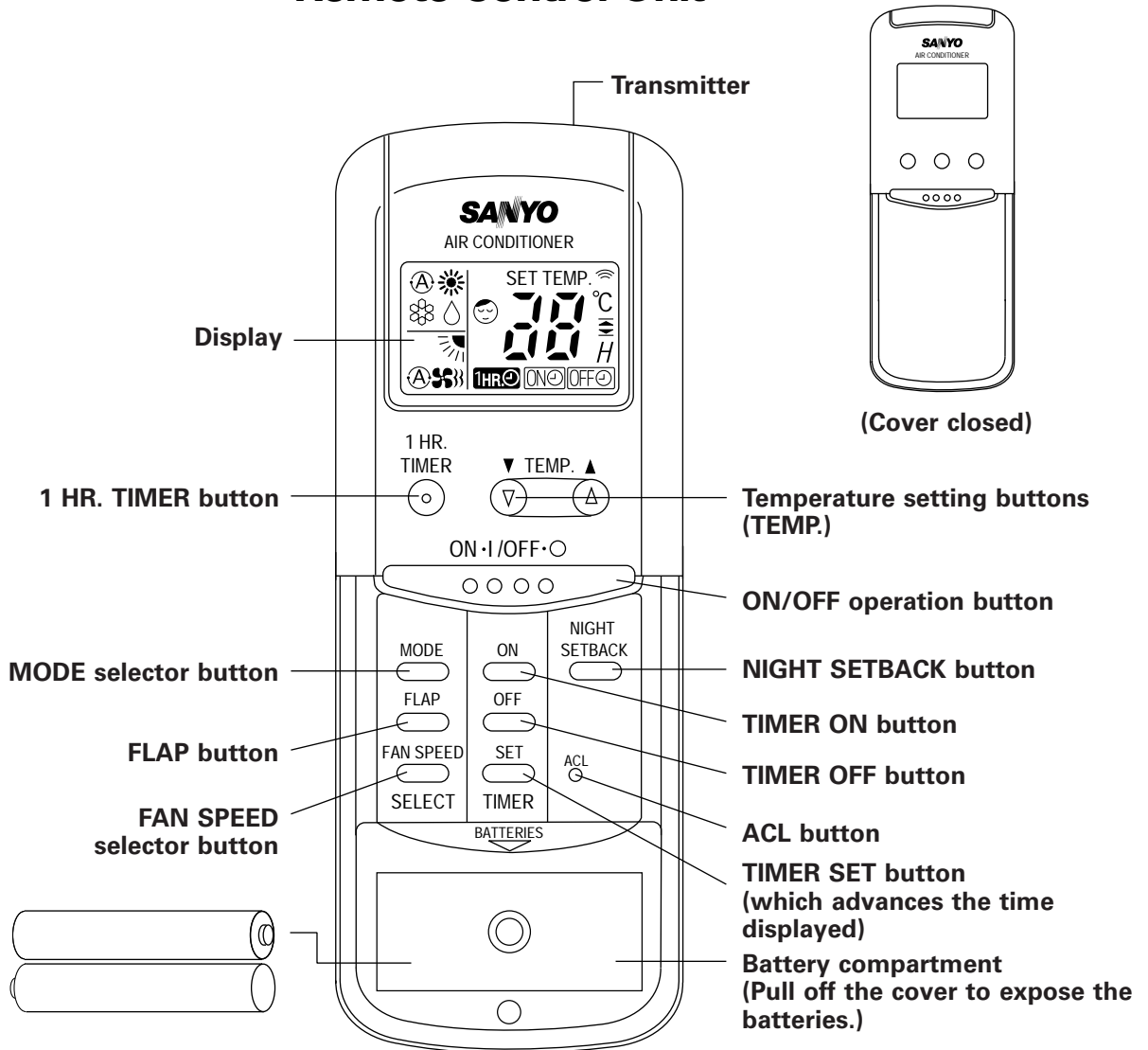

Remote Control Unit

















NOTE

The illustration above pictures the remote control unit after the cover has been lowered and removed.

Transmitter	When you press the buttons on the remote control unit, the  mark appears in the display to transmit the setting changes to the receiver in the air conditioner.
Display	Information on the operating conditions is displayed while the remote control unit is switched on. If the unit is turned off, only the mode that was set previously is still displayed.
NIGHT SETBACK button	For details, see "Night Setback Mode". When you press this button in the HEAT, DRY or COOL mode, the  mark appears in the display, and the remote control unit will automatically adjust the set temperature to save energy.
Temperature setting buttons (TEMP.)	Press the  button to increase the set temperature. Press the  button to reduce the set temperature.
ON/OFF operation button	This button is for turning the air conditioner on and off.

Remote Control Unit (continued)

TIMER ON button	 : The air conditioner starts at the set time.
TIMER OFF button	 : The air conditioner stops at the set time.
TIMER SET button	This button is used to set the time at which you wish the air conditioner to go on or off.
MODE selector button (AUTO) (HEAT) (DRY) (COOL)	Use this button to select AUTO, HEAT, DRY or COOL mode.  : When this setting is selected, the air conditioner calculates the difference between the thermostat setting and the room temperature and automatically switches to the "COOL" or "HEAT" mode as appropriate.  : The air conditioner makes the room warmer.  : The air conditioner reduces the humidity in the room.  : The air conditioner makes the room cooler.
FLAP button <div style="border: 1px solid black; padding: 2px; display: inline-block;">NOTE</div>	Press this button either to select to set the airflow direction to one of the six possible positions manually, or to select the sweep function, which moves the flap up and down automatically.  : The airflow direction can be set manually. (six positions)  : The flap moves up and down automatically. To switch to the sweep function () when in the manual () mode, hold down the FLAP button.
FAN SPEED selector button	 : The air conditioner automatically decides the fan speeds.  : High fan speed  : Medium fan speed  : Low fan speed
1 HR. TIMER button (1-HOUR OFF TIMER)	 : When you press this button, regardless of whether the unit is operating or stopping, the unit operates for one hour and then shuts down.
ACL button (ALL CLEAR)	Puts the remote control unit into pre-operation status. Always press this button after replacing the batteries.

• **Automatic switching between cooling and heating**

This unit automatically switches between cooling operation and heating operation according to the difference between the room temperature and the temperature setting.

EG

Using the Remote Control Unit

How to Install Batteries

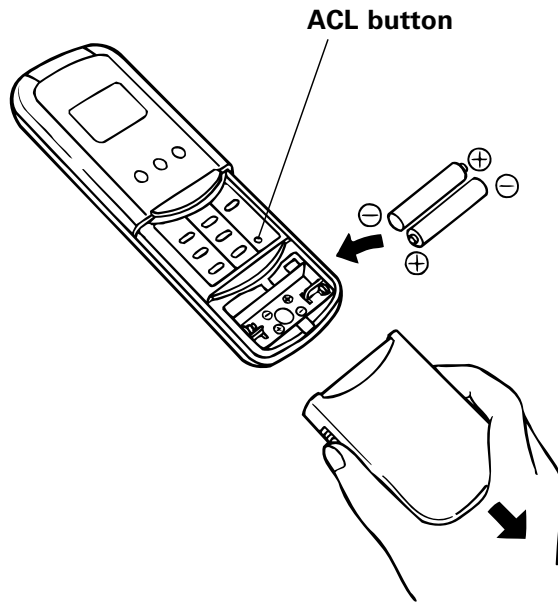

1. Slide the cover in the direction indicated by the arrow and remove it.
2. Install two AAA alkaline batteries. Make sure the batteries point in the direction marked in the battery compartment.
3. Use a thin object such as the tip of a pen to press the ACL button.

NOTE

- The batteries last about six months, depending on how much you use the remote control unit. Replace the batteries when the remote control unit's display fails to light, or when the remote control cannot be used to change the air conditioner's settings.
- Use two fresh leak-proof type-AAA alkaline batteries.
- In replacing batteries, follow the instructions as mentioned in the sub-section "How to Install Batteries".
- If you do not use the remote control unit more than 1 month, take out the batteries.

How to Use the Remote Control Unit

When using the remote control unit, always point the unit's transmitter head directly at the air conditioner's receiver.

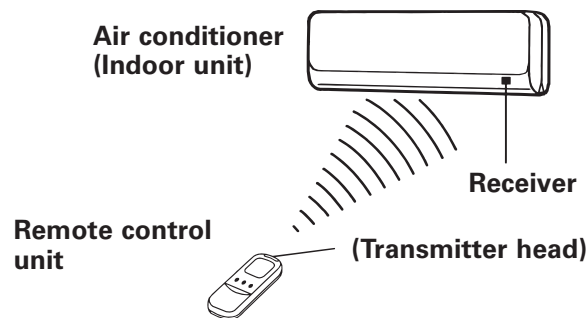

Remote Control Unit Installation Position

The remote control unit may be operated either from a non-fixed position or from a wall-mounted position. To ensure that the air conditioner operates correctly, **DO NOT** install the remote control unit in the following places:

DO NOT

- In direct sunlight
- Behind a curtain or other places where it is covered
- More than 8 m away from the air conditioner
- In the path of the air conditioner's airstream
- Where it may become extremely hot or cold
- Where it may be subject to electrical or magnetic noise
- Where there is an obstacle between the remote control unit and air conditioner (since a check signal is sent from the remote control unit every 3 minutes)

Using the Remote Control Unit (continued)

Mounting the Remote Control Unit

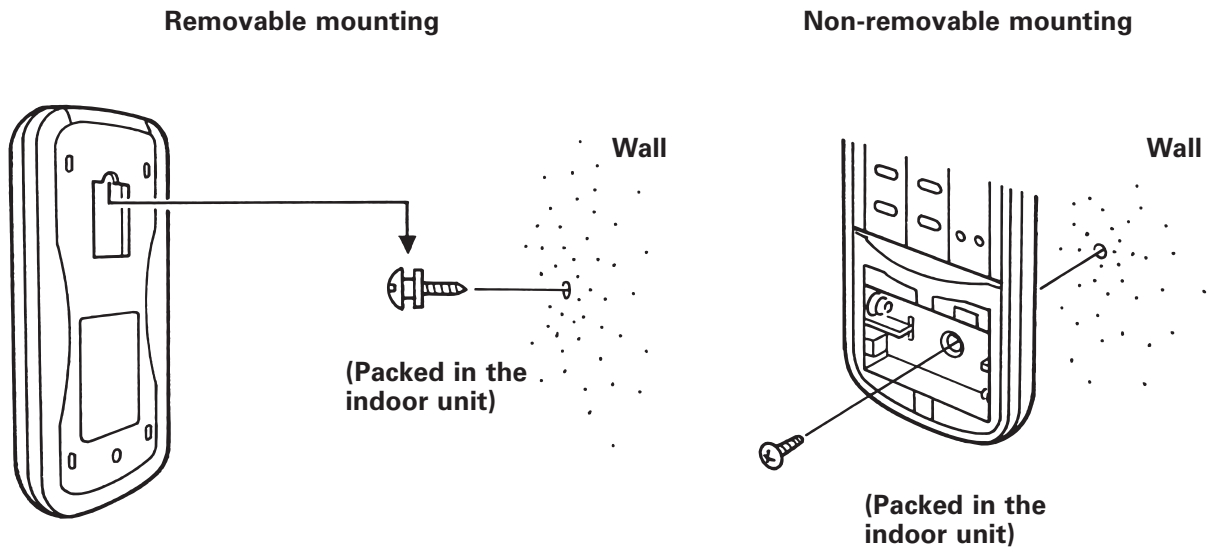

Mounting on a wall

A. Removable mounting

- 1) Momentarily hold the remote control unit at the desired mounting position.
- 2) Confirm that the air conditioner responds correctly when you press keys on the remote control from that position.
- 3) After confirming correct operation, use a screwdriver to screw the mounting screw into the wall.
- 4) Hang the remote control unit from the mounting screw.

B. Non-removable mounting

- 1) Momentarily hold the remote control unit at the desired mounting position.
- 2) Confirm that the air conditioner responds correctly when you press keys on the remote control from that position.
- 3) After confirming correct operation, use a screwdriver to screw the mounting screw into the wall.
- 4) Remove the batteries of the remote control unit.
- 5) Use a screwdriver to screw the remote control unit securing screw into the wall through the hole in the battery compartment.
- 6) Replace the batteries.
- 7) Again confirm that the remote control unit operates correctly.

Operation with the Remote Control Unit

1. Automatic Operation

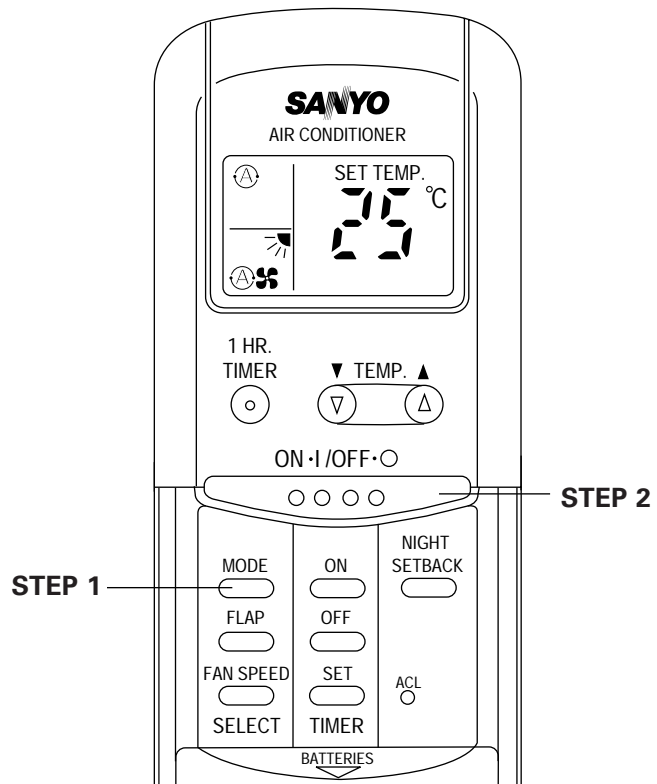

NOTE

Check that the circuit breaker on the power panel is turned on and that the operation selector of the indoor unit is in the ON position.

Once A mode is selected and the unit is preset by following the steps below, you can have the air conditioner automatically bring the room to the desired temperature simply by pressing the ON/OFF operation button.

STEP 1	Press the MODE selector to A .
STEP 2	Press the ON/OFF operation button.

To stop the air conditioner, press the ON/OFF operation button again.

NOTE

- To change the temperature setting; press the temperature setting buttons and change the setting to the desired temperature. The \equiv indicates the upper limit and the lower limit for the temperature setting.
- Although the fan speed is set automatically, you can change the fan speed by pressing the FAN SPEED selector button.

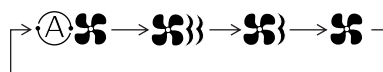

Operation with the Remote Control Unit (continued)

2. Manual Operation

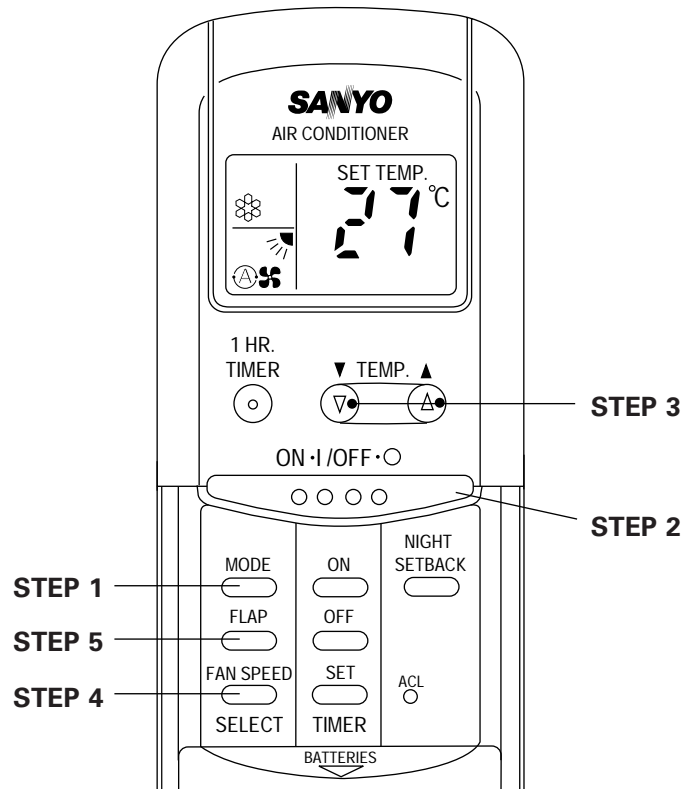

NOTE

Check that the circuit breaker on the power panel is turned on and that the operation selector of the indoor unit is in the ON position.

If the automatic operation settings of the unit do not meet your needs, press the setting buttons as described below and change the settings as desired.

STEP 1	Press the MODE selector button and select the desired mode. For heating operation → ☀ For dehumidifying operation → 💧 For cooling operation → ❄
STEP 2	To start the air conditioner, press the ON/OFF operation button.
STEP 3	Press the temperature setting buttons to change the temperature setting to the desired temperature. Adjustable temperature range: 30°C max. – 16°C min.
STEP 4	Set the FAN SPEED selector button to the setting you want.
NOTE	If the fan speed is set to Ⓐ❄ (Automatic), the fan speed switches automatically, according to the difference between the actual room temperature and the temperature setting.
STEP 5	Press the FLAP button and set the airflow direction as desired. (Refer to “Adjusting the Airflow Direction” on page 21.)

To stop the air conditioner, press the ON/OFF operation button again.

Operation with the Remote Control Unit (continued)

NOTE

- This appliance has a built-in 3-minute time delay circuit to ensure reliable operation. When the operation button is pressed, the compressor will start running within three minutes. In the event of power failure, the unit will stop. When the power is restored, the unit will restart automatically after three minutes.

3. Adjusting the Fan Speed

A. Automatic

Simply set the FAN SPEED selector button to the  position.

A microcomputer in the air conditioner automatically controls the fan speed when the  mode is selected. When the air conditioner starts operating, the difference between the room temperature and the set temperature is detected by the microcomputer which then automatically switches the fan speed to the most suitable level.



Cooling and DRY mode:

When difference between room temperature and set temperature is	FAN SPEED
2°C and over	High
Between 2°C and 1°C	Medium
Below 1°C	Low

Heating mode:

When difference between room temperature and set temperature is	FAN SPEED
2°C and over	High
Below 2°C	Medium

B. Manual

If you want to adjust fan speed manually during operation, just set the FAN SPEED selector button as desired. [ ,  , or ]

Operation with the Remote Control Unit (continued)

4. Night Setback Mode

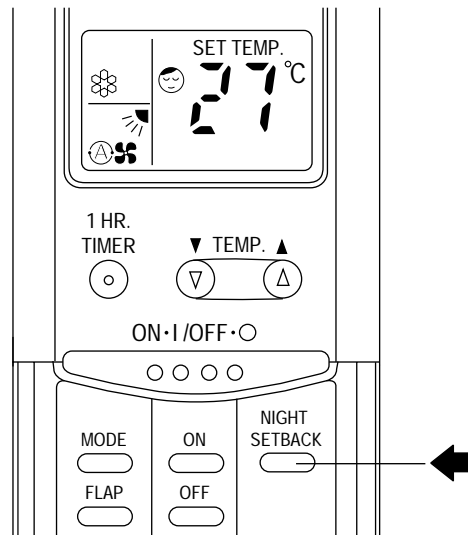

Night Setback Mode is used for saving energy.

Press the NIGHT SETBACK button while operation.
The ☺ mark appears in the display.

To release the night setback function, press the NIGHT SETBACK button again.

A. In Cooling and DRY Mode: (☼ and ♀)

When the night setback mode is selected, the air conditioner automatically raises the temperature setting 1°C when 30 minutes have passed after the selection was made, and then another 1°C after another 30 minutes have passed, regardless of the indoor temperature when night setback was selected. This enables you to save energy without sacrificing comfort. This function is convenient when gentle cooling is needed.

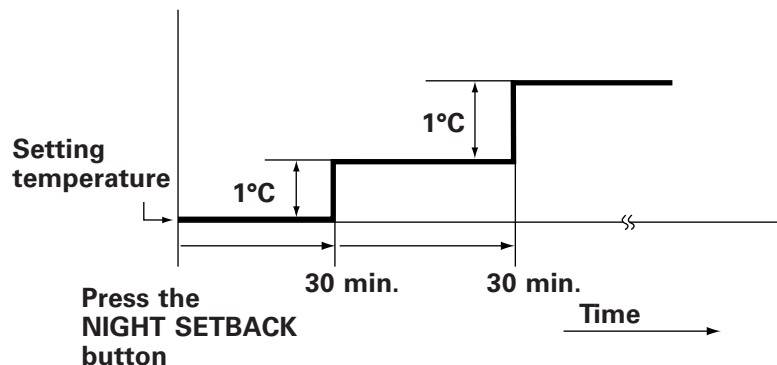

Operation with the Remote Control Unit (continued)

B. In Heating Mode: (※)

When the night setback mode is selected, the air conditioner automatically lowers the temperature setting 2°C when 30 minutes have passed after the selection was made, and then another 2°C after another 30 minutes have passed, regardless of the indoor temperature when night setback was selected. This enables you to save energy without sacrificing comfort. This function is convenient when gentle heating is needed.

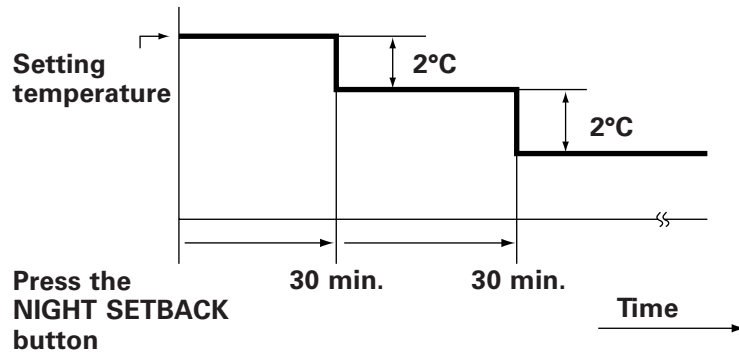

Special Remarks

"DRY" (☾) Operation

How it works?

- Once the room temperature reaches the level that was set, the unit repeats the cycle of turning on and off automatically.
- During DRY operation, the fan speed is automatically set to LOW or VERY LOW; the fan speed then switches back and forth between LOW (for 20 seconds) and VERY LOW (for 10 seconds).
- "DRY" operation is not possible if the indoor temperature is 15°C or less.

Heating (☀) Operation

Heating performance

- Because this air conditioner heats a room by drawing in the heat of the outside air (heat pump system), the heating efficiency will fall off when the outdoor temperature is very low. If sufficient heat cannot be obtained with this air conditioner, use another heating appliance in conjunction with it.

Defrosting

- When the outdoor temperature is low, frost or ice may form on the heat exchanger coil, reducing heating performance. When this happens, a microcomputer defrosting system operates. At the same time, the fan on the indoor unit stops and the STANDBY lamp remains lit until defrosting is completed. Heating operation restarts after several minutes. (This interval will vary slightly depending upon the outdoor temperature and the way in which frost forms).

STANDBY lamp

- For several minutes after the start of heating operation, the indoor fan will not start running until the indoor heat exchanger coil has warmed up sufficiently. This is because the COLD DRAFT PREVENTION SYSTEM is operating. During this period, the STANDBY lamp remains lit.

STANDBY lamp

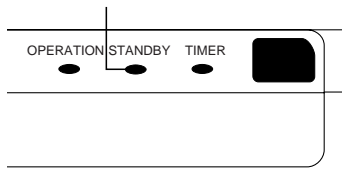

- The STANDBY lamp also remains lit during defrosting or when the compressor has been turned off by the thermostat when the system is in the heating mode.
- Upon completion of defrosting and when the compressor is turned on again, for heating operation, the STANDBY lamp will go off automatically.

Power failure during operation

- In the event of power failure, the unit will stop. When the power is resumed, the unit will restart automatically after three minutes.

Clicking Sound

Clicking sound is heard from the air conditioner

- In heating or cooling operation, any plastic parts may expand or shrink due to a sudden temperature change. In this event, a clicking sound may occur. This is normal, and the sound will soon disappear.

Remote Control Unit

- The remote control unit sends the setting condition to the air conditioner regularly at three minute intervals.

Using the 12-Hour ON and OFF Timer

1. TIMER ON mode (Example)

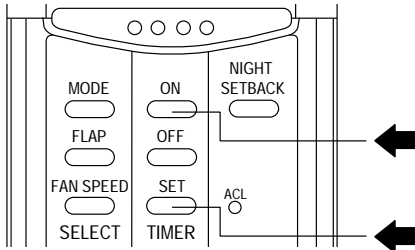

After the length of time set for **TIMER ON** elapses, the unit begins operating.

The display depicted at left indicates that the air conditioner will begin operating in three hours.

Setting procedure:

STEP 1	Press the MODE button and set the desired operation mode and press the ON/OFF operation button. (See "Operation with the Remote Control Unit," page 12.)
STEP 2	Press the TIMER ON button.
STEP 3	Press the TIMER SET button (which advances the time displayed) to set the time at which you want operation to begin. The time can be set for one to twelve hours, in one hour steps. <div style="text-align: center;"> </div>

- The display changes immediately to its status previous to timer setting, but the **ON/OFF** indication remains.
- To check the status of the timer while it is counting down, press the **TIMER SET** button.

Cancellation procedure: Press the **TIMER ON** button once again.

2. TIMER OFF mode (Example)

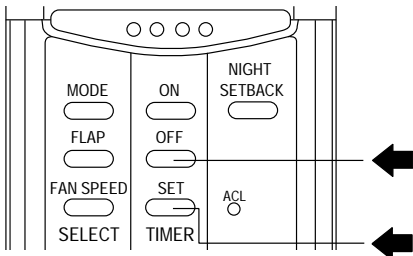

After the length of time set for **TIMER OFF** elapses, the unit stops operating.

The display depicted at left indicates that the air conditioner will stop operating in five hours.

Setting procedure:

STEP 1	Press the TIMER OFF button.
STEP 2	Press the TIMER SET button (which advances the time displayed) to set the time at which you want operation to stop. The time can be set for one to twelve hours, in one hour steps. <div style="text-align: center;"> </div>

- The display changes immediately to its status previous to timer setting, but the **OFF/OFF** indication remains.
- To check the status of the timer while it is counting down, press the **TIMER SET** button.

Cancellation procedure: Press the **TIMER OFF** button once again.

Using the 12-Hour ON and OFF Timer (continued)

3. ON/OFF Program Timer

A combination of the TIMER ON and TIMER OFF modes, this function allows you to specify the time that the unit turns on and the time when it turns off.

(Example) The unit will turn on three hours from now, and turn off five hours from now.



TIMER ON display during counting

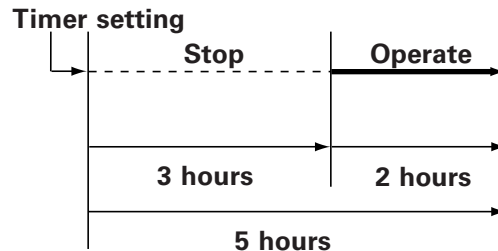

TIMER OFF display during counting after 3 hours has elapsed.

Setting procedure:

STEP 1	Use the procedure described in the "1. TIMER ON mode" section on the preceding page to set the timer to turn the unit on three hours from now.
STEP 2	Use the procedure described in the "2. TIMER OFF mode" section on the preceding page to set the timer to turn the unit off five hours from now.

- The display changes immediately to its status previous to timer setting, but the **ON** or **OFF** indication remains.
- Press the TIMER SET button to display the time remaining on the timer in seconds.
- Note that it is not possible to check both the ON and OFF timer settings. The timer setting that will occur first is given preference and displayed. The timer setting that will occur first is the one with the shorter time setting.

Cancellation procedure: Press the TIMER ON button and TIMER OFF button once again.

NOTE

- **Set the ON and OFF Timers simultaneously.** Unless you set the 12-Hour ON and OFF Timers at the same time, they may not operate at the specified time.

Using the 1-Hour OFF Timer

1. 1-Hour OFF Timer

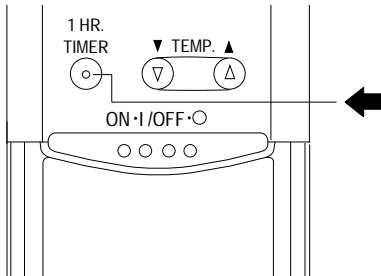

This function causes the unit to operate for one hour and then stop, regardless of whether the unit is on or off when this button is pressed. The **1HR** indicator in the display indicates that this function is operating.

Setting procedure:

Regardless of whether the unit is operating or stopped, press the 1 HR. TIMER button.

1HR appears in the display.

Cancellation procedure:

Press the ON/OFF operation button to turn the unit off, wait for the unit to stop operating, and then press the ON/OFF operation button again. The 1-Hour Timer function is now cancelled and the unit operates normally.

NOTE

- If, while the 1-Hour Timer function is operating, the 1HR. TIMER button is pressed once to cancel the function and then again, the unit continues to operate for one hour from that point in time and then stops.
- If the 1 HR. TIMER button is pressed while the TIMER OFF function operates, the OFF Timer is cancelled and the unit will stop operating one hour later.

2. Combining the 1-Hour OFF Timer and 12-Hour ON Timer

By combining the 1-Hour OFF Timer and 12-Hour ON Timer, it is possible to have the unit operate for just one hour from the present time, and then have it switch on again later at a time specified by you.

(Example) Having the unit operate for just one hour from the present time, and then switch on again three hours from the present time.

Timer setting

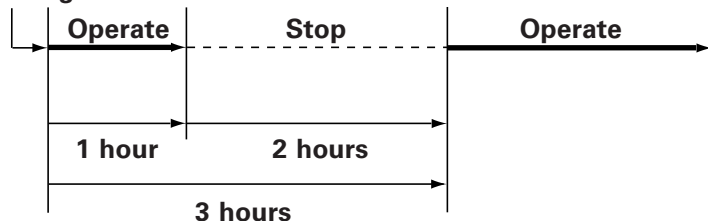

Setting procedure:

STEP 1	Press the 1 HR. TIMER button.
STEP 2	Press the TIMER ON button and use the TIMER SET button to set the unit to turn on three hours later.

NOTE

- **Set the 1-Hour OFF Timer and the 12-Hour ON Timer simultaneously.** Unless you set the 1-Hour OFF Timer and the 12-Hour ON Timer at the same time, the 1-Hour OFF Timer may operate for one hour or more.

Adjusting the Airflow Direction

1. Horizontal

The horizontal airflow can be adjusted by moving the vertical vanes with your hands to the left or right.

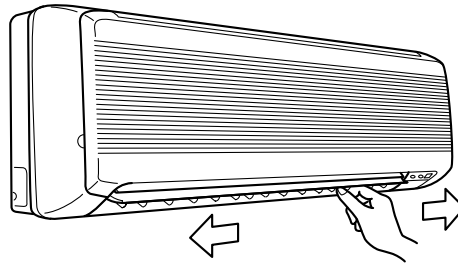

CAUTION

When the humidity is high, the vertical vanes should be in the front position during the cooling or dehumidifying operation. If the vertical vanes are positioned all of the way to the right or left, condensation may begin to form around the air vent and drip down.

2. Vertical

The vertical airflow can be adjusted by moving the flap with the remote control unit. Do not move the flap with your hands. Confirm that the remote control unit has been turned on. Use the FLAP button to set either the sweep function or one of the six airflow direction settings.

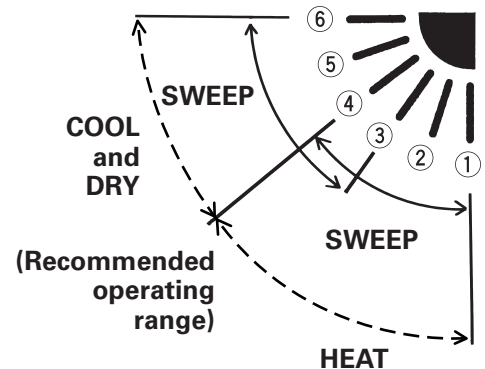
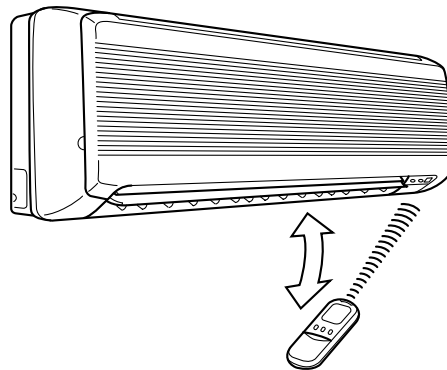
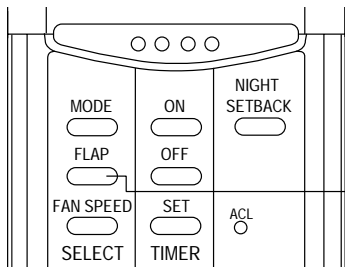

A. Sweep function



The flap starts moving up and down to deliver air over the sweep range.

B. Setting the Airflow Manually



Referring to the above illustration, use the FLAP button to set the airflow direction within the range used during the heating, cooling, or dehumidifying operation.

NOTE

- The flap automatically closes when the unit is off.
- During the heating operation, the fan speed will be very low and the flap will be in the horizontal position (position ⑥) until the air being blown out of the unit begins to warm. Once the air warms up, the flap position and fan speed change to the settings specified with the remote control.



CAUTION

- Use the FLAP button on the remote control to adjust the position of the flap. If you move the flap by hand, the flap position according to the remote control and the actual flap position may no longer match. If this should happen, shut off the unit, wait for the flap to close, and then turn on the unit again; the flap position will now be normal again.
- Do not have the flap pointed down during cooling operation. Condensation may begin to form around the air vent and drip down.

Operation without the Remote Control Unit

INDOOR UNIT

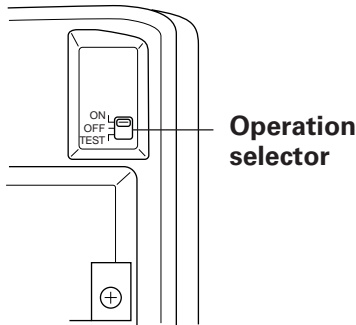

If you have lost the remote control unit or it has trouble, follow the steps below.

1. When the air conditioner is not running
If you want to turn on the air conditioner, switch the operation selector to the OFF position, and then to the ON position.

NOTE

The set temperature and fan speed are automatically set at the last selection before stopping.

2. When the air conditioner is running
If you want to turn off the air conditioner, switch the operation selector to the OFF position.

Care and Cleaning



WARNING

1. For safety, be sure to turn the air conditioner off and also to disconnect the power before cleaning.
2. Do not pour water on the indoor unit to clean it. This will damage the internal components and cause an electric shock hazard.

Casing and Grille (Indoor Unit)

Clean the casing and grille of the indoor unit with a vacuum cleaner brush, or wipe them with a clean, soft cloth.

If these parts are stained, use a clean cloth moistened with a mild liquid detergent. When cleaning the grille, be careful not to force the vanes out of place.



CAUTION

1. Never use solvents, or harsh chemicals when cleaning the indoor unit. Do not wipe the plastic casing using very hot water.
2. Some metal edges and the fins are sharp and may cause injury if handled improperly; be especially careful when you clean these parts.
3. The internal coil and other components of the outdoor unit must be cleaned every year. Consult your dealer or service center.

Care and Cleaning (continued)

Anti-Mold Filter

The anti-mold filter behind the air intake grille should be checked and cleaned at least once every two weeks.

How to remove the anti-mold filter

1. Grasp both ends of the air intake grille and pull it out and up.
2. Push the anti-mold filter up slightly, and then pull it down.

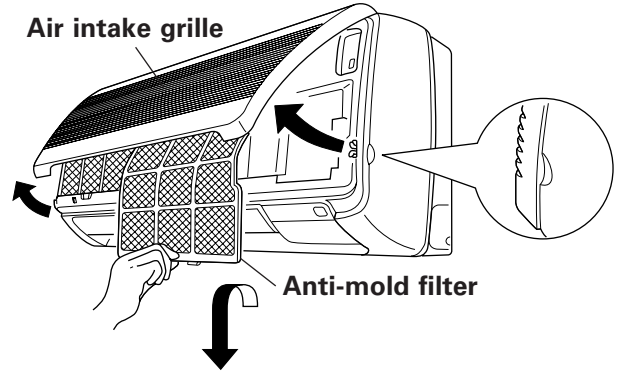

Cleaning

Use a vacuum cleaner to remove light dust. If there is sticky dust on the filter, wash the filter in lukewarm, soapy water, rinse it in clean water, and dry it.

How to replace the anti-mold filter

1. With the "FRONT" mark facing you, slide the anti-mold filter up into the unit and then lower the handle into the groove on the unit.
2. After installing the anti-mold filter, press the locations marked by the arrows (↓) and close the air intake grille.

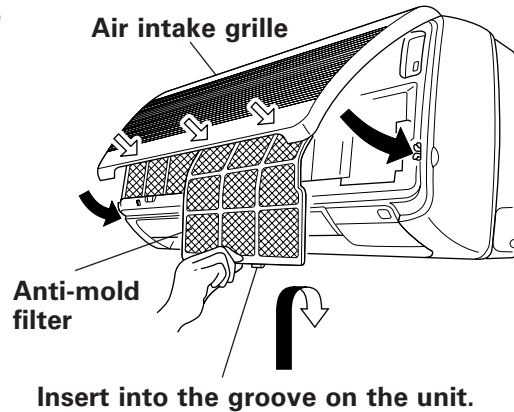

Care and Cleaning (continued)

Air cleaning filter (not provided)

The air cleaning filter removes dust and dirt from the air, and reduces odors and smoke from tobacco.

NOTE

The air clean filter is not provided with the air conditioner and must be purchased separately.
Ask for the **STK-F4B** model when purchasing.



WARNING

The air cleaning filter cannot remove harmful gases or vapors nor ventilate air in the room. You must open doors or windows frequently when you use gas or oil heating appliances. Otherwise there is a risk of suffocation in extreme cases.

How to install the air cleaning filter

The air cleaning filter needs to be installed behind the anti-mold filter.

1. Remove the anti-mold filter.
2. To mount the STK-F4B, set the air clean filter (sold separately) at the mounting position with the black side facing the rear.
3. Reinstall the anti-mold filter, and close the suction grill.

Air clean filter

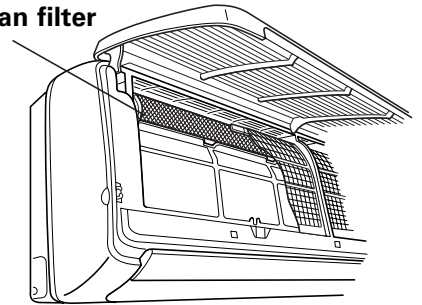

NOTE

Dirty air clean filters cannot be washed and reused. Purchase a replacement filter at your local dealer.

Cleaning the main unit and remote control unit

- Wipe clean using a soft, dry cloth.
- To remove stubborn dirt, moisten a cloth in warm water no hotter than 40 °C, wring thoroughly, and then wipe.
- The air intake grille can be removed in order to wash it with water.

Removing and remounting the air intake grille

- With the air intake grille open all the way, grip both arms with your hands and pull toward you to remove. To remount, hold the air intake grille roughly horizontal and push it in until the arm shafts fit into the indentations in the main unit, then fit the grille into place.

Air intake grille

Arm

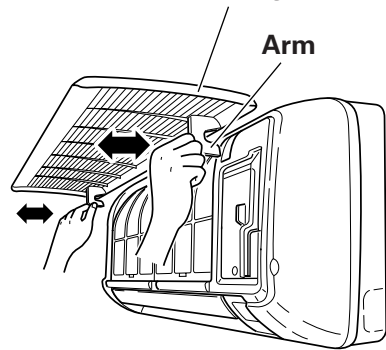

CAUTION

When using a footstool or the like, be careful not to let it tip over.

Washing the grille with water

- Clean the grille gently using a soft sponge, or the like. Then wipe away any remaining moisture.
- Neutral detergent may be used to remove stubborn dirt. Then rinse thoroughly with water and wipe away any remaining moisture.

Troubleshooting

If your air conditioner does not work properly, first check the following points before requesting service. If it still does not work properly, contact your dealer or service center.

Trouble	Possible Cause	Remedy
Air conditioner does not run at all.	<ol style="list-style-type: none"> 1. Power failure. 2. Leakage breaker tripped. 3. Line voltage is too low. 4. Operation button is OFF. 5. Batteries in remote control unit have run down. 	<ol style="list-style-type: none"> 1. Restore power. 2. Contact service center. 3. Consult your electrician or dealer. 4. Press the button again. 5. Replace batteries.
OPERATION lamp flashes and air conditioner does not operate.	Trouble in wiring system.	Contact service center.
Compressor runs but soon stops.	Obstruction in front of condenser coil.	Remove obstruction.
Poor cooling (or heating) performance.	<ol style="list-style-type: none"> 1. Dirty or clogged air filter. 2. Heat source or many people in room. 3. Doors and/or windows are open. 4. Obstacle near air intake or air discharge port. 5. Thermostat is set too high for cooling (or too low for heating). 6. (Outdoor temperature is too low.) 7. (Defrosting system does not work.) 	<ol style="list-style-type: none"> 1. Clean air filter to improve airflow. 2. Eliminate heat source if possible. 3. Shut them to keep the heat (or cold) out. 4. Remove it to ensure good airflow. 5. Set the temperature lower (or higher). 6. (Try to use a back-up heater.) 7. (Consult your dealer.)
Clicking sound is heard from the air conditioner.	In heating or cooling operation, any plastic parts may expand or shrink due to a sudden temperature change. In this event, a clicking sound may occur.	This is normal, and the sound will soon disappear.
OPERATION lamp lights but outdoor unit will not run.	1. The use of portable telephones near the air conditioner may cause disturbance to its normal operation.	<ol style="list-style-type: none"> 1. Turn off the power then restart the air conditioner after 1 minute. 2. Consult your dealer.

Tips for Energy Saving

- Do not**
- **Block the air intake and outlet of the unit. If they are obstructed, the unit will not work well, and may be damaged.**
 - Let direct sunlight into the room. Use sunshades, blinds or curtains. If the walls and ceiling of the room are warmed by the sun, it will take longer to cool the room.
- Do**
- Always try to keep the air filter clean. (Refer to "Care and Cleaning".) A clogged filter will impair the performance of the unit.
 - To prevent conditioned air from escaping, keep windows, doors and any other openings closed.



SANYO Electric Co.,Ltd

Osaka, Japan

SM700439 01/00/200

Printed in Japan