

## Parts List



---

File No.
----------

## Air Conditioner

INDOOR UNIT  
SAP-K181GJHA

---

Model No.	Prod.Code	Volt-Phase-Hertz
SAP-K181GJHA-S	1 852 070 48	220-240-1-50

SAP-K181GJHA  
INDOOR UNIT

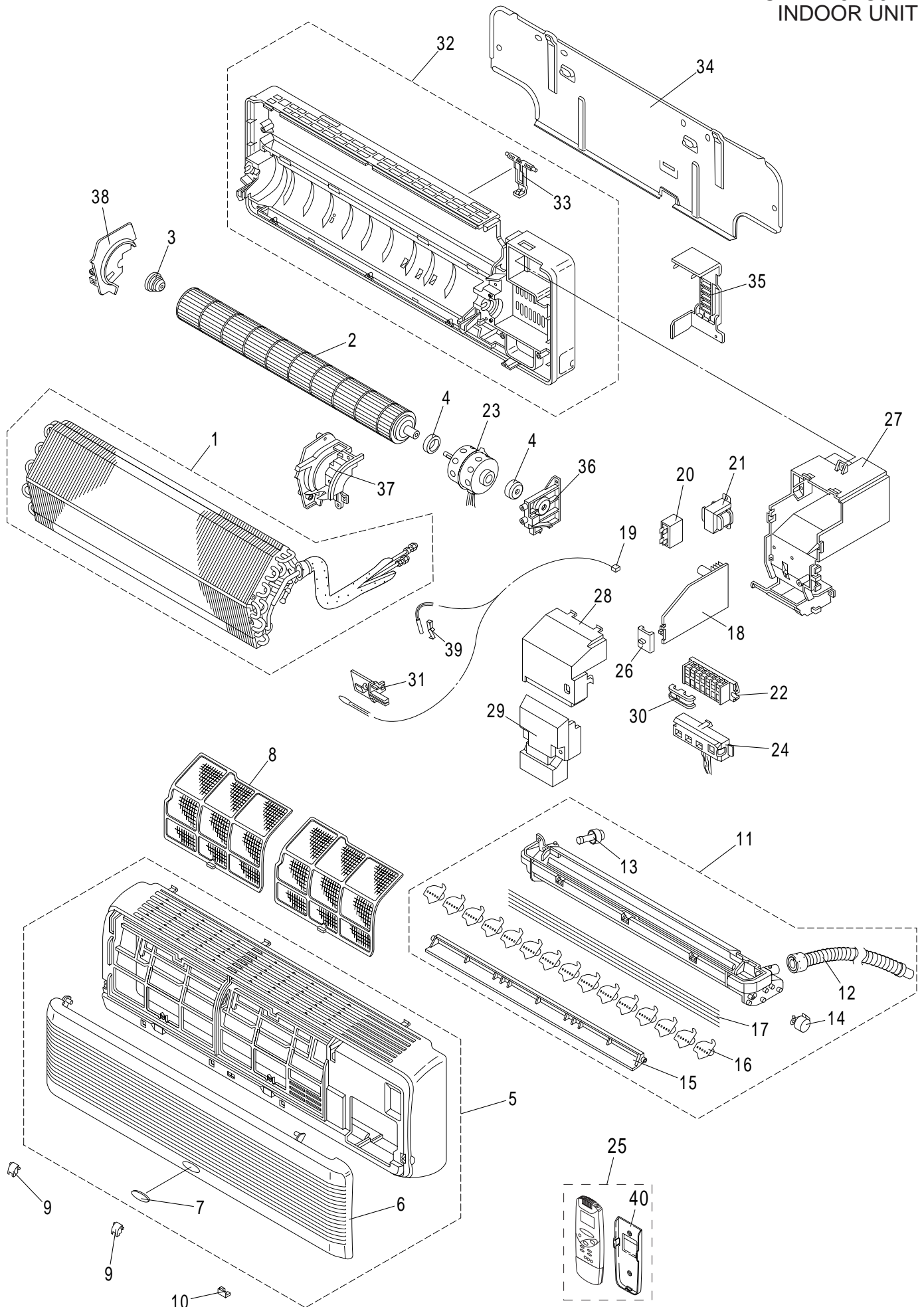

**ATTENTION !**

To ensure correct parts supply, please let us know followings,  
when you make service parts order:

1.Part No. 2.Description 3.Q'ty 4.Volts-Hz-Ph 5.Product Model No.

SAP-K181GJHA  
INDOOR UNIT

Key No.	Part No.	Description	Q'ty	Reference No.
1	623 156 4236	Evaporator Ass'y	1	85S-0-4116-01300
*	2 623 153 1283	Cross - Flow Fan Ass'y	1	852-0-2509-21900
*	3 623 094 4466	Bearing Housing Ass'y	1	852-0-2510-12800
4	623 118 2515	Cushion Rubber	2	852-2-2511-15801
5	623 155 1366	Grille Ass'y	1	852-0-1501-44800
6	623 153 1269	Ornamental Plate	1	852-2-1516-29701
7	623 153 1252	Badge	1	852-2-1504-22301
8	623 153 1245	Air Filter Ass'y	2	852-0-2307-27301
9	623 153 1351	Cap	2	852-2-2350-17401
10	623 153 1344	Cap	1	852-2-2350-17301
11	623 156 4243	Blade Ass'y	1	85S-0-1504-00100
12	623 156 4199	Drain Hose Ass'y	1	85S-0-1303-00300
13	623 151 2978	Cap, Drain Pan	1	852-2-2348-12101
*	14 623 153 1320	Step Motor	1	529-0-0000-07500
15	623 153 1313	Flap	1	852-2-1523-22401
16	623 153 1306	Blade	15	852-2-1519-27401
17	623 153 1405	Wire	5	852-2-1315-30102
*	18 623 157 0183	Circuit Board Ass'y CB-K181GJHA	1	851-0-5181-12300
*	19 623 153 1382	Thermistor Ass'y SAP-K181GJ-S	1	851-0-5259-71100
*	20 623 096 2583	Fixed Capacitor UPMDD-440V/2.0MF	1	4-2239-56159
*	21 623 147 9165	Transformer Ass'y ATR-J105	1	851-0-5263-10600
22	623 146 7698	Terminal Base OPSA-20-7P	1	1FA-4-J3A0-07100
*	23 623 153 1375	Fan Motor UF2-31A5P-S	1	525-0-0000-83605
*	24 623 155 1373	Indicator Lamp Ass'y IND-K1GJH	1	851-0-5161-62900
*	25 623 156 4335	Remote Control Switch RCS-2HS2E	1	851-0-0054-37300
26	623 151 2800	Knob	1	852-2-5323-11201
27	623 153 1443	Elec. Component Box	1	852-2-5307-58601
28	623 153 1436	Cover Plate	1	852-2-5315-36200
29	623 153 1429	Terminal Cover	1	852-2-5321-12301
30	623 151 3098	Clip, Wire	1	852-2-5304-18100
31	623 131 8907	Mounting Thermostat	1	852-2-5303-19301
32	623 153 1412	Frame Ass'y	1	852-0-2201-30200
33	623 153 1481	Mounting, Tube	1	852-2-2362-23401
34	623 156 4267	Rear Panel	1	852-2-2230-17000
35	623 153 1481	Mounting, Tube	1	852-2-2362-23401
36	623 153 1474	Mounting Plate, Fan Motor	1	852-2-2520-23601
37	623 153 1467	Mounting Plate	1	852-2-2309-80701
38	623 153 1450	Cover Rubber Ass'y	1	852-0-2515-10500
39	623 148 5876	Mounting Thermostat	1	852-2-5303-22401
40	623 156 4229	Holder	1	851-2-5377-01801

NOTE: Metal and plastic parts will be supplied basically with necessary heat insulation pads or packing. Each key number with an asterisk (\*) means the recommended service parts.



---

SANYO Electric Co.,Ltd  
Osaka, Japan  
9/00 Printed in Japan