



## **Instructions for operation and installation of electrical boiler**

**PROTHERM K  
PROTHERM D**

Protherm, s. r. o. (Ltd.)  
170 00 Praha 7, Jablonského 4  
Czech Republic  
Tel.: 00420 2 66712424  
Fax: 00420 2 805593

Dear customer,

You have become the owner of direct heated electrical boiler fitted with parts and equipment manufactured by the renowned producers.

We believe you will use the PROTHERM boiler to your full satisfaction. However, it is necessary to meet at least the minimal requirements for operating the boiler. Therefore, we would like to ask you for careful reading and abiding by the instructions.

We are sure the PROTHERM electrical boiler will contribute to pleasant atmosphere and optimal temperature in your environment.

Please pay attention to the following important instructions:

1. The boiler and all its necessary fittings and mountings must be installed and used in accordance with the project, all corresponding legal and technical regulations and the instructions of the manufacturer.
2. The boiler can be installed only in the surroundings for which it is designed.
3. It must be installed and put into operation exclusively by a specialist authorized by the producer.
4. In case of trouble, contact the specialist authorized by the producer – unprofessional repairs can damage the boiler (or possibly the fittings and mountings)!!
5. Examine the delivery and check it for completeness.
6. Check if the delivered model corresponds with your requirements.
7. If you feel uncertain about operating the boiler, please look up all the relevant information in the instructions and follow it.
8. Do not remove or damage any signs or labels on the boiler.
9. The boiler was made in accordance with the regulations valid in the Czech Republic. In case of using in a foreign country, it is necessary to deal with the possible differences.
10. When the service life of the boiler or its parts is over, they ought to be disposed environmentally friendly.

### **Types and usage description**

The PROTHERM electrical boilers are designed for assembling in heating-water distribution systems with forced water circulation. It is used for heating of service water, which is, in central or level heating systems, distributed by a pump to radiators.

The boiler is equipped with cylindrical exchanger with heating elements, circulating pump, manometer, thermometer, operation and breakdown thermostat and electronic switching block.

The electrical boiler is built-in into a steel case. Its front and both sides create a mechanical unit attached by screws to back-wall. The circulating heating water inlet is at the bottom, outlet at the top.

The D type allows a second pump to be mounted which enables heating of two detached dwelling units. A separate room regulator independent of temperature in the other unit regulates the temperature in each unit. Two non-return valves have to be mounted in the heating water distribution system.

The type can also be used for heating one dwelling unit and heating of HSW (hot service water) through HSW container heated by heating water (HW) flow. To increase output of the D type boilers they can be arranged in a cascade controlled by one room regulator located at the central electrical boiler.

The K type is of the same design as D type. There is no possibility to connect second pump to it and it is designed for only one heating circuit, though.

All types of the electrical boilers have a function of gradual switching the output on and off in max. 6 kW steps (2 kW in each phase) with approximate delay of 10 sec., which protects the electrical distribution network from undesirable pulses when switching the boiler on and off. The circulating pump runs for only necessary period of time which saves energy and reduces its mechanical wear. The pump remains in operation for certain time after the boiler is switched off to utilize the hot water in the boiler body and pipes.

The electrical boilers are equipped with a contactor for ARC (aggregate remote control) signal control.

## **Operation**

The electrical boilers are designed for automatic operation. After the main electrical switch is switched on, a white signal lights up on the main control panel (see figure of the control panel) signalling connection of the boiler to line voltage. Further signal (lock-out) informs of connection of the contactor controlled by ARC signal and at the same time that there is no low-tariff electricity supply lock-out. The signal is on when during the low-tariff energy supply.

The three buttons located at the bottom of the control panel enable the overall output to be reached gradually – by thirds of the maximum output. Only in case of outputs of 24, 21 and 15 kW the grades for the buttons are different:

24 kW: 1<sup>st</sup> button – 12 kW, 2<sup>nd</sup> button – 6 kW, 3<sup>rd</sup> button – 6 kW  
21 kW: 1<sup>st</sup> button – 9 kW, 2<sup>nd</sup> button – 6 kW, 3<sup>rd</sup> button – 6 kW  
15 kW: 1<sup>st</sup> button – 6 kW, 2<sup>nd</sup> button – 6 kW, 3<sup>rd</sup> button – 3 kW

The signals above the buttons inform that the switches are on and the heating elements in the electrical boiler heat. These signals do not shine permanently but they switch on or off in accordance of the boiler being turned on and off by the room regulator or boiler thermostat. If two or more boilers are operated in a cascade, the third button of each previous boiler has to be switched on to ensure proper function. Maximum temperature of water in the boiler is set at the boiler thermostat. Its setting to be done according to instructions of assembling company as maximum temperature of heating water depends on the type of your heating system (floor heating, thermostatic heads, service water heating, etc.). The assembling company shall also set the right pump speed depending on the system. The room thermostat setting is to be done according to the regulator manual. In case of classical type of central heating with radiators and regulation by means of room regulator the temperature of the boiler thermostat has to be set higher – e.g. 80°C. However, do not be surprised that the temperature in the heating system will not reach this value. The water temperature will, due to the room regulator, settle on the value needed to reach the required room temperature. Setting the higher temperature on the boiler thermostat will only prevent the boiler from switching off and thus negatively influencing the room regulator function.

The output-preselected level depends on heat loss of your house or apartment, atmospheric temperature, required room temperature or whether you use the electrical boiler for heating of service water. The boiler will not get damaged if it is operated full load while atmospheric temperatures range around 0 °C.

However, when heating two dwelling units the output setting has to be high enough to compensate the heat losses of both units.

Should the boiler be operated in lower than maximum output, especially in spring and autumn, we recommend changing the set output level from time to time. This is to avoid excessive wear of relays on the favourite level.

Safe operation of the electrical boiler is ensured by a safety thermal fuse – safety thermostat which puts the boiler irreversibly out of operation once critical temperature of 95°C – 100°C is exceeded. This state is signalled by a yellow control light. As soon as the situation occurs without a delay call a technician who will check possible reasons, repairs the boiler and re-start it. Never try to repair the boiler yourself! This situation is extremely rare and you will probably never come across with it. In order to reach economical operation (minimum electrical energy costs), your system has to be completed with a suitable regulation providing heating in required temperature when you are in, and automatically decreases the temperature at night or the periods when nobody is in.

Both simple and more complicated regulation units, e.g. programmable (daily or weekly program) room regulators are available from PROTHERM boiler manufacturer and its contract partners. A regulator with dead output is unconditionally needed for correct function of PROTHERM electrical boilers.

When heating two apartments with one electrical boiler type D (system with two pumps) each of the apartments should have its own room regulator. Temperature alterations in the apartments can be set up individually and independently both as to

time and level. The hot water distribution by the pumps is arranged so that there is no mutual influence of the systems. As mentioned before, the electrical boiler output has to be set to compensate heat losses in both apartments.

Once one apartment plus service water are heated, the service water exchanger tank has to be fitted, unless it has already been done by the manufacturer, with a thermostat sensing temperature of service water by a dead output contact substituting function of the second room regulator. The HSW is continuously heated to temperature set on the thermostat (50-60°C). The HSW heating and heating itself are time independent on each other. When the heating cycles are concurrent, the time needed for HSW heating gets longer as the heating water resultant temperature is given mainly by higher water volume in the heating system as well as its lower temperature. This situation does not have to occur every time – it depends on specific heating system conditions, i.e. water volume, atmospheric temperature, HSW take-off frequency and amount, etc. The HSW will be heated by a full load of the system whenever the room regulator interrupts apartment heating, i.e. mainly at night and in the periods when nobody is present. This function practically means that you can give priority to HSW heating by temporary decreasing of required temperature on the room regulator under real value to reach the state when the room regulator switches the heating off.

As the particular conditions in each object are different, the system has to be practically tested. In case the HSW heating is adversely influenced by the heating system, the concurrence of both heating cycles can be eliminated by using a room regulator with a throw-over contact.

### **Installation and operation conditions**

Connection of electrical heating system is subject to agreement of local electricity supplier. Preliminary agreement with a possibility of connection of higher power input has to be applied for as well as housing electrical heating rate.

If you are building a new central heating or reconstructing on old one and you want to make sure it will run well and economically, you should contact a designer for a project.

The electrical boiler can be installed into your heating system entirely by a qualified heating engineer. Connection to electrical network and other installations can be performed only by an expert with a qualification in accordance with Notice No. 50/78.

The electrical boilers are designed for permanent connection to a stationary line voltage distribution system. A breaking device has to be built-in into the boiler distribution system. Distance of all its disconnected contacts has to be at all poles at least 3 mm.

A suitable place has to be chosen for the boiler; sufficient space should remain in front of the boiler for its operators, under and above the boiler to allow connection of heating system inlet and outlet piping.

The manufacturer grants a guarantee under the condition that the installation will be carried out by an authorized service organization! For this reason please contact our partners who will assist you in getting all technical documentation, do the boiler connection and advise you as to your heating system operation.

After installation ask the expert for demonstration of the system function and for operation training. Once the boiler is in operation, the expert has to validate the certificate of warranty.

The boiler fittings and mountings are designed for attendance without electrotechnical qualification in accordance with ČSN (Czech National Standard) 34 3108. The operator is only allowed to manipulate control elements described in this manual or as directed by the service company. The operator is in no way entitled to meddle with electrical installations.

The boiler needs to be placed near a source of pressure water to fill and discharge the system. A suitable vertical wall is also a must for the boiler placement (the boiler hangs on the wall).

The electrical boiler is designed for operation in a standard environment: AA5 / AB5 in accordance with ČSN 33 2000-3 and ČSN 33 2000-5-51 (i.e. temperature range from +5°C to +40°C, humidity depending on the temperature up to 85%).

The boiler cannot be installed in rooms with a bath, bathrooms, wash-rooms and showers and zones 0, 1 and 2 as described in ČSN 33 2000-7-701. It can be installed neither in zone 3 in case there is a stream of water for cleaning purposes (e.g. public baths, bathtubs and showers in schools, factories, sports clubs, public places generally, etc.).

If the boiler is installed in the permissible zones, the mentioned standard requires appropriate protection against electrical shock hazard.

The wall bearing the boiler has to be non-combustible (non-combustible materials listed in group A in accordance with ČSN 73 0830).

### **Mounting**

Two bolts M10 built up into a wall are recommended for the boiler suspension. The unit of heater with pump and accessories are fitted to the back wall. The box casing is removable and it is fixed to the back wall with bolts.

The returning water inlet, a 1" pipe, is located at the bottom of the casing. The feeding water outlet is at the top and a 1" connection pipe is mounted directly to the pump by a pipe union with a cap nut and gasket (included in delivery). A rule has to be adhered at the mounting that the stop valve cannot be mounted among boilers, expansion vessel and safety valve.

In the heating systems where the water circulation can be completely closed by thermostat controlled valves it is necessary to include a bypass between feeding and return water pipes.

A cover sheet with a hole has to be slid on the pipe before you mount the pipe union with the cap nut connecting the pipe to the pump. The cover sheet is fitted with a flat connector where a protective conductor (yellow-green) already prepared in the boiler has to be added on. The protective conductor is connected inside the boiler with a protective clamp. As soon as the pipe is connected and the box casing put on (the cover sheet remains inside the box), this part has to be tightened to the upper wall and fastened by a sleeve around the pipe. For the position of the cover sheet see Fig. 1. If this is not done, there is a real danger of contact with danger voltage.

### **Electrical installations**

The client has to have prepared, before the boiler mounting, a power cable with a main switch for the heating, protection and other changes of house electrical installation including its inspection and also inform the electricity supplier of power take-off.

Before connection to power network bushings (included in delivery) have to be mounted to the openings in the back wall for connection of electrical wiring and supply from the space regulator. The bushings are located in the upper right corner of the back wall (front view). Do not forget to mount outer protective clamp (brass bolt M6) which is for the reason of transportation inserted contrariwise!

All the areas around the bolt, both sides of the case, have to be cleaned to bare metal before mounting the protective clamp. A protective lead with a cable lug is to be placed under the bolt head in the casing. Tighten the connection by a brass nut and fan-shaped washer. The other nut is to be used for connection of external protective lead.

Room regulators with a potential-free output are to be connected to PT connectors. A regulator with an electrical boiler have to be connected through a power cable.

If placing pumps outside the electrical boiler (type D), the inner leads have to be disconnected from the pump terminal box and connected to terminals 9, 10, 11 (pump 1). The pump is taken out and together with the second pump mounted into both heating systems. The pumps are protected inside the electrical boiler.

Heat sensors (room regulator, HSW thermostat) have to be connected into the terminals corresponding with pumps of both circuits (regulator 1 – pump 1). When using a room regulator with a switch-over contact (to eliminate parallel run of heating and heating of HSW) the connection is done as seen in Fig. 9. A connection between terminals 15 and 17 is disconnected. The now free terminal 17 is used for connection of third lead from room regulator. At the same time a contact of HSW thermostat is connected between the terminal (17) and terminal 18.

When the electrical boilers are cascade connected, the main boiler is controlled by a room regulator (terminals 15, 16). At the second and others the terminals for a room regulator are connected to terminals 19, 20 of the previous boiler – Fig. 10.

### **Operation**

After the electrical boiler is connected into the heating system (according to local conditions), the system is filled with soft water in compliance with ČSN 07 7401 while checking tightness of the system. If needed, additional tightening has to be done. It is also necessary when mounting electrical boilers to make sure that the heating system is equipped with a protective installations in compliance with ČSN 06 0830 (expansion pressure vessel, safety valve).

**ATTENTION!!! Electricity can be lead into the boiler electric installations system only after the system is filled with water!**

After the installation correct function of service thermostat, heat fuse and control elements on the panel has to be checked. Pump output is to be set according to heating system operating conditions.

### **Maintenance**

The electrical boiler is maintenance-free. Nevertheless, we recommend to have a check done by a service company once a year – best before heating season (not covered by guarantee).

Water pressure should be checked at the pressure gauge from time to time when a boiler is operated in an enclosed system of heating and expansion pressure vessel. If in a cold system the pressure drops under the limit marked by supplier, the system has to be checked by experts. In case of open systems water level in the expansion vessel has to be checked and possible loss re-filled.

### **Delivery completeness**

An electrical boiler is supplied assembled with exception of bushings, external protective terminal and pipe union. These parts are inserted into the boiler casing and they are mounted by a service engineer.

Connecting leads for electrical boiler and room regulator are not part of delivery.

A complete delivery consists of the following parts and documentation:

- assembled electrical boiler and casing
- packing bushings
- external protective terminal – 1 pc
- pipe union, 1", straight – 1 pc
- Instructions for operation and installation of PROTHERM electrical boiler
- Certificate of warranty



- Certificate of product quality and completeness

### **Warranty and warranty conditions**

A warranty in accordance with Certificate of warranty and conditions listed in these instructions apply to the PROTHERM electrical boiler.

### **Transportation and storage**

The boiler is protected for transportation and storage purposes with a cover – it is necessary to avoid any action of the force to the cover, shocks and never, with exception of unpacking, put the boiler into the position in which it could slip out of the cover.

Standard storage conditions have to be ensured (non-aggressive and dust-free environment, temperatures ranging from 5°C to 50°C, air humidity up to 75%, no biological influences, vibrations or shocks).

### **Technical characteristics**

Voltage		3 x 400/230 V, 50 Hz
Power input*	PROTHERM K	9, 12, 15, 18, 21, 24 kW
	PROTHERM D	15, 18 21, 24 kW
Maximum operating temperature of heating water		90°C
Maximum static pressure of the boiler		250 kPa
Protection		IP 41
Connection of feeding and return water		G 1"
Noisiness (1 m from the boiler, 1.5 m high)		up to 55 dB (A)
Dimensions	height	880 mm
	width	350 mm
	depth	300 mm
Weight (without water)		45 kg
Max. circulating pump delivery		60 kPa

*\* The output types can be changed according to demand*

Manufacturer reserves the right to make technical alterations connected with innovation or technical progress.

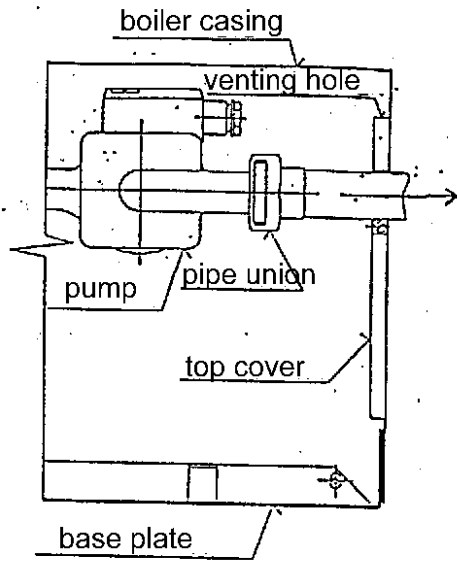

Fig. 1 - Mounting of cover sheet

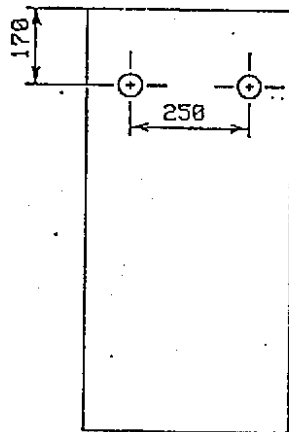
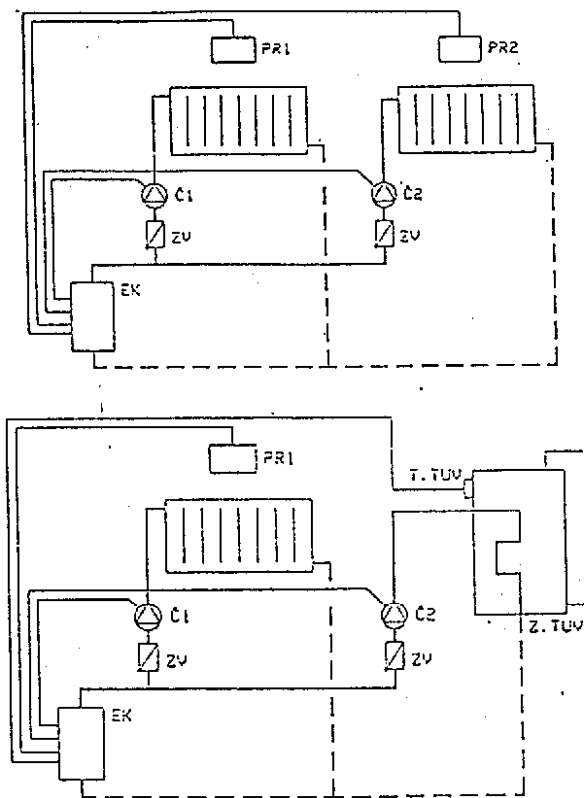
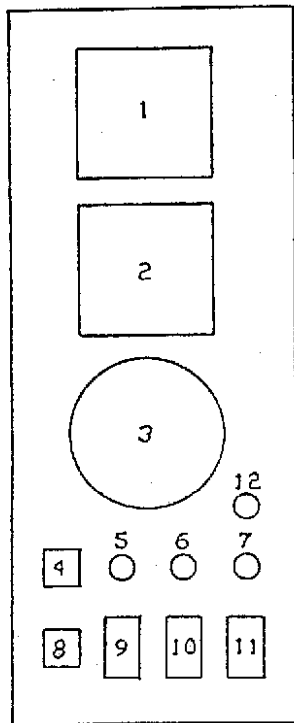

Fig. 2 - Back wall (holes for suspension)



- Č 1, Č 2     circulating pump
- EK            electrical boiler PROTHERM D
- PR 1, PR 2   room regulator
- T. TUV        HSW tank thermostat
- Z.TUV        HSW tank
- Z.V            non-return valve

Fig. 3 - Double circuit heating system (heating and heating of hot service water) with electrical boiler D



1. Manometer
2. Thermometer
3. Service thermostat
4. Signalization of connection to line voltage
5. Signalization of operation - 1st level
6. Signalization of operation - 2nd level
7. Signalization of operation 3rd level
8. Signalization of system failure
9. Operation switch - 1st level
10. Operation switch - 2nd level
11. Operation switch - 3rd level
12. Signalization of low tariff end

Fig. 4 - Control panel of electrical boiler

Connection of boiler PROTHERM K 24 kW

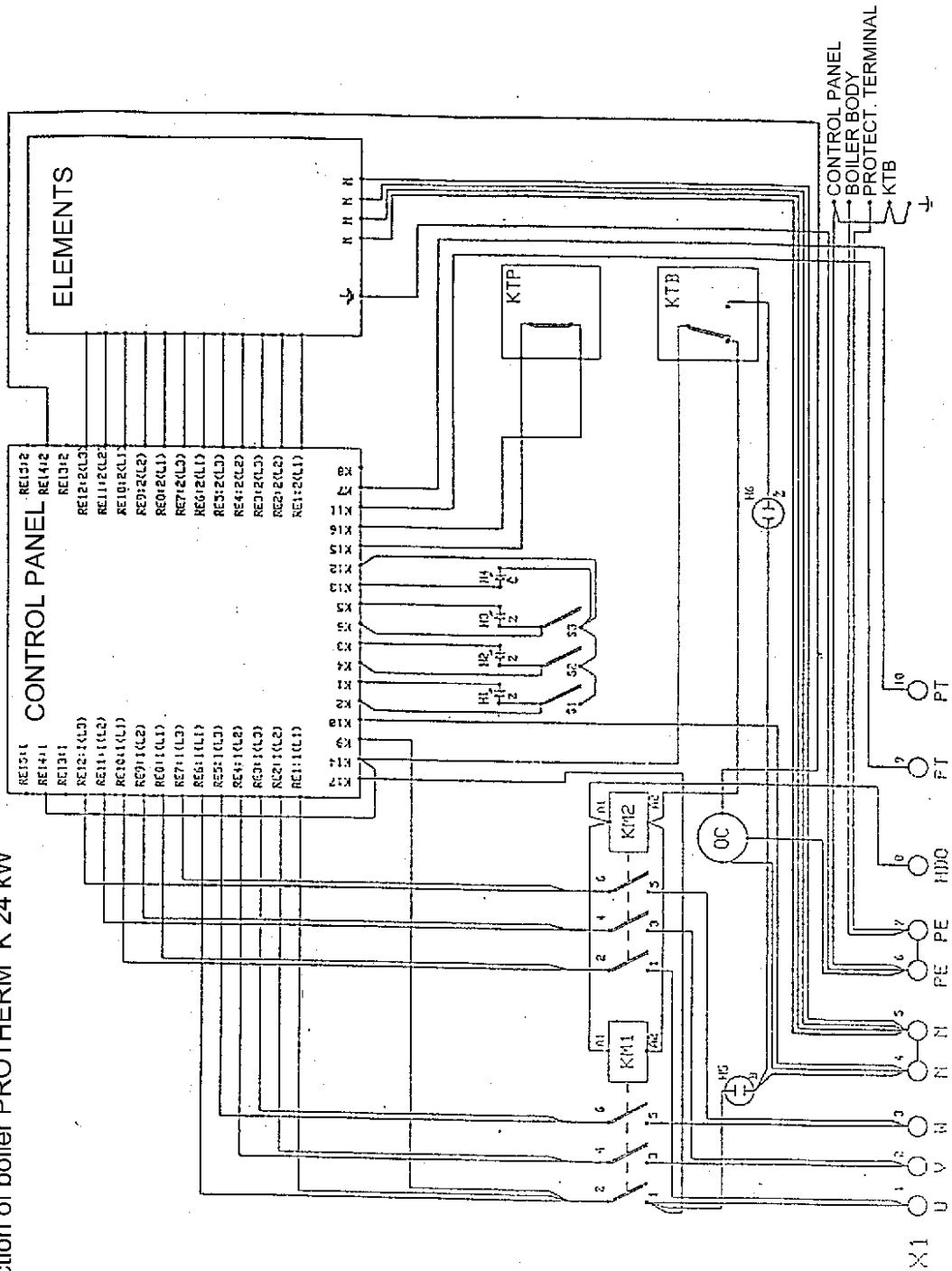

Fig. 5 - Diagram of electrical wiring of boiler PROTHERM K

Connection of boiler D 24 kW

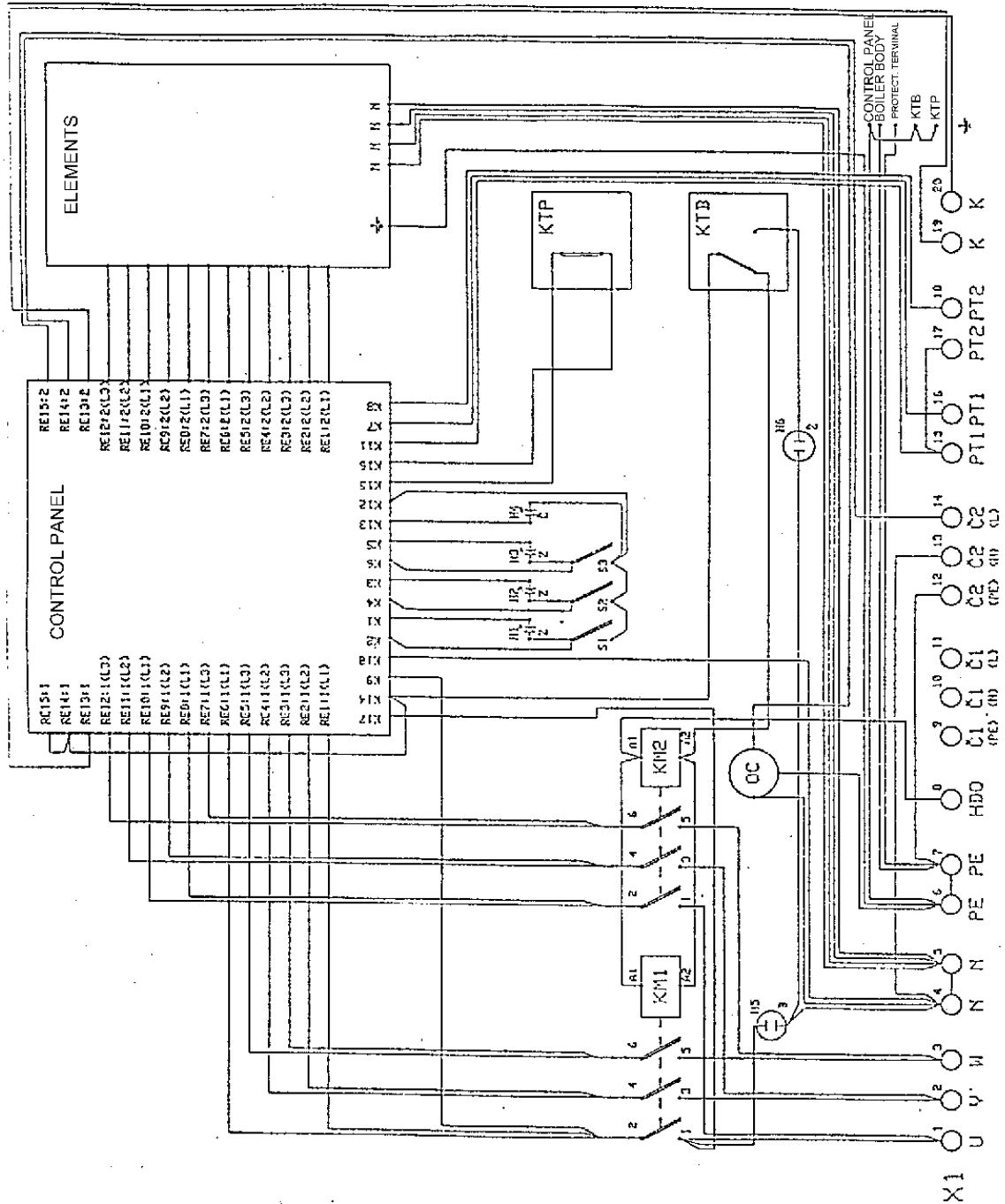

Fig. 6 - Diagram of electrical wiring of boiler PROTHERM D

F1, F3	line transformer fuses
F2	pump, contactor KM1, KM2 fuse
H1	signal of Ist output level (green)
H2	signal of IInd output level (green)
H3	signal of IIIrd output level (green)
H4	signal of HDO and operation of SS voltage source (white)
H5	signal of connection to line voltage (white)
H6	signal of overheating (yellow)
KM1, KM2	contactor
KTB	boiler safety thermostat (thermal fuse)
KTP	operation boiler thermostat
OC	circulating pump
RE1 to RE12	closing relays of heating heating elements
RE13	cascade sequencing relay
RE14, RE15	pump closing relay
S1, S2, S3	switches of output levels I, II, III
TT1 to TT4	heating elements

Fig. 7 – Legend to diagrams Fig. 5, 6, 11

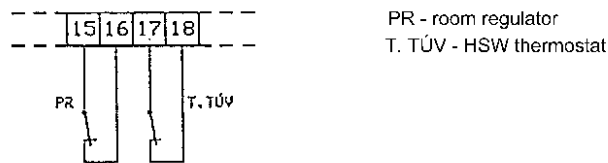

Fig. 8 - Connection of room regulator and HSW thermostat (type D)

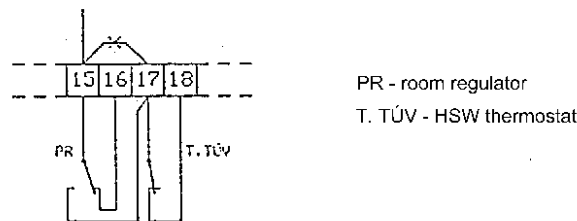

Fig. 9 - Connection of room regulator with switch-over contact (type D)

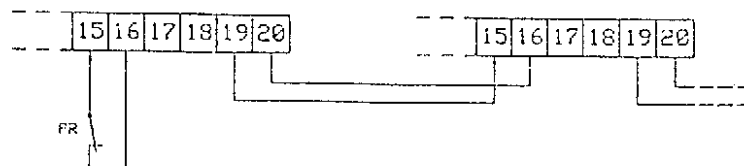

Fig. 10 - Cascade connection of boilers PROTHERM D

Diagram of boiler control panel

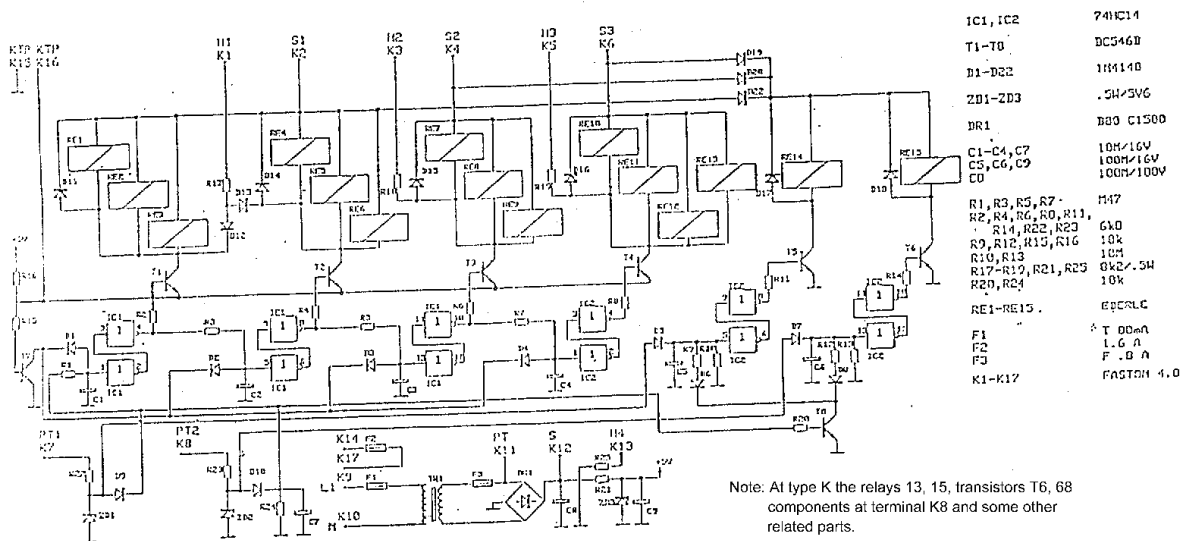

Fig. 11 - Electrical wiring of connection block board (type D, 24 kW)