



The Oventrop Quality Management System is certified to DIN-EN-ISO 9001

Technical information

Tender specification:

The Oventrop flow regulator "Hycococon Q" for a constant control of the set flow rate is a proportional regulator working without auxiliary energy.

Hidden, infinitely adjustable setting of the nominal flow (40 – 150 l/h) which is protected from unauthorised tampering. Both ports with integrated pressure test points and drain valves. Installation in the supply and the return pipe. Valve disc with soft seal.

Valve body, bonnet and regulator housing made of brass resistant to dezincification (DZR). Seals and diaphragm made of EPDM.

Max. working temperature t_s : +120°C

Min. working temperature t_s : -10°C

Max. working pressure p_s : 16 bar

Max. differential pressure: 1.5 bar

Adjustable flow range: 40 to 150 l/h

Size: DN 15, both ports female thread 1/2"

Item no.: 106 14 04

Function:

The Oventrop flow regulator "Hycococon Q" is a proportional regulator working without auxiliary energy. It is designed for use in heating or cooling systems to maintain a constant flow within a necessary proportional band. To achieve the set nominal flow, a minimum differential pressure of approx. 150 mbar is required. The required flow is set at the hidden scale. The diaphragm will hold the differential pressure at a constant rate by moving the valve disc.

Advantages:

- exact control of small flow rates
- integrated pressure test points and drain valves
- hidden, infinitely adjustable presetting which is protected from unauthorised tampering
- installation in the supply and the return pipe
- all functioning components on one level
- connection threads according to EN 10226 suitable for Oventrop compression fittings (one edge olive) for copper pipes with a diameter between 10 and 16 mm as well as Oventrop composition pipe "Copipe"

Installation and fitting of the regulator:

The Oventrop flow regulator "Hycococon Q" can be installed in either the supply or the return pipe of central heating or chilled water circuits. Installation is possible in any position provided that the direction of flow conforms with the arrow on the valve body. Before installing the regulator into the pipework, it is advisable to flush the latter thoroughly. The installation of an Oventrop "Y" type strainer is recommended.

Attention:

- arrow indicating direction of flow on the valve body must be observed
- do not use any greasing agents or oils as seals and diaphragm can be destroyed
- all installation points must be checked for leaks

Setting of the nominal value:

To set the nominal value, the diaphragm actuator is unscrewed before filling the system and the required flow rate is set at the lower setting scale. Then diaphragm actuator is remounted and tightened firmly.

Attention: Drain system first as otherwise water will escape when unscrewing the diaphragm actuator.

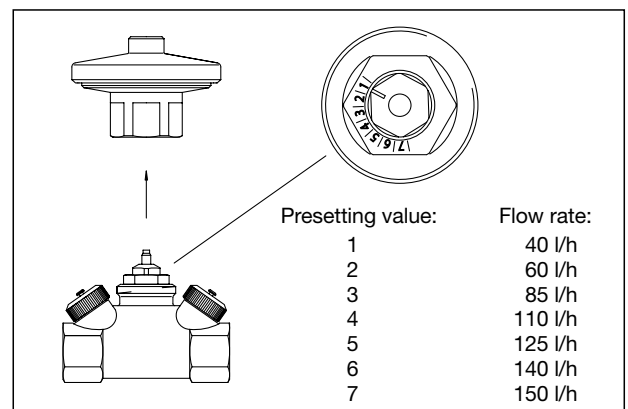
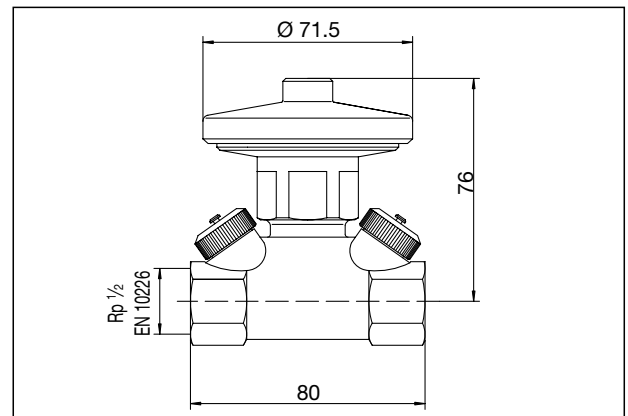









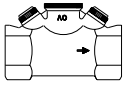

F. W. OVENTROP GmbH & Co. KG
 Paul-Oventrop-Straße 1
 D-59939 Olsberg
 Germany
 Telephone +49(0)2962 82-0
 Telefax +49(0)2962 82-450
 E-Mail mail@oventrop.de
 Internet www.oventrop.de

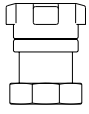
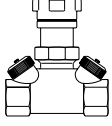
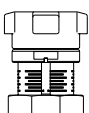
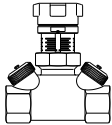
Subject to technical modification without notice.

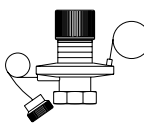
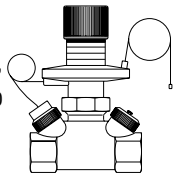
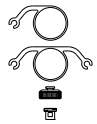
Product group 3
 ti 144-1/10/MW
 Edition 2008

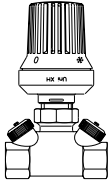
Printed on paper free from chlorine bleaching.

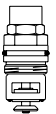
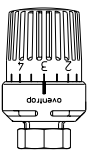
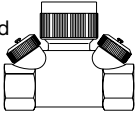
For an overview of our global presence visit www.oventrop.de.

Body	Inserts	Control unit	Valves (examples)	Accessories	
 <p>DN 15–DN 40</p>	 <p>Valve insert Item no. 106 70 65 for "Hycococon V/A", DN 15–DN 25</p> <p>Valve insert Item no. 106 70 68 for "Hycococon A", DN 32</p> <p>Valve insert Item no. 106 70 69 for "Hycococon A", DN 40</p> <p>Valve insert Item no. 106 70 66 for "Hycococon V/TM/DP", DN 32</p> <p>Valve insert Item no. 106 70 67 for "Hycococon V/TM/DP", DN 40</p>	 <p>Handwheel for Isolation DN 15–DN 25 DN 32–DN 40</p>	<p>"Hycococon A" DN 15–DN 40</p> 		
		 <p>Handwheel for control DN 15–DN 25 Item no. 106 17 93–95 DN 32–DN 40 Item no. 106 17 96–97</p>	<p>"Hycococon V" DN 15–DN 40</p> 		
		 <p>Valve insert Item no. 106 70 85 for "Hycococon TM/DP", DN 15–DN 25</p> <p>Valve insert Item no. 106 70 66 for "Hycococon V/TM/DP", DN 32</p> <p>Valve insert Item no. 106 70 67 for "Hycococon V/TM/DP", DN 40</p>	 <p>Diaphragm actuator DN 15–DN 25 Item no. 106 20 82/ 106 22 82 (including valve insert Item no. 106 70 85) DN 32–DN 40 Item no. 106 20 85/ 106 22 85</p>	<p>"Hycococon DP" DN 15–DN 40</p> 	 <p>Measuring and draining unit Item no. 106 17 90</p>
		<p>other valve inserts DN 15–DN 25</p> <p>"Series A" Item no. 118 70 69</p> <p>"Series AZ" Item no. 118 70 60</p> <p>P1 kvs 0.45 Item no. 118 60 52</p> <p>P2 kvs 1.0 Item no. 118 60 53</p> <p>Reversed supply/return Item no. 118 70 70</p> <p>"Series F" Item no. 118 73 52</p> <p>"Series KT" Item no. 114 71 69</p> <p>"Series ADV 6" Item no. 118 60 01</p> <p>"Hycococon T" and "Series AV 6" Item no. 118 70 57</p> <p>Steam insert Item no. 118 62 00</p>	 <p>Thermostats and actuators DN 15–DN 40</p> <p>Electrothermal actuators</p> <p>Electromotive actuators</p> <p>Manual heads</p> <p>Electromotive actuators System EIB System LON</p>	<p>"Hycococon T/TM" thermostatic operation DN 15–DN 25</p> 	 <p>Plug Item no. 106 17 98</p>
		 <p>Valve insert for return temperature limitation DN 15–DN 25 Item no. 102 69 81</p>	 <p>"Uni RTLH" DN 15–DN 25 Item no. 102 71 65</p>	<p>"Hycococon B" DN 15–DN 25 may be combined with further valve inserts and control units</p> 	
		 <p>"Combi LR" DN 15–DN 25 Item no. 118 70 71</p>	 <p>Spanner Control unit inside the insert</p>		

The combination summary is not valid for item no. 106 86 67 (DN 20 - "Hycococon TM" with kvs value 5.0)