

User manual  
**NIBE F470**  
Exhaust air heat pump

## Quick guide

### Navigation

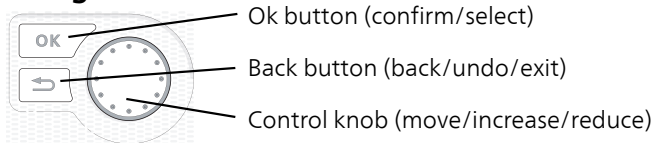

A detailed explanation of the button functions can be found on page 12.

How to scroll through menus and make different settings is described on page 16.

### Set the indoor climate

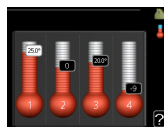
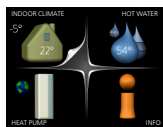

The mode for setting the indoor temperature is accessed by pressing the OK button twice, when in the start mode in the main menu. Read more about the settings on page 29.

### Increase hot water volume

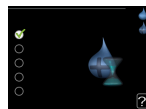
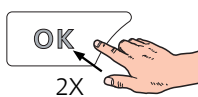
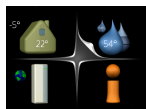
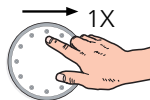

To temporarily increase the amount of hot water, first turn the control knob to mark menu 2 (water droplet) and then press the OK button twice. Read more about the settings on page 47.

### In event of disturbances in comfort

If a disturbance in comfort of any type occurs there are some measures that can be taken before you need to contact your installer. See page 71 for instructions.

# Table of Contents

<b>1</b>	<b><i>Important information</i></b>	<b>4</b>
	Installation data	4
	Safety information	5
	Serial number	6
	F470 – An excellent choice	7
<b>2</b>	<b><i>The heat pump – the heart of the house</i></b>	<b>8</b>
	Heat pump function	9
	Contact with F470	11
	Maintenance of F470	20
<b>3</b>	<b><i>F470 – at your service</i></b>	<b>29</b>
	Set the indoor climate	29
	Set the hot water capacity	47
	Get information	52
	Adjust the heat pump	56
<b>4</b>	<b><i>Disturbances in comfort</i></b>	<b>70</b>
	Info-menu	70
	Manage alarm	70
	Troubleshooting	71
<b>5</b>	<b><i>Technical data</i></b>	<b>75</b>
<b>6</b>	<b><i>Glossary</i></b>	<b>76</b>
	<b><i>Item register</i></b>	<b>81</b>
	<b><i>Contact information</i></b>	<b>83</b>

# 1 Important information

## Installation data

Product	F470
Serial number	
Installation date	
Installer	

No.	Name	Fact. sett.	Set
1.1	temperature (curve offset)	0	
1.9.1	heating curve (curve slope)	9	
1.9.3	min. flow line temp.	20	
5.1.5	fan sp. exhaust air (normal)	65%	
5.1.6	fan sp. supply air (normal)	45%	

✓	Accessories
	Extra shunt ECS 40/41
	Room unit RMU 40
	Communications module SMS 40
	Docking kit DEH 40/DEH 41

### Serial number must always be given

Certification that the installation is carried out according to instructions in the accompanying installer manual and applicable regulations.

Date \_\_\_\_\_ Signed \_\_\_\_\_

## Safety information

This appliance can be used by children aged from 8 years and above and persons with reduced physical, sensory or mental capabilities or lack of experience and knowledge if they have been given supervision or instruction concerning use of the appliance in a safe way and understand the hazards involved. Children shall not play with the appliance. Cleaning and user maintenance shall not be made by children without supervision.

Rights to make any design or technical modifications are reserved.

©NIBE 2017.



### NOTE

F470 must be installed via an isolator switch with a minimum breaking gap of 3 mm.



### NOTE

If the supply cable is damaged, only NIBE, its service representative or similar authorised person may replace it to prevent any danger and damage.



### NOTE

Do not start the heat pump, if there is a risk that the water in the system has frozen.

## Symbols



### NOTE

This symbol indicates danger to person or machine .



### Caution

This symbol indicates important information about what you should observe when maintaining your installation.



### TIP

This symbol indicates tips on how to facilitate using the product.

## Serial number

The serial number can be found at the bottom right of the front cover and in the info menu (menu 3.1).

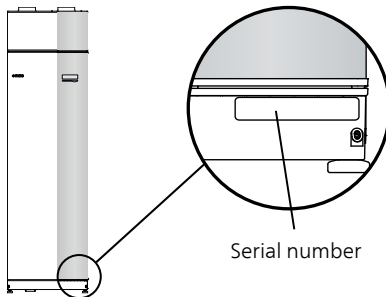

### Caution

You need the product's (14 digit) serial number for servicing and support.

## F470 – An excellent choice

F470 is part of a new generation of heat pumps, which have been introduced to supply your home with inexpensive and environmentally friendly heating. Heat production is safe and economical with integrated hot water heater, immersion heater, circulation pump and control system.

The heat pump can be connected to an optional low temperature heat distribution system. e.g. radiators, convectors or under floor heating. It is also prepared for connection to several different products and accessories, e.g. extra water heater and climate systems with different temperatures.

F470 is equipped with a control computer for good comfort, good economy and safe operation. Clear information about status, operation time and all temperatures in the heat pump are shown on the large and easy to read display. This means, for example, that external unit thermometers are not necessary.

### **Excellent properties for F470:**

- ***Integrated water heater***

There is a water heater integrated in the heat pump, which is insulated with environmentally friendly cellular plastic for minimal heat loss.

- ***Scheduling the indoor comfort and hot water***

Heating and hot water as well as ventilation, can be scheduled for each day of the week or for longer periods (vacation).

- ***Display with user instructions***

The heat pump has a large display with easy-to-understand menus that facilitate setting a comfortable climate.

- ***Simple troubleshooting***

In the event of a fault, the heat pump display shows what happened and the actions to be taken.

# 2 The heat pump – the heart of the house

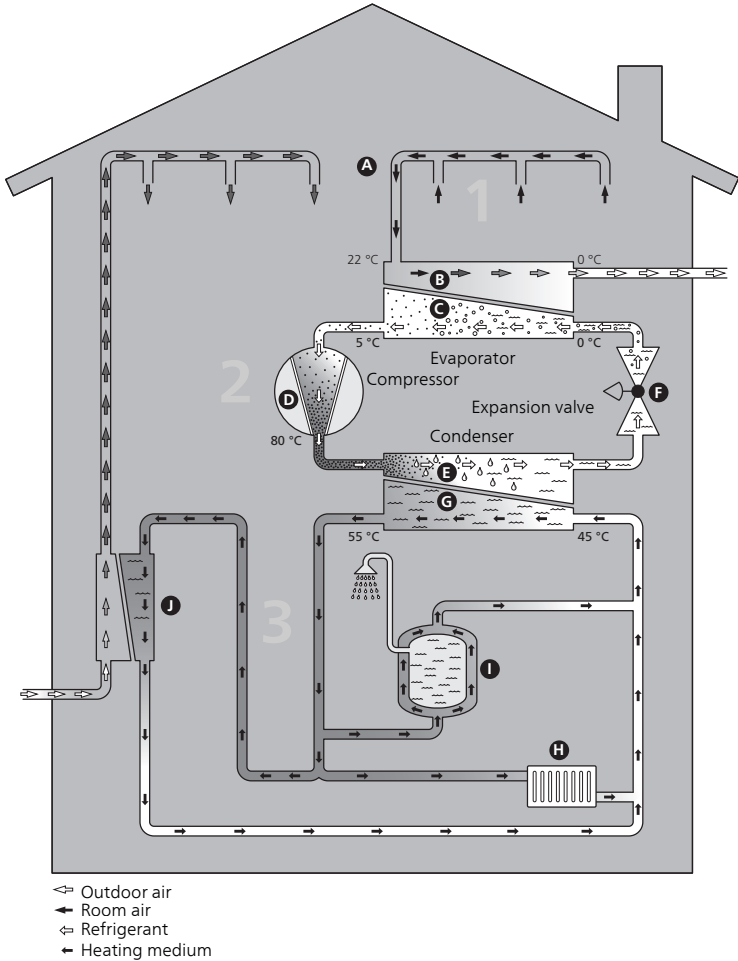



# Heat pump function

An exhaust air heat pump makes use of the heat in the building's ventilation air to heat up the accommodation. The conversion of the ventilation air's energy to accommodation heating is done in three different circuits. From the outgoing ventilation air (1), free heating energy is retrieved from the accommodation and transported to the heat pump. The heat pump increases the retrieved heat's low temperature to a high temperature in the refrigerant circuit, (2). The heat is distributed around the building in the heating medium circuit (3).

## Ventilation air

- A The hot air is transferred from the rooms to the heat pump via the house ventilation system.
- B The fan then routes the air to the heat pump's evaporator. Here, the air releases the heating energy and the air's temperature drops significantly. The cold air is then blown out of the house.

## Refrigerant circuit

- C A liquid, a refrigerant, circulates in a closed system in the heat pump which also passes the evaporator. The refrigerant has a very low boiling point. In the evaporator the refrigerant receives the heat energy from the ventilation air and starts to boil.
- D The gas that is produced during boiling is routed into an electrically powered compressor. When the gas is compressed, the pressure increases and the gas's temperature increases considerably, from approx. 5 °C to approx. 80°C.
- E From the compressor, the gas is forced into a heat exchanger, condenser, where it releases heat energy to the heat pump's heating section, whereupon the gas is cooled and condenses to liquid form again.
- F As the pressure is still high, the refrigerant can pass an expansion valve, where the pressure drops so that the refrigerant returns to its original temperature. The refrigerant has now completed a full cycle. It is routed to the evaporator again and the process is repeated.

## Heat medium circuit

- G The heat energy that the refrigerant produces in the condenser is retrieved by the climate system's water, heating medium, which is heated to 35 °C (supply temperature).
- H The hot water circulates in a closed system and is pumped out to the radiators/heating coils of the house.
- I The heat pump's integrated water heater is in the heating section. The heating medium heats the hot water.

The temperatures are only examples and may vary between different installations and time of year.

### **Pre-heated supply air**

- J** The hot water also circulates to the heat pump's supply air coil. The supply air coil heats up the air that is blown out into the rooms that have supply air inlets.

The temperatures are only examples and may vary between different installations and time of year.

# Contact with F470

## External information

When the heat pump door is closed, information can be received via an information window and a status lamp.

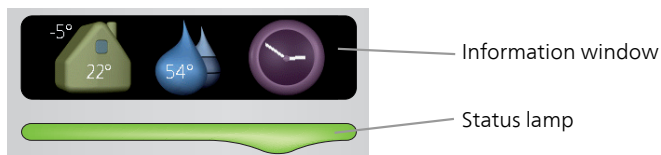

### ***Information window***

The information window shows part of the display that is on the display unit (located behind the door to the heat pump). The information window can display different type of information, e.g. temperatures, clock, etc.

You determine what is to be displayed in the information window. Your own combination of information is entered using the display unit. This information is specific to the information window and disappears when the heat pump door is opened.

Instructions on how to set the information window can be found on page 64.

### ***Status lamp***

The status lamp indicates the status of the heat pump: continuous green light during normal function, continuous yellow light during activated emergency mode or continuous red light in the event of a deployed alarm.

Alarm management is described on page 70.

## Display unit

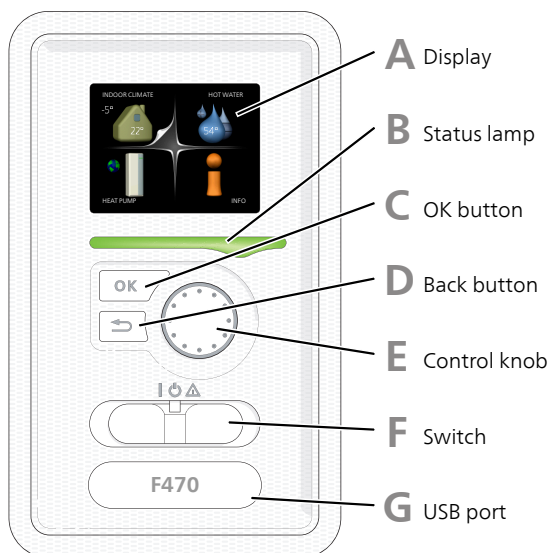

There is a display unit behind the heat pump door, which is used to communicate with F470. Here you:

- switch on, switch off or set the heat pump in emergency mode.
- sets the indoor climate and hot water as well as adjusts the heat pump to your needs.
- receive information about settings, status and events.
- see different types of alarms and receive instructions about how they are to be rectified.

### **A** *Display*

Instructions, settings and operational information are shown on the display. You can easily navigate between the different menus and options to set the comfort or obtain the information you require.

### **B** *Status lamp*

The status lamp indicates the status of the heat pump. It:

- lights green during normal operation.
- lights yellow in emergency mode.
- lights red in the event of a deployed alarm.

## C

### **OK button**

The OK button is used to:

- confirm selections of sub menus/options/set values/page in the start guide.

## D

### **Back button**

The back button is used to:

- go back to the previous menu.
- change a setting that has not been confirmed.

## E

### **Control knob**

The control knob can be turned to the right or left. You can:

- scroll in menus and between options.
- increase and decrease the values.
- change page in multiple page instructions (for example help text and service info).

## F

### **Switch**

The switch assumes three positions:

- On (I)
- Standby (⏻)
- Emergency mode (⚠)

Emergency mode must only be used in the event of a fault on the heat pump. In this mode, the compressor and fans switch off and the immersion heater engages. The heat pump display is not illuminated and the status lamp illuminates yellow.

The automatic heating control system is not operational, so manual shunt operation is required (see page 25).

## G

### **USB port**

The USB port is hidden beneath the plastic badge with the product name on it.

The USB port is used to update the software.

Visit <http://www.nibeuplink.com> and click the "Software" tab to download the latest software for your installation.

## Menu system

When the door to the heat pump is opened, the menu system's four main menus are shown in the display as well as certain basic information.

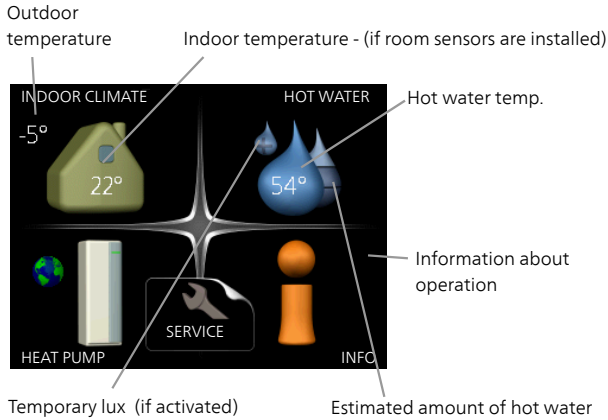

Menu 1

### ***INDOOR CLIMATE***

Setting and scheduling the indoor climate. See page 29.

Menu 2

### ***HOT WATER***

Setting and scheduling hot water production. See page 47.

Menu 3

### ***INFO***

Display of temperature and other operating information and access to the alarm log. See page 52.









Menu 4

### ***HEAT PUMP***

Setting time, date, language, display, operating mode etc. See page 56.

## Symbols in the display

The following symbols can appear in the display during operation.

Symbol	Description
	This symbol appears by the information sign if there is information in menu 3.1 that you should note.
	<p>These two symbols indicate whether the compressor or addition is blocked in F470.</p> <p>These can, for example, be blocked depending on which operating mode is selected in menu 4.2, if blocking is scheduled in menu 4.9.5 or if an alarm has occurred that blocks one of them.</p> <ul style="list-style-type: none"> <li> Blocking the compressor.</li> <li> Blocking additional heat.</li> </ul>
	This symbol appears if periodic increase or lux mode for the hot water is activated.
	This symbol indicates whether "holiday setting" is active in 4.7.
	This symbol indicates whether F470 has contact with Uplink.
	This symbol indicates the actual speed of the fan if the speed has changed from the normal setting.
	This symbol indicates whether solar heating is active. Accessory needed.

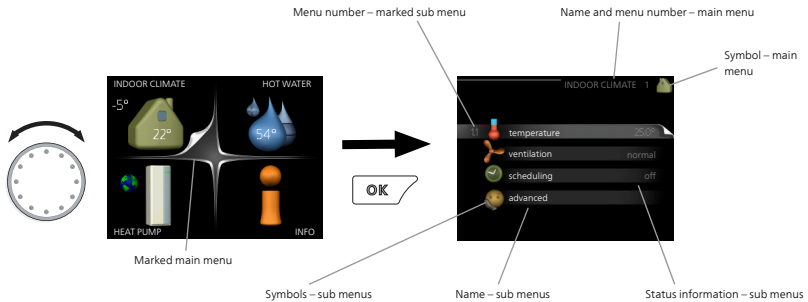

## Operation

To move the cursor, turn the control knob to the left or the right. The marked position is white and/or has a turned up tab.





## Selecting menu

To advance in the menu system select a main menu by marking it and then pressing the OK button. A new window then opens with sub menus.

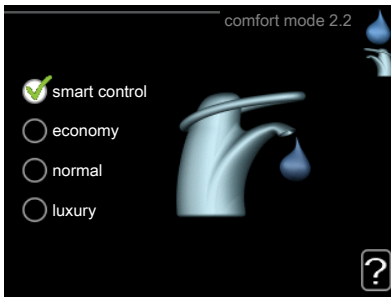

Select one of the sub menus by marking it and then pressing the OK button.

## Selecting options



In an options menu the current selected option is indicated by a green tick. 

To select another option:

1. Mark the applicable option. One of the options is pre-selected (white). 
2. Press the OK button to confirm the selected option. The selected option has a green tick. 



## Setting a value



Values to be changed

To set a value:

1. Mark the value you want to set using the control knob.
2. Press the OK button. The background of the value becomes green, which means that you have accessed the setting mode.
3. Turn the control knob to the right to increase the value and to the left to reduce the value.
4. Press the OK button to confirm the value you have set. To change and return to the original value, press the Back button.

01

01

04

04

## Use the virtual keyboard

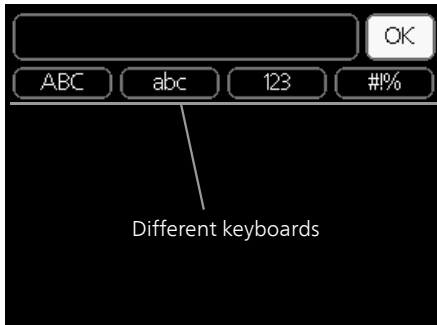

In some menus where text may require entering, a virtual keyboard is available.

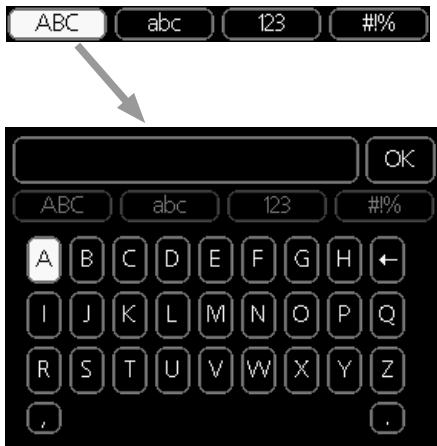

Depending on the menu, you can gain access to different character sets which you can select using the control knob. To change character table, press the Back button. If a menu only has one character set the keyboard is displayed directly.

When you have finished writing, mark "OK" and press the OK button.

## ***Scroll through the windows***

A menu can consist of several windows. Turn the control knob to scroll between the windows.

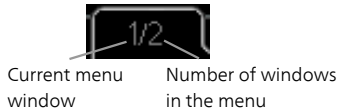

## **Scroll through the windows in the start guide**



Arrows to scroll through window in start guide

1. Turn the control knob until one of the arrows in the top left corner (at the page number) has been marked.
2. Press the OK button to skip between the steps in the start guide.

## ***Help menu***



In many menus there is a symbol that indicates that extra help is available.

To access the help text:

1. Use the control knob to select the help symbol.
2. Press the OK button.

The help text often consists of several windows that you can scroll between using the control knob.

# Maintenance of F470

## Regular checks

Your heat pump requires minimal maintenance after commissioning. On the other hand, it is recommended that you check your installation regularly.

If something unusual occurs, messages about the malfunction appear in the display in the form of different alarm texts. See alarm management on page 70.

## Service hatch

The vent valves etc. are behind the service hatch. Remove the hatch by pulling it towards you.

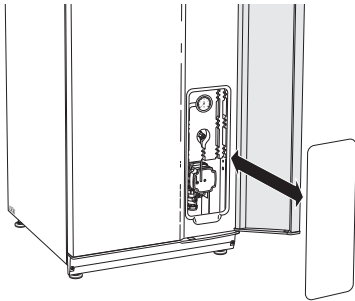

## Cleaning the ventilation devices

The building's ventilation devices should be cleaned regularly with, for example, a small brush to maintain the correct ventilation.

The device settings must not be changed.

Also check the outdoor air's intake grilles on the house facade and clean if necessary.

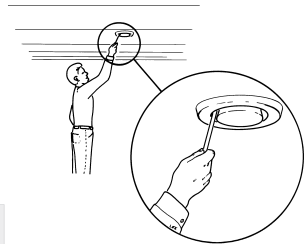

### NOTE

If you take down more than one ventilation device for cleaning, do not mix them up.

## ***Cleaning the air filter***

Clean the F470's air filters regularly, how often depends on the amount of dust in the ventilation air. Select what is most suitable for your heat pump.

You will receive a reminder about filter cleaning in the display. The default setting for the reminder is every three months, however, if the power to F470 is interrupted the countdown begins again.

1. Switch off the heat pump.
2. Remove the upper front cover by pulling straight out.
3. Pull out the filter cassette.
4. Take out the filter and shake/vacuum off any dirt. Do not use water or other liquids for cleaning.
5. Check that the filter is not damaged.
6. Carry out assembly in reverse order.

Even if the filter appears clean, dirt collects in it and this affects the efficiency of the filter. Therefore, replace it after 2 years. New filters can be ordered via the installer.

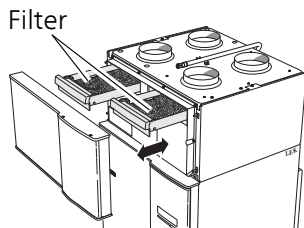

## **Check pressure**

F470 has a pressure gauge which shows the heating system pressure. The pressure should be between 0.5 and 1.5 bar, but varies during temperature changes. If the pressure drops to 0 or rises to 2.5 frequently, contact your installer for troubleshooting.

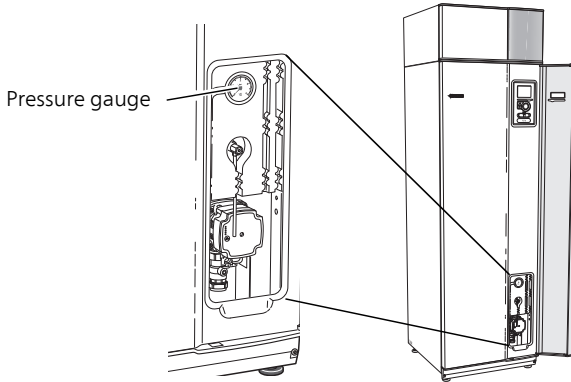

## **Safety valves**

F470 has two safety valves, one for the hot water heater and one for the climate system.

The water heater's safety valve sometimes releases a little water after hot water usage. This is because the cold water, which enters the water heater, expands when heated causing the pressure to rise and the safety valve to open. The climate system's safety valve must be completely closed and must not normally release any water.

The function of the safety valves must be checked regularly. The valves are accessed via the service hatch. Perform checks as follows:

1. Open the valve by turning the knob anti-clockwise carefully.
2. Check that water flows through the valve.
3. Close the valve by releasing it. If it does not close automatically when released, turn it anti-clockwise slightly.
4. The climate system may need to be refilled after checking the safety valve, see the section "Filling the climate system".

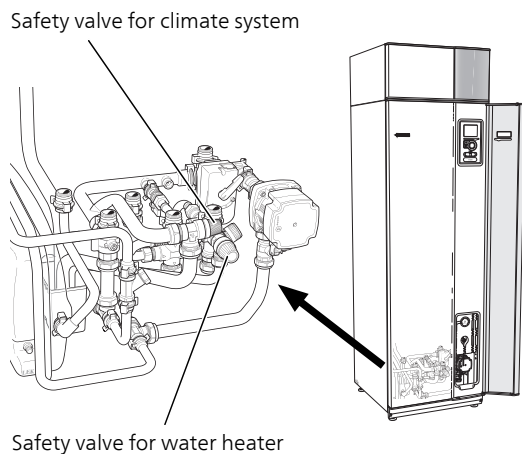

### ***Cleaning the overflow cup***

Condensation forms when the heat pump is working. This condensation is led off and collected in an overflow cup. In addition to water, a certain amount of dust and particles also collect in the overflow cup.

Regularly check that the overflow cup and any floor drains are not blocked; water must be able to run through freely. Clean, if necessary.

## ***Filling the climate system***

If the pressure is too low, increase as follows:

1. Open the filler valve. The heating section and the rest of the climate system are filled with water.
2. After a while the pressure rises on the pressure gauge. When it is approx. 1.0 bar close the filler valve.

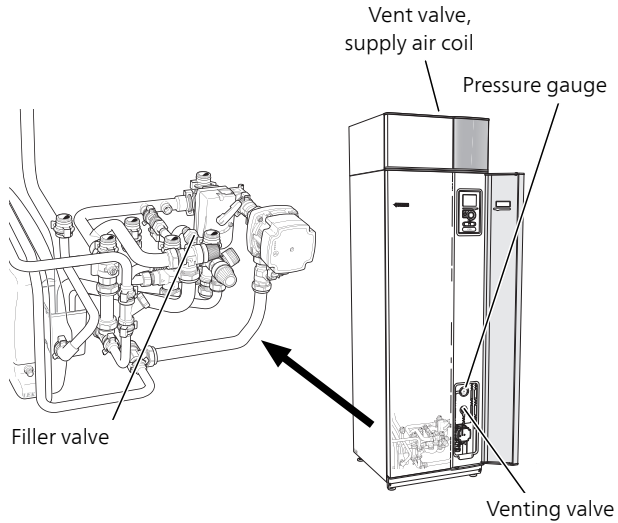



## Venting the climate system

In event of repeated filling of the climate system or if bubbling sounds are heard from the heat pump the system may need venting. This is carried out as follows:

1. Turn off the power supply to the heat pump.
2. Vent the heat pump via the vent valve and the rest of the climate system via the relevant vent valves.
3. Vent the supply air battery via its vent valve.

### NOTE

The vent pipe from the container must be drained of water before air can be released. This means that the system is not necessarily bled despite the flow of water when the bleed valve is opened.

Therefore hold the vent valve open for at least 5 seconds.

## Emergency mode

The automatic heating control system is not operational, so manual shunt operation is required. This is done by turning the adjustment screw on the shunt motor to "manual mode" and then turning the shunt knob to the desired position.

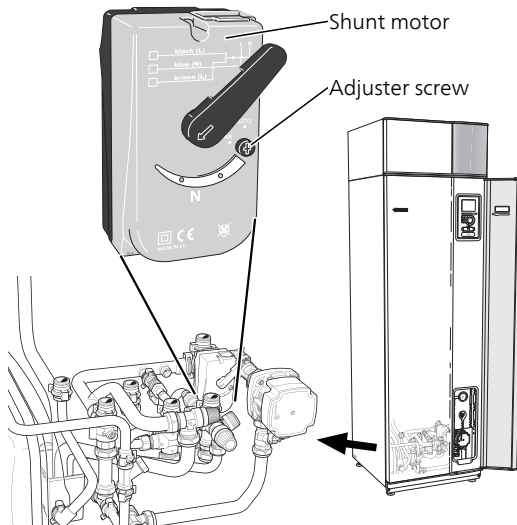

## Saving tips

Your heat pump installation produces heat and hot water. This occurs via the control settings you made.

Factors that affect the energy consumption are, for example, indoor temperature, hot water consumption, the insulation level of the house and whether the house has many large window surfaces. The position of the house, e.g. wind exposure is also an affecting factor.

Even the house ventilation affects the energy consumption. It is therefore important to perform a ventilation adjustment shortly after installing the heat pump. At ventilation adjustment, a ventilation technician sets the house ventilation device and the fans in F470, according to the projected values of the house. The ventilation technician also adjusts the supply air temperature so that it is a few degrees below the desired room temperature.



**TIP**

Check the supply air temperature on a cold day. If the setting was made on a hot day, the ventilation may require adjustment. If so, contact your installer.

Also remember:

- During the adjustment period (winter time) all thermostat valves should be fully open. The heat pump's heating settings are then adjusted so that the correct indoor temperature is obtained, in most rooms, regardless of the outdoor temperature. In rooms where a lower temperature is required, the thermostat valves are lowered to the desired level. After a few months, the remaining thermostats can be lowered slightly to avoid an increase of the room temperature due to solar radiation, stove heat etc. Further reductions may be required later on.
- You can lower the temperature when away from the house by scheduling "holiday setting" in menu 4.7. See page 65 for instructions.
- You can reduce the ventilation speed when you are away by entering a schedule in menu 1.3.3. See page 34 for instructions.
- If you activate "Hot water Economy", less energy is used.

## Power consumption

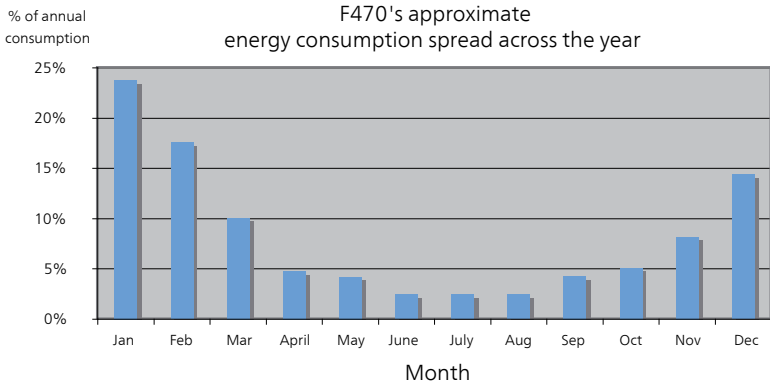

Increasing the indoor temperature one degree increases the energy consumption by approx. 5%.

## Domestic electricity

In the past it has been calculated that an average Swedish household has an approximate annual consumption of 5000 kWh domestic electricity/year. In today's society it is usually between 6000-12000 kWh/year.

Equipment	Normal Output (W)		Appr. ann. consumption (kWh)
	Operation	Standby	
TV (Operation: 5 h/day, Standby: 19 h/day)	200	2	380
Digital box (Operation: 5 h/day, Standby: 19 h/day)	11	10	90
DVD (Operation: 2 h/week)	15	5	45
TV games console (Operation: 6 h/week)	160	2	67
Radio/stereo (Operation: 3 h/day)	40	1	50
Computer incl. screen (Operation: 3 h/day, standby 21 h/day)	100	2	120
Bulb (Operation 8 h/day)	60	-	175
Spot light, Halogen (Operation 8 h/day)	20	-	58
Cooling (Operation: 24 h/day)	100	-	165

Equipment	Normal Output (W)		Appr. ann. consumption (kWh)
Freezer (Operation: 24 h/day)	120	-	380
Stove, hob (Operation: 40 min/day)	1500	-	365
Stove, oven (Operation: 2 h/week)	3000	-	310
Dishwasher, cold water connection (Operation 1 time/day)	2000	-	730
Washing machine (Operation: 1 times/day)	2000	-	730
Tumble drier (Operation: 1 times/day)	2000	-	730
Vacuum cleaner (Operation: 2 h/week)	1000	-	100
Engine block heater (Operation: 1 h/day, 4 months a year)	400	-	50
Passenger compartment heater (Operation: 1 h/day, 4 months a year)	800	-	100

These values are approximate example values.

Example: A family with 2 children live in a house with 1 flat-screen TV, 1 digital box, 1 DVD player, 1 TV games console, 2 computers, 3 stereos, 2 bulbs in the WC, 2 bulbs in the bathroom, 4 bulbs in the kitchen, 3 bulbs outside, a washing machine, tumble drier, fridge, freezer, oven, vacuum cleaner, engine block heater = 6240 kWh domestic electricity/year

### Energy meter

Check the accommodation's energy meter regularly, preferably once a month. This will indicate any changes in power consumption.

Newly built houses usually have twin energy meters, use the difference to calculate your domestic electricity.

### New builds

Newly built houses undergo a drying out process for a year. The house can then consume significantly more energy than it would thereafter. After 1-2 years the heating curve should be adjusted again, as well as the offset heating curve and the building's thermostat valves, because the heating system, as a rule, requires a lower temperature once the drying process is complete.

# 3 F470 – at your service

## Set the indoor climate

### Overview

#### Sub-menus

For the menu **INDOOR CLIMATE** there are several sub-menus. Status information for the relevant menu can be found on the display to the right of the menus.

**temperature** Setting the temperature for the climate system. The status information shows the set values for the climate system.

**ventilation** Setting the fan speed. The status information shows the selected setting.

**scheduling** Scheduling heating and ventilation. Status information "set" is displayed if you set a schedule but it is not active now, "holiday setting" is displayed if the vacation schedule is active at the same time as the schedule (the vacation function is prioritised), "active" displays if any part of the schedule is active, otherwise it displays "off".

**advanced** Setting of heat curve, adjusting with external contact, minimum value for supply temperature, room sensor and night cooling.

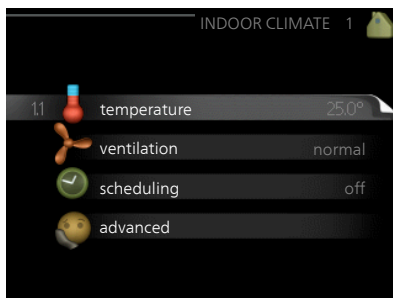

Menu  
1.1

### temperature

#### Set the temperature (with room sensors installed and activated):

##### heating

Setting range: 5 – 30 °C

Default value: 20

The value in the display appears as a temperature in °C if the climate system is controlled by a room sensor.

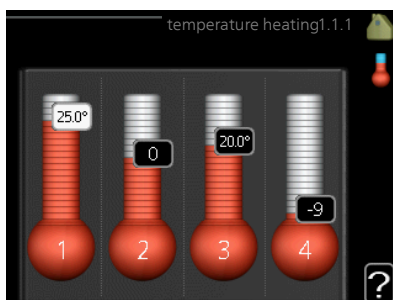



### Caution

A slow heat-releasing heating system, such as for example, underfloor heating, may not be suitable for control using the heat pump's room sensor.

To change the room temperature, use the control knob to set the desired temperature in the display. Confirm the new setting by pressing the OK button. The new temperature is shown on the right-hand side of the symbol in the display.

### ***Setting the temperature (without room sensors activated):***

Setting range: -10 to +10

Default value: -1

The display shows the set values for heating (curve offset). To increase or reduce the indoor temperature, increase or reduce the value on the display.

Use the control knob to set a new value. Confirm the new setting by pressing the OK button.

The number of steps the value has to be changed to achieve a degree change of the indoor temperature depends on the heating installation. One step is usually enough but in some cases several steps may be required.

Setting the desired value. The new value is shown on the right-hand side of the symbol in the display.



### Caution

An increase in the room temperature can be slowed by the thermostats for the radiators or under floor heating. Therefore, open the thermostats fully, except in those rooms where a cooler temperature is required, e.g. bedrooms.

If the exhaust air temperature falls below 16 °C the compressor is blocked and electric additional heat is permitted. Heat is not recovered from the exhaust air when the compressor is blocked.



### TIP

Wait 24 hours before making a new setting, so that the room temperature has time to stabilise.

If it is cold outdoors and the room temperature is too low, increase the curve slope in menu 1.9.1.1 by one increment.

If it is cold outdoors and the room temperature is too high, reduce the curve slope in menu 1.9.1.1 by one increment.

If it is warm outdoors and the room temperature is too low, increase the value in menu 1.1.1 by one increment.

If it is warm outdoors and the room temperature is too high, reduce the value in menu 1.1.1 by one increment.

## Menu 1.2

### ventilation

Setting range: normal and speed 1-4

Default value: normal

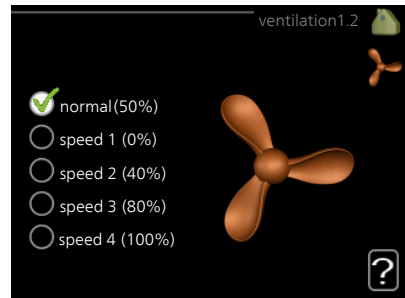

The ventilation in the accommodation can be temporarily increased or reduced here.

When you have selected a new speed a clock starts a count down. When the time has counted down the ventilation speed returns to the normal setting.

If necessary, the different return times can be changed in menu 1.9.6.

The fan speed is shown in brackets (in percent) after each speed alternative.



### TIP

If longer time changes are required use the holiday function or scheduling.

Menu  
1.3

## scheduling

In the menu **scheduling** indoor climate (heating/ventilation) is scheduled for each weekday.

You can also schedule a longer period (vacation) in menu 4.7.

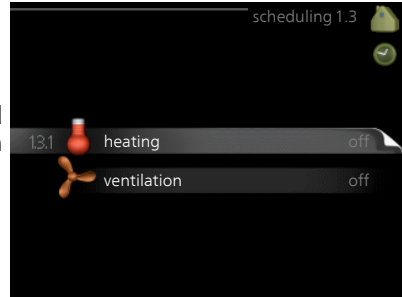

Menu  
1.3.1

## heating

Increases or decreases in the accommodation temperature can be scheduled here for up to three time periods per day. If a room sensor is installed and activated the desired room temperature (°C) is set during the time period. Without an activated room sensor the desired change is set (of setting in menu 1.1). One step is usually enough to change the room temperature by one degree, but in some cases several steps may be required.

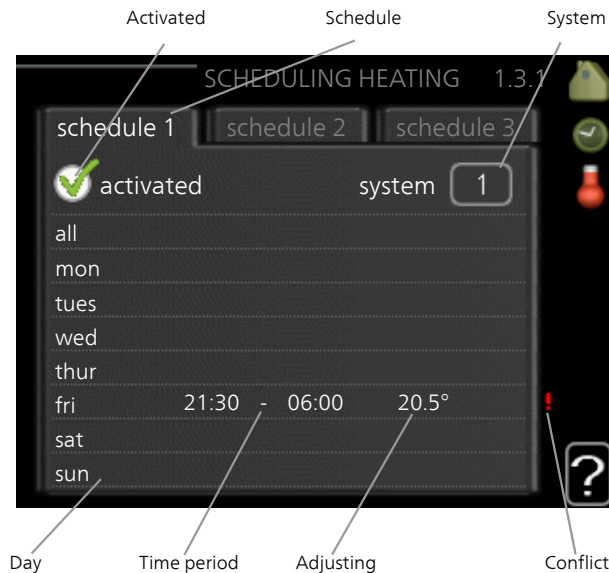

**Schedule:** The schedule to be changed is selected here.

**Activated:** Scheduling for the selected period is activated here. Set times are not affected at deactivation.



**System:** Which climate system the schedule is for is selected here. This alternative is only displayed if more than one climate system is present.

**Day:** Select which day or days of the week the schedule is to apply to here. To remove the scheduling for a particular day, the time for that day must be reset by setting the start time to the same as the stop time. If the line "all" is used, all days in the period are set for these times.

**Time period:** The start and stop time for the selected day for scheduling are selected here.

**Adjusting:** How much the heating curve is to be offset in relation to menu 1.1 during scheduling is set here. If the rooms sensor is installed the desired room temperature is set in °C.

**Conflict:** If two settings conflict with each other a red exclamation mark is displayed.



**TIP**

If you wish to set similar scheduling for every day of the week start by filling in "all" and then changing the desired days.



**TIP**

Set the stop time earlier than the start time so that the period extends beyond midnight. Scheduling then stops at the set stop time the day after.

Scheduling always starts on the date that the start time is set for.



**Caution**

Changes of temperature in accommodation take time. For example, short time periods in combination with underfloor heating will not give a noticeable difference in room temperature.

If the exhaust air temperature falls below 16 °C the compressor is blocked and electric additional heat is permitted. When the compressor is blocked heat is not recovered from the exhaust air.

Menu  
1.3.3

## ventilation

Increases or decreases in the ventilation to the accommodation can be scheduled here for up to two time periods per day.

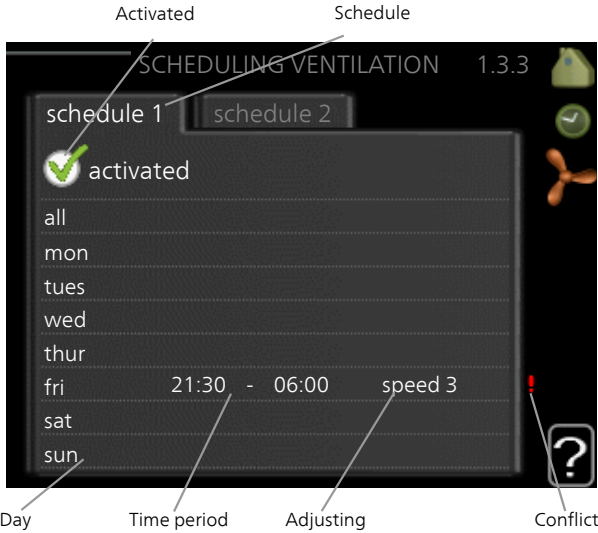

**Schedule:** The schedule to be changed is selected here.

**Activated:** Scheduling for the selected period is activated here. Set times are not affected at deactivation.

**Day:** Select which day or days of the week the schedule is to apply to here. To remove the scheduling for a particular day, the time for that day must be reset by setting the start time to the same as the stop time. If the line "all" is used, all days in the period are set for these times.

**Time period:** The start and stop time for the selected day for scheduling are selected here.

**Adjusting:** The desired fan speed is set here.

**Conflict:** If two settings conflict with each other a red exclamation mark is displayed.



**TIP**

If you wish to set similar scheduling for every day of the week start by filling in "all" and then changing the desired days.



### TIP

Set the stop time earlier than the start time so that the period extends beyond midnight. Scheduling then stops at the set stop time the day after.

Scheduling always starts on the date that the start time is set for.



### Caution

A significant change over a longer period of time may cause poor indoor environment and worse operating economy.

Menu  
1.9

## advanced

Menu **advanced** has orange text and is intended for the advanced user. This menu has several sub-menus.

**heating curve** Setting the heating curve slope.

**external adjustment** Setting the heat curve offset when the external contact is connected.

**min. flow line temp.** Setting minimum permitted flow line temperature.

**room sensor settings** Settings regarding the room sensor.

**fan return time** Fan return time settings in the event of temporary ventilation speed change.

**own curve** Setting own heat curve.

**point offset** Setting the offset of the heating curve at a specific outdoor temperature.

**night cooling** Setting night cooling.

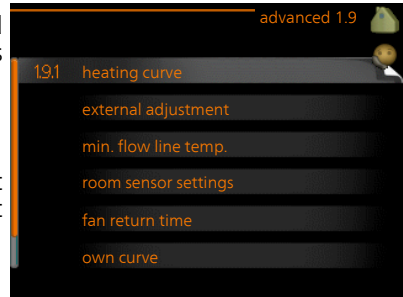

## heating curve

### heating curve

Setting range: 0 - 15

Default value: 5

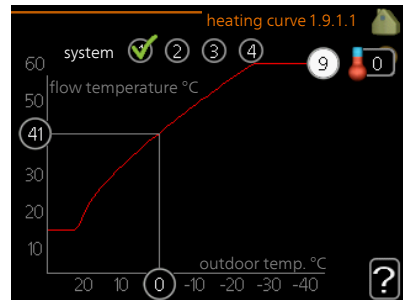

The prescribed heating curve for your house can be viewed in the menu **heating curve**. The task of the heating curve is to give an even indoor temperature, regardless of the outdoor temperature, and thereby energy efficient operation. It is from this heating curve that the heat pump's control computer determines the temperature of the water to the heating system, supply temperature, and therefore the indoor temperature. Select the heating curve and read off how the supply temperature changes at different outdoor temperatures here.

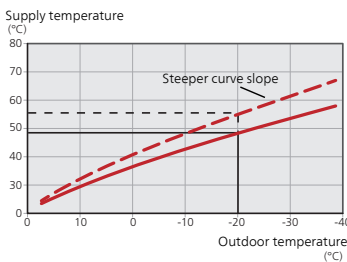

### Curve coefficient

The slope of the heating curve indicates how many degrees the supply temperature is to be increased/reduced when the outdoor temperature drops/increases. A steeper slope means a higher supply temperature at a certain outdoor temperature.

The optimum slope depends on the climate conditions in your location, if the house has radiators or under floor heating and how well insulated the house is.

The heating curve is set when the heating installation is installed, but may need adjusting later. Thereafter the heating curve should not need further adjustment.



### Caution

In the event of making fine adjustments for the indoor temperature, the heat curve must be offset up or down instead, this is done in menu 1.1 **temperature**.

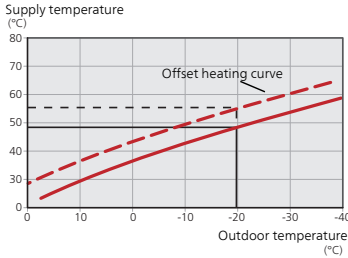

### Curve offset

An offset of the heating curve means that the supply temperature changes by the same amount for all the outdoor temperatures, e.g. that a curve offset of +2 steps increases the supply temperature by 5 °C at all outdoor temperatures.

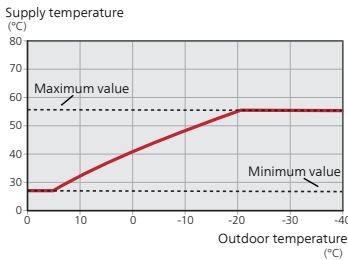

### Flow line temperature—maximum and minimum values

Because the flow line temperature cannot be calculated higher than the set maximum value or lower than the set minimum value the heating curve flattens out at these temperatures.



### Caution

Underfloor heating systems are normally **max flow line temperature** set between 35 and 45 °C.

Check the max temperature for your floor with your installer/floor supplier.

The figure at the end of the curve indicates the curve slope. The figure beside the thermometer gives the curve offset. Use the control knob to set a new value. Confirm the new setting by pressing the OK button.

Curve 0 is an own heating curve created in menu 1.9.7.

### ***To select another heat curve (slope):***

#### **NOTE**

If you only have one heating system, the number of the curve is already marked when the menu window opens.

1. Select the system (if more than one) for which the heat curve is to be changed.
2. When the system selection has been confirmed the heat curve number is marked.
3. Press the OK button to access the setting mode
4. Select a new heating curve. The heating curves are numbered from 0 to 15, the greater the number, the steeper the slope and the greater the supply temperature. Heating curve 0 means that **own curve** (menu 1.9.7) is used.
5. Press the OK button to exit the setting.

### ***To read off a heating curve:***

1. Turn the control knob so that the ring on the shaft with the outdoor temperature is marked.
2. Press the OK button.
3. Follow the grey line up to the heat curve and out to the left to read off the value for the supply temperature at the selected outdoor temperature.
4. You can now select to take read outs for different outdoor temperatures by turning the control knob to the right or left and read off the corresponding flow temperature.
5. Press the OK or Back button to exit read off mode.

**TIP**

Wait 24 hours before making a new setting, so that the room temperature has time to stabilise.

If it is cold outdoors and the room temperature is too low, increase the curve slope by one increment.

If it is cold outdoors and the room temperature is too high, lower the curve slope by one increment.

If it is warm outdoors and the room temperature is too low, increase the curve offset by one increment.

If it is warm outdoors and the room temperature is too high, lower the curve offset by one increment.



## external adjustment

### *climate system*

Setting range: -10 to +10.

Or desired room temperature if the room sensor is installed. See illustration.

Default value: 0

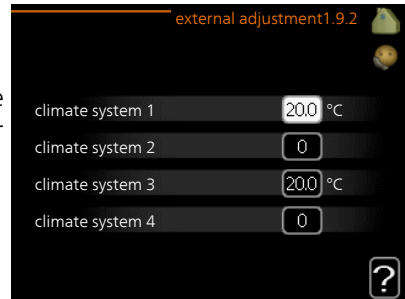

Connecting an external contact, for example, a room thermostat or a timer allows you to temporarily or periodically raise or lower the room temperature while heating. When the contact is on, the heating curve offset is changed by the number of steps selected in the menu. If a room sensor is installed and activated the desired room temperature (°C) is set.

If there is more than one climate system the setting can be made separately for each system.

## min. flow line temp.

### *heating*

Setting range: 20-70 °C

Default value: 20 °C

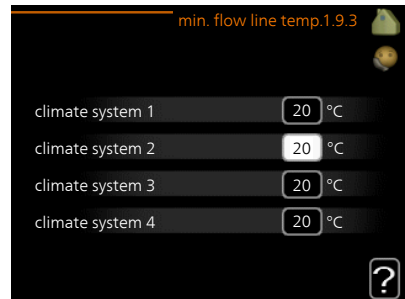

Set the minimum temperature on the supply temperature to the climate system. This means that F470 never calculates a temperature lower than that set here.

If there is more than one climate system the setting can be made separately for each system.

**TIP**

The value can be increased if you have, for example, a cellar that you always want to heat, even in summer.

You may also need to increase the value in "stop heating" menu 4.9.2 "auto mode setting".

## room sensor settings

### **factor system**

Setting range: 0.0 - 6.0

Default value: 2.0

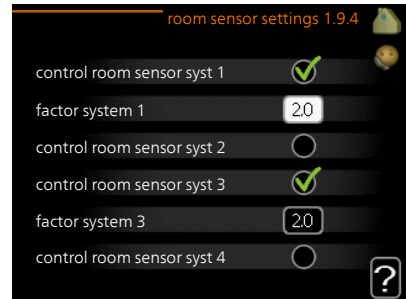

Room sensors to control the room temperature can be activated here.



### **Caution**

A slow heat-releasing heating system, such as for example, underfloor heating, may not be suitable for control using the heat pump's room sensor.

Here you can set a factor (a numerical value) that determines how much an over or sub normal temperature (the difference between the desired and actual room temperature) in the room is to affect the supply temperature to the climate system. A higher value gives a greater and faster change of the heating curve's set offset.

### **NOTE**

Too high a set value for "factor system" can (depending on your climate system) produce an unstable room temperature.

If several climate systems are installed the above settings can be made for the relevant systems.

## fan return time

### *speed 1-4*

Setting range: 1 – 99 h

Default value: 4 h

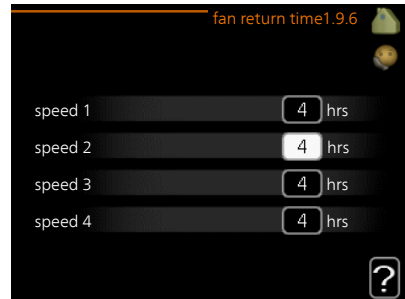

Here you select the return time for temporary speed change (speed 1-4) on the ventilation in menu 1.2.

Return time is the time it takes before ventilation speed returns to normal.

## own curve

### *supply temperature*

Setting range: 0 – 80 °C

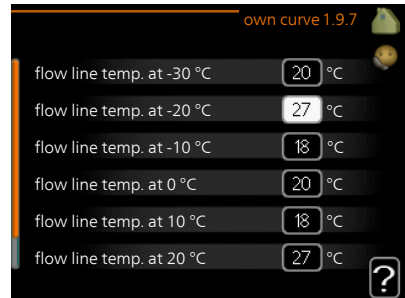

You can create your own heating curve here, if there are special requirements, by setting the desired supply temperatures for different outdoor temperatures.



### **Caution**

Curve 0 in menu 1.9.1 must be selected for own curve to apply.

## point offset

### ***outdoor temp. point***

Setting range: -40 – 30 °C

Default value: 0 °C

### ***change in curve***

Setting range: -10 – 10 °C

Default value: 0 °C

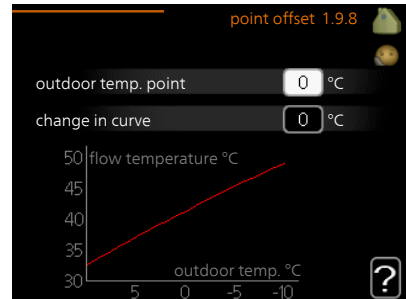

Select a change in the heating curve at a certain outdoor temperature here. One step is usually enough to change the room temperature by one degree, but in some cases several steps may be required.

The heat curve is affected at  $\pm 5$  °C from set outdoor temp. point.

It is important that the correct heating curve is selected so that the room temperature is experienced as even.



### **TIP**

If it is cold in the house, at, for example -2 °C, "outdoor temp. point" is set to "-2" and "change in curve" is increased until the desired room temperature is maintained.



### **Caution**

Wait 24 hours before making a new setting, so that the room temperature has time to stabilise.

## night cooling

### ***start temp. exhaust air***

Setting range: 20 – 30 °C

Default value: 25 °C

### ***min diff. outdoor-exhaust***

Setting range: 3 – 10 °C

Default value: 6 °C

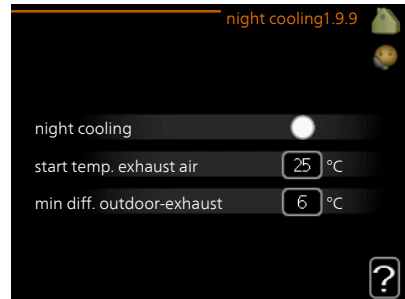

Activate night cooling here.

When the temperature in the house is high and the outdoor temperature is lower, a cooling effect can be obtained by forcing the ventilation.

If the temperature difference between the exhaust air and the outdoor air temperature is greater than the set value ("min diff. outdoor-exhaust") and the exhaust air temperature is higher than the set value ("start temp. exhaust air") run the ventilation at speed 4 until one of the conditions is no longer met.



### **Caution**

Night cooling can only be activated when house heating has been deactivated. This is done in menu 4.2.

# Set the hot water capacity

## Overview

### Sub-menus

For the menu **HOT WATER** there are several sub-menus. Status information for the relevant menu can be found on the display to the right of the menu.

**temporary lux** Activation of temporary increase in the hot water temperature. Status information displays "off" or what length of time of the temporary temperature increase remains.

**comfort mode** Setting hot water comfort. The status information displays what mode is selected, "economy", "normal" or "luxury".

**scheduling** Scheduling hot water comfort. The status information "set" appears if you have set scheduling but it is not currently active, "holiday setting" appears if holiday setting is active at the same time as scheduling (when the holiday function is prioritised), "active" appears if any part of scheduling is active, otherwise "off" appears.

**advanced** Setting periodic increase in the hot water temperature.



Menu  
2.1

### temporary lux

Setting range: 3, 6 and 12 hours and mode "off" and "one time increase"

Default value: "off"

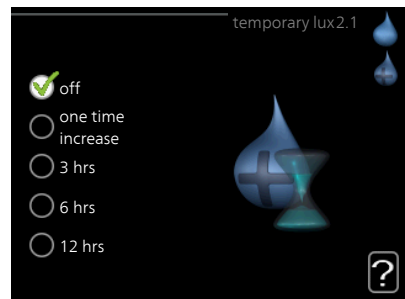

When hot water requirement has temporarily increased this menu can be used to select an increase in the hot water temperature to lux mode for a selectable time.



### Caution

If comfort mode "luxury" is selected in menu 2.2 no further increase can be carried out.

The function is activated immediately when a time period is selected and confirmed using the OK button. The remaining time for the selected setting is shown to the right.

When the time has run out F470 returns to the mode set in menu 2.2.

Select "off" to switch off **temporary lux**.

Menu  
2.2

### comfort mode

Setting range: smart control, economy, normal, luxury

Factory setting: smart control

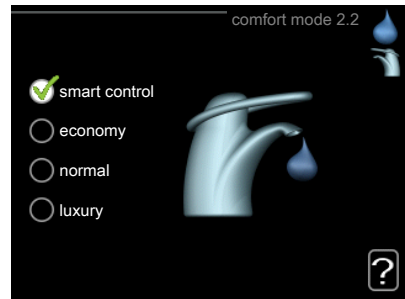

The difference between the selectable modes is the temperature of the hot tap water. Higher temperature means that the hot water lasts longer.

**smart control:** In this menu you activate the Smart Control function. The function learns the previous week's hot water consumption and adapts the temperature in the water heater for the coming week to ensure minimal energy consumption.

If the hot water demand is greater, there is a certain additional amount of hot water available.

When the Smart Control function is activated, the water heater delivers the reported performance according to the energy decal.

**economy:** This mode gives less hot water than the others, but is more economical. This mode can be used in smaller households with a small hot water requirement.

**normal:** Normal mode gives a larger amount of hot water and is suitable for most households.

**luxury:** Lux mode gives the greatest possible amount of hot water. In this mode, the immersion heater, as well as the compressor, is used to heat hot water, which may increase operating costs.



## scheduling

What hot water comfort the heat pump is to work with can be scheduled here for up to two different time periods per day.

Scheduling is activated/deactivated by ticking/unticking "activated". Set times are not affected at deactivation.

**Schedule:** The schedule to be changed is selected here.

**Activated:** Scheduling for the selected period is activated here. Set times are not affected at deactivation.

**Day:** Select which day or days of the week the schedule is to apply to here. To remove the scheduling for a particular day, the time for that day must be reset by setting the start time to the same as the stop time. If the line "all" is used, all days in the period are set for these times.

**Time period:** The start and stop time for the selected day for scheduling are selected here.

**Adjusting:** Set the hot water comfort that is to apply during scheduling here.

**Conflict:** If two settings conflict with each other a red exclamation mark is displayed.

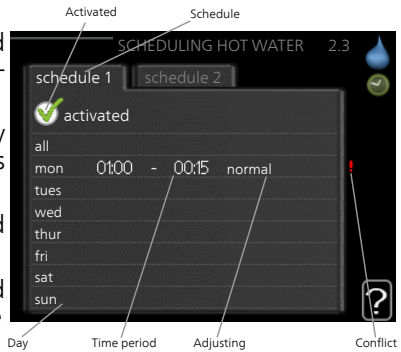

### TIP

If you wish to set similar scheduling for every day of the week start by filling in "all" and then changing the desired days.



### TIP

Set the stop time earlier than the start time so that the period extends beyond midnight. Scheduling then stops at the set stop time the day after.

Scheduling always starts on the date that the start time is set for.

Menu  
2.9

## advanced

Menu **advanced** has orange text and is intended for the advanced user. This menu has several sub-menus.

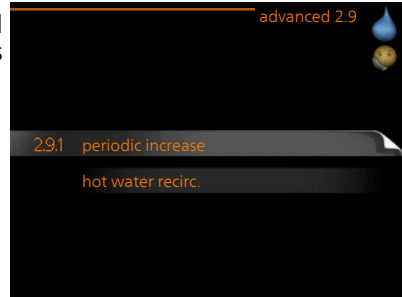

Menu  
2.9.1

## periodic increase

### **period**

Setting range: 1 - 90 days

Default value: 14 days

### **start time**

Setting range: 00:00 - 23:00

Default value: 00:00

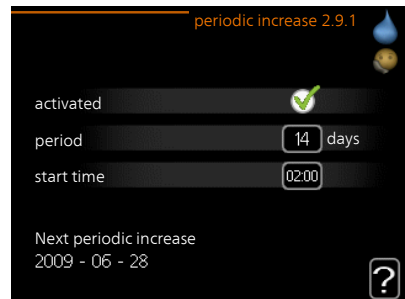

To prevent bacterial growth in the water heater, the compressor and the immersion heater can increase the hot water temperature for a short time at regular intervals.

The length of time between increases can be selected here. The time can be set between 1 and 90 days. Factory setting is 14 days. Tick/untick "activated" to start/switch off the function.

## hot water recirc.

### ***operating time***

Setting range: 1 - 60 min

Default value: 60 min

### ***downtime***

Setting range: 0 - 60 min

Default value: 0 min

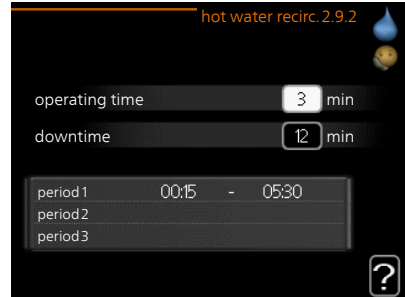

Set the hot water circulation for up to three periods per day here. During the set periods the hot water circulation pump will run according to the settings above.

"operating time" decide how long the hot water circulation pump must run per operating instance.

"downtime" decide how long the hot water circulation pump must be stationary between operating instances.

# Get information

## Overview

### Sub-menus

For the menu **INFO** there are several sub-menus. No settings can be made in these menus, they just display information. Status information for the relevant menu can be found on the display to the right of the menu.

**service info** shows temperature levels and settings in the installation.

**compressor info** shows operating times, number of starts etc for the compressor in the heat pump.

**add. heat info** displays information about the additional heat's operating times etc.

**alarm log** displays the latest alarm and information about the heat pump when the alarm occurred.

**indoor temp. log** the average temperature indoors week by week during the past year.

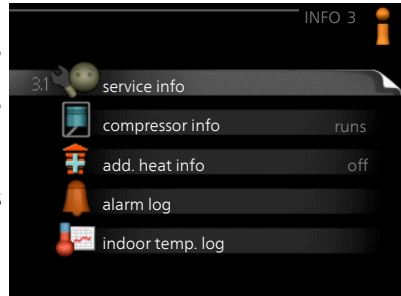

Menu  
3.1

### service info

Information about the heat pump's actual operating status (e.g. current temperatures etc.) can be obtained here. No changes can be made.

The information is on several pages. Turn the control knob to scroll between the pages.

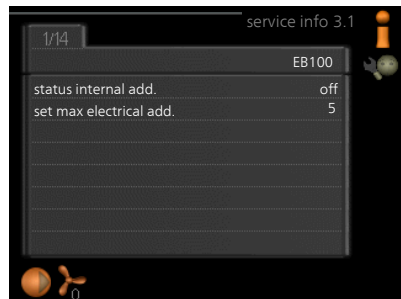

## Symbols in this menu:



Compressor



Heating



Addition



Hot water

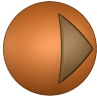

Circulation pump, climate system



Ventilation

Menu  
3.2

### compressor info

Information about the compressor's operating status and statistics can be obtained here. No changes can be made.

The information is on several pages. Turn the control knob to scroll between the pages.

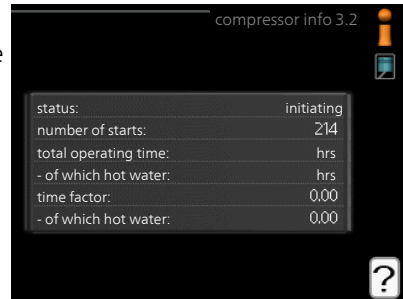

Menu  
3.3

### add. heat info

Information about the additional heat's settings, operating status and statistics can be obtained here. No changes can be made.

The information is on several pages. Turn the control knob to scroll between the pages.

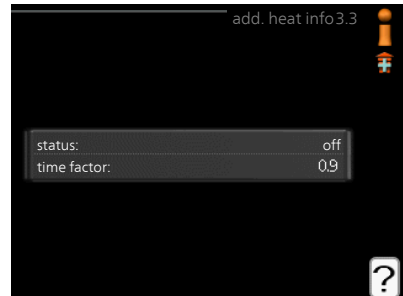

## alarm log

To facilitate fault-finding the heat pump operating status at alarm alerts is stored here. You can see information for the 10 most recent alarms.

To view the run status in the event of an alarm, mark the alarm and press the OK button.

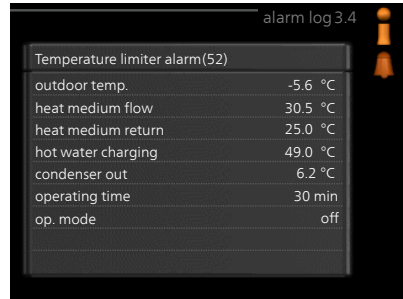
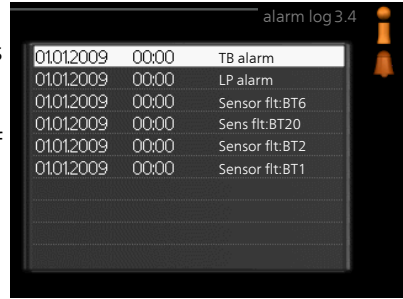

Information about an alarm.

## indoor temp. log

Here you can see the average temperature indoors week by week during the past year. The dotted line indicates the annual average temperature.

The average outdoor temperature is only shown if a room temperature sensor/room unit is installed. Otherwise, the exhaust air temperature is shown.

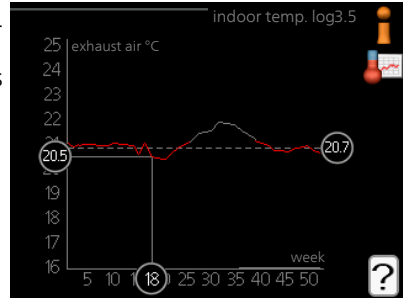

### ***To read off an average temperature***

1. Turn the control knob so that the ring on the shaft with the week number is marked.
2. Press the OK button.
3. Follow the grey line up to the graph and out to the left to read off the average indoor temperature at the selected week.
4. You can now select to take read outs for different weeks by turning the control knob to the right or left and read off the average temperature.
5. Press the OK or Back button to exit read off mode.

# Adjust the heat pump

## Overview

### Sub-menus

For the menu **HEAT PUMP** there are several sub-menus. Status information for the relevant menu can be found on the display to the right of the menu.

**plus functions** Settings applying to any installed extra functions in the heating system.

**op. mode** Activation of manual or automatic operating mode. The status information shows the selected operating mode.

**my icons** Settings regarding which icons in the heat pump's user interface that are to appear in the slot when the door is closed.

**time & date** Setting current time and date.

**language** Select the language for the display here. The status information shows the selected language.

**holiday setting** Vacation scheduling heating, hot water and ventilation. Status information "set" is displayed if you set a vacation schedule but it is not active at the moment, "active" is displayed if any part of the vacation schedule is active, otherwise it displays " off".

**advanced** Setting heat pump work mode.

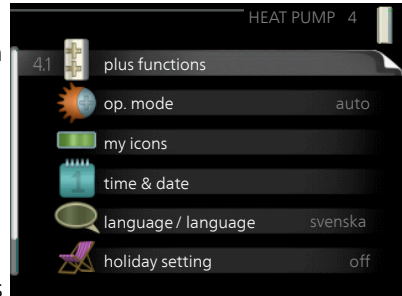

Menu  
4.1

### plus functions

Settings for any additional functions installed in F470 can be made in the sub menus.

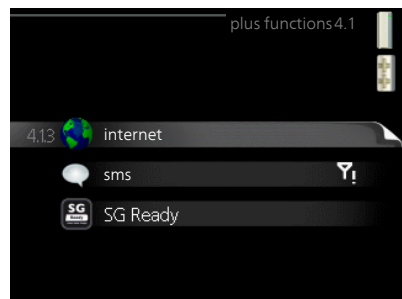



## internet

Here you make settings for connecting F470 to the internet.

### NOTE

For these functions to work the network cable must be connected.

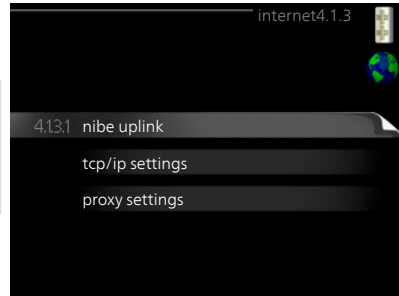

## Uplink

Here you can manage the installation's connection to Uplink (<http://www.nibeuplink.com>) and see the number of users connected to the installation via the internet.

A connected user has a user account in Uplink, which has been given permission to control and/or monitor your installation.

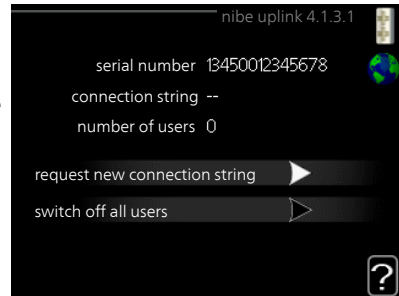

### **Request new connection string**

To connect a user account on Uplink to your installation, you must request a unique connection code.

1. Mark "request new connection string" and press the OK button.
2. The installation now communicates with Uplink to create a connection code.
3. When a connection string has been received, it is shown in this menu at "connection string" and is valid for 60 minutes.

### **Disconnect all users**

1. Mark "switch off all users" and press the OK button.
2. The installation now communicates with Uplink to release your installation from all users connected via the internet.

### NOTE

After disconnecting all users none of them can monitor or control your installation via Uplink without requesting a new connection string.

## tcp/ip settings

You can set TCP/IP settings for your installation here.

### **Automatic setting (DHCP)**

1. Tick "automatic". The installation now receives the TCP/IP settings using DHCP.
2. Mark "confirm" and press the OK button.



### **Manual setting**

1. Untick "automatic", you now have access to several setting options.
2. Mark "ip-address" and press the OK button.
3. Enter the correct details via the virtual keypad.
4. Mark "OK" and press the OK button.
5. Repeat 1 - 3 for "net mask", "gateway" and "dns".
6. Mark "confirm" and press the OK button.



### **Caution**

The installation cannot connect to the internet without the correct TCP/IP settings. If unsure about applicable settings use the automatic mode or contact your network administrator (or similar) for further information.



### **TIP**

All settings made since opening the menu can be reset by marking "reset" and pressing the OK button.

## proxy settings

You can set proxy settings for your installation here.

Proxy settings are used to give connection information to a intermediate server (proxy server) between the installation and Internet. These settings are primarily used when the installation connects to the Internet via a company network. The installation supports proxy authentication of the HTTP Basic and HTTP Digest type.

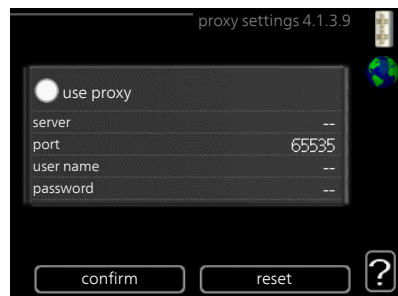

If unsure about applicable settings, contact your network administrator (or similar) for further information.

### Setting

1. Tick "use proxy" if you do not want to use a proxy.
2. Mark "server" and press the OK button.
3. Enter the correct details via the virtual keypad.
4. Mark "OK" and press the OK button.
5. Repeat 1 - 3 for "port", "user name" and "password".
6. Mark "confirm" and press the OK button.



#### TIP

All settings made since opening the menu can be reset by marking "reset" and pressing the OK button.

#### Menu 4.1.4

### sms (accessory is required)

Make settings for the accessory SMS 40 here.

Add the mobile numbers that are to have access to change and receive status information from the heat pump. Mobile numbers must include country code e.g. +46 XXXXXXXX.

If you want to receive an SMS message in the event of the alarm mark the box to the right of the telephone number.

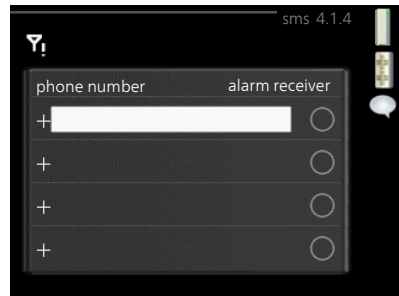

#### NOTE

Telephone numbers provided must be able to receive SMS messages.

## SG Ready

This function can only be used in mains networks that support the "SG Ready"-standard .

Make settings for the function "SG Ready" here.

### ***affect room temperature***

Here you set whether room temperature should be affected when activating "SG Ready".

With low price mode on "SG Ready" the parallel offset for the indoor temperature is increased by "+1". If a room sensor is installed and activated, the desired room temperature is instead increased by 1 °C.

With over capacity mode on "SG Ready" the parallel offset for the indoor temperature is increased by "+2". If a room sensor is installed and activated, the desired room temperature is instead increased by 2 °C.

### ***affect hot water***

Here you set whether the temperature of the hot water should be affected when activating "SG Ready".

With low price mode on "SG Ready" the stop temperature of the hot water is set as high as possible at only compressor operation (immersion heater not permitted).

With over capacity mode of "SG Ready" the hot water is set to "luxury" (immersion heater permitted).

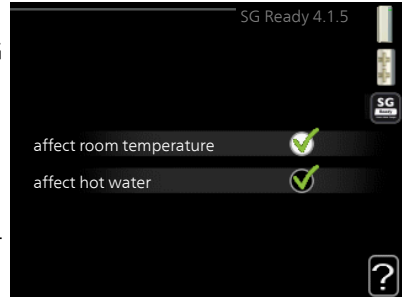

#### **NOTE**

The function must be connected and activated in your F470.

## Smart price adaption™

### **area**

In this menu you state where the heat pump is located and how great a role the electricity price should play. The greater the value, the greater the effect the electricity price has and the possible savings are larger, but at the same time there is an increased risk of affecting comfort.

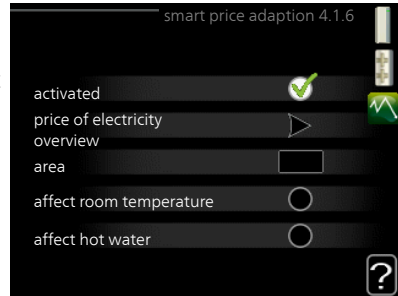

### **price of electricity overview**

Here you can obtain information on how the electricity price varies over up to three days.

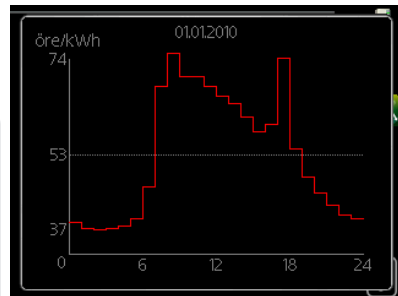

#### ***affect room temperature***

Setting range: 1 - 10

Factory setting: 5

#### ***affect hot water***

Setting range: 1 - 4

Factory setting: 2

Smart price adaption™ moves the heat pump's consumption over 24 hours to periods with the cheapest electricity tariff, which gives savings for hourly rate based electricity contracts. The function is based on hourly rates for the next 24 hours being retrieved via Uplink and therefore an internet connection and an account for Uplink are required.

Deselect "activated" to switch off Smart price adaption™.

## smart home (accessory is required)

When you have a smart home system that can speak to Uplink, you can control your heat pump via an app

By allowing connected units to communicate with Uplink, your heating system becomes a natural part of your homesmart home and gives you the opportunity to optimise the operation.



### Caution

The smart home function requires Uplink in order to work.

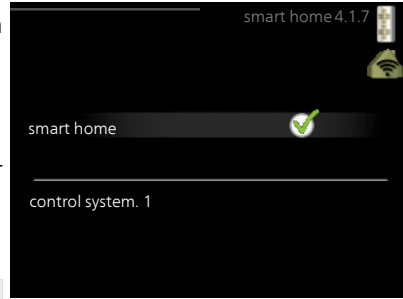

## solar electricity

### ***affect room temperature***

Setting range: on/off

Factory setting: off

### ***affect hot water***

Setting range: on/off

Factory setting: off

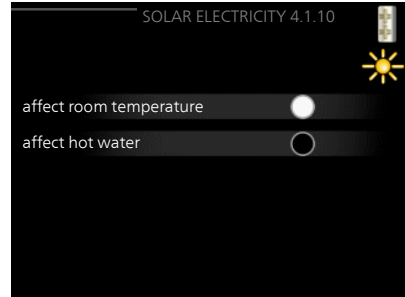

This is where you set which part of your climate system (room temperature, hot water temperature) is to be affected by EME 20 or EME 10. F470 switches automatically between different operating modes, depending on how much electricity the solar panels are producing. A sun icon appears in the main menu when electricity production is active, and when the solar panels are producing more electricity than F470 requires, the climate system is affected in line with the selected settings.

## op. mode

### ***op. mode***

Setting range: auto, manual, add. heat only

Default value: auto

### ***functions***

Setting range: compressor, addition, heating

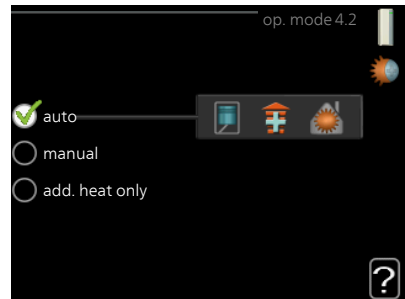

The heat pump operating mode is usually set to "auto". It is also possible to set the heat pump to "add. heat only", but only when an addition is used, or "manual" and select yourself what functions are to be permitted.

Change the operating mode by marking the desired mode and pressing the OK button. When an operating mode is selected, it shows what is permitted in the heat pump (crossed out = not permitted) and selectable alternatives to the right. To select selectable functions that are permitted or not, mark the function using the control knob and press the OK button.

### **Operating mode auto**

In this operating mode the heat pump automatically selects what functions are permitted.

### **Operating mode manual**

In this operating mode you can select what functions are permitted. You cannot deselect "compressor" in manual mode.

### **Operating mode add. heat only**

In this operating mode the compressor is not active, only additional heat is used.



#### **Caution**

If you choose mode "add. heat only" the compressor is deselected and there is a higher operating cost.

### **Functions**

"**compressor**" is that which produces heating and hot water for the accommodation. If "compressor" is deselected, a symbol in the main menu on the heat pump symbol is displayed. You cannot deselect "compressor" in manual mode.

"**addition**" is what helps the compressor to heat the accommodation and/or the hot water when it cannot manage the whole requirement alone.

"**heating**" means that you get heat in the accommodation. You can deselect the function when you do not wish to have heating running.



#### **Caution**

If you deselect "addition" it may mean that insufficient hot water and/or heating in the accommodation is achieved.

## Menu 4.3

### **my icons**

You can select what icons should be visible when the door to F470 is closed. You can select up to 3 icons. If you select more, the ones you selected first will disappear. The icons are displayed in the order you selected them.

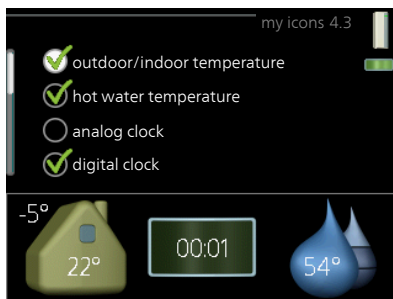



Menu  
4.4



## time & date

Set time and date, display mode and time zone here.

### TIP

Time and date are set automatically if the heat pump is connected to Uplink. To obtain the correct time, the time zone must be set.



Menu  
4.6

## language

Choose the language that you want the information to be displayed in here.

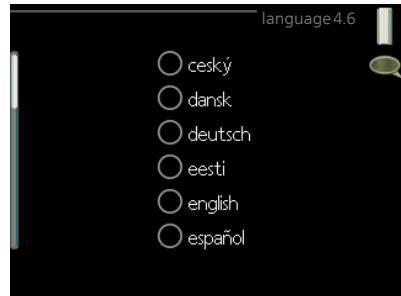

Menu  
4.7

## holiday setting

To reduce energy consumption during a holiday you can schedule a reduction in heating, ventilation and hot water temperature. Solar panel cooling can also be scheduled if the function is connected.

If a room sensor is installed and activated, the desired room temperature (°C) is set during the time period. This setting applies to all climate systems with room sensors.

If a room sensor is not activated, the desired offset of the heating curve is set. One step is usually enough to change the room temperature by one degree, but in some cases several steps may be required. This setting applies to all climate systems without room sensors.

Vacation scheduling starts at 00:00 on the start date and stops at 23:59 on the stop date.





### TIP

Complete holiday setting about a day before your return so that room temperature and hot water have time to regain usual levels.



### TIP

Set the vacation setting in advance and activate just before departure in order to maintain the comfort.



### Caution

If you choose to switch off hot water production during the vacation "periodic increase" (preventing bacterial growth) are blocked during this time. "periodic increase" started in conjunction with the vacation setting being completed.



### Caution

If the exhaust air temperature falls below 16 °C, the compressor is blocked and electric additional heat is permitted. Heat is not recovered from the exhaust air when the compressor is blocked.



### Caution

In installations with water heaters without an immersion heater connected to F470 "hot water comfort" should not be set to "off" when holiday setting is activated.

Menu  
4.9

## advanced

Menu **advanced** has orange text and is intended for the advanced user. This menu has several sub-menus.

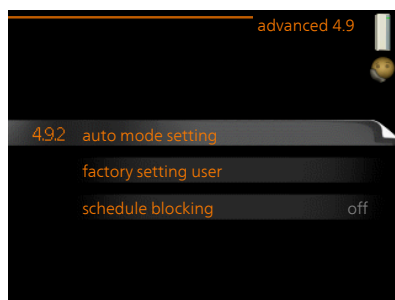

## auto mode setting

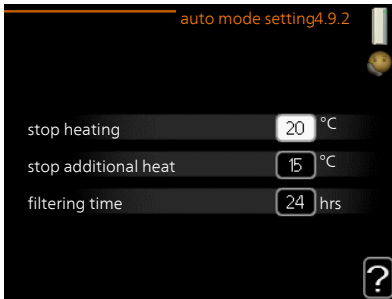

### ***stop heating***

Setting range: -20 – 40 °C

Default values: 20

### ***stop additional heat***

Setting range: -25 – 40 °C

Factory setting: 15

### ***filtering time***

Setting range: 0 – 48 h

Default value: 24 h

When the operating mode is set to "auto", the heat pump selects when start and stop of additional heat and heat production is permitted, dependent on the average outdoor temperature.

Select the average outdoor temperatures in this menu.



### **Caution**

It cannot be set "stop additional heat" higher than "stop heating".

You can also set the time over which (filtering time) the average temperature is calculated. If you select 0, the present outdoor temperature is used.

Menu  
4.9.4

## factory setting user

All settings that are available to the user (including advanced menus) can be reset to default values here.



### Caution

After factory setting, personal settings such as heating curves, ventilation etc must be reset.

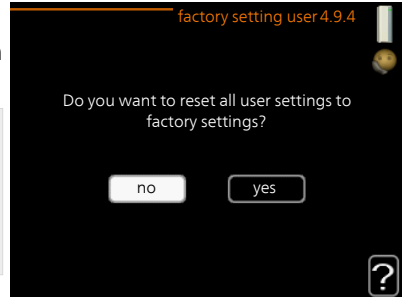

Menu  
4.9.5

## schedule blocking

The compressor can be scheduled to be blocked for up to two different time periods here.

When scheduling is active the actual blocking symbol in the main menu on the heat pump symbol is displayed.

**Schedule:** The period to be changed is selected here.

**Activated:** Scheduling for the selected period is activated here. Set times are not affected at deactivation.

**Day:** Select which day or days of the week the schedule is to apply here.

To remove the scheduling for a particular day, the time for that day must be reset by setting the start time to the same as the stop time. If the line "all" is used, all days in the period are set for these times.

**Time period:** The start and stop time for the selected day for scheduling are selected here.

**Blocking:** The desired blocking is selected here.

**Conflict:** If two settings conflict with each other a red exclamation mark is displayed.

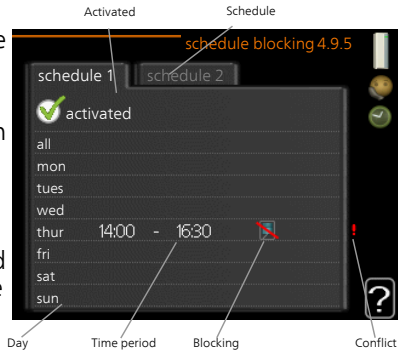

Blocking the compressor.



Blocking additional heat.

**TIP**

If you wish to set similar scheduling for every day of the week start by filling in "all" and then changing the desired days.

**TIP**

Set the stop time earlier than the start time so that the period extends beyond midnight. Scheduling then stops at the set stop time the day after.

Scheduling always starts on the date that the start time is set for.

**Caution**

Long term blocking can cause reduced comfort and operating economy.

# 4 Disturbances in comfort

In most cases, the heat pump notes operational interference (operational interference can lead to disturbance in comfort) and indicates this with alarms and shows action instructions in the display.

## Info-menu

All the heat pump measurement values are gathered under menu 3.1 in the heat pump menu system. Looking through the values in this menu can often simplify finding the fault source. See page 52 for more information about menu 3.1.

## Manage alarm

In the event of an alarm, some kind of malfunction has occurred, which is indicated by the status lamp changing from green continuously to red continuously. In addition, an alarm bell appears in the information window.

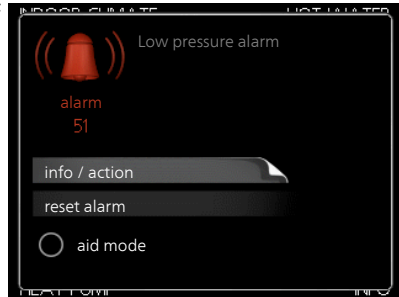

### Alarm

In the event of an alarm with a red status lamp a malfunction has occurred that the heat pump cannot remedy itself. In the display, by turning the control knob and pressing the OK button, you can see the type of alarm it is and reset it. You can also choose to set the heat pump to aid mode.

**info / action** Here you can read what the alarm means and receive tips on what you can do to correct the problem that caused the alarm.

**reset alarm** In many cases, it is sufficient to select “reset alarm” in order for the product to revert to normal operation. If a green light comes on after selecting “reset alarm”, the alarm has been remedied. If a red light is still visible and a menu called “alarm” is visible in the display, the problem that caused the alarm remains. If the alarm disappears and then returns, contact your installer.

**aid mode** “aid mode” is a type of emergency mode. This means that the heat pump produces heat and/or hot water despite there being some kind of problem. This can mean that the heat pump's compressor is not running. In this case the immersion heater produces heat and/or hot water.



### Caution

Selecting "aid mode" is not the same as correcting the problem that caused the alarm. The status lamp will therefore continue to be red.

If the alarm does not reset, contact your installer for suitable remedial action.



### NOTE

Always state the product's serial number (14 digits) when reporting a fault.

## Troubleshooting

If the operational interference is not shown in the display the following tips can be used:

### Basic actions

Start by checking the following possible fault sources:

- The switch's position.
- Group and main fuses of the accommodation.
- Earth-fault breaker.
- Correctly set load monitor (if installed).

### Low hot water temperature or a lack of hot water

- Closed or choked filling valve for the hot water heater.
  - Open the valve.
- Heat pump in incorrect operating mode.
  - Enter menu 4.2. If mode "auto" is selected, select a higher value on "stop additional heat" in menu 4.9.2.
  - If mode "manual" is selected, select "addition".
- Large hot water consumption.
  - Wait until the hot water has heated up. Temporarily increased hot water capacity (temporary lux) can be activated in menu 2.1.
- Too low hot water setting.
  - Enter menu 2.2 and select a higher comfort mode.
- Filter blocked.
  - Clean or replace filter (see page 21).

## Low room temperature

- Closed thermostats in several rooms.
  - See section "Saving tips" on page 25 and menu 1.1 on page 29 for more detailed information about how to best set the thermostats.
- Heat pump in incorrect operating mode.
  - Enter menu 4.2. If mode "auto" is selected, select a higher value on "stop heating" in menu 4.9.2.
  - If mode "manual" is selected, select "heating". If this is not enough, select "addition".
- Too low set value on the automatic heating control.
  - Enter menu 1.1 "temperature" and adjust the offset heating curve up. If the room temperature is only low in cold weather the curve slope in menu 1.9.1 "heating curve" needs adjusting up.
- "comfort mode" "luxury" selected in combination with large hot water outlet.
  - Enter menu 2.2 and select "economy" or "normal".
- "Holiday mode" activated in menu 4.7.
  - Enter menu 4.7 and select "Off".
- External switch for changing the room heating activated.
  - Check any external switches.
- Air in the heating system.
  - Vent the heating system.
- Closed valves to the heating system.
  - Open the valves (contact your installer for assistance in finding them).
- Filter blocked.
  - Clean or replace filter (see page 21).

## High room temperature

- Too high set value on the automatic heating control.
  - Enter menu 1.1 (temperature) and reduce the offset heating curve. If the room temperature is only high in cold weather the curve slope in menu 1.9.1 "heating curve" needs adjusting down.
- External switch for changing the room heating activated.
  - Check any external switches.

## Low system pressure

- Not enough water in the heating system.
  - Top up the water in the heating system.



## **Low or a lack of ventilation**

- Filter blocked.
  - Clean or replace filter (see page 21).
- The ventilation is not adjusted.
  - Order ventilation adjustment.
- Exhaust air device blocked or throttled down too much.
  - Check and clean the exhaust air devices (see page 20).
- Fan speed in reduced mode.
  - Enter menu 1.2 and select "normal".
- External switch for changing the fan speed activated.
  - Check any external switches.

## **High or distracting ventilation**

- Filter blocked.
  - Clean or replace filter (see page 21).
- The ventilation is not adjusted.
  - Order ventilation adjustment.
- Fan speed in forced mode.
  - Enter menu 1.2 and select "normal".
- External switch for changing the fan speed activated.
  - Check any external switches.

## **Low supply air temperature**

- Air in the supply air battery
  - Bleed the supply air battery.
- Trim valve too restricted
  - Contact your installer!

## **High supply air temperature**

- Trim valve not sufficiently restricted.
  - Contact your installer!

## **The compressor does not start**

- There is no heating requirement.
  - The heat pump does not call on heating nor hot water.
  - The heat pump defrosts.
- Compressor blocked due to the temperature conditions.
  - Wait until the temperature is within the product's working range.
- Minimum time between compressor starts has not been reached.
  - Wait 30 minutes and then check if the compressor has started.
- Alarm tripped.
  - Follow the display instructions.

# 5 Technical data

Detailed technical specifications for this product can be found in the installation manual ([nibe.eu](http://nibe.eu)).

# 6 Glossary

## **Additional heat**

The additional heat is the heat produced in addition to the heat supplied by the compressor in your heat pump. Additional heaters can be for example, immersion heater, electric heater, gas/oil/pellet/wood burner or district heating.

## **Calculated flow line temperature**

The temperature that the heat pump calculates that the heating system requires for an optimum accommodation temperature. The colder the outdoor temperature, the higher the calculated supply temperature.

## **Circulation pump**

Pump that circulates liquid in a pipe system.

## **Climate system**

Climate systems can also be called heating systems. The building is heated using radiators, under floor coils or convector fans.

## **Compressor**

Compresses the gas state refrigerant. When the refrigerant is compressed, the pressure and the temperature increase.

## **Condenser**

Heat exchanger where the hot gas state refrigerant condenses (cooled and becomes a liquid) and releases heat energy to the house heating and hot water systems.

## **Disturbances in comfort**

Disturbances in comfort are undesirable changes to the hot water/indoor comfort, for example when the temperature of the hot water is too low or if the indoor temperature is not at the desired level.

A malfunction in the heat pump can sometimes be noticed in the form of a disturbance in comfort.

In most cases, the heat pump notes operational interference and indicates this with alarms and shows instructions in the display.

## **Domestic hot water**

The water one showers in for example.

## **Electrical addition**

This is the electricity that, for example, an immersion heater produces when the compressor's output is not sufficient to fulfil the property's heating demand.

## **Emergency mode**

A mode that can be selected using the switch in the event of a fault, which means that the compressor stops. When the heat pump is in emergency mode, the building and/or hot water is heated using an immersion heater.

## **Evaporator**

Heat exchanger where the refrigerant evaporates by retrieving heat energy from the air which then cools.

## **Exhaust air**

The air that comes from the exhaust air device in the various rooms of the accommodation, to F470.

## **Exhaust air devices**

Vents, usually in the ceiling, in the kitchen/bathroom/clothes closet where the air is drawn in to be forwarded to F470.

## **Expansion valve**

Valve that reduces the pressure of the refrigerant, whereupon the temperature of the refrigerant drops.

## **Expansion vessel**

Vessel with heating medium fluid with the task of equalising the pressure in the heating medium system.

## **Extract air**

The air that the heat pump has retrieved heat from and which has therefore been cooled. This air is blown out of the building.

## **Filtering time**

Indicates the time the average outdoor temperature is calculated on.

## **Flow pipe**

The line in which the heated water is transported from the heat pump out to the house heating system (radiators/heating coils).

## **Heat exchanger**

Device that transfers heat energy from one medium to another without mixing mediums. Examples of different heat exchangers are evaporators and condensers.

## **Heat factor**

Measurement of how much heat energy the heat pump gives off in relation to the electric energy it needs to operate. Another term for this is COP.

## **Heating curve**

The heating curve determines which heat the heat pump is to produce depending on the temperature outdoors. If a high value is selected, this tells the heat pump that it must produce a lot of heat when it is cold outdoors in order to achieve a warm indoor temperature.

## **Heating medium**

Hot liquid, usually normal water, which is sent from the heat pump to the house climate system and makes the accommodation warm. The heating medium also heats the hot water.

## **Heating medium side**

Pipes to the house's climate system make up the heating medium side.

## **Mixing valve**

A valve that mixes the cold water with the hot water leaving the heater.

## **Outdoor air**

Air that is drawn into the F470 and heated.

## **Outside sensor**

A sensor that is located outdoors. This sensor tells the heat pump how hot it is outdoors.

## **Pressostat**

Pressure switch that triggers an alarm and/or stops the compressor if non-permitted pressures occur in the system. A high pressure pressostat trips if the condensing pressure is too great. A low pressure pressostat trips if the evaporation pressure is too low.

## **Radiator**

Another word for heating element. They must be filled with water in order to be used with F470.

## **Refrigerant**

Substance that circulates around a closed circuit in the heat pump and that, through pressure changes, evaporates and condenses. During evaporation, the refrigerant absorbs heating energy and when condensing gives off heating energy.

## **Return pipe**

The line in which the water is transported back to the heat pump from the house heating system (radiators/heating coils).

## **Return temp**

The temperature of the water that returns to the heat pump after releasing the heat energy to the radiators/heating coils.

## **Room sensor**

A sensor that is located indoors. This sensor tells the heat pump how hot it is indoors.

## **Safety valve**

A valve that opens and releases a small amount of liquid if the pressure is too high.

## **Shunt**

A valve that mixes the hot water with a small amount of slightly cooler water. There is a shunt in the heat pump that mixes the supply water with the return line water so that the heating system reaches the correct temperature.

## **Supply air**

The heated air that is blown from F470 and out into the room.

## **Supply air device**

Valves, usually in the ceiling, where the heated supply air is blown out and aids in heating up the accommodation.

## **Supply temperature**

The temperature of the heated water that the heat pump sends out to the heating system. The colder the outdoor temperature, the higher the supply line temperature becomes.

## **Water heater**

Container where domestic water is heated. Is located inside the heat pump, but an extra hot water heater can be installed in the event of large hot water requirements.



# 7 Item register

## A

- Adjust the heat pump, 56
- Alarm, 70

## B

- Back button, 13

## C

- Contact with F470, 11
  - Display unit, 12
  - External information, 11
  - Menu system, 14
- Control knob, 13

## D

- Display, 12
- Display unit, 12
  - Back button, 13
  - Control knob, 13
  - Display, 12
  - OK button, 13
  - Status lamp, 12
  - Switch, 13
- Disturbances in comfort, 70
  - Alarm, 70
  - Manage alarm, 70
  - Troubleshooting, 71

## E

- External information, 11
- Information window, 11
- Status lamp, 11

## F

- F470 – An excellent choice, 7
- F470 – at your service, 29
  - Adjust the heat pump, 56
  - Get information, 52
  - Set the hot water capacity, 47
  - Set the indoor climate, 29

## G

- Get information, 52
- Glossary, 76

## H

- Heat pump function, 9
- Help menu, 19

## I

- Important information
  - F470 – An excellent choice, 7
  - Installation data, 4
  - Serial number, 6
- Information window, 11
- Installation data, 4

## M

- Maintenance of F470, 20
  - Regular checks, 20
  - Saving tips, 25
- Manage alarm, 70
- Menu system, 14
  - Help menu, 19
  - Operation, 16
  - Scroll through the windows, 19
  - Selecting menu, 16
  - Selecting options, 16
  - Setting a value, 17
  - Use the virtual keyboard, 18

## O

- OK button, 13
- Operation, 16

## P

- Power consumption, 27

## R

- Regular checks, 20

## S

- Saving tips, 25
  - Power consumption, 27
- Scroll through the windows, 19
- Selecting menu, 16
- Selecting options, 16
- Serial number, 6
- Set the hot water capacity, 47
- Set the indoor climate, 29
- Setting a value, 17
- Status lamp, 11–12
- Switch, 13

## T

- Technical data, 75
- The heat pump – the heart of the house, 8

Troubleshooting, 71

## **U**

Use the virtual keyboard, 18

# Contact information

- AT KNV Energietechnik GmbH**, Gahberggasse 11, AT-4861 Schörföling  
Tel: +43 (0)7662 8963 E-mail: mail@knv.at www.knv.at
- CH NIBE Wärmetechnik c/o ait Schweiz AG**,  
Industriepark, CH-6246 Altishofen Tel: +41 58 252 21 00  
E-mail: info@nibe.ch www.nibe.ch
- CZ Druzstevni zavody Drazice s.r.o.**,  
Drazice 69, CZ - 294 71 Benatky nad Jizerou  
Tel: +420 326 373 801 E-mail: nibe@nibe.cz www.nibe.cz
- DE NIBE Systemtechnik GmbH**, Am Reiherpfahl 3, 29223 Celle  
Tel: +49 (0)5141 7546-0 E-mail: info@nibe.de www.nibe.de
- DK Vølund Varmeteknik A/S**, Member of the Nibe Group,  
Brogårdsvej 7, 6920 Videbæk Tel: +45 97 17 20 33  
E-mail: info@volundvt.dk www.volundvt.dk
- FI NIBE Energy Systems OY**, Juurakkotie 3, 01510 Vantaa  
Tel: +358 (0)9-274 6970 E-mail: info@nibe.fi www.nibe.fi
- FR NIBE Energy Systems France Sarl**,  
Zone industrielle RD 28, Rue du Pou du Ciel, 01600 Reyrieux  
Tel : 04 74 00 92 92 E-mail: info@nibe.fr www.nibe.fr
- GB NIBE Energy Systems Ltd**,  
3C Broom Business Park, Bridge Way, S419QG Chesterfield  
Tel: +44 (0)845 095 1200 E-mail: info@nibe.co.uk www.nibe.co.uk
- NL NIBE Energietechniek B.V.**, Postbus 634, NL 4900 AP Oosterhout  
Tel: 0168 477722 E-mail: info@nibenl.nl www.nibenl.nl
- NO ABK AS**, Brobekkveien 80, 0582 Oslo, Postboks 64 Vollebakk, 0516 Oslo  
Tel: +47 23 17 05 20 E-mail: post@abkklima.no  
www.nibe.no
- PL NIBE-BIAWAR Sp. z o. o.** Aleja Jana Pawła II 57, 15-703 BIALYSTOK  
Tel: +48 (0)85 662 84 90 E-mail: sekretariat@biawar.com.pl  
www.biawar.com.pl
- RU © "EVAN"** 17, per. Boynovskiy, RU-603024 Nizhny Novgorod  
Tel: +7 831 419 57 06 E-mail: kuzmin@evan.ru www.nibe-evan.ru
- SE NIBE AB Sweden**, Box 14, Hannabadsvägen 5, SE-285 21 Markaryd  
Tel: +46 (0)433 73 000 E-mail: info@nibe.se www.nibe.se

For countries not mention in this list, please contact Nibe Sweden or check [www.nibe.eu](http://www.nibe.eu) for more information.

NIBE AB Sweden  
Hannabadsvägen 5  
Box 14  
SE-285 21 Markaryd  
info@nibe.se  
www.nibe.eu

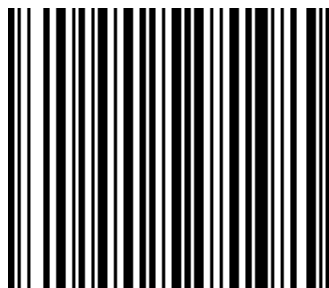

231451