

**7. WALL MOUNTED TYPE ROOM AIR-
CONDITIONER
SPLIT SYSTEM, MULTIPLE TYPE
(Split system, Air cooled)
cooling only type**

SCM328CENF-L1

[SKM258CENF-L]

SCM338CENF-L1

[SKM258CENF-L, SKM328CENF-L]

CONTENTS

7.1 GENERAL INFORMATION	235
7.1.1 Specific features	235
7.1.2 How to read the model name	235
7.2 SELECTION DATA	236
7.2.1 Specifications	236
7.2.2 Range of usage & limitations	239
7.2.3 Exterior dimensions	240
7.2.4 Piping system	241
7.3 ELECTRICAL DATA	241
7.3.1 Electrical wiring	242
7.4 OUTLINE OF OPERATION CONTROL BY MICROCOMPUTER	244
7.4.1 Table for operation control	244
7.4.2 Details of operation control	244
7.5 APPLICATION DATA	250
7.5.1 Selection of location for installation	251
7.5.2 Installation of indoor unit	252
7.5.3 Installation of outdoor unit	254
7.5.4 Refrigerant piping	257
7.5.5 Test run	258
7.5.6 Precautions for wireless remote controller installation and operation	259
7.6 MAINTENANCE DATA	260
7.6.1 Trouble shooting	260
7.6.2 Servicing	263

7.1 GENERAL INFORMATION

7.1.1 Specific features

The “Mitsubishi Daiya” room air conditioner: **SKM series** are of split and wall mounted type and the unit consists of indoor unit and outdoor unit with refrigerant precharged in factory. The indoor unit is composed of room air cooling equipment with operation control switch and the outdoor unit is composed of condensing unit with compressor.

(1) **One outdoor unit can be connected to two indoor units, so that installation space of the outdoor unit can be sharply reduced.**

(2) **Remote control flap**

The flap can be automatically controlled by operating wireless remote control.

- AUTO (Natural flow) Flap operation is automatically control.
- Swing flap This will swing the flap up and down.
- Memory flap Once the flap position is set, the unit memorizes the position and continues to operate at the same position from the next time.

(3) **Self diagnosis Function**

We are constantly trying to do better service to our customers by installing such judges that show abnormality of operation as follows.

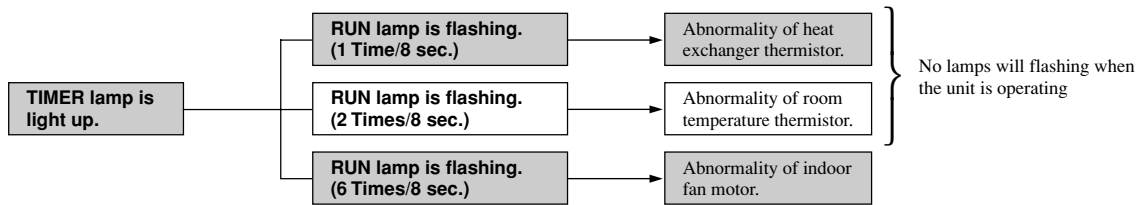

7.1.2 How to read the model name

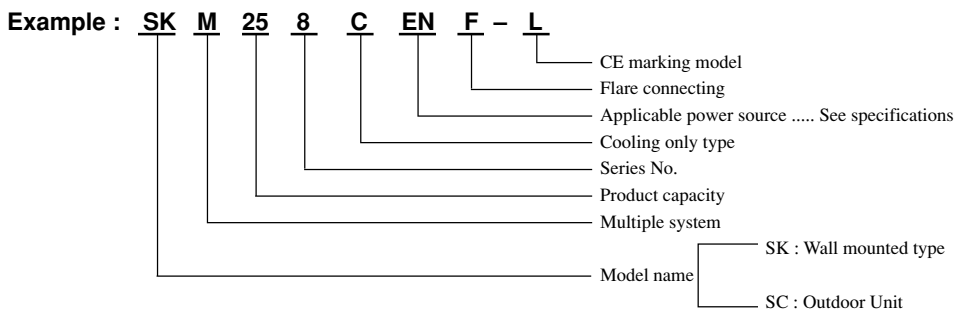

7.2 SELECTION DATA

7.2.1 Specifications

(1) Indoor Unit

Models SKM258CENF-L, 328CENF-L

Item		Model	SKM258CENF-L	SKM328CENF-L
		W	2200/2200	2600/2600
Cooling capacity		W	2200/2200	2600/2600
Power source			1 Phase, 220/240V, 50Hz	
Noise level ⁽⁴⁾		dB (A)	38/39	40/42
Exterior dimensions			275 × 790 × 174	
Height × Width × Depth		mm		
Color			Ivory white	
Net weight		kg	7.5	8
Air handling equipment			Tangential fan × 1	
Fan type & Q'ty				
Motor		W	16	
Air flow (at high)		CMM	7.5 / 7.5	9/9
Air filter, Q'ty			Polypropylene net (washable) × 2	
Operation switch			Wireless-Remote controller	
Room temperature control			MC, Thermostat	
Pilot lamp			RUN (Green), TIMER (Yellow)	
Refrigerant piping	O.D	mm (in)	Liquid line: φ6.35 (1/4") Gas line: φ9.52 (3/8")	
	Connecting method		Flare connecting	
	Attached length piping		Liquid line: 0.4 m Gas line: 0.35 m	
	Insulation		Necessary (Both sides)	
Drain hose			Connectable	
Connection wiring	Size × Core number		1.5 mm ² × 4 cores (with Earth)	
	Connecting method		Terminal block (screw fixing type)	
Accessories (included)			Mounting kit	
Optional parts			-	

Notes (1) The data are measured at the following conditions.

Operation	Item	Indoor air temperature		Outdoor air temperature		Standards
		DB	WB	DB	WB	
Cooling		27°C	19°C	35°C	24°C	JIS C9612, ISO-T1

- (2) The operation data indicate when the air conditioner is operated at 220V and 240V (SKM258CERF:220V) respectively.
- (3) Limitation of Voltage application
Minimum: 198V Maximum: 264V
- (4) Expressed in sound pressure level.

(2) Outdoor Unit

Models SCM328CENF-L1, 338CENF-L1

Item	Model	SCM328CENF-L1	SCM338CENF-L1
		Cooling capacity	W
Power source		1 Phase, 220/240V, 50Hz	
Inrush current	A	16/17	16/17
Noise level	dB (A)	44/44	44/44
Exterior dimensions Height × Width × Depth	mm	542 × 795 × 255	
Color		Polar white	
Net weight	kg	32	
Refrigeration equipment Compressor type & Q'ty		RM5495GNE8 × 1	
Motor	kW	0.75 × 1	
Starting method		Line starting	
Refrigerant control		Capillary tubes	
Refrigerant ⁽⁴⁾	kg	R22 0.74	R22 0.79
Refrigerant oil	ℓ	0.35 (BARREL FREEZE 32SAM)	
Air handling equipment Fan type & Q'ty		Propeller fan × 1	
Motor	W	15	
Air flow (at high)	CMM	22.0/22.5	
Shock & Vibration absorber		Rubber (for compressor)	
Safety equipment		Dome mounted protector (for compressor), Internal thermostat (for fan motor)	
Refrigerant piping	O.D	mm (in)	Liquid line: φ6.35 (1/4") × 2 Gas line: φ9.52 (3/8") × 2
	Connecting method		Flare connecting
	Attached length piping		-
	Insulation		Necessary (Both sides)
Power source supply		Terminal block	
Connection wiring	Size × Core number		2 pcs × 1.5 mm ² × 4 cores (with Earth)
	Connecting method		Terminal block (screw fixing type)

Notes (1) The data are measured at the following conditions.

Item	Indoor air temperature		Outdoor air temperature		Standards
	DB	WB	DB	WB	
Operation					
Cooling	27°C	19°C	35°C	24°C	JIS C9612, ISO-T1

(2) The operation data applied to 220V or 240V districts respectively.

(3) Limitation of Voltage application
Minimum: 198V Maximum: 264V

(4) The refrigerant quantity to be charged includes the refrigerant in 15 m (SCM338.25m) connecting piping.
(Purging is not required even in the short piping.)

SCM-C

(3) Operation data

Model SCM328CENF-L1

Indoor Unit	Cooling				
	Cooling capacity (kW)		Cooling input (W)	Running current (A)	EER
	Total				
25	2.2/2.2		730/770	3.4/3.3	3.01/2.86
25 + 25	1.4 + 1.4/1.4 + 1.4		770/800	3.6/3.4	3.64/3.50

Model SCM338CENF-L1

Indoor Unit	Cooling				
	Cooling capacity (kW)		Cooling input (W)	Running current (A)	EER
	Total				
25	2.2/2.2		730/770	3.4/3.3	3.01/2.86
32	2.6/2.6		750/790	3.5/3.4	3.47/3.29
25 + 25	1.4 + 1.4/1.4 + 1.4		770/800	3.6/3.4	3.64/3.50
25 + 32	1.4 + 1.5/1.4 + 1.5		780/810	3.6/3.5	3.72/3.58

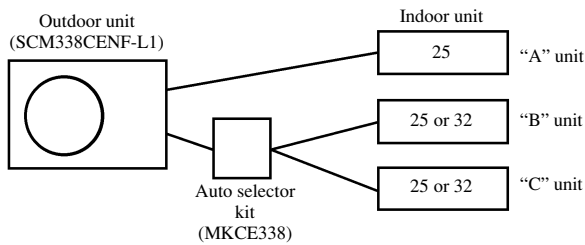

<Operation mode>

	"A" unit	"B" unit	"C" unit
2-unit operation	○	○	×
2-unit operation	○	×	○
1-unit operation	○	×	×
1-unit operation	×	○	×
1-unit operation	×	×	○

○ : Operation × : Stop

Simultaneous operation of "B" unit and "C" unit is impossible.

7.2.2 Range of usage & limitations

(1) Inlet air temperature

(a) Cooling operation

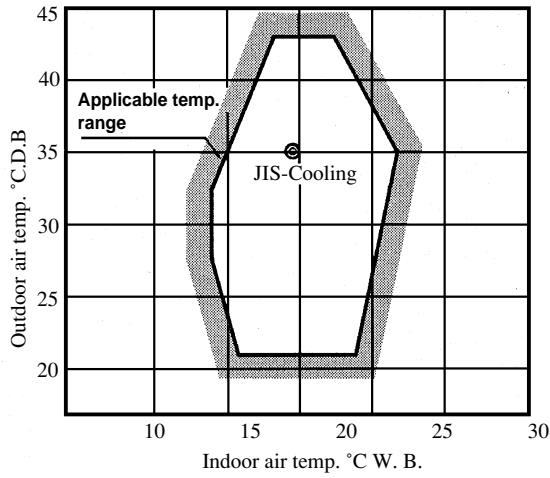

Note: The chart is result from the continuous operation under constant air temperature conditions. However, excludes the initial pull-down stage.

(2) Total one way piping length and vertical height difference.

◆ SCM328CENF-L1

Unit: mm

$$l_1 + l_2 = \text{Max. } 15$$

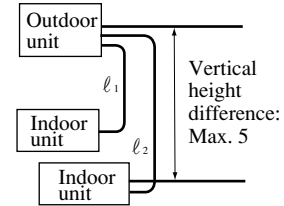
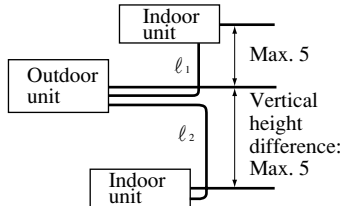
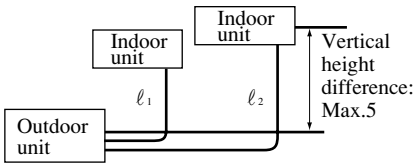

◆ SCM338CENF-L1

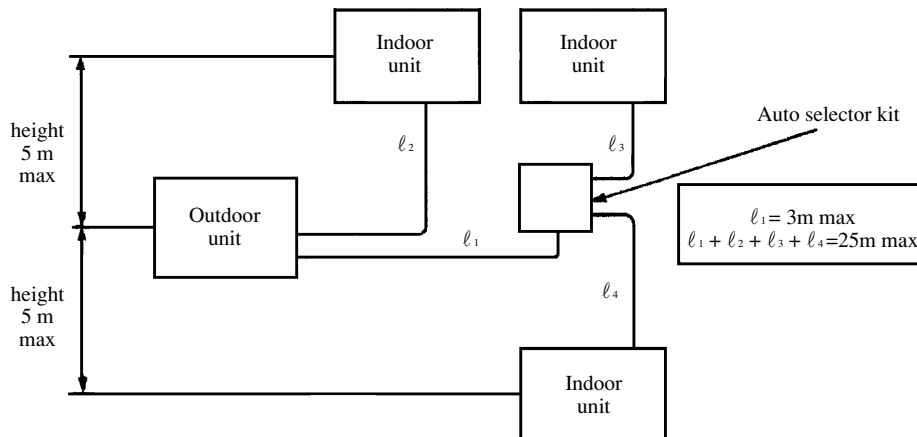

SCM-C

7.2.3 Exterior dimensions

(1) Indoor unit

Models SKM258CENF-L, 328CENF-L

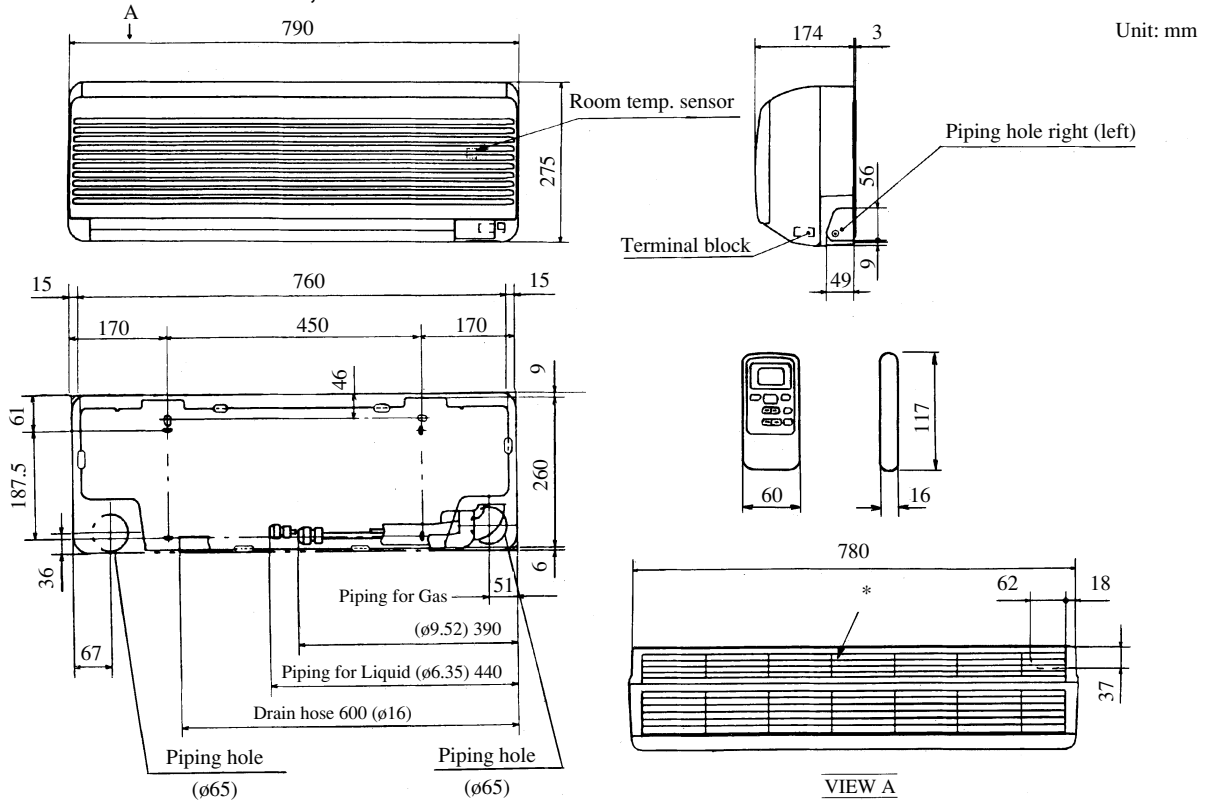

Note (1) Model 25 have no inlet opening indicated by * mark.

(2) Outdoor unit

Models SCM328CENF-L1, 338CENF-L1

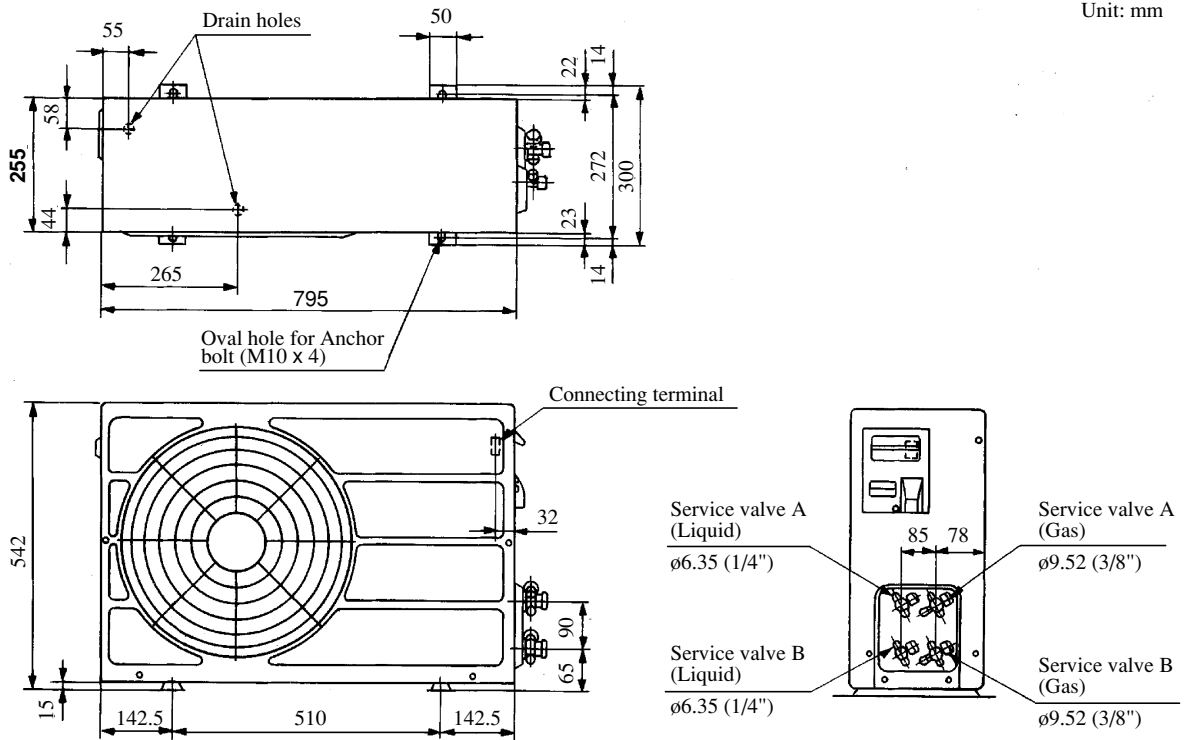

7.2.4 Piping system

Model SCM328CENF-L1

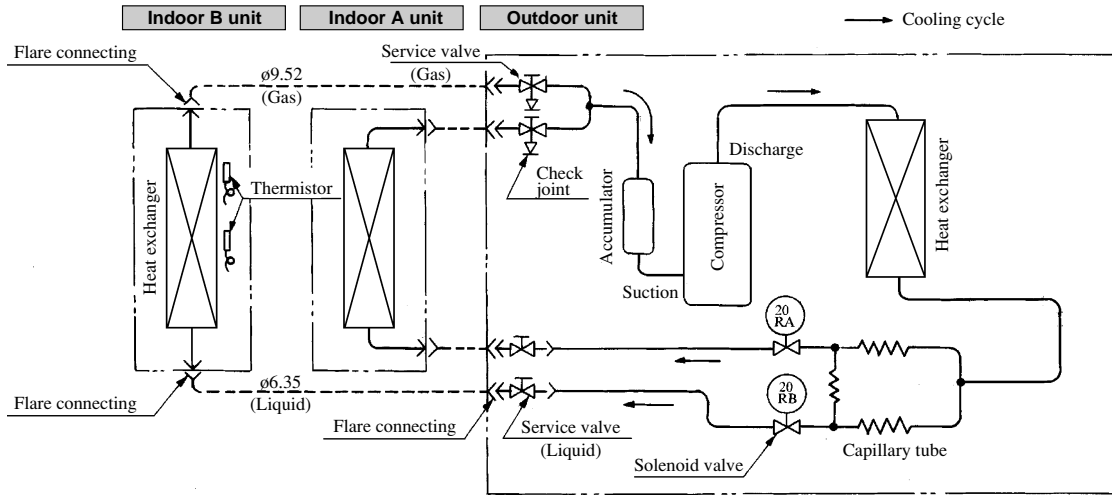

Model SCM338CENF-L1

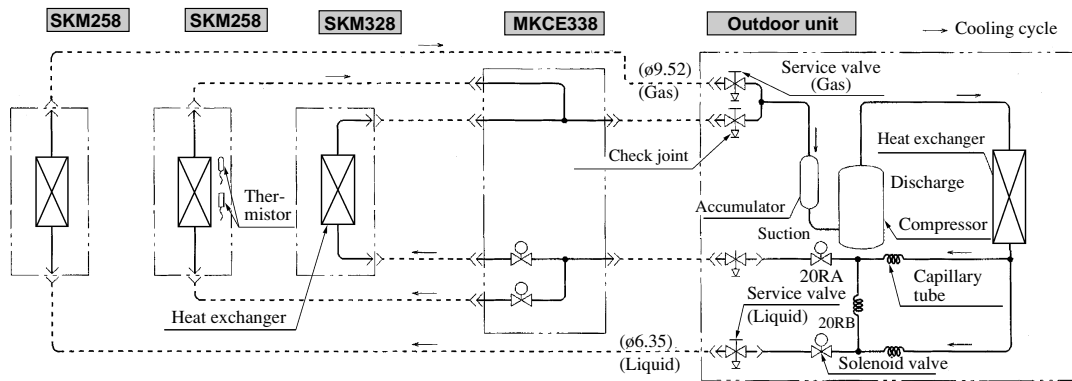

7.3 ELECTRICAL DATA

Meaning of marks

• Outdoor Unit

Symbol	Parts name	Symbol	Parts name
C _c	Capacitor for CM	20RA	Solenoid coil for A uni
C _{F0}	Capacitor for FM ₀	20RB	Solenoid coil for B uni
CM	Compressor motor	52C	Magnetic contactor for CM
TM	Delay relay	52X, 52RA, RB	Auxiliary relay
FM ₀	Fan motor	51C	Motor protector for CM

• Indoor Unit

Symbol	Parts name	Symbol	Parts name
CF _i	Capacitor for FM _i	F	Fuse
FM _i	Fan motor	Tr	Transformer
LM	Louver motor	ZNR	Varistor
Th _{1,2}	Thermistor	52C	Magnetic contactor for CM

Table of relay operations

Models SKM258CENF-L, 328CENF-L

Relay symbol	Operation	
	Control part	Cooling
52C	CM	○

Note (1) ○ : denotes magnetized relay × : denotes demagnetized relay

SCM-C

7.3.1 Electrical wiring

Model SCM328CENF-L1

Color symbol

BK	Black
BL	Blue
BR	Brown
OR	Oreng
Y/GN	Yellow/Green
RD	Red
WH	White
PP	Purple

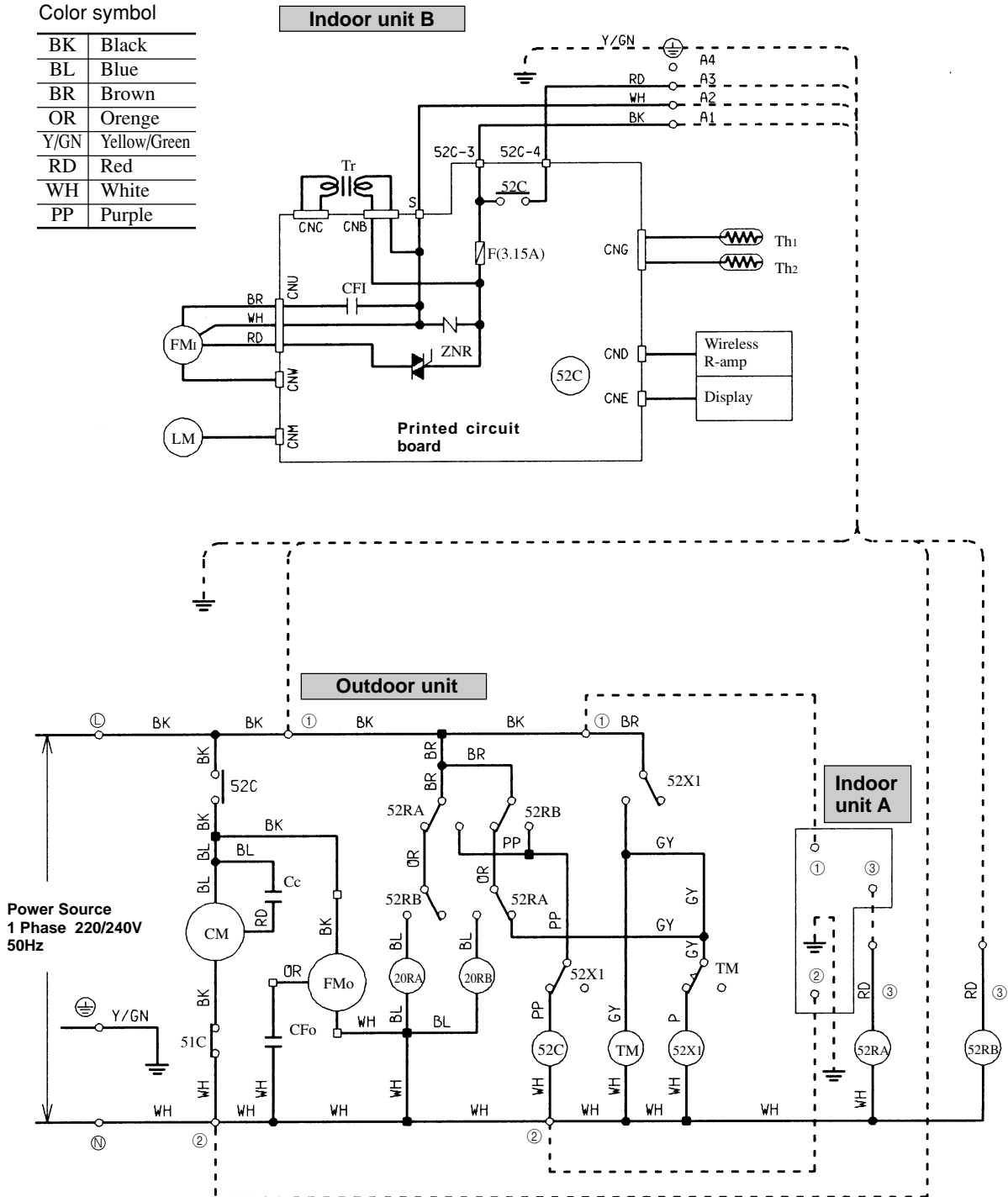

Model SCM338CENF-L1

Indoor unit A

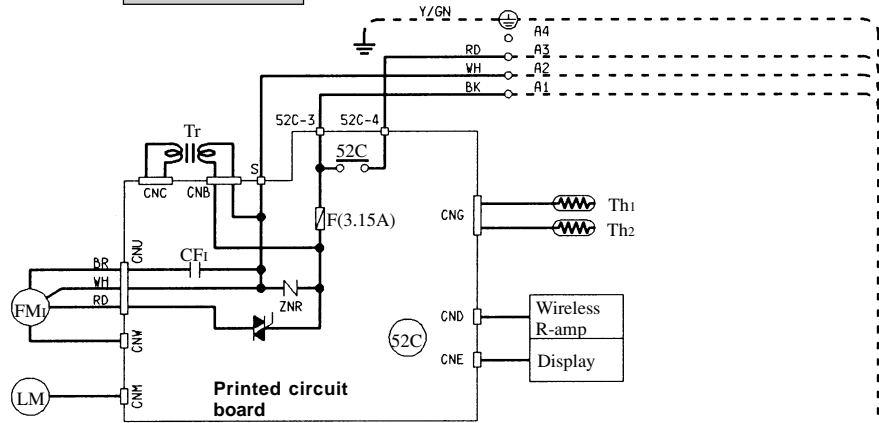

Indoor unit B

Indoor unit C

MKCE338

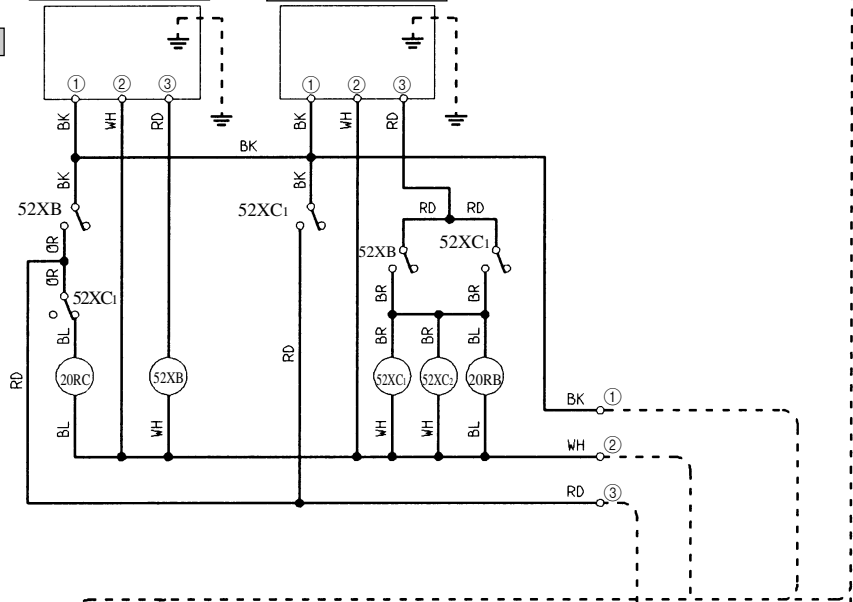

Color symbol

BK	Black
BL	Blue
BR	Brown
OR	Orege
Y/GN	Yellow/Green
RD	Red
WH	White
PP	Purple

Outdoor unit

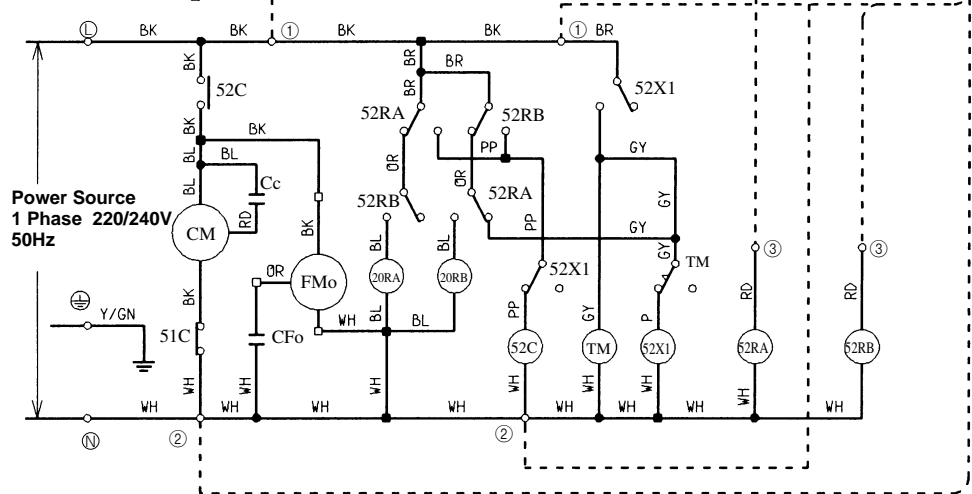

7.4 OUTLINE OF OPERATION CONTROL BY MICROCOMPUER

7.4.1 Table for operation control

Functions		Content	Referring page	
Comfortability, Economical efficiency, Operational simplicity	High efficiency, low input rotary compressor	Low input rotary compressor with high efficiency is equipped.	—	
	Wireless remote control	All operation modes can be operated from distance place by the wireless remote control. And also liquid crystal is used to show all kinds of operation or, off, air flow switch, operation switch, timer switch, timer set, temperature set, flap control	246	
	Micro computer control	Dry	Defumidifies while keeping room temperature to the thermostat setting level by M. C. thermostat.	248
		ON TIMER	ON timer setting for anytime during 12 hours can be performed.	247
		OFF TIMER	When OFF-TIMER operation is selected, the room temperature is automatically controlled after a while, ensuring that the room is not too cold during cooling. • During COOL and DRY: the pre-set temperature is raised by 0.5°C at the start of OFF-TIMER operation (when the timer is set). After that, the temperature goes up by 0.5°C every 30 minutes to become 1.5°C higher within one hour.	247
		Automatic fan control	Room unit air volume can be automatically controlled step by step, according to the difference between room temperature and setting temperature. 1. Shorten pull down time for cooling operation. 2. Low noise level operation can be performed by proper air volume.	247
		M. C. (Micro computer controlled) thermostat	M. C. thermostat improves on energy saving and comfort, by controlling room temperature with high accuracy.	—
		Remote control flap	The flap can be automatically controlled by operating wireless remote control. • AUTO (Natural flow) : Flap operation is automatically controlled. • Swing : This will swing the flap up and down. • Memory flap : Once the flap position is set, the unit memorizes the position and continues to operate at the same position from the next time.	244
		Comfort timer	The room temperature is checked 60 minutes before the timer is at ON. Depending on the temperature at that time, the operation starts 5 to 60 minutes before the timer is at ON.	247
		Self Diagnosis Function	We are constantly trying to do better service to our customers by installing such judges that show abnormality of each function as follows: • Abnormality of heat exchanger thermistor: RUN lamp flashing • Abnormality of room temperature thermistor: RUN lamp flashing • Abnormality of indoor fan motor: RUN lamp flashing	} No lamp will flashing when the unit is operating

7.4.2 Details of operation control

(1) Flap control

Control the flap by the AIRFLOW button on the wireless remote control

(a) AUTO (Natural flow)

The flap will be automatically set to the angle of air flow best to operation mode

1) Starting time of operation

In case of cooling and dry operation

Stops at the level position for one minute.

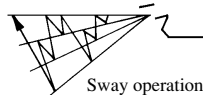

- The flap operation as shown above will be repeated.

2) When not operating

The flap returns to the position of air flow directly below, when operation has stopped.

(b) Memory flap

While the flap is operating if the AIRFLOW button is pushed once, it stops swinging at an angle.

As this angle is memorized in the microcomputer, the flap will be automatically set to the angle when next operation is started.

- Recommendable stopping angle of the flap

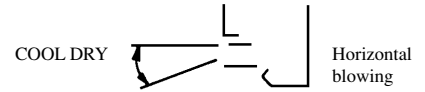

(c) Swing flap

Flap moves in upward and downward directions continuously.

(2) Back-up Switch

When the remote controller batteries become weak, or if the remote controller is lost or malfunctioning, this switch may be used to turn the unit on and off.

(a) Operation

Push the switch once to place the unit in the automatic mode. Push it once more to turn the unit off.

(b) Details of operation

The unit will go into the automatic mode in which it automatically determines, from room temperature (as detected by sensor), whether to go into the cooling, thermal dry or heating modes.

Function / Operation mode	Room temperature setting	Fan speed	Flap	Timer switch
Cooling	About 26°C	Auto	Natural flow	Continuous
Thermal dry	About 25°C			
Heating	About 25°C			

On operating in automatic operation mode by back-up switch, functions shown in the above table are not altered, while, the other micro-computer control functions remain effective.

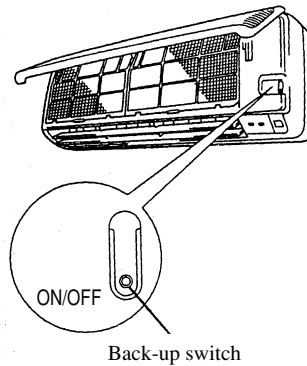

(3) AUTOMATIC operation

(a) When starting operation after more than 1 hour since operation stops

(Operation stop button ON or ON-Timer), this system operates indoor fan with Lo for 20 seconds checks room temperature and allowing decision of operating mode automatically.

	21°C ≤ Room temperature < 26°C	26°C ≤ Room temperature
Operation Mode	Dry	Cooling

Note (1) Operating Mode is not altered due to change of room temperature.

When intended to change operating mode, switch operation change over dial to the intended mode.

(b) Established temperature (operate by the established temperature button on remote controller).

		Wireless remote control signal (Indication)												
		-6	-5	-4	-3	-2	-1	±0	+1	+2	+3	+4	+5	+6
Temperature setting	Cooling	20	21	22	23	24	25	26	27	28	29	30	31	32
	Thermal dry	19	20	21	22	23	24	25	26	27	28	29	30	31

(4) Operation control function by remote control switch

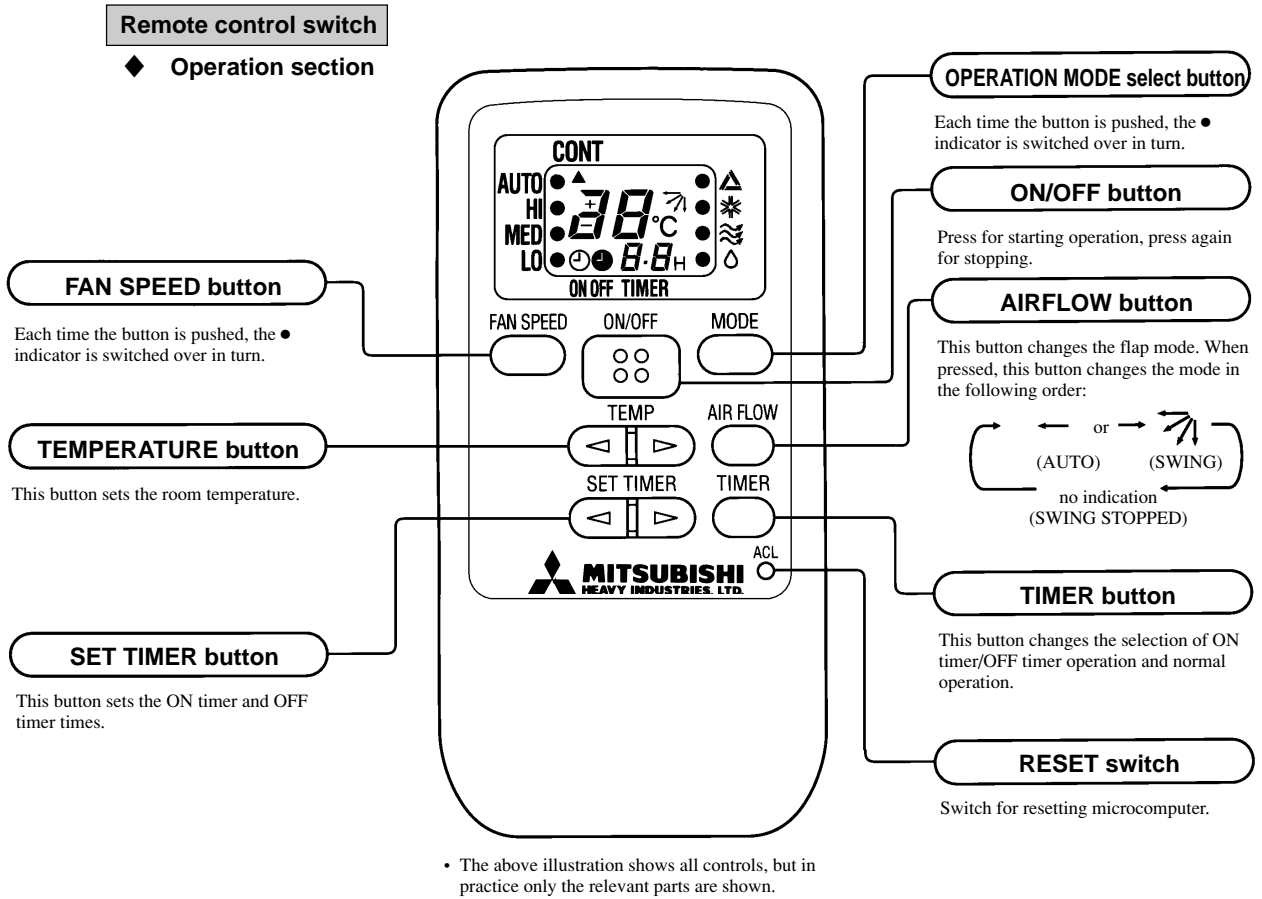

◆ **Indication section**

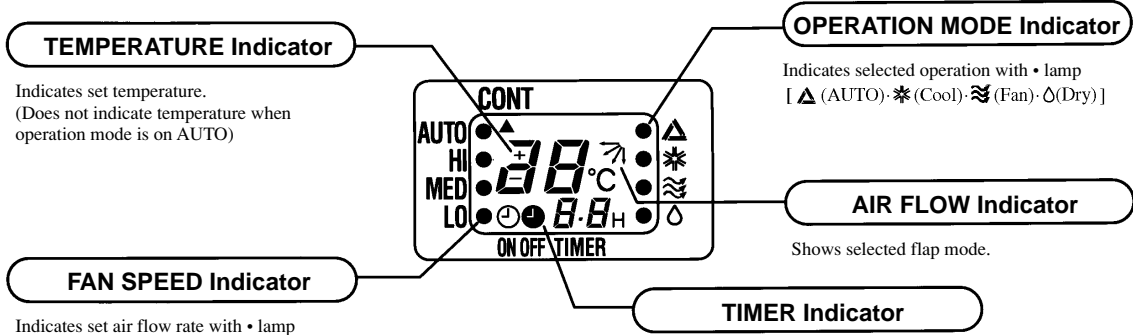

Unit indication section

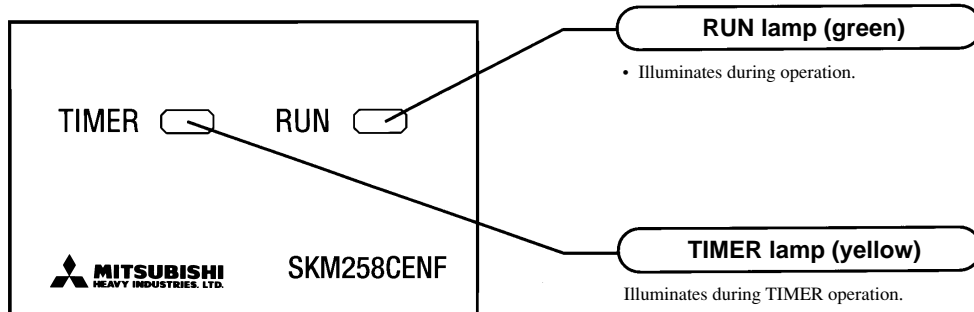

(a) Comfort timer settings

Temperature is checked beginning 1 hour before the set time, and the power is turned on before the timer setting as necessary to bring the temperature to the proper level by the set time.

Operation mode	Room temp. thermistor (Th1)	Operating time (amount of time previous to set time that operation begins)
Cooling	Over 40°C	60 mins.
	Over 35°C	30 mins.
	Over 30°C	15 mins.
	Under 30°C	5 mins.

(b) Timer time setting

The turn-off timer and turn-on timer can be set for up to 12 hours in units of 1 hour.

(c) Night time turn off

Placing the timer to this setting changes the temperature setting of the indoor set button as follows:

Cooling, thermaldry

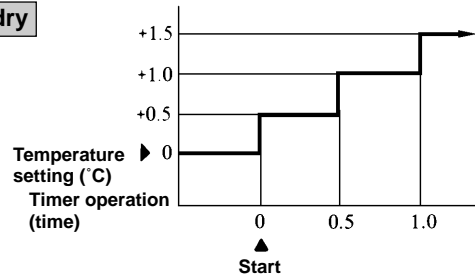

(d) Temperature adjustment

- 1) Temperature adjustment setting may be set between 18 and 30°C.
- 2) The compressor and outdoor fan are turned on and off as shown below according to the temperature setting.

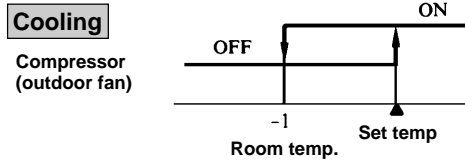

- 3) During the continuous mode, the compressor runs continuously in both cooling. For thermal dry, please refer to page 248.

(e) Fan control

- (i) Fan speed change

Mode	COOL	FAN
Fan speed knob		
AUTO	See below	
LOW	Speed 1 (Speed 1)	Speed 1 (Speed 1)
MED	Speed 2 (Speed 2)	Speed 2 (Speed 2)
HIGH	Speed 3 (Speed 4)	Speed 3 (Speed 3)

Note (1) Please refer to page 248 for dry operation.

(ii) Fan speed knob : AUTO

The indoor fan is automatically controlled in accordance with the difference between the room temperature (detected by the room temperature sensor) and the thermostat setting as shown below.

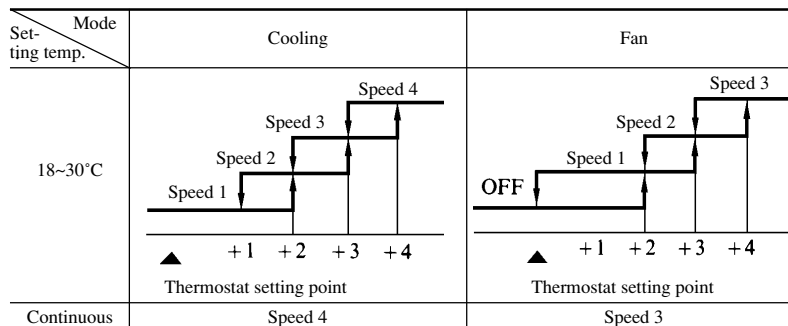

Note (1) Please refer to page 248 for dry operation.

(5) DRY operation

(a) Choose the appropriate operation block area by the difference between room temperature and thermostat setting temperature as shown below.

• Operation block area

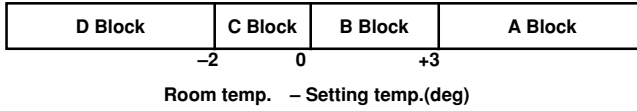

(b) Start up operation

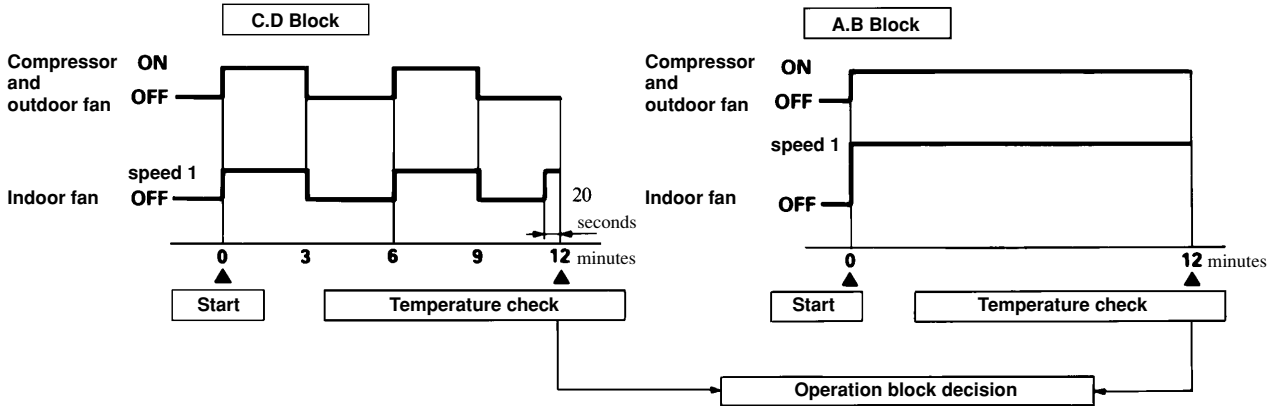

Note (1) Thermostat operation is performed in A.B.Block. When compressor and indoor fan stop by thermostat operation within 12 minutes from start, temperature check is performed by operating indoor fan at Speed 1 (Lo) for 20 seconds before finishing 12 minutes and allowing decision of next operation block.

(c) DRY operation

After finishing start up operation described in (b) above, thermal dry operation is performed at 8 minutes intervals, according to the difference between room temperature and thermostat setting temperature as shown below.

Besides, 1 cycle of this operating time consists of 8 minutes. 7 cycle operation is performed then.

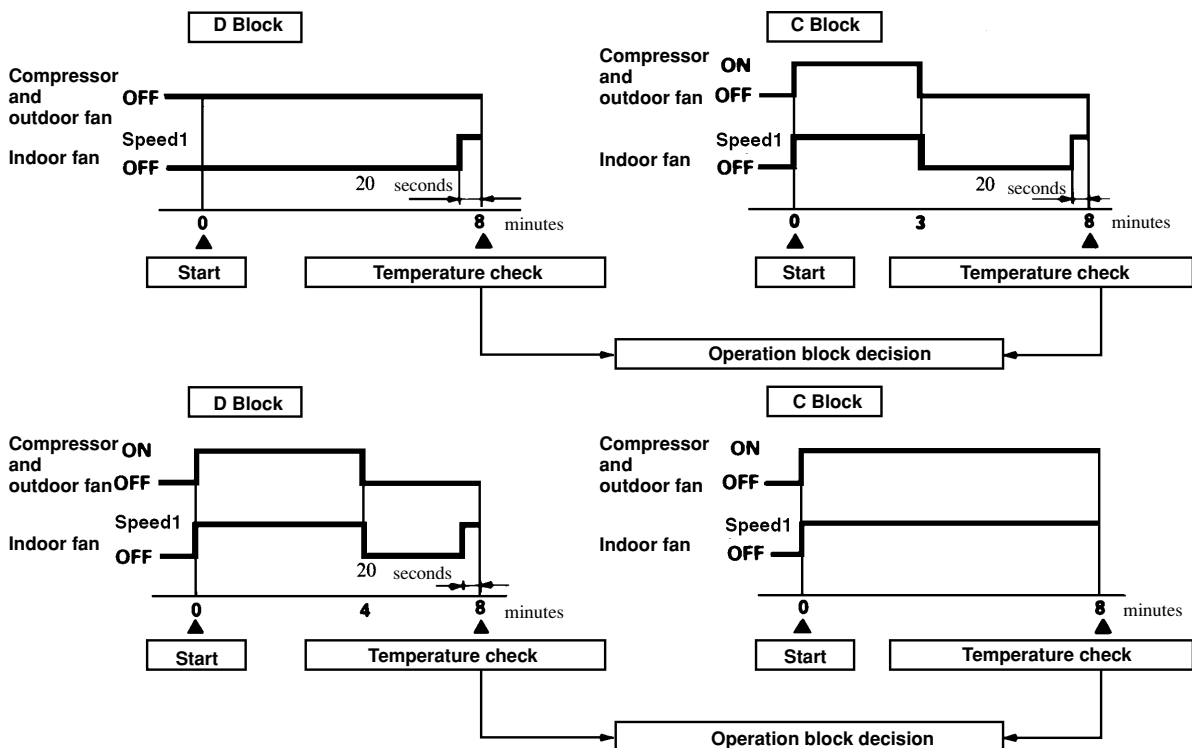

(6) Dew condensation prevention control for cooling operation

This prevents dew condensation, in the indoor unit, from occurring.

- (a) **Operating condition:** when 52C is kept ON for 30 min, after the unit starts operation.
- (b) **Operation content:** forces the indoor fan to change from Speed 1 to Speed 2.
- (c) **Resetting condition:** When 52C is off, or when dew condensation prevention control has operating continuously for 30 minutes.

(7) Frost prevention for indoor heat exchanger [Preventing frost accumulation on the indoor heat exchanger]

During the Cooling or Dry operation in low room air temp. condition, evaporating temperature will decrease and consequently indoor heat exchanger sometimes gets clogged with frost (or ice).

In order to prevent this trouble, compressor is stopped by under mentioned condition by indoor heat exchanger thermistor (Th₂) and timer (built into micro computer circuit) functions.

Also indoor fan is changed over to Lo speed.

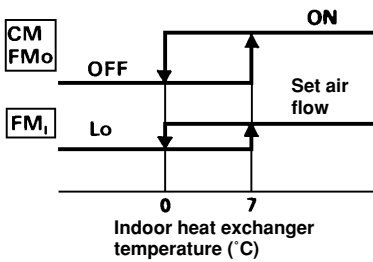

CM, FM_o stoppage condition

- ① Temperature of heat exchanger is 0°C or lower.
- ② As least 10 minutes has passed since the compressor started.

CM, FM_o stoppage condition

- ① Temperature of heat exchanger is 7°C or lower.
- ② As least 3 minutes has passed since the compressor started.





(8) Self diagnosis Function

We are constantly to do better service to our customers by installing such judges that show abnormality of operation as follows.

- (a) **Abnormality of heat exchanger thermistor:** RUN lamp will flashing when the input temperature of the heat exchanger thermistor measures less than -20°C for more than 3 seconds with the airconditioner “OFF”. (will not flashing during operation)
- (b) **Abnormality room temperature thermistor:** RUN lamp will flashing when the input temperature of the room temperature thermistor measures less than -20°C for more than 3 seconds with the airconditioner “OFF”. (will not flashing during operation)
- (c) **Abnormality of indoor fan motor** The indoor fan motor revolves at a rate under 300 rpm for 30 seconds or longer, the RUN lamp will flash.

7.5 APPLICATION DATA



SAFETY PRECAUTIONS

- Please read these “Safety Precautions” first then accurately execute the installation work.
- Though the precautionary points indicated herein are divided under two headings,  and , those points which are related to the strong possibility of an installation done in error resulting in death or serious injury are listed in the  section. However, there is also a possibility of serious consequences in relationship to the points listed in the  section as well. In either case, important safety related information is indicated, so by all means, properly observe all that is mentioned.
- After completing the installation, along with confirming that no abnormalities were seen from the operation tests, please explain operating methods as well as maintenance methods to the user (customer) of this equipment, based on the owner’s manual. Moreover, ask the customer to keep this sheet together with the owner’s manual.

WARNING

- This system should be applied to places as households, residences and the like. Application to inferior environment such as engineering shop could cause equipment malfunction.
- Please entrust installation to either the company which sold you the equipment or to a professional contractor. Defects from improper installations can be the cause of water leakage, electric shocks and fires.
- Execute the installation accurately, based on following the installation manual. Again, improper installations can result in water leakage, electric shocks and fires.
- For installation, confirm that the installation site can sufficiently support heavy weight. When strength is insufficient, injury can result from a falling of the unit.
- For electrical work, please see that a licensed electrician executes the work while following the safety standards related to electrical equipment, and local regulations as well as the installation instructions, and that only exclusive use circuits are used.
Insufficient power source circuit capacity and defective installment execution can be the cause of electric shocks and fires.
- Accurately connect wiring using the proper cable, and insure that the external force of the cable is not conducted to the terminal connection part, through properly securing it improper connection or securing can result in heat generation or fire.
- Take care that wiring does not rise upward, and accurately install the lid/service panel. It’s improper installation can also result heat generation or fire.
- When setting up or moving the location of the air conditioner, do not mix air etc. or anything other than the designated refrigerant (R22) within the refrigeration cycle.
Rupture and injury caused by abnormal high pressure can result from such mixing.
- Always use accessory parts and authorized parts for installation construction. Using parts not authorized by this company can result in water leakage, electric shock, fire and refrigerant leakage.
- Ventilate the work area when refrigerant leaks during the operation. 
Coming in contact with fire, refrigerant could generate toxic gas.
- Confirm after the foundation construction work that refrigerant does not leak.
If coming in contact with fire of a fan heater, a stove or movable cooking stove, etc., refrigerant leaking in the room could generate toxic gas.

CAUTION

- Execute proper grounding. Do not connect the ground wire to a gas pipe, water pipe, lightning rod or a telephone ground wire. 
Improper placement of ground wires can result in electric shock.
- The installation of an earth leakage breaker is necessary depending on the established location of the unit.
No installing an earth leakage breaker may result in electric shock.
- Do not install the unit where there is a concern about leakage of combustible gas. 
The rare even of leaked gas collecting around the unit could result in an outbreak of fire.
- For the drain pipe, follow the installation manual to insure that it allows proper drainage and thermally insulate it to prevent condensation. Inadequate plumbing can result in water leakage and water damage to interior items.

Remark per EMC Directive 89/336/EEC
 For to prevent flicker impressions during the start of the compressor (technical process) following installation conditions do apply.

1. The power connection for the air conditioner has to be done at the main power distribution. This distribution has to be of an low impedance. Normally the required impedance is reached at a 32A fusing point. Air conditioner fuse has to be 16A max.
2. No other equipment has to be connected to this power line.
3. For detailed installation acceptance please refer to your contract with the power supplier, if restrictions do apply for products like washing machines, air conditioners or electrical ovens.
4. For power details of the air conditioner refer to the rating plate of the product.

7.5.1 Selection of location for installation

(1) Indoor unit

- (a) Where there is no obstructions to the air flow and where the cooled air can be evenly distributed.
- (b) A solid place where the unit or the wall will not vibrate.
- (c) A place where there will be enough space for servicing.
(Where space mentioned below can be secured)
- (d) Where wiring and the piping work will be easy to conduct.
- (e) The place where receiving part is not exposed to the direct rays of the sun or the strong rays of the street lighting.

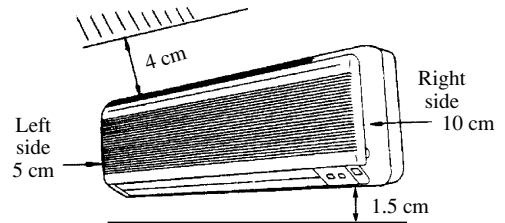

(2) Outdoor unit

- (a) A place where good air circulation can be obtained.
- (b) A place where the exhausted air will not be sucked in for the second time.
- (c) A place where the unit will not be affected by other heat sources.
(When there are several units installed or another heat source)
- (d) Do not install the unit near the seaside, or where there is possibility of chlorine gas generation.
- (e) A place where discharged hot and cold air or unit's operating sound will not be a nuisance to the neighborhood.
- (f) A place where servicing space can be secured.
- (g) A place where vibration will not be enlarged.
- (h) In heating operation, snow deposit on the heat-exchanger of outdoor unit must be prevented for keeping the normal performance capacity.
 - (i) Snow-hood on outdoor unit as in drawing, will reduce the frequency of defrost operation.
When installing the snow hood, take care so that the air outlet of the snow food will not face directly into the most windy direction.
 - (ii) Design the base higher than possible snow deposit.

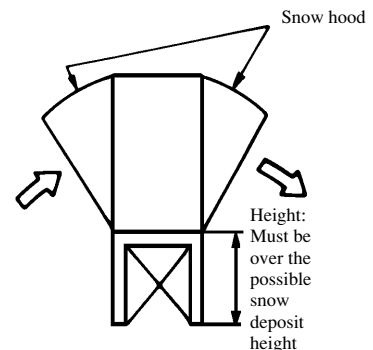
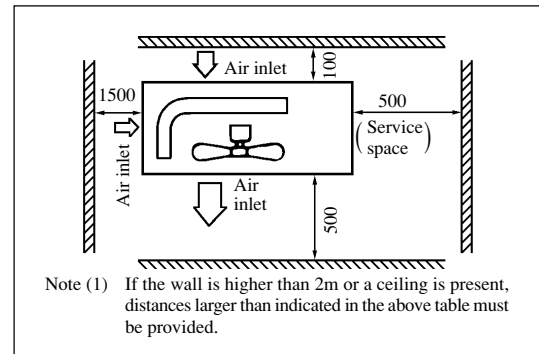

(3) Limitations for one way piping length and vertical height difference

- SCM328CENF-L1

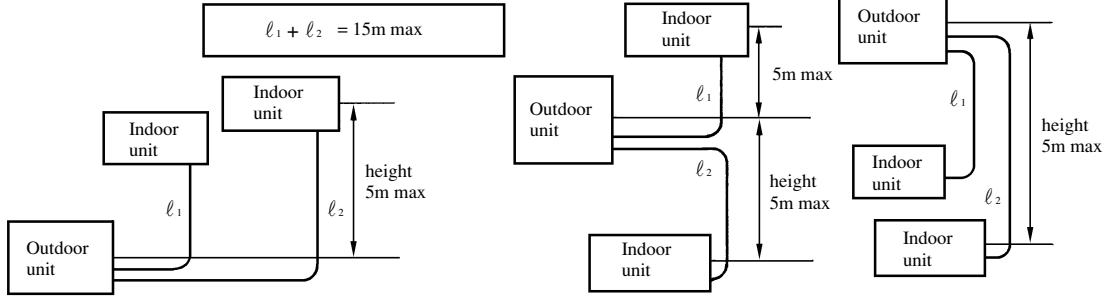

- SCM338CENF-L1

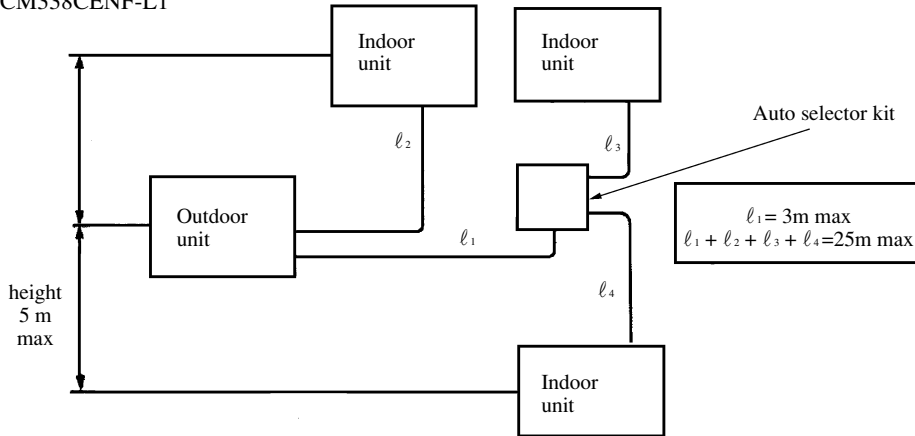

7.5.2 Installation of indoor unit

(1) Installation if installation board

(a) Fixing of installation board

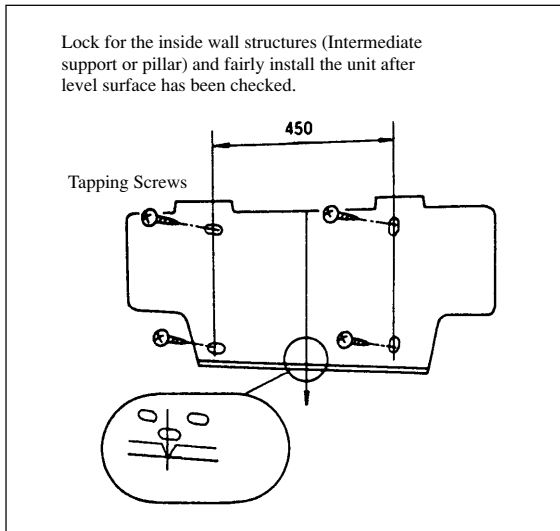

Adjustment of the installation board in the horizontal direction is to be conducted with four screws in a temporary tightened state.

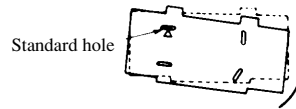

Adjust so that board will be level by turning the board with the standard hole as the center.

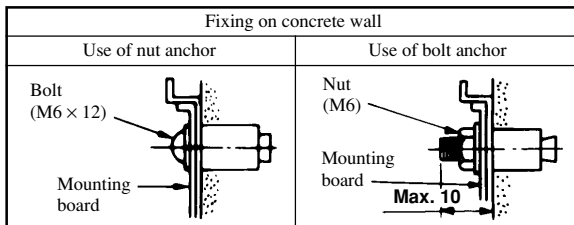

(2) Drilling of holes and fixture sleeve (Option parts)

(a) Drill a hole with $\phi 65$ whole core drill

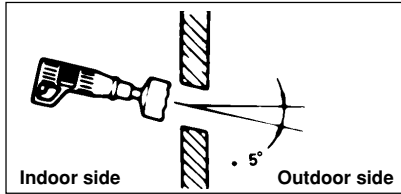

Note (1) Drill a hole with incline of 5 degree from indoor side to outdoor side.

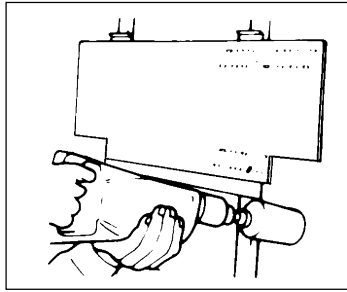

(b) Adjusting sleeve length

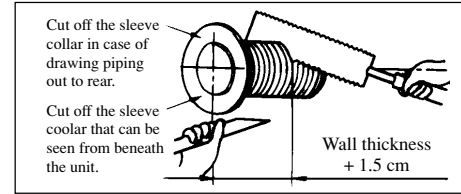

(c) Install the sleeve

(Inserting sleeve)

(*Sleeve + *Inclined + *Sealing plate)

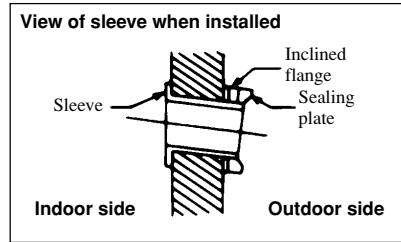
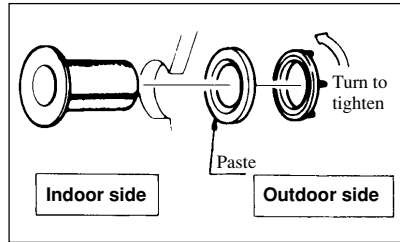
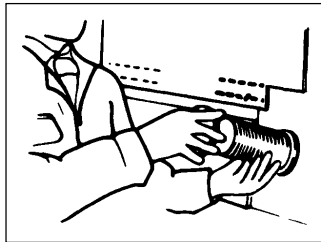

(3) Preparation of indoor unit

(a) Mounting of connecting wires

- (i) Remove lid.
- (ii) Remove cover, terminal block cover.
- (iii) Connect the connection wire securely to the terminal block.

Use cables for interconnection wiring to avoid loosening of the wires. CENELEC code for cables Required field cables.
 H05 RNR3G1.5 (Example)
 H Harmonized cable type
 05 300/500 volts
 R Natural-and/or synth, rubber wire insulation
 N Polychloroprene rubber conductors insullation
 R Stranded core
 3or5 Number of conductors
 G One conductor of the cable is the earth conductor (yellow/green)
 1.5 Section of copper wire (mm²)

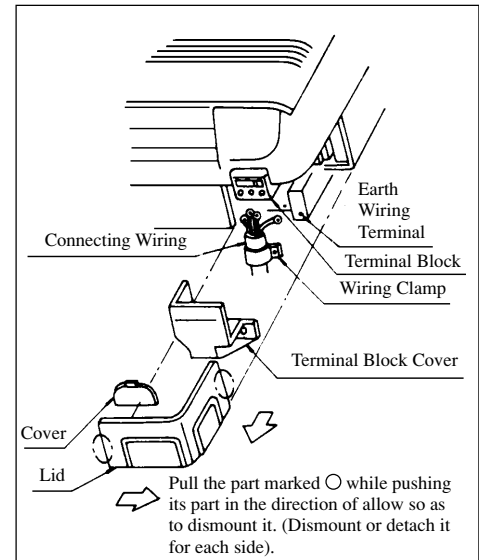

- ① Affix the connection wire securely to the terminal block. If the wire is not affixed completely, contact will be poor, and it is dangerous as the terminal block may heat up and catch fire.
- ② Take care not to confuse the terminal numbers for indoor and outdoor connections.
- ③ Affix the connection wire using the wiring clamp.

- (iv) Attach the terminal bock cover.
- (v) Attach the lid.

(b) Protective taping (Protect the cable with tape at the section where the cable passes through the hole opened on the wall.)

(c) Forming of pipe (Holding down the pipe at the root, change the pipe direction, extend it and adjust according to the circumstance.)

[When the pipe is extended to left and taken out from the rear center]

(Drain pipe relocation procedure)

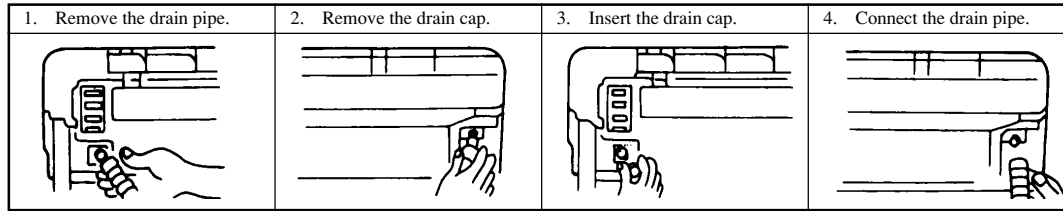

- Loosen the spring clamp to remove.
- Remove by hand or use cutting pliers, etc.
- Securely insert the drain cap removed in the step 2.
Note: If it is inserted insufficiently, water leakage could result.
- Loosen the spring clamp and securely insert the drain pipe.
Note: If it is inserted insufficiently, water leakage could result.

- When arranging the pipe through a hole opened at the center, open the knockout hole using nippers, etc.

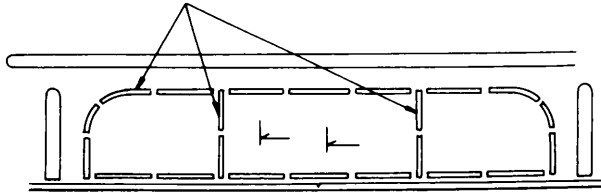

Note (1) It is designed to collect moisture accumulated on the rear face in the drain pan. Be sure not to accommodate the power cable, etc. above the chute.

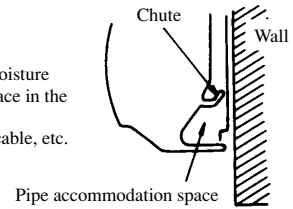

(4) Installation on indoor unit

(a) Install the indoor unit on the mounting plate.

Hook the upper part of the indoor unit on the stoppers disposed at the upper part of the mounting plate and lightly push the lower part of the indoor unit so that the unit is fixed in position.

- When removing the indoor unit
 - ① Disconnect the lid at right and left.
 - ② Pull down the stoppers (right and left) provided at the bottom of the indoor unit base. (See the detail view shown at right.) (The stoppers are separated from the mounting plate.)

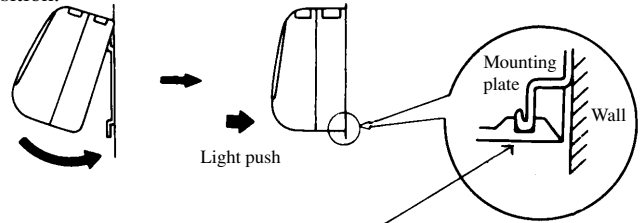

Indoor unit base bottom stopper (2 places at right, left)

(b) Be sure not to leave any trap on the drain pipe.

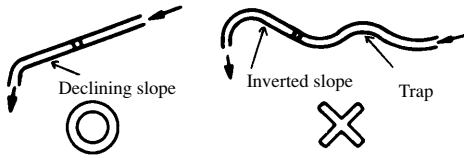

7.5.3 Installation of outdoor unit

- (1) Make sure that the unit is stable in installation. Fix the unit to stable base.
- (2) In wiring, make sure that the wire terminal numbers are match to the wire terminal numbers of indoor unit terminal block.
- (3) Terminal symbol A of the outdoor unit is used for A indoor unit and B for B indoor unit.

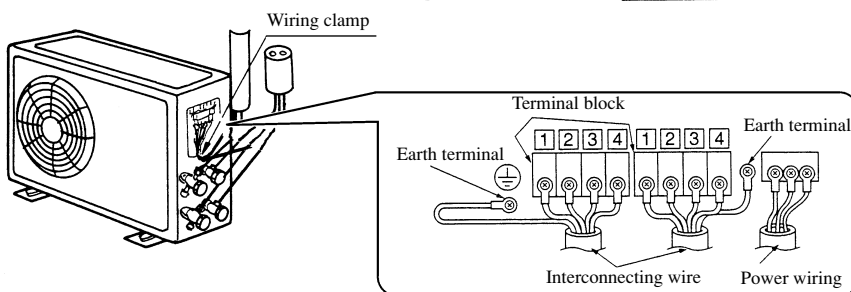
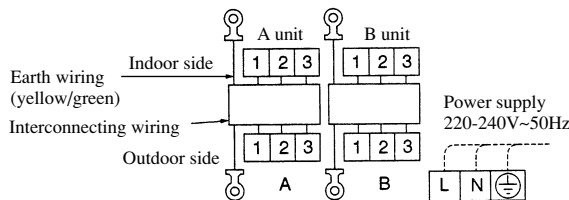

POWER SUPPLY CODE

CENELEC code for cables required field cables.
H05RNR3G 3.5

◆ Installation directions auto selector kit (only for SCM338 model)

(1) Selection of installation location

(Install at location that meets the following conditions after getting the approval from the customer).

- (a) Do not install the auto selector kit indoors.
- (b) A location where rain and snow will not directly strike the kit.
- (c) A location where servicing space is available.
- (d) A location where the kit can be supported and vibration will be minimized.

Piping length limitations

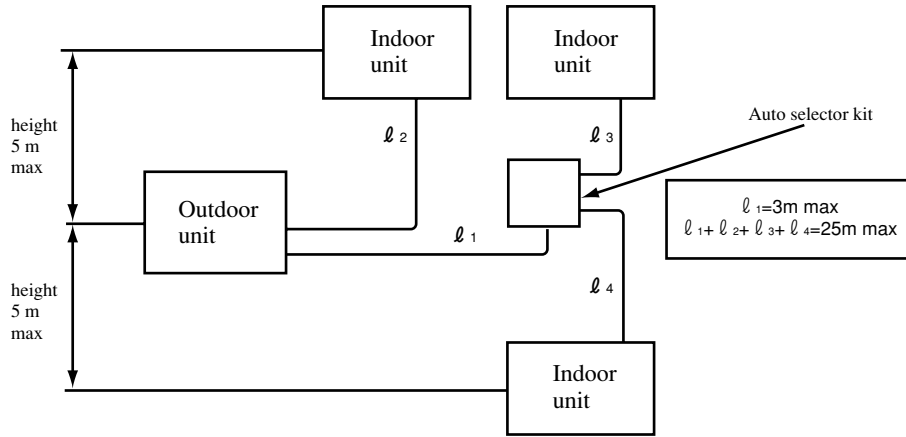

(2) Installation of auto selector kit

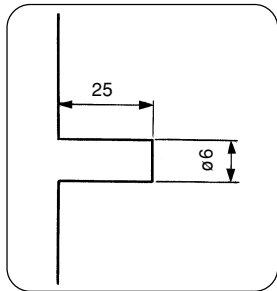

Make a $\phi 6 \times 25$ mm deep hole with a drill.

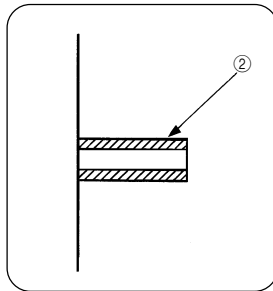

Drive in the sleeve (accessory No.2) to the hole.

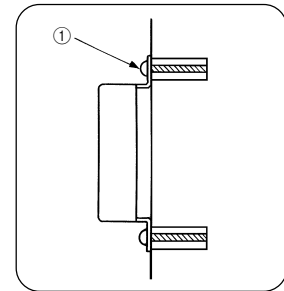

Secure the auto selector kit by the screw (accessory No.1). (Install as shown in Fig. 2.)

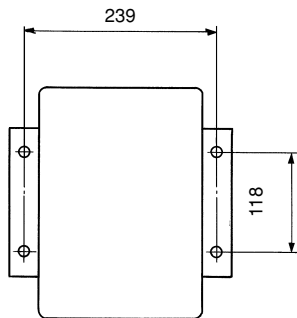

(Fig - 1)

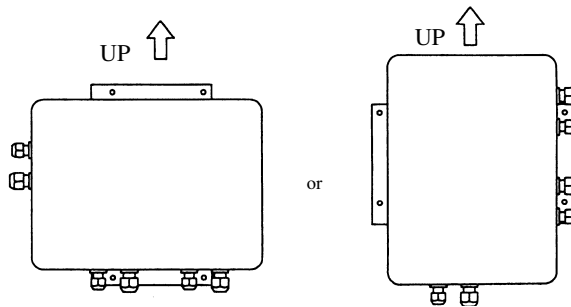

(Fig - 2)

⚠ CAUTION

Do not install the auto selector kit upside down. Wrong installation direction might cause electric shock.

(3) Mounting of interconnecting wires (Field wiring)

- Use cable for interconnection wiring to avoid loosening of the wires. CENELEC code for cables required field cables. H05 RNR3AG1.5
- Connect the connection wire securely to the terminal block.
- In wiring, make sure that the wire terminal numbers are matched to the wire terminal numbers of indoor unit terminal block.
- Terminal symbol OUTDOOR of the auto selector kit is used for outdoor unit, B for B indoor unit and C for C indoor unit.
- Affix the connection wire using the wire clamp. (Fig – 3)

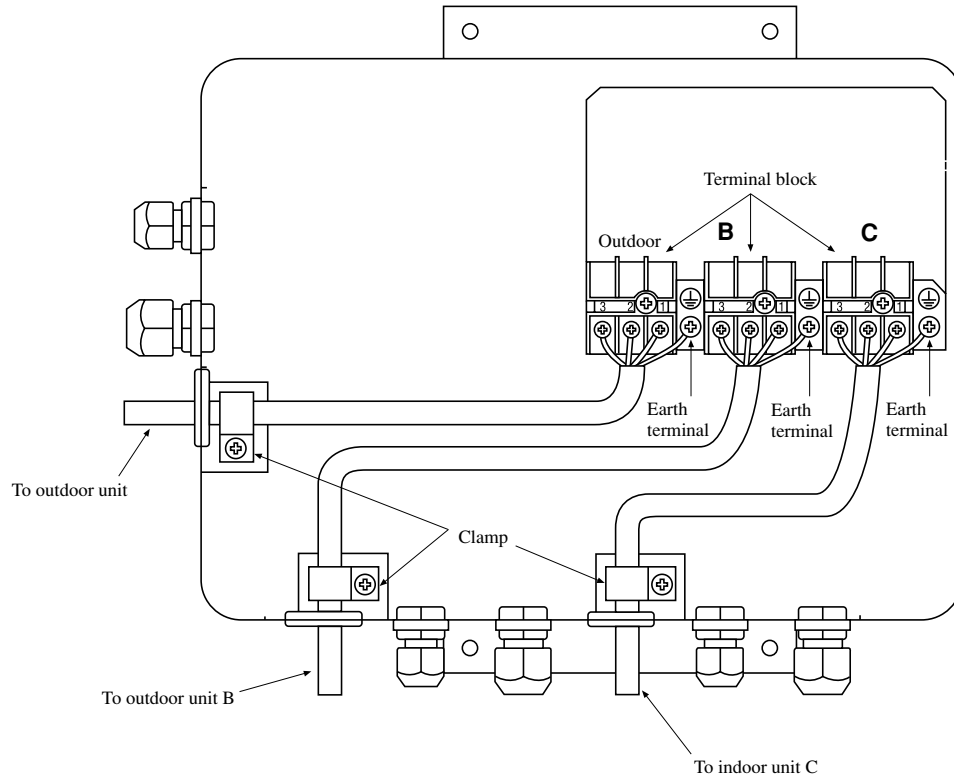

(Fig – 3)

(4) Connection of refrigerant pipings

- Use $\phi 6.35$ connecting pipe for the liquid and $\phi 9.52$ for the gas side.

Preparation

- Keep the openings of the pipes covered with tapes, etc. to prevent dust, sand and other foreign matters from entering inside the pipes.

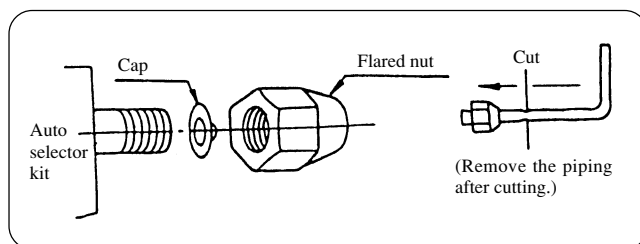

- Remove the flared nuts (on both liquid and gas sides)

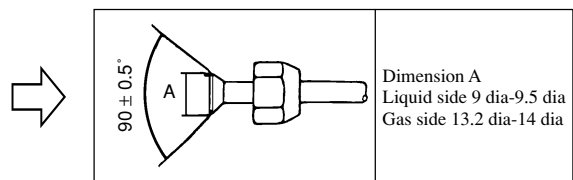

- Insert the removed flared nuts to the pipes to be connected, then flare the pipes.

Connection

- Assign the symbols of “A”, “B” and “C” to the indoor units, and paste the attached labels “A”, “B” and “C” on the respective indoor units. However, assign the symbol “A” to the indoor unit which is connected with the outdoor unit and connect SKM25. Also, assign symbols “B” and “C” to the indoor units connected with the auto selector kit.
- Flare coupling symbol of OUTDOOR UNIT on auto selector kit is used for outdoor unit, INDOOR UNIT B for indoor B unit and INDOOR UNIT C for indoor C unit.

7.5.4 Refrigerant piping

(1) Preparation

Keep the openings of the pipes covered with tapes etc. to prevent dust, sand, etc. from entering them.

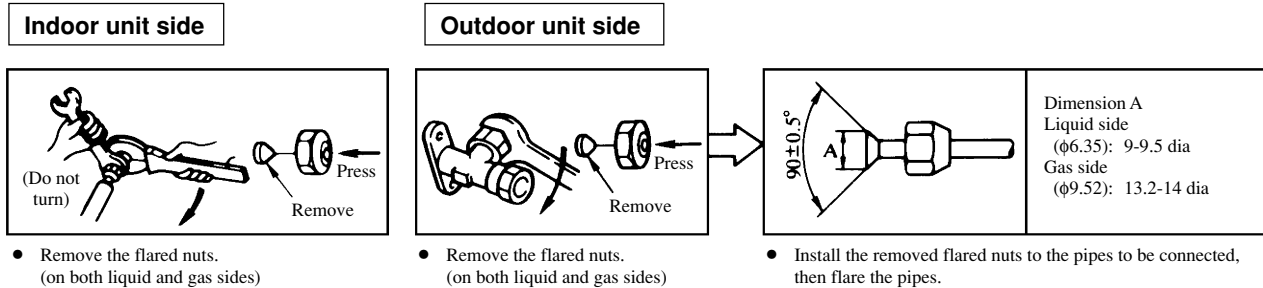

(2) Connection of refrigerant piping

Indoor unit side

- Connect firmly gas and liquid side pipings by Torque wrench.

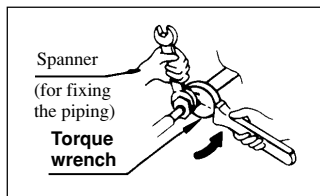

- Specified torquing value:
Liquid side (ø6.35) : 15.7~19.6 N·m (1.6~2.0kgf·m)
Gas side (ø9.52) : 29.4~39.2 N·m (3.0~4.0kgf·m)

Outdoor unit side

- Connect firmly gas and liquid side pipings by Torque wrench.

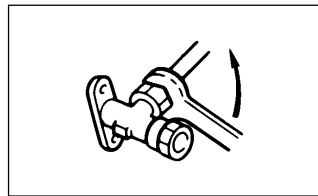

- Specified torquing value:
Liquid side (ø6.35) : 15.7~19.6 N·m (1.6~2.0kgf·m)
Gas side (ø9.52) : 29.4~39.2 N·m (3.0~4.0kgf·m)
- Use one more spanner to fix the valve.

- Always use a Torque wrench and back up spanner to tighten the flare nut.

(4) Air purge

- Tighten all flare nuts in the pipings both indoor and outside wall so as not to cause leak.
- Connect operating valve, charge hose, manifold valve and vacuum pump as is illustrated below.
- Open manifold valve handle Lo to its full width, and perform vacuum or evacuation.
 Continue the vacuum or evacuation operation for 15 minutes or more and check to see that the vacuum gauge reads 0.1 MPa (-76 cm Hg).
- After completing vacuum operation, fully open service valve (Both gas and liquid sides) with hexagon headed wrench.
- Check for possible leakage of gas in the connection parts of both indoor and outdoor.

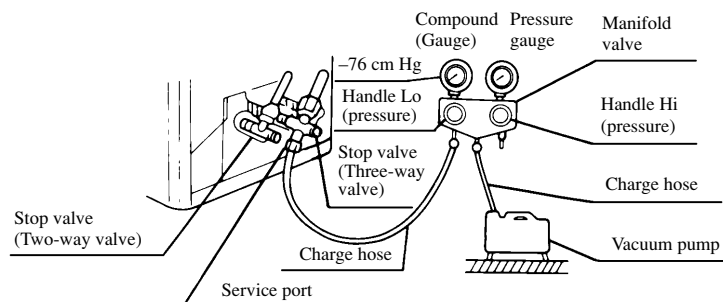

(5) Insulation of connecting portion

- 1) Cover the connecting portion of the refrigerant piping with the pipe cover and seal them.
If neglecting to do so, moisture occurs on the piping and water will drip out.

Cover the coupling with insulator and then cover it with tape

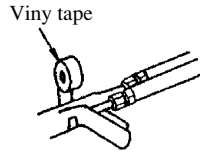

Place the slit upward

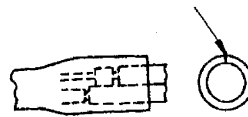

- 2) Finishing and fixing
 - a) Tie up the piping with wrapping tape, and shape it so that it conforms to which the pipe is attached.
 - b) Fix them with clamps as right figure.

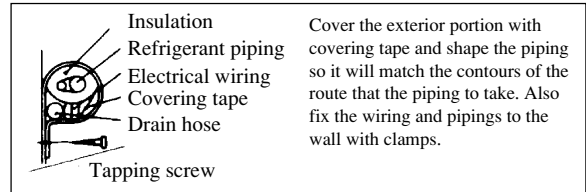

Cover the exterior portion with covering tape and shape the piping so it will match the contours of the route that the piping to take. Also fix the wiring and pipings to the wall with clamps.

7.5.5 Test run

- (1) Check carefully for gas leakage before performing the trial operation.
- (2) Make sure that drain flows properly. (Right figure)
- (3) If power source voltage is low and difficult to start air conditioner, ask your local electric power company to raise voltage. (Of it is not correct there may occur breaker trip or burning.)
- (4) Make sure that power source is wired as exclusive use for air conditioner and there is no looseness or play between plug socket and plug. (Plug socket is to be purchased locally.)
(When there is something wrong with the electric outlet and if the insertion of the electric plug is insufficient, there may occur a burn out.)
- (5) 3 minutes delay circuit operation under the following conditions:
 - (a) When the air conditioner is stopped by pressing ON/ OFF switch.
 - (b) When thermostat actuates.
 - (c) When operation is changed from cooling or dry to fan.
- (6) Explain well the correct usage of the air conditioner carefully to the customer following the instruction manual.
- (7) Standard operation data

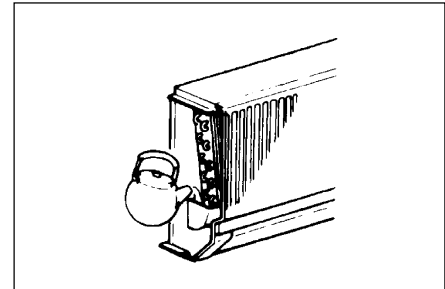

[Example]

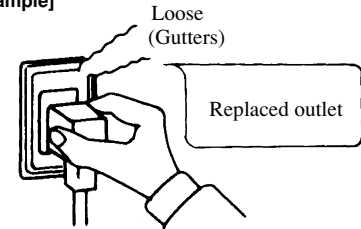

◆ SCM328CENF-L1

Model		One unit		Two units	
		Item	Model	One unit	Two units
High pressure MPa (kgf/cm ²)	Cooling	1.68~1.87 (17.1~19.1)	1.74~1.94 (17.8~19.8)		
Low pressure MPa (kgf/cm ²)	Cooling	0.44~0.60 (4.5~6.1)	0.60~0.74 (6.1~7.6)		
Temp. difference between return air and supply air of indoor unit (deg °C)	Cooling	9~11	8~10		

◆ SCM338CENF-L1

Model		One unit		Two units	
		25 type	32 type	25 + 25	25 + 32
High pressure MPa (kgf/cm ²)	Cooling	1.68~1.87 (17.1~19.1)	1.69~1.88 (17.2~19.2)	1.74~1.94 (17.8~19.8)	1.78~1.98 (18.2~20.2)
Low pressure MPa (kgf/cm ²)	Cooling	0.45~0.60 (4.6~6.1)	0.48~0.63 (4.9~6.4)	1.87~0.74 (6.1~7.6)	0.63~0.77 (6.4~7.9)
Temp. difference between return air and supply air of indoor unit (deg °C)	Cooling	9~11	10~12	8~10	25 side:8~10 32 side:5~7

7.5.6 Precautions for wireless remote controller installation and operation

(1) Wireless remote controller covers the following distances:

(a) When operating facing the air conditioner:

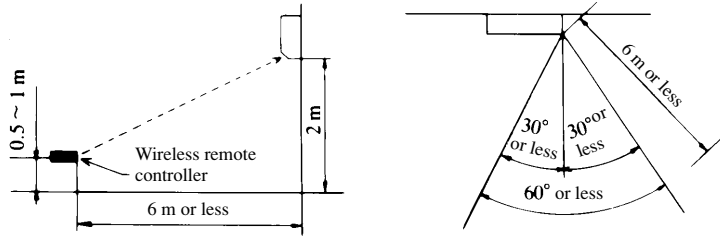

- Notes (1) The remote controller is correctly facing the sensing element of the air conditioner when being manipulated.
 (2) The typical coverage is indicated (in the left illustration). It may be more or less depending on the installation.
 (3) The coverage may be less or even nil. If the sensing element is exposed to strong light, such as direct sunlight, illumination, etc., or dust is deposited on it or it is used behind a curtain, etc.

(b) When manipulating the remote controller mounted on a wall:

Make sure that it works normally (i.e., transmission/reception signal is audible) before mounting.

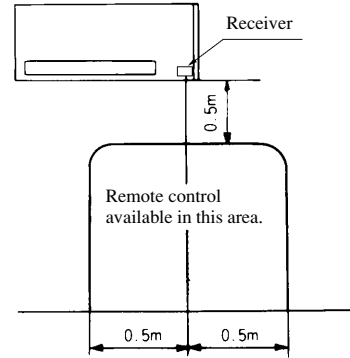

7.6 MAINTENANCE DATA

7.6.1 Trouble shooting

(1) Trouble shooting to be performed prior to exchanging PCB, (Printed circuit board) [Common to all models]

All the models described in this chapter are controlled by a microcomputer. When providing maintenance service to customers it is necessary to understand the function controlled by a micro computer thoroughly, so as not to mistakenly identify correct operations as mis-operations. It is also necessary to perform the following simple checks before conducting detailed checks or exchanging printed circuit board.

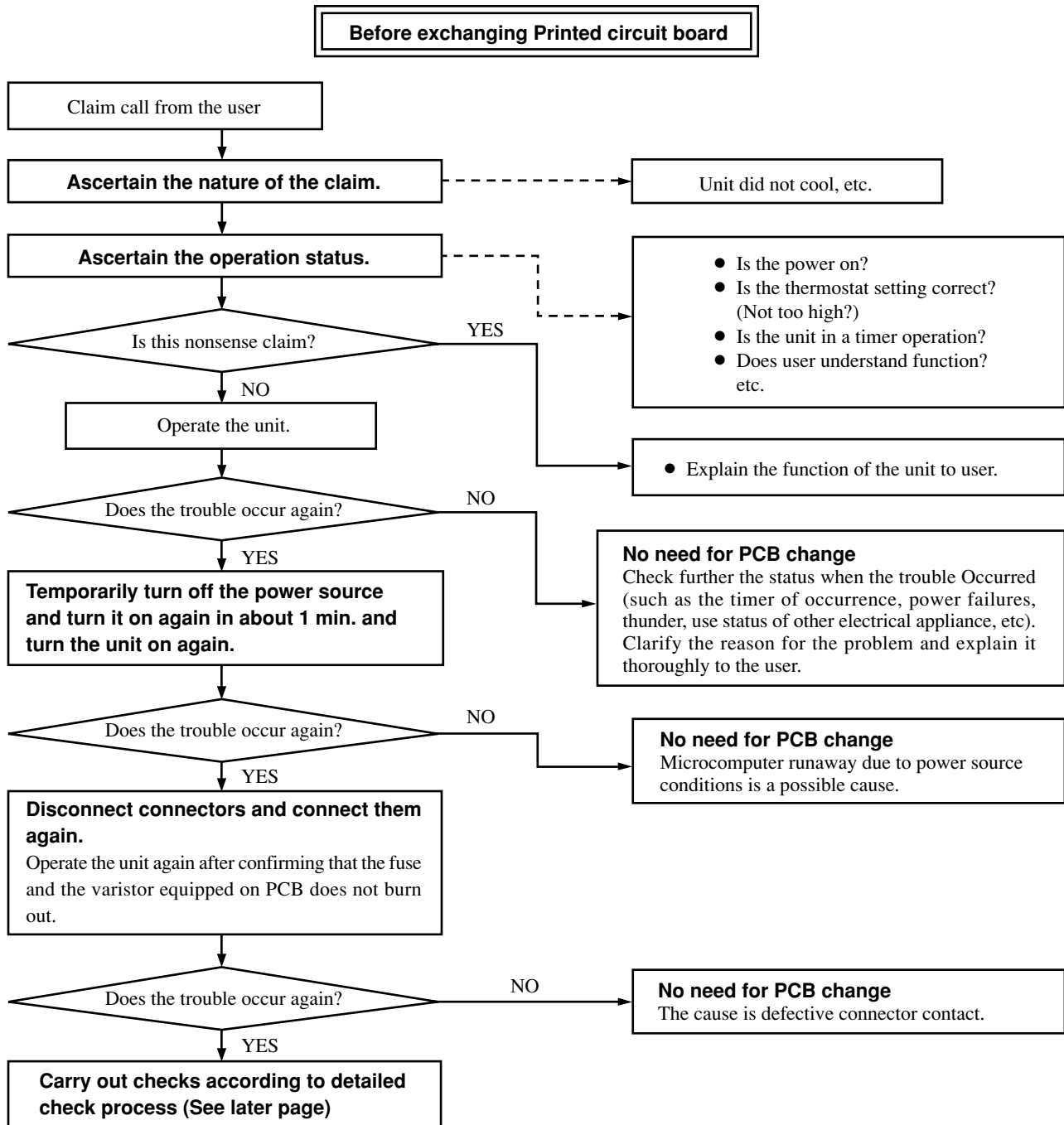

(2) Indication of Self Diagnosis (Indoor unit)

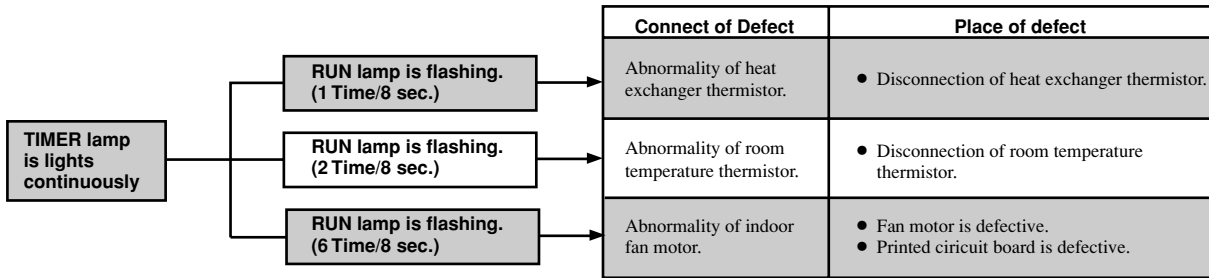

Abnormality of thermistor Disconnection of sensor and defective connection of connector

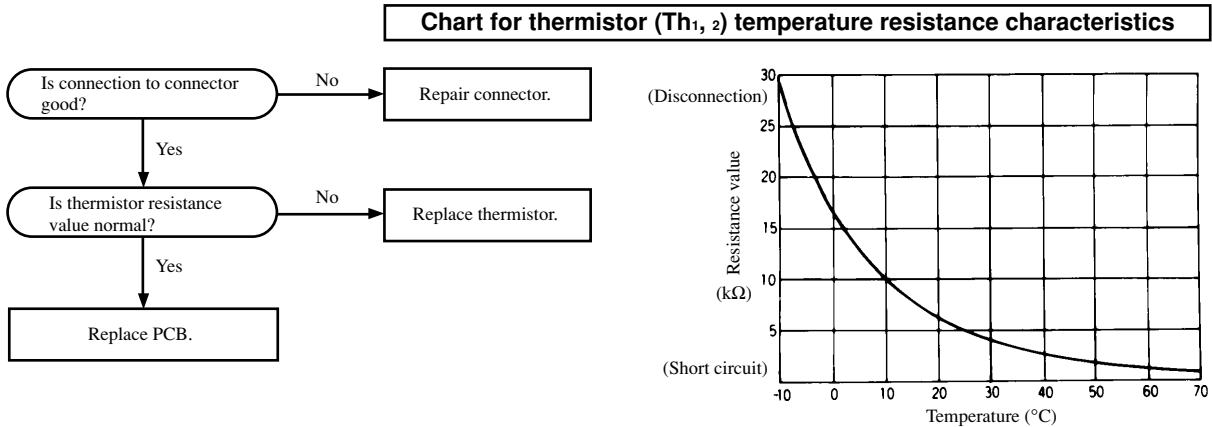

Abnormality of indoor fan motor (Fan motor defective, printed circuit board defective)

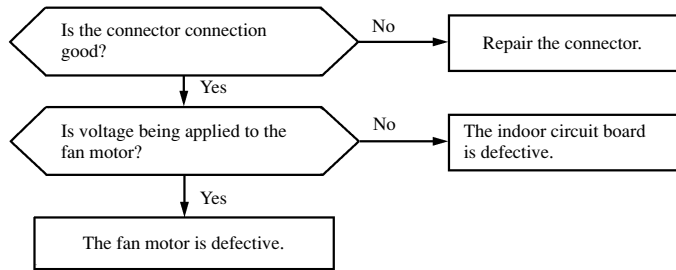

(3) Trouble Diagnostic Procedures

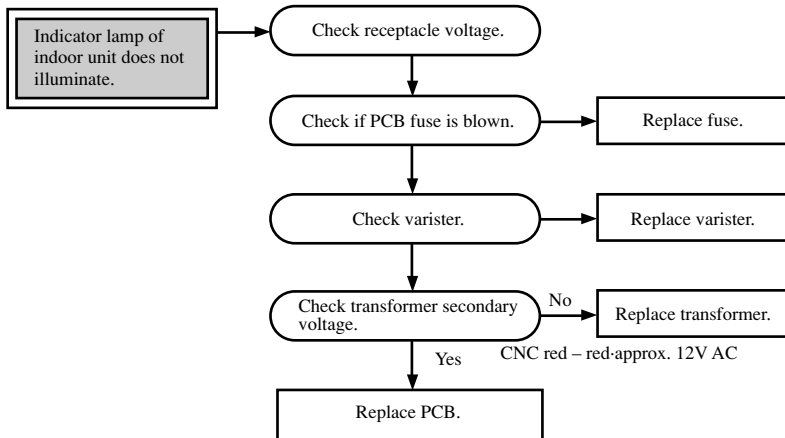

(4) Trouble shooting chart for the room temperature thermistor (Th₁), heat exchanger thermistor (Th₂)

Unit	Sensor	Operation	Function	
			Short circuit	Broken connection
Indoor Unit	Room temperature thermistor ⁽¹⁾ (Th ₁) except for "continuous" thermal setting	Cooling	Continuous Cooling operation • Cannot be turned ON/OFF by thermostat • When FM1 is on, "AUTO" is continuously Hi	Cooling will not operate • FM1: continuous operation • CM, FM0: stopped
	Heat exchanger thermistor (Th ₂)	Cooling	Cooling will not operate	Cooling will operate • Heat exchanger frost preventer begins to operate • Cools alternately for 10 minutes, stopping for 3 minutes

Note (1) When the room temperature thermistor (Th₁) will not operate normally. Cooling or heating operation may be run continuously by putting the thermostat setting on "CONTINUOUS".

(5) How to make sure of remote controller

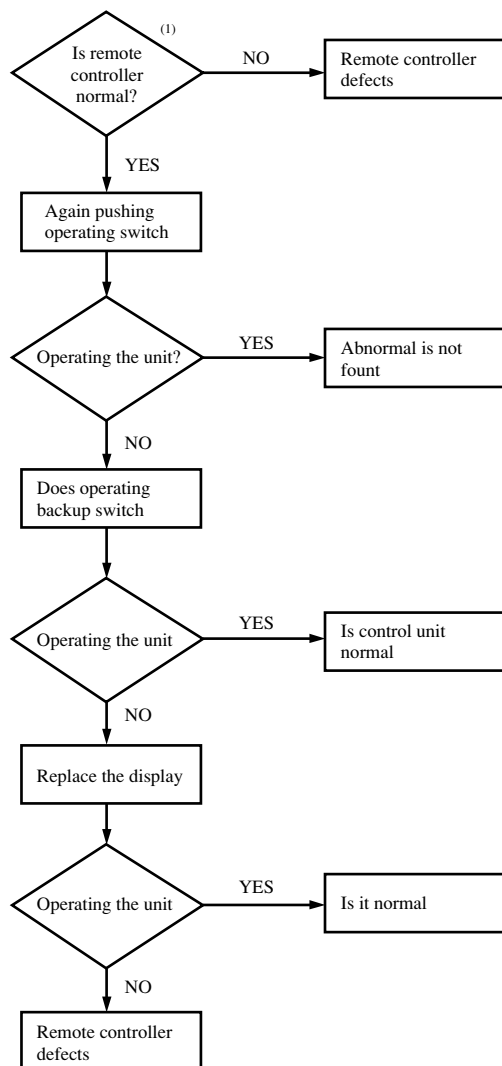

Note (1) How to check the remote controller

- (a) Press the reset switch of remote controller
- (b) It is almost normal if entire display of remote controller is shown after indication.

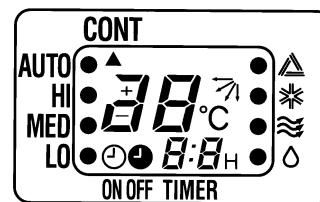

7.6.2 Servicing

(1) Evacuation

The evacuation is an procedure to purge impurities.....noncondensable gas, air, moisture from the refrigerant equipment by using a vacuum pump. Since the refrigerant R22 is very insoluble in water, even a small amount of moisture left in the refrigerant equipment will freeze, causing what is called water clogging.

• Evacuation procedure

- Check to ensure that there is no internal pressure in the unit. If there is an internal pressure, it should be relieved through the check joint.
- Connect the service hoses of the gauge manifold to the check joint of the gas & liquid piping.
- Connect a vacuum pump to the charge hose (A). Repeat evacuation in the following sequence.

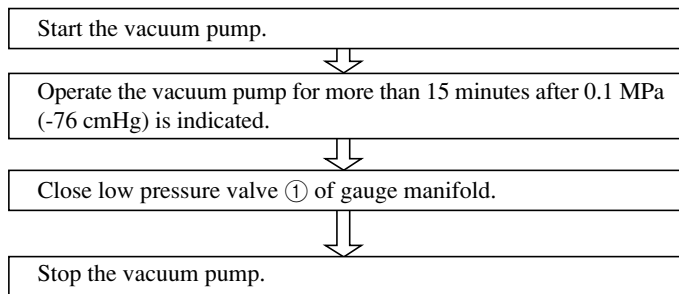

- Notes
- Do not use the refrigerant pressure to expel air.
 - Do not use the compressor for evacuation.
 - Do not operate the compressor in the vacuum condition.

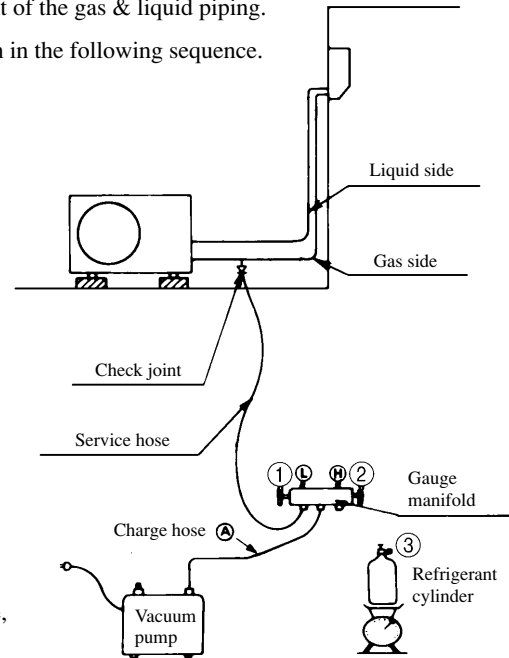

(2) Refrigerant charge

- Discharge refrigerant entirely from the unit and evacuate the unit.

Note: Addition of refrigerant without evacuation is unreasonable, because it will result in low charge or overcharge.

- Keep the gauge manifold and connect a refrigerant cylinder to the unit.
- Record the weight of the refrigerant cylinder on the balance. This is necessary for making sure of the charge refrigerant amount.
- Purge air from the charge hose (A)

Firstly loose the connecting portion of the charge hose (A) at the gauge manifold side and open the valve ③ for a few seconds, and then immediately retighten it after observing that gas is blow out from the loosened portion.
- Open the valve ① and ③ after discharging air form the charge hose (A), then the gas refrigerant begins flowing from the cylinder into unit. Be sure to erect the refrigerant cylinder upright to let gas refrigerant flow into the unit.
- When refrigerant has been charged into the system to some extent, **refrigerant flow becomes stagnant, when that happens, start the compressor in cooling cycle until the unit is filled with gas to the specified weight.**
- Making sure of the refrigerant amount, close the valve ③
- Disconnect the charge hose from the unit. Cover the valve ports of the refrigerant piping with caps and tighten them securely.
- Check for gas leakage by applying a gas leak detector along the piping line.
- Start the air conditioner and make sure of its operating condition.....high side and low side pressures and temperature difference between suction air and outlet air.