

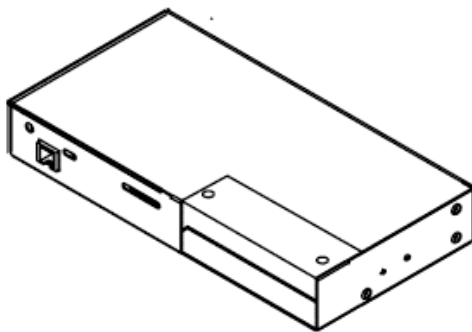

Mitsubishi Electric Air-conditioner Network System

**Central Controller
Model: GB-50A**

Installation Manual



Contents



1. Safety Precautions to be Observed without Fail	1
2. Confirmation of Parts	3
3. Product Feature	4
4. System Diagram	5
5. Installation Method	7
1. Part prepared at site	7
2. Allowable length of M-NET transmission lines.....	7
3. Installation method	8
6. Wiring Method	11
1. Grounding cable.	11
2. Cover removal and installation	11
3. M-NET transmission line	12
4. LAN connection	12
7. Initial setting	13
1. How to set the IP address with dip switches	14
2. Setting of the service switch.....	14
8. Test Run	15
1. Collective operation ON/OFF	15
2. Service LED display.....	15
9. Example for System Configuration.....	16
1. To control a K control model	16
2. To use system controllers on multiple units	16
10. External Input/Output Usage Method	16
1. External signal input function	16
2. External signal output function	18

Before using the controller, please read this Installation Manual carefully to ensure correct operation. Store this Installation Manual in a location that is easy to find.

This manual describes the installation of the central controller and wiring to the air conditioner. Refer to the installation manual of the air conditioner. Carefully read item "1 Safety precautions to be observed without fail" before installing the unit.

1 Safety Precautions to be Observed without Fail

* Hazards and levels of danger that can occur due to incorrect handling are classified by the following symbols.

 WARNING	Incorrect handling can result in death, serious injury, etc.
 CAUTION	Incorrect handling can result in injury or damage to the building or its contents.

* After reading this manual, keep in a handy place. When removing or repairing the unit, give this manual to the installer. When the user changes, also give to the new user.

 **WARNING**

<p>Ask your dealer or technical representative to install. If incorrect installation is done by a customer, it may cause an electric shock, fire, etc.</p>	<p>Securely install the controller according to the installation manual. If installation is not correct, it may cause an electric shock, fire, etc.</p>
<p>Securely install in a place which can withstand the weight of the controller. If it is not enough, the unit may fall and cause an injury.</p>	<p>The electric work should be performed by authorized personnel according to the installation manual. Any lack of electric circuit or any deficiency caused by installation may result in an electric shock or fire.</p>
<p>Securely connect the wiring using the specified cables and fix them so that the stress from the cables is not applied to the terminal connection sections. If connection or fixing is not reliably connected, it may cause heat generation, a fire, etc.</p>	<p>Do not move and re-install the unit by yourself. If installation is not correct, it may cause an electric shock, fire, etc. Ask your dealer or technical representative.</p>
<p>Never modify or repair by yourself. If the controller is modified or a repair is not correct, it may cause an electric shock, fire, etc. Consult your dealer if repairs are necessary.</p>	<p>This appliance must be earthed (grounded). Make sure to install a protect earth(PE)/grounding line . Do not connect the PE (grounding) line to gas or water pipes, lightning conductors or telephone grounding lines. Improper grounding may cause an electric shock.</p>

 **CAUTION**

<p>Do not install the controller in a place where flammable gas could leak. If gas leaks and collects around the unit, it may cause a fire or explosion.</p>	<p>Do not install this controller in a place where the ambient temperature exceeds 40°C (104°F) or drops below 0°C (32°F), also do not install in a place where it is exposed to direct sunlight. It may cause a deformation or malfunction.</p>
<p>Do not use this controller in an abnormal environment. If the controller is used in a place where there is much oil (including machine oil), steam or sulfide gas, the performance of the controller may deteriorate or parts may be damaged.</p>	<p>Do not install this controller in a place where steam is generated such as bathroom, kitchen, etc. Avoid placing where water condenses on the walls. It may cause an electric shock or malfunction.</p>

 **CAUTION**

Perform wiring so the tension is not applied.

If tension is applied, it may cause disconnection, heat generation or a fire.

Do not wash this controller with water.

It may cause an electric shock or malfunction.

Use specified wires corresponding to the current capacity for wiring.

Otherwise it may cause power leakage, heat generation or fire.

Do not touch the PCB (Printed Circuit Board) with your hand or a tool. Also do not get dirt on the PCB.

It may cause a fire or malfunction.

Do not install this controller in a place where an acid or alkaline solution, special spray, etc. is used frequently.

It may cause an electric shock or malfunction.

Do not press the switches with sharp objects.

It may cause an electric shock or malfunction.

Do not connect an AC power source to the M-NET terminal blocks of this device.

It may cause a breakdown or fire.

Do not touch the switches with wet hands.

It may cause an electric shock or malfunction.

2

Confirmation of Parts

*Please confirm that in addition to this Installation Manual the following items are enclosed in the box.

No.	Part name	Qty.
1	Central controller	1
2	L-fitting	2
3	M3 (8mm (5/16in)) round head screw (for fixation of the fitting described in 2 above)	4
4	DIN rail attachment	2
5	M3 (6mm (1/4in)) round head screw (for fixation of the attachment described in 4 above)	8
6	Installation manual (this book)	1
7	Installation book	1

* The screws for installing to the control panel are not included. (M4 screws)

* In addition to the parts above, a power supply unit for transmission line, which supplies the power to the central controller through the transmission line, must be purchased. When R410A, however, the power can be supplied also from the R410A outdoor unit.

Unit that supplies the power to GB-50A	The number of connectable GB-50A	Remarks
PAC-SC50KUA	2 units *1	<ul style="list-style-type: none"> When only one GB-50A unit is connected Up to three other system controllers can be connected to the transmission line for central control (Up to three ON/OFF remote controllers, up to six system remote controllers, up to six schedule timers, or up to six group remote controllers can be connected.) When two GB-50A units are connected No other system controllers can be connected.
R410A outdoor unit (connected to the transmission line for central control)	1 unit	Replace CN41 (power-supply switch connector) with CN40 on only one outdoor unit. Connectable number of indoor units will decrease by 4 units.
Outdoor unit other than described above (connected to the indoor/outdoor transmission line)	1 unit	Connectable number of indoor units will decrease by 4 units.

*1: Cannot be connected to the different transmission line for central control in the different system.

* Use PAC-SC50KUA (power supply unit) when "Charge" function is used, or multiple outdoor units are connected. Connect only the M-NET terminal (TB2) on PAC-SC50KUA to the M-NET terminal on GB-50A.

3 Product Feature

1. Specification

Item	Contents	
Interface	M-NET	:DC30V/24V;0.13/0.15A
	External I/O	:DC12V or 24V (External power supply)
	Ethernet	:10Base-T
Environmental condition	Temperature	Operating range 0 to 40°C / 32 to 104°F Storage range -20 to 60°C / -4 to 140°F
	Humidity	30~90%RH (No condensation)
Dimensions	130(H) x 250(W) x 38 (D) mm/5 ¹ / ₈ (H) x 9 ⁷ / ₈ (W) x 1 ¹ / ₂ (D)in	
Weight	1.1kg/2 ¹ / ₂ lb	
Installation Environment	In the control panel box (indoor) *This unit is installed and used in a business office or equivalent environment.	

2. Outline dimensions

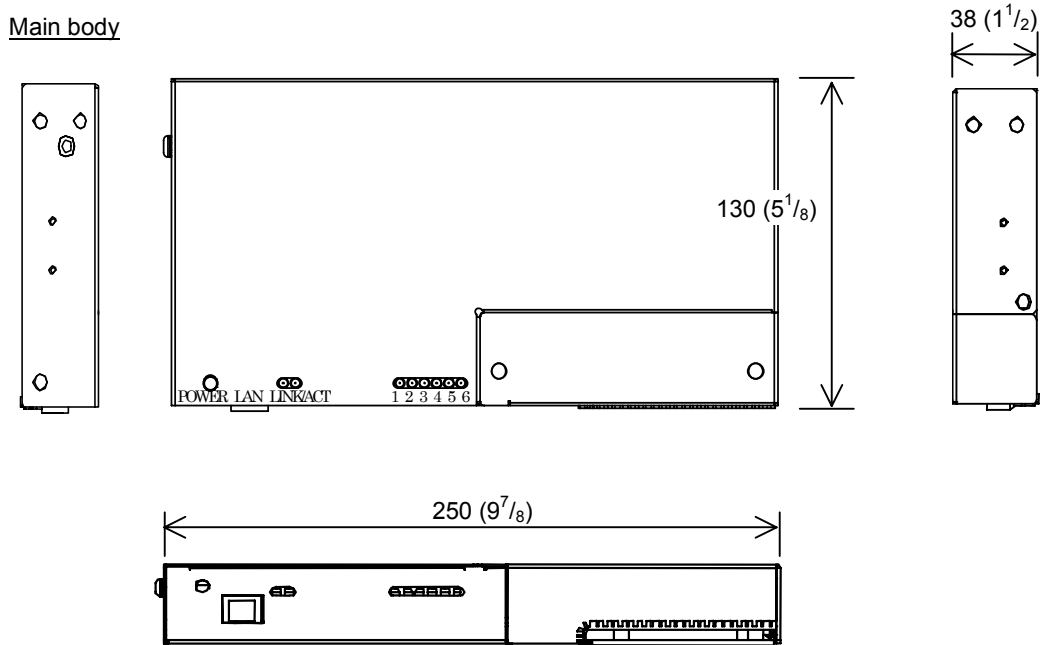

Fig. 3-1

Unit:mm(in)

L-fittings

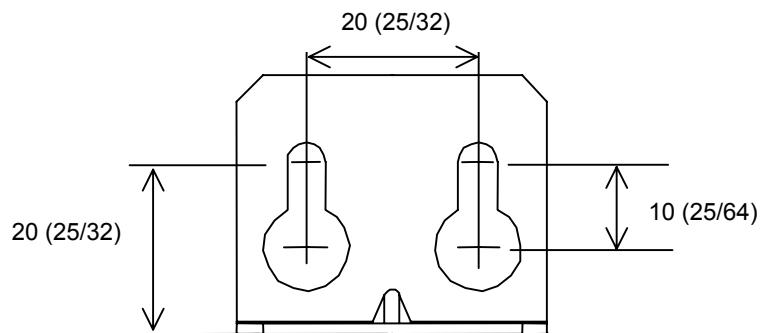
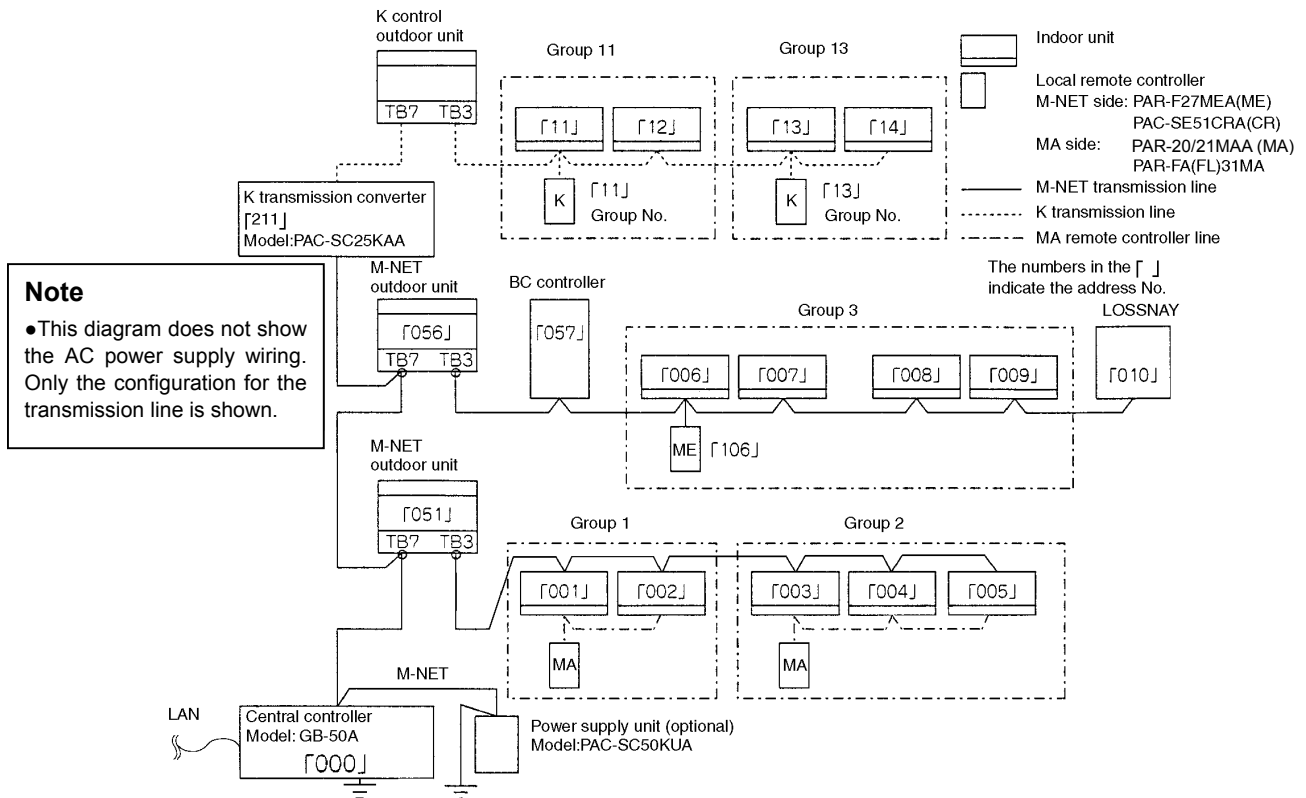

Fig. 3-2

Unit:mm(in)

4 System Diagram



- * Address setting for each M-NET device (The address cannot be duplicated.)
- * The K transmission converter (PAC-SC25KAA) and OA processing unit (LOSSNAY) are not included in systems shipped to North America (USA & Canada).

	Address setting method	Address
Indoor unit	Set the indoor unit you want to make them master unit in the same group to the minimum address, and sequentially set the indoor unit address in the same group.	1-50
Outdoor unit	Min. indoor unit address in same refrigerant system + 50	51-100
BC controller/OS controller * OS: Subsidiary Outdoor unit	Outdoor unit address in same refrigerant system + 1 However, for Sub-BC controller, minimum indoor unit address that connects the local refrigerant piping + 50.	52-100
K control side remote controller	Same address as indoor unit master unit	1-50
M-NET remote controller	Set to the minimum indoor unit master address in the same group + 100.	101-200
MA remote controller	Address setting is unnecessary.	-
OA processing unit/LOSSNAY	After setting all the indoor units, set an arbitrary address.	1-50
K transmission converter	Min. address of K control indoor unit + 200	201-250

NOTE

* The following precautions will apply when using the K transmission converter (model: PAC-SC25KAA) and controlling the M-NET model and K control model with the same controller.

Refer to the K transmission converter installation manual for details.

1) Central controller address

Always set the controller address to "00".

(Refer to section 7Initial setting .)

2) Central controller function selects

Always set the No.3 function selects of the controller to "ON".

(Refer to section 7Initial setting .)

3) Indoor unit address

Set all M-NET model indoor units from the No.1 unit, and then set the K control model addresses.

Indoor unit No.1 unit – M-NET indoor unit max. address->K control indoor unit min. address – 50.

4) K control model group No.

The min. indoor address No. of that group becomes the group No. (Same for K control side local remote controller.)

NOTE

* This system controller is designed as a main controller, not as a sub controller.

● Main system controller (main SC)

The main system controller is designed to control all units including the units that other system controllers control. When there is only one system controller in a system, it will become the main system controller. Group setting or interlock setting can be made only with the main system controller.

● Sub system controller (sub SC)

The sub system controller is designed to have its control area to be controlled by the main system controller.

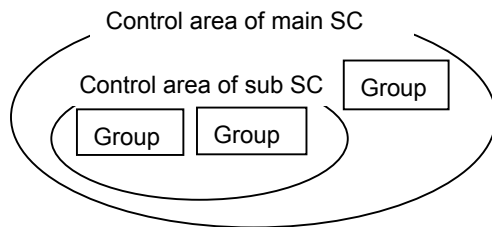

This system controller is designed as a main controller, so it cannot be controlled by a main SC (such as Gateway).

5 Installation Method

1. Parts prepared at site

Please prepare the following parts before installation of the unit.

Preparation parts	Specification
Unit fixing screw	M4 screw x 4pcs (when using L-fittings) *1
Protective earth cable (Ground cable)	Use sheathed vinyl cord or wire. Wire type : Wire should not be lighter than ordinary PVC sheathed flexible cord IEC 60227 (designation 60227 IEC 53) Wire size : 0.75mm ² to 2mm ² (AWG 18 to 14) Wire color : The color combination green/yellow
Round terminal	M4 screw size terminal (used for protective earth cable)
Transmission cable	Type of the cable; Sheathed vinyl cords or cable which comply with the following specifications or equivalent. <ul style="list-style-type: none"> • CPEVΦ1.2mm to Φ1.6mm • CVVS 1.25mm² to 2mm² (AWG 16 to 14) *CPEV: PE insulated PVC jacketed shielded communication cable *CVVS: PVC insulated PVC jacketed shielded control cable PE: Polyethylene PVC: Polyvinyl chloride

*1: When installing DIN rail, prepare 35mm(1.38inch) DIN rail. Mounting screws for DIN rail must be also procured separately.

Applicable DIN rail types (IEC 60715/DIN 60715): TH35-7.5Fe, TH35-7.5AI

2. Allowable length of M-NET transmission lines

- Maximum length of M-NET transmission =500m/1640 ft *1
- Maximum power feeding length =200m/656 ft *1

NOTE

* 1: Not including the remote control cables up to 10m (32 ft) in length. If the remote control cable exceeds 10m (32 ft), the excess must be added to the total length in order to avoid exceeding the maximum length.

Example

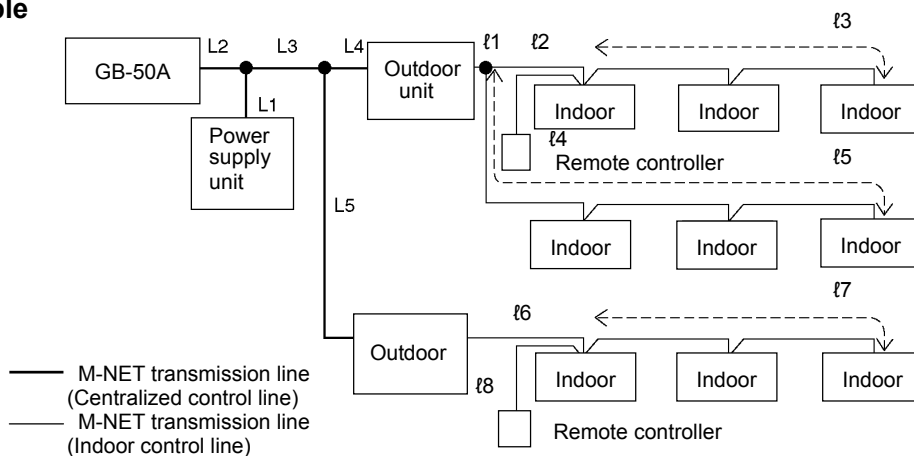

- 1) Maximum length of M-NET transmission
 - 1 L2+L3+L4+l1+l2+l3 (l4) =500m/1640 ft
 - 2 L2+L3+L4+l1+l5 =500m/1640 ft
 - 3 L2+L3+L5+l6+l7 (l8) =500m/1640 ft
 - 4 l3 (l4)+ l2+l1+L4+L5+l6+l7 (l8) =500m/1640 ft
 - 5 l5+l1+L4+L5+l6+l7 (l8) =500m/1640ft
- 2) Maximum power feeding length for the indoor control line
 - 1 l1+l2+l3 (l4) =200m/656 ft
 - 2 l1+l5 =200m/656 ft
- 3) Maximum power feeding length for the centralized control line
 - 1 L1+L2 =200m/656 ft
 - 2 L1+L3+L4 (L5) =200m/656 ft

NOTE

If the remote control cable (l4, l8) do not exceed 10m (32 ft) in length, the length for l4, l8 may not be considered to the total length.

3. Installation method

Central controller GB-50A is not waterproof.
 Installation methods for the central controller GB-50A are shown below.

Method1: Horizontal installation using L-fittings

Attach two L-fittings to GB-50A using the supplied screws (Fig.5-1), then install GB-50A (Fig.5-2).
 GB-50A shall be installed in a control panel box (steel: thickness 1mm (3/64 in) or more).
 Please prepare the control panel box in consideration with installation space as shown in the Fig.5-2.
 (Install in an area capable of withstanding a 1.1 kg (2 1/2 lb) load.)
 Install GB-50A horizontally as shown in the Fig.5-2.

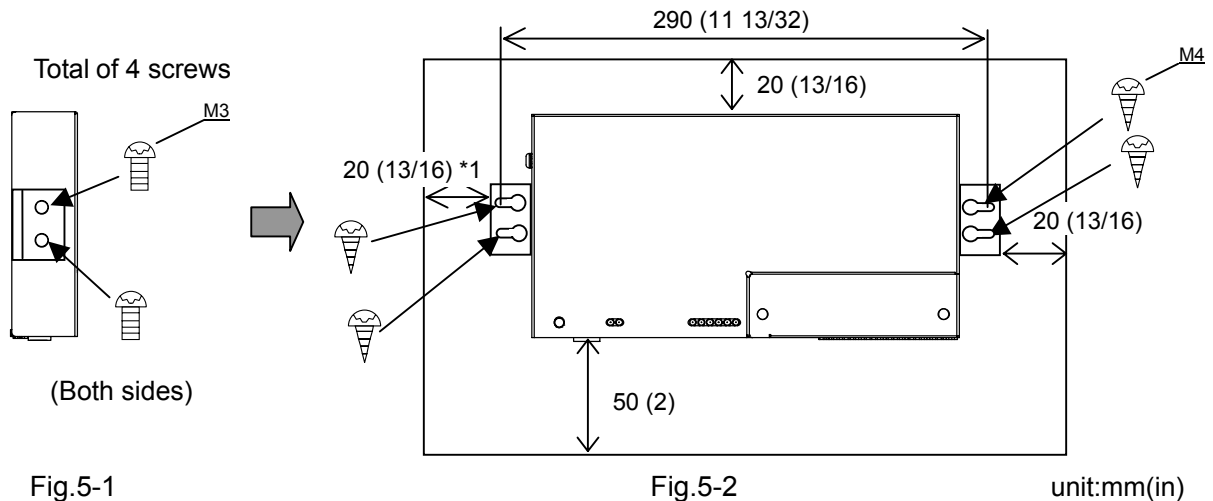

⚠ CAUTION

- L-fittings must be fixed at two points on the unit.
- The unit with L-fittings must be fixed at four points to prevent the unit from falling.

NOTE(*1)

When connecting the protective earth cable after GB-50A is installed, leave some space for mounting screws. When there is little space for mounting screws, connect the grounding wire before GB-50A is installed.

Method2: Vertical installation using L-fittings

After removing the screws on GB-50A, attach two L-fittings to GB-50A using the supplied screws (Fig.5-3), then install GB-50A (Fig.5-4).

GB-50A shall be installed in a control panel box (steel : thickness 1mm (3/64 in) or more).

Please prepare the control panel box in consideration with installation space as shown in the Fig.5.4.

(Install in an area capable of withstanding a 1.1 kg (2 1/2 lb) load.)

Install GB-50A vertically as shown in the Fig.5-4.

(Reference) When GB-50A is installed inside the control board, it is recommended that it be installed after the wiring work, so that the installation becomes easy.

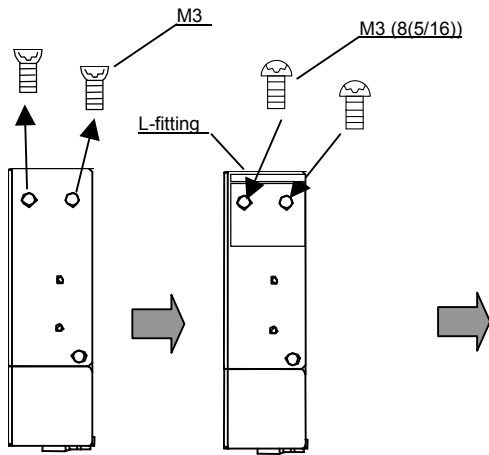

(Both sides)

Fig.5-3

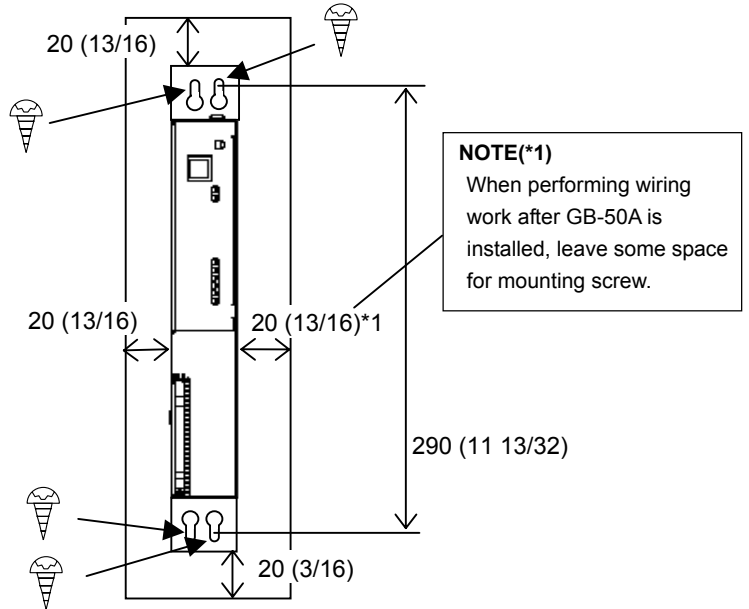

NOTE(*1)
When performing wiring work after GB-50A is installed, leave some space for mounting screw.

Fig.5-4

unit:mm(in)

CAUTION

- L-fittings must be fixed at two points on the unit.
- The unit with L-fittings must be fixed at four points to prevent the unit from falling.

Method3: Installation using DIN rail

GB-50A can be attached to DIN rail (35mm(1.38inch)).

Attach DIN rail attachment to GB-50A using the supplied screws (Fig.5-5), then install GB-50A (Fig.5-6).

GB-50A shall be installed in a control panel box (steel : thickness 1mm (3/64 in) or more).

Please prepare the control panel box in consideration with installation space as shown in the Fig.5-6.

(Install in an area capable of withstanding a 1.1 kg (2 1/2 lb) load.)

Install GB-50A vertically as shown in the Fig.5-6.

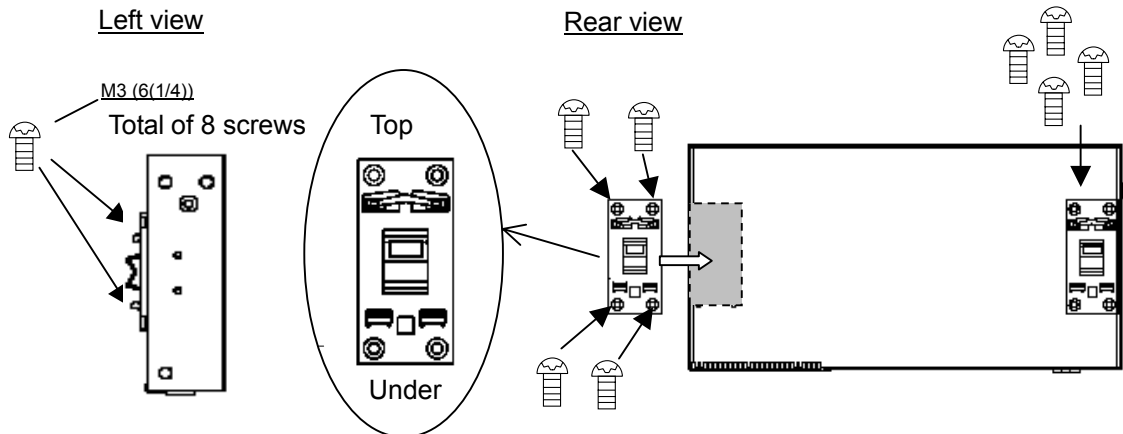

Fig.5-5

unit:mm(in)

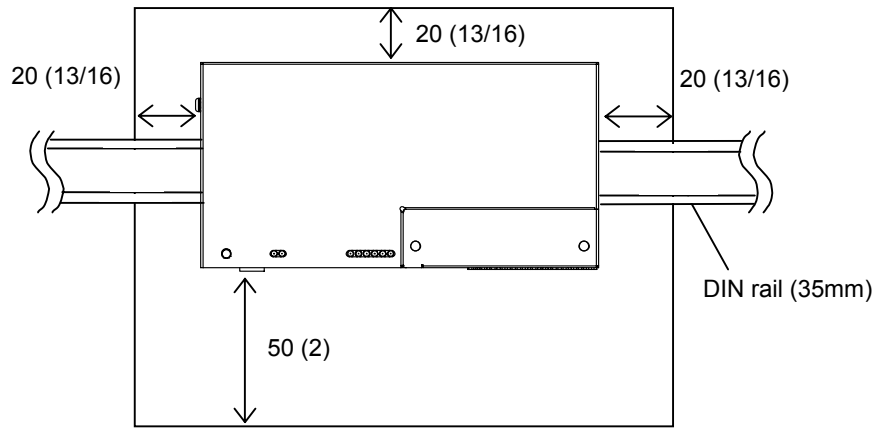

Fig.5-6

unit:mm(in)

⚠ CAUTION

- DIN rail attachment must be fixed at four points on the unit using two attachments.
- To secure the strength, screw pitch of 200mm(7.88inch) or less is required when DIN rail is fixed on the control board.
- Use GB-50A in a place where it receives no vibrations. Use studs as necessary to fix GB-50A.

Installation and de-installation on DIN rail

1) Installation

Put the upper side of attachment on DIN rail, and push the bottom of the unit in the direction of the arrow shown in the figure below.

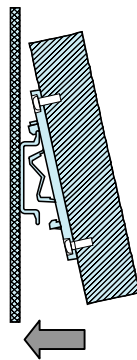

Fig.5-7

⚠ CAUTION

- Check that the attachment is fixed securely to the DIN rail.

2) De-installation

Push the unit downwards, and pull it in the direction of the arrow shown in the figure below.

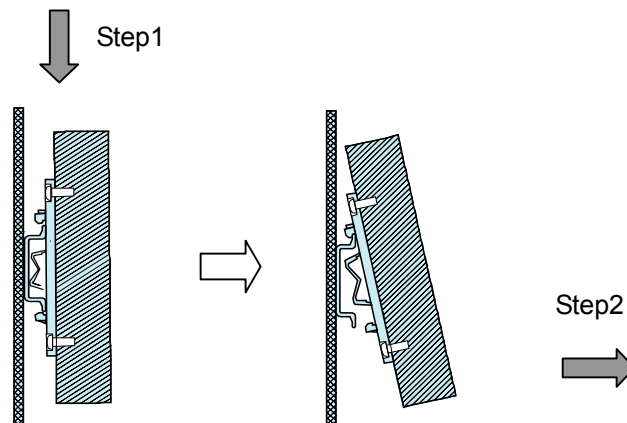

Fig.5-8

⚠ WARNING

- All electric work must be performed according to local regulations. Improper electrical work may result in electric shock or fire.
- Be sure to shut off the power source of the unit and the all other unit to be connected to the power supply unit before wiring.

⚠ CAUTION

- Do not connect the AC power line to the M-NET terminal blocks of this device. Otherwise, the unit may fall.

1. Grounding cable

Connect the protective earth cable (grounding cable) to the ground terminal as shown in the Fig.6-1. Attach the ring terminal (M4) to the grounding cable, and connect the cable to the ground terminal on the unit body.

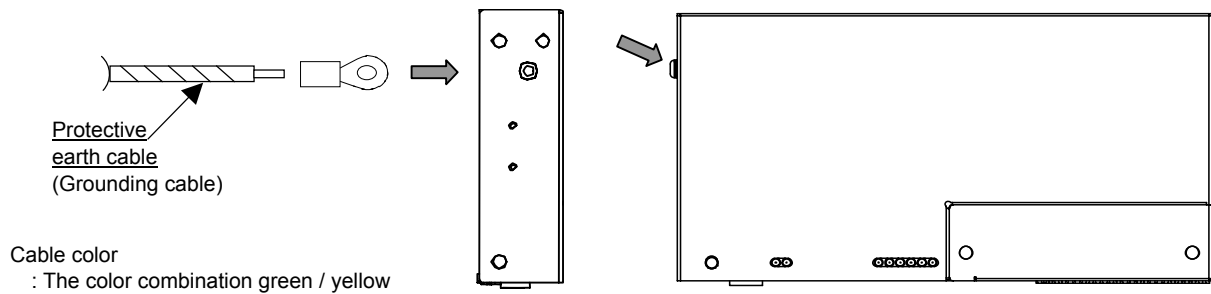

Fig. 6-1

2. Cover Removal and Installation

When removing the cover, remove the 2 mounting screws and remove the cover. When installing the cover, install the cover by tightening the 2 screws.

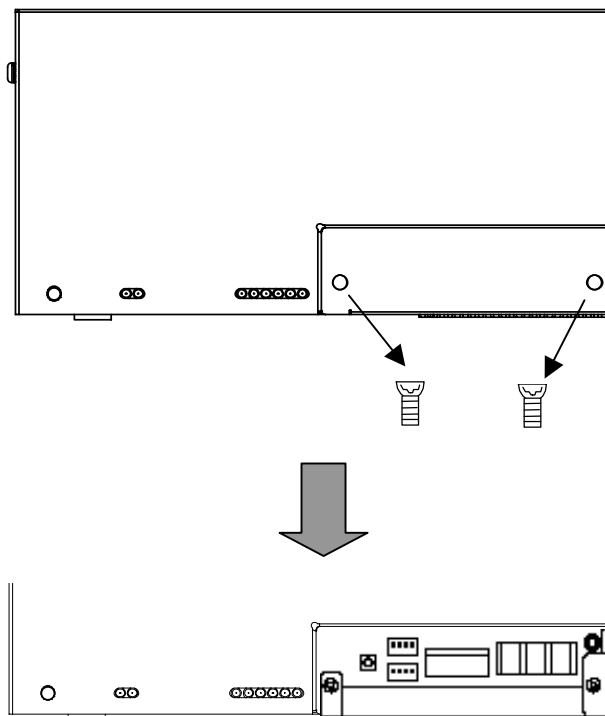

Fig.6-2

3. M-NET transmission line

Connect the M-NET transmission line to the A, B (non-polarity) and S (shield) terminal block, as shown in Fig. 6-3.

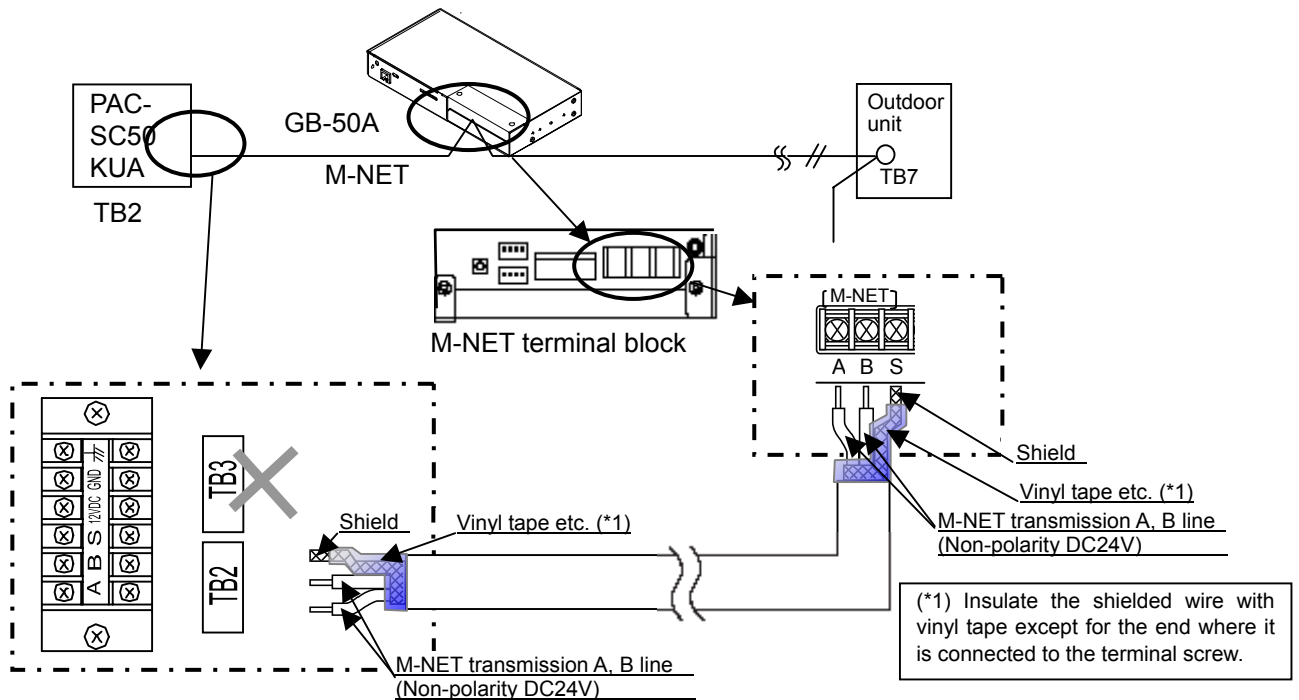

Fig.6-3

⚠ CAUTION

- DC power to the M-NET transmission line is supplied from either the power supply unit PAC-SC50KUA or R410A outdoor unit. When supplying the power from R410A outdoor unit to the transmission line for central control (TB7), disconnect the male connector from the female power supply switch connector (CN41: no power supply) and connect it to the female power supply switch connector (CN40: power supply) on only one of the outdoor units. For further details, refer to the transmission manual of the outdoor unit. Not doing so may cause unit failure or fire.
- Securely connect the wiring using the specified cables and fix them so that the stress from the cables is not applied to the terminal connection sections. If connection or fixing is not reliably connected, it may cause heat generation, a fire, etc.

4. LAN connection

Connect the LAN cable to the LAN connector of this device.

- Procure the LAN cable at the site, and use an enhanced category 5UTP cable.
- For a description of the IP address setting method, refer to section [7 Initial setting](#).
- LAN is 10 BASE-T Specification.
- The maximum wiring length from HUB to GB-50A is 100m.
- GB-50A is connected to the monitoring PC via HUB.

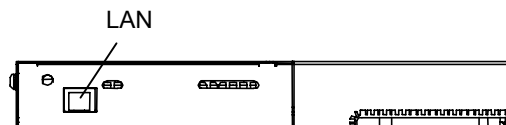

NOTE

- Perform the LAN wiring before installation, and wire up to the unit by the same method as wiring of M-NET transmission line.
- When a LAN is already connected, decide the IP address by consultation with the system administrator and connect the LAN port after changing the IP address.
- Space for the connector and wiring is required. Refer to section [5 Installation method](#).

7 Initial Setting

Initial setting steps

- Step 1: IP address setting
- Step 2: License number registration *License must be registered before use.
- Step 3: Group setting
- Step 4: Other settings
- Step 5: Test run

Note

- Initial setting can be set with either the initial setting tool or the initial setting web through LAN. More functions can be set with the initial setting web. The license is not registered at factory shipment, and monitor or operation cannot be performed on the air conditioner. In this section, the functions that can be initialized using this unit are described. Refer to the operation manuals for the initial setting tool or the initial setting web for more information.
- The format in which the Web page address for each GB-50A is expressed on the Initial Setting Web, as well as the default setting user name and password are shown below.

http:// [IP address of the GB-50A]/g-50/ administrator.html

Note: For example, type "http://192.168.1.1/g-50/administrator.html" if the GB-50A IP address is [192.168.1.1].

User	Default user name	Default password
Maintenance user	initial	init

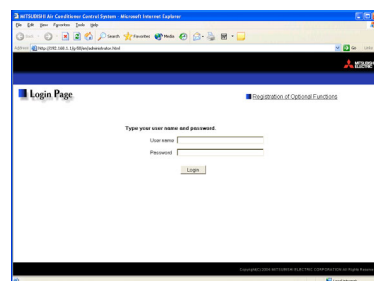

The function list of GB-50A main body, the Initial Setting Tool, and the Initial Setting Web is shown below.

Items	This unit	Initial Setting Tool	Initial Setting Web	Remarks
M-NET address setting		√	√	The default value is 0.
IP address setting	√ (simple setting)	√	√	*The settings of the simple setting have the priority over other settings.
Function selection		√	√	Presence/absence of K transmission converter connection, local operation prohibition setting, and external input mode
Group registration		√	√	
Registration of interlocked operation with the ventilation unit		√	√	
Service switch	√			
Other settings		√	√	Available functions vary depending on the tool.

1. How to set the IP address with dip switches

IP addresses between 192.168.1.1 and 15 can be set using the 4-pin dip switch on SW2. Set this switch before turning the power on.

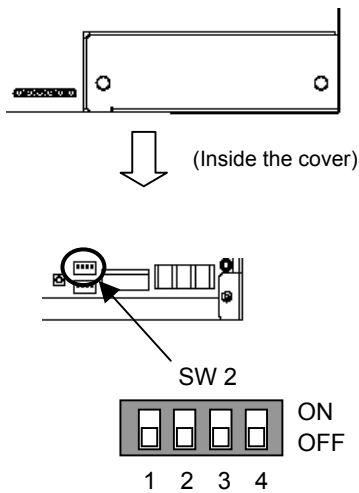

1	2	3	4	Contents (IP address)
OFF	OFF	OFF	OFF	Address that is set with Initial Setting Tool or Initial Setting Web (Default IP address setting is 192.168.1.1 (Factory setting))
OFF	OFF	OFF	ON	Starts from 192.168.1.1
OFF	OFF	ON	OFF	Starts from 192.168.1.2
OFF	OFF	ON	ON	Starts from 192.168.1.3
OFF	ON	OFF	OFF	Starts from 192.168.1.4
OFF	ON	OFF	ON	Starts from 192.168.1.5
OFF	ON	ON	OFF	Starts from 192.168.1.6
OFF	ON	ON	ON	Starts from 192.168.1.7
ON	OFF	OFF	OFF	Starts from 192.168.1.8
ON	OFF	OFF	ON	Starts from 192.168.1.9
ON	OFF	ON	OFF	Starts from 192.168.1.10
ON	OFF	ON	ON	Starts from 192.168.1.11
ON	ON	OFF	OFF	Starts from 192.168.1.12
ON	ON	OFF	ON	Starts from 192.168.1.13
ON	ON	ON	OFF	Starts from 192.168.1.14
ON	ON	ON	ON	Starts from 192.168.1.15

NOTE

- When setting IP addresses with the Initial Setting Web or the Initial Setting Tool, set all four dipswitches on SW2 to OFF.
- If the IP address of GB-50A is forgotten, check the IP address that is registered on the monitoring PC (Web or TG-2000A). GB-50A can be started by changing the setting of SW2 on GB-50A IP address and using an arbitrary fixed IP address as a temporary IP address. It is recommended to paste a sticker with the IP address on that unit, so that the IP address of GB-50A is available at all times.

2. Setting of the service switch

The switches must be OFF for normal use. The switch setting change works when the power is turned on next time.

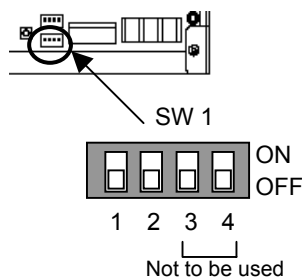

1	2	Contents	Remarks
OFF	OFF	Start up with the normal mode	*This setting is for normal use.
ON	OFF	-	Setting is prohibited.
OFF	ON	-	Setting is prohibited.
ON	ON	Start up with the update mode	*The software can be updated with the normal mode. If the update fails, or the software does not work properly, use this setting to update the software again.

*SW1-3 and SW1-4 are always OFF.

8 Test Run

1. Collective operation ON/OFF

* After setting the group or interlocked setting, confirm that the controller has started up, and then perform a test run.

* It may take approx. 10 minutes for local remote controller operation to be enabled after the power is turned ON. In this case, press the collective ON/OFF switch on the controller to enable immediate local remote controller operation.

(Test run procedure)

1. Turn ON the Power to the controller and all the units.
2. When the LED1 on the main unit turns OFF from ON, press SW3. The units registered in the same group will start a group operation. When the group operation starts, the LED2 on this turns ON.
3. Confirm the run state during the test run.
4. When each unit has been confirmed, stop the unit with the controller or local remote controller.

* Refer to the installation manual for the connected indoor unit for details on the test run method.

* The test run mode cannot be selected with this collective ON/OFF switch (SW3). The operation mode will be the current operating mode.

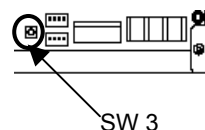

Note

- Use the local remote controller to change the mode to the “Test run” mode.
- The operation mode other than the “Test run” mode can be selected on the Web browser.
- The format in which the Web page address for each GB-50A is expressed on the Web browser, as well as the default setting user name and password are shown below. For further detail, refer to the manual for Web browser.

http:// [IP address of the GB-50A] / administrator.html

Note: For example, type “http://192.168.1.1/administrator.html” if the GB-50A IP address is [192.168.1.1].

User	Default user name	Default password
Managers	administrator	admin

2. Service LED display

The LED display the status of the unit as follows.

LED No.	Items	Contents
Power supply LED	Powering status	ON : Power is supplied / OFF: Power is cut off
LAN	LAN LINK	ON : During LINK / OFF: No LINK
LAN	LAN ACT	Flicker: During communication / OFF: No communication
LED1	Start-up	ON : Start-up not completed / OFF: Start-up completed
LED2	Operation ON/OFF	ON : 1 or more units are ON / OFF: All OFF
LED3	Error	Flicker: Error occurred on 1 or more units / OFF: Normal state
LED4	(not defined)	-
LED5	(not defined)	-
LED6	M-NET communication (transmission)	Flicker: During communication / OFF: No communication

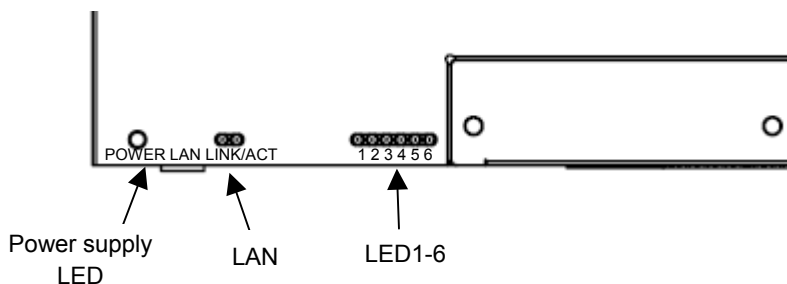

9 Example for System Configuration

1. To control a K control model

- Set GB-50A address to "000" when a K transmission Converter is connected. Always set to the master system Controller when the address is "000".
- When using a group setting for the K control model, set Only the indoor unit that belongs to that group.
- Set the min. indoor unit address in the group for the K control model group No.
The K transmission converter address is "K control model address + 200". Set the address to K transmission converter main body, and register it to GB-50A using the Initial Setting Web or the Initial Setting Tool.
- Set the master system controller function select No.4 to "OFF" (operation prohibit transmission valid) When the K transmission controller is connected.

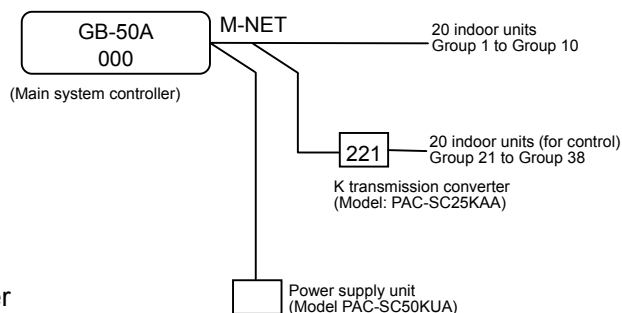

2. To use system controllers on multiple units

- Make the initial setting such as group setting or interlock setting using the Initial Setting Web or the Initial Setting Tool on GB-50A.
- Set one system controller that is allowed to send operation prohibition within a system.

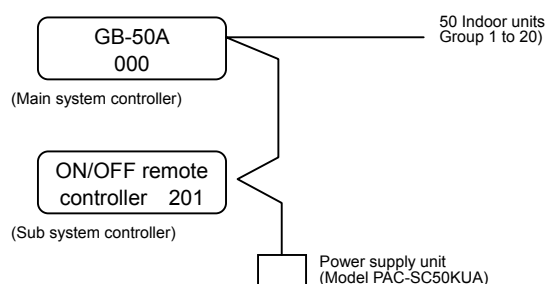

10 External Input/Output Usage Method

1. External signal input function

* External signal input requires the external I/O adapter (Model: PAC-YG10HA) sold separately.

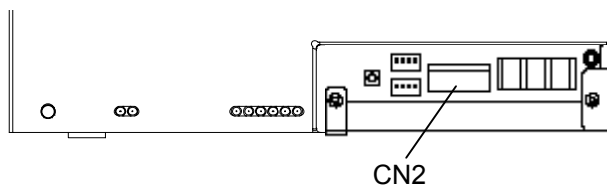

(1) External input

Emergency stop/normal, run/stop and prohibit/enable of local remote controller operation can be controlled for all air conditioners being controlled by using a voltage (DC12V or DC24V) contact signal from an external source. (Select with the function select setting using the Initial Setting Web or the Initial Setting Tool.)

No.	External signal input function	Function		Remarks
		No.6	No.7	
1	Do not use external input signal (factory setting)	OFF	OFF	
2	Execute emergency stop/normal with level signal	OFF	ON	The local remote controller ON/OFF operations, and the controller ON/OFF operation and prohibit/enable change operations will be prohibited during emergency stop.
3	Perform ON/OFF with level signal	ON	OFF	The local remote controller ON/OFF operations, and the controller ON/OFF operations and prohibit/enable change operations will be prohibited.
4	Perform ON/OFF, prohibit/enable with pulse signals	ON	ON	Set the pulse width while the contact is ON to 0.5 to 1 sec.

(2) Level signal and pulse signal (DC12V or DC24V)

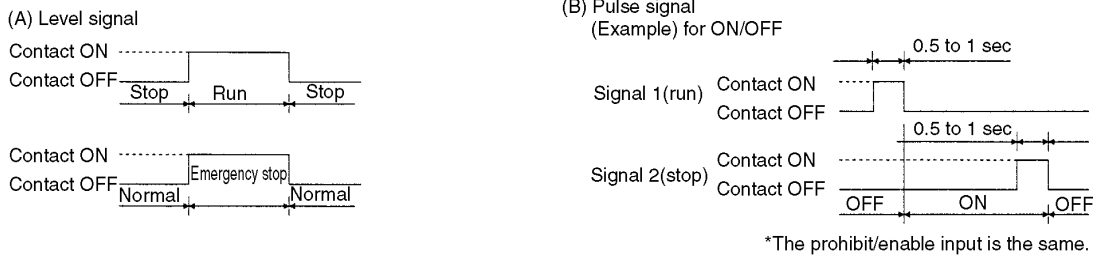

(3) External input specification

CN2	Lead wire	Emergency stop/normal level signal	ON/OFF, level signal	ON/OFF, prohibit/enable pulse signal
No.5	Orange	Emergency stop/normal input	ON/OFF input	ON input
No.6	Yellow	Not used	Not used	OFF input
No.7	Blue	Not used	Not used	Local remote controller operation prohibit input
No.8	Gray	Not used	Not used	Local remote controller operation enable input
No.9	Red	External DC source "+"		

(A) For level signal

- 1 When the emergency stop/normal signal is selected, the status will change from normal to emergency stop when the external input signal contact changes from OFF to ON, and will change from emergency stop to normal when the contact changes from ON to OFF. Emergency stop signal will bring the air conditioners to stop, and canceling the emergency stop will not automatically reset these units. To go back to the previous operation status, they must be manually turned back on.
- 2 When the ON/OFF signal is selected, the status will change from OFF to ON when the external input signal contact changes from OFF to ON, and will change from ON to OFF when the contact changes from ON to OFF.

(B) For pulse signal

- 1 Even if the ON signal is input during ON, the status will remain ON.
- 2 If the local remote controller is prohibited, the ON/OFF operation mode and temperature setting operations by the local remote controller will be prohibited.
- 3 Set the pulse width (contact ON time) to 0.5 to 1 sec.

(4) Recommended circuit example

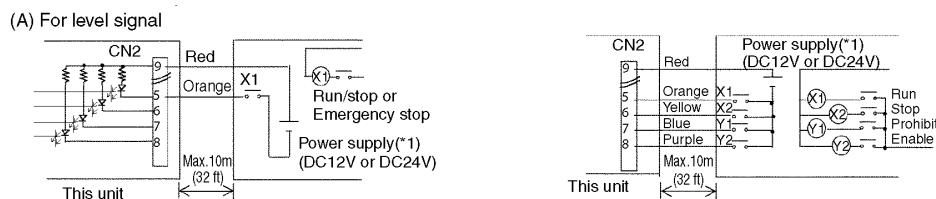

- 1 The contact relay, DC power source, extension cable, etc. must be prepared separately at the site.
- 2 The connection cable can be extended up to 10m (32 ft). (Use a 0.3mm² (AWG 22) or larger wire.)
- 3 Strip the extra cable near the connector, and securely insulate the exposed section with tape, etc.

2. External signal output function

* External signal output requires the external I/O adapter (Model: PAC-YG10HA) sold separately.

(1) External output

When one or more air conditioners are running, the "ON" signal will be output and if a malfunction occurs in one or more air conditioners, the "Malfunction" signal will be shown.

(2) External output specifications

CN2	Lead wire	Details of each terminal
No.1	Green	Common (External ground)
No.2	Black	ON/OFF
No.3	Brown	Malfunction/normal
No.9	Red	Common (External power supply) (*1)

1 "ON" signal and "Malfunction" signal will both be shown.

(3) Recommended circuit example

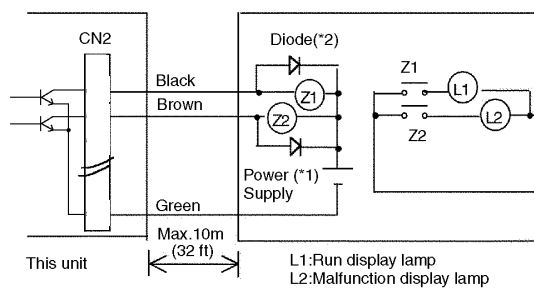

Use Z1 and Z2 relays having the following specifications.

Operation coil

Rated voltage : DC12V, DC24V

Power consumption : 09.W or less

(*1) Prepare a power supply separately according to the relay being used. (DC12V or DC24V)

(*2) Always insert a diode on both ends the relay coil.

1 Each element will turn on while ON operation or a malfunction occurs.

2 The connection cable can be extended up to 10m (32 ft).

3 The relays, lamps, diodes and extension cables, etc, must be prepared separately at the site.

This product is designed and intended for use in the residential,
commercial and light -industrial environment.

The product at hand is
based on the following
EU regulations:

- Low Voltage Directive 73/23/EEC
- Electromagnetic Compatibility Directive 89/
336/EEC

NOTE:

This equipment has been tested and found to comply with the limits for a Class B digital device, pursuant to Part 15 of the FCC Rules. These limits are designed to provide reasonable protection against harmful interference in a residential installation. This equipment generates, uses and can radiate radio frequency energy and, if not installed and used in accordance with the instructions, may cause harmful interference to radio communications.

However, there is no guarantee that interference will not occur in a particular installation.

If this equipment does cause harmful interference to radio or television reception, which can be determined by turning the equipment off and on, the user is encouraged to try to correct the interference by one or more of the following measures:

- Reorient or relocate the receiving antenna.
- Increase the separation between the equipment and receiver.
- Connect the equipment into an outlet on a circuit different from that to which the receiver is connected.
- Consult the dealer or an experienced radio / TV technician for help.