

Part 6

Electric and Control System

- 1. Electric System 105**
 - 1.1 Wiring Diagrams and Field Wiring..... 105**
 - 1.2 Description of Main Control Board of Main unit..... 105**
 - 1.3 SW1 Query Instruction 107**
 - 1.4 Dial Codes definition 110**
 - 1.5 Description of Main Control Board of Indoor unit..... 115**
 - 1.6 Electric Wiring Installations 112**
- 2. Control System..... 117**
 - 2.1 Control System Introduction..... 117**

1. Electric System

1.1 Wiring Diagrams and Field Wiring

Wiring diagrams and field wiring please refer to "6. Wiring Diagrams and field wiring" of "Part 3 Specification & Performance"

1.2 Description of Main Control Board of Main unit

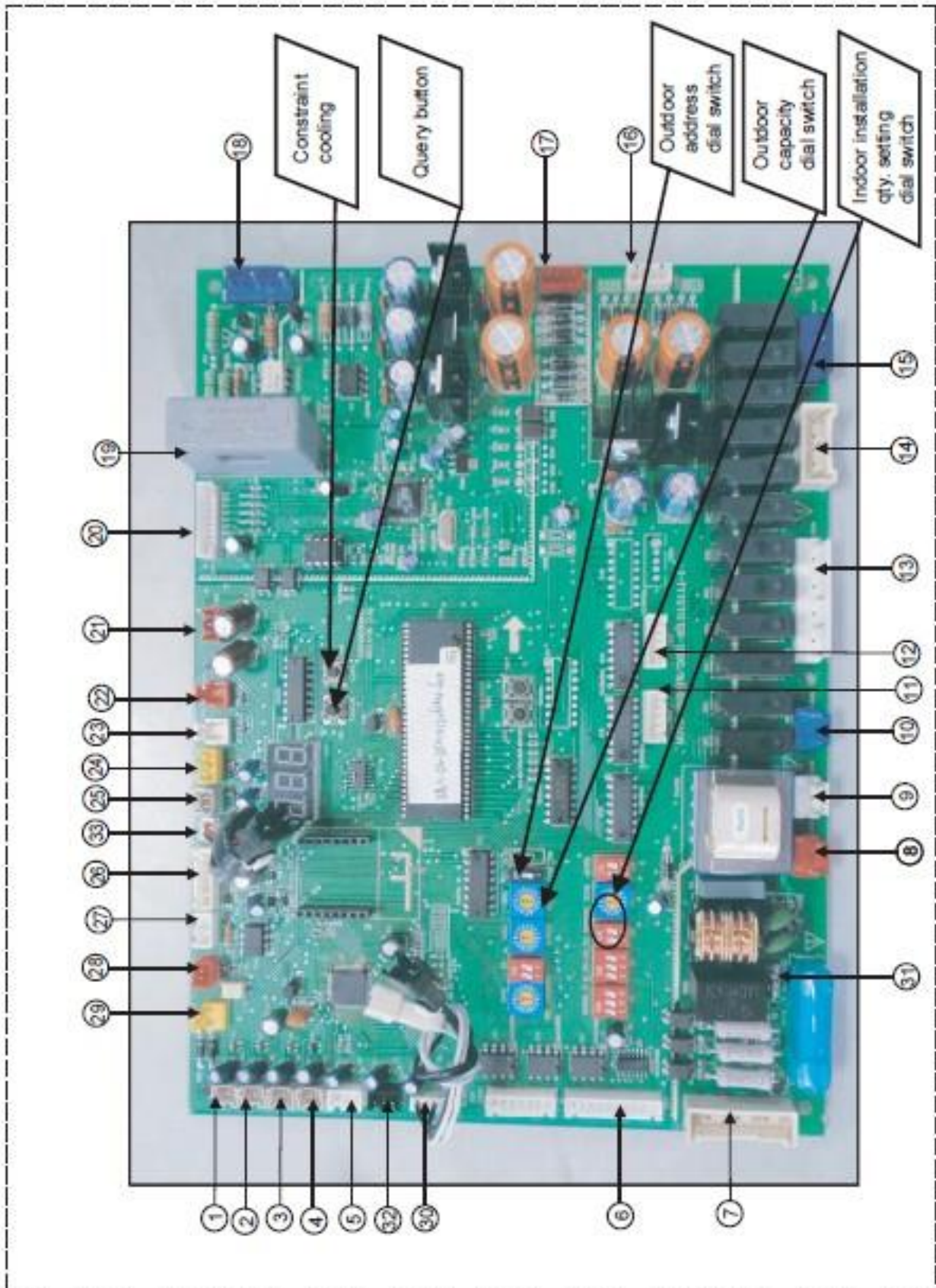

Fig.1-1

■ Explanation of main board

No	Content
1	Reserve
2	Reserve
3	Air discharge temp. sensed port 2 of inverter compressor
4	Air discharge temp. sensed port 1 of inverter compressor
5	Power supply port in the Mid-adapted panel
6	Communication between indoor and main units, indoor unit network, main unit network and terminal of network accounting
7	Phase inspection port
8	Power input of the No.1 transformer
9	Power input of the No.2 transformer
10	Loading output terminal
11	NO.1 EXV activation port
12	NO.2 EXV activation port
13	Loading output terminal
14	Loading output terminal
15	Loading output terminal
16	Power output of the No.1 transformer
17	Power output of the No.2 transformer
18	Port for inverter module voltage inspection
19	Mutual inductor for DC main lead current inspection
20	Activation port of inverter module
21	Power supply connected port of the main control panel
22	ON/OFF signal input port for system low pressure inspection
23	ON/OFF signal input port for system Hi-pressure inspection
24	Input port for system high pressure inspection
25	Temp. sensed port of the inverter module
26	Current sensed port of power phase A and power phase B
27	Communication ports among main units
28	Reserve
29	Water flow ON/OFF sensed port
30	Temp. sensed port of water inlet sensor 1 and water outlet sensor 2
31	C phase power supply
32	Input port for system low pressure inspection
33	Water inlet temp. sensed port

1.3 SW1 Query Instruction

No.	Display content	Note	No.	Display content	Remark
1	Main unit address	0,1,2,3	14	TSC1, water outlet temp. of upper pipe	Actual value
2	Capacity of main unit	8,10,12	15	TSC2, water outlet temp. of lower pipe	Actual value
3	Qty. of modular main unit	Effective to master unit	16	Current 1 of inverter compressor	Actual value
4	Total capacity of main unit	Capacity requirement	17	Current 2 of inverter compressor	Actual value
5	Total capacity requirement of indoor unit	Effective to master unit	18	High pressure	Actual value
6	Total capacity requirement of master unit after correction	Effective to master unit	19	Low pressure	Actual value
7	Operation mode	0,2,3,4	20	Opening degree of EEV A	Display value ×8
8	The actual operation capacity of main unit	Capacity requirement	21	Opening degree of EEV B	Display value ×8
9	Water flow switch	0-OFF,1-ON	22	Priority mode	0,1,2,3,4
10	T2B/T2 average temp.	Actual value	23	Quantity of communicated indoor units	Actual value
11	T5, inverter module temp.	Actual value	24	The qty. of installed indoor units	Actual value
12	T7, discharge temp. of inverter compressor	Actual value	25	The last time error or protective code	Without protection or error display code 00
13	TSJ, water inlet temp.	Actual value	26	---	Check end

Normal display:

- When in standby mode, it displays number of indoor units that can communicate with main unit. When it is operating, it will display the rotation frequency of the compressor.
- Operating mode: 0---Off/Fan; 1---fan only; 2---Cooling; 3---Heating; 4---Forced cooling
- Water flow switch state:0---close;1---open.
- Priority mode:0---Heating priority mode;1---Cooling priority mode;2---Priority mode;3---Only respond the heating mode; 4---Only respond the cooling mode
- EXV opening angle: pulse count=display value×8. ENC1: Main unit address setting switch,
- ENC1: Main unit address setting switch,
ENC2: Main unit capacity setting switch,
ECN3: Network address setting switch,
S10, ENC4: combination setting the qty. of the installed indoor units.
SW1: Query button;SW2:Constraint cooling.

Note: Setting 0 or 1, all mean install 1 set indoor unit.

1.4 Dial codes definition



Fig.1-2

S1 definition

Starting time is set about 10 minutes	Starting time is set about 12 minutes (Default the Factory Set)

S3 definition

	Reserve
--	---------

S5 definition (For cooling & heating type)

Heating priority mode (Default the Factory Set)	Cooling priority mode	Priority mode	Only Respond the heating mode	Only Respond the cooling mode

S6 definition

Automatic search address.	Non automatic search address. (The communication way of the original digital indoor unit) (Default the Factory Set)	Clean the indoor unit addresses	Reserve	Reserve

S10 definition

Combined with ENC14 to set the indoor unit of the installation number 1-15	Combined with ENC14 to set the indoor unit of the installation number 16-31	Combined with ENC14 to set the indoor unit of the installation number 32-47	Combined with ENC14 to set the indoor unit of the installation number 48-63

S11 definition

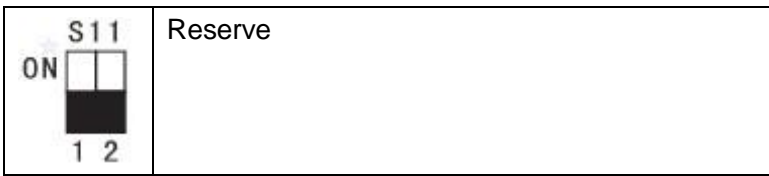

NOTE: Please shut off the power when setting the switch

1.5 Description of Main Control Board of Indoor unit

There are two shapes of main control board that used to all types of indoor unit matching with V4+ main unit.

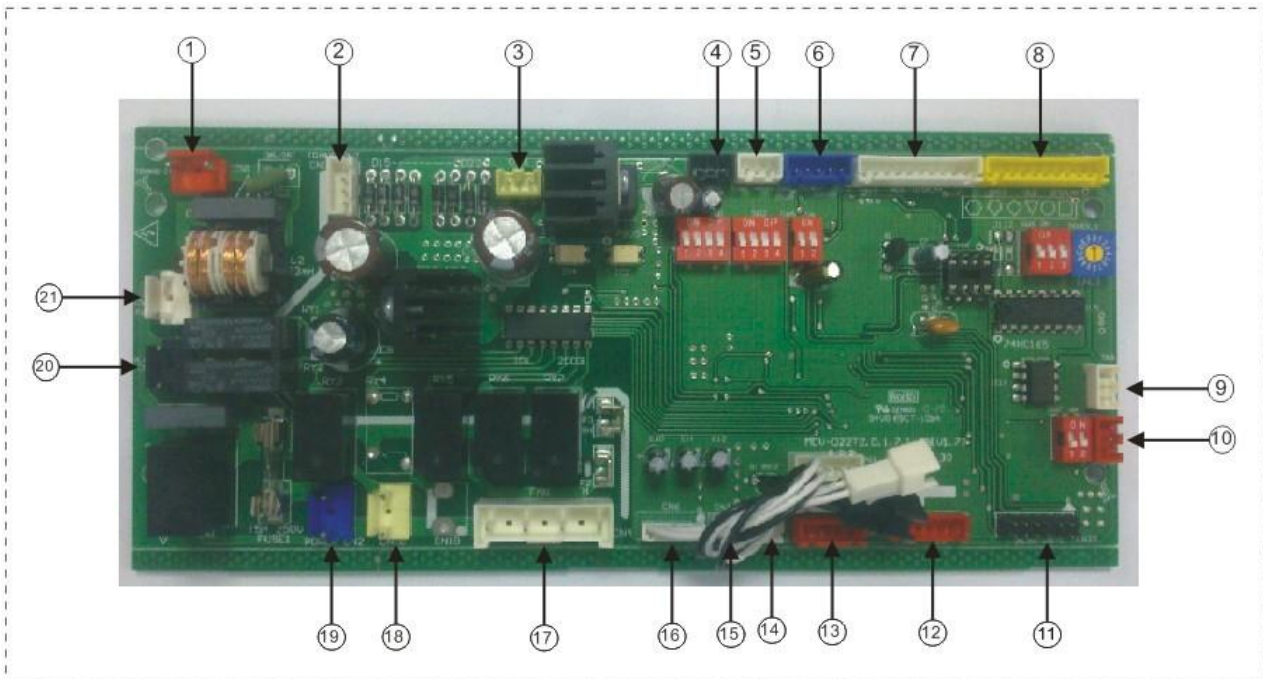

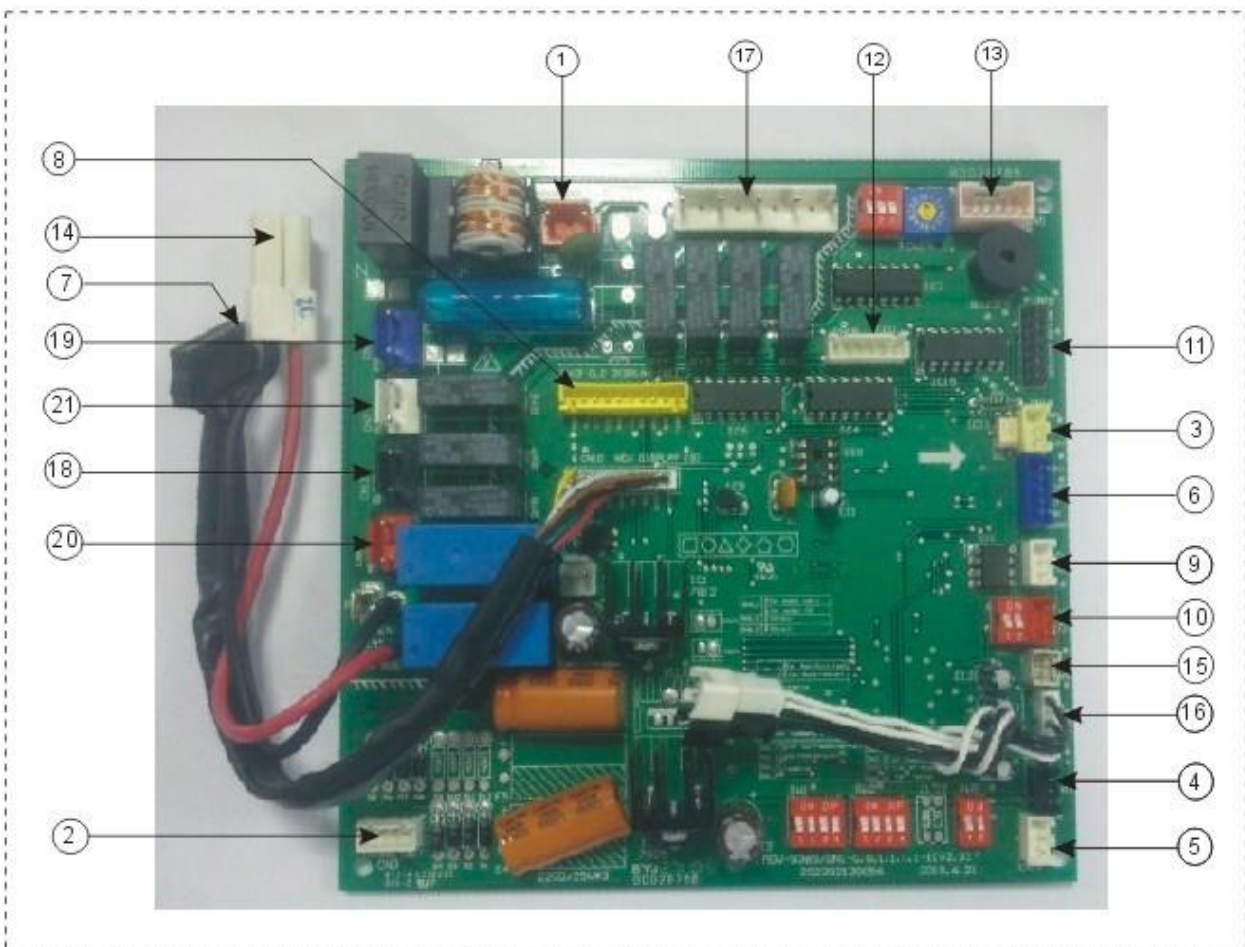

Shape 1









Shape 2

Dial codes definition









0/1 definition

ON 	Means 0
ON 	Means 1





SW1 definition

ON 	1 means factory test mode 0 means default auto addressing mode	ON 	1 means DC fan is chosen 0 means AC fan is chosen
ON 	00 means DC fan static pressure is 0 (reserved)	ON 	01 means DC fan static pressure is 1 (reserved)
ON 	10 means DC fan static pressure is 2 (reserved)	ON 	11 means DC fan static pressure is 3 (reserved)



SW2 definition

ON 	00 means shutting down the unit to stop cold air at 15°C	ON 	01 means shutting down the unit to stop cold air at 20°C
ON 	10 means shutting down the unit to stop cold air at 24°C	ON 	11 means shutting down the unit to stop cold air at 26°C
ON 	00 means the time of stopping fan (when no capacity need) is 4 minutes	ON 	01 means the time of stopping fan (when no capacity need) is 8 minutes
ON 	10 means the time of stopping fan (when no capacity need) is 12 minutes	ON 	11 means the time of stopping fan (when no capacity need) is 16 minutes



SW5 definition

ON 	00 means temperature compensation value is 6°C under heating mode	ON 	01 means temperature compensation value is 2°C under heating mode
ON 	10 means temperature compensation value is 4°C under heating mode	ON 	11 means temperature compensation value is 8°C under heating mode



SW6 definition

ON 	1 means old display panel 0 means new display panel	ON 	1 means auto air blow under auto mode 0 means auto air blow under non-auto mode
ON 	Reserved		

SW7 definition

	Normal configuration		Last unit of the network
---	-----------------------------	---	---------------------------------

J1 J2 definition

	Without jumper J1 for auto restart function		With jumper J1 for non-auto restart function
	Reserved		

Explanation of main board

No.	Content	No.	Content
1	Power input of transformer	12	Electric expansion valve drive port
2	Power output of transformer	13	Swing motor drive ports
3	Port for remote ON/OFF switch	14	Port for electric auxiliary heater
4	Port for infrared sensor	15	Indoor evaporator outlet pipe temp. detect port
5	Water level switch	16	Indoor ambient and evaporator middle part temp. detect port
6	Port for network module	17	Port for indoor fan motor
7	Port for new display board	18	Reserved
8	Port for old display board	19	Power input port
9	Communication port of X Y E	20	Port for alarm
10	Communication port of P Q E	21	Port for water pump
11	Port for on-line writing program	—	

1.6 Electric Wiring Installations**1.6.1 Highlights of electrical installation**

- 1) Please separately design the special power of indoor units and main units.
- 2) The power adopts special circuit, and installs creepage protector and manual switch.
- 3) The indoor units' power, creepage protector and manual switch connecting to the same main unit must be general. All indoor units must be the same circuit, and must simultaneously on or off; otherwise, system life will seriously effect, and appear the situation not to solve.
- 4) The communication line between indoor units and main units please use 3 core shielded wiring, while don't use the multi core wiring without shielded affect, for the interference is reduced each other
- 5) Purchased wiring, parts and materials should be in compliance with the local and national regulations.
- 6) All field wiring construction should be finished by qualified electrician.
- 7) Air conditioning equipment should be grounded according to the relevant local and national electrical regulations.
- 8) Current leakage protection switch should be installed (select current leakage breaker in light of the 1.6-2 times of total loading rated current.)
- 9) When connecting wiring and wire holder, use cable clamp to fix and make sure no exposure.
- 10) Refrigerant piping system and wiring system of indoor and main unit belongs to the different system.
- 11) Do not connect the power wire to the terminal of signal wire.
- 12) When power wire is parallel with signal wire, put wires to their own wire tube and remain proper gap (the current capacity of power wire is: 10A below 300mm, 50A below 500mm).

13) Voltage discrepancy of power wire terminal (side of power transformer) and end voltage (side of unit) should be less than 2%. If its length could not be shortened, thicken the power wire. Voltage discrepancy between phases shall not pass 2% rated value and Current discrepancy between highest and lowest phase should be less than 3% rated value.

1.6.2 Selection of wiring

1. The selection of wiring area shall in accordance with the requirements below:

- 1) Voltage lose of wire shall meet the requirement of terminal voltage for normal operation and startup.
- 2) The wiring current-carrying capacity determined by installed method and environment is not less than the largest current of unit.
- 3) Conductor shall ensure the stability of movement and heating.
- 4) The conductor's smallest sectional area should satisfy the requirement of mechanical strength.

When earth protection line (shortly called PE line) is made of material the same as phase line, the smallest sectional area of PE line should be in accordance with the regulation below:

Sectional area of core to phase line s(mm ²)	Smallest sectional area of PE line(mm ²)
$S \leq 16$	S
$16 < S \leq 35$	16
$S > 35$	S/2

1.6.3 Distribution highlights of distribution wiring

1. When distributing wiring, select wirings with different colors for phase line, zero line and protection earth according to relevant regulations.

2. The power wire and control wire of concealed engineering is prohibited to bind together with refrigerant piping. It is necessary to pass through wire tube and be distributed separately, and the gap between control line and power wire should be 500mm at least.

3. When distributing wiring by passing through pipe, the following should be paid attention to:

- 1) Metal wire tube could be used in indoor and outdoor, but it is not suitable to the place with acid – alkali corrosion.
- 2) Plastic wire tube is generally used in indoor and place with corrosion, but it is not suitable to situation with mechanical damage.
- 3) The wiring through pipe shall not be in the form with ends jointing. If there must be joint, connection box should be installed at the corresponding place.
- 4) The wiring with different voltage should not pass through the same wire tube.
- 5) Total sectional area of wiring through wire tube shall not exceed 40% valid area of stuffing tube.
- 6) Fixing point of wire tube support shall follow the standard below:

Normal diameter of wire tube	Largest gap between fixed points of wire tube	
	Metal pipe	Plastic pipe
15~20	1.5m	1m
25~32	2m	1.5m
40~50	2.5m	2m

CAUTION:

- Please select power supply for indoor unit and main unit separately
- The power supply should have specified branch circuit with leakage protector and manual switch.
- The power supply, leakage protector and manual of all the indoor units connecting to the same main unit should be universal. (Please set all the indoor unit power supply of one system into the same circuit.

It should turn on or shut down the unit at the same time, otherwise, the service life would affect seriously, even the unit may not turn on.)

■ Please put the connective wiring system between indoor unit and main unit with refrigerant piping system together.

■ It is suggested to use 3-core shielded wire as signal wire between indoor and main units, multi-core wire is unavailable.

■ Please comply with relevant National Electric Standard.

■ Power wiring should be done by professional electrician.

■ The water circulating pump, target flow switch etc. must be connected to the control circuit of the unit. The above accessories should be purchased by the user, and be installed at field, and they are not belong to the unit.

1.6.4 Main unit power wiring

■ Separate Power Supply (without power facility) (See Table.1-2,Table.1-3)

Table.1-2

Model \ Item	Power supply	Min. Power wire diameter (mm ²) Wiring of mental and synthetic resin	
		Size (Continuous length of pipe m)	Grounding wire
8,10,12HP	380-415V 3N~ 50Hz/ 60Hz	4 × 10 mm ² (<20 m) 4 × 16 mm ² (<50 m)	1 × 10 mm ²

Table.1-3

Model \ Item	Power supply	Manual switch (A)		Leakage protector
		Capacity	Fuse	
8,10,12HP	380-415V 3N~ 50Hz/ 60Hz	32	25	100mA 0.1sec or less

NOTE:

■ Select power cord for these five models separately according to relevant standard 8HP, 10HP, 12HP.

■ The wiring diameter and the length in the table indicate the condition that the voltage dropping range is within 2%. If the length exceeds the above figure, please select the wire diameter according to relevant standard.

■ With power facilities

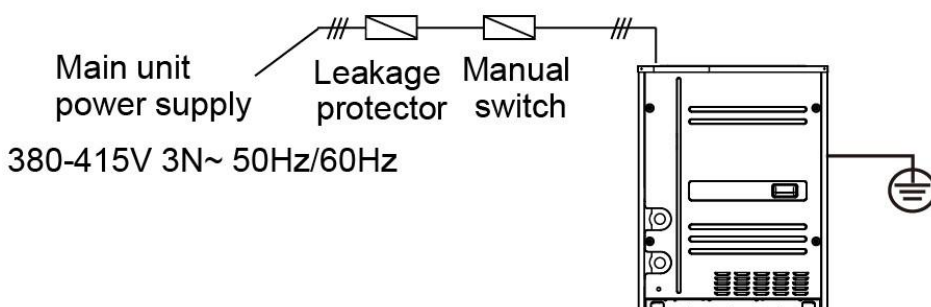

Fig.1-8

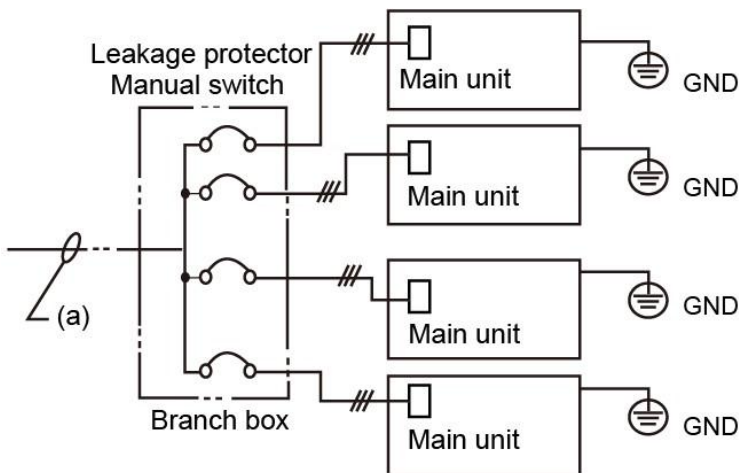

Fig.1-9

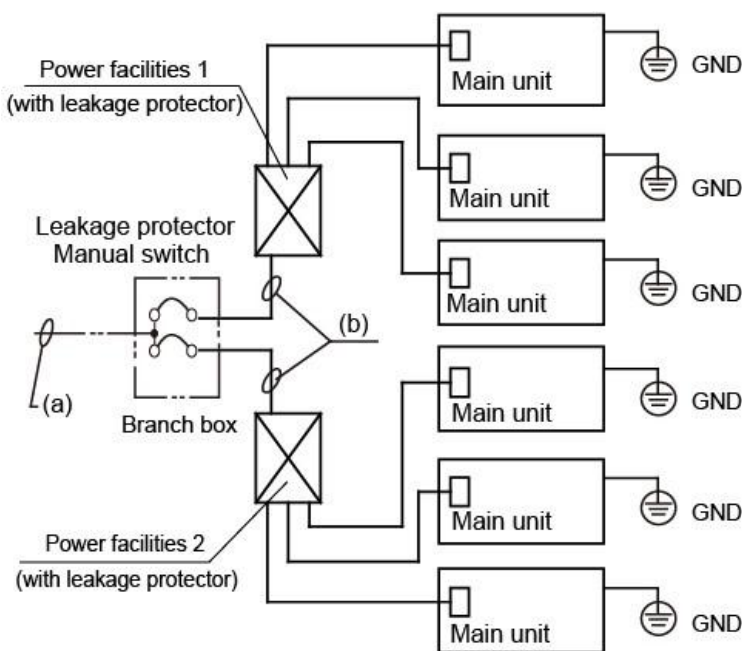

Fig.1-10

■ Select the wire diameter

Power wiring refer to the main wire (a) connecting to branch box and the wiring (b) between branch box and power facilities. Please select the wire diameter according to the following requirement.

·Diameter of main wire (a)

Depends on the total horsepower of outdoor unit and following table.

E.g In system:(10Hp × 1unit+10Hp × 1unit+8Hp × 1unit) Total Hp=28Hp → (Table.7-4) → size of wire=35mm²(within 50m)

·Wiring(b):between branch box and power equipment. Depends on the number of combined main unit. If fewer than 5, the diameter is the same as that of main wire (a); if more than 6, there will be 2 electric control boxes, and the diameter of wiring depends on the total horsepower of main units connecting to each electric control box and following table.

·Select wire diameter (≥) (table.1-4) (unit :mm²)

Table.1-4

Total HP	<20m	<50m
8	10	16
10	10	16

12	10	16
14	16	25
16	16	25
18	16	25
20	16	25
22	16	25
24	25	35
26	25	35
28	25	35
30	35	50
32	35	50
34	35	50
36	35	50

- Select the capacity of manual switch and fuse of the branch box
- See following table when without power facilities, depends on the main unit it connecting to.
- See table.1-5 below when there is power facility, depends on the total horsepower.

Table.1-5 Total horsepower, capacity of manual switch and fuse

Total HP	Manual switch (A)	Fuse(A)	Total HP	Manual switch (A)	Fuse(A)
8~12	32	25	24~28	80	63
14~16	40	35	30~34	80	70
18~22	63	50	36	100	80

■ Indoor power supply

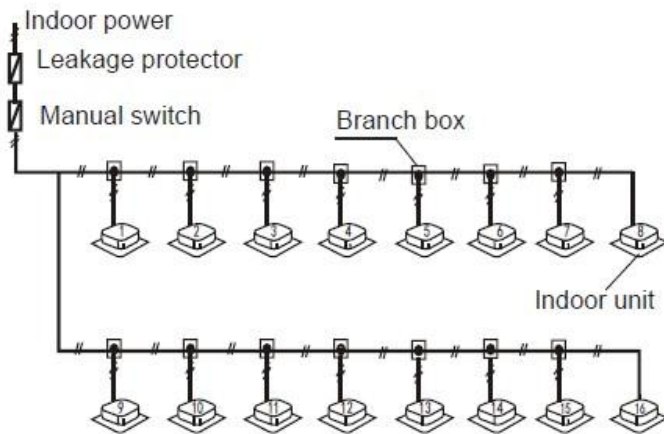

Fig.1-11

CAUTION:

- Set refrigerant piping system, signal wires between indoor-indoor unit, and that between main-main unit into one system.
- Power must unified supply to all indoor units in the same system.
- Please do not put the signal wire and power wire in the same wire tube; keep distance between the two tubes.(Current capacity of power supply: less than 10A--300mm,less than 50A--500mm.)
- Make sure to set address of main unit in case of parallel multi-main units.

2. Control System

2.1 Control System Introduction

2.1.1 Connecting highlights of control line (RS-485 communication)

1. The control line should be shielded wire. Using other wiring shall create signal interference, thus leading to error operation.
2. The shielded nets at the two sides of shielded wires are either grounded to the earth, or connected with each other and jointed to the sheet metal along to the earth.
3. Control wire could not be bound together with refrigerant pipeline and power wire. When power wire and control wire is distributed in parallel form, keep gap between them above 300mm so as to preventing signal interference.
4. Control wire could not form closed loop.
5. Control wire has polarity, so be careful when connecting.

2.1.2 Selection of control wire specification

The ordinary shielded wire includes:

Model	Name
AVP	Copper core PVC insulation shielded wire
AVP-105	Heat-resistant 105°C PVC insulation shielded wire
RVP	PVC insulation shielded flexible wire
RVP-105	Heat-resistant 105°C PVC insulation shielded flexible wire
RVVP	PVC insulation shielded PVC sheath flexible wire
RVVP1	PVC insulation entangled shielded PVC sheath flexible wire

2.1.3 Signal wire of indoor/main units

Signal wire of indoor/outdoor unit adopts 3-core shielded wire ($\geq 0.75\text{mm}^2$) which has polarity, please connect it correctly.

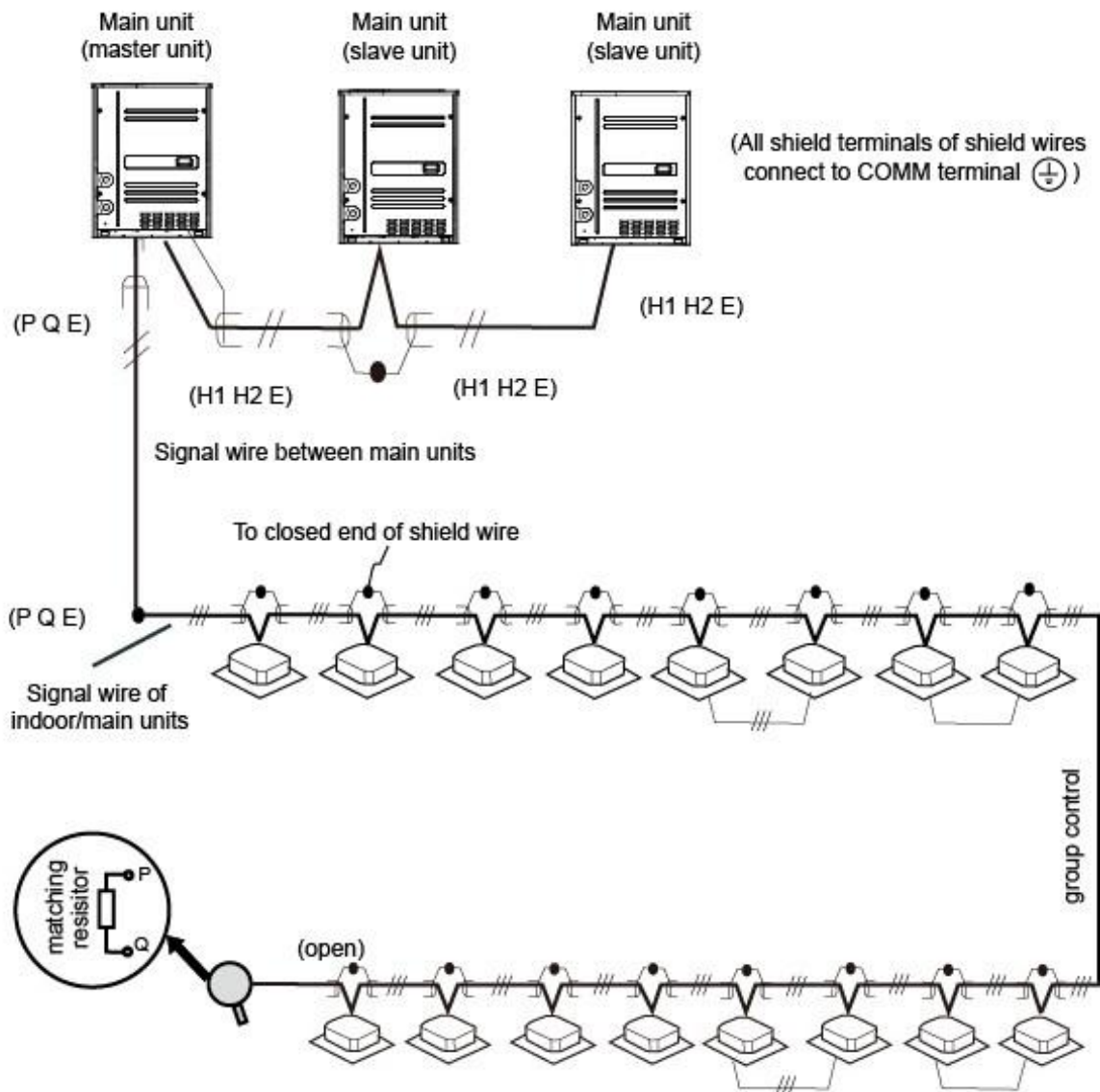

Note:

1. The signal connecting line between main units, indoor and main units and indoor units has polarity. When connecting, be careful to prevent error connection.
2. Signal wire shall adopt three-core shielded wire with the dia. no less than 0.75m².
3. The signal wire of indoor unit and main unit must only connect to the prime main unit.
4. Do not bind signal wire and copper pipe together with belting.

1) Correct connection

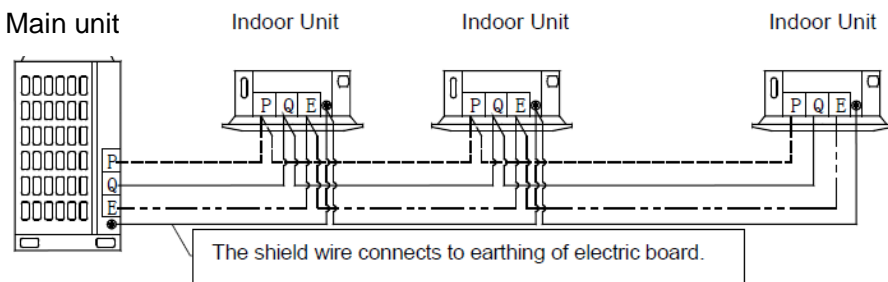

2) Typical wrong connection

- a. Loop connection of signal wire

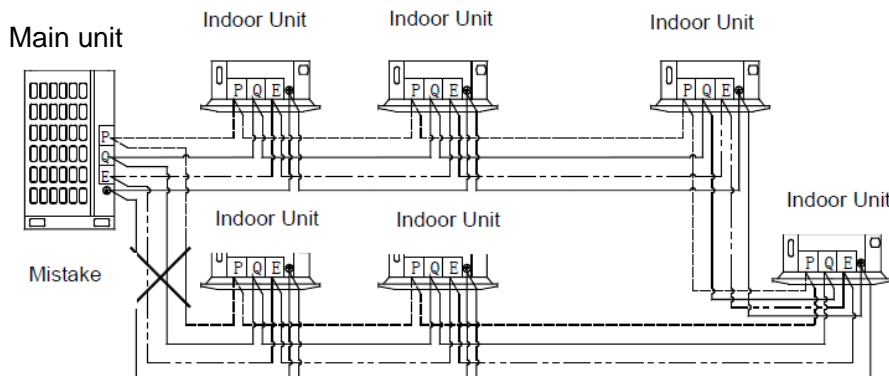

b. Star connection of signal wire

- Star connection of part signal wires

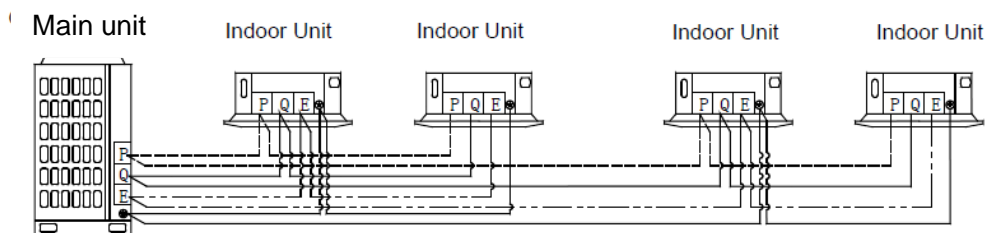

- Star connection of all signal wires

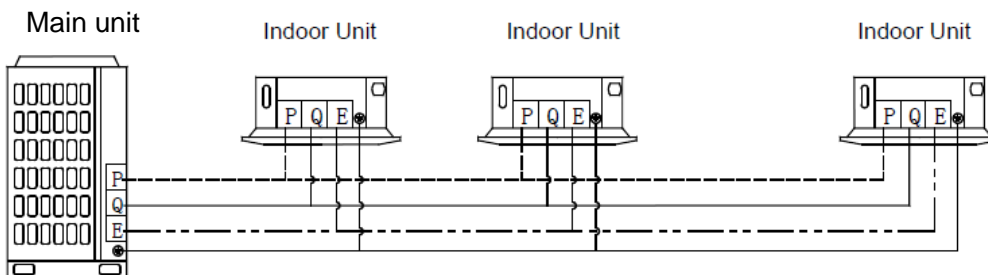

c. Reverse connection of signal wire

- Main unit — indoor unit

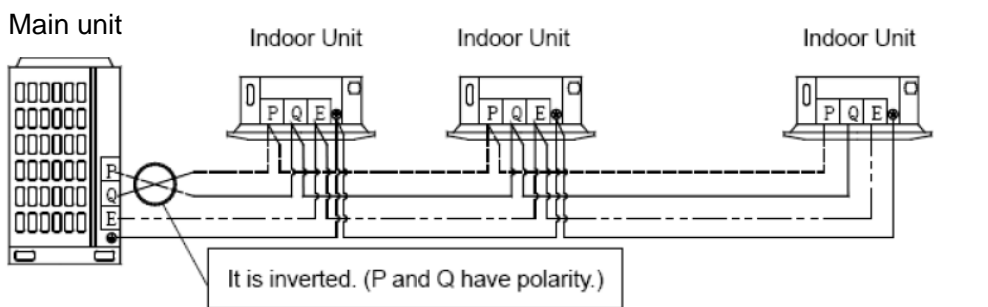

- Indoor unit — indoor unit

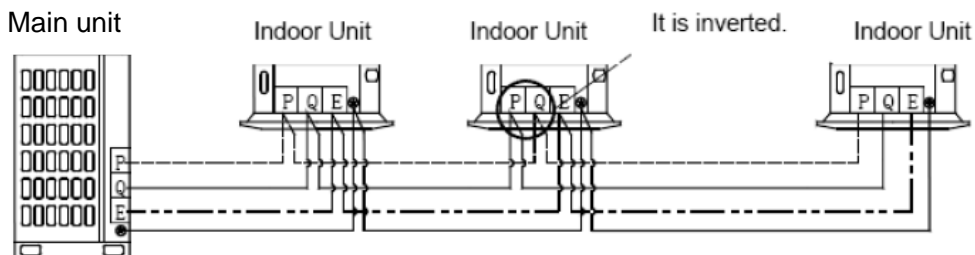

Caution: shielded layer should be connected to electrical panel.

2.1.4 Signal wire of centralized control

When centralized control is needed, one CCM03 (central controller of indoor unit) can only control the

indoor units which are in the same refrigerant system **via the port X Y E of outdoor unit**. Main unit will automatically distribute the address to indoor units without any manual setting. Remote controller can enquiry and modify every indoor unit address.

The diagram below shows the connection of signal wire in this case:

For example:

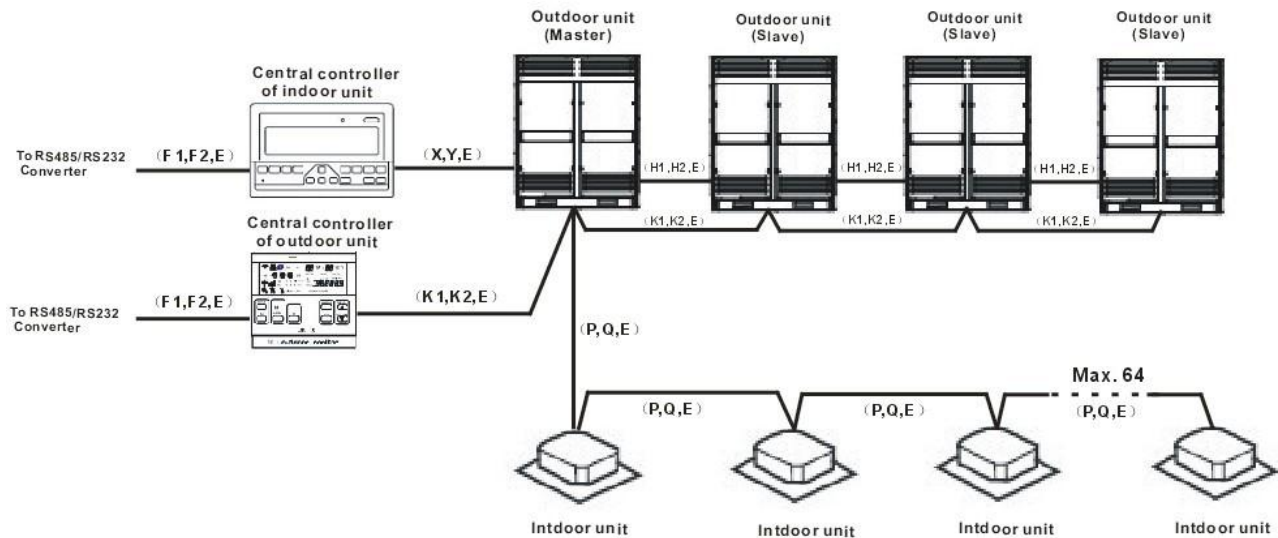

Besides, CCM03 can also connect indoor units **via the port X Y E of indoor unit**. However, one more group of wire(X Y E between indoor units) is needed; it is more complex and not suggested. Anyway, the diagram below shows the connection of signal wire in this case:

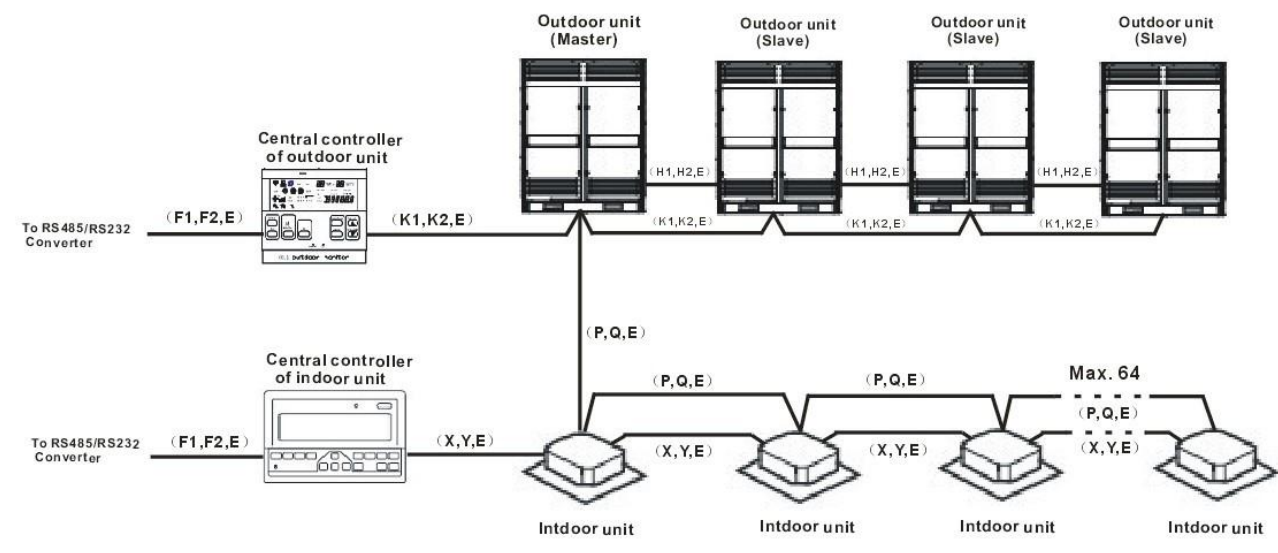

Note:

In the above Figure, outdoor unit stands for V4 Plus W Series main unit. It can be connect max.3 set. The above is for reference.