

INSTALLATION & OWNER'S MANUAL

M-INTERFACE



Thank you very much for purchasing our product,
Before using it, please read this manual carefully and keep it for future reference.

SAFETY INFORMATION.....	1
ACCESSORIES	2
M-INTERFACE GATEWAY CONTROLLER INSTALLATION.....	3
SYSTEM INTRODUCTION.....	8
SETTINGS	1
OPERATION INSTRUCTIONS	5
TROUBLE SHOOTING	1

1. SAFETY INFORMATION



The following contents are stated on the product and the operation manual, including usage, precautions against personal harm and property loss, and the methods of using the product correctly and safely. After fully understanding the following contents (identifiers and icons), read the text body and observe the following rules.



■ Identifier description

Identifier	Meaning
 Warning	Means improper handling may lead to personal death or severe injury.
 Caution	Means improper handling may lead to personal injury or property loss.

[Note]: 1. "Harm" means injury, burn and electric shock which need long-term treatment but need no hospitalization.
 2. "Property loss" means loss of properties and materials.







■ Icon description

Icon	Meaning
	It indicates forbidding. The forbidden subject-matter is indicated in the icon or by images or characters aside.
	It indicates compulsory implementation. The compulsory subject-matter is indicated in the icon or by images or characters aside.

 Warning	Delegate installation	<ul style="list-style-type: none"> ■ Please entrust the distributor or professionals to install the unit. The installers must have the relevant know-how. Improper installation performed by the user without permission may cause fire, electric, shock, personal injury or water leakage. ■ Please do not strike down the M-INTERFACE gateway controller, otherwise it may lead to abnormal operation, overheating, and cause electric shock or fire etc. damages.
	 Usage Warning	Forbid
	Forbid	Do not operate with wet hands or let water enter the M-INTERFACE gateway controller. Otherwise, electric shock may occur.

2. ACCESSORIES

Table 2-1

Accessory Name	Qty.	Sharp	Purpose
Owner's & Installation Manual	1		_____
Control box	1		_____
Power line	1		_____
Communication socket with 3 terminals	8		_____
Communication socket with 6 terminals	1		_____
One Button battery	1		_____

Note:

As the product updates, this document will be changed without prior notice.



NOTE

- Do not install near a place leak flammable gas easily, otherwise it may cause fire;
- Wiring according to the instruction manual, do not press the terminals, otherwise it may cause electricity leakage, wire broken, overheat, and fire.

Before carefully read this manual, do not connect the control system power, and do not do any installation work, until ensure the preparation work has been done.

3. M-INTERFACE GATEWAY CONTROLLER INSTALLATION



CAUTION

- Do not install near where has electromagnetic interference or network stations;
- Do not install near a place has any heat source and steam source or flammable gas source, which will cause electric leakage easily;
- Installation should comply with the local rules;
- Ensure there has enough installation space, for heat dissipation of the community service network device nearby.

3.1 M-INTERFACE Gateway controller structure

1) Front view of M-INTERFACE gateway controller (Unit: mm)

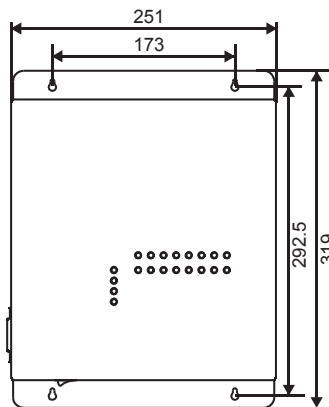

Fig.3-1

2) Side view of M-INTERFACE gateway controller (Unit: mm)

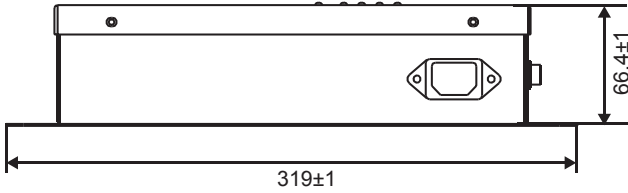

Fig.3-2

3) Detailed drawing of installation holes (Unit: mm)

Installation precautions:

- Install at a place where should not affect by electro-magnetic wave or dust;
- Avoid to install at a place where affects by sunshine or heat source device etc;
- Avoid to install at a place where has high humidity or can contact the water;
- Avoid to install at a place where will produce corrosive or flammable gas.

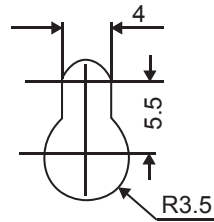

Fig.3-3

3.2 System framework specification

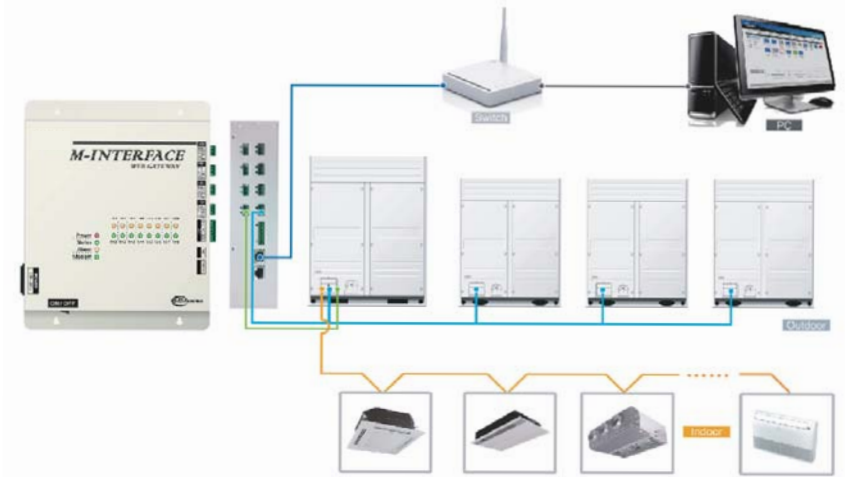

Fig.3-4

M-INTERFACE gateway controller is used for query and controls the air-conditioning indoor unit, and transmits the status information of indoor unit to the computer and transmits the controlling and querying orders sent by the computer to the indoor unit.

1) M-INTERFACE gateway controller indication instructions

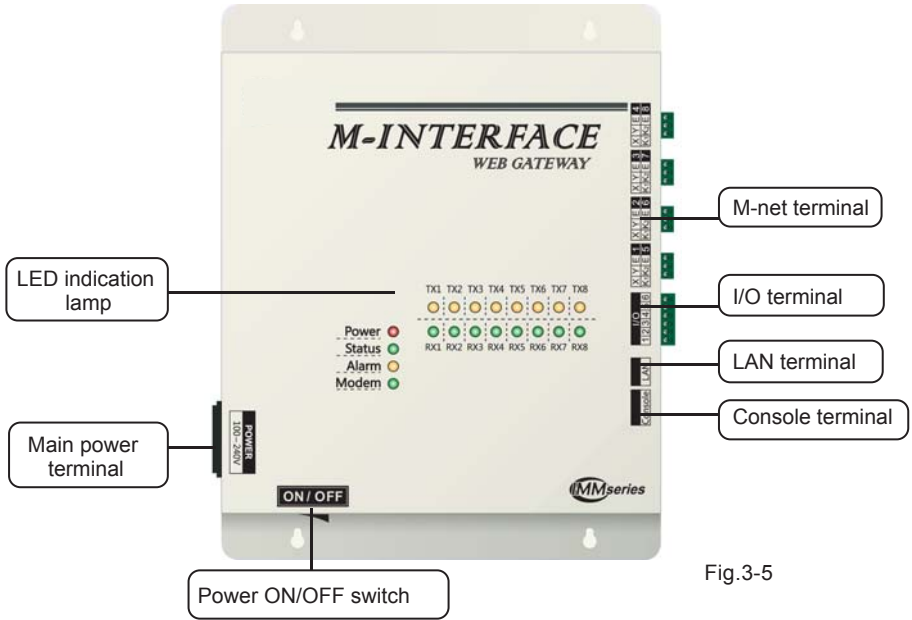

Fig.3-5

M-INTERFACE gateway has 8 M-net terminals, 1 LAN terminal, 8 M-net terminal indication lamps, 4 status display lamps (Power, Status, Alarm, and Modem) and power switch. Connect to the central air-conditioning system through the M-net terminal, and connect the local area network or Internet network through LAN terminal. Computer or other similar devices can visit M-INTERFACE WEB through Brower, and then local or remote control the devices.



NOTE

- Install the gateway at a side of M-net communicating bus, do not install it in the middle of the bus.
- Use 3-core shielding wire with 0.7mm²~1.0mm² for wiring, details please refers to professionals.

2) Terminal figure

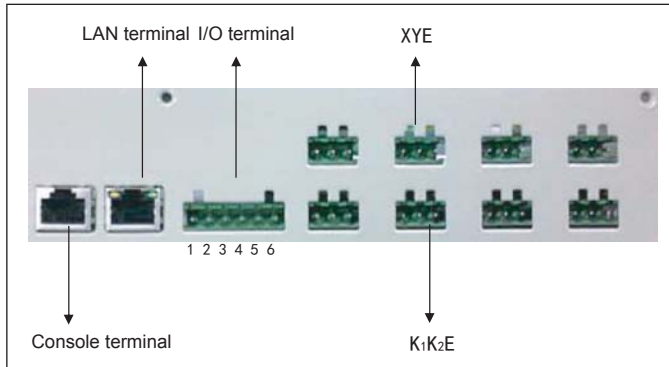

Fig.3-6

3) LED indication lamp instructions

Table.3-1

Indication lamp	Color	Indication lamp instructions
TX1~TX8	Yellow	No.1-8 sending terminals indication lamp
RX1~RX8	Green	No.1-8 receiving terminals indication lamp
Power	Red	Power indication lamp
Status	Green	Status indication lamp
Alarm	Yellow	Alarm indication lamp
Modem	Green	Reserve indication lamp

LED status:

- Under normal situation, Status lamp will flash with 1HZ frequency, and Alarm lamp will light off;
- Under error situation, Status lamp will flash with 1HZ frequency, and Alarm lamp will flash with 1HZ frequency.

4) Specification parameters of M-INTERFACE gateway controller

Table.3-2

Power specification	Voltage range	Single phase AC 100~240V, 50/60 Hz
	Consumed power	Max.15W
Using conditions	Voltage fluctuation	Rated value $\pm 10\%$
	Ambient temp.	-10~50°C
	Ambient humidity	0~95%
	Storage temp.	-20~60°C
Capacity	Insulated resistance	When it is DC 500VM, it will over 50M Ω
Weight	4.4kg	
Color of the cover	Milky white	

5) Definitions for code switch as follow:

Table.3-3

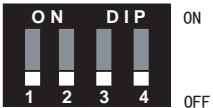
Gateway controller	On	Off (Factory state)	
SW1-1	No Electric Quantity Partition function	Electric Quantity Partition function	
SW1-2	Dial code setting IP	WEB setting IP	
SW1-3	Manual topology	Auto topology	
SW1-4	Reserve		

Note: Dial code switch needs to take off the cover of control box, and take down four screws on the cover.

6) Button battery installation

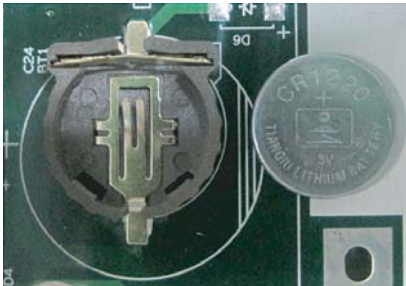

Fig.3-7



Fig.3-8



NOTE

After adjusted the dial code switch, please install the button batteries (attached in the accessories package) as the above figure. And synchronize the time refers to 5.2 Time setting.

7) IO terminal

Table.3-4

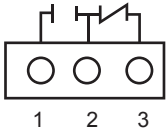
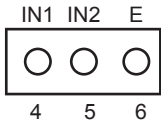
Gateway controller	Base pin name	Function definition
Pin1		Gateway controller error output;
Pin2		When the device operates normally, break off Pin1 and Pin2, close Pin2 and Pin3; when it is error, close Pin1 and Pin2, break off Pin2 and Pin3.
Pin3		When it's powered off, the device still output error.
Pin4		Emergency stop signal, this signal is input signal, and if this signal is high-level (12~36VDC), then means emergency stop; if this signal is low-level (0~0.7VDC), then means normal.
Pin5		Reserve function
Pin6		Ground wire with emergency signal

8) Uninterruptible power supply (UPS BK650-CH optional)

Table.3-5

Requirements	Performance
Capacity	650 VA/400 Watt
Voltage	220V±8%(Battery)
Control signal	50Hz±1Hz(Battery)
<p>Note: When cut off the power please completely close the computer.</p>	

4. SYSTEM INTRODUCTION

M-INTERFACE is a Central Air-conditioning multi-connected devices' gateway which based on WEB, is an important part of Intelligent Manager system (IMM). Connect to Central Air-conditioning devices through the M-net terminal. It can connect the multi-connected devices through its M-net connector (M-net connector is XYE communication terminals and K1K2E communication terminals); under the auto topology mode, it can connect 4 refrigerant systems at most (can insert 256 sets indoor units and 16 sets outdoor units); under the manual topology mode, it can connect 16 refrigerant systems at most (can insert 256 sets indoor units and 64 sets outdoor units). The operation methods of auto topology and manual topology please refer to IMM TECHNOLOGY MANUAL. The appearance interface of M-INTERFACE gateway as follow displays:

4.1 M-INTERFACE Network

- 1) M-INTERFACE gateway can connect the local area network or Internet network through LAN terminal. M-INTERFACE network topology as follows Fig 4-1.
- 2) M-net terminals are listed to be two rows, 1-4 are XYE terminals, 5-8 are K1K2E terminals. Computer or other similar devices can visit M-INTERFACE WEB through browser, and then local or remote control the devices.

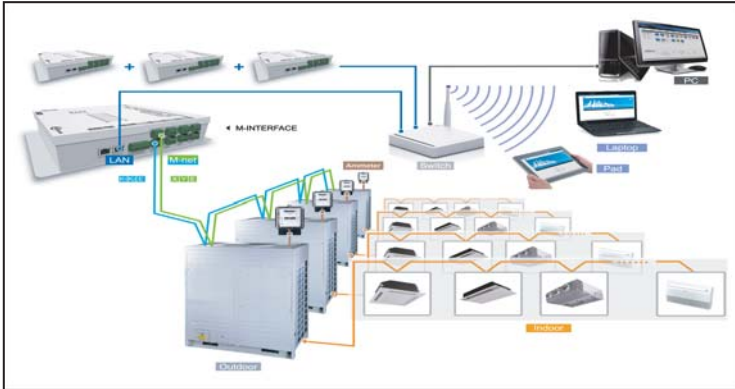

Fig.4-1

4.2 Models which could be inserted

- 1) Projects which do not need electric quantity division: can freely insert V4+ units.
- 2) Projects which need electric quantity division: connect the V4+ series outdoor units and indoor units, and wiring the M-net terminal communication wire from the outdoor side.
- 3) Details refer to IMM TECHNOLOGY MANUAL.

4.3 Base on WEB technology

M-INTERFACE is a gateway based on WEB technology, unrelated to computer or similar devices operation systems. M-INTERFACE insert into network then can browse the WEB page through the browser of system platform, we suggest using IE (9.0 or above), Firefox (11.0 or above), Chrome (18.0 or above) or Safari (5.1 or above).

4.4 Local network connection

M-INTERFACE gateway can connect to the LAN network through switch. IP address of computer or similar devices must in the same subnet area as the IP address of M-INTERFACE gateway.

4.4.1 IP configuration

Default IP of gateway is 192.168.100.40, subnet cover code is 255.255.255.0. IP address of computer or similar devices should manual configure the statistic IP and within the range of 192.168.100, subnet cover code should be 255.255.255.0. If the computer only insert the M-INTERFACE network, then use the way of configuring single IP; if the computer also inserts the local network beside M-INTERFACE network, then use the way of configuring several IP. Methods as follow (Take windows 7 system for example).

1) Configure single IP

Open the property dialogue box to configure the IP address and subnet cover code, for example: IP: 192.168.100.44, subnet cover code: 255.255.255.0.

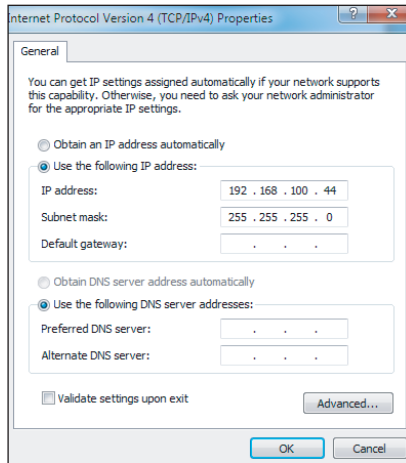

Fig.4-2

After configuration, click the “OK” button.

2) Configure several IP

Before configure several IP, it needs to configure a statistic IP address, configuring steps as follow:

- Check the local IP

Open the property dialogue box, as Fig.4-2 display, if the option “Use the following IP addresses(S)” has been selected, and the interface displayed IP address, that means the local IP is statistic IP address. Otherwise it is a dynamic IP address, then it needs to configure a statistic IP address.

- Configure statistic IP address

Open the “Start” menu, and type “cmd” in the search column, and display the dialogue box as follow:

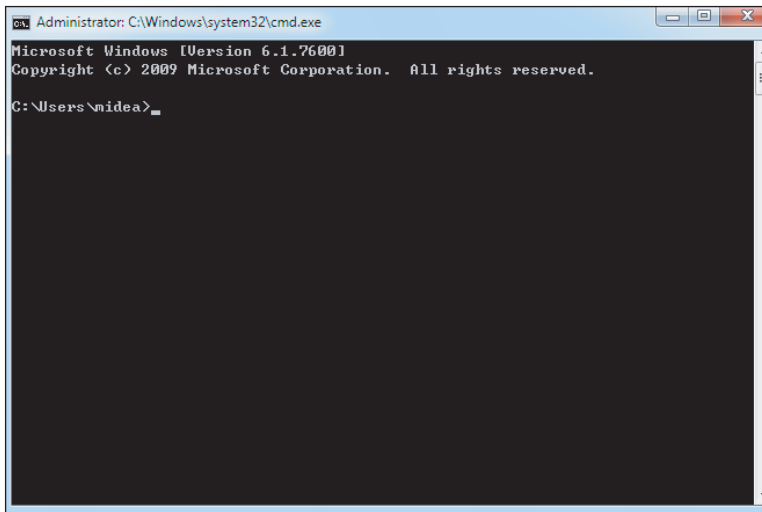

Fig.4-3

Type "ipconfig" in the above figure, then the interface will display the local dynamic IP address, and it will write this IP address into the property dialogue box, and finish the statistic IP address configuration, details please consult the local network administrator.

After the statistic IP address configuration, open the property dialogue box again, select the "Advanced", and display the TCP/IP setting dialogue box as follow:

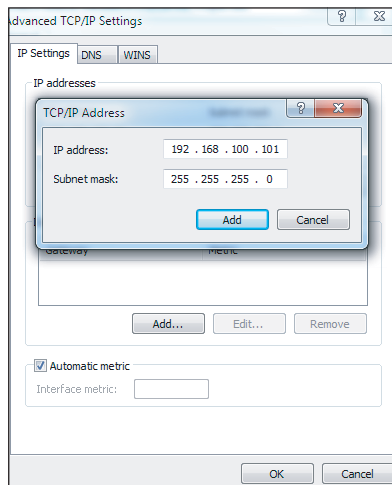

Fig.4-4

Click the "ADD" button under IP address column, and add a IP address with the same network segment of "192.168.100.40", such as IP: 192.168.100.101, sub network cover code: 255.255.255.0, and click "OK" button.

4.4.2 Local LAN access

If there is a computer or other similar device of same subnet area as M-INTERFACE in LAN, then type the link address of M-INTERFACE gateway (e.g.: <http://192.168.100.40>) on the browser address bar can visit the M-INTERFACE WEB interface to operate the air-conditioning device. The local visit topology structure as follow display:

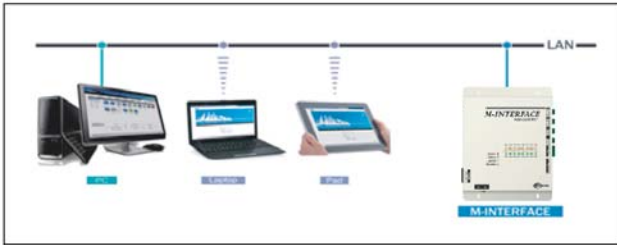

Fig.4-5

4.5 Remote network connection

Under the allowable situation, M-INTERFACE gateway can set in the office network; the user can operate the air-conditioning device through the computer or similar devices. Remote insert should base on some IT technology and help by the network administrator. Three remote insert methods:

1) Statistic IP

Configure public network address statistic IP address for M-INTERFACE gateway, and set it in the internet; directly visit this public network address then can visit the WEB interface. Ask the local network operator for the public network address. The public network address insert fee will be charged by operator, and consider the network safety at the same time.

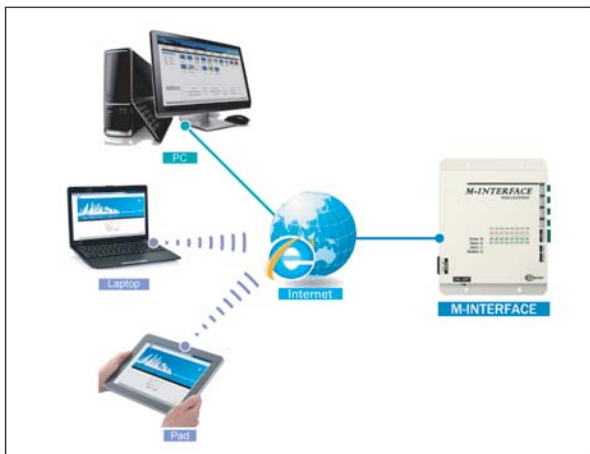

Fig.4-6

2) Network terminal mapping

If the company has a public network address, then it needs to send a mapping of a terminal in fire wall to M-INTERFACE gateway; when the computer or similar device of outside network visit the M-INTERFACE, then take `http:// public network IP: visit as a terminal`. E.g.: `http:// 203.208.60.72:6080`.

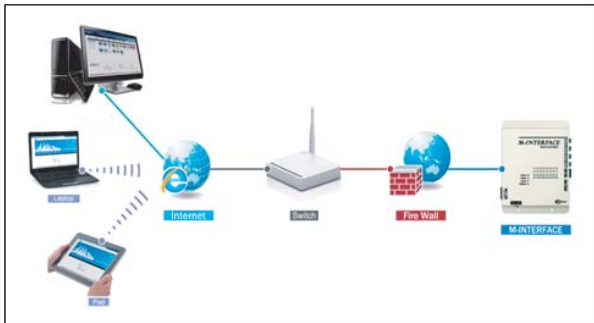

Fig.4-7

3) VPN visit

■ Router establishing

M-INTERFACE gateway might use a same public IP address with other devices, under the situation of network cannot send terminal mapping to M-INTERFACE gateway, and then can use VPN for visiting. As the figure displayed, VPN tunnels establish between routers, and then can visit WEB interface through VPN tunnels. VPN Server can be established by oneself also can be rented. Its topology structure as follow display:

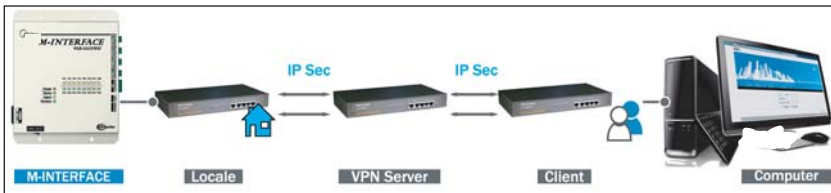

Fig.4-8

■ Computer establishing way

Establish VPN tunnel by computer is a little difficult for general users. Use VPN client-side software and VPN Server to establish VPN tunnel in the user's computer, then user can visit WEB interface through VPN tunnel. VPN client-side software and VPN Server can be achieved by commercial ways. Its topology structure as follow display:

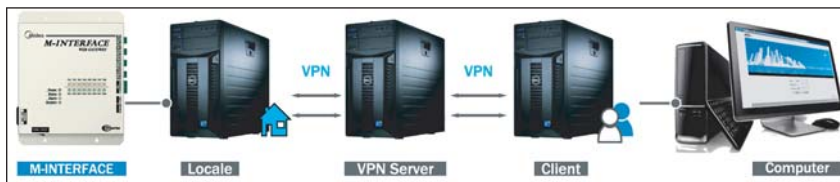

Fig.4-9

4.6 WEB functions introduction

WEB system has “Device monitoring”, “System mapping”, “Setting”, “Device information” and “Help” etc. functions.

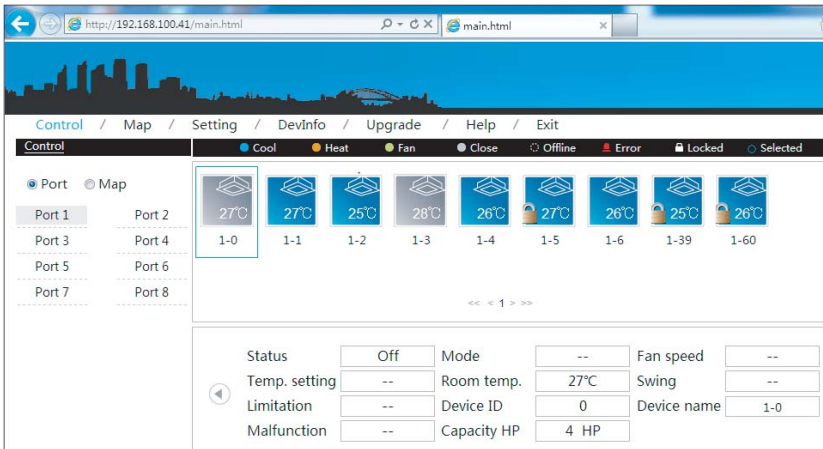

Fig.4-10

1) Device monitoring

Offer indoor and outdoor units' operating details and control the indoor unit.

2) System mapping

Display the entire situation of refrigerant system; include quantities of indoor and outdoor units in refrigerant system, ammeter quantity and communication quality between single device and M-INTERFACE gateway.

3) Setting

Offer the centralize controller configuration, time setting, IP setting and User management etc. functions.

4) Device information

Display and amend detail information of indoor and outdoor devices in air-conditioning system.

5) Help

Offer helping information for user.

5. SETTINGS

Do the following settings before using the M-INTERFACE gateway.

5.1 M-INTERFACE setting

M-INTERFACE gateway setting as the following display:

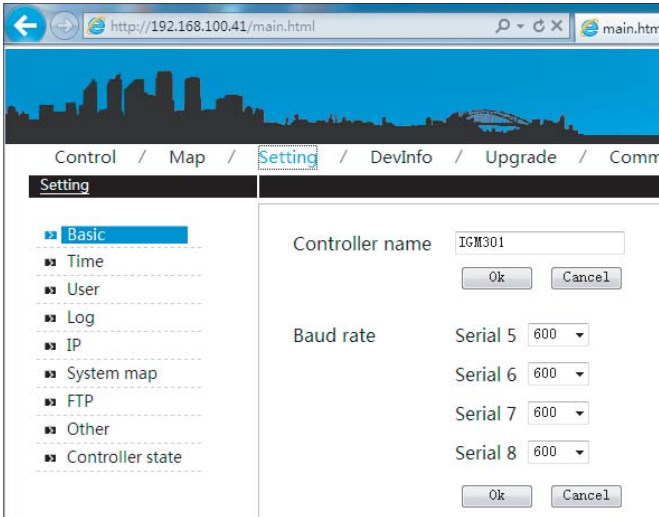

Fig.5-1

5.2 Time setting

Offer M-INTERFACE gateway system time synchronization function, display as follow:

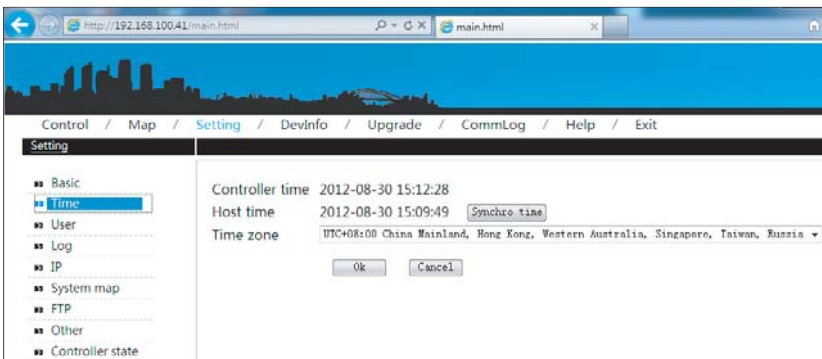

Fig.5-2

Select the time area, click the “OK” button, and then click the “Synchro time” button for synchronization. Time synchronization function should be used with caution; details refer to IMM TECHNOLOGY MANUAL.

5.3 IP setting

If add the M-INTERFACE into local network, then it needs to reset the M-INTERFACE IP address, and click “OK ” button after setting. If many M-INTERFACES in the same network area, then the IP address could not be repeated.

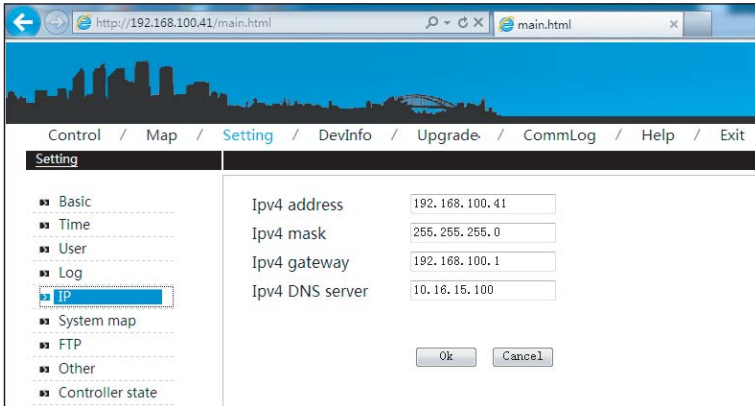

Fig.5-3

5.4 FTP setting

Set the IP address, terminal, login name (Default: test) and password (Default: 123456) of ftp server. Click “apply” button after setting.

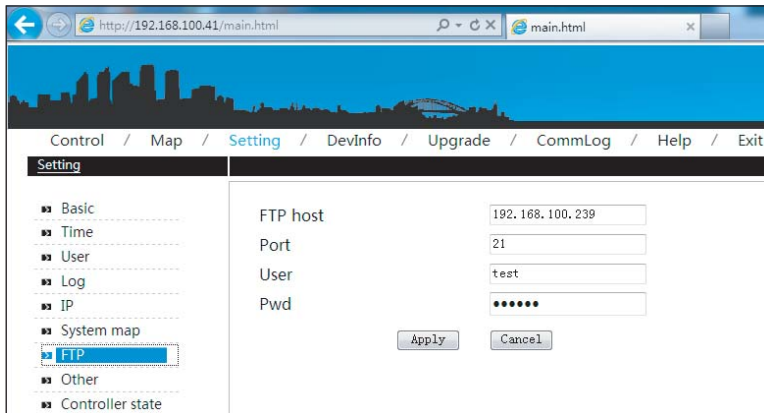

Fig.5-4

6. OPERATION INSTRUCTIONS

6.1 User login

Type the link address of M-INTERFACE gateway on the browser address (take windows 7 system, IE for example), then can visit the M-INTERFACE WEB login interface.

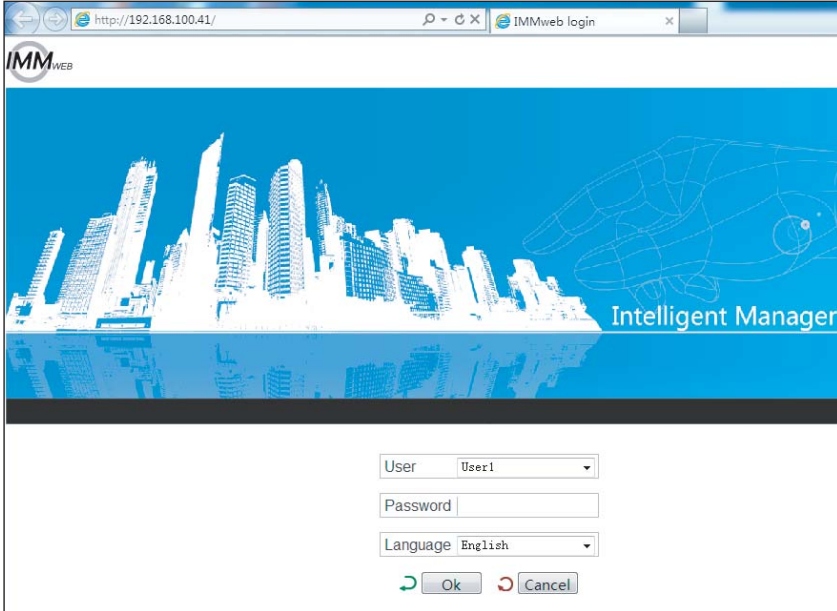

Fig.6-1

Enter the login page, user operates as follow to enter into system:

- 1) Select user name, type in password;
- 2) Select the display language;
- 3) Click [OK] to enter the M-INTERFACE WEB home page;
- 4) Click [Cancel] to cancel this typing;
If login failed please refers to 7.2 in Appendix.

For safety, every user only can login at one place, if there are repeated login (even the same computer with different browser), it will force the first login user back to the login interface. After the user login, 5 minutes without operations, and re-operate it, the page will automatically back to the login interface.

6.2 Main interface introduction

WEB home page display as follow:

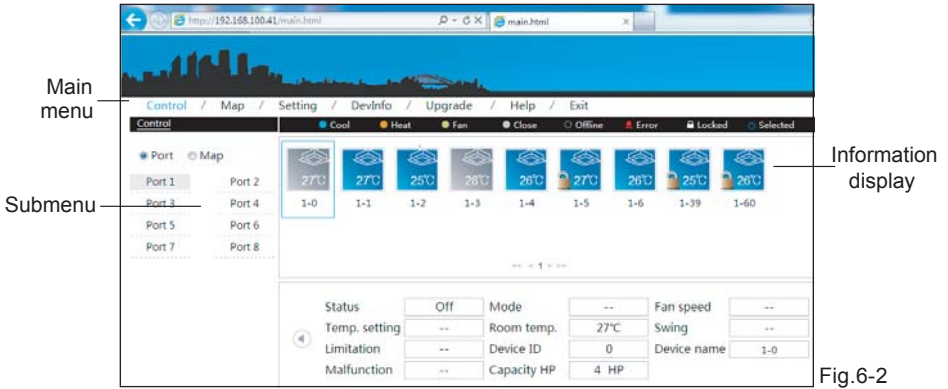

Fig.6-2

Home page: main menu, submenu and information display. Main menu: display all functions of system, include “Device monitoring”, “System mapping”, “Setting”, “Device information” and “Help” etc. functions. Submenu: simple divide the main menu. Information display: display information of a function.

6.3 Devices monitoring

According to terminal and system to display the operating status of indoor and outdoor units, and control the indoor unit. Find out the error in system through checking the operating status of indoor and outdoor units. Detailed display the page will refresh every 10 seconds.

6.3.1 Terminals monitoring

Select the terminal, the page will display corresponding air-conditioning devices under 8 M-net terminals, and the connected indoor units in 1-4 terminals; it offers checking and amending functions the operating status of indoor unit.

1) Check the operating status of indoor unit



Fig.6-3

The operating statuses of indoor unit are cool, heat, fan, OFF, power off, error and lock. Different operating statuses will has different pictures. Click a single indoor unit, then it will display the operating status information of this indoor unit on the bottom of page, include ON/OFF status, operating mode, device name and HP etc. information.

2) Control the operating status of indoor unit

Click the “⌂” button in the page, then can control the indoor unit operating status page.

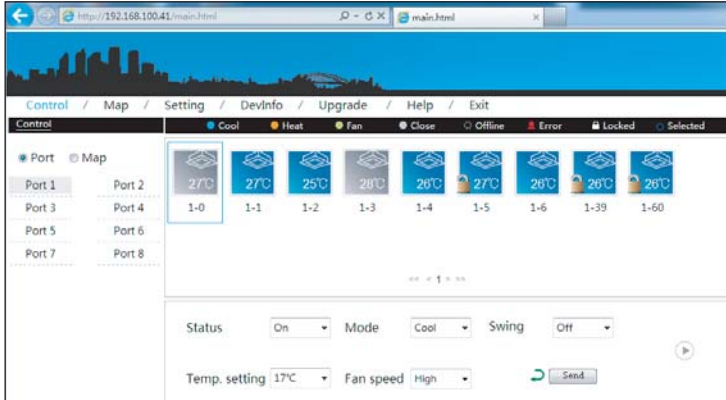

Fig.6-4

Control the air-conditioning indoor unit through single select and multi-select; select one or more air-conditioners, set the controlling parameters, include “ON/OFF setting”, “Mode setting”, “Swing setting”, “Temp setting” and “Fan speed setting”, and then click the “Send” button to send the control order, and the page will display success or fail information. Check the execution status of order through the change of the icons on the page.

3) Check the operating status of indoor unit

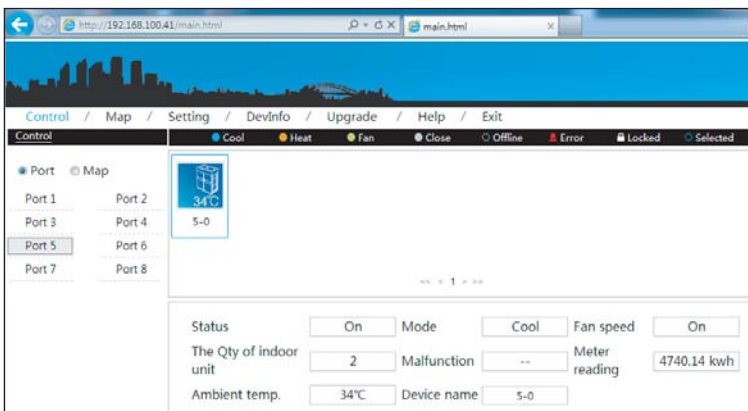

Fig.6-5

Select the 5-8 terminals, the page will display the corresponding outdoor unit, and then click the picture of an outdoor unit, and it will display its operating status include ON/OFF state, operating mode, fan state, indoor unit quantity, error protection, ammeter readings etc.

6.3.2 System monitoring

Display all the indoor units of refrigerant system as the system way, has the function of checking and controlling the operating status of indoor unit.

- 1) Check the detailed information of indoor unit

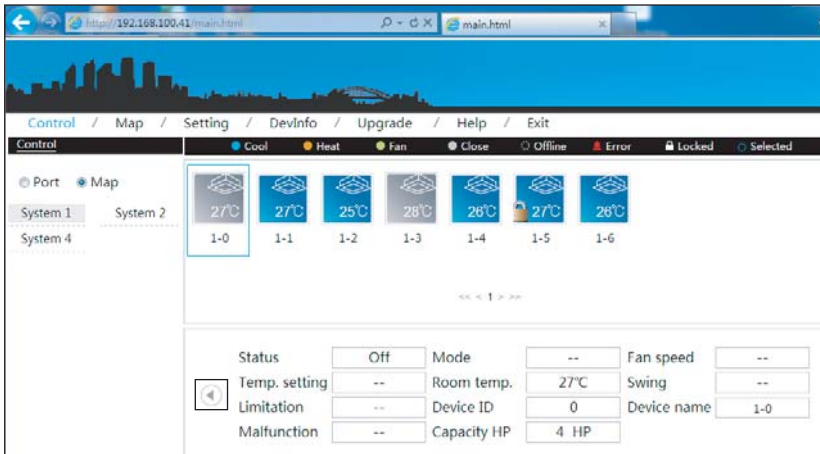

Fig.6-6

Select the refrigerant system, the page will display all the indoor unit of the refrigerant system, and then click the indoor unit and it will display its operating status include ON/OFF state, operating mode, fan state, indoor unit quantity, error protection, ammeter readings etc.

- 2) Control the operating status of indoor unit

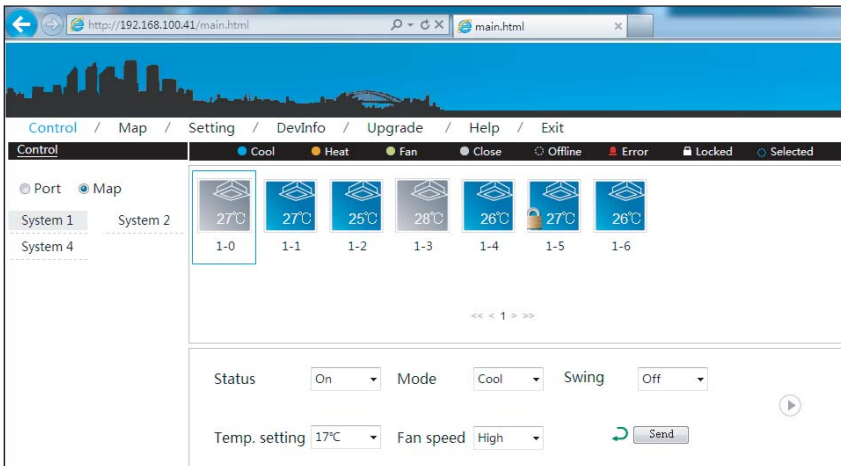

















Fig.6-7

Click the “” button in the page, then can control the indoor unit operating status page. Select one or more air-conditioners, set the controlling parameters, include “ON/OFF setting”, “Mode setting”, “Swing setting”, “Temp setting” and “Fan speed setting”, and then click the “Send” button to send the control order, and the page will display success or fail information. Check the execution status of order through the change of the icons on the page.

Icon specification:

Table.6-1

Icon	Specification	Icon	Specification
	Indoor unit error (RED)		Indoor unit is selected, indoor ambient temp. is 25°C (BLUE)
	Indoor unit lost connection (WHITE)		Outdoor unit operates cooling, outdoor ambient temp. is 25°C (BLUE)
	Indoor unit operates cooling, indoor ambient temp. is 25°C (BLUE)		Outdoor unit is OFF, outdoor ambient temp. is 25°C (GREY)
	Indoor unit operates heating, indoor ambient temp. is 25°C (CROCI)		Outdoor unit operates heating, outdoor ambient temp. is 25°C (CROCI)
	Indoor unit operates fan, indoor ambient temp. is 25°C (GREEN)		Outdoor unit error (RED)
	Indoor unit is OFF, indoor ambient temp. is 25°C (GREY)		Outdoor unit is selected, outdoor ambient temp. is 25°C (BLUE)
	Indoor unit is locked, indoor ambient temp. is 25°C (GREY)		Outdoor unit lost connection (WHITE)

6.4 System mapping

Display the entire situation of refrigerant system, to reflect the mapping relationship between the indoor and outdoor units.

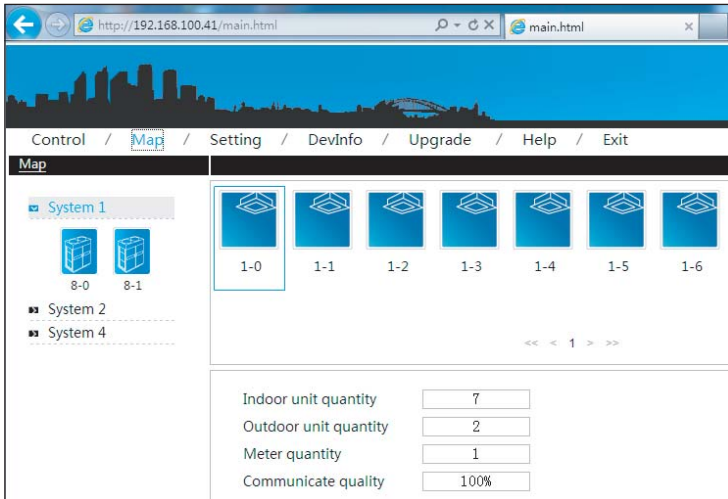

Fig.6-8

Select a single refrigerant system, the page display all the indoor unit pictures of this refrigerant system, and the bottom of the page display the indoor unit quantity, outdoor unit quantity and ammeter quantity. Click the single indoor unit to check the communication quality between this device and the M-INTERFACE.

Characters instruction:

Table.6-2

Indoor unit qty. of refrigerant system	Calculate all the indoor unit qty. of refrigerant system
Outdoor unit qty. of refrigerant system	Calculate all the outdoor unit qty. of refrigerant system
Outer ammeter qty. of refrigerant system	Calculate all the ammeter qty. of refrigerant system
Communication quality	Communication quality between single device and M-INTERFACE gateway

6.5 Setting

For safety operation of M-INTERFACE, it only offer the “User management” function (Other functions refer to the IMM TECHNOLOGY MANUAL).

6.5.1 User management

Offer the password changing function.

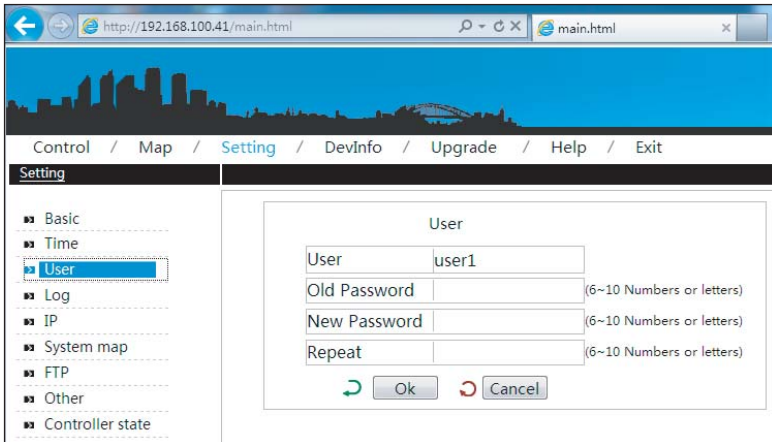

Fig.6-9

Click “OK” button after changing.

6.5.2 Refrigerant system mapping

Output the topology document, the auto topology structure as follow display:

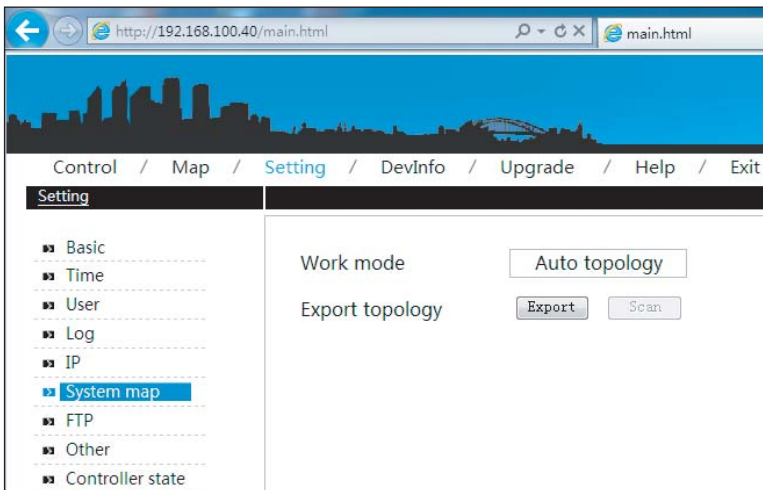

Fig.6-10

6.5.3 Gateway controller status

Display the status information of gateway controller.

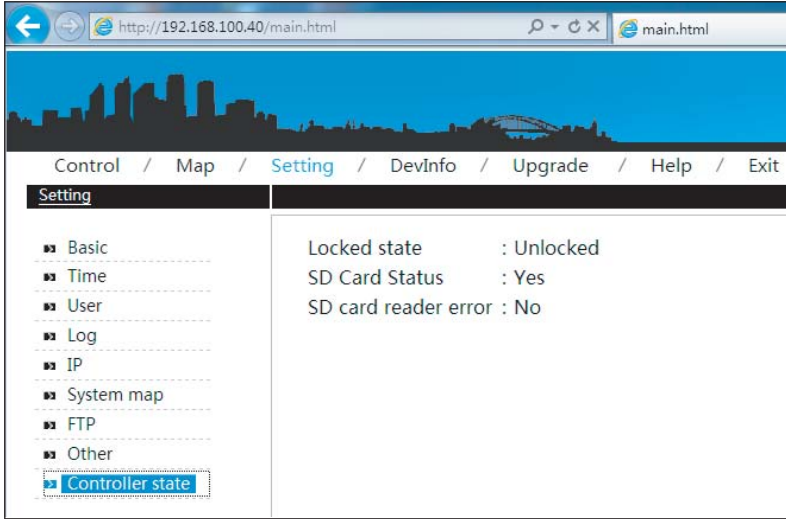

Fig.6-11

6.6 Device information

Check the indoor/outdoor device information in the refrigerant system.

6.6.1 Indoor unit information

Select the refrigerant system, click the “Indoor Info”, and the will show up the indoor unit information display page, as follow:

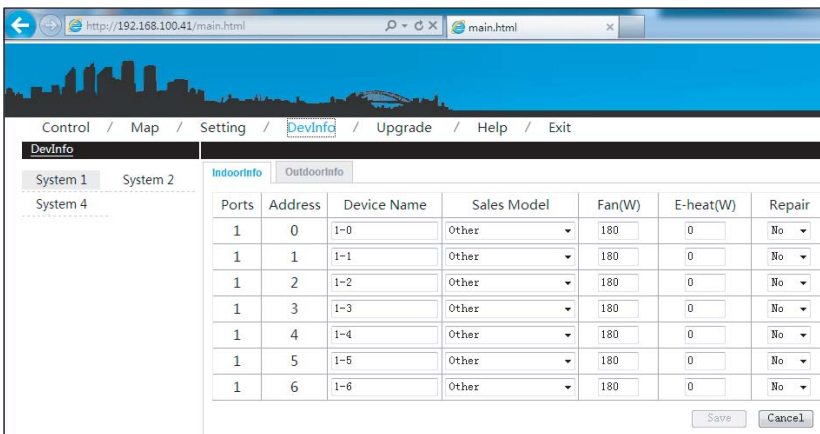

Fig.6-12

The display contents include: serial port (terminal no. which inserted into), address, physics location, sales model, fan power, E-heater power and maintenance status information.

6.6.2 Outdoor unit information

Select the refrigerant system, click the “Outdoor Info”, and the will show up the outdoor unit information display page, as follow:

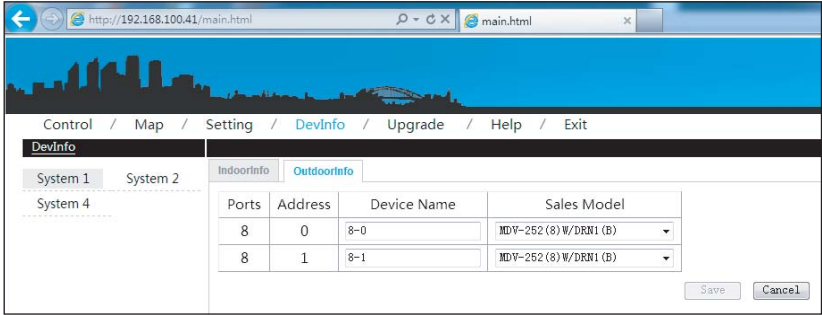

Fig.6-13

The display contents include: serial port, address, physics location and sales model.

6.7 Help

This function offers error code table for analyze, to help user to check the error of air-conditioner. This error code may differ from the display contents in the display board, please consult the local technical support specialist.

6.8 Exit

This function can operate back to the login page, click the “Exit” menu, the system will back to the login page automatically.

7.TROUBLESHOOTING

7.1 Unable to enter into the login page

Type the IP address of M-INTERFACE gateway in the browser, if it cannot display the login page, which may be error of network; if it's needed, ask the IT administrator to check the local network. Check the computer whether stay the same network area with the N-INTERFACE gateway.

7.2 Login failed

When the user is logging, there might be login fail as the following:

1) No password

If the user did not type the password, and clicked "OK", then it would display as follow:

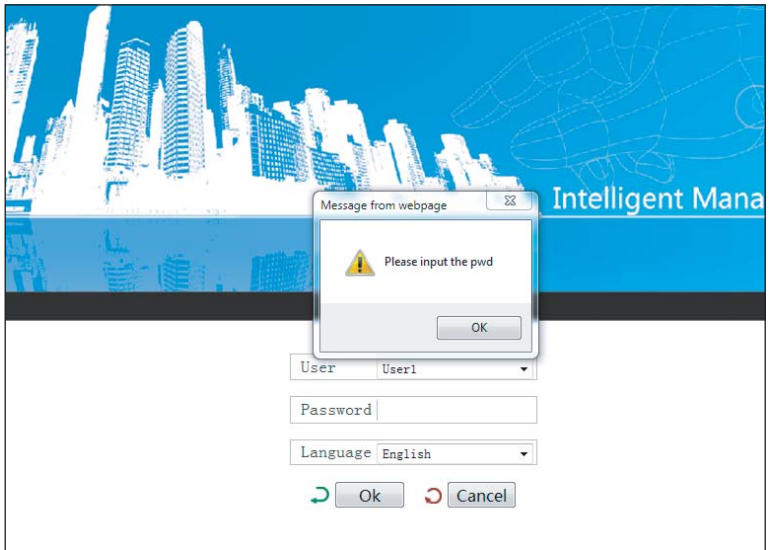

Fig.7-1

Type the correct password and then login again.

2) Wrong password

When the password was wrong, it would display as follow:

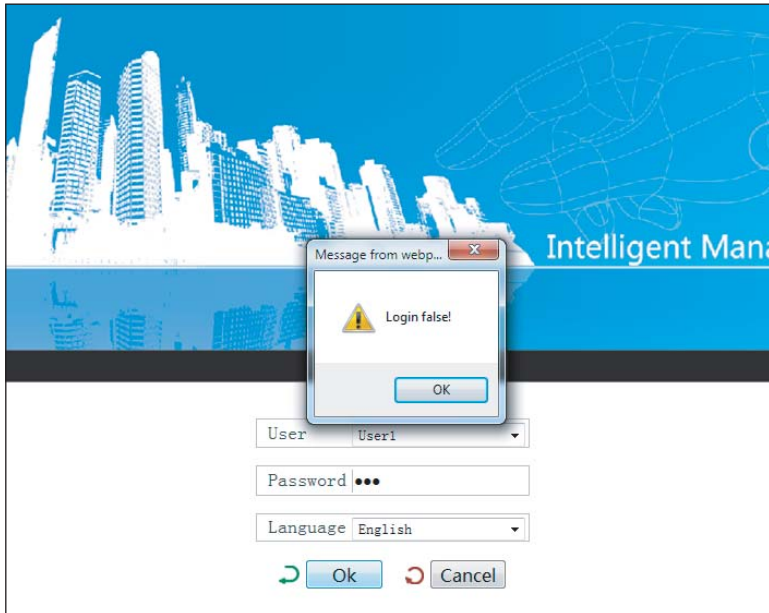

Fig.7-2

Type the correct password again.

7.3 No device displayed

If login successfully, and no data display in the home page, then contact the dealer or technicians to check whether the wiring of M-net communication terminal was correct, and whether the air-conditioner system has been insert correctly to the M-INTERFACE gateway.

7.4 Control operation failed

When changing the operating status of the indoor unit, there might be prompt message of "Setting failed", which means the current operation failed. Contact the dealer or technicians to check whether the communication between the device and M-net terminal was correct, and also the Ethernet.

7.5 No respond in page

When operating the page and no respond or display "No connection" message, that means the network communication between computer and M-INTERFACE gateway was broke off, and it needs to check the computer network card, IP setting, and the switch board, as well as the IP of the M-INTERFACE gateway and LAN terminal network card indication lamp of M-INTERFACE gateway.

MD12IU-013AW

202055100872