

Cleanroom diffusers









Cleanroom diffusers, Dako Cytomation, Glostrup.

About Lindab	1
Comfort and Design	2
Product overview / symbols	3
Theory	4
Ceiling diffusers	5
Ceiling diffusers - visible	6
Plenum boxes	7
Wall diffusers	8
Nozzles	9
Ventiduct	10
Grilles	11
Displacement units	12
VAV	13
Constant- / variable flow dampers	14
Air valves	15
Fresh air valves/overflow unit	16
Cleanroom diffusers	17
Contents	18

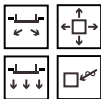
Cleanroom diffusers

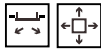
Cleanroom diffusers

Diffusers

	Product	Functions	Page
	LCR 1		655
	LCR 2		662
	LCR 3		664
	LCR 4		666

LCR

Ceiling adaption

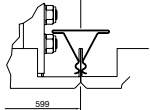
	Product	Functions	Page
	LCR		668

LCRZ

Accessories

	Product	Functions	Page
	LCRZ		669

LCRF

Filter

	Product	Functions	Page
	LCRF		670

Cleanroom diffusers



Cleanroom diffusers

Cleanroom is traditionally used within the pharmaceutical and bio-technical industry, but also producers of food and electronics are often forced to comply with demands which require a cleanroom. We have found it natural to co-operate with some of the leading companies within the pharmaceutical industry to create an optimal solution. Using their knowledge about the daily use of cleanrooms as a work place, we have developed solutions closely tuned to the high demands made on cleanrooms with regards to both installation and operation.

Lindab offers the broadest selection on the market, with cleanroom diffusers with many adaption possibilities. Lindab is also able to both deliver and advise on special solutions. While developing the diffuser programme, the emphasis has been placed on designing a construction, which has a number of advantages with regards to user-friendliness. We have made sure it is easy to clean, maintain, and test the diffusers.

Our solutions are in use

Lindabs cleanroom diffusers are used in many companies and within many different industrial sectors.

Among our references are: Novo Nordisk, GEA Niro, DakoCytomation, Grundfos, Research-center Risø and Chr. Hansen.

When it comes to cleanroom ventilation, the quality of the solution is the deciding factor. We know, that our customers have chosen our cleanroom diffusers because the solutions are sure to meet the important requirements made on cleanrooms.

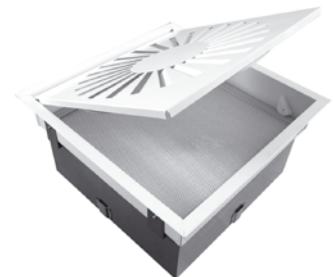

Clean-room diffuser

Ceiling diffuser

LCR1



Description

The LCR1 diffuser is a clean room diffuser that can be equipped with a HEPA filter, for installation in ceilings. It is typically used in premises where there are stringent requirements concerning the amount of particles and germs in the air. The diffuser can be used both to supply and exhaust air. LCR1 is available in two sizes and with three different types of duct connection. The diffuser can be adapted for the most popular ceiling systems with reference to the order code. It is normally supplied with a rotating front plate, which ensures good mixing and distribution of air throughout the premises. The supply air pattern can be adjusted in size to suit the volume flow rate. The diffuser is also available with a fully-perforated front plate for vertical supply air or exhaust. The diffuser excels by having a hinged front plate and extremely simple and easy filter installation. Filters are supplied by Camfil Farr with a PU or Gel seal.

- Airtight all-welded box in stainless steel
- Hinged drop-down front plate
- Simple and easy filter installation
- Supplied adapted for the most popular ceiling systems
- Pattern of airflow adapted for actual volume flow rate
- Detachable duct connection (circular side connection)
- Mounting brackets for threaded bolts are supplied as accessories
- Low net weight
- Equipped with outlet for pressure measurement and DOP testing
- The lower section can be supplied in stainless steel

Materials and finish

Upper section:

Material: Stainless steel

Lower section:

Material: Galvanised steel, powder-coated
Standard colour: RAL 9010, gloss 30

The diffuser is available in other colours. Please contact Lindab's sales department for further information.

Order (size 400)

Product	LCR1	a	b	c	ddd	400	F
Type							
Duct connection							
S = Side, Ø.							
T = Top, Ø.							
Filter type							
P = PU seal							
G = Gel seal							
Front plate							
H = High impulse (rot.)							
L = Low impulse (perf.)							
Air pattern							
300 = 300 (rot.)							
400 = 400 (rot./perf.)							
Size							
400							
Ceiling/type							
F = Fixed ceiling							

Order (size 600)

Product	LCR1	a	b	c	ddd	600	f
Type							
Duct connection							
S = Side, Ø.							
T = Top, Ø.							
R = Rect. side							
Filter type							
P = PU seal							
G = Gel seal							
Front plate							
H = High impulse (rot.)							
L = Low impulse (perf.)							
Air pattern							
300 = 300 (rot.)							
400 = 400 (rot.)							
500 = 500 (rot.)							
600 = 600 (rot./perf.)							
Size							
600							
Ceiling/type							
F = Fixed ceiling							
T = Visible T-rail							
C = Clip-In (bevelled)							
A = Other ceiling type*							

* To be stated in plain text

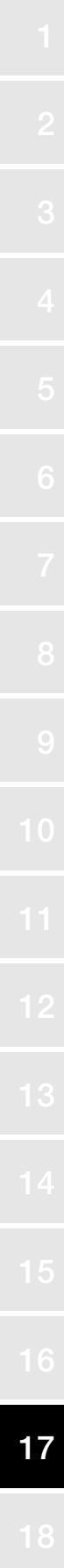

Ceiling diffuser

LCR1

Dimensions

Circular side connection

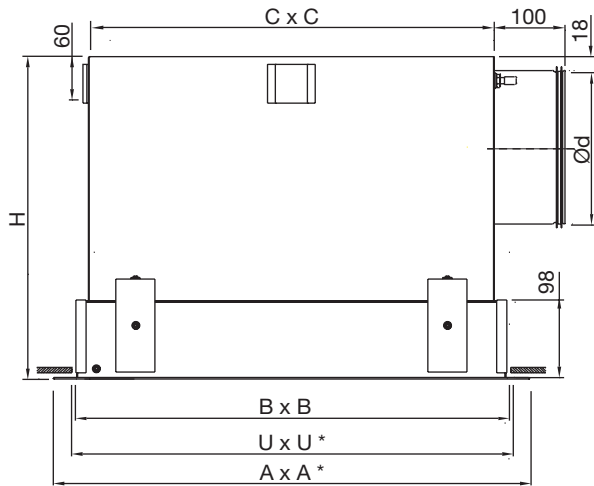

U x U = Min. cutting dimension

Size mm	Ød mm	H mm	A mm	B mm	C mm	U mm	m kg
400	125	325	415	360	325	365	5.2
600	200	420	615	560	525	565	14.6

Circular top connection

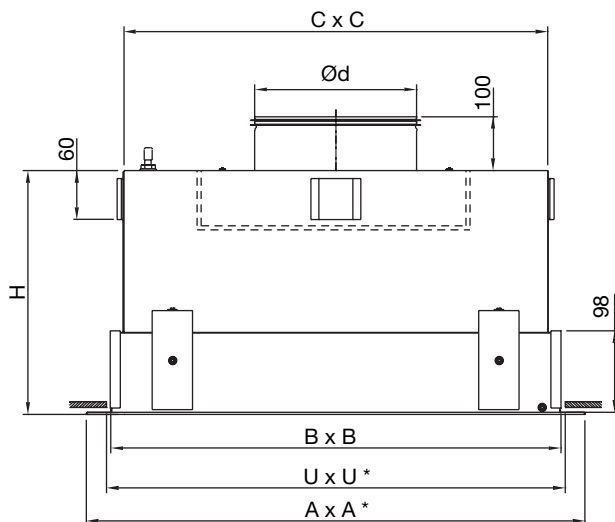

Size mm	Ød mm	H mm	A mm	B mm	C mm	U mm	m kg
400	125	300	415	360	325	365	5
600	200	300	615	560	525	565	12.8

Rectangular side connection

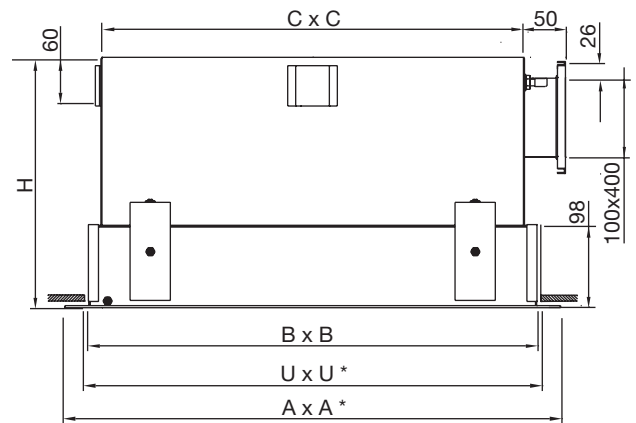

U x U = Min. cutting dimension

Size mm	H mm	A mm	B mm	C mm	U mm	m kg
600	310	615	560	525	565	12.4

Variant with increased capacity

The diffuser range can also be supplied in a different design for fixed ceilings, where the diffuser has an increased capacity of up to approx. 900 m³/h. However, the physical dimensions differ from the standard range. This version is made entirely of stainless steel.

A x A dimension: 698 x 698

The diffuser is supplied with a filter with the dimensions 610 x 610 x 110 mm.

*) Dimensioning applies for fixed ceiling diffusers. Dimensions for other ceiling types (size 600) are given in the ceiling adjustment section.

(Go to chapter: "Ceiling tile adaption")

U x U = Min. cutting dimension

Ceiling diffuser

LCR1

Technical data

All measurements include the class H-14 filter, manufactured by Camfil Farr.

Capacity

Volume flow q_v [l/s] and [m³/h], total pressure Δp_t [Pa], throw $l_{0.2}$ [m] and sound power level L_{WA} [dB(A)] can be seen in the diagrams on the next pages.

Frequency-related sound effect level

The sound effect level in the frequency band is defined as $L_{w_{ok}} = L_{WA} + K_{ok}$. K_{ok} values are specified in charts beneath the diagrams on the following pages.

Throw length

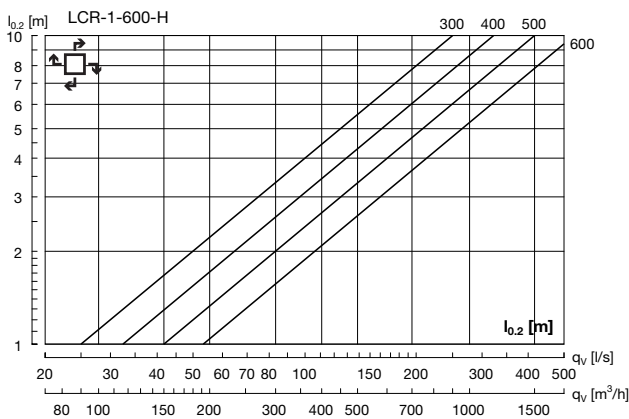
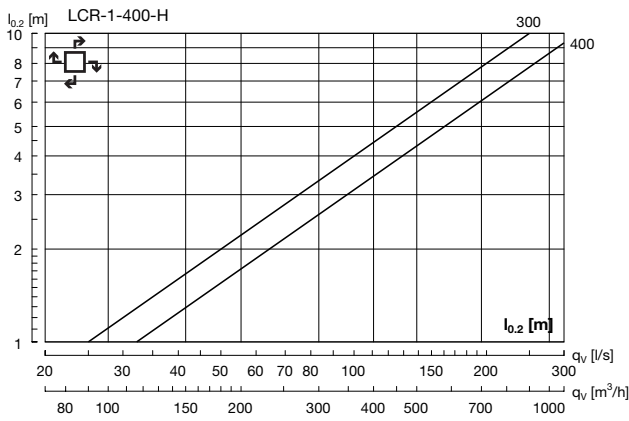

Sound attenuation

The diffuser's sound attenuation function from duct to room, including end reflection.

Size	Mean frequency Hz							
	63	125	250	500	1K	2K	4K	8K
400	20	13	7	9	12	11	12	18
600	16	10	12	7	8	9	12	18

Ceiling adjustment

LCR1 in size 600 is suitable for installation in several different types of ceiling system. Read more about this in the ceiling adjustment section.

Parts

Filter clip



Hinged drop-down front plate



Magnetic lock for front plate



Detachable circular duct connection (side only, Ø)



- 1
- 2
- 3
- 4
- 5
- 6
- 7
- 8
- 9
- 10
- 11
- 12
- 13
- 14
- 15
- 16
- 17
- 18

Ceiling diffuser

LCR1

Technical data (rotation - supply)

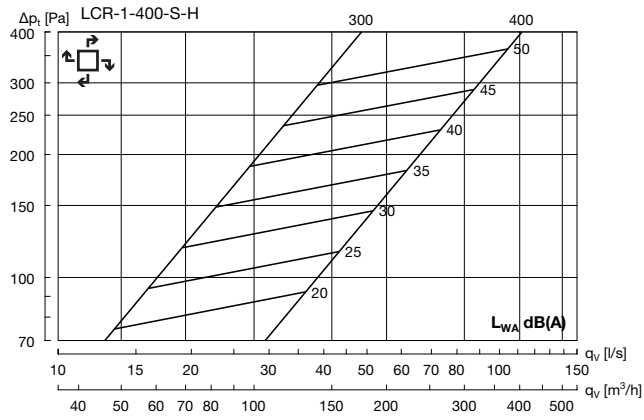

Size	63	125	250	500	1K	2K	4K	8K
400-300	0	3	1	-1	-5	-13	-23	-36
400-400	5	2	0	-1	-5	-10	-21	-25

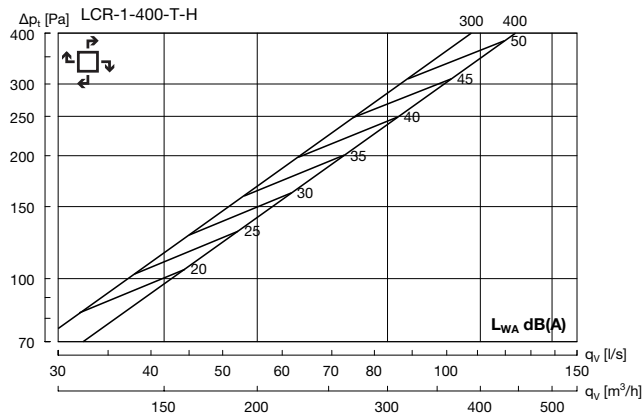

Size	63	125	250	500	1K	2K	4K	8K
400-300	6	4	1	-1	-5	-13	-22	-29
400-400	3	-1	-3	0	-5	-10	-22	-26

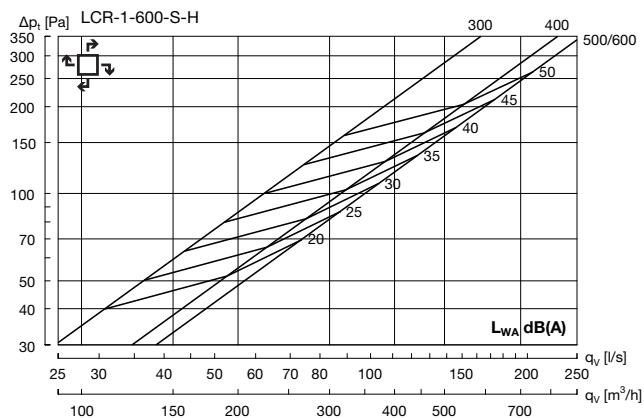

Size	63	125	250	500	1K	2K	4K	8K
600-300	1	7	1	-1	-6	-15	-24	-34
600-400	2	8	0	-2	-5	-12	-22	-34
600-500	2	5	-1	-1	-5	-12	-17	-28
600-600	1	-2	-4	0	-4	-12	-21	-28

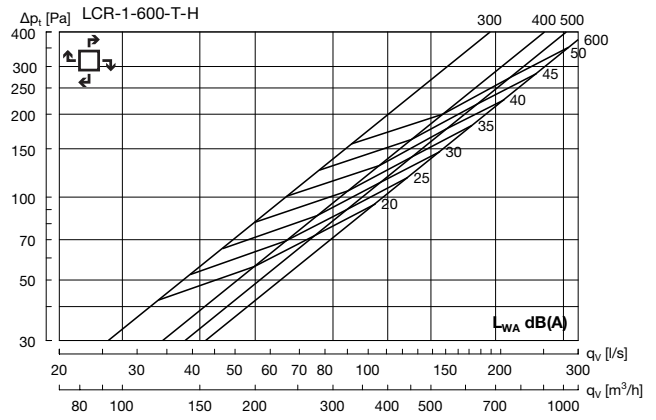

Size	63	125	250	500	1K	2K	4K	8K
600-300	4	7	2	-2	-5	-14	-25	-34
600-400	4	5	2	-2	-5	-12	-20	-33
600-500	5	5	1	-3	-4	-10	-24	-34
600-600	8	0	1	-1	-5	-12	-22	-28

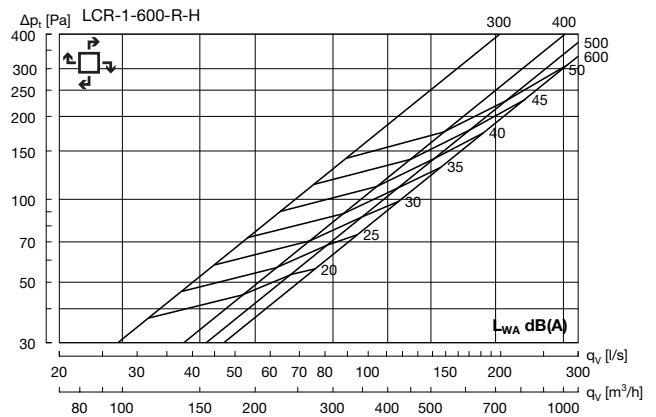

Size	63	125	250	500	1K	2K	4K	8K
600-300	7	7	1	-2	-6	-14	-22	-32
600-400	5	7	1	-2	-6	-10	-19	-28
600-500	3	5	-1	-4	-5	-7	-13	-25
600-600	2	-3	-4	-4	-4	-6	-16	-21

Code key

- S-H = Circular side connection
- T-H = Circular top connection
- R-H = Rectangular side connection

All measurements include the class H-14 filter manufactured by Camfil Farr.

Ceiling diffuser

LCR1

Technical data (rotation - exhaust)

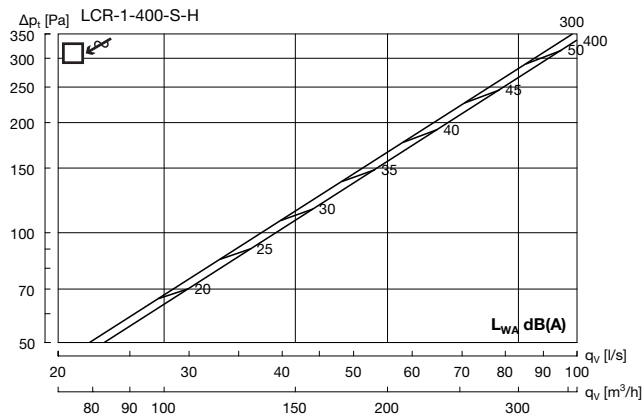

Size	63	125	250	500	1K	2K	4K	8K
400-300	-3	5	2	-1	-5	-14	-22	-25
400-400	4	4	3	-2	-6	-10	-19	-24

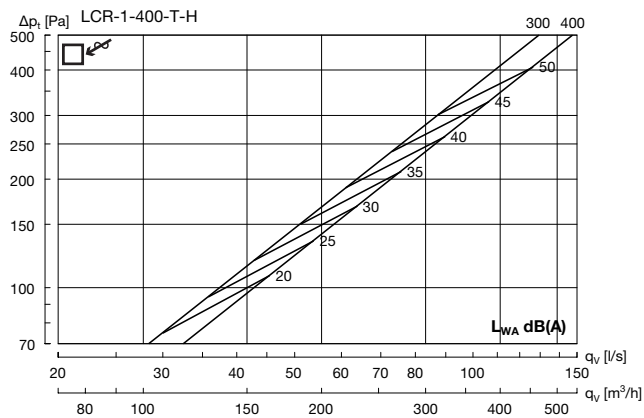

Size	63	125	250	500	1K	2K	4K	8K
400-300	9	3	2	-2	-5	-12	-20	-24
400-400	6	8	4	-2	-8	-16	-19	-22

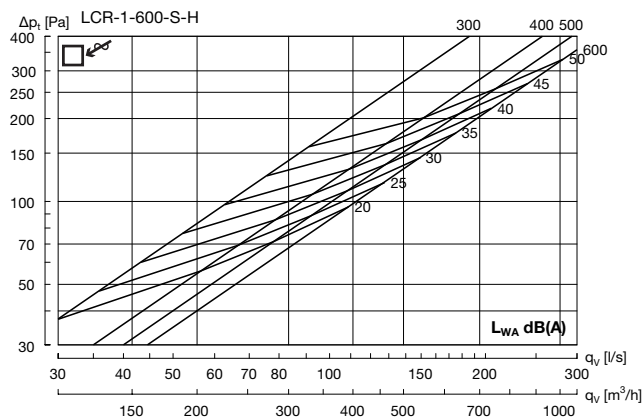

Size	63	125	250	500	1K	2K	4K	8K
600-300	1	3	-2	-2	-3	-12	-19	-25
600-400	3	7	1	-2	-5	-15	-20	-30
600-500	3	8	0	-1	-5	-15	-22	-32
600-600	4	5	1	-1	-5	-17	-28	-40

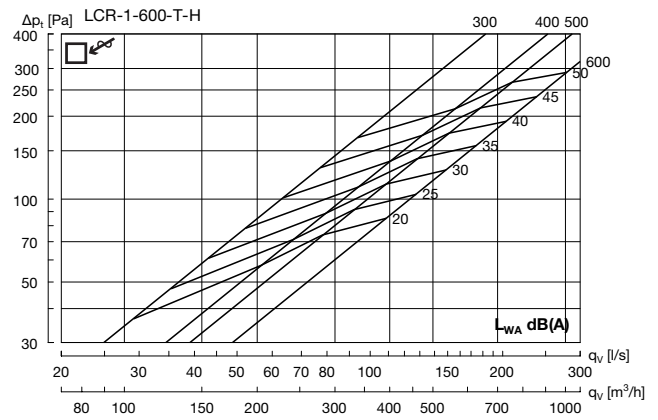

Size	63	125	250	500	1K	2K	4K	8K
600-300	7	7	1	-2	-6	-14	-22	-32
600-400	5	7	1	-2	-6	-10	-19	-28
600-500	3	5	-1	-4	-5	-7	-13	-25
600-600	2	-3	-4	-4	-4	-6	-16	-21

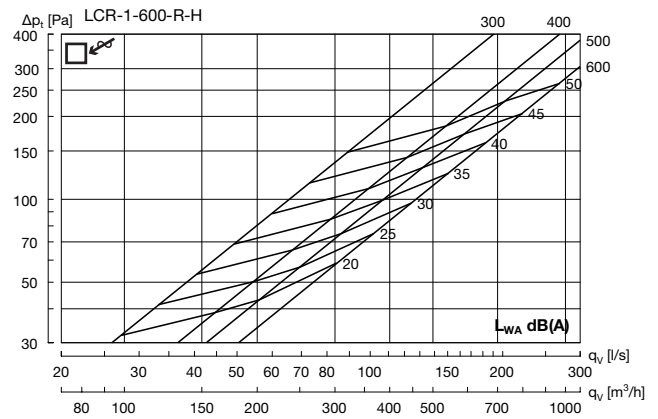

Size	63	125	250	500	1K	2K	4K	8K
600-300	0	3	-1	-2	-4	-11	-18	-26
600-400	6	5	0	-3	-4	-9	-18	-26
600-500	6	3	-3	-5	-5	-7	-12	-21
600-600	2	1	-3	-3	-5	-7	-13	-22

Code key

- S-H = Circular side connection
- T-H = Circular top connection
- R-H = Rectangular side connection

All measurements include the class H-14 filter manufactured by Camfil Farr.

Ceiling diffuser

LCR1

Technical data (perforated - supply)

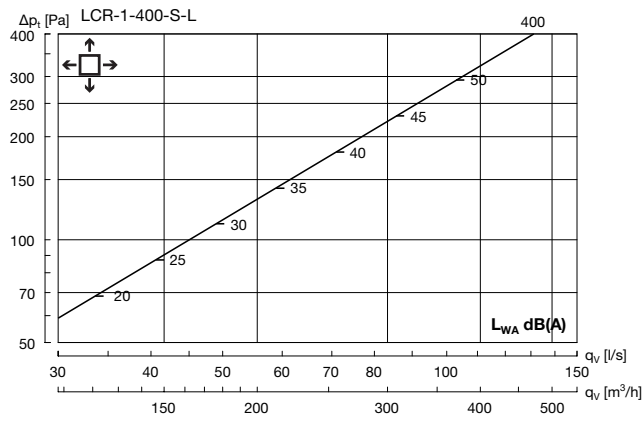

Size	63	125	250	500	1K	2K	4K	8K
400	5	-9	-10	-4	-2	-10	-22	-31

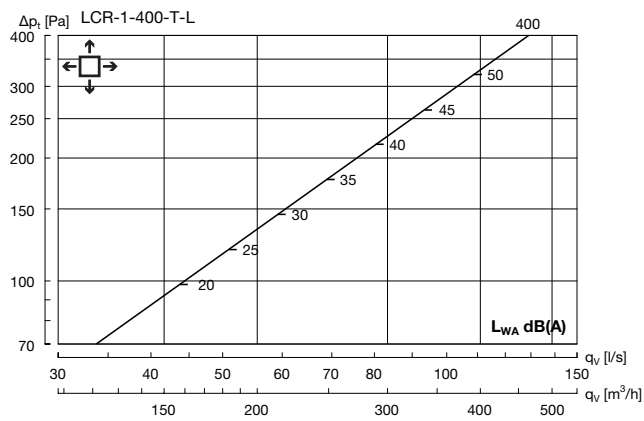

Size	63	125	250	500	1K	2K	4K	8K
400	10	10	3	-4	-11	-12	-13	-14

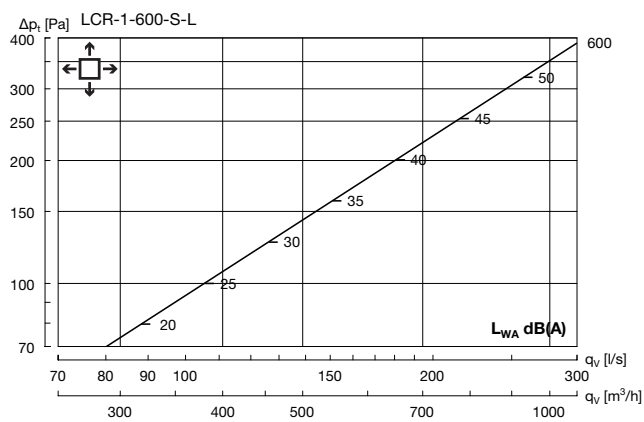

Size	63	125	250	500	1K	2K	4K	8K
600	9	-6	-8	0	-4	-12	-25	-35

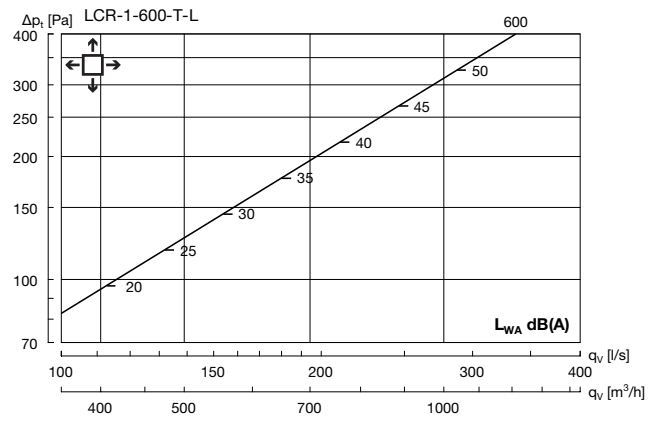

Size	63	125	250	500	1K	2K	4K	8K
600	5	-3	-7	-5	-2	-8	-22	-29

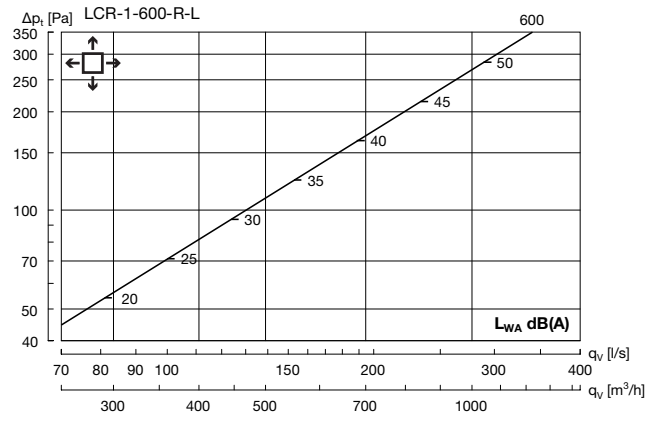

Size	63	125	250	500	1K	2K	4K	8K
600	7	-9	-6	-3	-5	-7	-12	-19

Code key

- S-L = Circular side connection
- T-L = Circular top connection
- R-L = Rectangular side connection

All measurements include the class H-14 filter manufactured by Camfil Farr.

Ceiling diffuser

LCR1

Technical data (perforated - exhaust)

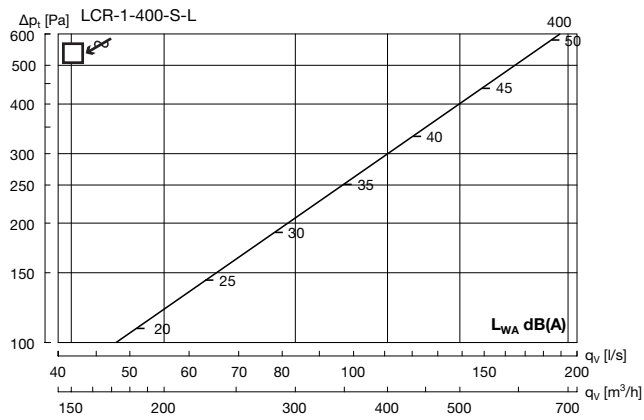

Size	63	125	250	500	1K	2K	4K	8K
400	8	8	2	-4	-7	-10	-15	-19

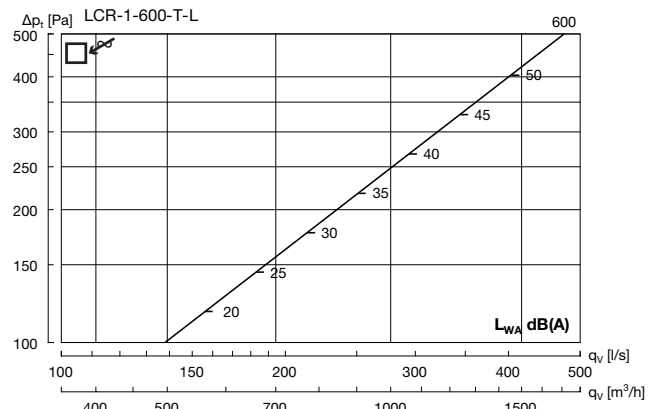

Size	63	125	250	500	1K	2K	4K	8K
600	13	11	4	-4	-11	-15	-19	-27

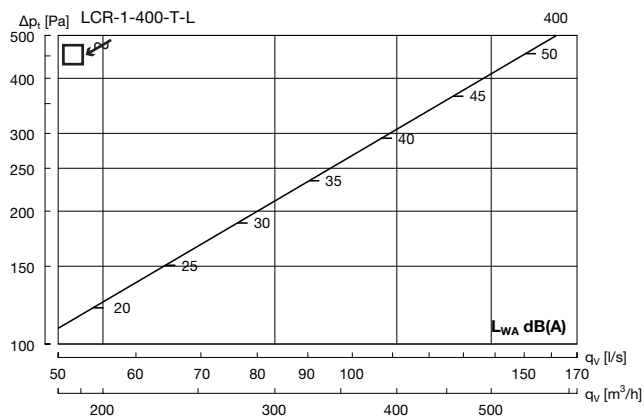

Size	63	125	250	500	1K	2K	4K	8K
400	10	10	3	-4	-11	-12	-13	-14

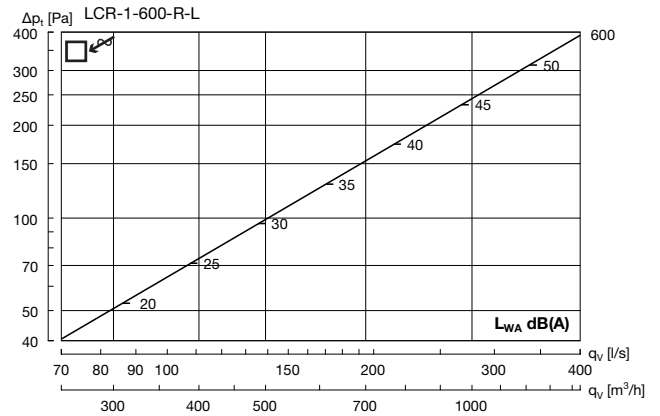

Size	63	125	250	500	1K	2K	4K	8K
600	2	-4	-6	-4	-5	-6	-10	-21

Code key

- S-L = Circular side connection
- T-L = Circular top connection
- R-L = Rectangular side connection

All measurements include the class H-14 filter manufactured by Camfil Farr.

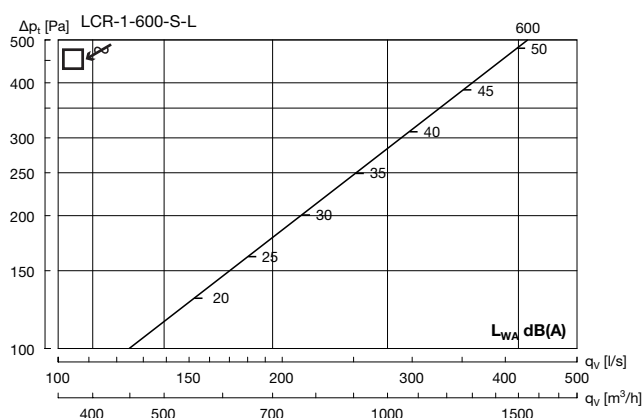

Size	63	125	250	500	1K	2K	4K	8K
600	13	9	0	-2	-7	-11	-16	-23



Perforated wall diffuser

LCR2

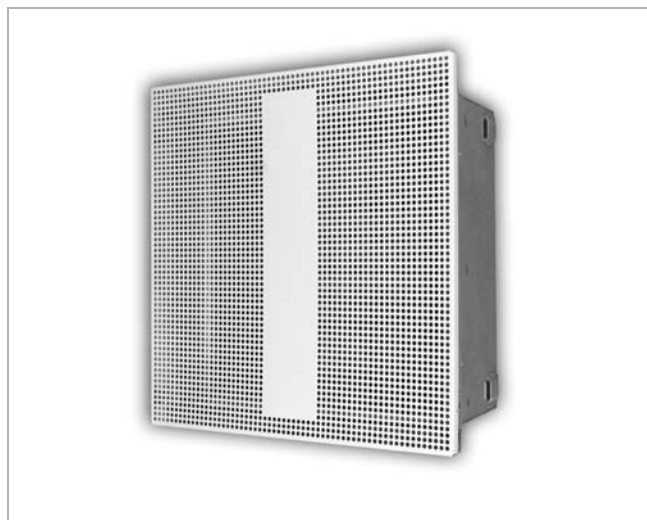

Description

LCR2 is a clean room diffuser that can be equipped with a HEPA filter, for installation in walls. It is typically used in premises where there are stringent requirements concerning the amount of particles and germs in the air. The diffuser can be used both to supply and exhaust air. It is supplied with a front-mounted, partially perforated and easy-to-detach front plate that ensures good air distribution and moderate flow rates throughout the premises. The diffuser excels when used with the very simple and easy filter installation function.

The pattern of airflow is illustrated on the following page. Filters are supplied by Camfil Farr with a PU seal.

- Airtight all-welded box in stainless steel
- Simple and easy filter installation
- Mounting brackets are supplied as accessories
- Hinged front plate on diffuser – easy to detach
- Low net weight
- The front plate can be supplied in stainless steel upon request.

Ordering example

Product LCR2
Type _____

Dimensions

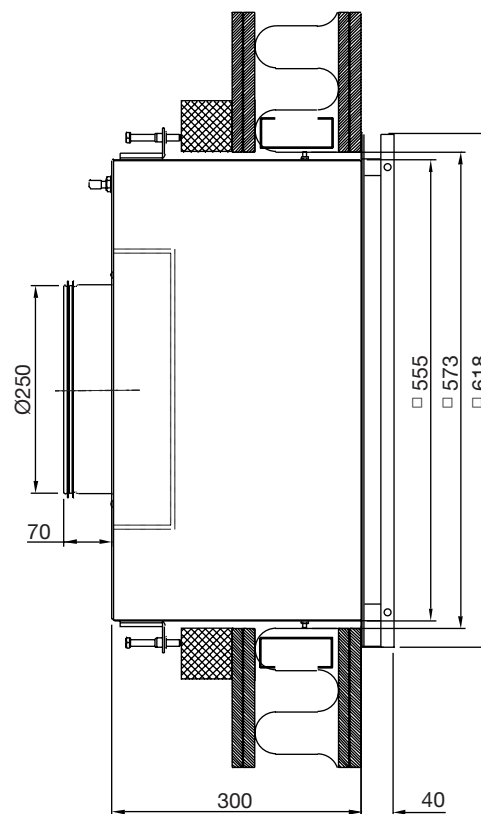

- Weight 16.9 kg.

- The diffuser can also be supplied with circular or rectangular side connections. However, this requires an increased box depth.

Materials and finish

Box:

Material: Stainless steel
 Standard finish: Powder-coated
 Standard colour: RAL 9010, gloss 30

Front plate:

Material: Galvanised steel
 Standard finish: Powder-coated
 Standard colour: RAL 9010, gloss 30

The diffuser is available in other colours. Please contact Lindab's sales department for further information.

Perforated wall diffuser

LCR2

Technical data

All measurements include the class H-14 filter manufactured by Camfil Farr.

Capacity

Volume flow q_v [l/s], [m³/h], total pressure drop Δp_t [Pa] and sound effect level L_{WA} [dB(A)] can be seen in the diagram below.

Frequency-related sound effect level

The sound effect level in the frequency band is defined as $L_{w_{ok}} = L_{WA} + K_{ok}$. The values for K_{ok} are specified in charts beneath the diagram below.

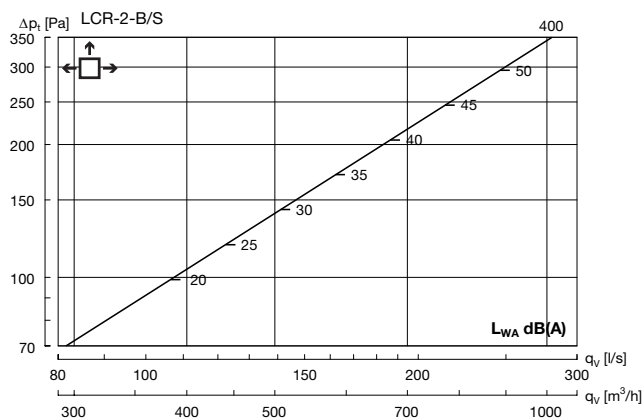

Hz	63	125	250	500	1K	2K	4K	8K
K_{ok}	4	-3	-5	0	-5	-9	-23	-32

Sound attenuation

The diffuser's sound attenuation function from duct to room, including end reflection.

	Mean frequency Hz							
Hz	63	125	250	500	1K	2K	4K	8K
	17	11	3	5	5	4	5	13

Dispersal diagram – viewed from the front

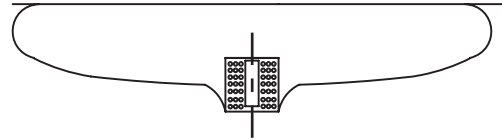

Dispersal diagram – viewed from above

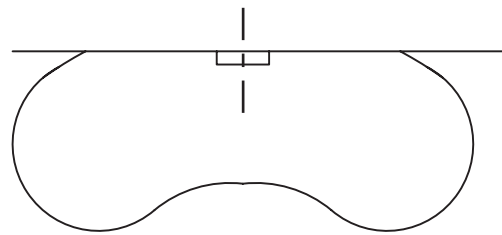

Dispersal diagram – viewed from the side

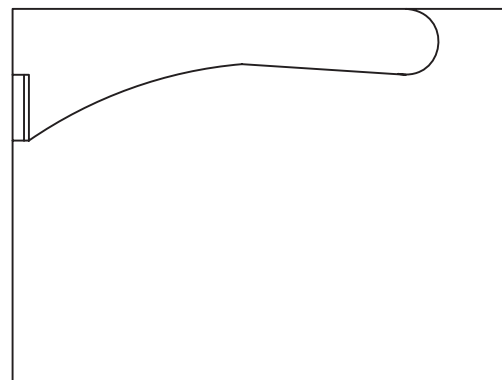

Parts

Filter clip



- 1
- 2
- 3
- 4
- 5
- 6
- 7
- 8
- 9
- 10
- 11
- 12
- 13
- 14
- 15
- 16
- 17
- 18

Perforated ceiling diffuser

LCR3



Description

LCR3 is a ceiling-mounted air exhaust diffuser, which can be used to advantage in clean rooms where you don't want to equip exhaust diffusers with HEPA filters. In addition, the diffuser can be used to supply air in connection with a central duct-mounted HEPA filter. LCR3 ensures a sealed ceiling and diffuser solution for the pressure regulation of rooms.

If you want to use the diffuser alongside plenum box MBB, then the box should be supplied without sound-attenuating insulation, so that the risk of particles being transferred from the MBB box's soundproofing to rooms is eliminated.

LCR3 is available in two sizes and with different duct connections. The diffuser can also be adapted for the most popular ceiling systems with reference to the order code. Visually, the diffuser looks like type LCR1. The diffuser is equipped with a fully perforated front plate, which is attached by wire springs, ensuring easy installation and removal of the base plate for cleaning purposes.

- Can be supplied adapted for ceilings with reference to the order code
- Visually identical to LCR1
- Airtight box with sealed design
- Mounting brackets supplied as standard
- Can be attached using a wire mounting (pendants) for standard ceiling systems
- The front plate can be opened downwards without having to demount it.

Materials and finish

Material: Galvanised steel
 Standard finish: Powder-coated
 Standard colour: RAL 9010, gloss 30

The diffuser is available in other colours. Please contact Lindab's sales department for further information.

Dimensions

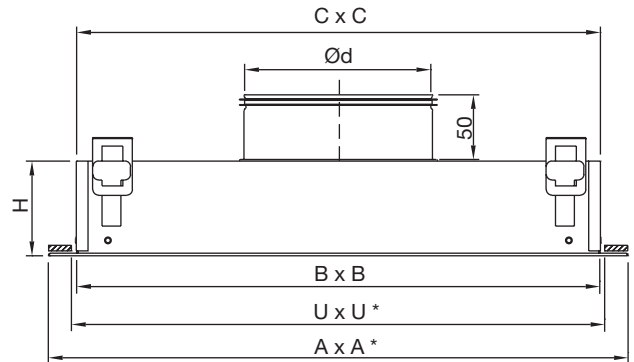

*) Dimensioning applies for fixed ceiling diffusers. Dimensions for other ceiling types (size 600) are given in the ceiling adjustment section. (see chapter "Ceiling tile adaption").

U x U = Min. cutting dimension

Size mm	Ød mm	H mm	A mm	B mm	C mm	U mm	m kg
400	125-200	100	415	360	325	365	2.4
600	160-400	100	615	560	525	565	4.8

Order (size 400)

Product	LCR3	400	F	aaa
Type				
Size				
Fixed ceiling				
Connection Ød (125, 160, 200)				

Order (size 600)

Product	LCR3	600	a	bbb
Type				
Size				
ceiling				
F = Fixed ceiling				
T = Visible T-rail				
C = Clip-In (bevelled)				
A = Other ceiling type*				
Connection Ød (160, 200, 250, 315, 400)				

Perforated ceiling diffuser

LCR3

Technical data

Capacity

Volume flow q_v [l/s], [m³/h], total pressure drop Δp_t [Pa] and sound effect level L_{WA} [dB(A)] can be seen in the diagram below.

Frequency-related sound effect level

The sound effect level in the frequency band is defined as $L_{w_{ok}} = L_{WA} + K_{ok}$. The values for K_{ok} are specified in charts beneath the diagrams below.

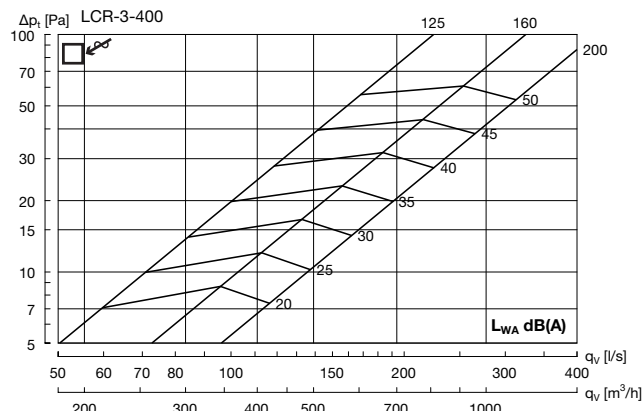

Size	63	125	250	500	1K	2K	4K	8K
125	8	6	3	-2	-9	-10	-19	-25
160	8	9	2	-3	-7	-11	-20	-28
200	7	5	-2	-3	-3	-14	-25	-40

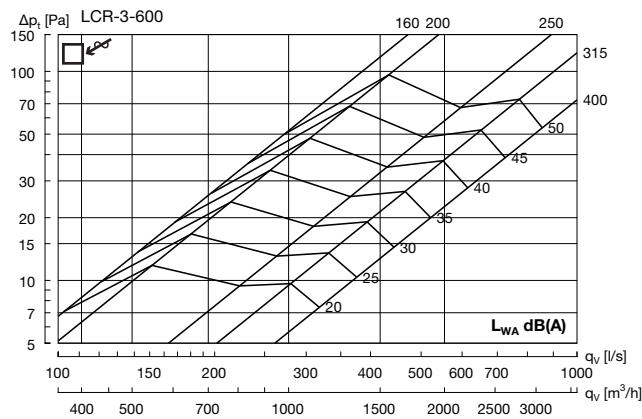

Size	63	125	250	500	1K	2K	4K	8K
160	2	9	3	-3	-7	-12	-20	-27
200	2	10	1	-2	-7	-12	-17	-22
250	1	11	1	-2	-7	-14	-21	-28
315	9	4	-2	-1	-4	-17	-24	-33
400	1	3	-5	-1	-3	-14	-23	-34

Sound attenuation

The diffuser's sound attenuation function from duct to room, including end reflection.

Size	Mean frequency Hz							
	63	125	250	500	1K	2K	4K	8K
400-125	20	14	9	10	5	1	1	3
400-160	16	13	7	0	5	1	1	3
400-200	16	10	4	1	4	0	0	2
600-160	18	12	7	2	1	0	0	1
600-200	15	10	4	2	0	0	1	2
600-250	15	9	3	3	0	0	1	1
600-315	12	7	2	1	0	1	1	2
600-400	9	6	1	3	0	0	0	1

Ceiling adjustment

LCR3 in size 600 is suitable for installation in several different types of ceiling system. Read more about this in the ceiling adjustment section.

- 1
- 2
- 3
- 4
- 5
- 6
- 7
- 8
- 9
- 10
- 11
- 12
- 13
- 14
- 15
- 16
- 17
- 18

Rotating ceiling diffuser

LCR4



Description

LCR4 is a ceiling-mounted air exhaust diffuser, which can be used to advantage in clean rooms where you don't want to equip exhaust diffusers with HEPA filters. In addition, the diffuser can be used to supply air in connection with centrally-located HEPA filters. LCR4 ensures a sealed ceiling and diffuser solution for the pressure regulation of rooms.

If you want to use the diffuser alongside plenum box MBB, then the box should be supplied without sound-attenuating insulation, so that the risk of particles being transferred from the MBB box's soundproofing to rooms is eliminated.

LCR4 is available in two sizes and with different duct connections. The diffuser can also be adapted for the most popular ceiling systems with reference to the order code. Visually, the diffuser looks like type LCR1. The diffuser is equipped with a rotating front plate, which is attached by wire springs, ensuring easy installation and removal of the base plate for cleaning purposes.

- Can be supplied adapted for ceilings with reference to the order code
- Visually identical to LCR1
- Airtight box with sealed design
- Mounting brackets supplied as standard
- Can be attached using a wire mounting (pendants) for standard ceiling systems
- The front plate can be opened downwards without having to demount it.

Materials and finish

Material: Galvanised steel
 Standard finish: Powder-coated
 Standard colour: RAL 9010, gloss 30

The diffuser is available in other colours. Please contact Lindab's sales department for further information.

Dimensions

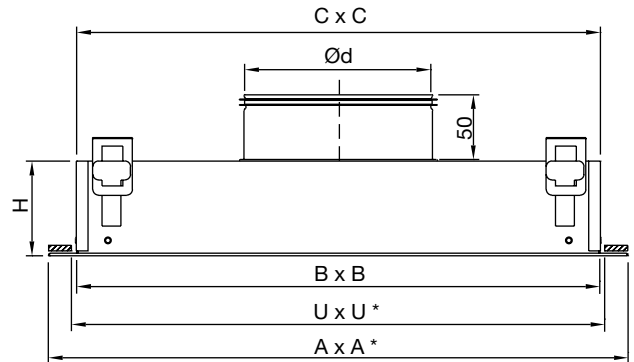

*) Dimensioning applies for fixed ceiling diffusers. Dimensions for other ceiling types (size 600) are given in the ceiling adjustment section. (see chapter "Ceiling tile adaption").

U x U = Min. cutting dimension

Size mm	H mm	A mm	B mm	C mm	U mm	m kg
400	100	415	360	325	365	3.1
600	100	615	560	525	565	6.0

Duct connection

Air pattern mm	Ød mm
400-300	160
400-400	200
600-400	200
600-500	250
600-600	315

Order (size 400)

Product	LCR4	400	F	aaa
Type				
Size				
Fixed ceiling				
Air pattern (300, 400)				

Order (size 600)

Product	LCR4	600	a	bbb
Type				
Size				
ceiling				
F = Fixed ceiling				
T = Visible T-rail				
C = Clip-In (bevelled)				
A = Other ceiling type*				
Air pattern (400, 500, 600)				

Rotating ceiling diffuser

LCR4

Technical data

Capacity

Volume flow q_v [l/s], [m³/h], total pressure drop Δp_t [Pa] and sound effect level L_{WA} [dB(A)] can be seen in the diagram below.

Frequency-related sound effect level

The sound effect level in the frequency band is defined as $L_{w_{ok}} = L_{WA} + K_{ok}$. The values for K_{ok} are specified in charts beneath the diagrams below.

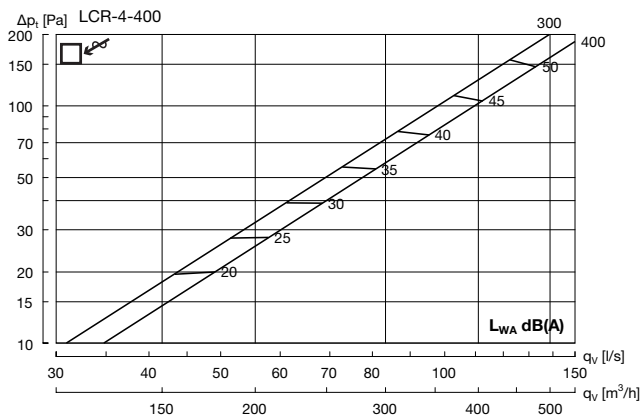

Size	63	125	250	500	1K	2K	4K	8K
300	4	3	-1	-2	-5	-9	-20	-28
400	6	0	0	-2	-5	-8	-20	-31

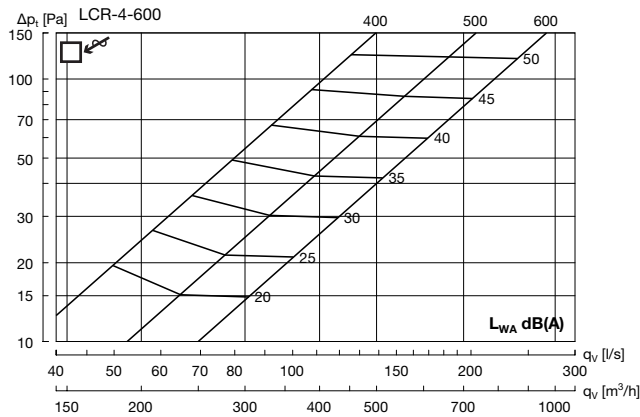

Size	63	125	250	500	1K	2K	4K	8K
400	6	0	3	-3	-5	-11	-19	-30
500	5	1	3	-2	-6	-11	-22	-32
600	3	1	-1	-1	-5	-10	-20	-35

Sound attenuation

The diffuser's sound attenuation function from duct to room, including end reflection.

Size	Mean frequency Hz							
	63	125	250	500	1K	2K	4K	8K
400-300	19	12	7	1	6	2	4	5
400-400	16	9	4	4	6	2	3	5
600-400	15	10	3	3	2	1	4	6
600-500	14	9	2	6	1	2	4	5
600-600	13	9	2	4	2	3	4	7

Ceiling adjustment

LCR4 in size 600 is suitable for installation in several different types of ceiling system. Read more about this in the ceiling adjustment section.

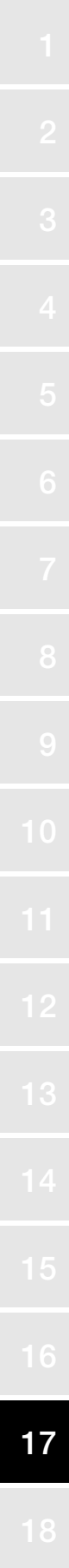

Ceiling adjustment

LCR

Diffusers LCR1, LCR3 and LCR4 in size 600 are suitable for installation in different types of ceiling. The various options for adjusting the diffuser range for ceilings are shown below. To achieve maximum tightness between the diffuser and ceiling/wall, it is recommended that a seal be used around the diffuser.

To ensure that the LCR diffuser can be easily fed into the ceiling recess/rail system, the diffuser with circular side connection is equipped with a detachable connection.

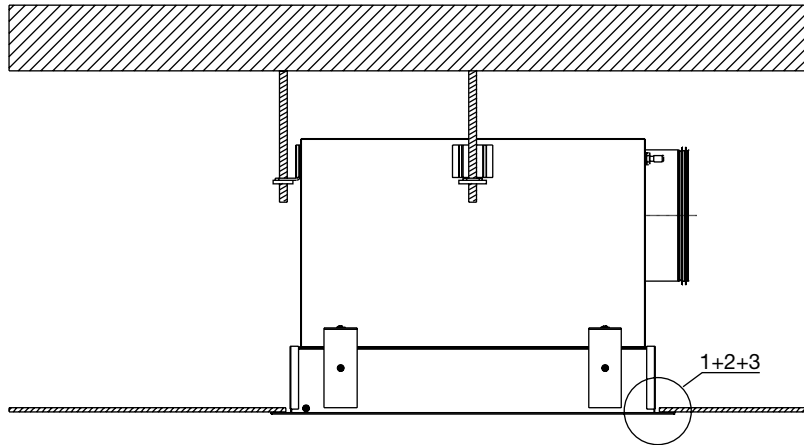

1. Fixed ceiling

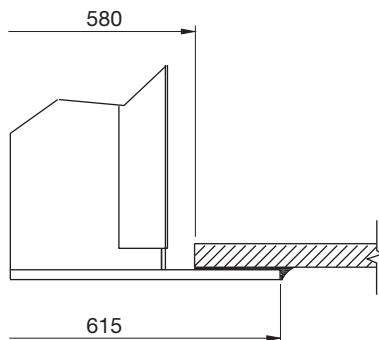

2. 15/24 mm visible T-rail

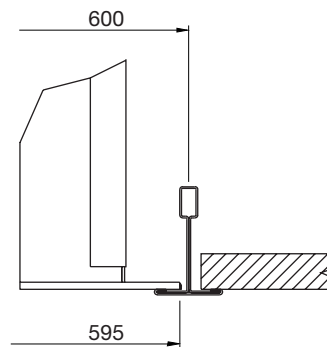

3. Clip-In ceiling

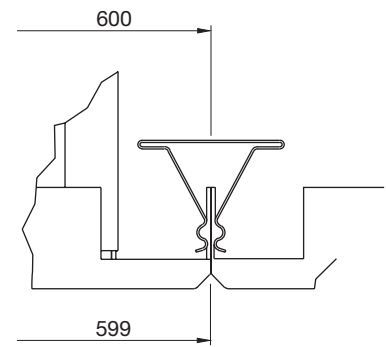

Other ceiling types (walkable ceiling)

A diffuser solution can be supplied for installation in walkable ceilings with filter replacement from above, although this is not a standard solution. For installation and removal of a filter, it is possible to use filter installation tool LCRZ4.

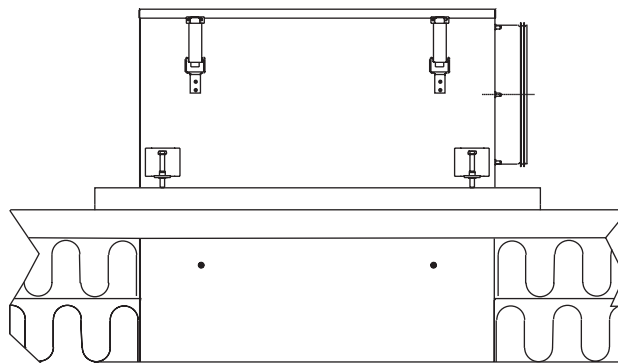

Accessories

LCRZ

Mounting brackets

LCR1 and LCR2 can be secured during construction using a 6 or 8 mm threaded bolt and suspension brackets LCRZ1 or LCRZ2, which are available as accessories.

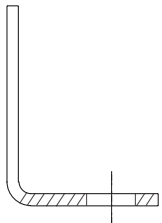

LCRZ-1
Mounting bracket with Ø 10 mm smooth hole (in stainless steel).

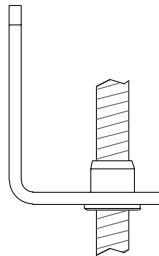

LCRZ-2
Mounting bracket with 8 mm thread (in stainless steel).

Mounting

LCR3 and LCR4 can be installed to advantage using the traditional wire mountings that are used when installing ceiling rails. Wire mountings can be supplied on order stating the desired length.

Filter installation tool

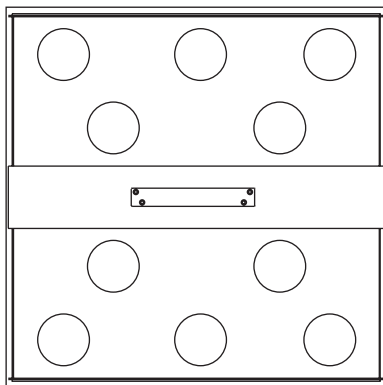

LCRZ-3
- filter installation from below (shown above).

LCRZ-4
- filter installation from above.

LCRZ-5
- fixture for correct installation of filters with a gel seal in the diffuser.
For LCRZ-3-5, state diffuser dimension.

Ordering example

Product	LCRZ	a
Type		
Accessories (1-7)		

Pressure connection for ceiling and wall

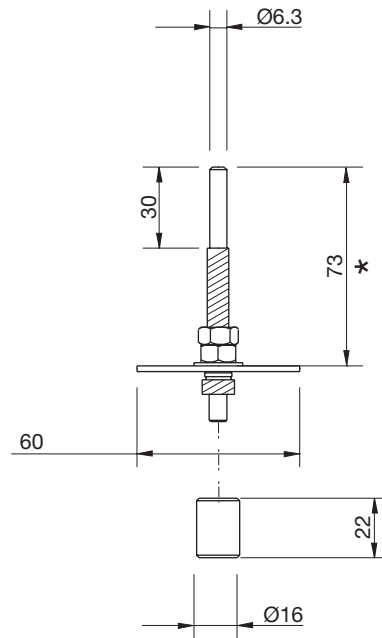

LCRZ-6
Pressure connection for ceiling mounting which is used for registration of pressure before filter in the diffuser. It is connected via a plastic hose to an outlet in the diffuser box. Pressure loss above the filter can then be found in the ventilated room.
LCRZ-6 comes standard painted RAL 9010.

- Upon request, LCRZ-6 can be delivered in other lengths, (for example adapted to cleanroom elements), and can also be delivered as a double measuring connection with 2 outlets

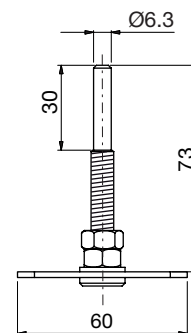

LCRZ-7
Pressure connection for wall or ceiling mounting which is used in connection with room-pressure regulation. It is connected via a plastic hose to a room-pressure regulator and the common reference (Pressure neutral). LCRZ-7 comes standard painted RAL 9010

- Upon request, LCRZ-7 comes with thread in full length

1
2
3
4
5
6
7
8
9
10
11
12
13
14
15
16
17
18

Filter

LCRF

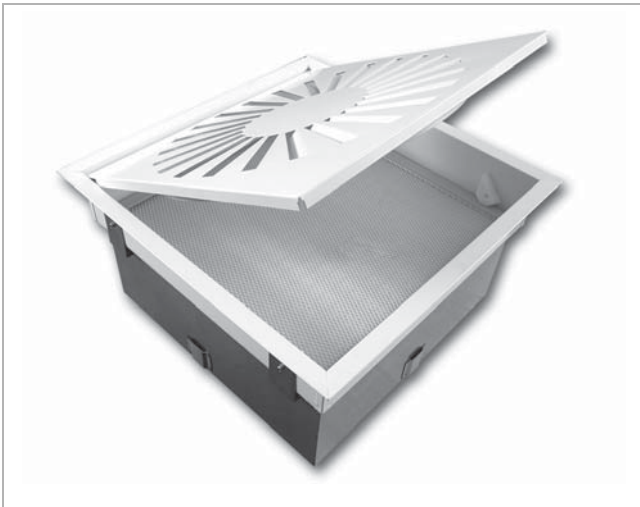

Description

HEPA filters in class H14 have a large area of filter material and are of a very high quality that ensures a long service life, low pressure drops and excellent filtration. Choose between gel or PU seals without joints. The seal around the filter is replaced when the filter is changed to guarantee hassle-free operation and installation. Other filter classes are available on request. The filter is equipped as standard with powder-coated protective mesh on both sides of the filter material.

- Easy filter replacement without the need for tools
- Filter cell with PU or gel seal
- Individual Scantest certificate supplied with the filter

Filter – brief facts: The filter is intended for installation in clean rooms.

Frame: Aluminium extrusion 86 mm

Filter material: Fibreglass

Separators: Hot-melt adhesive

Sealant: Polyurethane

Diffuser seal: PU (Polyurethane without joints) or gel

Temperature/humidity, max.: 70°C/RH 100%

Filter class as per DS/EN 1822: H14 (99.995% at MPPS)

Recommended max. end pressure drop: 450 Pa.

Volume flow/pressure drop:

Size 400 : 153 m³/h / 112 Pa (0.45 m/s)

Size 600 : 418 m³/h / 112 Pa (0.45 m/s)

Recommended max. volume flow/pressure drop:

Size 400 : 200 m³/h / 140 Pa

Size 600 : 550 m³/h / 140 Pa

Manufacturer: Camfil Farr

Seal type

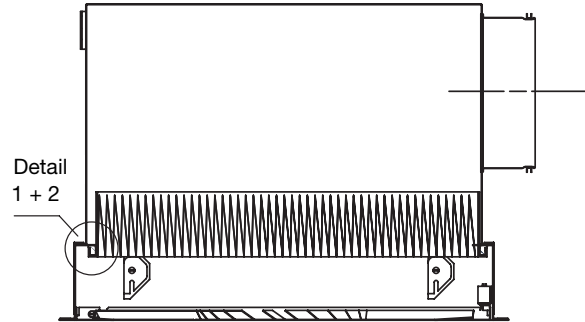

Part 1: PU seal

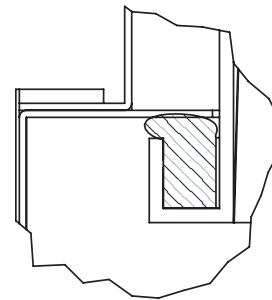

Part 2: GEL seal

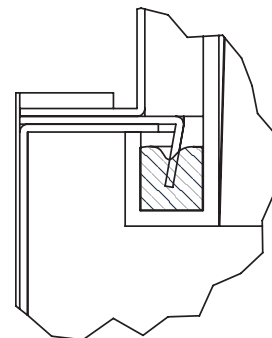

Ordering example

Product	LCRF	aaa	b	H14
Type				
Size				
400				
600				
Sealing				
P = PU seal				
G = Gel seal				
Filter class				