

**installation
operation
and
service
instructions**

HP19 Series Units

HEAT PUMP UNITS
1-1/2 through 5 ton
502,698M
2/92
Supersedes 502,214M

**RETAIN THESE INSTRUCTIONS
FOR FUTURE REFERENCE**

TABLE OF CONTENTS

Unit Dimensions.....	Page 1
Start-Up and Performance Check List.....	Page 1
Installation.....	Page 2
Electrical.....	Page 3
Plumbing.....	Page 5
Refrigeration.....	Page 5
Operation.....	Page 9
Maintenance.....	Page 10

UNIT DIMENSIONS

MODEL NO.	A	B	C	D	E
HP19-211 HP19-261	28" (711mm)	25-7/8" (657mm)	29-7/8" (759mm)	10" (254mm)	14-7/8" (378mm)
HP19-311 HP19-411/413	31" (787mm)	32-1/8" (816mm)	34-1/16" (865mm)	12-1/4" (311mm)	17" (432mm)
HP19-461/461	35" (889mm)	32-1/8" (816mm)	34-1/16" (865mm)	13-1/4" (337mm)	18" (457mm)
HP19-511/513	41" (1041mm)	32-1/8" (816mm)	34-1/16" (865mm)	13-1/4" (337mm)	18-1/16" (459mm)
HP19-651/653	45" (1143mm)	32-1/8" (816mm)	34-1/16" (865mm)	13-1/4" (337mm)	21-1/16" (535mm)

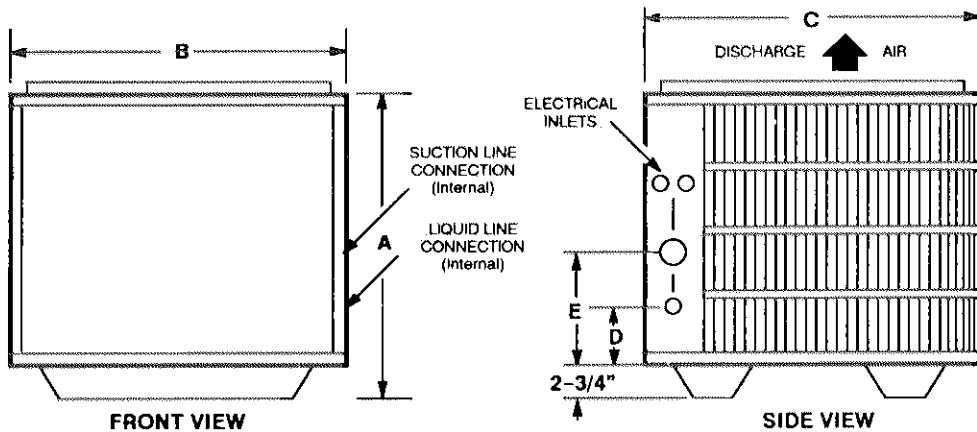
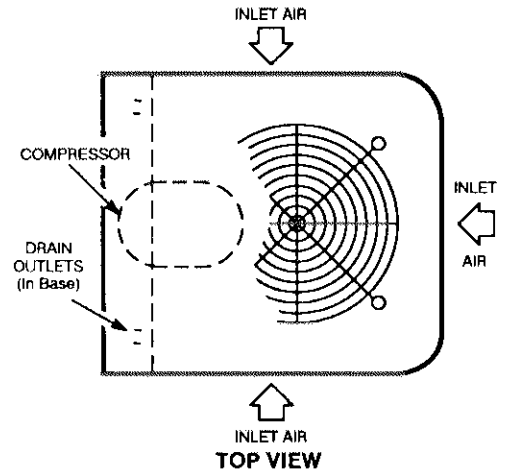

START-UP AND PERFORMANCE CHECK LIST

Job Name _____	Job No. _____	Date _____
Job Location _____	City _____	State _____
Installer _____	City _____	State _____
Unit Model No. _____	Serial No. _____	Serviceman _____
Nameplate Voltage _____	Amps: _____	
Minimum Circuit Ampacity _____	Supply _____	Outdoor Fan _____
Maximum Fuse Size _____	Compressor _____	
Electrical Connections Tight? <input type="checkbox"/>	Indoor Filter Clean? <input type="checkbox"/>	Indoor Blower RPM _____
Supply Voltage (Unit Off) _____	S.P. Drop Over Evaporator (Dry) _____	
	Outdoor Coil Entering Air Temperature _____	
Refrigerant Lines:	Discharge Pressure _____	Suction Pressure _____
Leak Checked? <input type="checkbox"/>	Refrigerant Charge Checked? <input type="checkbox"/>	
Service Valves Tightened? <input type="checkbox"/>	THERMOSTAT	
Properly Insulated? <input type="checkbox"/>	Calibrated? <input type="checkbox"/>	Properly Set? <input type="checkbox"/>
Outdoor Fan Checked? <input type="checkbox"/>		Level? <input type="checkbox"/>
Voltage With Compressor Operating _____		

I-SHIPPING AND PACKING LIST

Package 1 of 1 contains:

1-Assembled heat pump unit

Check unit for shipping damage. Consult last carrier immediately if damage is found.

These instructions are intended as a general guide and do not supersede local codes in any way. Authorities having jurisdiction should be consulted before installation.

⚠ WARNING

Product contains fiberglass wool.

Disturbing the insulation in this product during installation, maintenance, or repair will expose you to fiberglass wool. Breathing this may cause lung cancer. (Fiberglass wool is known to the State of California to cause cancer.)

Fiberglass wool may also cause respiratory, skin, and eye irritation.

To reduce exposure to this substance or for further information, consult material safety data sheets available from address shown below, or contact your supervisor.

Lennox Industries Inc.
P.O. Box 799900
Dallas, TX 75379-9900

II-INSTALLATION

HP19 heat pump units are approved and warranted only for installation with specially matched indoor coils, L10 line sets, and refrigerant control devices as designated by Lennox. Refer to the Lennox Engineering Handbook for approved systems.

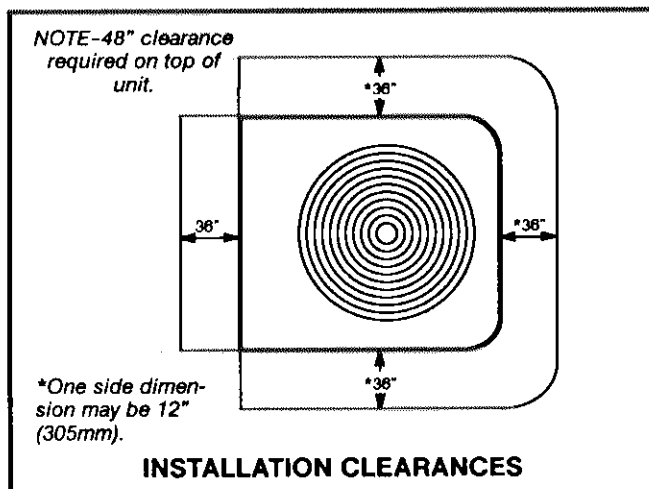

FIGURE 1

A-Setting the Unit

Heat pump units operate under a wide range of weather conditions; therefore, several factors must be considered when positioning the outdoor unit.

- 1- Place a sound-absorbing material, such as Iso-mode, under the unit if it will be installed in a location or position that will transmit sound or vibration to the living area or adjacent buildings.
- 2- Mount unit high enough above ground or roof to allow adequate drainage of defrost water and prevent ice build-up.
- 3- In heavy snow areas, do not locate unit where drifting will occur. The unit base should be elevated above the depth of average snows.

NOTE-Elevation of the unit may be accomplished by constructing a frame using suitable materials. If a support frame is constructed, it must not block drain holes in unit base.

- 4- When installed in areas where low ambient temperatures exist, locate unit so winter prevailing winds do not blow directly into outdoor coil.
- 5- Locate unit away from overhanging roof lines which would allow water or ice to drop on, or in front of, coil or into unit.

B-Slab Mounting (See figure 2)

When installing unit at grade level, top of slab should be high enough above the grade so that water from higher ground will not collect around unit. Slab should have a slope tolerance away from the building of 2 degrees or 2 inches per 5 feet (51mm per 1524mm). This will prevent ice build-up under unit during a defrost cycle. Refer to roof mounting section for barrier construction if unit must face prevailing winter winds.

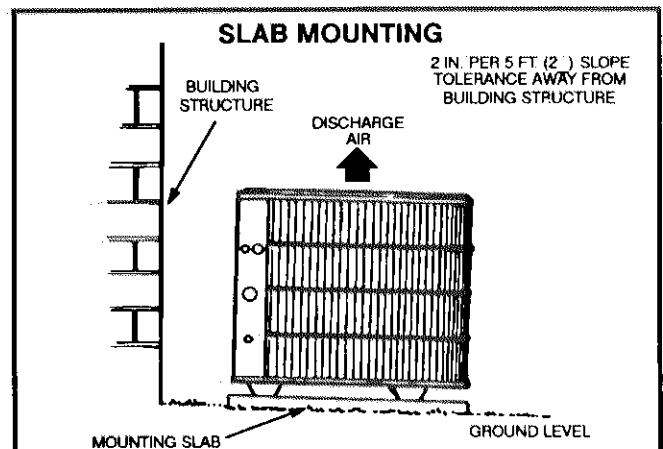

FIGURE 2

C-Roof Mounting (See figure 3)

If unit coil cannot be mounted away from prevailing winter winds, a wind barrier should be constructed. Size barrier at least the same height and width as outdoor unit. Mount barrier 24 inches (610mm) from the sides of the unit in the direction of prevailing winds.

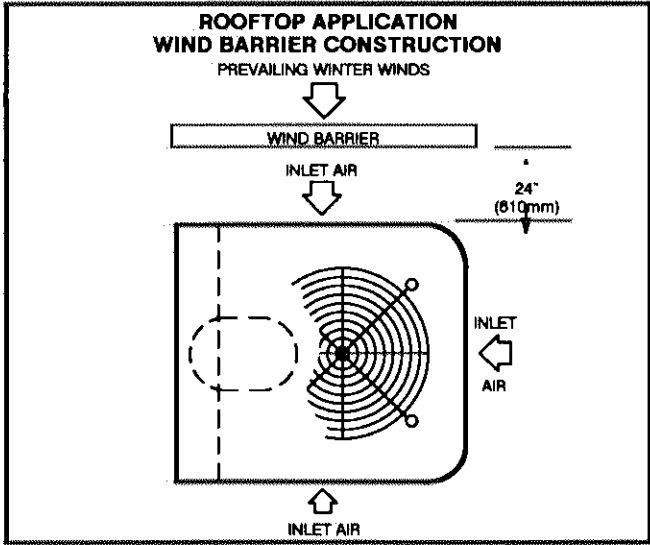

FIGURE 3

III-ELECTRICAL

Wiring must conform to the National Electric Code (NEC) and local codes. Application diagram is included in this instruction (See figure 5) and in indoor unit instructions. Refer to unit rating plate for minimum circuit ampacity and maximum fuse size.

- 1- Provide line voltage power supply to unit from a properly sized disconnect switch.
- 2- Install room thermostat (ordered separately) in the conditioned area. Locate where it will not be affected by sunlight, drafts or vibration. See figure 4 for new Lennox thermostat nomenclature versus old style nomenclature. Do not install on an outside wall. A position approximately 5 feet (1524mm) from the floor and near the center of the conditioned area is most desirable.
- 3- Provide low voltage wiring from outdoor to indoor unit and from thermostat to indoor unit as indicated on the field wiring diagram in this instruction (See figure 5).
- 4- Ground unit either through supply wiring or with an earth ground.
- 5- Mount compressor warning sticker on unit disconnect switch.

OLD THERMOSTAT NOMENCLATURE		NEW THERMOSTAT NOMENCLATURE
(M)	1ST STAGE COOL/HEAT - YELLOW	(Y1)
(M2)	2ND STAGE COOL - BLUE	(Y2)
(3)	COMMON - BLACK	(C)
(R)	REVERSING VALVE - ORANGE	(O)
(V)	POWER - RED	(R)
(Y)	AUX. HEAT - WHITE	(W1)
(F)	INDOOR BLOWER - GREEN	(G)

USE THIS DIAGRAM WHEN TRYING TO MATCH NEW STYLE THERMOSTAT NOMENCLATURE TO OLD STYLE THERMOSTAT NOMENCLATURE

FIGURE 4

FIELD WIRING DIAGRAM HP19 WITH CB19

- △ 1 THERMOSTAT HEAT ANTICIPATION SETTING .4 AMP ELECTRIC HEAT.
- △ 2 WHEN TWO-STAGE THERMOSTAT IS USED, CONNECT SECOND-STAGE HEAT BULB TO TERMINAL "W2" AND REMOVE JUMPER BETWEEN TERMINALS "R" AND "W2."
- △ 3 IF OUTDOOR THERMOSTAT IS USED, REMOVE JUMPER BETWEEN TERMINALS "R" AND "W2."
- △ 4 JUMPER BETWEEN "R" AND "W3" IS SUPPLIED WHEN ECB19-25P & 30P ARE USED. REMOVE THIS JUMPER WHEN EMERGENCY HEAT RELAY IS USED.
- △ 5 EMERGENCY HEAT RELAY (USED ONLY IF OUTDOOR T-STAT IS USED) FIELD PROVIDED AND INSTALLED NEAR INDOOR UNIT 24VAC 5VA MAX NEC CLASS 2.

----- LOW VOLTAGE
FIELD INSTALLED

----- LOW VOLTAGE
FACTORY INSTALLED

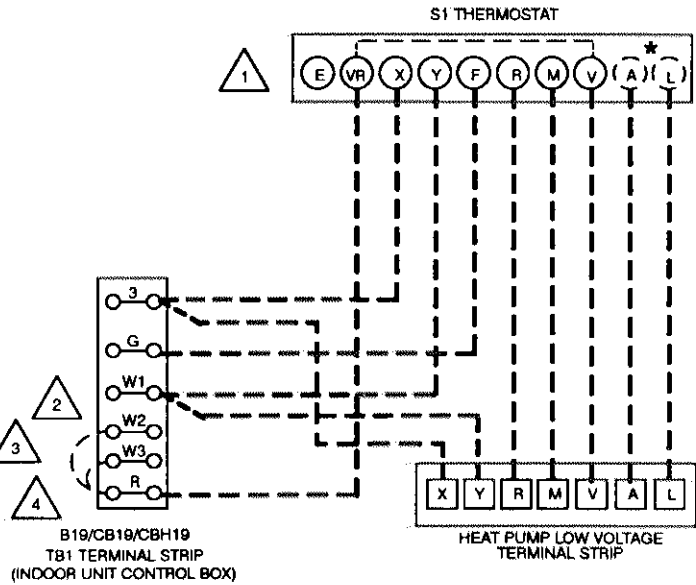

NOTE-ALL REMAINING WIRES FACTORY INSTALLED

*A & L TERMINALS NOT ON ALL THERMOSTATS

ADDITIONAL WIRING IF EMERGENCY HEAT RELAY AND OUTDOOR THERMOSTAT ARE USED

**ECB19-2.5P, 5P, 6P, 7P AND 8P
ECB19-7G, 10G, AND 15G
ECB19-5Y, 7.5Y, 10Y AND 15Y
APPLICATIONS**

**ECB19-10P, 12.5P, 15P AND 20P
ECB19-20Y AND 25Y
ECB19-20G AND 25G
APPLICATIONS**

**ECB19-25P AND 30P
APPLICATIONS**

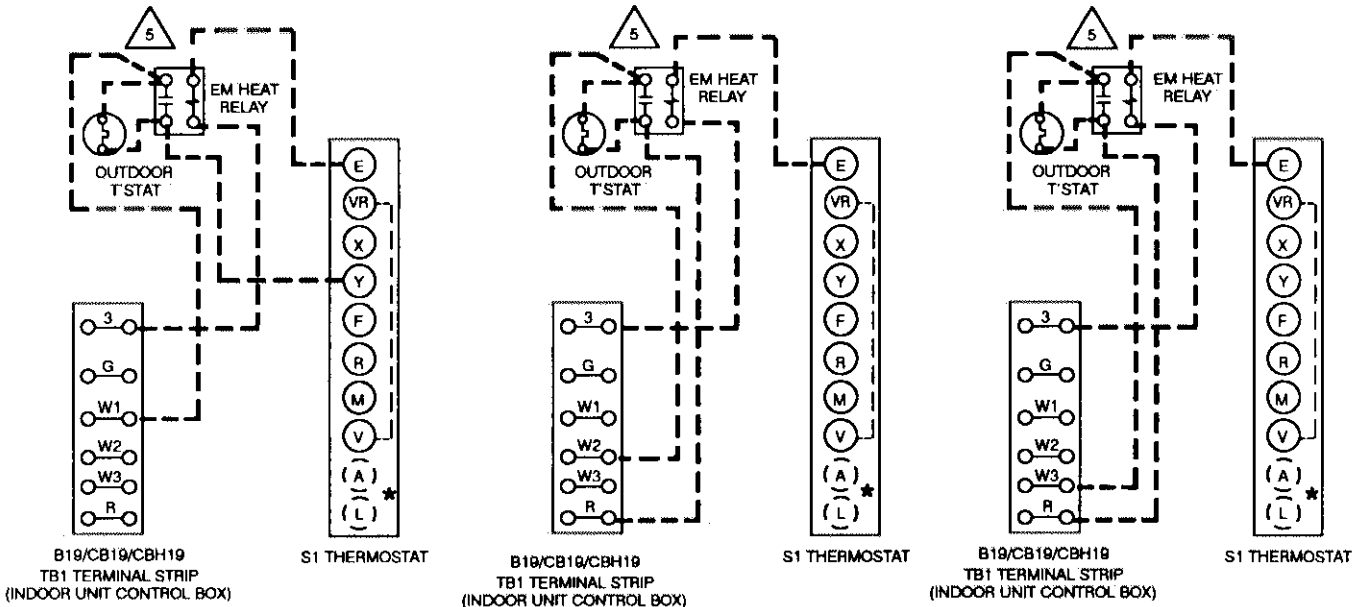

FIGURE 5

IV-PLUMBING

Field refrigerant piping consists of liquid and vapor lines from the outdoor unit (sweat connections). Use Lennox L10 series line sets as shown in table 1 or field fabricated refrigerant lines. Refer to the piping section of the Lennox Unit Information Service Manual for proper size, type and application of field-fabricated lines. The model number "410" refers to both 411 (single-phase) and 413 (three-phase) units. The same applies for 460 (461/463), 510 (511/513), and 650 (651/653) units.

TABLE 1

MODEL NO.	LIQUID LINE	VAPOR LINE	L10 LINE SETS
HP19-211 HP19-261	3/8 in. (10mm)	5/8 in. (16mm)	L10-26 20 ft. - 50 ft. (3m - 15.2m)
HP19-311 HP19-410	3/8 in. (10mm)	3/4 in. (19mm)	L10-41 20 ft. - 50 ft. (6.1m - 15.2m)
HP19-460 HP19-510	3/8 in. (10mm)	7/8 in. (22mm)	L10-65 30 ft. - 50 ft. (9.1m - 15.2 m)
HP19-650	3/8 in. (10mm)	1-1/8 in. (29mm)	FIELD FABRICATED

NOTE-To obtain maximum efficiency, remove the 3/4" reduction from the L10-65 series line sets and the flare fitting from the indoor coil. Then, make a sweat connection using a 7/8" X 1-1/8" reducer bushing.

V-REFRIGERATION

A-Processing Procedure

The unit is factory-charged with the amount of R-22 refrigerant indicated on the unit rating plate. This charge is based on a matching indoor coil and outdoor coil with a 25 foot (7620mm) line set. For varying lengths of line set, refer to table 2 for refrigerant charge adjustment. A blank space is provided on the unit rating plate to list actual field charge.

TABLE 2

LINE SET DIAMETER		Ozs per ft. (ml per mm) adjust from 25 ft. (7620mm) line set*
Vapor	Liquid	
5/8 in. (16mm)	3/8 in. (10mm)	1 ounce (30ml)
3/4 in. (19mm)	3/8 in. (10mm)	1 ounce (30ml)
7/8 in. (22mm)	3/8 in. (10mm)	1 ounce (30ml)
1-1/8 in. (29mm)	3/8 in. (10mm)	1 ounce (30ml)

*If line set length is greater than 25 ft. (7620mm), add this amount. If line set length is less than 25 ft. (7620mm), subtract this amount.

Service Valves and Gauge Manifold Attachment

The liquid line and vapor line service valves and gauge ports are accessible on the inside of the unit. The vapor line service valve cannot be closed once it has been opened. These gauge ports are used for leak testing, evacuating, charging and checking charge. A separate gauge port is provided for checking the suction pressure when the unit is in the heating cycle.

⚠ IMPORTANT

Service valves are closed to the heat pump unit and open to line set connections. Do not open until refrigerant lines have been leak tested and evacuated.

All precautions should be exercised in keeping the system free from dirt, moisture and air.

Leak Testing

- 1- Attach gauge manifold and connect a drum of dry nitrogen to center port of gauge manifold.

⚠ CAUTION

Can cause permanent damage or explosion of gauges resulting in personal injury.

When using dry nitrogen, a pressure reducing regulator must be used to prevent excessive pressure in gauge manifold, connecting hoses, and within the system. Regulator setting must not exceed 150 psig. (1034 kPa).

- 2- Open high pressure valve on gauge manifold and pressurize line set and indoor coil to 150 psig (1034 kPa).
- 3- Check lines and connections for leaks.

NOTE-If electronic leak detector is used, add a trace of refrigerant to the nitrogen for detection by the leak detector.

- 4- Release nitrogen pressure from the system, correct any leaks and recheck.

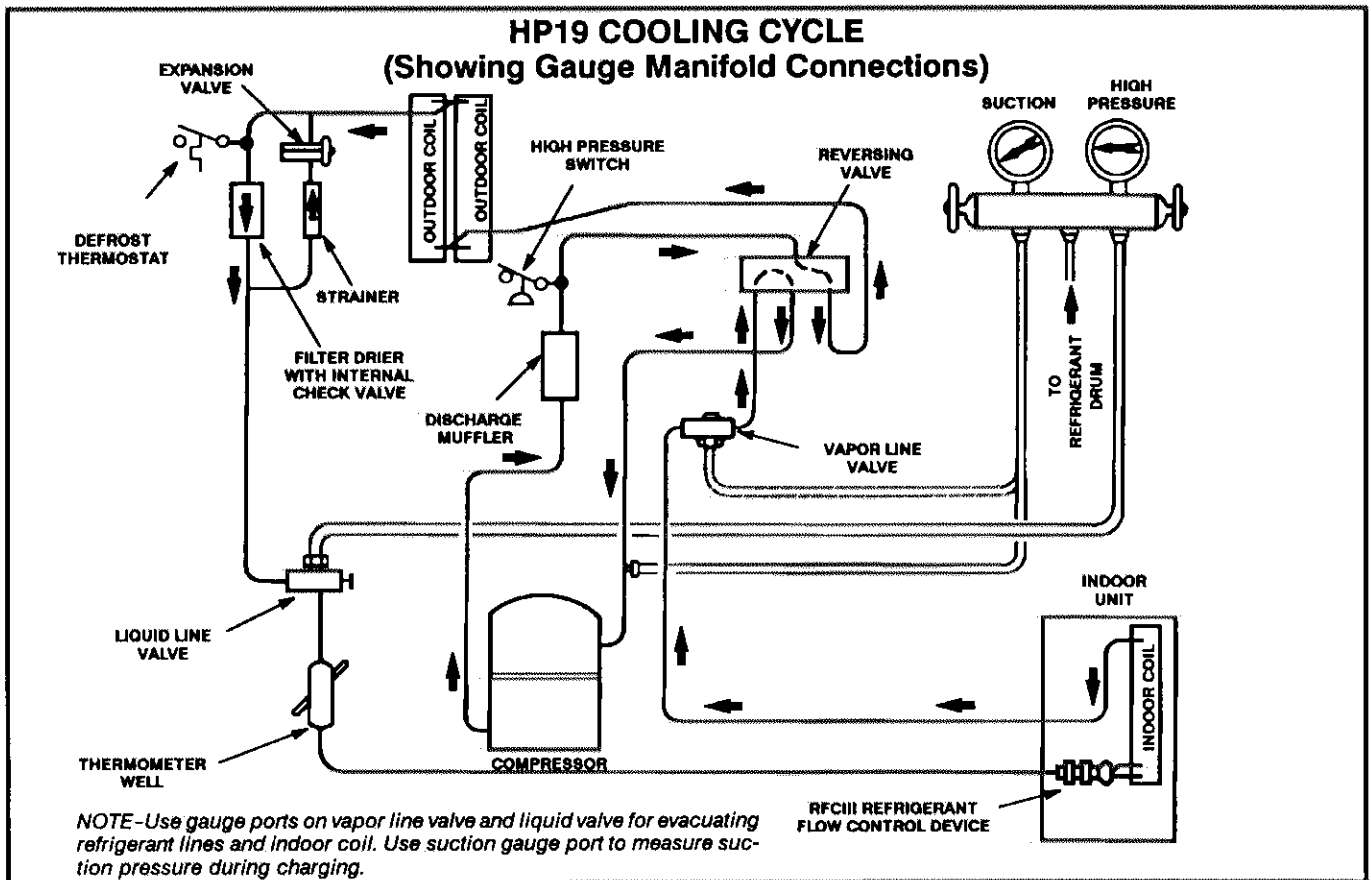

FIGURE 6

Evacuating the System

- 1- Attach gauge manifold as shown in figure 6. Connect vacuum pump (with vacuum gauge) to center port of gauge manifold. With both manifold service valves open, start pump and evacuate indoor coil and refrigerant lines.

NOTE—A temperature vacuum gauge, mercury vacuum (U-tube), or thermocouple gauge should be used. The usual Bourdon tube gauges are not accurate enough in the vacuum range.

- 2- Evacuate the system to 29 inches (737mm) vacuum. During the early stages of evacuation, it is desirable to stop the vacuum pump at least once to determine if there is a rapid loss of vacuum. A rapid loss of vacuum would indicate a leak in the system and a repeat of the leak testing section would be necessary.
- 3- After system has been evacuated to 29 inches (737mm), close gauge manifold valves to center port, stop vacuum pump and disconnect from gauge manifold. Attach an upright nitrogen drum to center port of gauge manifold and open drum valve slightly

to purge line at manifold. Break vacuum in system with nitrogen pressure by opening manifold high pressure valve. Close manifold high pressure valve to center port.

- 4- Close nitrogen drum valve and disconnect from gauge manifold center port. Release nitrogen pressure from system.
- 5- Reconnect vacuum pump to gauge manifold center port. Evacuate system through manifold service valves until vacuum in system does not rise above 29.7 inches (754mm) mercury (5mm absolute pressure) within a 20-minute period after stopping vacuum pump.
- 6- After evacuation is complete, close manifold center port, and connect refrigerant drum. Pressurize system slightly with refrigerant to break vacuum.

B-Start-Up

- 1- Rotate fan to check for frozen bearings or binding.
- 2- Inspect all factory and field-installed wiring for loose connections.

- 3- Open liquid line and vapor line service valves to release refrigerant charge (contained in heat pump unit) into the system.
- 4- To open vapor valve, tighten the opening cap (longest) until it hits bottom [nut will be within 1/8 inch (3mm) or less of the body]. Tighten an additional 1/4 turn to make the metal to metal seal. Refer to figure 7.

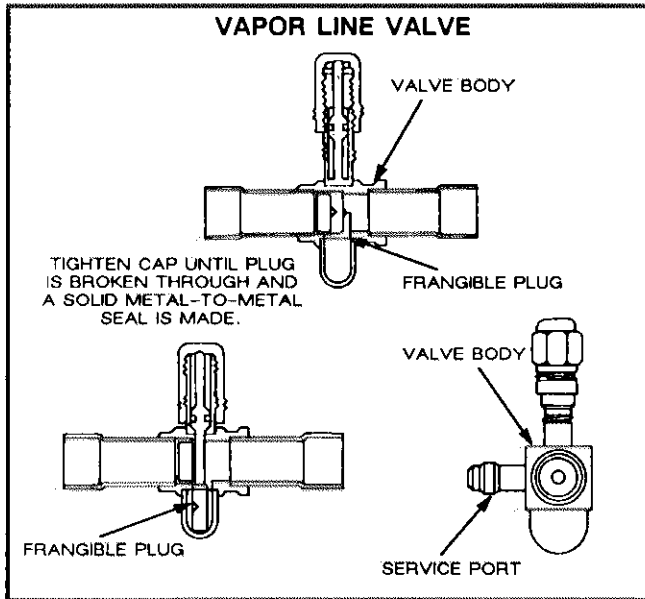

FIGURE 7

NOTE—When tightening, the torque will increase, then drop off as the frangible plug shears.

- 5- Check voltage supply at the disconnect switch. The voltage must be within the range listed on the unit nameplate. If not, do not start the equipment until the power company has been consulted and the voltage condition corrected.
- 6- Set the thermostat for a cooling demand, turn on power to the indoor blower coil and close heat pump unit disconnect switch to start the unit.
- 7- Recheck unit voltage with unit running. Power must be within range shown on unit nameplate. Check amperage draw of unit. Refer to unit nameplate for correct running amps.

C-Charging

It is desirable to charge the system in the cooling cycle if weather conditions permit. However, if the unit must be charged in the heating season, one of the following procedures must be followed to ensure proper system charge.

If the system is completely void of refrigerant, the recommended and most accurate method of charging is to weigh the refrigerant into the unit according to the total amount shown on the unit nameplate and in table 3. Refer to the Lennox Unit Information Service manual for proper procedure.

Model number 410 is a condensed number that refers to both 411 and 413 units. The same applies for 460 (461/413), 510 (511/513) and 650 (651/653) units.

TABLE 3

Model	Refrigerant Charge R-22
HP19-211	6 lbs. 4 oz.
HP19-261	6 lbs. 14 oz.
HP19-311	9 lbs. 5 oz.
HP19-410	11 lbs. 3 oz.
HP19-460	12 lbs. 10 oz.
HP19-510	14 lbs. 12 oz.
HP19-650	18 lbs. 8 oz.

If weighing facilities are not available or if unit is just low on charge, use the following procedure:

- 1- Connect gauge manifold as shown in figure 5. Connect an upright R-22 drum to center port of gauge manifold.
- 2- Record outdoor ambient temperature.
- 3- Set room thermostat to 74°F (23°C) in "Emergency Heat" or "Heat" position and allow unit to run until heating demand is satisfied. This will create the necessary load for proper charging of system in cooling cycle. Change thermostat setting to 68°F (20°C) in "Cool" position. Allow unit to run until system pressures stabilize.
- 4- Check to make sure that thermometer well is filled with mineral oil before checking liquid line temperature.

Expansion Valve Systems

NOTE—Units using RFC111 refrigerant flow control device use a separate charging procedure.

- 5- If outdoor temperature is 60°F or above, place thermometer in well and read liquid line temperature. Difference between ambient and liquid line temperatures should match values given in table 4. Refrigerant must be added to lower approach temperature. Remove refrigerant from system to increase approach temperature.

TABLE 4
Approach Method--Expansion Valve Systems

Model	Liquid Temp Minus Ambient Temp. (°F)
HP19-211	7
HP19-261	6
HP19-311	5
HP19-410	7
HP19-460	8
HP19-510	7
HP19-650	8

6- If ambient temperature is less than 60°F (15°C), air flow might need to be restricted to achieve pressures in the 200–250 psig range (See figure 8). These higher pressures are necessary for checking charge. Block equal sections of air intake panels, moving obstructions sideways as shown until liquid pressure is in the 200–250 psig range.

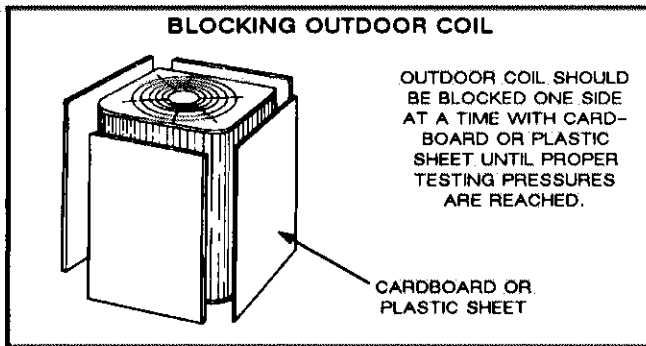

FIGURE 8

7- Read liquid line temperature. Read liquid line pressure from gauge and convert to condensing temperature using standard R-22 temperature/pressure conversion chart. The difference between the liquid line temperature and the conversion temperature is the subcooling temperature (subcooling = conversion temperature minus liquid temperature). Subcooling should approximate values given in table 5. Add refrigerant to increase subcooling and remove refrigerant to reduce subcooling.

TABLE 5
Subcooling Method--Expansion Valve Systems

Model	Subcooling (°F)
HP19-211/261	7 ± 2
HP19-311	8 ± 2
HP19-410/460/510	12 ± 2
HP19-650	10 ± 2

RFCIII Systems

(Charge Using Subcooling Method Steps 7 and 8)

- 8- It is not recommended that the system be charged below 60°F (15°C). If charging below 60°F (15°C) is required, the most reliable method is to weigh in the charge listed on the unit nameplate. This amount will be correct for a system with a line set length of 25 feet. If the line set is longer or shorter than 25 feet, add or remove refrigerant as outlined in table 2.
- 9- If ambient temperature is above 60°F (15°C), place thermometer in well and read liquid line temperature. Read liquid line pressure from gauge and convert to condensing temperature using standard R-22 temperature/pressure conversion chart (or conversion scale on gauge). The difference between the liquid line temperature and the conversion temperature is subcooling (subcooling = conversion temperature minus liquid temperature). The subcooling temperature should approximate the values given in table 6. Add refrigerant to increase subcooling and remove refrigerant to reduce subcooling.
- 10- When unit is properly charged, whether by approach or subcooling method, liquid line pressures should approximate those values given in table 7. Table 7 is to be used as a general guide for typical installations.

TABLE 6
Subcooling Method--RFCIII Systems

Outdoor Unit	Indoor Unit	Subcooling at Various Ambient Temperatures °F					
		65	75	85	95	105	115
HP19-211	CB/CBH19-21	10	9	7	6	4	2
HP19-261	CB/CBH19-26	9	8	7	6	4	2
HP19-311	CB/CBH19-31	11	10	8	7	5	3
HP19-411	CB/CBH19-41	13	12	12	11	9	6
HP19-460	CB19-51	13	12	12	11	9	6
HP19-460	CH19-51	13	12	12	11	9	6
HP19-510	CB19-51	13	12	12	10	7	4
HP19-510	CH19-51	13	12	12	10	7	4
HP19-650	CB19-65	8	7	6	5	3	2
HP19-650	CH19-65	8	7	6	5	3	2

**TABLE 7
NORMAL OPERATING PRESSURES**

MODE	OUTDOOR COIL ENTERING AIR TEMPERATURE	HP19-311		HP19-411 HP19-413		HP19-461 HP19-463		HP19-511 HP19-513		HP19-651 HP19-653	
		LIQ. ± 10 PSIG	SUC. ± 5 PSIG	LIQ. ± 10 PSIG	SUC. ± 5 PSIG	LIQ. ± 10 PSIG	SUC. ± 5 PSIG	LIQ. ± 10 PSIG	SUC. ± 5 PSIG	LIQ. ± 10 PSIG	SUC. ± 5 PSIG
COOLING RFCIII ONLY	75 °F	165	69	169	63	181	71	169	69	175	70
	85 °F	194	75	200	70	211	76	200	75	205	74
	95 °F	223	80	232	77	242	82	232	80	235	79
	105 °F	253	82	266	79	275	84	265	82	267	81
COOLING EXPANSION VALVE ONLY	75 °F	169	76	171	73	182	78	177	74	173	69
	85 °F	196	78	201	75	212	80	196	75	197	76
	95 °F	223	80	232	77	242	82	235	78	238	78
	105 °F	253	82	266	79	275	84	268	79	272	80
HEATING ALL UNITS	20 °F	177	33	181	32	177	32	180	30	179	29
	30 °F	190	42	195	40	194	41	194	40	190	34
	40 °F	203	51	210	49	210	50	206	48	207	45
	50 °F	216	61	225	58	228	60	229	52	219	53

NOTE - Liquid line pressure in heating mode may vary more than ±10 PSIG depending on unit matchup.

D-Compressor Oil Charge

Table 8 gives compressor oil charge for HP19 units. Refer to Lennox Cooling Service Handbook for correct procedure for checking and adding compressor oil.

**TABLE 8
COMPRESSOR OIL CHARGE**

UNIT MODEL NO.	COMPRESSOR OIL CHARGE (Fluid Ozs.)
HP19-211, HP19-261	40*
HP19-311	50*
HP19-410	55 ozs. H.P. Grade Mineral Oil (190-210 viscosity)
HP19-461	54*
HP19-463	54 ozs. H.P. Grade Mineral Oil (150 viscosity)
HP19-511/513 HP19-651/653	65*

*Heat pump grade mineral oil (brand and viscosity unspecified).

VI-OPERATION

A-High Pressure Switch

All units are equipped with a high pressure switch (manually reset type) mounted on the compressor discharge line. This switch has a cut-out point of 410 psig (2827 kPa) and must be manually reset when discharge pressure drops below 180 psig (1241 kPa).

B-Crankcase Heater

IMPORTANT

Crankcase heater (when provided) should be energized before start-up to prevent compressor damage as a result of slugging.

C-Filter Drier

The drier is equipped with an internal check valve for correct refrigerant flow (Refer to figure 5). If replacement is necessary, order another of like design and capacity. A liquid line strainer gives additional compressor protection.

D-Thermostat Operation

Some heat pump thermostats incorporate isolating contacts and an emergency heat function (which includes an amber indicating light). The thermostat is not included with the unit and must be purchased separately.

Emergency Heat (Amber Light)

An emergency heat function is designed into some thermostats. This feature is applicable only to those systems with auxiliary electric heat staged by outdoor thermostats. When the thermostat is placed in the emergency

heat position, the outdoor unit control circuit is isolated from power and field-provided relays by-pass the outdoor thermostats. An amber indicating light simultaneously comes on to remind the homeowner that the unit is operating in the emergency heat mode.

Emergency heat is usually used during a heat pump shut-down, but it should also be used following a power outage if power has been off for over an hour and the outdoor temperature is below 50°F (10°C). System should be left in the emergency heat mode at least six hours to allow the crankcase heater sufficient time to prevent compressor slugging.

E-Defrost System

Defrost Thermostat

A defrost thermostat is mounted on the liquid line between the expansion valve and the distributor. When the unit defrost thermostat senses 35°F (2°C) or cooler, its contacts close and send a signal to the defrost timer for it to start the timing. It also terminates defrost when the liquid line warms up to 70°F (21°C).

Defrost Timer

This control energizes a defrost every 90 minutes after the defrost thermostat closes. The timer will not allow a defrost to last for more than 14 minutes. The defrost timer can be field adjusted from a 90-minute to a 30- or 60-minute defrost interval if warranted by climatic conditions.

VII-MAINTENANCE

At the beginning of each heating or cooling season, the system should be cleaned as follows:

A-Heat Pump Unit

- 1- Clean and inspect condenser coil. (Coil may be flushed with a water hose.)
- 2- Condenser fan motor is prelubricated and sealed. Always relubricate motor according to instructions on the motor manufacturer's nameplate.

- 3- Visually inspect all connecting lines, joints and coils for evidence of oil leaks.
- 4- Check all wiring for loose connections.
- 5- Check for correct voltage at unit (unit operating).
- 6- Check amp-draw on heat pump fan motor.
Unit nameplate _____ Actual _____.
- 7- Inspect drain holes in coil compartment base and clean if necessary.

NOTE-If insufficient heating or cooling occurs, the unit should be gauged and refrigerant charge checked.

B-Indoor Coil

- 1- Clean coil if necessary.
- 2- Check connecting lines, joints and coil for evidence of oil leaks.
- 3- Check condensate line and clean if necessary.

C-Indoor Unit

- 1- Clean or change filters.
- 2- Lubricate blower motor: Always relubricate motor according to manufacturer's lubrication instructions on motor. If no instructions are provided, use the following as a guide:
 - a- *Motors without Oiling Ports* -- Prelubricated and sealed. No further lubrication required.
 - b- *Direct Drive Motors with Oiling Ports* -- Prelubricated for an extended period of operation. For extended bearing life, relubricate with a few drops of SAE No.10 non-detergent oil once every two years. It may be necessary to remove blower assembly for access to oiling ports.
- 3- Adjust blower speed for cooling. The pressure drop over the coil should be checked to determine the correct blower CFM. Refer to the Lennox Engineering Handbook for indoor unit blower CFM tables.
- 4- Check all wiring for loose connections.
- 5- Check for correct voltage at unit.
- 6- Check amp-draw on blower motor.
Motor nameplate _____ Actual _____.