

USER'S INFORMATION MANUAL

G14 Series Units

GAS UNITS
502,596M
12/90
Supersedes 502,207M

RETAIN THESE INSTRUCTIONS FOR FUTURE REFERENCE

FOR YOUR SAFETY

Do not store or use gasoline or other flammable vapors and liquids in the vicinity of this or any other appliance.

WARNING

Improper installation, adjustment, alteration, service, or maintenance can cause injury or property damage. Refer to this manual. For assistance or additional information, consult a qualified installer, service agency, or the gas supplier.

FOR YOUR SAFETY

WHAT TO DO IF YOU SMELL GAS:

- Do not try to light any appliance.
- Open windows.
- Do not touch any electrical switch; Do not use the phone in your building.
- Immediately call your gas supplier from a neighbor's phone. Follow the gas supplier's instructions.
- If you cannot reach your gas supplier, call the fire department.

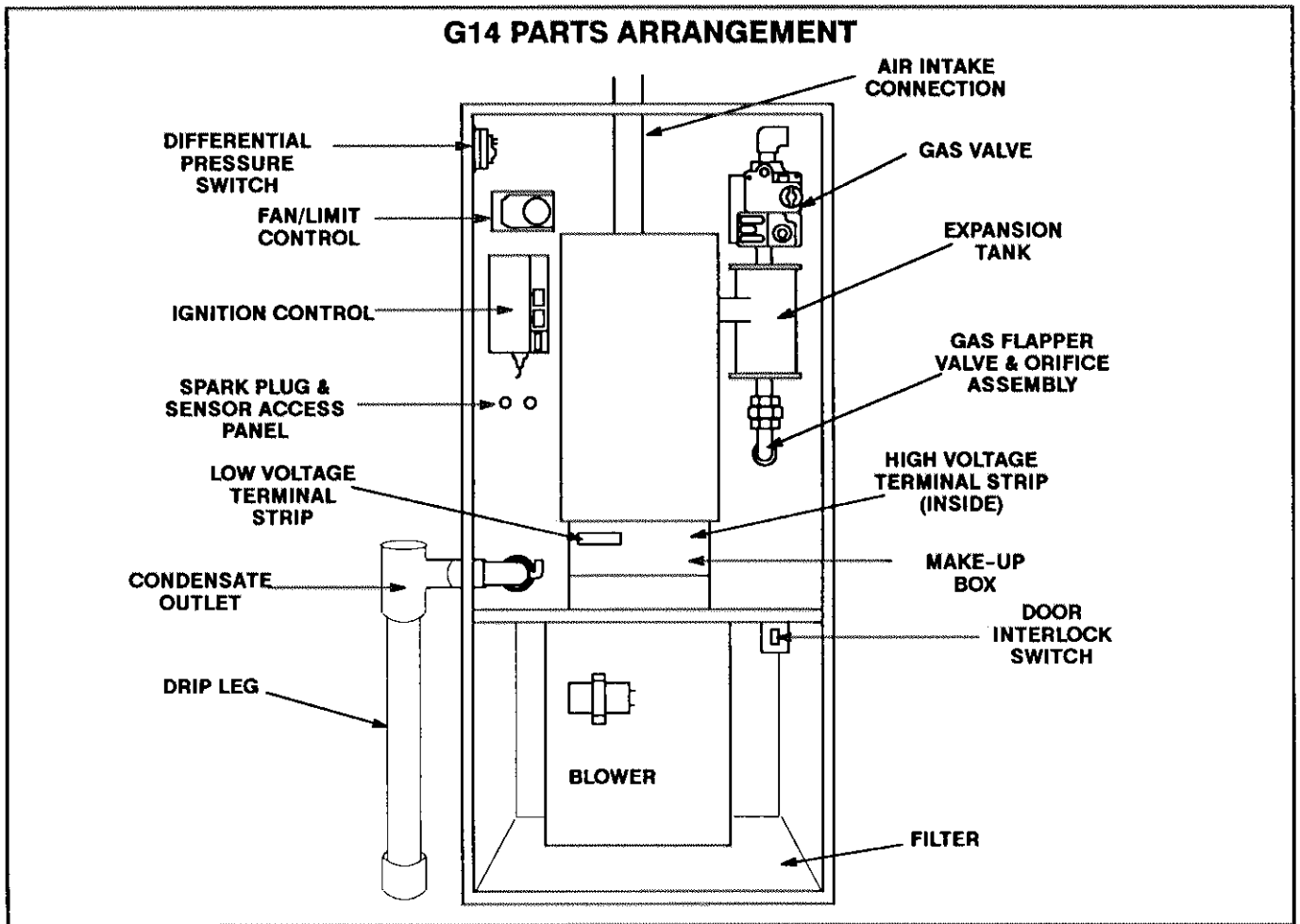

FIGURE 1

FOR YOUR SAFETY READ BEFORE LIGHTING

WARNING: Do not use this furnace if any part has been under water. Immediately call a qualified service technician to inspect the furnace and to replace any part of the control system and any gas control which has been under water.

WARNING: If overheating occurs or if gas supply fails to shut off, shut off the manual gas valve to the appliance before shutting off electrical supply.

CAUTION: Before attempting to perform any service or maintenance the electrical power to unit OFF at disconnect switch.

BEFORE LIGHTING smell all around the appliance area for gas. Be sure to smell next to the floor because some gas is heavier than air and will settle on the floor.

Use only your hand to push in or turn the gas control knob. Never use tools. If the knob will not push in or turn

by hand, do not try to repair it, call a qualified service technician. Force or attempted repair may result in a fire or explosion.

I-IMPORTANT OPERATION

A-Clearing Furnace Area

Keep the furnace area free and clear of combustible material, gasoline and other flammable vapors and liquids. If installed in an insulated area, furnace must be kept free of insulating material. Insulating material may be combustible.

B-Do Not Obstruct Air Flow

Do not obstruct termination ends of exhaust and intake pipes.

C-Hazard To Furnace

Do not store chlorine or fluorine products near unit or introduce into combustion air. These products can result in furnace corrosion.

II-UNIT OPERATION

This unit is equipped with an automatic spark ignition system with flame rectification. Once combustion has started, the purge blower and spark ignitor are turned off. Do **not** try to light by hand.

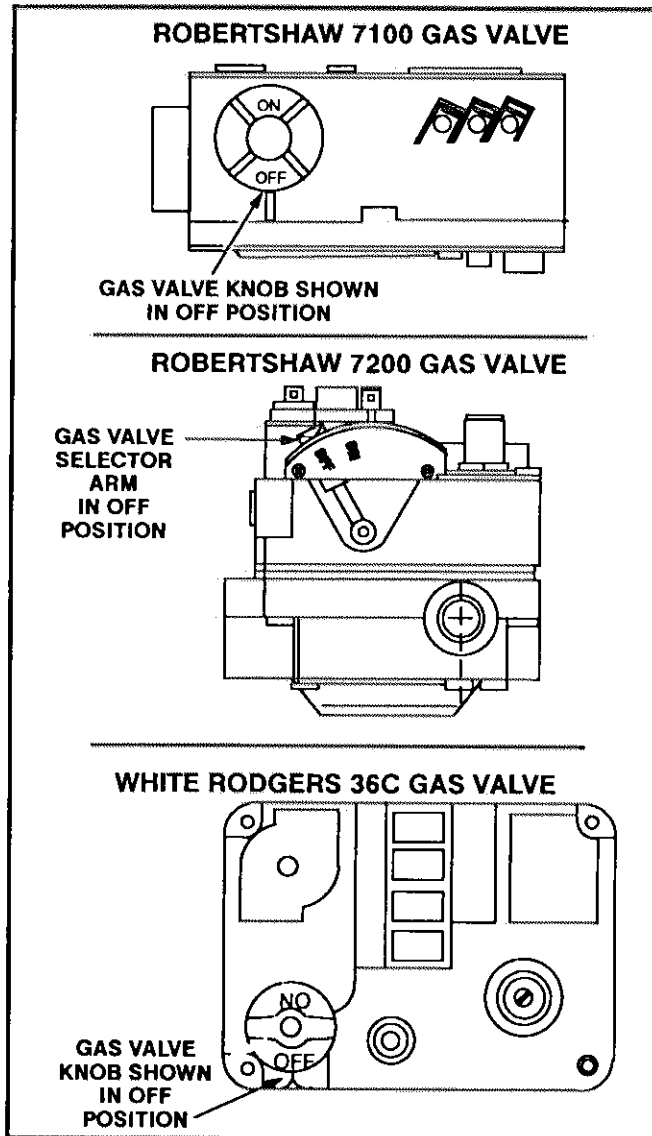



FIGURE 2

A-Gas Valve Operation

WARNING: If you do not follow these instructions exactly, a fire or explosion may result causing property damage, personal injury or loss of life.

Gas Valve Operation for Robertshaw and White Rodgers Valves (Figure 2)

- 1- Set thermostat to lowest setting. See figure 4.
- 2- Turn off all electrical power to furnace. See figure 6.

- 3- This appliance is equipped with an ignition device which automatically lights the burner. Do **not** try to light the burner by hand.
- 4- Remove unit access panel.
- 5- Turn knob on gas valve clockwise  to **OFF**. On Robertshaw 7200 gas valve, depress lever on gas control and move to **OFF** and release. Do not force.
- 6- Wait five (5) minutes to clear out any gas. If you then smell gas, **STOP!** Immediately call your gas supplier from a neighbor's phone. Follow the gas supplier's instructions. If you do not smell gas go to next step.
- 7- Turn knob on gas valve counterclockwise  to **ON**. On Robertshaw 7200 gas valve, depress lever on gas control and move to **ON** and release.
- 8- Replace unit access panel.
- 9- Turn on all electrical power to unit.
- 10- Set thermostat to desired setting.
- 11- If the furnace will not operate, follow the instructions "To Turn Off Gas To Unit" and call your service technician or gas supplier.

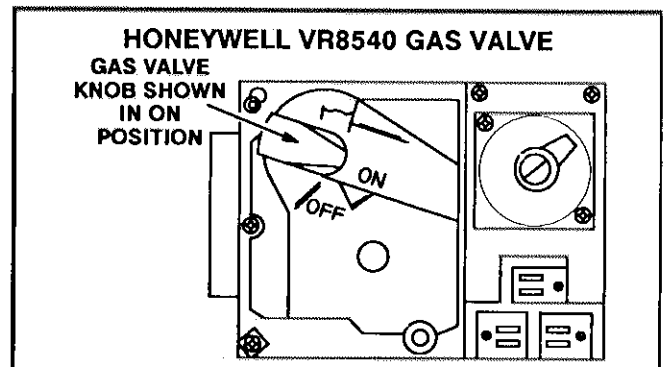





FIGURE 3

Gas Valve Operation for Honeywell VR8450 Series Valve (Figure 3)



- 1- Set thermostat to lowest setting. See figure 4.
- 2- Turn off all electrical power to furnace. See figure 6.
- 3- This appliance is equipped with an ignition device which automatically lights the burner. Do **not** try to light the burner by hand.
- 4- Remove unit access panel.
- 5- Turn knob on gas valve clockwise  to **STOP** and release. Knob will pop up. Turn clockwise  to **OFF**.

NOTE-Knob cannot be turned from ON to OFF unless knob is depressed.

- 6- Wait five (5) minutes to clear out any gas. If you then smell gas, STOP! Immediately call your gas supplier from a neighbor's phone. Follow the gas supplier's instructions. If you do not smell gas go to next step.
- 7- Turn knob on gas valve counterclockwise  to STOP. Depress knob and turn counterclockwise  to ON. Knob will remain depressed.
- 8- Replace unit access panel.
- 9- Turn on all electrical power to unit.
- 10- Set thermostat to desired setting.
- 11- If the appliance will not operate, follow the instructions "To Turn Off Gas To Unit" and call your service technician or gas supplier.

B-To Turn Off Gas To Unit

- 1- Set thermostat to lowest setting.
- 2- Turn off all electrical power to unit if service is to be performed.
- 3- Remove heat section access panel.
- 4- Turn knob on gas valve clockwise  to OFF. Do not force.

NOTE-Honeywell VR8450 series valves - Turn knob on gas valve clockwise  to STOP and release. Knob will pop up. Turn knob  clockwise to OFF. On Robertshaw 7200 gas valve, depress lever on gas control and move to OFF and release.

- 5- Replace unit access panel.

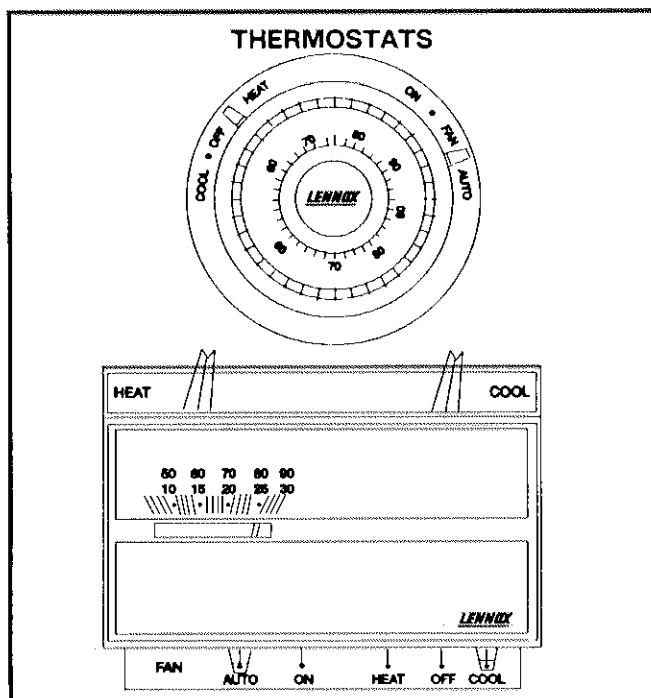

FIGURE 4

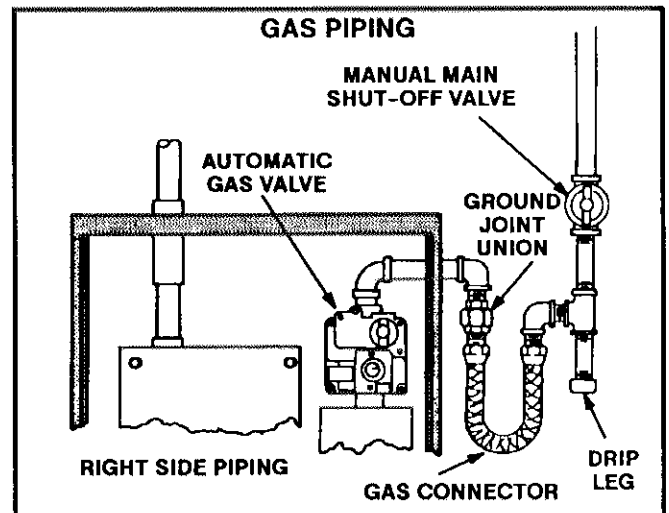

FIGURE 5

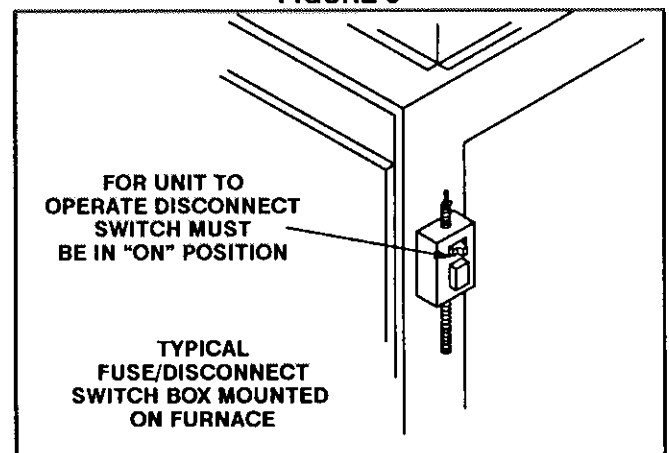

FIGURE 6

III-SERVICING FILTER

Inspect and clean air filters each month. Filters must be cleaned when dirty to assure proper furnace operation and maintain efficiency.

A-Cleaning Reusable Scotfoam Filter

- 1- Turn off electrical power to furnace. See figure 4.
- 2- Remove blower access panel. Wait for blowers to stop.
- 3- Remove filter by sliding up and out of channel.
- 4- Wash filter with water and a mild detergent. For increased efficiency, filter media should be sprayed with Filter Handicoater when dry. Filter Handicoater is RP products No. 418 and is available as Lennox part No. P-8-5069.

NOTE-If filter media must be replaced, use Lennox part No. P-8-7822 for 16 x 25 inch filters and P-8-7831 for 20 x 25 inch filters.

- 5- Reinstall filter. Slide filter into top channel and drop into lower channel.

IMPORTANT-Do not replace Scotfoam Reusable Filters with throw-away type filters.

- 6- Replace blower access panel.

IV-LUBRICATION

Motor is prelubricated for extended bearing life; no further lubrication is required.

V-SERVICE

At the beginning of each heating season, the system should be checked as follows:

- 1- Examine the termination ends of the intake and exhaust lines for obstructions or blockages.
- 2- Check the intake and exhaust lines for sagging or broken isolation hangers. If a sag is found in either line, raise the line and support it with an isolation hanger. Replace any damaged isolation hangers.

IMPORTANT-If a change in the sound level of the

unit is detected or there is evidence of condensate leakage around the unit, contact your Lennox service technician.

VI-SERVICE REMINDER

Call your Lennox service technician if the unit is inoperative. Before calling, always check the following to be sure service is required:

- 1- Be sure electrical switches are **ON**.
- 2- Check the room thermostat for proper setting.
- 3- Replace any blown fuses or reset circuit breakers.
- 4- Make sure gas valve is on.
- 5- Blower access panel is in place.
- 6- Air filter must be clean.

VII-PLANNED SERVICE

To keep your Lennox gas heating system in peak operating condition year after year, contact your independent Lennox dealer about planned service program.