



Water chillers and two-circuit heat pumps – water-condensing and split type versions – HWW series

HWW – C water-water chillers – cooling only

HWW - H water-water chillers - heat pump version

HWR motor-driven evaporative chillers with remote condenser



USE and INSTALLATION MANUAL



TABLE OF CONTENTS

GENERALITIES

INSPECTION, CONVEYANCE, SITING

- Inspection
 - Lifting and conveyance
 - Unpacking
 - Siting

INSTALLATION

- Installation clearance requirements
- General guidelines for plumbing connections
- Water connection to the evaporator
- Instructions for the filling up of the tank
- Safety valve drain pipes
- Electrical connections
- Generalities
- Remote controls
- Split unit installation

STARTING UP

- Preliminary checks
- Starting up instructions
- Starting operation
- Checks during operation
- Checking the refrigerant level
- Stopping the unit



TABLE OF CONTENTS

OPERATING LIMITS

- Water flow to evaporator
- Chilled water temperature
- External water temperature
- Operation with water at low temperatures

SETTING OPERATING PARAMETERS

- Generalities
- Maximum pressure switch
- Minimum pressure switch
- Service thermostat
- Antifreeze thermostat
- Anti-recycle timer

ROUTINE MAINTENANCE AND CHECKS

- Warnings
- Generalities
- Repairing the cooling circuit
- Tightness test
- Hard vacuum and drying of cooling circuit
- Charging with R407C refrigerant
- Environmental protection

RETIRING THE UNIT

TROUBLESHOOTING



Dichiarazione di conformità

LA dichiarazione di conformità è allegata ad ogni macchina



Declaration of conformity

The declatration of conformity is attached to each unit sold.



General Description

The Series

The HWW series of water-condensing chillers includes a range of models capable of satisfying every need.

- ❑ Water-condensing units – cooling only – of [53.9 - 296 kW]
- ❑ Heat pump reversible water-condensing units of [53 - 290 kW]
- ❑ Motor-driven evaporative units – cooling only – of [46.2 –257.3 kW]

Structure

All HWW units have a galvanised sheet steel supporting base, coated with epoxy polyester powder paint oven cured at 180°C and enclosing panels made of aluminium and magnesium alloy 5005 (Peraluman). The unit features an exclusive design which lends it an attractive appearance as well as ensuring that all components will be completely inaccessible when the unit is closed. This characteristic, together with the extensive use of soundproofing material inside the compartment – an optional feature of low-noise models – reduces noise to exceptionally low levels [Lp < 66 dB-A at 1 metre]. The plumbing/cooling connections are situated at the top to reduce the technical spaces required for installation. All panels are removable, thus enabling complete access to all chiller components, though only access from the front is required for routine servicing.

Field of Application

The HWW units are designed to cool-heat water and solutions containing up to 30% glycol (percentage by weight) in civil, industrial and technological air-conditioning systems. In buildings with large surface areas, the air conditioning system can be expanded step by step as new floors or areas are sold/leased, by installing an HWW unit for every floor in a small control room. This allows you to spread your investment over time.. The possibility of keeping the evaporator indoors means there is no need to add glycol to the water inside the system. In addition, you can keep all components requiring routine or special maintenance in an easily accessible room. The plusses offered by these products are summed up in the following table:

- ❑ HWWC HWWH water-condensing units
 - Occupies an extremely small surface area
 - No need to add glycol to the water in the user circuit
 - High COP [Coefficient of Performance] of the thermodynamic cycle
 - No noise outside
 - Extremely small refrigerant charge.
 - Innovative aesthetics and total safety, given that the chillers are completely enclosed
 - Option of installing an outdoor dry cooler where it is not possible to use a non-recirculating water supply to cool the condenser
 - Heat pump version with cycle reversibility at the cooling side
 - Condensing control option on the heat pump versions possible

- HWRC versions with remote condenser
 - Occupies an extremely small surface area
 - No need to add glycol to the water in the user circuit
 - Possibility of installing condensers on floors with a low weight-bearing capacity, which would not be able to support the weight of a complete machine
 - Simplified piping, since there is no need for vapour barrier insulation [cooling only configuration]
 - Innovative aesthetics and total safety, given that the chillers are completely enclosed
 - Availability of a separate hydronic kit with the same styling as the chiller
 - **NOTE:** for the units in question, it is mandatory to comply with the specifications of 97/23 PED, cited in the section "INSTALLATION"

HWW units are to be used within the operating limits stated in this manual; failure to comply with said limits will invalidate the warranties provided in the contract of sale.

Cooling circuit

The entire cooling circuit is built in the manufacturer factory using only components of the finest quality brands and processes conforming to the specifications of Directive 97/23 for brazing. The chillers are built with a single cooling circuit using only components supplied by leading international manufacturers.

- Compressors: only scroll-type compressors of leading international manufacturers are used in the HWW units. The scroll compressor is presently the best solution in terms of reliability and efficiency in the range of power up to 145 kW for each circuit and in terms of noise level. **NOTE:** the scroll compressor, like all hermetic compressors, is classified as a pressure vessel according to the PED insofar as its low-pressure section is concerned, to which the PS indicated on the rating plate refers.
- Heat exchangers all chillers have heat exchangers with braze-welded AISI 304 austenitic stainless steel plates and connections made of AISI 304 L, characterised by a reduced carbon content to facilitate brazing. Braze-welded plate exchangers represent the state of the art in terms of heat exchange efficiency and make it possible to significantly reduce the refrigerant charge compared to traditional solutions. The high turbulence induced by the internal corrugation of the plates combined with their perfectly smooth surface also helps prevent dirt build-up and the formation of scale on the condenser side. **NOTE:** due to the presence of heat insulation, the data plate is not legible as required under 97/23 PED. However, the exchanger serial number and declaration of conformity are recorded during production and constitute an integral part of HiRef S.p.A records.
- Cooling components:
 - Molecular mesh activated-alumina filter dryer
 - Flow indicator with humidity indicator. Indications are provided directly on the sight glass.
 - Thermostatic valve with external equalisation and integrated MOP function.
 - Reverse cycle valve (heat pump only)
 - Unidirectional valve (heat pump only)
 - High and low pressure switches
 - Schrader valves for checks and/or maintenance
 - Safety valve
- Electric control board: The electric control board is constructed and wired in accordance with Directives 73/23/EEC and 89/336/EEC and related standards. The board may be accessed through a door after the main switch has been put off. All the remote controls use 24 V signals powered by an insulating transformer situated on the electric control board. A T



control kit comprising a thermostat and an auxiliary fan is available on request. The protection rating of the unit is IP 43. **NOTE:** the mechanical safety devices such as the high pressure switch are of the kind that trigger directly; their efficiency will not be affected by any faults occurring in the microprocessor control circuit. in compliance with 97/23 PED.

- Control microprocessor: the microprocessor built into the unit allows the different operating parameters to be controlled from a set of pushbuttons situated on the electric control board;
 - Switching on/off of compressor to maintain the temperature set point of the chiller inlet water temperature
 - Alarm management
 - High / low pressure
 - Antifreeze
 - Flow switch
 - Pump alarm
 - Alarm signalling
 - Display of operating parameters
 - Antifreeze protection of evaporator
 - Management of maximum number of compressor start-ups
 - RS232, RS485 serial output management (optional)
 - Phase sequence error [Not displayed by the mP, but prevents the compressor from starting up]

[ref. Microprocessor control manual for further details]

BASIC COOLING CIRCUIT

- Cooling only versions – Basic diagram of a single circuit

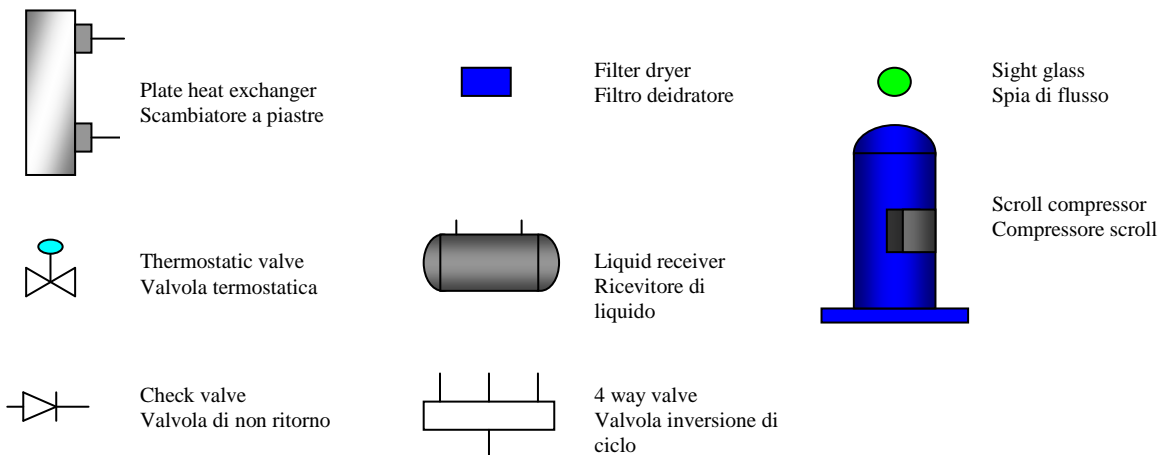
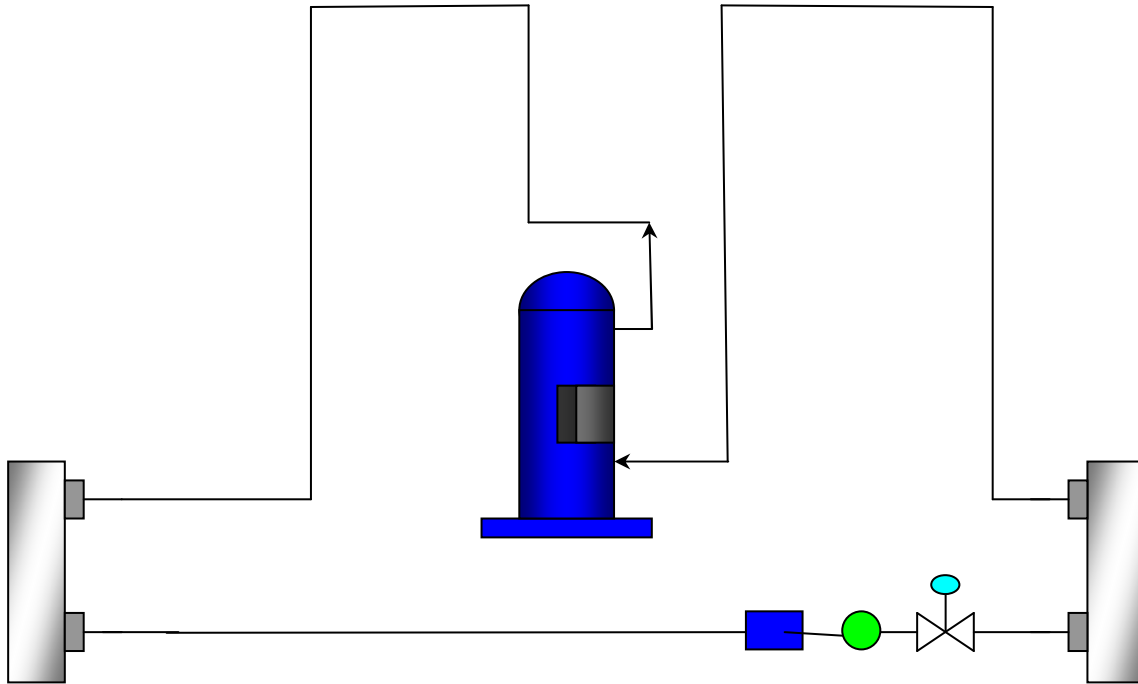

□ Heat pump versions – Basic diagram of a single circuit

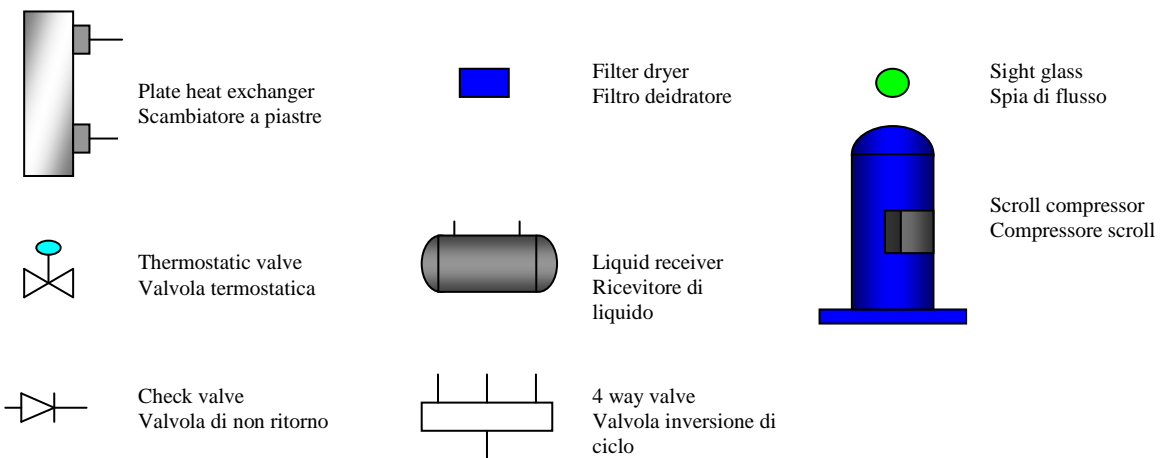
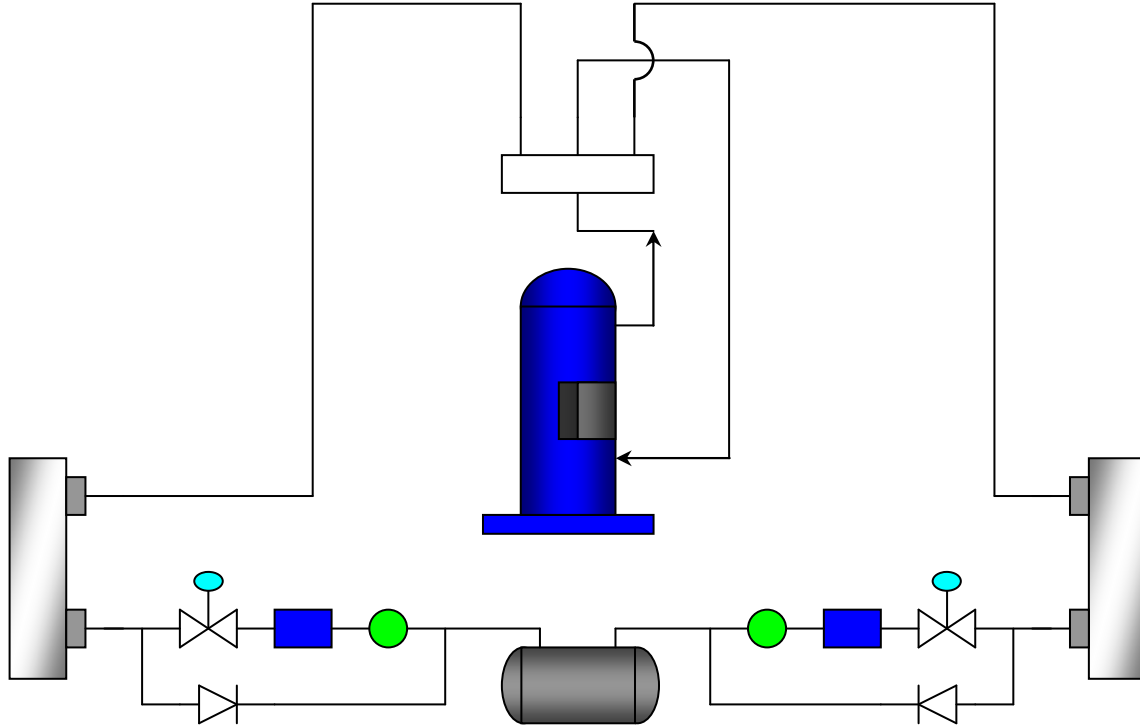

❑ Cooling only versions with remote condenser – Diagram of a single circuit

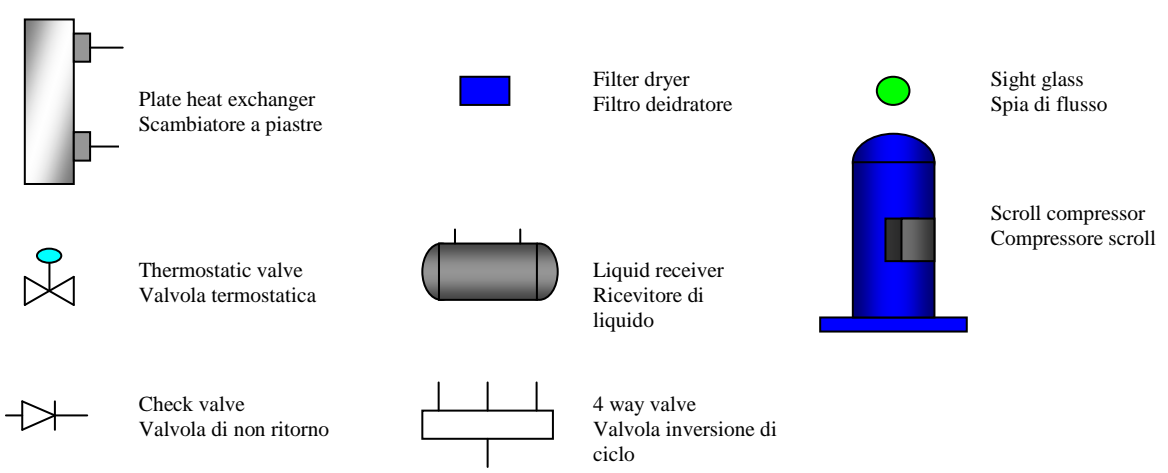
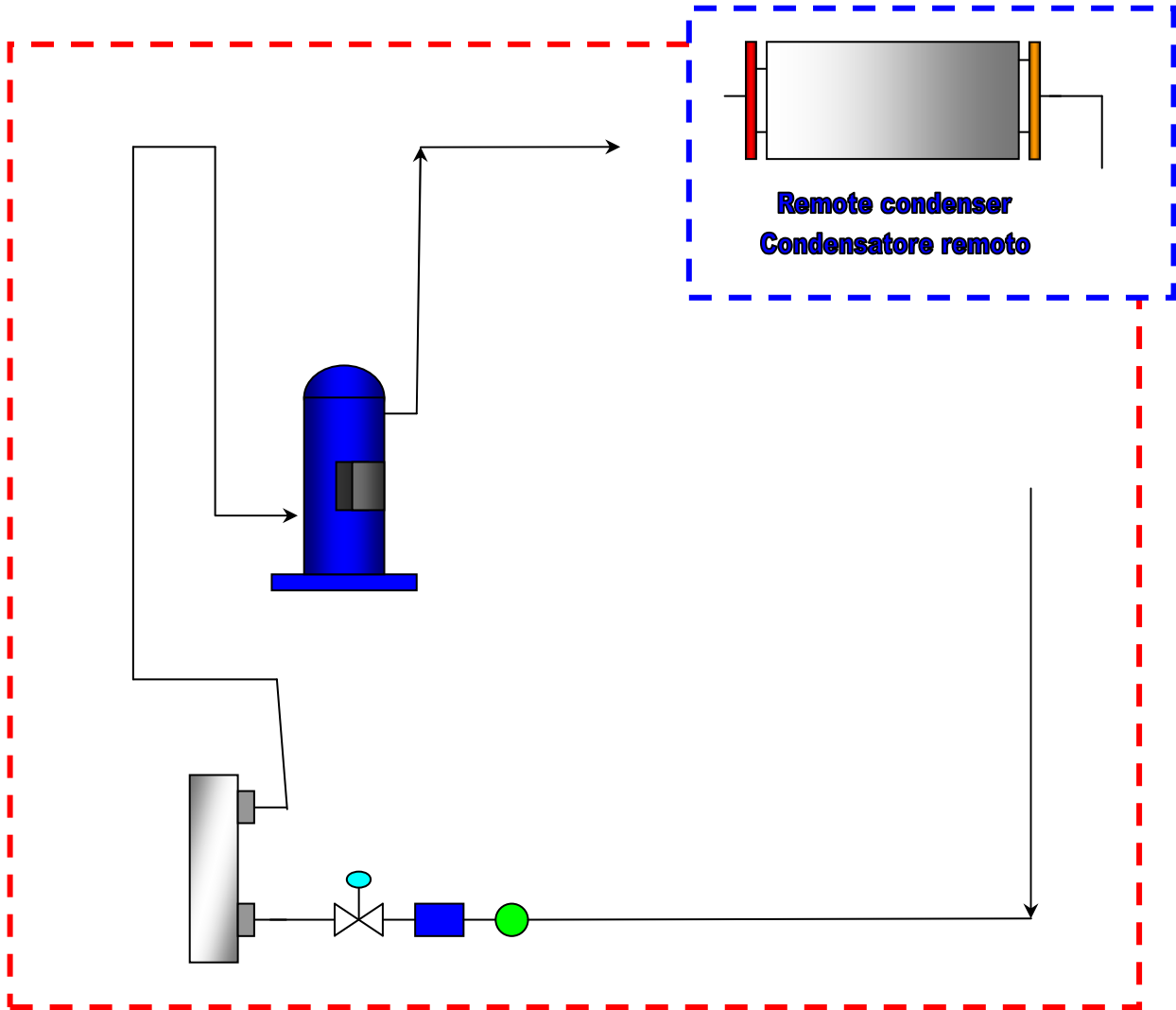

□ Heat pump versions with remote condenser – Basic diagram of a single circuit

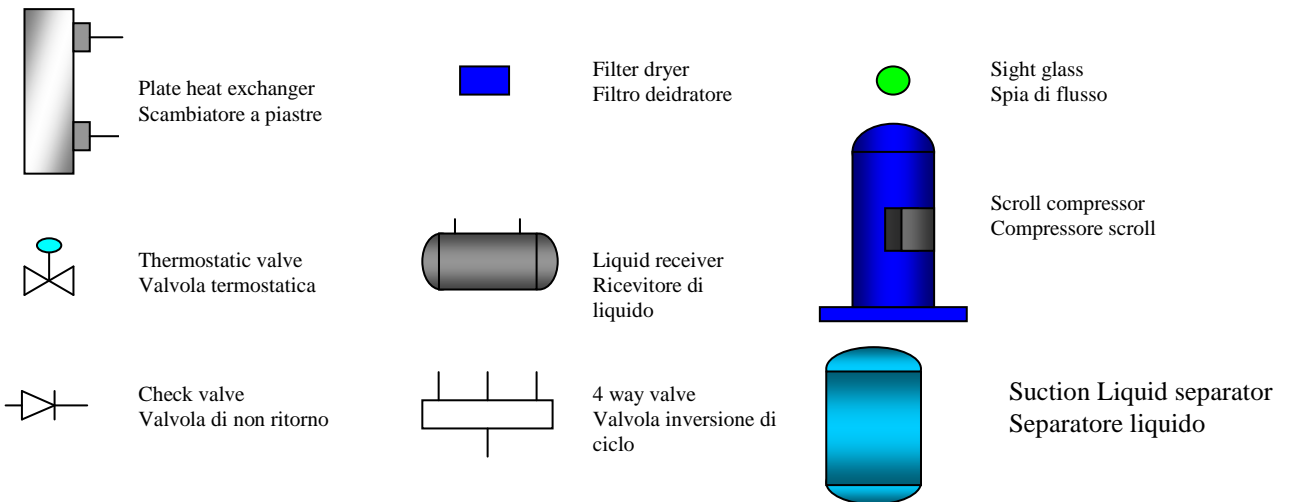
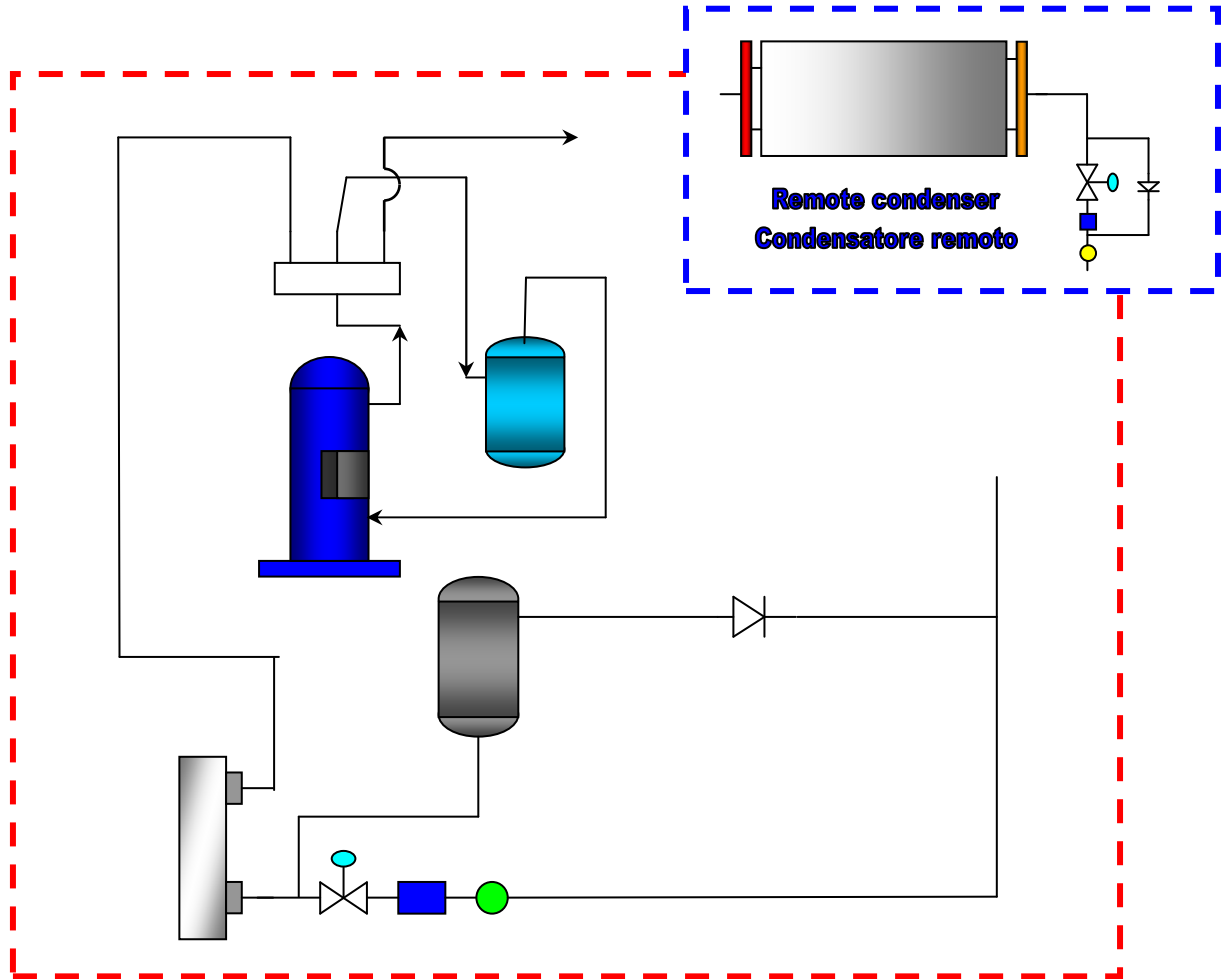

Installation

General rules

- When installing or servicing the chiller, you must strictly follow the rules provided in this manual, comply with the directions on the units and take all such precautions as are necessary.
- The fluids under pressure in the cooling circuit and the presence of electrical components may cause hazardous situations during installation and maintenance work.



All work on the unit must be carried out by qualified personnel trained to do their job in observance of current laws and regulations.

- Failure to comply with the rules provided in this manual or any modification made to the unit without prior authorisation will result in the immediate invalidation of the warranty.



Warning: Before performing any kind of work on the unit, make sure it has been disconnected from the power supply.

Inspection/Conveyance/Siting

Inspection on receipt

On receiving the unit, check that it is perfectly intact: the machine left the factory in perfect conditions; immediately report any signs of damage to the carrier and note them on the Delivery Slip before signing it.

Lennox S.p.A. or its Agent must be promptly notified of the entity of the damage. The Customer must submit a written report describing every significant sign of damage.

Lifting and Conveyance

While the unit is being unloaded and positioned, utmost care must be taken to avoid abrupt or violent manoeuvres. The unit must be handled carefully and gently: avoid using machine components as anchorages when lifting or moving it.

The unit must be lifted using the holes provided on the base and a lifting beam to prevent the unit from being deformed due to axial strains during lifting.



Warning: In all lifting operations make sure that the unit is securely anchored in order to prevent accidental falls or overturning.



Unpacking

The packing must be carefully removed to avoid the risk of damaging the unit. Different packing materials are used: wood, cardboard, nylon etc.

It is recommended to keep them separately and deliver them to suitable waste disposal or recycling facilities in order to minimise their environmental impact.

Siting

You should bear in mind the following aspects when choosing the best site for installing the unit and the relative connections:

- size and origin of water pipes;
- location of power supply;
- accessibility for maintenance or repairs;
- solidity of the supporting surface;

All models belonging to the HWW series are designed and built for indoor installation. As special care has been taken in the sound insulation and sealing of the components and hot parts in general, they need not be installed in dedicated rooms.

It is advisable to place a rigid rubber strip between the base frame and the supporting surface.

INSTALLATION

Installation clearance requirements

In the case of units with a remote condenser, the plumbing and cooling connections are provided on the top of the unit. This allows the chiller to be placed practically against the rear wall. It is nonetheless of fundamental importance to assure the following service spaces:

- back side: min. 0 metres
- electric control board side: min. 1.0 metre to guarantee access for inspection and/or maintenance of cooling components
- lateral part: min. 0.5 metre for extraordinary maintenance
- top side: min. 1.0 metre for adequate connection to the external hydraulic and cooling piping.

General Guidelines for Plumbing Connections

When you are getting ready to set up the water circuit for the evaporator you should follow the directions below and in any case make sure you comply with national or local regulations (use the diagrams included in this manual as your reference).

- Connect the pipes to the chiller using flexible couplings to prevent the transmission of vibrations and to compensate thermal expansions. For the types and size of the water and cooling connections [versions with remote condenser only] refer to the table of technical data.
- It is recommended to install the following components on the pipes:
 - temperature and pressure indicators for routine maintenance and monitoring of the unit. Checking the pressure on the water side will enable you to verify whether the expansion tank is working efficiently and to promptly detect any water leaks within the equipment.
 - traps on incoming and outgoing pipes for temperature measurements, which can provide a direct reading of the operating temperatures. Temperature readings can in any case be obtained from the microprocessor installed on the unit.
 - regulating valves (gate valves) for isolating the unit from the water circuit during maintenance work.
 - metal mesh filter (incoming pipes), with a mesh not to exceed 1 mm, to protect the exchanger from scale or impurities present in the pipes. This prescription is particularly important at first start-up.
 - air vent valves, to be placed at the highest points of the water circuit for the purpose of bleeding air. [The internal pipes of the unit are fitted with small manual air vent valves for bleeding the unit itself: **this operation may only be carried out when the unit is disconnected from the power supply**].
 - drainage valve and, where necessary, a drainage tank for emptying out the equipment for maintenance purposes or when the unit is taken out of service at the end of the season.

Water connection to the evaporator



It is of fundamental importance that the incoming water supply is hooked up to the connection marked "Water Inlet".

Otherwise the evaporator would be exposed to the risk of freezing since the antifreeze thermostat would not be able to perform its function; moreover the reverse cycle would not be respected in the cooling mode, resulting in additional risks of malfunctioning. This position does not enable the operation of the water flow control device.

The dimensions and position of plumbing connections are shown in the dimension tables at the end of the manual.



The water circuit must be set up in such a way as to guarantee that the nominal flow rate of the water supplied to the evaporator remains constant (+/- 15%) in all operating conditions.

The compressors work intermittently, since the chilling requirements of the user generally do not coincide with the compressor output. In systems containing little water, where the thermal inertia of the water is lower, it is a good idea to check that the water content in the section delivering to users satisfies the condition below:

$$V = \frac{Cc \times \Delta\tau}{\rho \times Sh \times \Delta T \times Ns}$$

V	= water content in user section	[m ³]
Sh	= specific heat of the fluid	[J/(kg/°C)]
ρ	= fluid density	[kg/m ³]
Dτ	= minimum time lapse between 2 compressor restarts	[s]
DT	= allowed water T differential	[°C]
Cc	= Cooling capacity	[W]
Ns	= N° of capacity control steps	

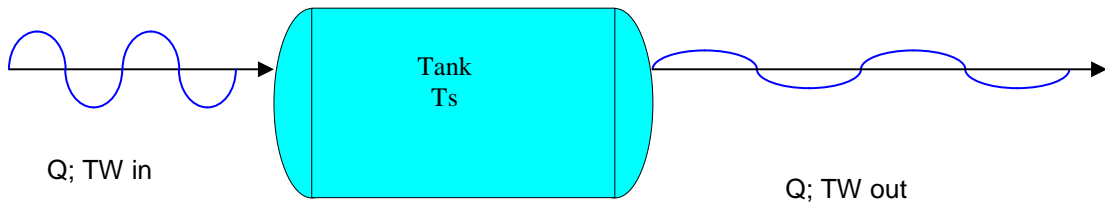



A **standard** feature of HWW units is a device for controlling the flow rate (flow switch or differential pressure switch) in the water circuit in the immediate vicinity of the evaporator. Any tampering with said device will immediately invalidate the warranty. It is advisable to install a metal mesh filter on the inlet water pipe.



Warning: When making the plumbing connections, make sure there are no open flames in proximity to or inside the unit.

Instructions for the filling up of the tank



The tank is not planned to resist to a depression greater than -0,15 Bar, so pay attention to the fact that the suction pressure of the pump, where the expansion tank is positioned, has to be always greater than 0,5 Bar with the pump in operation: this fact also contributes to reduce any risks concerning the cavitation of the pump.

It is of fundamental importance for the installer to follow and check the instructions written below stepwise, so as to avoid every kind of risks concerning the implosion of the tank or the cavitation of the pump:

- a) Empty the expansion tank until the pressure is 0,5 Bar
- b) Charge the system and pressurize it until about + 1 Bar in suction, pump side (with pump not working)
- c) Allow air to escape from the system
- d) Check the suction pressure of the pump (about 1 Bar) and start the system
- e) Stop the pump after 15-30 minutes and repeat from point **c)** until you don't hear noises, caused by air still present in the system, anymore.

General guidelines for Cooling connections of HWR units

HWR units are supplied pre-charged with inert nitrogen gas at a pressure of 3 bars to protect them from the penetration of humidity and are provided with threaded Rotalock weld-on connections (3 pieces) for outdoor piping.

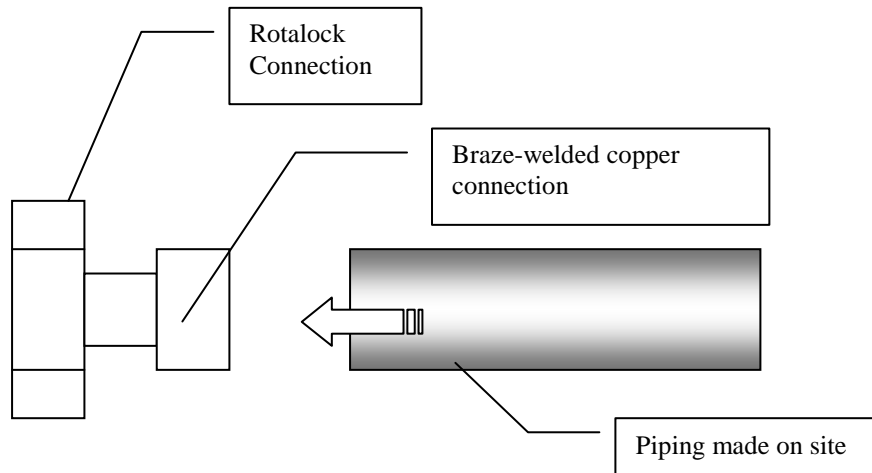

Note: Only qualified personnel may choose and install the piping and carry out the final braze-welding operations, as per current laws and regulations. Said personnel must issue a new declaration of conformity for units assembled on site.

The following table reports the dimensions suggested for piping

Unit model	Fluid line	Thickness (mm)	GAS line	Thickness (mm)
HWRC0502-0672	16 mm	1	22	1,5
HWRC0742-1362	18 mm	1	28	1,5
HWRC1522-2442	22 mm	1,5	35	1,5
HWRC2582-3042	28 mm	1,5	42	1,5

Prescriptions for laying

- Vertical ascending gas lines set a trap every 4 metres
- Vertical fluid lines:
 - The complete miscibility between oil and refrigerant assures entrainment of lubricant in all conditions
 - Pay attention to the fact that in the case of descending lines the pressure generated by the column of liquid is added to the outlet pressure: for differences in level exceeding 10 m contact the manufacturer to have the safety pressure switches set accordingly
 - Pay attention to the fact that in the case of rising lines, the pressure drop due to the travel height reduces the undercooling of the liquid, resulting in the possible formation of flash vapours: in this case choose a larger sized remote condenser and charge until you obtain 2°C of additional undercooling for every 10 m of height.

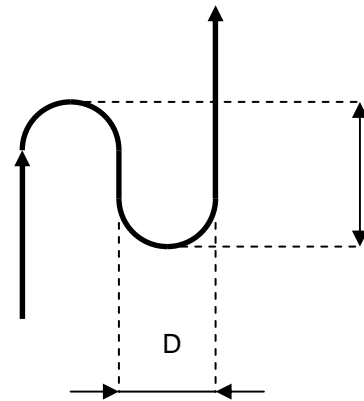

The table below shows the classification of piping according to EEC directive 97/23 PED

Outside diameter [mm]	Thickness (mm)	PS bars	PED Category	σ_s copper [N/mm ²]	actual σ [N/mm ²]	Coeff. Sic.
10	1	28	A3 P3	227	11.2	20.3
12	1	28	A3 P3	227	14	16.2
16	1	28	A3 P3	227	19.6	11.6
18	1	28	A3 P3	227	21	10.8
22	1,5	28	A3 P3	227	17.3	13.1
28	1,5	28	A3 P3	227	23.3	9.8
35	1,5	28	A3 P3	227	28.9	7.85
42	1,5	28	CAT I	227	36.4	6.2
54	1.5	28	CAT I	227	47.6	4.8



Note: The material used for the piping must be exclusively CU-DHP or CW024A. copper of a quality complying with the specifications of standard EN12735 and for which materials certificate 3.1b is available.

Evacuation and charging operations for HWR-type units



This type of work must be carried out by qualified personnel trained to do their job in observance of current laws and regulations.

1. Introduction:

The simultaneous presence of liquid and vapour makes it necessary for both to be in a state of saturation [Gibbs law], as shown in fig. 1). In conditions of thermal equilibrium, the pressure in the tank corresponds to the T of the surrounding environment; a withdrawal of refrigerant charge will cause pressure drops, which will be associated with

- withdrawal of refrigerant charge
 - pressure drop in tank
 - T drop - change of state
 - cooling of liquid
- ⇒ pressure drop in tank
 - ⇒ T drop - change of state
 - ⇒ evaporation of part of the liquid, causing the liquid itself to cool
 - ⇒ thermal exchange with ambient air, further evaporation of remaining liquid; the original pressure is restored in the tank after a certain amount of time

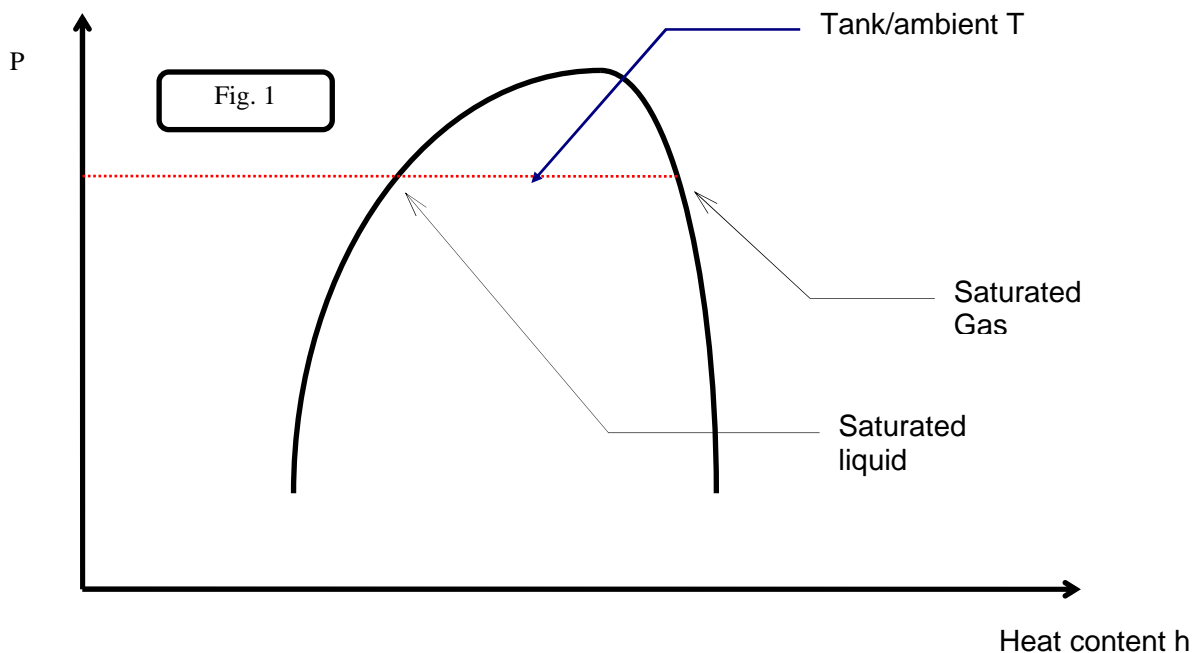

2. Vacuum and charging machine

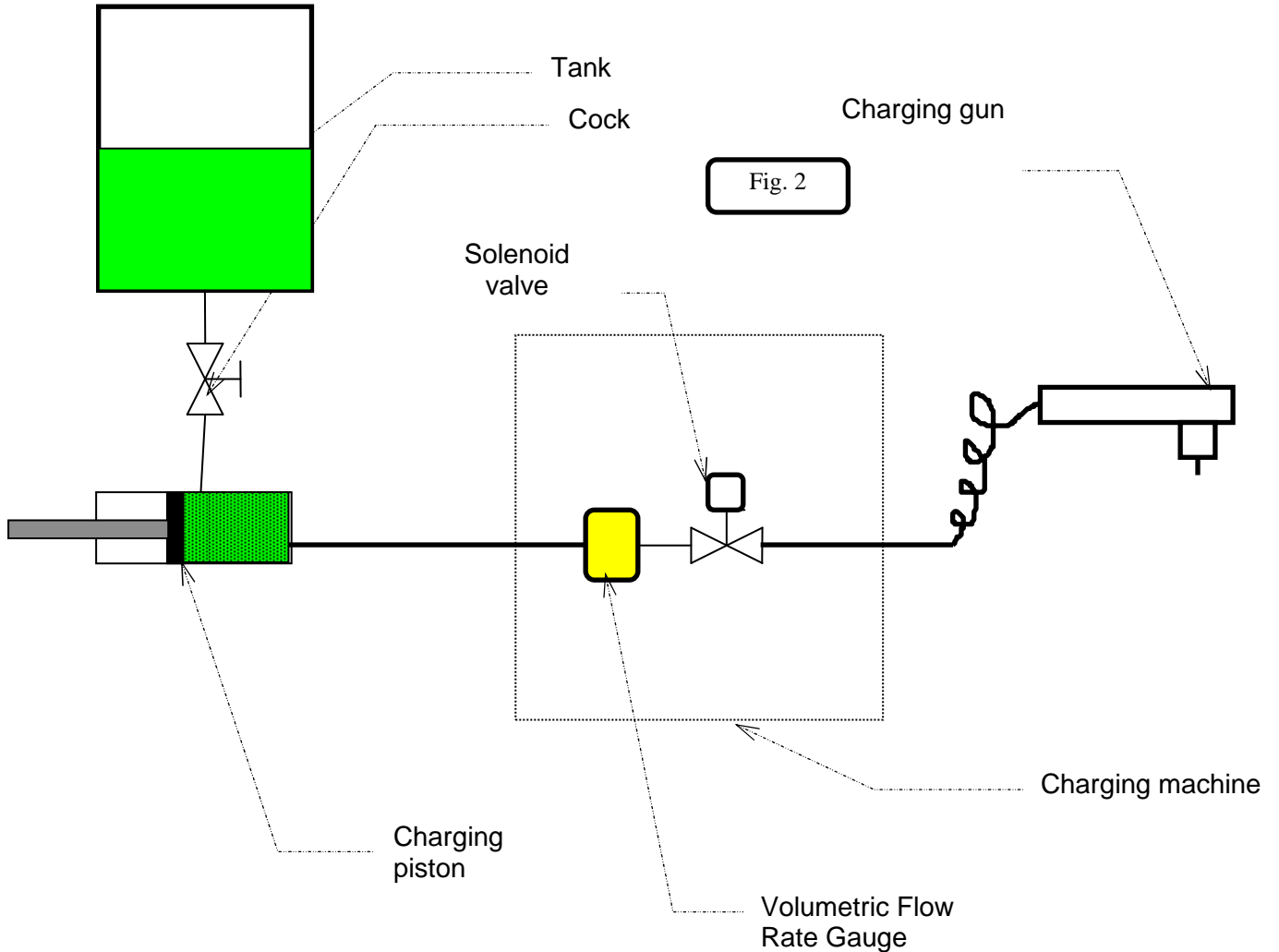

The charging piston compresses the refrigerant to a max P of 20 bar-r, thus favouring the re-condensation of any flash vapour that may have formed during transit through the line between the tank -cylinder: consider fig. 1) in which the saturated liquid (left-hand point on curve) undergoing slight pressure drops "enters" into the tank generating flash vapour and ultimately a liquid-vapour mixture.

Opening the solenoid valve of the charging machine allows the passage of refrigerant liquid toward the charging gun and flow is measured by the volumetric flow rate gauge; the quantity in weight is calculated by measuring the T of the liquid, calculating its density (tables) and multiplying this value by the volumetric flow rate.

Given the constant pressure in the charging machine cylinder, the flow rate of the refrigerant mainly depends on the cross section area of the charging nozzle and must be dimensioned so as to limit, in our case, the charging speed to 2 kg per minute.

3. Vacuum cycle

In general it is preferable to apply a “long” rather than “hard” vacuum: reaching low pressures too abruptly may in fact cause any trapped humidity to evaporate instantaneously, thereby freezing part of it.

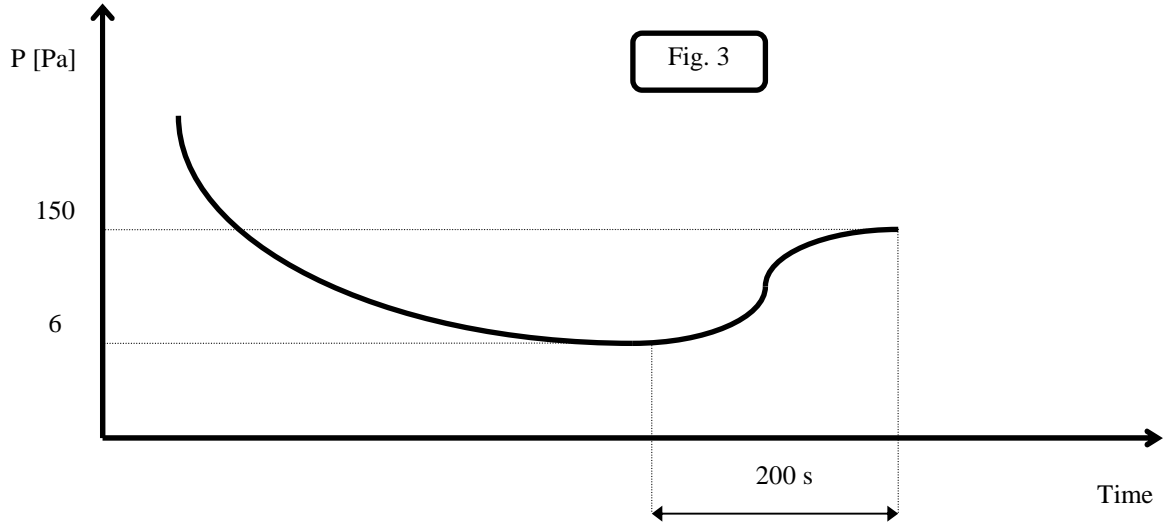

The figure represents a vacuum cycle and an optimal subsequent pressure rise for the refrigeration devices we manufacture.

As a rule, if there is suspicion of an extensive presence of humidity throughout the circuit or system as a whole, the vacuum must be “broken” with anhydrous nitrogen and then the steps must be repeated as described; this operation facilitates the removal of trapped and/or frozen humidity during the evacuation process.

4. Evacuating a circuit “contaminated” with refrigerant

The first step is to remove the refrigerant from the circuit using a specific machine with a dry compressor for recovering the refrigerant.

Refrigerants all tend to dissolve in oil [compressor sump] in percentages that are directly proportional to increases in pressure and decreases in the T of the oil itself - Charles' Law -

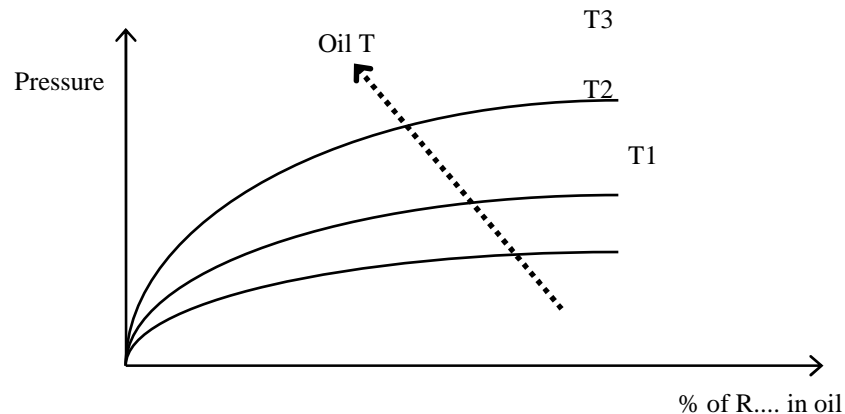

The release of refrigerant tends to cool the oil and thus actually serves to oppose the release itself: for this reason, it is advisable to switch on the crankcase heating elements, if available, during the evacuation process.

If a high % of refrigerant comes into contact with the Pirani gauge (vacuum sensor), it may “drug” the sensitive element of the latter, rendering it inefficient for a certain period of time. For this reason, if no machine for recovering refrigerant is available, it is nonetheless advisable to switch on the crankcase heating elements and avoid applying a vacuum until the circuit has been adequately purged of refrigerant: the refrigerant may in fact solubilise in the oil of the vacuum pump, undermining its performance for a long time (hours).

5. Charging positions [single point]

The best position for charging the air conditioners is the section between the thermostatic valve and the evaporator; care should be taken to avoid fixing the thermostat bulb until the operation is complete. This is important to ensure that the valve orifice remains open so as to allow the passage of refrigerant also toward the condenser/receiver.

Air-condensing water chillers should be charged with refrigerant in the section between the condenser and thermostatic valve, this favours flow into the larger-sized exchanger.

If possible, avoid the inflow of refrigerant into the compressor as this may cause excessive dilution of the lubricant; in any case, first check the compatibility between the crankcase capacity and the required charge volumes.

Safety valve drain pipes

A safety valve is present on the refrigerant circuit. Some regulations provide that the refrigerant drained from the valves be conveyed to the outside by means of a suitable pipe with a diameter at least matching that of the valve drainage outlet; the valve must not be made to bear the weight of the pipe.

The valves positioned on the compressor outlet only discharge hot saturated gas; those on the liquid receivers, may discharge saturated liquid and pose a greater hazard of burns due to the strong dehydrating effect caused by the sudden evaporation of refrigerant fluid in contact with bodies having a $T > -41\text{ }^{\circ}\text{C}$.



Warning: Always direct the drain pipe toward an area where the discharge cannot harm people.

ELECTRICAL CONNECTIONS

GENERALITIES



Before carrying out any job on electrical parts, make sure the power supply is disconnected.

Check that the mains electricity supply is compatible with the specifications (voltage, number of phases, frequency) shown on the unit rating plate.

The power connection for single-phase loads is to be made with a three-pole cable and "N" wire at the centre of the star [optional: power supply w/o neutral].



The size of the cable and line protections must conform to the specifications provided in the wiring diagram.

The supply voltage may not undergo fluctuations exceeding $\pm 5\%$ and the unbalance between phases must always be below 2%.



The above operating conditions must always be complied with: failure to ensure said conditions will result in the immediate invalidation of the warranty.

The electrical connections must be made in accordance with the information shown in the wiring diagram provided with the unit and current regulations.

An earth connection is **mandatory**. The installer must connect the earthing wire using the earthing terminal situated on the electric control board (yellow and green wire).

The power supply to the control circuit is shunted from the power line through an insulating transformer situated on the electric control board.

The control circuit is protected by suitable fuses or automatic breakers depending on the unit size.

Electrical connections of circulation pump

For all HWW units a clean contact is provided on the electric board for powering a low-voltage remote control used to start the pump.



If it is an integral part of the supply, the pump must be started before the chiller and stopped after the latter (minimum recommended delay: 60 seconds). If it is connected to the terminal in the electric control board, this function is carried out by the built-in microprocessor.

Remote controls

If you wish to include a remote control for switching the unit on and off, you must remove the bridge between the contacts indicated in the wiring diagram and connect the remote ON/OFF control to the terminals themselves [see annexed wiring diagram], then enable the "REMOTE" function by means of the switch provided in the electric board.

Summer Winter Remote Switching (Heat pump version)

If you wish to include a remote control for summer/winter switching of the unit, you must remove the bridge between the contacts indicated in the wiring diagram and connect the remote ON/OFF control to the terminals themselves [see annexed wiring diagram], then enable the "REMOTE" function by means of the switch provided in the electric board.

STARTING UP

Preliminary checks

- Check that the cocks of cooling circuit (if present) are open.
- Check that the electrical connections have been made properly and that all the terminals **are securely tightened**. This check should also be included in a periodic six-month inspection.
- Check that the voltage at the RST terminals is $400\text{ V} \pm 5\%$ and **make sure** the yellow indicator light of the phase sequence relay is on. The phase sequence relay is positioned on the electric control board; if the sequence is not duly observed, it will not enable the machine to start.
- Make sure there are no refrigerant leaks that may have been caused by accidental impacts during transport and/or installation.
- Check the power supply to the crankcase heating elements, where present.



The heating elements must be turned on at least 12 hours before the unit is started. This function is carried out automatically when the main switch is off. Their function is to raise the T of the oil in the sump and limit the quantity of refrigerant dissolved in it.

To verify whether the heating elements are working properly, check the lower part of the compressors: it should be warm or in any case at a temperature 10 - 15 °C higher than the ambient temperature.

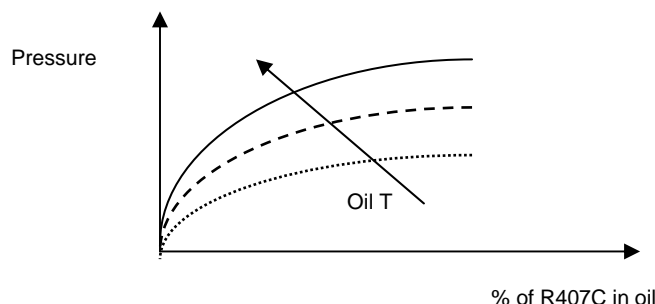



The diagram above illustrates a specific property [Charles' Law] of gases. which are more soluble in liquids as the pressure increases but less soluble as the temperature increases: if the oil in the sump is held at a constant pressure, an increase in oil temperature will significantly reduce the amount of refrigerant dissolved in it, thus ensuring that the lubricating function desired is maintained.

- Check that the plumbing connections have been properly made according to the indications given on the plates to be found on the unit itself (proper inlet and outlet connections).
- Make sure that the water circuit is duly bled to completely eliminate the presence of air: load the circuit gradually and open the air vent valves on the top part, which the installer should have set in place.



STARTING UP FOR THE FIRST TIME

HOW TO START UP THE Chillers OF THE HWW SERIES FOR THE FIRST TIME

Water connections

- Warning: the chiller is charged with HFC R407C – Group I EN 378 refrigerant (non-hazardous substances) conforming to the requirements of EEC regulation 2037/00.
- When making the plumbing connections, be sure to apply the inlet and outlet connections as indicated. In particular, be very careful **not** to invert condenser and evaporator circuits. Apply gate valves on the water side so that the chiller may be isolated from the plumbing system and install a mesh filter (accessible for inspection) on both the evaporator and condenser sides.
- Fill the water circuit, making sure to expel all the air present inside using the air valve situated on the external brass connections at the top right of the storage reservoir.

Electrical connections

- Put on the main switch, turn the ½-turn locking screws of the electric enclosure and open it.
- Introduce the power cable 400/3/50+N through the hole provided on the left side of the unit and secure it in place with the cable holder.
- Connect the power supply and earthing wire to the terminals of the main switch.
- Put off switch “QF” of the compressor so as to be sure it will not start running in the wrong direction in the case of a phase sequence error.
- Position the Local/Remote selector (SLR) situated at the top middle of the electric board on **LOCAL** and switch on the power by turning the main switch (IG) to ON.
- Check the phase sequence relay situated in the middle of the electric control board to make sure the phases are in the right sequence R-S-T; the **green** indicator light should go on: if it does not, disconnect the power supply to the unit from the external distribution board, invert two phases and repeat the check. **IN NO CASE SHOULD YOU TAMPER WITH THE WIRING DOWNSTREAM FROM THE MAIN SWITCH** since this may alter the correct sequence of other devices, e.g. pump(s).
- Put the compressor switch “QF” back on.
- Close the electric control board and lock it by means of the ½- turn locks.

Starting up

- Check that all external cocks of the water circuit are open and water flows properly (the flow alarm should not be triggered)
- Put the main switch on the ON position.
 - The [external] pump will start immediately.
 - After 60 seconds the compressor will start
- Check the water thermal differential (12-7°C to be detected by means of a thermometer on the inlet and outlet water pipes of the unit).
- Check that there are no leaks on the refrigerant side and water side.
- Using all the screws supplied, close the unit.

Use

- always consult the USER manual and the µChiller or pCO1 manual provided with the unit when undertaking maintenance and/or advanced set-ups.

STARTING OPERATION

Before starting the unit, turn the main switch on, select the operating mode desired from the control panel and press the "ON" button on the control panel.

The unit will start up if enabled:

- by the safety devices of the water circulation pump/s
- by the flow switch (or differential pressure switch)
- by the T sensor measuring the temperature of the water returning from the system [chiller inlet]
- and no alarms have been triggered

If the unit fails to start up, check whether the service thermostat has been set according to the nominal values provided.



You should not disconnect the unit from the power supply during periods when it is inoperative but only when it is to be taken out of service for a prolonged period (e.g. at the end of the season). To turn off the unit temporarily follow the directions provided in the section 4.5.

CHECKS DURING OPERATION

- Check the phase sequence relay on the control board to verify whether the phases occur in the correct sequence: if they do not, disconnect the unit from power supply and invert two phases of the incoming three-pole cable. **Never** attempt to modify internal electrical connections: any undue modifications will render the warranty null and void.
- Check that the temperature of the water entering the evaporator is close to the value set on the service thermostat.

CHECKING THE REFRIGERANT LEVEL

- After a few hours of operation, check whether the liquid level indicator has a green crown: a yellow colour indicates the presence of humidity in the circuit. In such a case the circuit must be dehumidified by qualified personnel.
- Large quantities of bubbles should not appear through the liquid level indicator. A constant passage of numerous bubbles may indicate that the refrigerant level is low and needs to be topped up. The presence of a few bubbles is however allowed, especially in the case of high-glide ternary mixtures such as HFC R407C.
- Also check that the end-of-evaporation temperature shown on the pressure gauge (refer to the pressure gauge scale for the refrigerant R407C, marked with the initials D.P. - Dew Point) is about 4°C lower than the temperature of the water leaving the evaporator.
- Make sure the overheating of the cooling fluid is limited to between 5 and 8 °C. To this end:
 - 1) read the temperature indicated by a contact thermometer placed on the compressor intake pipe;
 - 2) read the temperature indicated on the scale of a pressure gauge likewise connected to the intake side; refer to the pressure gauge scale for the refrigerant R407C, marked with the initials D.P. (Dew Point).The degree of overheating is given by the difference between the temperatures thus determined.

- Make sure that the undercooling of the cooling fluid is limited to between 3 and 5°C. To this end:
 - 1) read the temperature indicated by a contact thermometer placed on the condenser outlet pipe;
 - 2) read the temperature indicated on the scale of a pressure gauge connected to the liquid inlet at the condenser outlet; refer to the pressure gauge scale for the refrigerant R407C, marked with the initials B.P. (Bubble Point).The degree of undercooling is given by the difference between the temperatures thus determined.



Warning: all units of the HWW series are charged with R407C refrigerant except the versions with remote condenser which are charged with nitrogen. Any top-ups must be made using the same type of refrigerant. This operation is to be considered extraordinary maintenance work and must be performed by qualified personnel.
Warning: HWR units are pre-charged with anhydrous nitrogen and must be evacuated before charging with the refrigerant.



Warning: the refrigerant R407C requires "POE" polyolester oil of the type and viscosity indicated on the compressor rating plate.
For no reason should oil of a different type be introduced into the oil circuit.

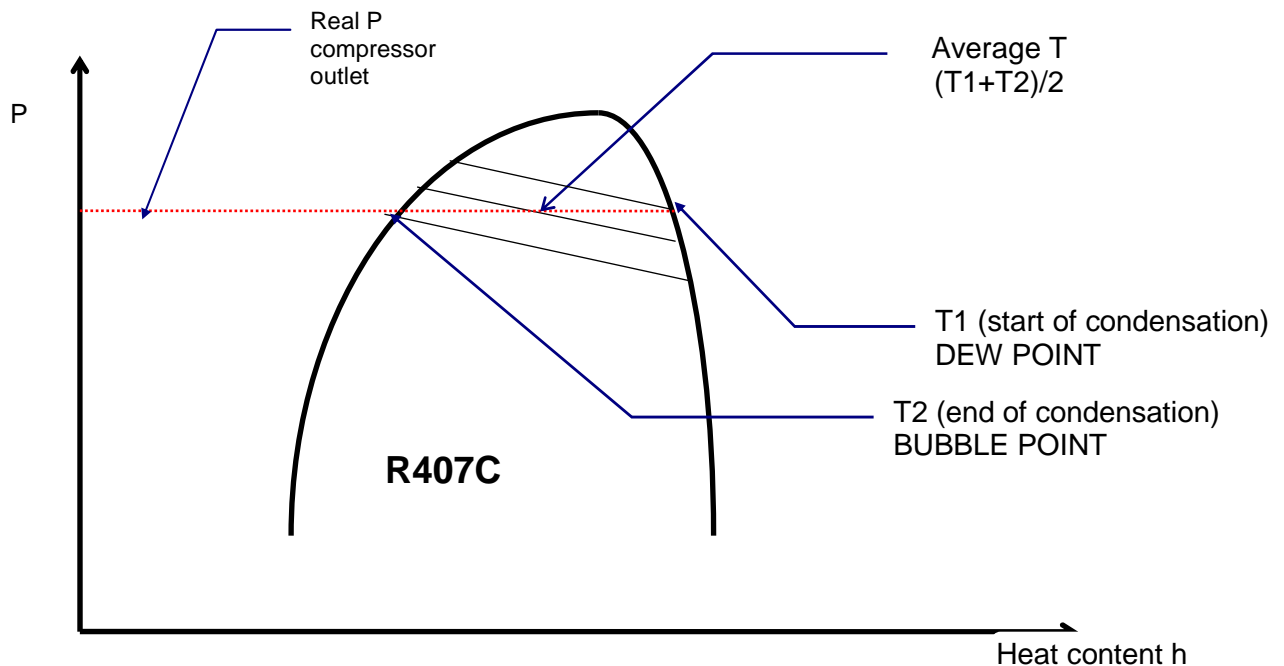

- The difference between the Dew Point and Bubble Point is known as "GLIDE" and this is a characteristic property of refrigerant mixtures. If pure fluids are used, the phase change occurs at a constant T and thus the glide is equal to zero.

STOPPING THE UNIT

To stop the unit press the "OFF" button on the front panel.



Warning: do not stop the unit using the main switch. The latter device is used to disconnect the unit from the electricity supply when there is no passage of current, i.e. when the unit is already turned OFF.

Moreover, if you completely disconnect the unit from the electricity supply, the crankcase heating elements (where present) will receive no power, thereby jeopardising the integrity of the compressor the next time the unit is started.



OPERATING LIMITS

Operating limits of HWW chillers in relation to the outlet water temperature and water dew point. Applications with water T above the specified limits require the use of R134a refrigerant fluid. For details please contact the local Lennox dealer.

❑ Cooling only Units

Water temperature	Minimum	Maximum	Notes
Evaporator inlet	10	25	Without antifreeze products Below 25°C the condensation pressure control is required
Condenser inlet	25	45	

❑ Heat pump units

Water temperature	Minimum	Maximum	Notes
Evaporator inlet (cooling mode)	10	25	Without antifreeze products Below 25°C the condensation pressure control is required
Condenser inlet (cooling mode)	25	45	
Evaporator inlet (*) (heating mode)	25	45	Without antifreeze products
Condenser inlet (*) (heating mode)	12	25	

(*) in heat pump operation heat exchangers work on reverse function.

❑ Cooling only units with remote condenser

Water temperature	Minimum	Maximum	Notes
Evaporator inlet	10	25	Without antifreeze products Below 40°C the condensation pressure control is required
Dew Point (°C)	40	65	

❑ Heat pump units with remote condenser

Water temperature	Minimum	Maximum	Notes
Evaporator inlet (cooling mode)	10	25	Without antifreeze products Below 40°C the condensation pressure control is required
Dew point (cooling mode)	40	65	
Evaporator inlet (*) (heating mode)	25	45	Without antifreeze products
Evaporation temperature (heating mode)	-15	15	

(*) in heat pump operation heat exchangers work on reverse function.



Glycol solutions

It is possible to produce water at temperatures below 5°C and as low as -10°C using glycol solutions that lower the freezing point according to the following table:

Minimum temperature of water produced	5 °C	2 °C	-1 °C	-5 °C	-10 °C
Percentage of ethylene glycol (in weight)	0 %	10 %	15 %	25 %	30 %
Freezing temperature of mixture °C	0 °C	-4 °C	-8 °C	-14 °C	-18 °C

Given an equal volumetric flow rate of water, pressure drops will depend on the percentage of glycol, as shown in the following table:

Percentage of ethylene glycol (in weight)	0 %	10 %	15 %	25 %	30 %
Pressure drop change	0 %	+12 %	+ 21 %	+43 %	+55 %

Operating limit table

- thermal carrier fluid water or water/antifreeze mixtures
- maximum water operating pressure 6 bars
- Maximum operating P – High pressure side = 28 bar-r
- Maximum operating T – High pressure side = 125°C
- Maximum operating T - indoor environment = 50°C
- Minimum operating T = -10°C
- Maximum operating P – Low pressure side = 22.6 bar-r
- Supply voltage +/- 10% of rating plate voltage
- Maximum stocking T = + 50 °C
- Minimum stocking T = - 10 °C (limit imposed by the built-in electronic components)

(*) this value can be reached only in storage conditions and determines the refrigerant saturation pressure of 22 bar-r on the low pressure side of the circuit, a value which in fact defines the limits.

Water flow to evaporator

The nominal flow rate is based on a thermal differential of 5°C between inlet and outlet water, in relation to the cooling capacity provided at the nominal water temperatures (12/7 °C).

The maximum allowed flow rate is associated with a thermal differential of 3 °C. Higher flow rate values cause too big pressure drops.

The minimum allowed flow rate is associated with a thermal differential of 8 °C. Lower flow rates could cause excessively low evaporation temperatures, which would trigger the safety devices and cause the unit to stop.

SETTING OPERATING PARAMETERS

GENERALITIES

All the control devices are set and tested in the factory before the unit is dispatched. However, after the unit has been in service for a reasonable period of time you can perform a check on the operating and safety devices. The settings are shown in Tables II and III.



All servicing of the equipment is to be considered extraordinary maintenance and may be carried out SOLELY BY QUALIFIED TECHNICIANS: incorrect settings may cause serious damage to the unit and injury to persons.

The operating parameters and control system settings configurable by means of the microprocessor control are password protected if they have a potential impact on the integrity of the unit.

TABLE II - SETTING OF CONTROL DEVICES

CONTROL DEVICE		SET POINT	DIFFERENTIAL
Service thermostat [Cooling]	°C	12	2
Service thermostat [H]	°C	40	2

TABLE III - SETTING OF SAFETY - CONTROL DEVICES

CONTROL DEVICE		ACTIVATION	DIFFERENTIAL	RESETTING
Antifreeze thermostat	°C	+4	2	Automatic
Maximum pressure switch IV PED	bars	28,0	4	Manual
High pressure relief valve IV PED	bars	29,0	-	-
Minimum pressure switch	bars	2	1.5	Automatic
Modulating condensation control device [optional]	bars	14	7	
Time lapse between two starts of the same compressor	s	360	-	-
Delay in flow switch alarm	s	20	-	-
Delay in low pressure alarm	s	120	-	-

MAXIMUM PRESSURE SWITCH

The high pressure switch stops the compressor when the outlet pressure exceeds the set value.



Warning: do not attempt to change the setting of the maximum pressure switch. Should the latter fail to trip in the event of a pressure increase, the pressure relief valve will open.

The high pressure switch must be **manually reset**; this is possible only when the pressure falls below the set differential (see Table III).

MINIMUM PRESSURE SWITCH

The low pressure switch stops the compressor when the intake pressure falls below the set value for more than 120 seconds.

The switch is automatically reset when the pressure rises above the set differential (see Table III).

SERVICE THERMOSTAT

This device permits to enable and disable the compressors' operation as a function of the reading of the inlet water temperature of the chilling unit [return from the system]. For further details, refer to the microprocessor control section in the manual.

ANTIFREEZE THERMOSTAT

The antifreeze probe is located at the evaporator outlet and stops the compressor when the temperature goes below the set limit value. Together with the flow switch and low pressure switch, this device protects the evaporator from the risk of freezing as a result of faults in the water circuit. For further details, refer to the microprocessor control section in the manual.

ANTI-RECYCLE TIMER

The function of the timer is to prevent excessively frequent compressor starts and stops. This device imposes a minimum time lapse of 480 seconds between two compressor starts. For further details, refer to the microprocessor control section in the manual.



Never attempt to change the delay set in the factory: wrong settings could cause serious damage to the unit.

MAINTENANCE

The only tasks to be performed by the end user are turning the chillers on and off and switching them between the cooling and heating functions as the seasons change.

All other operations are to be considered maintenance work and must thus be carried out by qualified personnel trained to do their job in observance of current laws and regulations.

WARNINGS



All the operations described in this chapter MUST ALWAYS BE PERFORMED BY QUALIFIED PERSONNEL.



Before carrying out any work on the unit or accessing internal parts, make sure you have disconnected it from the mains electricity supply.



The upper part and the outlet pipe of the compressor reach high temperatures. Be especially careful when working in the surrounding area with the panels off.



Be especially careful when working in proximity to finned coils of HWRC and HWRH units since the 0.11 mm-thick aluminium fins can cause superficial injuries due to cuts.



After completing maintenance jobs, always replace the panels enclosing the units and secure them with the fastening screws provided.

Generalities

To guarantee a constantly satisfactory performance over time, it is advisable to carry out routine maintenance and checks as described below.

Operations	Frequency
• Check the efficiency of all the control and safety devices	Once a year
• Check the terminals on the electric control board and compressor terminal boards to ensure that they are securely tightened. The movable and fixed contacts of the circuit breakers must be periodically cleaned and replaced whenever they show signs of deterioration.	Once a year
• Check the refrigerant level by means of the liquid level indicator	Every 6 months
• Check the oil levels through the windows provided on the compressor crankcases	Every 6 months
• Check the water circuit for leaks	Every 6 months
• If the unit is to remain out of service for a long time, drain the water from the pipes and heat exchanger. This is indispensable if during the period of quiescence the ambient temperature is expected to fall below the freezing point of the fluid used	Every 6 months
• Check whether the water in the circuit needs to be replenished.	Every 6 months
• Check the efficiency of the flow switch or differential pressure switch	Every 6 months
• Clean the metal mesh filters mounted externally on the water pipes.	First start-up
• Check the humidity indicator (green=dry, yellow=humid) on the liquid level indicator; if the indicator is not green as shown on the indicator sticker, replace the filter	Every 6 months

Repairing the Cooling Circuit



Warning: while performing repairs on the cooling circuit or maintenance work on the compressors, make sure the circuit is left open for as little time as possible. Even if briefly exposed to air, ester oils tend to absorb large amounts of humidity, which results in the formation of weak acids.

If the cooling circuit has undergone any repairs, the following operations must be carried out:

- tightness test;
- emptying and drying of the cooling circuit;
- charging with refrigerant.



If the system has to be drained, always recover the refrigerant present in the circuit using suitable equipment; the refrigerant should be handled exclusively in the liquid phase.

Tightness test

Fill the circuit with anhydrous nitrogen supplied from a tank with a pressure-reducing valve until the pressure rises to 22 bars.



During the pressurisation phase, do not exceed a pressure of 22 bars-r on the low pressure side

The presence of any leaks must be determined using special leak detectors. Should any leaks be detected during the test, empty out the circuit before repairing the leaks with suitable alloys.



Do not use oxygen in the place of nitrogen as a test agent, since this would cause a risk of explosion.

Hard Vacuum and Drying of Cooling Circuit

To achieve a hard vacuum in the cooling circuit it is necessary to use a pump capable of generating a high degree of vacuum, i.e. 150 Pa of absolute pressure with a capacity of approximately 10 m³/h. If such a pump is available, one evacuation will normally suffice to achieve an absolute pressure of 150 Pa.

If there is no such vacuum pump available, or whenever the circuit has remained open for long periods of time, you are strongly recommended to adopt the triple evacuation method. This method is also recommended when there is a presence of humidity within the circuit.

The vacuum pump should be connected to the inlets.

The procedure to be carried out is as follows:

- Evacuate the circuit until you reach an absolute pressure of at least 350 Pa. At this point inject nitrogen into the circuit until you reach a relative pressure of about 1 bar.
- Repeat the step described above.
- Carry out the step described above for the third time, but in this case attempting to reach the hardest vacuum possible.

Using this procedure you can easily remove up to 99% of pollutants.

Recharging with refrigerant R407C

- Connect the tank of refrigerant gas to the male 1/4 SAE inlet situated on the liquid line after discharging a little gas to eliminate air in the connection pipe.
- **Fill with refrigerant in liquid form** until you reach 75% of the total charge.
- Then connect to the inlet on the pipe between the thermostatic valve and evaporator and complete the charging process with the refrigerant **in liquid form** until no more bubbles can be seen on the liquid level indicator and the operating parameters specified in this manual have been reached.



Since R407C is a ternary mixture, charging must take place exclusively with liquid refrigerant to ensure the correct percentages of the three constituents. Introduce refrigerant through the inlet in the liquid line.



A unit that was originally charged with R407C in the factory cannot be charged with R22 or other refrigerants without the written authorisation of Lennox S.p.A.

Environmental protection

The law implementing the regulations [reg. EEC 2037/00] which govern the use of ozone-depleting substances and greenhouse gases bans the dispersal of refrigerant gases in the environment and requires whoever is in their possession to recover them and, at the end of their useful life, either to return them to the dealer or take them to a suitable waste disposal facility.

The refrigerant HFC R407C is not harmful to the ozone layer but is included among the substances responsible for the greenhouse effect and thus falls within the scope of the aforesaid regulations.



Therefore, special care should be taken when carrying out maintenance work to minimise refrigerant leaks.

TROUBLESHOOTING

On the next pages you will find a list of the most common causes that may cause the chilling unit to fail or malfunction. These causes are broken down according to easily identifiable symptoms.



You should be extremely careful when attempting to implement any of the possible remedies suggested: overconfidence can result in injuries, even serious ones, to inexperienced individuals. Therefore, once the cause has been identified, you are advised to contact the manufacturer or a qualified technician for help.

FAULT	Possible causes	Corrective actions
The unit does not start.	<p>No power supply.</p> <p>The electronic card is cut off from the power supply.</p> <p>Alarms have been triggered.</p> <p>The phase sequence is wrong.</p>	<p>Check that power is being supplied both to the primary and auxiliary circuits.</p> <p>Check the fuses.</p> <p>Check whether any alarms are signalled on the microprocessor control panel, eliminate the causes and restart the unit.</p> <p>Invert two phases in the primary power line after disconnecting them upstream from the unit.</p>
The compressor is noisy.	<p>The compressor is rotating in the wrong direction.</p>	<p>Check the phase sequence relay. Invert the phases on the terminal board after disconnecting the unit and contact the manufacturer.</p>
Presence of abnormally high pressure.	<p>Insufficient flow of water to the condenser.</p> <p>Presence of air in the refrigerant circuit, as revealed by the presence of bubbles in the flow indicator also with undercooling values exceeding 5 °C.</p>	<p>Check for any clogging in the water circuit.</p> <p>Check the compressor inlet water T.</p> <p>Check the condensation control device. [optional]</p> <p>Drain and pressurise the circuit and check for leaks. Evacuate slowly for more than 3 hours until reaching a pressure of 0.1 mBar and then recharge in the liquid phase.</p>
Presence of abnormally high pressure.	<p>Unit overcharged, as revealed by an undercooling of more than 8 °C.</p> <p>Thermostatic valve and/or filter obstructed. These symptoms may also occur in the presence of an abnormally low pressure.</p> <p>Insufficient flow of water in the case of heat pump operation.</p>	<p>Drain the circuit.</p> <p>Check the temperatures upstream and downstream from the valve and filter and replace them if necessary.</p> <p>Check the water circuit for pressure drops and/or whether the pump is working properly [direction of rotation]. Check the outgoing water T and make sure it is less than or equal to 50°C.</p>



FAULT	Possible causes	Corrective actions
Low condensation pressure.	Transducer fault. Water T too low.	Check the setting of the condensation control device [optional]. Install the condensation control device.
Low evaporation pressure.	Insufficient flow of water. Malfunctioning of thermostatic valve. Filter clogged. Low condensation T. Low level of refrigerant.	Check whether the pumps are rotating in the right direction. Check the water system for pressure drops. Warming the bulb with your hand, check whether the valve opens and adjust it if necessary. If it does not respond, replace it. Pressure drops upstream and downstream from the filter should not exceed 2°C. If they do, replace the filter. Check the efficiency of the condensation control device [where present]. Check the refrigerant level by measuring the degree of undercooling; if it is below 2°C replenish the charge.
The compressor does not start.	The internal thermal protection device has tripped. The circuit breakers or line fuses have been tripped by a short circuit. One of the high or low pressure switches has tripped. The phases have been inverted in the distribution compartment.	In the case of compressors equipped with a protection module, check the thermal contact. Identify the causes after restarting. Pinpoint the cause by measuring the resistance of the individual windings and the insulation from the casing before restoring power. Check on the microprocessor, eliminate the causes. Check the phase sequence relay, then invert the phases upstream from the main switch.
High evaporation pressure.	Water T too high.	Check the thermal load and/or efficiency of the thermostat function. Check the efficiency of the thermostatic valve.



Technical data

Performance data – cooling models HWW-C

Model	HWWC055	HWWC060	HWWC070	HWWC080	HWWC090	HWWC105	HWWC115
Refrigerant	R407C	R407C	R407C	R407C	R407C	R407C	R407C
Cooling capacity at 7 ¹² ° - 15°C [kW]	53.9	59.8	68.7	81.5	89.8	103.0	121.2
Heating capacity- Heat recovery (optional) at 40-45°C [kW]	18	20.5	23.6	27.5	30.4	34.5	40.7
Pressure drop- water side. Heat recovery [kPa]	12	12	16	13	15	16.5	19
Rated input power [kW]	12.0	14.6	15.7	18.4	22.3	25.4	30.2
Rated current absorption [A]	26.2	30.4	35.2	38.7	41.7	49.3	55.4
Maximum current absorption [A]	50.5	62.5	70.2	76.2	76.2	93	108
Inrush current [A]	146	152	198	203	206	247	252
Evaporator water flow rate [l/h]	9282	10295	11810	14015	15441	17715	20841
Pressure drop – evaporator side [kPa]	48.4	48.4	48.4	47.1	41.7	32.3	39.0
Condenser water flow rate (1) [l/h]	3588.5	4049.2	4587.5	5430.1	6098.5	6984.4	8236.2
Pressure drop – condenser side [kPa]	20	25	13	18	23	22	25
Additional pressure drop for condensation control (optional) [kPa]	14	18	24	20	24	12	15
Compressor type [-]	Scroll	Scroll	Scroll	Scroll	Scroll	Scroll	Scroll
Number of cooling circuits [-]	2	2	2	2	2	2	2
Number of compressors [-]	2	2	2	2	2	2	2
Oil charge/ compressor [dm ³]	3.3	3.3	4.1	4.1	6.5	8	8
Evaporator [type]	BPHE	BPHE	BPHE	BPHE	BPHE	BPHE	BPHE
Number of evaporators	2	2	2	2	2	1	1
Condensers [type]	BPHE	BPHE	BPHE	BPHE	BPHE	BPHE	BPHE
Number of condensers	2	2	2	2	2	1	1
Water content in user section [dm ³]	5.5	6.1	6.6	7.1	7.9	8.2	8.8
Type of water connections	GAS	GAS	GAS	GAS	GAS	GAS	GAS
Size of water connections	2"	2"	2"	2"	2"	2"	2"

(1) Municipal Water at 15°C



Technical data

Performance data – cooling models HWW-C

Model	HWWC130	HWWC150	HWWC180	HWWC205	HWWC235	HWWC250	HWWC275	HWWC300
Refrigerant	R407C	R407C	R407C	R407C	R407C	R407C	R407C	R407C
Cooling capacity at 7°/12°-15°C [kW]	137.3	150.7	172.9	209.6	236.7	253.9	273.5	296.1
Heating capacity- Heat recovery (optional) at 40-45°C [kW]	45.8	55.2	57.2	69.5	78.2	83.6	91.2	91.2
Pressure drop- water side. Heat recovery [kPa]	14	17	15	23	30	34	40	40
Rated input power [kW]	34.2	37.6	44.1	53.4	59.8	65.3	69.1	74.8
Rated current absorption [A]	58.7	64.1	78.5	91.6	104.0	112.4	117.8	126.8
Maximum current absorption [A]	123.2	141.2	144.2	165.6	205.6	228	246	260
Inrush current [A]	307	325.3	248	301	318	377	384	384
Evaporator water flow rate [l/h]	23622	25952	29744	36065	40708	43670	47046	50931
Pressure drop – evaporator side [kPa]	41.7	43.1	53.8	37.7	35.0	36.3	40.4	40.4
Condenser water flow rate (1) [l/h]	9331.8	10251.6	11803.7	14313.4	16128.3	17359.8	18633.9	20174.9
Pressure drop – condenser side [kPa]	19	23	28	15	17	21	25	25
Additional pressure drop for condensation control (optional) [kPa]	17	21	18	21	12	15	17	17
Compressor type [-]	Scroll	Scroll	Scroll	Scroll	Scroll	Scroll	Scroll	Scroll
Number of cooling circuits [-]	2	2	2	2	2	2	2	2
Number of compressors [-]	2	2	4	4	4	4	4	4
Oil charge/ compressor [dm ³]	8	8	8	8	8	8	8	8
Evaporator [type]	BPHE	BPHE	BPHE	BPHE	BPHE	BPHE	BPHE	BPHE
Number of evaporators	1	1	1	1	1	1	1	1
Condensers [type]	BPHE	BPHE	BPHE	BPHE	BPHE	BPHE	BPHE	BPHE
Number of condensers	1	1	1	1	1	1	1	1
Water content in user section [dm ³]	9.5	10.5	10.5	11.5	12.4	12.4	13.6	14.4
Type of water connections	Victaulic	Victaulic	Victaulic	Victaulic	Victaulic	Victaulic	Victaulic	Victaulic
Size of water connections	3"	3"	3"	4"	4"	4"	4"	4"
(1) Municipal Water at 15°C								



Technical data

Performance data – heat pump models HWW-H

Model	HWWH055	HWWH060	HWWH070	HWWH080	HWWH090	HWWH105	HWWH115
Refrigerant	R407C	R407C	R407C	R407C	R407C	R407C	R407C
Cooling capacity (1) [kW]	53	57.2	65.5	79.4	87.4	100.2	116.8
Heating capacity (2)	58.6	63.4	71.8	88.3	97.5	110.8	128.5
Rated electrical input [kW]	11.8	14.3	15.2	18.2	21.9	25.1	29.7
Rated current absorption [A]	25.9	29.6	34.5	38.2	41.3	48.8	54.9
Maximum current absorption [A]	50.5	62.5	70.2	76.2	76.2	93	108
Inrush current [A]	146	152	198	203	206	247	252
Evaporator water flow rate [l/h]	9120	9843	11269	13653	15044	17247	20101
Pressure drop – evaporator side [kPa]	48.4	48.4	48.4	47.1	41.7	32.3	39
Condenser water flow rate (1) [l/h]	5307.1	5855.3	6608.2	7988.5	8953.0	10263.7	20101
Pressure drop – condenser side [kPa]	45	56.25	29.25	40.5	51.75	49.5	56.25
Additional pressure drop for condensation control (optional) [kPa]	31,5	40,5	54	45	54	27	33,75
Compressor type [-]	Scroll	Scroll	Scroll	Scroll	Scroll	Scroll	Scroll
Number of cooling circuits [-]	2	2	2	2	2	2	2
Number of compressors [-]	2	2	2	2	2	2	2
Oil charge/ compressor [dm ³]	3,3	3,3	4,1	4,1	6,5	8	8
Evaporator [type]	BPHE	BPHE	BPHE	BPHE	BPHE	BPHE	BPHE
Number of evaporators	2	2	2	2	2	1	1
Condensers [type]	BPHE	BPHE	BPHE	BPHE	BPHE	BPHE	BPHE
Number of condensers	2	2	2	2	2	1	1
Water content in user section [dm ³]	5.5	6.1	6.6	7.1	7.9	8.02	8.08
Type of water connections	GAS	GAS	GAS	GAS	GAS	GAS	GAS
Size of water connections	2"	2"	2"	2"	2"	2"	2"
(1) Municipal Water at 15°C							



Technical data

Performance data – heat pump models HWW-H

Model	HWWH130	HWWH150	HWWH180	HWWH205	HWWH235	HWWH250	HWWH275	HWWH300
Refrigerant	R407C	R407C	R407C	R407C	R407C	R407C	R407C	R407C
Cooling capacity (1) [kW]	134.6	147.8	169.4	205.4	231.9	248.9	268.1	290.2
Heating capacity (2)	148.7	163.4	187.2	227.0	256.2	274.9	296.1	320.6
Rated electrical input [kW]	34.1	37.6	44.2	53.4	60.1	65.4	69.3	74.9
Rated current absorption [A]	58.7	64.1	78.5	91.6	104.1	112.4	117.9	126.9
Maximum current absorption [A]	123.2	141.2	144.2	165.6	205.6	228	246	260
Inrush current [A]	307	325.3	248	301	318	377	384	384
Evaporator water flow rate [l/h]	23151	25428	29149	35344	39894	42803	46108	49920
Pressure drop – evaporator side [kPa]	41.7	43.1	53.8	37.7	35	36.3	40.4	40.4
Condenser water flow rate (1) [l/h]	13810	15183	17492	21193	23907	25722	27617	29886
Pressure drop – condenser side [kPa]	41.6	50.4	61.5	32.9	37.4	46.1	54.9	54.9
Additional pressure drop for condensation control (optional) [kPa]	37.2	46.1	39.5	46.0	26.4	32.9	37.3	37.3
Compressor type [-]	Scroll	Scroll	Scroll	Scroll	Scroll	Scroll	Scroll	Scroll
Number of cooling circuits [-]	2	2	2	2	2	2	2	2
Number of compressors [-]	2	2	4	4	4	4	4	4
Oil charge/ compressor [dm ³]	8	8	8	8	8	8	8	8
Evaporator [type]	BPHE	BPHE	BPHE	BPHE	BPHE	BPHE	BPHE	BPHE
Number of evaporators	1	1	1	1	1	1	1	1
Condensers [type]	BPHE	BPHE	BPHE	BPHE	BPHE	BPHE	BPHE	BPHE
Number of condensers	1	1	1	1	1	1	1	1
Water content in user section [dm ³]	9.05	10.05	10.05	11.05	12.04	12.04	13.06	14.04
Type of water connections	Victaulic	Victaulic	Victaulic	Victaulic	Victaulic	Victaulic	Victaulic	Victaulic
Size of water connections	3"	3"	3"	4"	4"	4"	4"	4"
(1) Municipal Water at 15°C								



Technical data

Performance data – models with remote condenser HWR

Model	HWR055	HWR060	HWR070	HWR080	HWR090	HWR105	HWR115
Refrigerant	R407C	R407C	R407C	R407C	R407C	R407C	R407C
Cooling capacity (1) [kW]	46.2	51.2	58.8	69.8	76.9	88.2	103.7
Power to unload to the condenser [kW]	59.0	67.0	75.6	89.4	101.1	115.7	136.6
Input power (1) [kW]	15.8	19.2	20.6	24.2	29.4	33.4	39.8
Current absorption (1) [A]	34	39.5	45.7	50.2	54.1	64	72
Maximum current [A]	50.5	62.5	70.2	76.2	76.2	93	108
Inrush current [A]	146	152	198	203	206	247	252
Water flow rate [l/h]	7947	8813	10113	11991	13220	15170	17843
Pressure drop – evaporator side [kPa]	36	36	36	35	31	24	29
Compressor type [-]	Scroll	Scroll	Scroll	Scroll	Scroll	Scroll	Scroll
Number of cooling circuits [-]	2	2	2	2	2	2	2
Number of compressors [-]	2	2	2	2	2	2	2
Oil charge/ compressor [dm ³]	3.3	3.3	4.1	4.1	6.5	8	8
Evaporator [type]	BPHE	BPHE	BPHE	BPHE	BPHE	BPHE	BPHE
Number of evaporators	2	2	2	2	2	1	1
Water content [dm ³]	5.5	6.1	6.6	7.1	7.9	32	33.5
Type of refrigerating circuit connections	RTK	RTK	RTK	RTK	RTK	RTK	RTK
Type of water connections	GAS	GAS	GAS	GAS	GAS	GAS	GAS
Size of water connections	2"	2"	2"	2"	2"	2"	2"
Remote condenser – Standard model							
Power supply	SHVN 61 V 230V/1Ph/- 50Hz	SHVN 73 V 230V/1Ph/- 50Hz	SHVN 79 V 230V/1Ph/- 50Hz	SHVN 94 V 230V/1Ph/- 50Hz	SHVN 106 V 230V/1Ph/- 50Hz	SHVN 122 V 230V/1Ph/- 50Hz	SHVN 147 V 230V/1Ph/- 50Hz
Lp at 10 m free field [dB-A]	56	55	58	58	59	59	58
Remote condenser – Silenced model							
Power supply	SHVN 70 V 230V/1Ph/- 50Hz	SHVN 72 V 230V/1Ph/- 50Hz	SHVN 87 V 230V/1Ph/- 50Hz	SHVN 97 V 230V/1Ph/- 50Hz	SHVN 111 V 230V/1Ph/- 50Hz	SHVN 117 V 230V/1Ph/- 50Hz	SHVS 141 H/V 230V/1Ph/- 50Hz
Lp at 10 m free field	46	46	47	47	48	48	49

RTK Rotalock weld-on connection with stub pipe for lines made on site.
(1) at 7/12 °C water T – 35 °C Air Temperature



Technical data

Performance data – models with remote condenser HWR

Model	HWR130	HWR150	HWR180	HWR205	HWR235	HWR250	HWR275	HWR300
Refrigerant	R407C	R407C	R407C	R407C	R407C	R407C	R407C	R407C
Cooling capacity (1) [kW]	117.6	129.2	148.1	179.6	202.6	217.4	234.1	257.3
Power to unload to the condenser [kW]	154.8	170.0	196.1	237.8	267.8	288.6	309.4	339.9
Input power (1) [kW]	45	49.5	58	70.3	78.7	85.9	90.9	99.9
Current absorption (1) [A]	76.2	83.2	102	119	135	146	153	168.1
Maximum current [A]	123.2	141.2	144.2	165.6	205.6	228	246	282
Inrush current [A]	307	325.3	248	301	318	377	384	384
Water flow rate [l/h]	20228	22214	25465	30890	34856	37385	40274	44247
Pressure drop – evaporator side [kPa]	31	32	40	28	26	27	30	30
Compressor type [-]	Scroll	Scroll	Scroll	Scroll	Scroll	Scroll	Scroll	Scroll
Number of cooling circuits [-]	2	2	2	2	2	2	2	2
Number of compressors [-]	2	2	4	4	4	4	4	4
Oil charge/ compressor [dm ³]	8	8	8	8	8	8	8	8
Evaporator [type]	BPHE	BPHE	BPHE	BPHE	BPHE	BPHE	BPHE	BPHE
Number of evaporators	1	1	1	1	1	1	1	1
Water content [dm ³]	34.1	36.2	38.1	67.8	70.6	73.5	73.5	73.5
Type of refrigerating circuit connections	RTK	RTK	RTK	RTK	RTK	RTK	RTK	RTK
Type of water connections	Victaulic	Victaulic	Victaulic	Victaulic	Victaulic	Victaulic	Victaulic	Victaulic
Size of water connections	3"	3"	3"	4"	4"	4"	4"	4"
Remote condenser – Standard model	SHVN 158 H/V	SHVN 186 H/V	SHVN 212 H/V	SHVN 244 H/V	SHVN 265 H/V	SHVN 310 H/V	SHVN 335 H/V	SHVN 380 H/V
Power supply	230V/1Ph/-50Hz	230V/1Ph/-50Hz	230V/1Ph/-50Hz	230V/1Ph/-50Hz	230V/1Ph/-50Hz	230V/1Ph/-50Hz	400V-3PH-50Hz	400V-3PH-50Hz
Lp at 10 m free field [dB-A]	61	61	62	62	63	63	61	61
Remote condenser – Silenced model	SHVS 173 H/V	SHVS 173 H/V	SHVS 213 H/V	SHVS 235 H/V	SHVS 271 H/V	SHVS 301 H/V	SHVS 324 H/V	SHVS 360 H/V
Power supply [dB-A]	230V/1Ph/-50Hz	230V/1Ph/-50Hz	230V/1Ph/-50Hz	230V/1Ph/-50Hz	400V-3PH-50Hz	400V-3PH-50Hz	400V-3PH-50Hz	400V-3PH-50Hz
Lp at 10 m free field	50	50	51	51	54	54	55	55

RTK Rotalock weld-on connection with stub pipe for lines made on site.
 (1) at 7/12 °C water T – 35 °C Air Temperature





