

User manual

CLIMATIC™ 200/400 - Controller



- Providing indoor climate comfort



CONTENTS	PAGE
• INDEX	1
• GENERAL DESCRIPTION	2
• THE KEYPAD, Climatic® 200	3
• THE KEYPAD, Climatic® 400	4
• THE KEYPAD REMOTE CONTROLLER (OPTION), RC Climatic® 200	5
• THE KEYPAD REMOTE CONTROLLER (OPTION), RC Climatic® 400	6
• FUNCTION	7
UNIT COMMISSIONING	
SELECTING OPERATING MODE	
SELECTING SET POINT	
• MENU MODE	8
• ADJUSTING WATER TEMPERATURE (SET POINT)	9
• ANALOGUE INPUTS, TEMPERATURE PROBES	10
• OPTIONS	11-12
• MODIFY UNIT PARAMETERS	13-14
• OPERATING HOURS	15
• ALARM CODES	16-18
• DEFROSTING SYSTEM	19
• FAN SPEED CONTROL (only for 0091 to 0812 units)	20
• FAN FUNCTIONING CONTROL (only for 1003 to 1303 units)	20
• SAFETY DEVICES	21

GENERAL DESCRIPTION

This equipment is an electronic device that controls packaged water cooling systems via air and reversible air/water heat pumps.

The thermostat allows the following operations:

- Unit ON/OFF.
- Select system operating mode.
- Set point adjustment.
- Alarm signal relay.
- Display temperature.
- Status of the unit alarms.
- Possibility of remote ON/OFF.
- A remote controller as an option.

REGULATION:

The control makes the system regulation as follow:

- Receives the signals of analogue inputs through the inlet and outlet probe temperature values and from the refrigerant piping probe temperature (two for model Climatic® 400).
- Receives digital inputs through the status of low, high and end defrost pressure switches, flow switch (water flow) status and from electrical protection of fan and compressor.

According to the values and status of analogue and digital inputs manages: the output signals; compressor, fan and status of water pump operating, obtaining the regulation of the inlet water temperature to the unit, regulating the speed of the air fan volume, activating the defrost cycle (heat pump units only); output signals water exchange heater, water tank heater, and hot gas valve (all these elements are an option) used to protect the unit, and also activates the alarm codes about, setting pressure switches, flow switch, water flow, and the electrical protection of fan and compressor (see alarm section).

- A group of parameters let the control be programmed for each application.

The control incorporated in the unit contains the following devices:

MODEL Climatic® 200 (1 circuit unit model EAC 0091 to 0812 and EAR 0091 to 0431)

- Keypad:

Located in the unit.

The keypad provides control of the system.

- Fan Control Plate:

Located at the electrical box.

Allows the fan speed to be varied with respect to the condensing temperature (only for EAC 0091 to 0812 units and EAR 0091 to 0431 units).

Keypad located in the unit

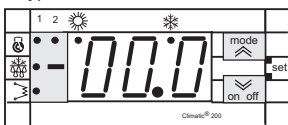

Fan control plate

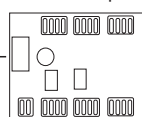

MODEL Climatic® 400 (2 circuit unit model EAC 1003 to 1303 and EAR 0472 to 1303)

- Keypad:

Located in the unit.

- Control Module:

Located at the electrical box.

This device controls the operation of the unit, allowing the regulation of the system.

- Fan Control Plate:

Located at the electrical box.

Allows the fan speed to be varied with respect to the condensing temperature (only for EAR 0472 to 0812 units).

Keypad located in the unit

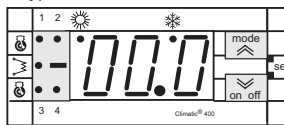

Control Module

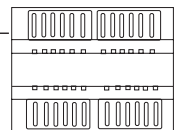

Fan control plate

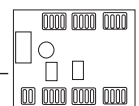

OPTION

A remote controller is offered as an option.

To install this optional remote controller proceed as follow:

- Connect exactly as indicated in electrical diagram.
- The wire should not exceed 50 m.

The three cables for connection from the keypad to the power board must be kept separate from other cables, using an individual cable channel; and use shielded cables, with a cross-section of 1 mm².

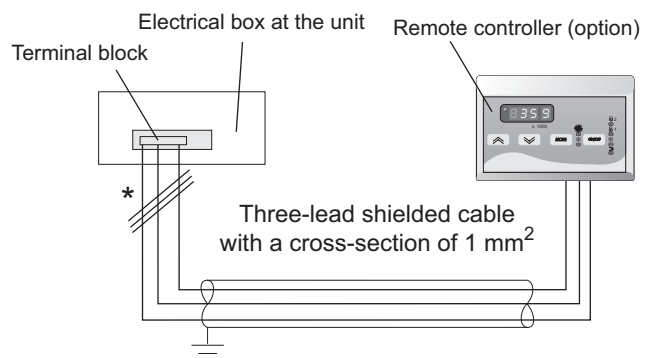

*Connection to be made by customer
MAXIMUM LENGTH 50m

THE KEYPAD INCORPORATED AT THE UNIT, MODEL Climatic® 200

READING DISPLAY

This is a 3-digit display, the inlet water temperature is shown in degrees (default), °C (when shows decimal point). The following can also be displayed:

- Values of all parameters controlled by the equipment:
 - Cooling set point, cooling differential temperature.
 - Heating set point (heat pump units) and heating differential temperature.
 - Outlet water temperature (as security).
 - Inlet water temperature (regulation).
 - Piping temperature.
- Alarm codes.
- The status of all machine functions (operating hours, delay time etc).

COMPRESSOR LED

When this LED is continually lit, it indicates that the compressor is operating (in heating or cooling mode, depending on the operating mode selected); however, when it flashes, this indicates that pausing is taking place, delaying the compressor start.

- LED 1: Compressor 1 circuit 1
- LED 2: Compressor 2 circuit 1

MODE / UP BUTTON

Selects the operating mode between the following:
Stand-by / Cool / Heat
In menu mode, this button acts as a scroll up or up key (increasing value).

HEATING MODE LED

When this LED is continually lit it indicates that the unit is operating in heating mode.

COOLING MODE LED

When this LED is continually lit it indicates that the unit is operating in cooling mode.

COOLING MODE LED / HEATING MODE LED

When none of these two leds COOLING/HEATING are lit, it indicates that the operating mode selected is STAND-BY.

DEFROST LED

LED ON: The defrosting is in progress.
LED OFF: If defrosting is disabled or has been completed.
LED BLINK: If timing is in progress (defrost interval).

MODE - ON / OFF BUTTON

Pressing both buttons at the same time, gets to the menu level.
They also move one level up or down in the menu.

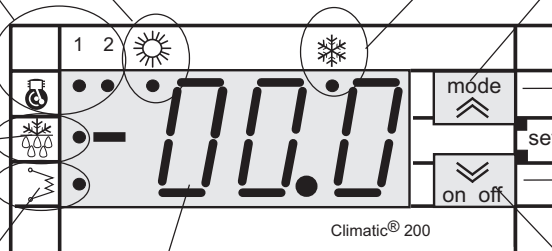

READING DISPLAY

ELECTRICAL HEATER LED

When this LED is continually lit it indicates that the internal anti-freeze electrical heater is on; if the led is off, the internal anti-freeze is off.

ON - OFF / DOWN BUTTON

Turn the unit ON and OFF. Press also once to reset all manually reset alarms not currently active; all the alarm events per hour will also be reset even if the alarms are not active.
In menu mode, this key acts as a scroll down or down key (decreasing value).

THE KEYPAD INCORPORATED AT THE UNIT, MODEL Climatic® 400

READING DISPLAY

This is a 3-digit display, the inlet water temperature is shown in degrees (default), °C (when shows decimal point). The following can also be displayed:

- Values of all parameters controlled by the equipment:
 - Cooling set point, cooling differential temperature.
 - Heating set point (heat pump units) and heating differential temperature.
 - Outlet water temperature (as security).
 - Inlet water temperature (regulation).
 - Piping temperature.
- Alarm codes.
- The status of all machine functions (operating hours, delay time etc).

COMPRESSOR LED

When this LED is continually lit, it indicates that the compressor is operating (in heating or cooling mode, depending on the operating mode selected); however, when it flashes, this indicates that pausing is taking place, delaying the compressor start.

- LED 1: Compressor 1 circuit 1
- LED 2: Compressor 2 circuit 1
- LED 3: Compressor 1 circuit 2
- LED 4: Compressor 2 circuit 2

HEATING MODE LED

When this LED is continually lit it indicates that the unit is operating in heating mode.

COOLING MODE LED

When this LED is continually lit it indicates that the unit is operating in cooling mode.

COOLING MODE LED / HEATING MODE LED

When none of these two leds COOLING/HEATING are lit, it indicates that the operating mode selected is STAND-BY.

MODE / UP BUTTON

Selects the operating mode between the following:
Stand-by / Cool / Heat
In menu mode, this button acts as a scroll up or up key (increasing value).

MODE - ON / OFF BUTTON

Pressing both buttons at the same time, gets to the menu level.
They also move one level up or down in the menu.

ELECTRICAL HEATER LED

When this LED is continually lit it indicates that the internal anti-freeze electrical heater is on; if the led is off, the internal anti-freeze is off.

READING DISPLAY

ON - OFF / DOWN BUTTON

Turn the unit ON and OFF. Press also once to reset all manually reset alarms not currently active; all the alarm events per hour will also be reset even if the alarms are not active.
In menu mode, this key acts as a scroll down or down key (decreasing value).

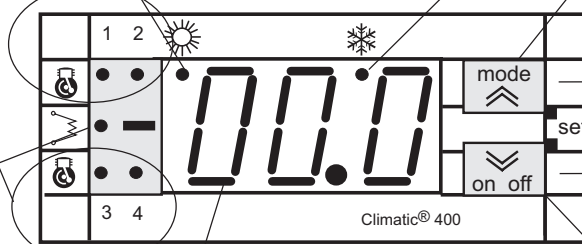

THE KEYPAD REMOTE CONTROLLER (OPTION), MODEL RC Climatic® 200

READING DISPLAY

This is a 3-digit display, the inlet water temperature is shown in degrees (default), °C (when shows decimal point). The following can also be displayed:

- Values of all parameters controlled by the equipment:
 - Cooling set point, cooling differential temperature.
 - Heating set point (heat pump units) and heating differential temperature.
 - Outlet water temperature (as security).
 - Inlet water temperature (regulation).
 - Piping temperature.
- Alarm codes.
- The status of all machine functions (operating hours, delay time etc).

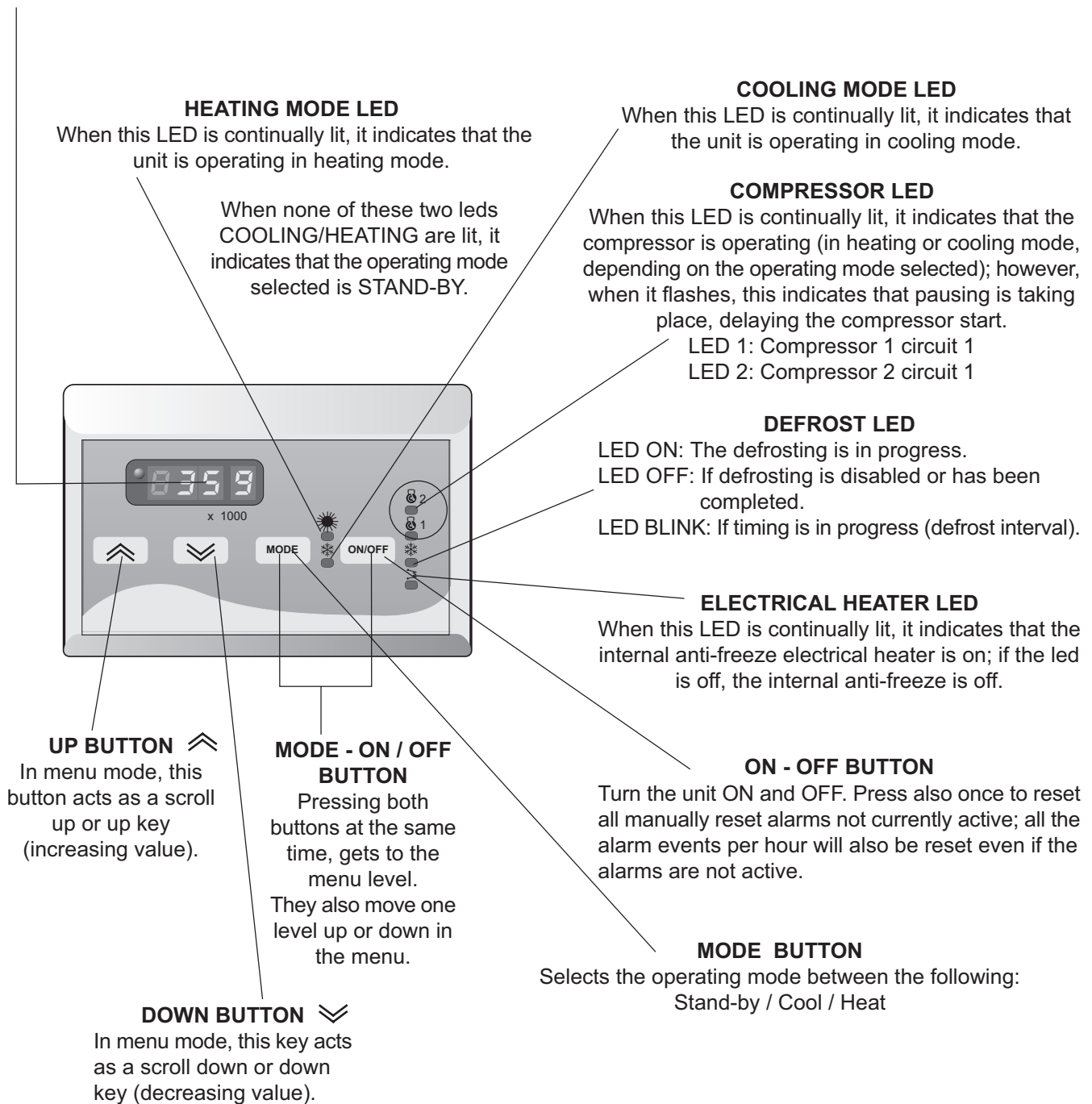

READING DISPLAY

This is a 3-digit display, the inlet water temperature is shown in degrees (default), °C (when shows decimal point). The following can also be displayed:

- Values of all parameters controlled by the equipment:
 - Cooling set point, cooling differential temperature.
 - Heating set point (heat pump units) and heating differential temperature.
 - Outlet water temperature (as security).
 - Inlet water temperature (regulation).
 - Piping temperature.
- Alarm codes.
- The status of all machine functions (operating hours, delay time etc).

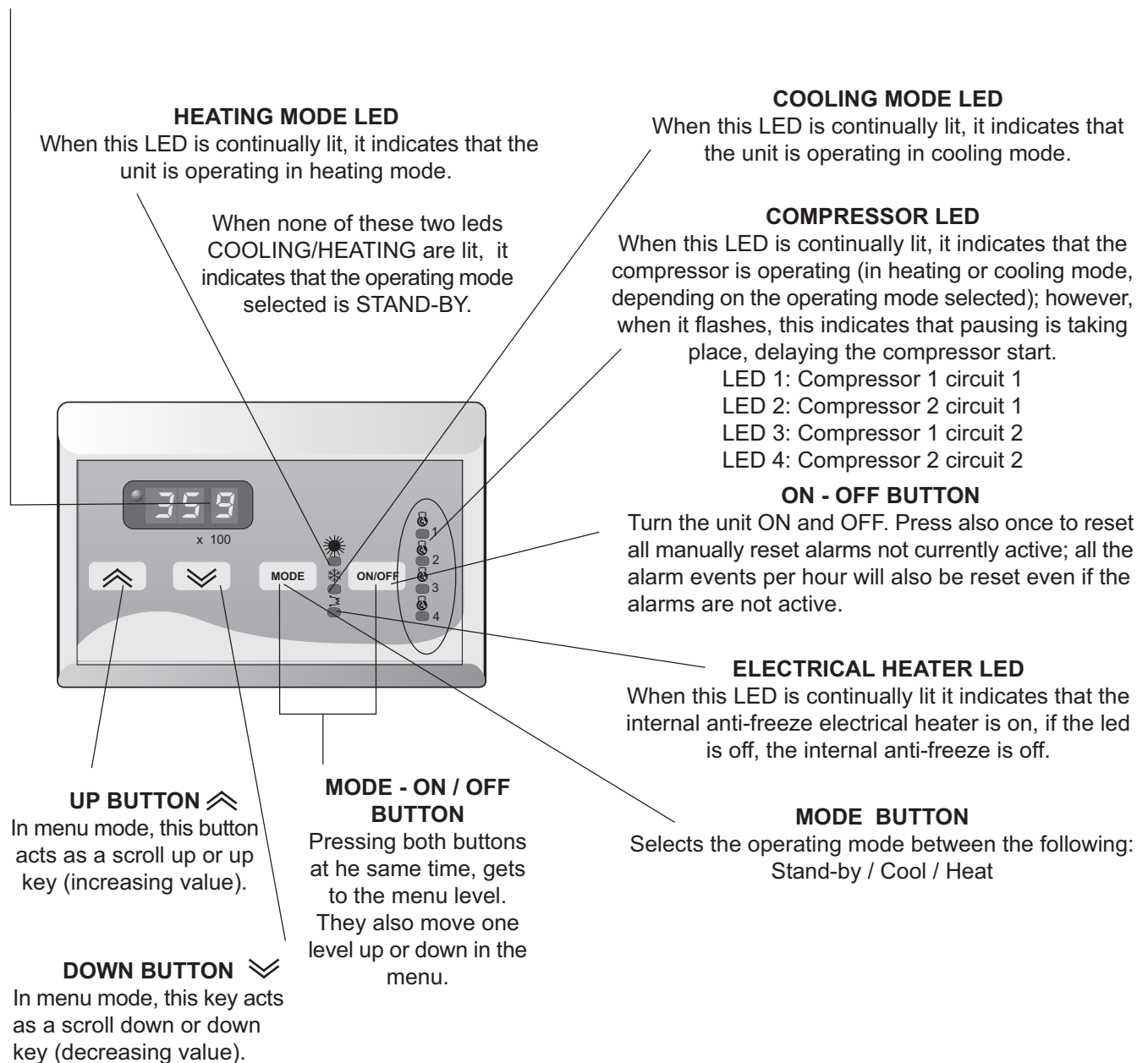

UNIT COMMISSIONING

When all the instructions in the Operating, Service and Installation Manual have been carried out, the unit can be commissioned as follows:

POWER SUPPLY TO THE UNIT

- Set the general cut-off switch to ON.

TURN ON/OFF THE UNIT

- Pressing  button **for more than 2 seconds** lets you turn ON the unit. The display lights up and shows the inlet water temperature, or an alarm indication, and the different leds on the unit will flash (see page 16 for alarm section).

If "E00" is shown, indicates that the unit has been turn off by the remote ON/OFF switch, located between 93 and 94 terminals at the electrical box. If the unit does not incorporate this switch, verify that a link exists between these terminals.

- To turn OFF the unit press  button **for more than 2 seconds**. Before disconnecting power supply, wait until water pump stops.

NOTE: When unit is not going to be operating during long periods of time do not turn off power supply, select the OFF operating mode in order to anti-freeze protection works.

SELECTING THE UNIT'S OPERATING MODE

The operating mode is always indicated on the display by leds.

Pressing the  button repeatedly you can change the unit operating mode, and select the required one:



COOL: The unit is working on cooling mode, the led ❄️ will light up on the display.















HEAT: The unit is working on heating mode, the led ☀️ will light up on the display (only heat pump units).

STAND BY: The unit is working on stand-by, none led will light up.





Once cooling or heating mode has been selected, water pump will turn on. If cooling is the unit's operating mode selected and the inlet water temperature exceeds the cooling set point, or if heating mode has been selected and the inlet water temperature drops below the heating set point, there will be a demand for the compressor to start, then the compressor led starts blinking, indicating that the compressor start is delayed due to the compressor recycle timer operation (see page 20); after this the compressor will start and the led is on.

SELECTING THE WATER TEMPERATURE OF THE SYSTEM (SET POINT)

To modify the set point of the unit follow the steps:

- Press the buttons  and  simultaneously, the display will show up .
- Press the buttons  and  again, the display will show up  (cooling set point).
Pressing the buttons  and , the display will show up  (heating set point) (only heat pump units).
- Once positioned on the set point which should be changed  or :
press the buttons  and  simultaneously and **release within 2 seconds**, and the display shows up the current set point; and with buttons  or  may change the set point between maximum and minimum limits.

Once the set point has been changed press  and  simultaneously.

- To get to the main display, press  and  simultaneously **for more than 2 seconds**, the display will show up ; press again  and  **for more than 2 seconds**, and you will be on the main display.

MENU MODE

Press **[mode]** and **[on off]** buttons and **release within 2 seconds**, to enable the user to get to the menu mode

To move through the menu on this way → :

Press **[mode]** and **[on off]** buttons simultaneously and **release within 2 seconds**.

To move through the menu on this way ← :

Press **[mode]** and **[on off]** buttons simultaneously **for more than 2 seconds**.

To move through the menu on this way ↓ , press: 

To move through the menu on this way ↑ , press: 

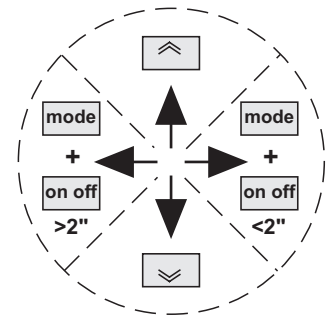

NOTE: When the leds on the display flash alternatively from one to the other, you are on menu mode.

MENU STRUCTURE

MAIN DISPLAY

It shows:
Inlet water temperature
Active alarms

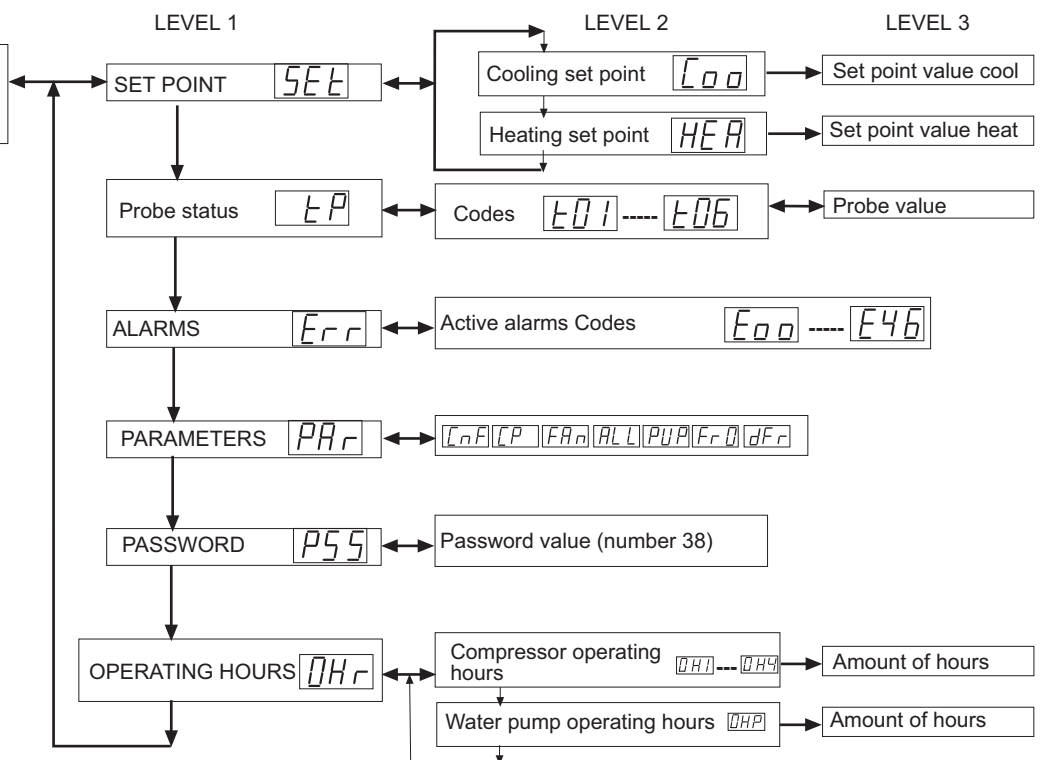

SEt Water temperature adjustment menu.

Status temperature probes menu:

St1: Inlet water temperature.

EP St2: Outlet water temperature.

St3 and St6: Piping temperature.

St4: Outdoor temperature (with option Dynamic set point).

Err Active alarms Menu.

PAR Configuration parameters menu.

PSS Password to access to parameters configuration (number); the password is 38.

OHR Operating hours resources management (compressor, water pump).

SET POINT THERMOSTAT FUNCTION DESCRIPTION

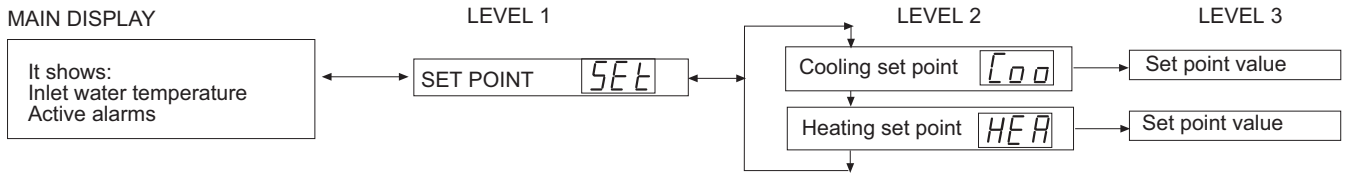

See page 7, for adjustment of set point of the system. The water temperature is thermostatically controlled via a set point and a tolerance range (differential). The operation of these parameters is shown in the following diagrams:

COOLING OPERATING MODE

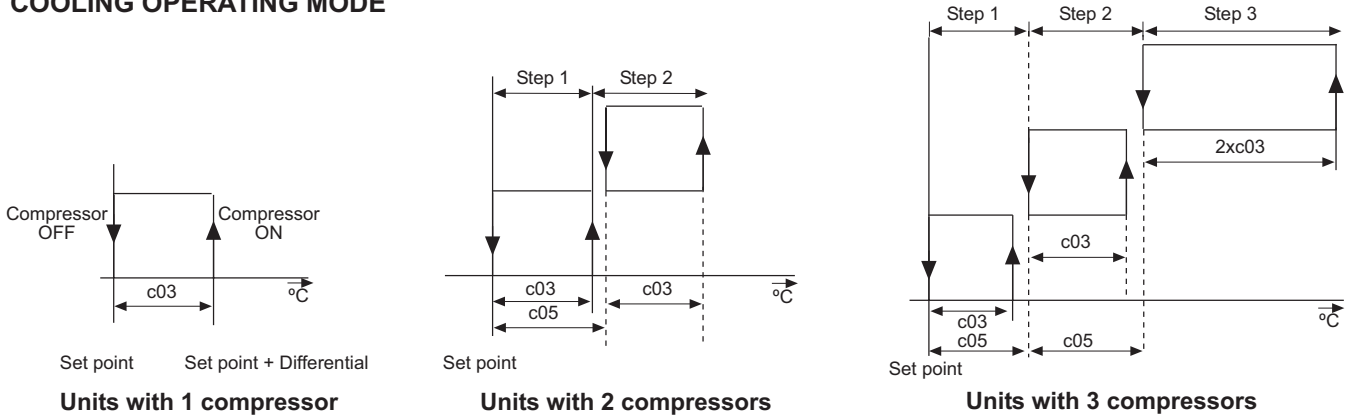

Operation with one compressor is as shown in the diagram taking into account that the temperature about which the controller takes over is the inlet water temperature. When this temperature exceeds the set point + tolerance range (differential) the compressor **starts** to produce cool water. When inlet water temperature gets below the set point the compressor **stops**. For example, when the set point = 11°C and differential = 2°C, the compressor **stops** when inlet water temperature is 11°C and **starts** when this temperature exceeds 13°C.

HEATING OPERATING MODE

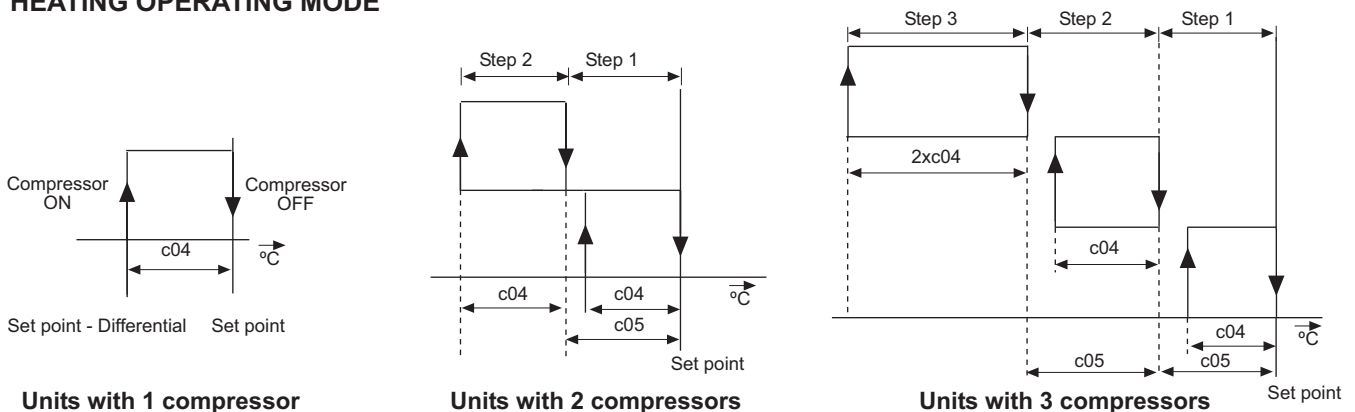

Operation with one compressor is as shown in the diagram taking into account that the temperature about which the controller takes over is also the inlet water temperature. When this temperature gets below the set point - Differential, the compressor **starts** to produce heat water. When the inlet water temperature exceeds the set point, the compressor **stops**. For example: when the set point = 41°C and differential = 2°C, the compressor **stops** when the inlet water temperature is 41°C and **starts** when this temperature gets below 39°C.

NOTE: The units with 3 compressors and the Low water temperature kit work with 2 steps according to the units with 2 compressors.

AFFECTED PARAMETERS

MAX: Maximum value for the parameter. UNIT: The units of measure used.
 MIN: Minimum value for the parameter. VAR.: Minimum variation allowed.
 DEF: The default value, factory set.

Code that appears on the display	DESCRIPTION	1 COMPRESSOR UNIT VALUES			2 COMPRESSOR UNIT VALUES			3 COMPRESSOR UNIT VALUES			UNIT	VAR.
		MIN	MAX	DEF	MIN	MAX	DEF	MIN	MAX	DEF		
SEt	COO	10	15	11	9	14	10	8	14	9	°C	0,1
	HEA	20	43	41	20	43	42	20	43	43	°C	0,1
PAR-CP	CO3	0	25,5	2	0	25,5	1.5	0	25,5	1	°C	0,1
	CO4	0	25,5	2	0	25,5	1.5	0	25,5	1	°C	0,1
	CO5	---	---	---	0	25,5	1.5	0	25,5	1	°C	0,1

ANALOGUE INPUTS

MAIN DISPLAY

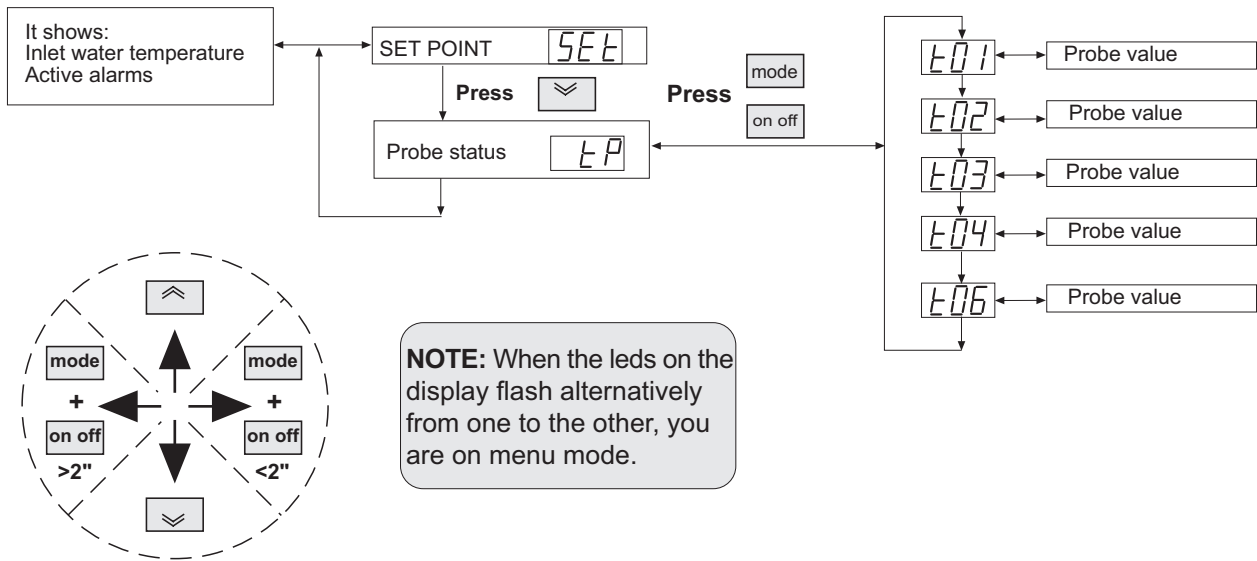

Probe St1 E01 Inlet water temperature.

Probe St2 E02 Outlet water temperature.

Probe St3 E03 Piping temperature at circuit 1.

Probe St4 E04 Outdoor temperature (with option Dynamic set point).

Probe St6 E06 Piping temperature at circuit 2 (ONLY MODEL Climatic® 400).

For every unit without anti-freeze the minimum outlet water temperature should be 5°C.

For applications where the outlet water temperature is lower than 5°C is necessary to use anti-freeze.

ON/OFF REMOTE

Remove the wire between 93 and 94 terminal block on the electrical box and insert a contact.
If the unit stops with ON/OFF Remote, "E00" will appear on the unit display.

REMOTE CHANGEOVER SUMMER/WINTER

On heat pump units, it is possible to select cooling or heating mode with a remote contact. The ON/OFF remote can be combined with this function in order to control the unit from a long distance, with the Off/Cool/Heat options. To use this option:

- Units with Climatic® 200:

- 1) Connect a remote contact between the 97 and 98 terminal block on the electrical box.
- 2) Change the parameters: H08=2, H21=3, and H27=1.

- Units with Climatic® 400:

- 1) Connect a remote contact between the 99 and 100 terminal block on the electrical box.
- 2) Change the parameter: H49=1.

From this moment, when the contact is open, the heating mode has been selected, and when the contact is closed, the cooling mode has been selected.

Note 1: when this function is enabled, you can only change between the cooling and heating mode through this contact. The change through the remote control or through the unit display is disabled.

Note 2: for units with Climatic® 200 you can only use the Remote changeover Summer/Winter or the Dynamic set point.

DYNAMIC SET POINT

With this Option which incorporates an additional outdoor temperature probe (St4) to have a Dynamic adjustment to the set point based on ambient temperature.

The set point value can be increased to 3°C on cooling mode, or decreased to 4°C on heating mode when the external conditions are more advantageous, so an extra energy saving can be achieved.

Parameters:

- Units with Climatic® 200:

- H08 St4 configuration= 0 no probe, 2 Remote changeover Summer/Winter, 3 Outdoor temperature.
- H31 Dynamic set point enable (0 disabled, 1 enabled).
- H34 Ext. temperature in cool Dynamic set point.
- H35 Ext. temperature in heat Dynamic set point.
- H36 Ext. temperature cool Dynamic set point differential.
- H37 Ext. temperature heat Dynamic set point differential.

- Units with Climatic® 400:

- H14 St4 configuration= 0 no probe, 3 Outdoor temperature.
- H50 Dynamic set point enable (0 disabled, 1 enabled).
- H53 Ext. temperature in cool Dynamic set point.
- H54 Ext. temperature in heat Dynamic set point.
- H55 Ext. temperature cool Dynamic set point differential.
- H56 Ext. temperature heat Dynamic set point differential.

Outdoor temperature probe has to be connected between 97 and 98 terminal block on the electrical box.

Note 1: For units with Climatic® 200 you can only use Remote changeover Summer/Winter or the Dynamic set point.

Note 2: On the display, the St4 probe indicates the outdoor temperature.

Note 3: This function is not available for EAC 0472 to 0812 units.

(See the following page.)

OPTIONS

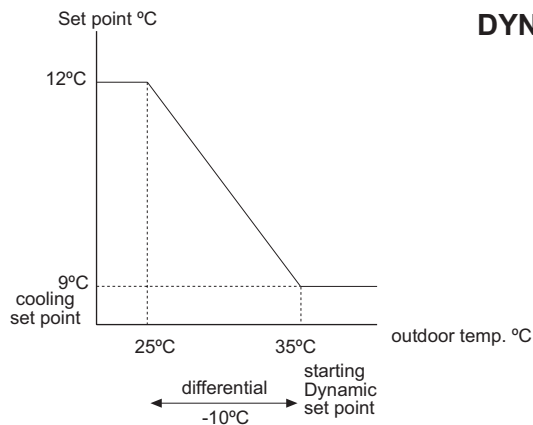

COOLING MODE

When the outdoor temperature exceeds 35°C, the unit set point is the set value. The Dynamic set point function starts when the temperature is below 35°C. The set point value increases below 35°C, so for 25°C (10°C differential) the set point is 3°C more than the set value.

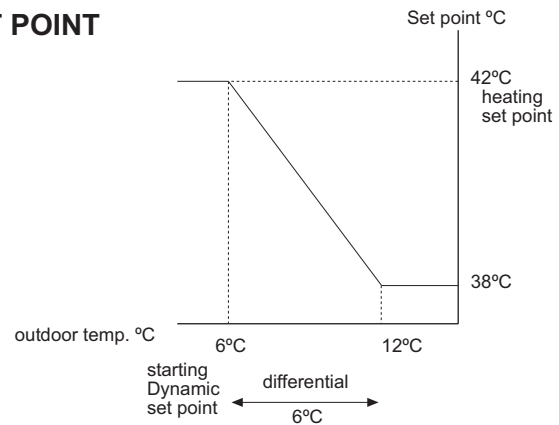

HEATING MODE (only for heat pump units)

When the outdoor temperature is 6°C the unit set point is the set value. The Dynamic set point function starts when the temperature exceeds 6°C. The set point value decreases above 6°C, so for 12°C (6°C differential) the set point is 4°C less than the fixed value.

BMS CONNECTION

It is possible to connect the unit to a BMS system with a MODBUS protocol.

A communication adaptor is installed in the unit. With a GATEWAY, 8 units can be connected. It is possible to achieve a net with 15 GATEWAYS. This net communicates with a BMS system through MODBUS protocol.

The interface can:

- Select between OFF/STAND-BY/COOL/HEAT.
- Modify the cooling and heating set point.
- Read the alarm status.
- Read all the functioning temperatures.
- Read the status of inputs (pressure switches, fluid switch, thermal protection...).
- Read the status of outputs (compressor, fan, pump...).
- Read the maximum and minimum set point available in cooling and heating mode.

Parameters:

- Units with Climatic® 200:

H26 Serial output configuration 1= ModBus.

H44 Family serial address= 0.

H45 Device serial address= 1..8 (different for each one connected to the GATEWAY).

- Units with Climatic® 400:

H48 Serial output configuration 1= ModBus.

H65 Family serial address= 0.

H66 Device serial address= 1..8 (different for each one connected to the GATEWAY).

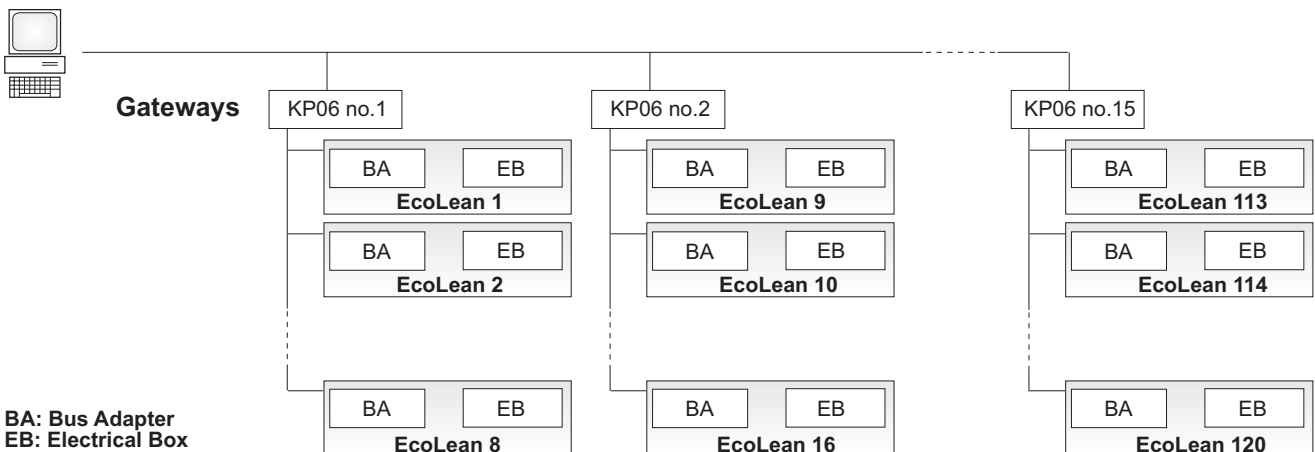

MODIFY PARAMETERS

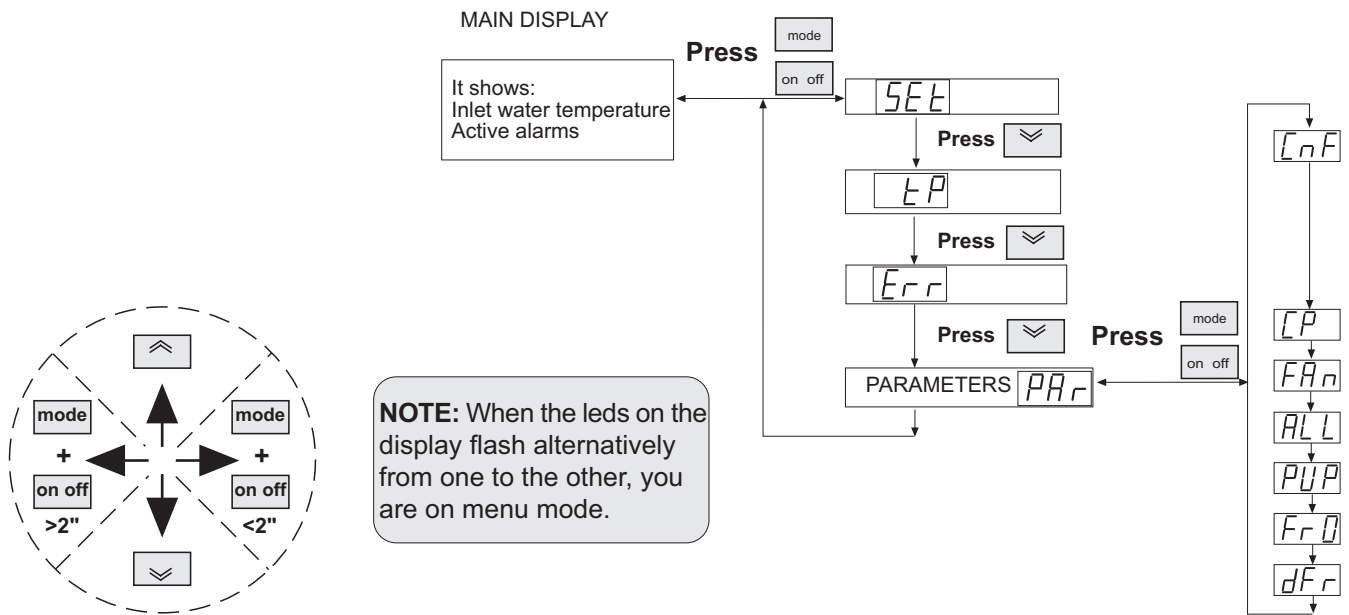

PAR Menu of configuration parameters of the unit.

CnF General configuration parameters of the unit (Values (H)).

CP Configuration parameters concerning to compressor (Values (C)).

FAn Configuration parameters concerning to fan and defrost control (Values (F)).

ALL Configuration parameters concerning to active alarms (Values (A)).

PUP Configuration parameters concerning to water pump (Values (P)).

FrQ Configuration parameters concerning to anti-freeze (Values (r)).

dFr Configuration parameters concerning to defrost cycle (Values (d)).

To access to parameters modification, a password should be included to the system; this is not necessary if you only want to see the parameters.

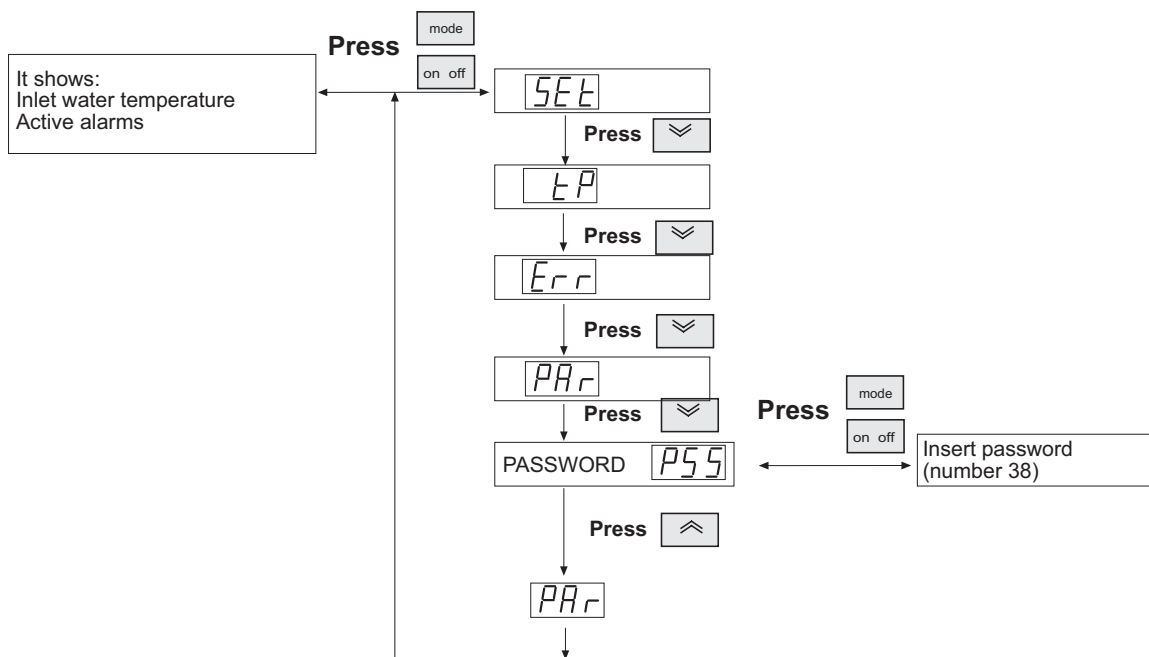

MODIFY UNIT PARAMETERS

MAX: Maximum value for the parameter.
 MIN: Minimum value for the parameter.
 DEF: The default value, factory set.
 UNIT: The units of measure used.
 VAR.: Minimum variation allowed.

DESCRIPTION	MIN	MAX	DEF	UNIT	VAR.
1 CIRCUIT UNIT MODEL Climatic® 200					
[C03] Cooling thermal regulator hysteresis	0	25.5	1.5	°C	0.1
[C04] Heating thermal regulator hysteresis	0	25.5	1.5	°C	0.1
[C05] Steps delta	0	25.5	1.5	°C	0.1
[H08] St4 configuration 0: no probe / 2: remote changeover S./W. / 3: outdoor temp.	0	3		Num	1
[H21] St4 configuration (if digital) 3: remote changeover Summer/Winter.	0	6		Num	1
[H26] Serial output configuration	0	1	0	---	1
[H27] Operation mode selection 0: selection by keyboard / 1: selection by digital input	0	2	0	Num	1
[H31] Dynamic set point enable 0: no enable / 1: enable	0	1	0	---	1
[H34] Ext. temperature in cool Dynamic set point	-127	127	35	°C	1
[H35] Ext. temperature in heat Dynamic set point	-127	127	6.0	°C	1
[H36] Ext. temperature cool Dynamic set point differential	-12.7	12.7	-10.0	°C	0.1
[H37] Ext. temperature heat Dynamic set point differential	-12.7	12.7	6.0	°C	0.1
[H44] Family serial address	0	14	0	Num	1
[H45] Device serial address	0	14	0	Num	1
[H56] Alarm output polarity 0: open relay if the output is on 1: closed relay if the output is on	0	1	0	---	1
[F07] Internal antifrost heater set point in heat	1	48	35	°C	1

DESCRIPTION	MIN	MAX	DEF	UNIT	VAR.
2 CIRCUITS UNIT MODEL Climatic® 400					
[C03] Cooling thermal regulator hysteresis	0	25.5	1.5	°C	0.1
[C04] Heating thermal regulator hysteresis	0	25.5	1.5	°C	0.1
[C05] Steps delta	0	25.5	1.5	°C	0.1
[H08] Compressors activation sequence 0: depending on operating hours 1: starting sequence	0	1	0	---	1
[H09] Balancing of the circuits 0: saturation of the circuits 1: balanced circuits	0	1	0	---	1
[H14] St4 configuration 0: no probe / 3: outdoor temperature	0	3	0	Num	1
[H45] Alarm relay polarity 0: open relay if the output is on 1: closed relay if the output is on	0	1	0	---	1
[H48] Serial output configuration	0	1	0	---	1
[H49] Operation mode selection 0: selection by keyboard / 1: selection by digital input	0	1	0	---	1
[H50] Dynamic set point enable 0: no enable / 1: enable	0	1	0	---	1
[H53] Ext. temperature in cool Dynamic set point	-127	127	35	°C	1
[H54] Ext. temperature in heat Dynamic set point	-127	127	6	°C	1
[H55] Ext. temperature cool Dynamic set point differential	-50.0	80.0	-10.0	°C	0.1
[H56] Ext. temperature heat Dynamic set point differential	-50.0	80.0	6.0	°C	0.1
[H65] Family serial address	0	14	0	Num	1
[H66] Device serial address	0	14	0	Num	1
[F07] Internal antifrost heater set point in heat	1	48	35	°C	1

OPERATING HOURS

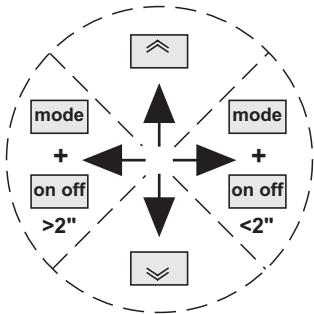
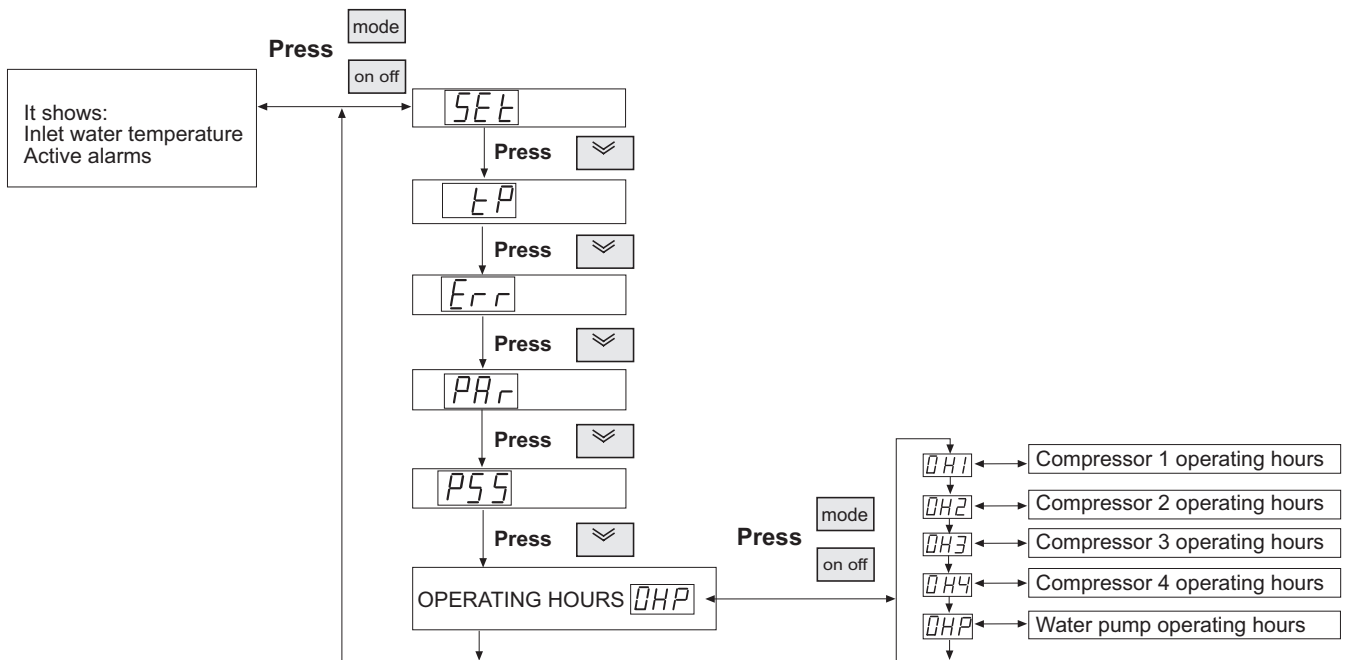

NOTE: When the leds on the display flash alternatively from one to the other, you are on menu mode.

Resetting of operating hours counters

When display shows the compressor or water pump operating hours, the counters can reset by pressing ON/OFF button and **release within 2 seconds**.

CODE	PARAMETERS	MIN	MAX	UNIT
OHI	Operating hours compressor 1 circuit 1	0	9.99	hrs/khrs
OH2	Operating hours compressor 2 circuit 1	0	9.99	hrs/khrs
OH3	Operating hours compressor 1 circuit 2	0	9.99	hrs/khrs
OH4	Operating hours compressor 2 circuit 2	0	9.99	hrs/khrs
OHP	Water pump operating hours	0	9.99	hrs/khrs

The display shows the operating hours value without the decimal point up to 999 hours. If the counter has exceeded 999 hours, the operating hours value appears with 2 decimals and the point decimal (1.00=1000 hours).

ALARM CODES

MENU STRUCTURE

MAIN DISPLAY

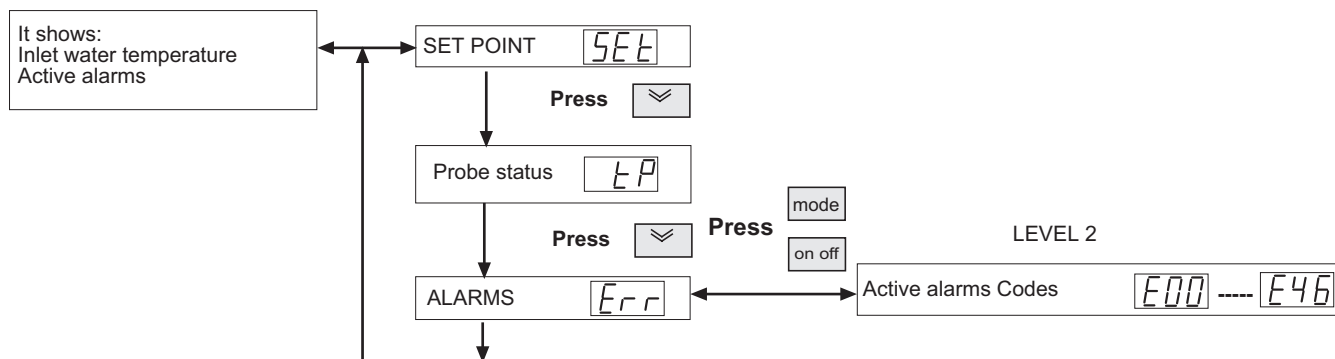

The unit self-protects through safety devices; when any of these safety devices detect an anomaly, this is shown in the display in order to advise the operator.

The activation of an alarm brings about:

- The display of the alarm code beginning with the letter E and follows a number; if more than one alarm will be activated, the alarm shown would be the one with the lowest numerical value.
- The blocking of some or all the outputs, depending on the type of alarm.

E00: This indication is not an alarm; it indicates that unit is turn off from ON /OFF remote.

VIS (Visualization): It indicates the type of alarm shown on the display.

RE (Reset): Type of reset:

AUT: AUTOMATIC RESET: Some alarms are automatically reset. When the cause is no longer present, they disappear from the display.

MAN: MANUAL RESET: Press ON/OFF button and **release within 2 seconds**. If the alarm conditions have been removed, the instrument returns to the normal operation and the alarm relay is de-energized. If on the other hand, the alarm conditions persist, then call for technical service.

VIS.	DESCRIPTION	EFFECT	RE	ACTION
E01	High pressure switch alarm. This alarm may indicate the following problems: - High pressure switch protection. - Fuses of the fan burnt out.	Circuit 1 compressors stop	MAN	Press the ON/OFF button, until the alarm disappears; if the alarm shows up again, check: • Coil is clean and not blocked. • Water flow on the heating cycle. • Check fuses of the fan. • Condenser air temperature is very high. • Check refrigerant charge.
E02	Low pressure switch alarm. This alarm may indicate the following problems: - Low amount of refrigerant. - Low water flow in cooling cycle. - Blocked coil in heating cycle. - Fuses of the fan burnt out. After two automatic resets in one hour, it comes to be a manual reset.	Circuit 1 compressors stop	MAN	When this alarm shows up repeatedly, and the alarm keeps on, make an electrical reset and check: • Coil is clean and not blocked. • Water flow on the cooling cycle. • Check fuses of the fan. • Evaporation air temperature is very low. • Check refrigerant charge.
E03	Compressor thermal protection alarm: - Compressor thermal protection open. - Faulty power supply.	Compressor 1 circuit 1 stops	MAN	Press the ON/OFF button until the alarm disappears; if alarm shows up again, check continuity and change the faulty component. • Check refrigerant charge. • Check the refrigerant circuit is not blocked. • Check connections and fuses. • Check power supply.
E04	Fan thermal protection alarm.	Circuit 1 Fan and circuit 1 compressors stop	MAN	Press the ON/OFF button until the alarm disappears; if alarm shows up again, check continuity and change the faulty component.

ALARM CODES

VIS.	DESCRIPTION	EFFECT	RE	ACTION
E05	Anti-freeze alarm. It indicates the outlet water temperature is lower than +3°C. After 1 automatic reset, it comes to be a manual reset.	Unit stops (*)	MAN	Press the ON/OFF button until the alarm disappears; if alarm shows up again, <ul style="list-style-type: none"> • Check the water filter. • Check water flow. • Check that the water pump is connected to power supply of the unit.
E06	Outlet water temperature probe alarm (St2). Outlet water temperature probe open or without connecting.	Unit stops	AUTO	These protections are automatic reset; if alarm shows up again, check: <ul style="list-style-type: none"> • Connection of outlet water temperature probe (St2) (see electrical diagram), check continuity and change the faulty component.
E07	Refrigerant piping temperature probe (St3) alarm. Refrigerant piping temperature probe open or without connecting.	Unit stops	AUTO	These protections are automatic reset; if alarm shows up again, check: <ul style="list-style-type: none"> • Connection of refrigerant piping temperature probe (St3) (see electrical diagram), check continuity and change the faulty component.
E11	High pressure / high temperature alarm. It is activated when refrigerant piping temperature probe (St3) detects a temperature higher than 70°C and the high pressure switch has not been activated.	Circuit 1 compressors stop	AUTO	Press the ON/OFF button until the alarm disappears; if alarm shows up again, check: <ul style="list-style-type: none"> • Working of high pressure switch. • Coil is clean and not blocked. • Water flow on the heating cycle. • Check fuses of the fan. • Condenser air temperature is very high. • Check refrigerant charge.
E12	Low pressure / low temperature alarm. It is activated when refrigerant piping probe (St3) detects a temperature lower than -30°C and the low pressure switch has not been activated.	Circuit 1 compressors stop	AUTO	<ul style="list-style-type: none"> • Check low pressure switch working. • Coil is clean and not blocked. • Check water flow on the cooling cycle. • Check fuses of the fan. • Evaporation air temperature is very low. • Check refrigerant charge.
E13	Compressor 2 thermal protection alarm: - Compressor thermal protection open. - Faulty power supply.	Compressor 2 circuit 1 stops	MAN	Press the ON/OFF button until the alarm disappears; if alarm shows up again, check continuity and change the faulty component. <ul style="list-style-type: none"> • Check refrigerant charge. • Check the refrigerant circuit is not blocked. • Check connections and fuses. • Check power supply.
E21	High pressure switch alarm, circuit 2. This alarm may indicate the following problems: - High pressure switch protection. - Fuses of the fan burnt out.	Circuit 2 compressors stop	MAN	Press the ON/OFF button until the alarm disappears; if the alarm shows up again, check: <ul style="list-style-type: none"> • Coil is clean and not blocked. • Water flow on the heating cycle. • Check fuses of the fan. • Condenser air temperature is very high. • Check refrigerant charge.
E22	Low pressure switch alarm, circuit 2. This alarm may indicate the following problems: - Low amount of refrigerant. - Low water flow in cooling cycle. - Blocked coil in heating cycle. - Fuses of the fan burnt out. After two automatic resets in one hour, it comes to be a manual reset.	Circuit 2 compressors stop	MAN	When this alarm shows up repeatedly, and the alarm keeps on, make an electrical reset and check: <ul style="list-style-type: none"> • Coil is clean and not blocked. • Water flow on the cooling cycle. • Check fuses of the fan. • Evaporation air temperature is very low. • Check refrigerant charge.

(*) Unit **stops** except water pump.

ALARM CODES

VIS.	DESCRIPTION	EFFECT	RE	ACTION
E23	Compressor 1 circuit 2 thermal protection alarm: - Compressor thermal protection open. - Faulty power supply.	Compressor 1 circuit 2 stops	MAN	Press the ON/OFF button until the alarm disappears; if alarm shows up again, check continuity and change the faulty component. • Check refrigerant charge. • Check the refrigerant circuit is not blocked. • Check connections and fuses. • Check power supply.
E24	Fan thermal protection alarm.	Circuit 2 fan and circuit 2 compressors stop	MAN	Press the ON/OFF button until the alarm disappears; if alarm shows up again, check continuity and change the faulty component.
E27	Refrigerant piping temperature probe alarm (St6) circuit 2. It may indicate: - Refrigerant piping temperature probe open or without connecting.	Unit stops	AUTO	These protections are automatic reset; if alarm shows up again, check: • Connection of refrigerant piping temperature probe (St6) (see electrical diagram), check continuity and change the faulty component.
E31	High pressure / high temperature alarm. It is activated when refrigerant piping temperature probe (St6) detects a temperature higher than 70°C and the high pressure switch has not been activated.	Circuit 2 compressors stop	AUTO	Press the ON/OFF button, until the alarm disappears; if alarm shows up again, check: • Working of high pressure switch. • Coil is clean and not blocked. • Water flow on the heating cycle. • Check fuses of the fan. • Condenser air temperature is very high. • Check refrigerant charge.
E32	Low pressure / low temperature alarm. It is activated when refrigerant piping temperature probe (St6) detects a temperature lower than -30°C and the low pressure switch has not been activated.	Circuit 2 compressors stop	AUTO	• Check low pressure switch working. • Coil is clean and not blocked. • Check water flow on the cooling cycle. • Check fuses of the fan. • Evaporation air temperature is very low. • Check refrigerant charge.
E33	Compressor 4 thermal protection alarm. - Compressor thermal protection open. - Faulty power supply.	Compressor 2 circuit 2 stops	MAN	Press the ON/OFF button until the alarm disappears; if alarm shows up again, check continuity and change the faulty component. • Check refrigerant charge. • Check the refrigerant circuit is not blocked. • Check connections and fuses. • Check power supply.
E40	Inlet water temperature probe alarm (St1). It may indicate: - Inlet water temperature probe open or without connecting.	Unit stops	AUTO	Check connection of inlet water temperature probe (St1) (see electrical diagram), check continuity and change the faulty component.
E41	Water flow switch alarm. It indicates low water flow in the unit.	Unit stops (*)	AUTO	• Check water circuit is not blocked. • Check water filter. • Check water pump operation.
E42	St4 probe error.	Unit stops	AUTO	Check the St4 probe connection or cancel Dynamic set point if the unit does not incorporate St4 probe.
E45	Alarm of configuration error. It may indicate that the terminal is broken.	Unit stops	AUTO	These protections are automatic reset; if the alarm shows up again, check the continuity and change the faulty component.
E46	High inlet water temperature. It indicates: Inlet water temperature probe detects temperatures higher than 90°C during more than one minute.	Unit stops	AUTO	These protections are automatic reset; if the alarm shows up again, check connection of inlet water temperature probe (St1) (see electrical diagram), check the continuity and change the faulty component

(*) Unit **stops** except water pump.

DESCRIPTION OF THE DEFROSTING SYSTEM

The defrosting process is activated during heating mode in heat pump units, when the outside temperature is low and the outdoor coil could become frozen.

To melt the ice the defrosting function will switch the unit to cooling operation for a short period.

During defrosting mode the low pressure is at minimum level, consequently the pressure switch is disabled in this mode.

The manufacturer uses default control settings which apply to most installations. The set parameters determine the following:

INITIAL DEFROSTING TEMPERATURE

The defrosting cycle begins when outdoor probe temperature is below -1°C .

END DEFROSTING CYCLE

The defrosting cycle ends when:

For one circuit units, when outdoor probe temperature of the refrigerating pipe reaches 15°C .

For two circuits units, when end defrosting pressure switch detects 24 bar.

DELAY BETWEEN TWO DEFROSTING REQUESTS

Time between two defrosting cycles is calculated from the end of one to the beginning of next, and it is 30 minutes. This defines the time during which the initial defrosting temperature (-1°C) must be maintained. When this time has elapsed, the unit starts to defrost. If the initial defrosting temperature (-1°C) increases before this time has elapsed, the timer would block and it would only start to count when the temperature returns below the starting defrosting temperature. This pausing prevents the unit from carrying out continual defrosting patterns.

MAXIMUM DEFROSTING DURATION

It is the maximum defrosting time.

This defines the maximum period if the temperature has not exceeded a set value.

This timing prevents too long defrosting cycles.

The maximum defrosting time will be 5 minutes.

DEFROSTING CYCLE SEQUENCE:

When a probe located in the outside exchanger detects -1°C , the compressor stops, the four-way valve reverses 30 seconds and after 30 seconds, the compressor starts. This cycle ends when the outside exchanger probe detects the final defrosting temperature or exceeds a safety interval. When the defrosting cycle has finished, the compressor stops for 30 seconds. Then the four-way valve reverses and 30 seconds later, the compressor starts again in heating mode generating again warm water more efficiently due to the absence of frost.

FAN SPEED CONTROL (only for 0091 to 0812 units)

Fan speed control: Management of the fan speed

It is managed by a fan speed control printed plate located at the electrical box of the unit.

The function of the fan speed control is to prevent very low condensing temperatures during cooling mode operation between 0°C and 46°C outside temperatures.

In this case, it is a proportional fan speed control, which varies the fan voltage supplied to the fan.

FAN STAGES	AMBIENT TEMPERATURE	FAN RPM
Fan stops	Ambient temperature below +5°C	0
Minimum fan speed	Ambient temperature between +5°C and +20°C	350
Fan regulation	Ambient temperature between +20°C and +30°C	350 to 750
Silent fan speed	Ambient temperature between +30°C and +35°C	750
Maximum fan speed	Ambient temperature over +35°C	900

FAN FUNCTIONING CONTROL (only for 1003 to 1303)

The fans for these models incorporate 2 speeds. The fans work on high or low speed according to:

COOLING MODE:

The on/off and low/high fan speed is managed according to the condensing pressure. See the drawing below:

COOLING MODE

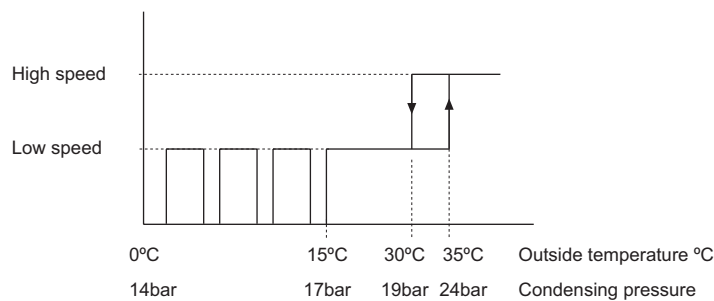

HEATING MODE (only heat pump units):

The low/high fan speed is managed according to the ambient thermostat. See the drawing below:

HEATING MODE

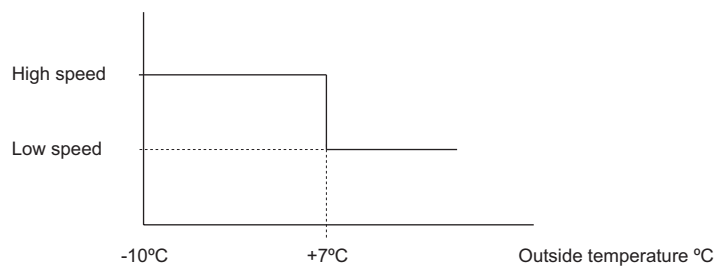

SAFETY DEVICES

The units contain various safety devices to avoid damage to the unit due to very low water temperatures.

1.- Anti-freeze protection.

This protection is activated by the control of the unit when the outlet water temperature probe (St2), located inside the water exchanger, measures +5°C and deactivates when the outlet water temperature probe reaches to +6°C again.

When the protection is activated occurs as follow:

- If the unit is on STAND-BY as the operating mode: the water pump goes on, the same happens with electrical heater of water exchanger and electrical heater of water tank (if included).



DO NOT TURN OFF THE POWER TO THE UNIT. WHEN THE POWER IS OFF THE ANTI FREEZE PROTECTION WILL NOT OPERATE.

- If the unit is operating on cooling mode: feeds the electrical heater of water tank, the electrical heater of the water exchanger, and activates the hot gas injection valve (if the unit incorporates these options).
- If the unit is operating on heating mode: feeds the electrical heater of water tank and the electrical heater of the water exchanger (if the unit incorporates these options).

2.- Low water temperature alarm.

This alarm activates when the outlet water temperature probe (St2) measures a value of +3°C. As a consequence, the unit stops. The alarm could be reset when outlet water temperature reaches +8 °C.

3.- Compressor start delay.

There is a start to start anti cycle time of 5 minutes between starts compressor starts and a further delay between compressor stop to start of 5 minutes (maximum number of starts is 12 per hour).

4.- Compressor crankcase heaters.

It is located around the compressor. This protection is activated when the unit is stopped in order to keep the compressor oil on suitable conditions and to avoid refrigerant condensing inside the compressor.



DO NOT TURN OFF THE POWER TO THE UNIT. WHEN THE POWER IS OFF THE CRANKCASE HEATER PROTECTION WILL NOT OPERATE.

5.- Water pump start delay.

In both heating and cooling modes the compressors start 4 minutes after the water pump has started in order to stabilize the water system.



DO NOT TURN OFF THE POWER TO THE UNIT. WHEN THE POWER IS OFF THE WATER PUMP START DELAY PROTECTION WILL NOT OPERATE.



www.lennox europe.com

BELGIUM, LUXEMBOURG
www.lennoxbelgium.com

CZECH REPUBLIC
www.lennoxczech.com

FRANCE
www.lennoxfrance.com

GERMANY
www.lennoxdeutschland.com

NETHERLANDS
www.lennoxnederland.com

POLAND
www.lennoxpolska.com

PORTUGAL
www.lennoxportugal.com

RUSSIA
www.lennoxrussia.com

SLOVAKIA
www.lennoxdistribution.com

SPAIN
www.lennoxspain.com

UKRAINE
www.lennoxukraine.com

UNITED KINGDOM AND IRELAND
www.lennoxuk.com

OTHER COUNTRIES
www.lennoxdistribution.com

Due to Lennox's ongoing commitment to quality, the Specifications, Ratings and Dimensions are subject to change without notice and without incurring liability.

Improper installation, adjustment, alteration, service or maintenance can cause property damage or personal injury.

Installation and service must be performed by a qualified installer and servicing agency.



MUL28E-0104 09-2006