



LENNOX®

BASIC CLIMATIC CONTROLLER



PROVIDING GLOBAL SYSTEM SOLUTIONS

**Basic Climatic™
Controller
Ecologic**

CONTENTS

	PAGE
GENERAL DESCRIPTION	3
USER INTERFACE	4
The keypad incorporated on the unit	4
The keypad remote controller (option)	5
Key functions	6
Function	7
How to get parameters and devices	8
Menu structure	9
PARAMETERS	10
Set point thermostat function description	10
Condensation fan control	11
Fan control in cool mode	12
Modify parameters	13
Parameters lists	14
ALARM	19
Alarms	19
Diagnostics	21
Alarm codes	22
TECHNICAL DATA	23
USE OF DEVICE	26
GLOSSARY	27

LENNOX have been providing environmental solutions since 1895, our range of air cooled Chillers continues to meet the standards that have made **LENNOX** a household name.

Flexible design solutions to meet YOUR needs and uncompromising attention to detail. Engineered to last, simple to maintain and Quality that comes as standard.

Our company is a member of the Eurovent Certification Programme. The ECOLOGIC™ Lennox chillers are tested and rated in accordance with Eurovent certification program.



Our products comply with the European standards.



The manufacturing ECOLOGIC™ family of chillers answers to ISO 9001 control quality system. A copy of the certificate can be get on request.



Due to LENNOX on going commitment to quality, specifications subject to change without notice and without incurring liability

COPYRIGHT

All the technical and technological information contained in this manual, including any drawing and technical descriptions provided by us, remain the property of Lennox and must not be utilised (except in the operation of this product), reproduced, issued to or made available to third parties without the prior written agreement of Lennox.

This equipment is an electronic device that controls packaged water cooling systems.

The thermostat allows the following operations:

- Unit ON/OFF
- Select system operating mode
- Set point adjustment
- Alarm signal relay
- Display temperature
- Status of the unit alarms
- Possibility of remote ON/OFF.
- A remote controller as an option

The control supplied incorporated on the unit contains the following devices:

REGULATION:

The control makes the system regulation as follow:

- The signals of analogue inputs through the inlet and outlet temperature and from the refrigerant piping temperature.
- Receives digital inputs through the status of low, high and pressostat, flow switch (water flow) status and from electrical protection of fans and compressor.

According to the valves and status of analogue and digital inputs manages.

The out put signals; compressor, fan and water pump operating, obtaining the regulation of the inlet water temperature to the unit, regulating the speed of the air fan volume, output signals water.

Heater, water tank heater, and hot gas valve (all these elements are an option) used to protect the unit, and also activates the alarm codes about, setting pressurestat, flow switch, water flow, and the electrical protection of fan and compressor (see alarm section).

- A group of parameters allow the control be programmed for each application within factory set limitations.

The control supplied incorporated on the unit contains the following devices :

CLIMATIC BASIC CONTROLLER

- Keypad

Located within the unit.

- Control Module

Located at the electrical box

This device controls the operation of the unit, allowing the regulation of the system.

- Fan Control

Located at the electrical box

Allows the fan voltage to be varied in respect of the condensing temperature.

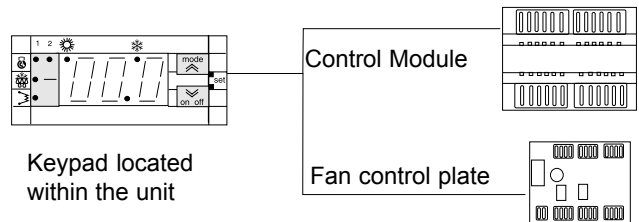

A remote controller is offered as an option. To install this optional remote controller proceeded as follow:

- Connect exactly as indicated in electrical diagram
- The wire should not exceed 50 m.

The three cables for connection from the keypad to the power board must be kept separate from other cables, using an individual cable channel; and use shielded cables, with a cross-section of 1 mm².

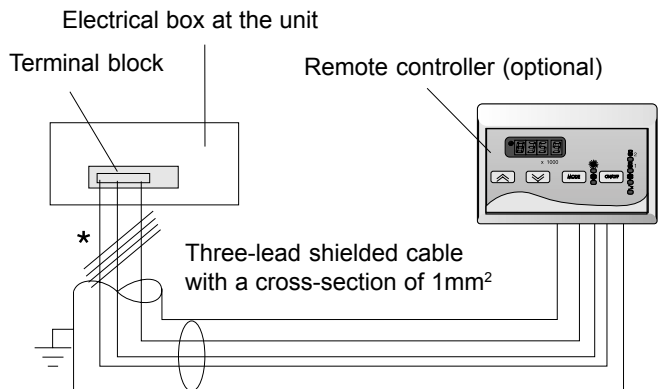

* Connection to be made by user MAXIMUM LENGTH 50m

READING DISPLAY

This is the 3-digit display, The inlet water temperature is shown in degrees (default), °C (when shows decimal point), o °F (do not show the decimal point) . The following can also be displayed:

- Values of all parameters controlled by the equipment:
- Cooling set point, cooling differential temperature
- Outlet water temperature (as security)
- Inlet water temperature (regulation)
- Alarm codes.
- The status of all machine functions (operating hours, delay time etc.)

COMPRESSORS LED

When this LED is continually lit it indicates that the compressor is operating; however, when it flashes this indicates that pausing is taking place which is delaying the compressor start.

MODE / UP BUTTON

Selects the operating mode between the following: Stand-by / Cool In menu mode, this button acts as a scroll up or up key (increasing value).

COOLING MODE LED

When this LED is continually lit it indicates that the unit is operating in cooling mode.
When the led COOLING is not lit, it indicates that the operating mode selected is STAND-BY.

NOT USED

MODE - ON / OFF BUTTON

Pressing both buttons at the same time, gets to the menu level. They also lets move one level up or down in the menu.

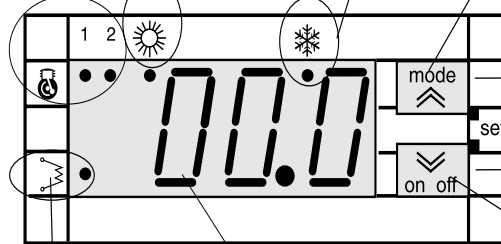

READING DISPLAY

ELECTRICAL HEATER LED

When this LED is continually lit it indicates that the internal anti-freeze electrical heater is on, if the led is off, the internal anti-freeze is off.

ON - OFF / DOWN BUTTON

Turn the unit ON and OFF, Press once to reset all manually reset alarms not currently active; all the alarm events per hour will also be reset even if the alarms are not active. In menu mode this key acts as a scroll down or down key (decreasing value).

READING DISPLAY

This is the 3-digit display, The inlet water temperature is shown in degrees (default), °C (when shows decimal point), °F (do not show the decimal point) . The following can also be displayed:

- Values of all parameters controlled by the equipment:
- Cooling set point, cooling differential temperature
- Heating set point (heat pump units) and heating differential temperature
- Outlet water temperature (as security)
- Inlet water temperature (regulation)
- Defrost temperature
- Alarm codes.
- The status of all machine functions (operating hours, delay time etc.)

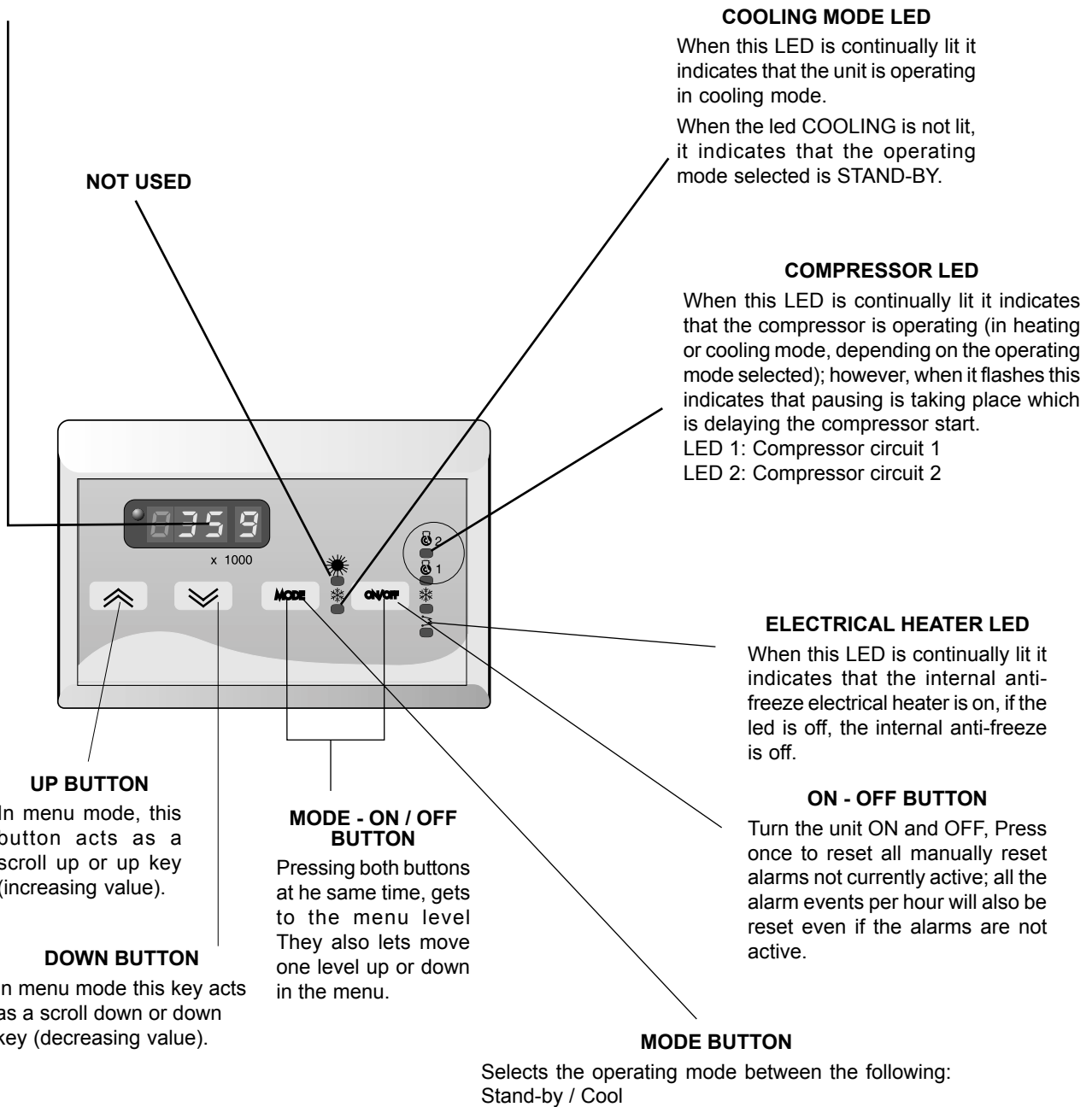



Mode

Selects operating mode:

Stand-by ⇨ **cooling** ⇨ **stand-by**

In menu mode, this key acts as a **SCROLL UP** or **UP** key (increasing value).

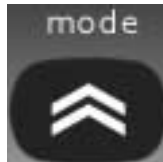

Normal display shows:



Resets **alarms**, and turns the Chiller on and off.

Press once to **reset** all **manually reset alarms** not currently active; all the alarm events per hour will also be reset even if the alarms are not active. Hold down the key for **2 seconds** to turn the Chiller from on to off or vice versa. When it is off, only the decimal point remains on the display.

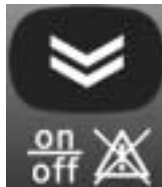

In menu mode this key acts as a **SCROLL DOWN** or **DOWN** key (decreasing value).

Pressing the "**mode**" and "**on-off**" keys at the same time:

If you press both keys at the same time and then release within 2 seconds, you will move one level deeper in the display menu.



If you press both keys for more than 2 seconds you will move one level up. If you are currently viewing the lowest level in the menu and you press both keys and release within 2 seconds, you will go up one level.

Display

The device can communicate information of all kinds on its status, configuration, and alarms through a display and a number of leds on its front panel.

Display

Water temperature in tenths of degrees Celsius or Fahrenheit

Alarm code, if at least one alarm is active. If multiple alarms are active, the one with greater priority will be displayed, according to the Table of Alarms.

Otherwise, in **menu mode**, the display depends on the current position; labels and codes are used to help the user identify the current function.

Led Indications
Circuit 1 / Circuit 2



Compressor Status

ON - if at least one compressor of the circuit 1 is active



OFF - if all compressors of the circuit are off

RAPID BLINK - safety timing is in progress, on the activation of first Compressor in that Circuit (all compressors are OFF)

Slow BLINK if circuit 1 is currently set to defrost

Cooling Mode



NOT USED



Auxiliary Heating ON





UNIT COMMISSIONING

When all the instructions in the Operating, Service and Installation Manual have been carried out, the unit can be commissioned as follows:

POWER SUPPLY TO THE UNIT

- Set the general cut-off switch to ON (if included), when the unit gets under power supply the display will lights up.

TURN ON/OFF THE UNIT.

- Pressing  button during more than two seconds , lets you turn on or OFF the unit. The display will show the inlet water temperature or an alarm indication, if E 00 shows, indicates that the unit has been turn off by the  remote, located between **93** and **94** terminal at the electrical box, If the unit does not incorporate this switch, verify that a link is between these terminals, and the leds on the display will lit (see alarm section). To turn off the unit press button  during more than 2 seconds, before disconnect power supply, wait until water pump stops.

SELECTING THE UNIT'S OPERATING MODE

The operating mode is always indicated on the display by leds. Pressing the  button repeatedly you can change the unit operating mode, and select the required one :

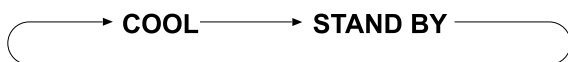

COOL : The unit is working in cooling mode, the LED  will lights up in the display



STAND BY : The unit is working in stand-by, none LED will lights up.



Once cool have been selected water pump will turn on. If cool is the unit's operating mode selected and the inlet water temperature exceeds the cooling the set point, there will be a demand for the compressor to start, then the compressor LED start blinking, which indicates that the compressor starts, is delayed because of anticyclone protection, after of this, compressor start and LED gets set.



NOTE : When unit is not going to be operating during long periods of time do not turn off power supply or antifreeze protection may be isolated.



SELECTING THE UNIT'S OPERATING MODE





To modify the set point of the unit follow the steps:



Press the buttons  and  simultaneously and release within two seconds, the display will show up 





Press the buttons  and  again, the display will show up  (cooling set point)

Pressing the buttons  and , the display will show up  (heating set point)

Once positioned on the set point which should be changed  or 

Press the buttons  and  simultaneously and release within two seconds, and the display shows up the actual set point, and with buttons  or  may change the set point, between a maximum and a minimum values.

Once the set point have been changed press  and  simultaneously.

To get to the display value, press  and  simultaneously during more than two seconds, the display will show up  press again  and  during more than two seconds, and you will be on the display value.

A parameter is an internal program reference containing important values which can be set to allow the user or installer to ensure proper operation of the unit.

A device is, the status list of the elements that comprises the system. Getting to the menu mode enable the user to obtain a status list for the unit's devices, this can be used to read the probe temperatures or the operating hours for example.

All parameters and devices are structure on levels of visualization as shown below:

HOW TO GET TO MENU MODE

Press and buttons and release **within two seconds**, to enable the user to get to the menu mode

To move through the menu on this way ⇄

Press and buttons simultaneously and release **within two seconds**.

To move through the menu on this way ⇄

Press and buttons simultaneously during **more than two seconds**.

To move through the menu on this way ↓, press:

To move through the menu on this way ↑, press:

Water temperature adjustment menu

Status temperature probes menu

ST1: Inlet water temperature

ST2: Outlet water temperature

ST3 and ST6: Piping temperature

Active alarms Menu

Configuration parameters menu

Password to access to parameters configuration

Operating hours resources management (compressor, water pump)

NOTE: When leds on the display lit alternative from one to the other. You are on menu mode.

MENU STRUCTURE

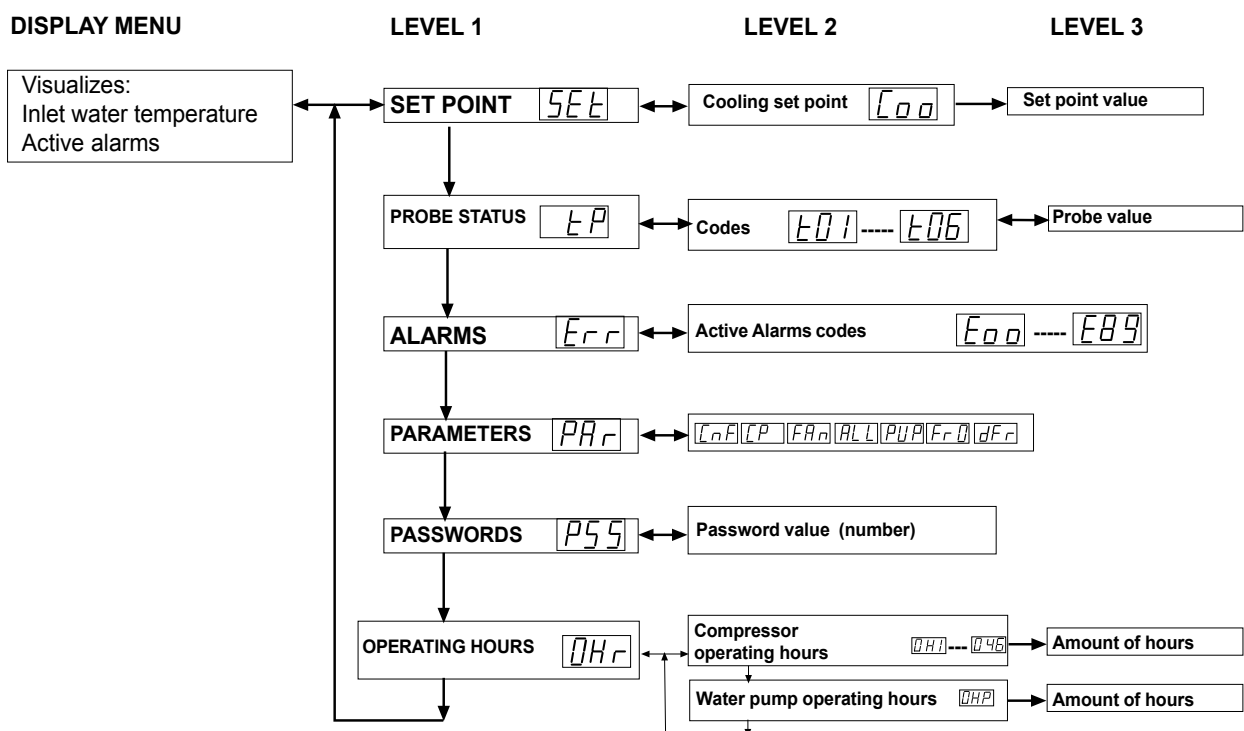

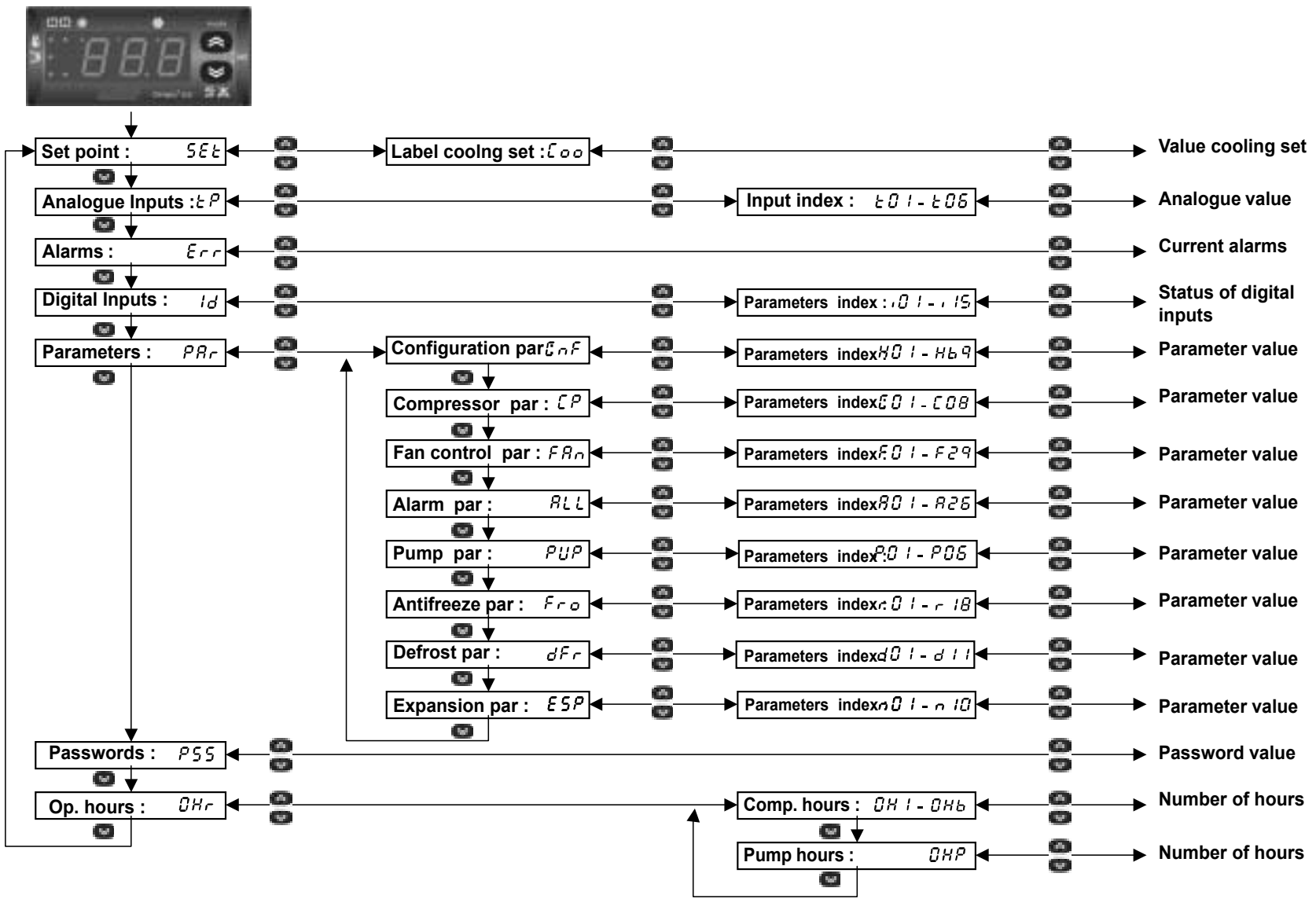

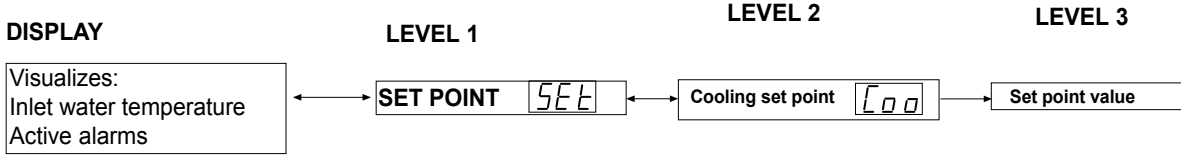

See page 8, for adjustment of set point of the system
 The water temperature is thermostatically controlled via a set point and a tolerance range (differential)
 The operation of these parameters is shown in the following diagram.

COOLING OPERATING MODE

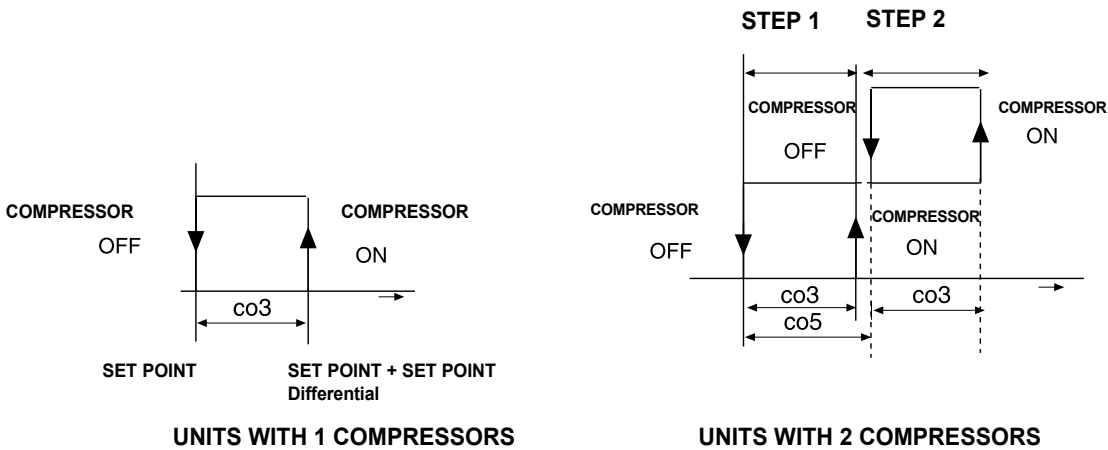

Operation with one compressor is as shown in the diagram taking into account that the temperature above which the controller takes over is the inlet water temperature. When this temperature exceeds the set point + tolerance range (differential) the compressor starts to produce cool water. When inlet water temperature gets below the set point the compressor stops. For example: if set point = 10°C and tolerance range (differential)= 2°C, the compressor will operate when the return water temperature exceeds 10°C and switch off when it returns at 10°C, and turn on again when the temperature reaches 12°C.

Condensation control is dependent on the condensation temperature or pressure for the circuit.

Fan control will be on if:

at least one probe per circuit is configured as a condensation probe (pressure or temperature);

if not, the fan for the circuit will come ON and go OFF in response to the circuit *compressors*.

Fan control may be independent of the compressor, or it may be carried out in response to requests from

HyperCodex152compressors;

Operating mode is determined by parameter *Pa F05*:

	Value	
	0	1
<i>Pa F05</i> : fan output mode	If the compressor is off, the fan is off	condensation control is independent of the compressor

When the compressor is started up, if the proportional control requests fan *cut-off*, the *cut-off* may be excluded for an amount of time equal to *Pa F12* beginning when the compressor is turned on. If the controller requests *cut-off* during this time period, the fan will run at minimum speed.

If parameter *Pa F05* is set to 1, condensation control will be dependent on condensation temperature or pressure, depending on how the following *parameters* are set:

Silent speed :

The fan control unit may have a minimum speed, a maximum speed, and a “silent” speed (for silent operation, for instance during the night), as well as a proportional band within these values.

The fan will always be off if:

there is an alarm indicating that a *condensation fan* has shut down (*refer to table of alarms*).



Energy 200 is on *stand-by* or off

CONDENSATION FAN CONTROL IN COOL MODE :

Pa F06 = Minimum fan speed in COOL mode;

Pa F07 = Maximum silent fan speed in COOL mode

Pa F08 = Minimum fan speed temperature/pressure *set point* in COOL mode

Pa F09 = Fan prop. band in COOL mode

Pa F10 = Fan *cut-off* delta

Pa F11 = *Cut-off hysteresis*.

Pa F13 = Maximum fan speed in COOL mode

Pa F14 = Maximum fan speed temperature/pressure *set point* in COOL mode

An example of interaction of these *parameters* is shown in the figure below:

Diagram :

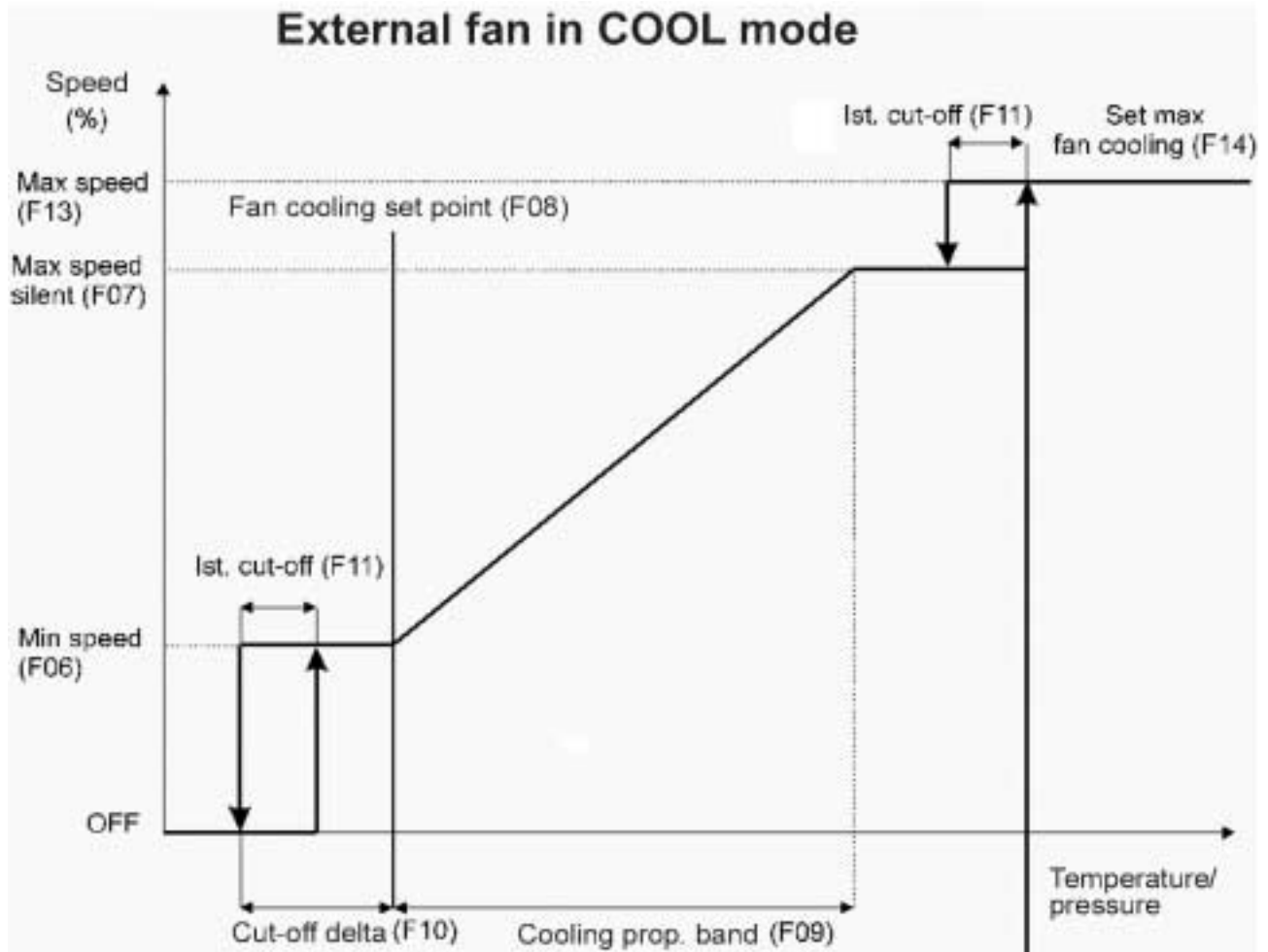

DISPLAY

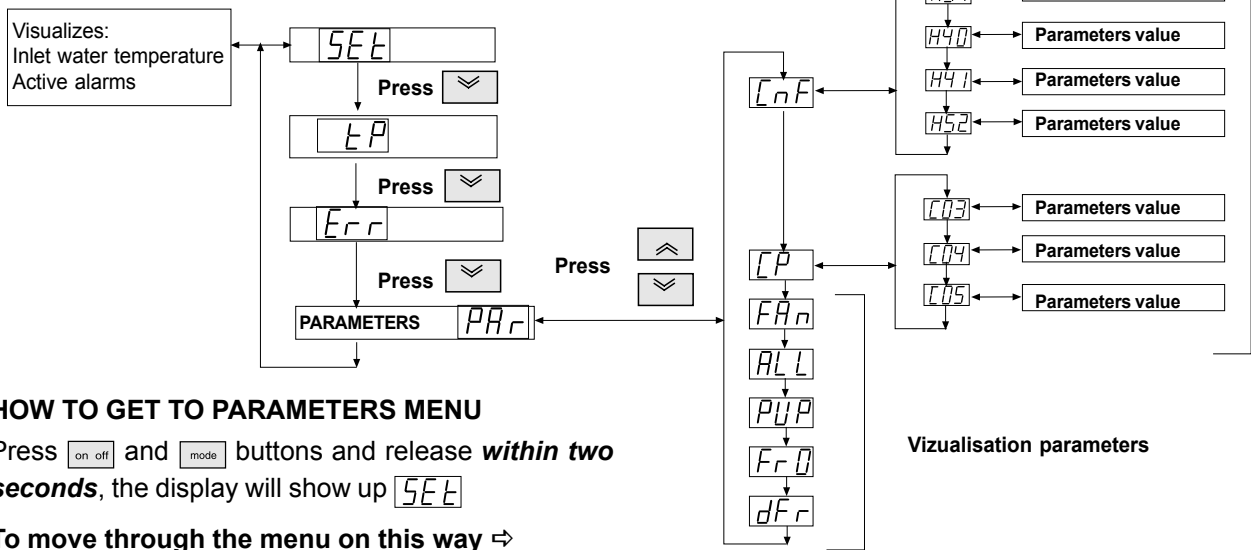

HOW TO GET TO PARAMETERS MENU

Press and buttons and release **within two seconds**, the display will show up **SEt**

To move through the menu on this way ⇔

Press and buttons simultaneously and release **within two seconds**.

To move through the menu on this way ⇐

Press and buttons simultaneously during **more than two seconds**.

To move through the menu on this way ↓, press:

To move through the menu on this way ↑, press:

- General configuration parameters of the unit (Values (F))
- General configuration parameters of the unit (Values (H))
- Parameters configuration concerning to compressor (Values (C))
- Parameters configuration concerning to fan and defrost control (Values (F))
- Parameters configuration concerning to active alarms (Values (A))
- Parameters configuration concerning to water pump (Values (P))
- Parameters configuration concerning to anti-freeze (Values (r))
- Parameters configuration concerning to defrost cycle (Values (d))
- Parameters configuration concerning extension card (Values (n))

To access to parameters modification, a password should be includes to the system, this is not necessary if you want to visualize the parameters

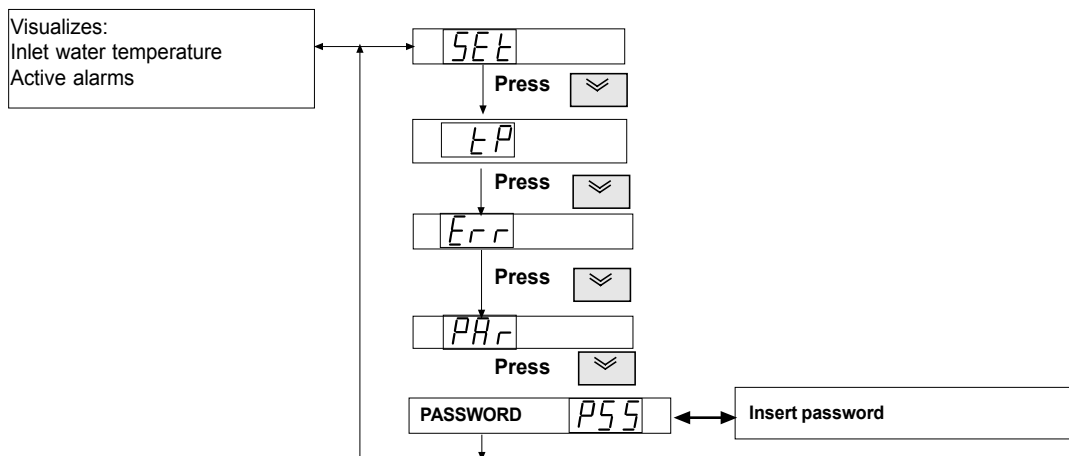

Ref.	Control Setpoints	Unit	Settings			Access			
			Min	Max	Factory	General	Password	Factory Adjust.	Hidden
G01	Cooling Setpoint	°C	6	12	6.5	X			
G02	Heating Setpoint	°C	0	0	0	-	-	X	X

Ref.	Configuration Parameters	Unit	Settings			Access			
			Min	Max	Factory	General	Password	Factory Adjust.	Hidden
H01	Maximum Heating Set Point	°C	0	90	0	-	-	X	X
H02	Minimum Heating Set Point	°C	-40	0	0	-	-	X	X
H03	Maximum Cooling Set Point	°C	6	90	12	X	-	-	
H04	Minimum Cooling Set Point	°C	-40	12	6	-	X	X	
H05	Number of Circuits (Chiller dependant)	Num	0	2	2	-	X	X	
H06	Compressors per Circuit (Chiller Dependant)	Num	0	4	2	-	X	X	
H07	Capacity Steps per compressor	Num	0	3	0	-	X	X	
H08	Compressor ON sequence 0 = Start Compressor with least running hours, Stop Compressor with most running hours. 1 = Start Compressor 1, 2, 3. Stop Compressor 3,2,1	Flag	0	1	0	-	X	X	
H09	Circuit balancing 0 = Start Compressors in Circuit 1 before Circuit 2 1 = Balance the Compressors in both Circuits	Flag	0	1	0	-	X	X	
H10	Heat Pump 0 = Chiller, 1 = Heat Pump	Flag	0	1	0	-	X	X	
H11	Configuration of Sensor ST1 1 = Entering Water Temperature	Num	0	4	1	-	X	X	
H12	Configuration of Sensor ST2 1 = Leaving Water Temperature	Num	0	3	1	-	X	X	
H13	Configuration of Sensor ST3 2 = 4-20Ma Condenser Pressure Circuit 1	Num	0	5	2	-	X	X	
H14	Configuration of Sensor ST4 3 = Outside Air Temperature	Num	0	3	3	-	X	X	
H15	Configuration of Sensor ST5 0 = No Probe	Num	0	1	0	-	X	X	
H16	Configuration of Sensor ST6 2 = 4-20Ma Condenser Pressure Circuit 2	Num	0	4	2	-	X	X	
H17	Bottom of scale pressure value	KPa*10	0	350	300	-	X	X	
H18	Polarity of Input ID1 ID2 ID3 ID4	Num	0	15	15	-	X	X	
H19	Polarity of Input ID5 ID6 ID7 ID8	Num	0	15	15	-	X	X	
H20	Polarity of Input ID9 ID10 ID11 ST4	Num	0	15	15	-	X	X	
H21	Polarity of Input ST1 (if Digital Input)	Flag	0	1	0	-	X	X	
H22	Polarity of Input ST2 (if Digital Input)	Flag	0	1	0	-	X	X	
H23	Configuration of Input ID1 10 = HIGH Pressure Circuit 1	Num	0	28	10	-	X	X	
H24	Configuration of Input ID2 12 = LOW Pressure Circuit 1	Num	0	28	12	-	X	X	
H25	Configuration of Input ID3 8 = Cond. Fan Thermal Overload Circuit 1	Num	0	28	8	-	X	X	
H26	Configuration of Input ID4 4 = Compressor Thermal Overload Circuit 1	Num	0	28	4	-	X	X	
H27	Configuration of Input ID5 11 = HIGH Pressure Circuit 2	Num	0	28	11	-	X	X	
H28	Configuration of Input ID6 13 = LOW Pressure Circuit 2	Num	0	28	13	-	X	X	
H29	Configuration of Input ID7 9 = Cond. Fan Thermal Overload Circuit 2	Num	0	28	9	-	X	X	
H30	Configuration of Input ID8 ? = Compressor Thermal Overload Circuit 2	Num	0	28	?	-	X	X	
H31	Configuration of Input ID9 0 = Not Used	Num	0	28	0	-	X	X	

Ref.	Configuration Parameters	Unit	Settings			Access			
			Min	Max	Factory	General	Password	Factory Adjust.	Hidden
H32	Configuration of Input ID10 2 = Remote ON / OFF	Num	0	28	2	-	X	X	
H33	Configuration of Input ID11 1 = Flow Switch	Num	0	28	1	-	X	X	
H34	Configuration ST4 (if Digital Input)	Num	0	28	0	-	X	X	
H35	Configuration of output RL2 9 = Compressor step 2	Num	0	17	9	-	X	X	
H36	Configuration of output RL3 0 = Disabled, 11= Compressor step 4	Num	0	17	11	-	X	X	
H37	Configuration of output RL4 0 = Disabled, 16 = Compressor step 5	Num	0	17	16	-	X	X	
H38	Configuration of output RL5 12 = Fan 2 Circuit 1	Num	0	17	12	-	X	X	
H39	Configuration of output RL6 13 = Fan 3 Circuit 1 14 = Fan 2 Circuit 2	Num	0	17	13	-	X	X	
H40	Configuration of output RL7 7 = Pump	Num	0	17	7	-	X	X	
H41	Polarity RL2	Flag	0	1	0	-	X	X	
H42	Polarity RL3	Flag	0	1	0	-	X	X	
H43	Polarity RL4	Flag	0	1	0	-	X	X	
H44	Polarity RL5	Flag	0	1	0	-	X	X	
H45	Alarm relay polarity 0 = Output ON if Alarm Active 1 = Output OFF if Alarm Active	Flag	0	1	0	-	X	X	
H46	Configuration fan 1 Circuit 1 output 0 = Triac output from TK1 1 = 4-20mA output from AN1 2 = Solid State Relay Output from TK1	Flag	0	2	2	-	X	X	
H47	Configuration fan 1 Circuit 2 output 0 = Triac output from TK1 1 = 4-20mA output from AN1 2 = Solid State Relay Output from TK1	Flag	0	2	2	-	X	X	
H48	Configuration serial protocol 0 = BMS Communications Disabled 1 = BMS Communications enabled	Flag	0	1	0	-	X	X	
H49	Selection of operating mode 0 = Selection by Keyboard	Flag	0	1	0	-	X	-	
H50	Enable dynamic set point 0 = Disable, 1 = Enable	Flag	0	1	0	-	-	X	X
H51	Offset of dynamic set point during cooling	°C	-50	80	30	-	-	X	X
H52	Offset of dynamic set point during heating	°C	-50	80	30	-	-	X	X
H53	Dynamic outdoor temp. set point during cooling	°C	-127	127	35	-	-	X	X
H54	Dynamic outdoor temp. set point during heating	°C	-127	127	-5	-	-	X	X
H55	Delta dynamic outdoor temp. set point during cooling	°C	-50	80	25	-	-	X	X
H56	Delta dynamic outdoor temp. set point during heating	°C	-50	80	28	-	-	X	X
H57	Offset Sensor 1	°C	-12.7	12.7	0	-	X	X	
H58	Offset Sensor 2	°C	-12.7	12.7	0	-	X	X	
H59	Offset Sensor 3 (Note : °C/10, Kpa*10)	°C / Kpa	-127	127	-10	-	X	X	
H60	Offset Sensor 4	°C	-12.7	12.7	0	-	X		
H61	Offset Sensor 5	°C	-12.7	12.7	0	-	-	X	X
H62	Offset Sensor 6 (Note : °C/10, Kpa*10)	°C / Kpa	-127	127	-6	-	X	X	
H63	Voltage Frequency 0=50 Hz 1=60 Hz	Flag	0	1	0	-	X	-	
H64	Temperature Display 0= °C 1=°F	Flag	0	1	0	-	X	X	
H65	Family serial address Used to set the Address of the controller when using a Modbus Interface	Num	0	14	0	-	X	X	
H66	Device serial address Used to set the Address of the controller when using a Modbus Interface	Num	0	14	0	-	X	X	
H67	User password	Num	0	255	See LENNET	-	X	X	
H68	Copy card password Factory use only	Num	0	255	See LENNET	-	X	X	
H69	Keyboard Present	Flag	0	1	1	-	X	X	

Ref.	Compressor Parameters	Unit	Settings			Access			
			Min	Max	Factory	General	Password	Factory Adjust.	Hidden
C01	ON-OFF safety time	s*10	0	255	6	-	X		
C02	ON-ON safety time	s*10	0	255	30	-	X	X	
C03	Cooling Control Hysteresis	°C	0	25.5	1	-	X		
C04	Heating Control Hysteresis	°C	0	25.5	1.5	-	X	X	
C05	Regulation algorithm step intervention delta	°C	0	25.5	1.5	-	X		
C06	Compressor – compressor ON interval	s	0	255	60	-	X		
C07	Compressor – compressor OFF interval	s	0	255	30	-	X		
C08	Capacity step ON interval	s	0	255	60	-	X		

Ref.	Condenser Fan Parameters	Unit	Settings			Access			
			Min	Max	Factory	General	Password	Factory Adjust.	Hidden
F01	Fan output mode	Num	0	2	0	-	X	X	
F02	Fan pick-up time	s/10	0	255	20	-	X		
F03	Fan-Shift	%	0	100	8	-	X	X	
F04	Impulse Duration triac start	uS*100	0	255	30	-	X	X	
F05	Functioning in response to compressor request	Flag	0	1	0	-	X	X	
F06	Minimum speed during cooling	%	0	100	0	-	X	-	
F07	Maximum silent speed during cooling	%	0	100	100	-	X	-	
F08	Minimum fan speed temperature/pressure set point during cooling	°C/10-Kpa*10	-500	800	120	-	X		
F09	Prop. Band during cooling	°C/10-Kpa*10	0	255	30	-	X		
F10	Delta cut-off	°C/10-Kpa*10	0	255	0	-	X		
F11	Cut-off hysteresis.	°C/10-Kpa*10	0	255	25	-	X		
F12	Bypass time cut-off	s	0	255	10	-	X		
F13	Max speed during cooling	%	0	100	100	-	X		
F14	Maximum fan speed temperature/pressure set point during cooling	°C/10-Kpa*10	-500	800	150	-	X		
F15	Minimum speed during heating	%	0	100	100	-	X	X	
F16	Maximum silent speed during heating	%	0	100	100	-	X	X	
F17	Minimum fan speed temperature/pressure set point during heating	°C/10-Kpa*10	-500	800	10	-	X	X	
F18	Prop. Band during heating	°C/10-Kpa*10	0	255	50	-	X	X	
F19	Maximum fan speed during heating	%	0	100	100	-	X	X	
F20	Maximum fan speed temperature/pressure set point during heating	°C/10-Kpa*10	-500	800	450	-	X	X	
F21	Preventilation in cooling mode	s	0	255	0	-	X	X	
F22	Combined or separate fan control 0= Fans control to separate Circuits 1= Fans control to common Circuits	Flag	0	1	1	-	X	X	
F23	Fan activation temperature/pressure set point during defrosting	°C/10-Kpa*10	-500	800	-500	-	X	X	
F24	Fan activation hysteresis during defrosting	°C/10-Kpa*10	0	255	10	-	X	X	
F25	Set 2nd fan step Cooling	°C/10-Kpa*10	-500	800	175	-	X		
F26	Set 3rd fan step Cooling	°C/10-Kpa*10	-500	800	190	-	X		
F27	Set 2nd fan step Heating	°C/10-Kpa*10	-500	800	-500	-	X	X	
F28	Set 3rd fan step Heating	°C/10-Kpa*10	-500	800	-500	-	X	X	
F29	Duty cycle period for "DC" output	s	1	10	5	-	X	X	

Ref.	Alarm Parameters	Unit	Settings			Access			
			Min	Max	Factory	General	Password	Factory Adjust.	Hidden
A01	L/P switch bypass time after compressor on	s	0	255	120	-	X		
A02	Low pressure alarm events per hour	Num	0	255	3	-	X	-	
A03	Flow switch bypass time after pump on	s	0	255	50	-	X	-	
A04	Duration of flow switch input active	s	0	255	10	-	X	-	
A05	Duration of flow switch input inactive	s	0	255	30	-	X	-	
A06	Number of flow switch alarm events per hour	Num	0	255	5	-	X	-	
A07	Bypass compressor thermal switch from compressor on	s	0	255	0	-	X	-	
A08	Number of compressor thermal switch alarms/hour	Num	0	255	3	-	X	-	
A09	Number of fan thermal switch alarms/hour	Num	0	255	20	-	X	X	
A10	Anti-freeze alarm bypass after ON-OFF	Min	0	255	0	-	X	X	
A11	Anti-freeze alarm activation set point	°C	-127	127	3	-	X	X	
A12	Hysteresis of anti-freeze alarm	°C	0	25.5	1	-	X	-	
A13	Anti-freeze alarm events/hour	Num	0	255	3	-	X	-	
A14	High pressure/temperature activation set point	°C/10-Kpa*10	0	900	350	-	X	X	
A15	High pressure hysteresis	°C/10-Kpa*10	0	255	30	-	X	X	
A16	Low pressure activation bypass	s	0	255	10	-	X	X	
A17	Low pressure activation set point	°C/10-Kpa*10	-500	800	-500	-	X	X	
A18	Low pressure hysteresis	°C/10-Kpa*10	0	255	20	-	X	X	
A19	Low pressure alarm events per hour	Num	0	255	3	-	X	X	
A20	Machine out of coolant differential	°C	0	255	1	-	X	X	
A21	Machine out of coolant bypass	Min	0	255	1	-	X	X	
A22	Machine out of coolant duration	Min	0	255	3	-	X	X	
A23	Machine out of coolant alarm triggered	Flag	0	1	0	-	X	X	
A24	Enable low pressure alarm during defrost	Flag	0	1	0	-	X	X	
A25	Input over-temperature set point	°C	0	255	30	-	X	-	
A26	Input over-temperature duration	s*10	0	255	60	-	X	-	

Ref.	Pump Parameters	Unit	Settings			Access			
			Min	Max	Factory	General	Password	Factory Adjust.	Hidden
P01	Pump operating mode 0= Continuous operation 1= Pump start upon demand from controller	Flag	0	1	0	-	X	X	
P02	Delay between pump ON and compressor ON	s	0	255	120	-	X		
P03	Delay between compressor OFF and pump OFF	s	0	255	255	-	X		
P04	Set start Pump on external temperature	°C/10	-500	800	50	-	X		
P05	Set stand-by on external temperature	°C/10	-500	800	0	-	X		
P06	Hysteresis Pump on external temperature	°C/10	0	255	10	-	X		

Ref.	Anti Freeze Parameters	Unit	Settings			Access			
			Min	Max	Factory	General	Password	Factory Adjust.	Hidden
R01	Configuration of electrical heaters in defrost mode	Flag	0	1	1	-	X	X	
R02	Configuration of electrical heaters on in cooling mode 0= Off during cooling 1= On in cooling if called by the Anti freeze program	Flag	0	1	1	-	X	X	
R03	Configuration of electrical heaters on in heating mode 0= Off during heating 1= On in heating if called by the Anti freeze program	Flag	0	1	1	-	X	X	
R04	Configuration of electrical heater 1 control probe	Num	0	3	1	-	X	X	
R05	Configuration of electrical heater 2 control probe	Num	0	3	2	-	X	X	
R06	Configuration of electrical heaters when Unit is OFF or on STAND-BY 0= Off 1= On in if called by the Anti freeze program	Flag	0	1	1	-	X	X	
R07	Set point of electrical heater 1 in heating mode	°C	-7	8	4	-	X	X	
R08	Set point of electrical heater 1 in cooling mode	°C	-7	8	4	-	X	X	
R09	Max. set point electrical heaters	°C	-7	127	8	-	X	X	
R10	Min. set point electrical heaters	°C	-127	8	-7	-	X	X	
R11	Hysteresis of anti-freeze heaters	°C	0	255	1	-	X	X	
R12	Parallel electrical heater enable	Flag	0	1	1	-	X	X	
R13	Set point of electrical heater 2 in heating mode	°C	-7	8	4	-	X	X	
R14	Set point of electrical heater 2 in cooling mode	°C	-7	8	4	-	X	X	
R15	Enable supplementary electrical heaters	Flag	0	1	1	-	X	X	
R16	Delta of activation of supplementary heater 1	°C	0	25.5	2	-	X	X	
R17	Delta of activation of supplementary heater 2	°C	0	25.5	3	-	X	X	
R18	Status of with pump OFF	Flag	0	1	0		X	X	

Ref.	Defrost Parameters	Unit	Settings			Access			
			Min	Max	Factory	General	Password	Factory Adjust.	Hidden
D01	Defrost enabled	Flag	0	1	0	-	X	X	
D02	Defrost start temperature/pressure	°C/10-Kpa*10	-500	800	30	-	X	X	
D03	Defrost interval	Min	0	255	4	-	X	X	
D04	Defrost end temperature/pressure	°C/10-Kpa*10	-500	800	180	-	X	X	
D05	Maximum defrost time	Min	0	255	6	-	X	X	
D06	Compressor-reversing valve wait time	s	0	255	5	-	X	X	
D07	Drip time	s	0	255	5	-	X	X	
D08	Delay between defrosting of circuits	s * 10	0	255	5	-	X	X	
D09	Output probe defrost circuit 1	Num	0	3	1	-	X	X	
D10	Output probe defrost circuit 2	Num	0	3	1	-	X	X	
D11	Delay in compressors on in defrost mode	s	0	255	0	-	X	X	

Ref.	Expansion Card Parameters	Unit	Settings			Access			
			Min	Max	Factory	General	Password	Factory Adjust.	Hidden
N01	Polarity of ID12 ID13 ID14 ID15	Num	0	15	0	-	X	X	
N02	Configuration ID12	Num	0	28	0	-	X	X	
N03	Configuration ID13	Num	0	28	0	-	X	X	
N04	Configuration ID14	Num	0	28	0	-	X	X	
N05	Configuration ID15	Num	0	28	0	-	X	X	
N06	Configuration relay 9	Num	0	17	0	-	X	X	
N07	Configuration relay 10	Num	0	17	0	-	X	X	
N08	Configuration relay 11	Num	0	17	0	-	X	X	
N09	Configuration relay 12	Num	0	17	0	-	X	X	

An **Alarm code** will be displayed if at least one alarm is active. If multiple alarms are active, the one with greater priority will be displayed according to the Table of Alarms.

Alarm Events Per Hour

Alarms which are Manual Reset are reset by pressing the ON/OFF  button and releasing

CODE	INDICATES	DESCRIPTION
E00	Remote off	All loads will be shut down.
E01	High pressure Fault circuit 1	Digital Input All Compressors in circuit 1 will be shut down Manual Reset Required
E02	Low pressure circuit 1	All Compressors in circuit 1 will be shut down; also condenser fans if separate for the 2 circuits Automatically reset unless alarm events per hour reaches the value of parameter Pa A02 , after which manually reset; Inactive during timer Pa A01 after compressor on in circuit 1
E03	Compressor Thermal protection Circuit 1	All Compressors in Circuit 1 will be shut down; Automatic reset until alarm events per hour reaches the value of parameter Pa A07 , after which manually reset; Inactive during timer Pa A08 after compressor on.
E04	Condenser Fan Thermal protection circuit 1	Fans and compressors in circuit 1 will be shut down; If Common to both Circuits Compressors in circuit 2 will also be shut down; Automatically reset until alarm events per hour reaches the value of parameter Pa A09 , after which manually reset;
E05	Anti-freeze circuit 1	Fans and compressors in circuit 1 will be shut down; Triggered when Leaving Water Temperature is lower than Pa A11 ; Turned off if probe Leaving Water Temperature is greater than Pa A11 + Pa A12 ; Automatically reset until alarm events per hour reaches the value of parameter Pa A13 , after which manually reset; Inactive during timer Pa A10 after the Chiller is turned on with the On-OFF key via the keyboard or from the remote ON-OFF input.
E06	Leaving Water Sensor fault	All loads will be shut down; Input shorted or open circuit or probe limits are exceeded (-50°C.. 100°C).
E07	Condenser Sensor Circuit 1 fault	All loads will be shut down; Input shorted or open circuit or probe limits are exceeded (-50°C.. 100°C).
E09	Not Used	Not used
E11	High pressure circuit 1 on analog input	Compressors in circuit 1 will be shut down; Active when Circuit 1 pressure sensor detects a value greater then Pa A14 ; Inactive if the sensor detects a value lower then Pa A14 – Pa A15 ;
E12	Low pressure circuit 1 on analog input	Compressors in circuit 1 will be shut down, as well as condenser fans if the 2 circuits have separate condensation (refer to combined or separate condensation); Active if the analog probe ST6 (refer to analog inputs) is configured as pressure probe; Active when the pressure probe ST6 detects a value lower then Pa A17; Inactive if the probe detects a value greater then Pa A17 – Pa A18 ; Automatically <i>reset</i> until <i>alarm events per hour</i> reaches the value of parameter Pa A19 , after which manually <i>reset</i> ; Inactive during timer Pa A16 after compressor on or reversal of 4-way valve (<i>reversing valve</i>) of circuit 1
E13	Compressor Thermal protection Circuit 2	All Compressors in Circuit 1 will be shut down; Automatic reset until alarm events per hour reaches the value of parameter Pa A07 , after which manually reset; Inactive during timer Pa A08 after compressor on.
E19	Not Used	Not used
E21	High pressure Fault circuit 2	Digital Input All Compressors in circuit 2 will be shut down Manual Reset Required
E22	Low pressure circuit 2	All Compressors in circuit 2 will be shut down; also condenser fans if separate for the 2 circuits Automatically reset unless alarm events per hour reaches the value of parameter Pa A02 , after which manually reset; Inactive during timer Pa A01 after compressor on in circuit 2
E23	Not Used	Not Used
E24	Condenser Fan Thermal protection circuit 2	Fans and compressors in circuit 2 will be shut down; If Common to both Circuits Compressors in circuit 1 will also be shut down; Automatically reset until alarm events per hour reaches the value of parameter Pa A09 , after which manually reset;
E25	Not Used	Not Used
E26	Not Used	Not Used
E27	Condenser Sensor Circuit 2 fault	All loads will be shut down; Input shorted or open circuit or probe limits are exceeded (-50°C.. 100°C).

E29	Not Used	Not Used
E31	High pressure circuit 2 on analog input	Compressors in circuit 2 will be shut down; Active when Circuit 2 pressure sensor detects a value greater then Pa A14 ; Inactive if the sensor detects a value lower then Pa A14 – Pa A15 ;
E32	Low pressure circuit 2 on analog input	Compressors in circuit 2 will be shut down, as well as condenser fans if the 2 circuits have separate condensation (refer to <i>combined or separate condensation</i>); Active if the analog probe ST6 (refer to analog inputs) is configured as pressure probe; Active when the pressure probe ST6 detects a value lower then Pa A17 ; Inactive if the probe detects a value greater then Pa A17 – Pa A18 ; Automatically <i>reset</i> until <i>alarm events per hour</i> reaches the value of parameter Pa A19 , after which manually <i>reset</i> ; Inactive during timer Pa A16 after compressor on or reversal of 4-way valve (<i>reversing valve</i>) of circuit 2
E33	Not Used	Not Used
E39	Not Used	Not Used
E40	Entering Water Temperature Sensor fault	All loads will be shut down; Input shorted or open circuit or probe limits are exceeded (-50°C.. 100°C).
E41	Flow switch	All compressors, fans and pump will be cut off if manually reset; Triggered if the “Flow switch” remains active for an amount of time equal to Pa A04 ; Goes off if “Flow switch” remains inactive for an amount of time equal to Pa A05 ; Automatically reset until alarm events per hour reaches the value of parameter Pa A06 , after which manually reset; Inactive during timer Pa A03 following pump on.
E42	Outside Air Sensor fault	All loads will be shut down; Input shorted or open circuit or probe limits are exceeded (-50°C.. 100°C).
E43	Anti-freeze external circuit 1,2	Fans and <i>compressors</i> will be shut down; Active if analogue probe ST6 and/or ST3 (refer to <i>analogue inputs</i>) is configured as external anti-freeze probe (Pa H13 = 4, Pa H16=4); Triggered when probe ST3 and/or ST6 detects a value below Pa A11 ; Turns off when probe ST3 and/or ST6 detects a value above Pa A11 + Pa A12 ; Automatically <i>reset</i> until <i>alarm events per hour</i> reaches value of parameter Pa A13 , after which manually <i>reset</i> ; Inactive during timer Pa A10 after turning on Energy 400 using On-OFF key (refer to <i>keyboard</i>) or digital input ON-OFF (refer to <i>digital inputs</i>) or start of <i>heating</i> mode.
E44	Machine out of coolant	In all working modes, except if the boiler is active and during <i>defrost</i> , the machine is checked to identify circuit failures. For example: gas flooding, broken inversion valve in heat pump machines, compressor power phases exchange. The regulator is active if Pa A23=1 and ST2 is configured as water output probe. An alarm arises if one of the following conditions lasts for a minimum time of Pa A22 : ST2-ST1(or ST3)< Pa A20 in heat pump configuration, ST1(or ST3)-ST2< Pa A20 in <i>cooling</i> configuration. The gas flooding alarm always needs a <i>manual reset</i> . Time count resets with each mode change or if all the <i>compressors</i> are off. After a compressor start, the alarm is ignored for a time of Pa A21 .
E45	Configuration error	All <i>loads</i> will be shut down; Triggered if at least one of the following conditions apply: H11= 2 (ST1 configured as request for <i>heating</i>), H12= 2 (ST2 configured as request for <i>cooling</i>) and both inputs are active. Sum of <i>compressors</i> and capacity steps on machine exceeds 4 The <i>keyboard</i> is declared present (Pa H69=1) and there is no communication between the <i>keyboard</i> and the basic unit.
E46	High temperature regulation algorithm	All <i>loads</i> will be shut down except the pump; Triggered if probe ST1 (refer to <i>analogue inputs</i>) has a value exceeding Pa A25 for an amount of time exceeding Pa 26 in <i>cooling</i> mode; Goes off if probe ST1 (refer to <i>analogue inputs</i>) has a value lower than Pa A25 – Pa A12 ; Automatically <i>reset</i> .
E47	Not Used	Not Used
E48	Not Used	Not Used
E49	Not Used	Not Used
E50	Not Used	Not Used
E89	Not Used	Not Used

Alarms

Basic CLIMATIC™ can perform full systems diagnostics and signal a series of alarms.

Alarm trigger and reset modes are set using parameters Pa A01 – Pa A26.

Alarms events per hour

For some alarms the signal will not be given for a certain amount of time, determined by a parameter.

For some alarms the number of alarm events is counted; if the number of alarm events in the past hour

exceeds a certain threshold set by a parameter, the alarm will switch from automatic to manual reset.

Alarms are sampled every 226 seconds;

Example: if the number of events/hour is set to 3, the duration of an alarm must fall between 2*226 seconds and 3*226

seconds for the alarm to be switched from automatic to manual reset.



 If an alarm is triggered more than once within one sampling period (226 seconds), only one alarm will be counted.

Alarms with manual reset are reset by pressing the ON-OFF button and releasing.

Manual reset shuts down corresponding **loads** and requires an operator to intervene (**reset** the alarm using the ON-OFF control).

 **Manual reset alarms** are used mainly to identify problems which could result in damage to the system.

Alarm code	DESCRIPTION	EFFECT	Reset	ACTION
E01	High pressostat alarm This alarm may indicate the following problems: - High pressostat protection - Compressor electrical protection (only EAC 047 o 081) - Indoor fan electrical protection - Fuses of the fan burn out	Unit stops	Manual	Press the ON/OFF button, until the alarm disappeared, if the alarm shows up again check: •Coil clean and no blocked. • Water flow on the cooling cycle •Check fuses of the fan
E02	Low presostat alarm This alarm may indicate the following problems: - Low amount of refrigerant - Low water flow in cooling cycle - Blocked coil in heating cycle - Fuses of the fan burn out After two automatic resets in one hour, it comes to be a manual reset	Compressor 1 stops	Manual	When this alarm shows up repeteally, and the alarm keeps on, make a electrical reset and check: •Coil clean and no blocked. • Water flow on the cooling cycle •Check fuses of the fan •Check refrigerant charge.
E03	Compressor and fan thermal protection alarm: - Compressor and fan thermal protection open - Faulty power supply	Compressor 1 stops	Manual	Press the ON/OFF button until the alarm disappeared, if alarm shows up again check continuity and change the faulty component •Check refrigerant charge •Check the refrigerant circuit is not blocked •Check connections and fuseses •Check power supply

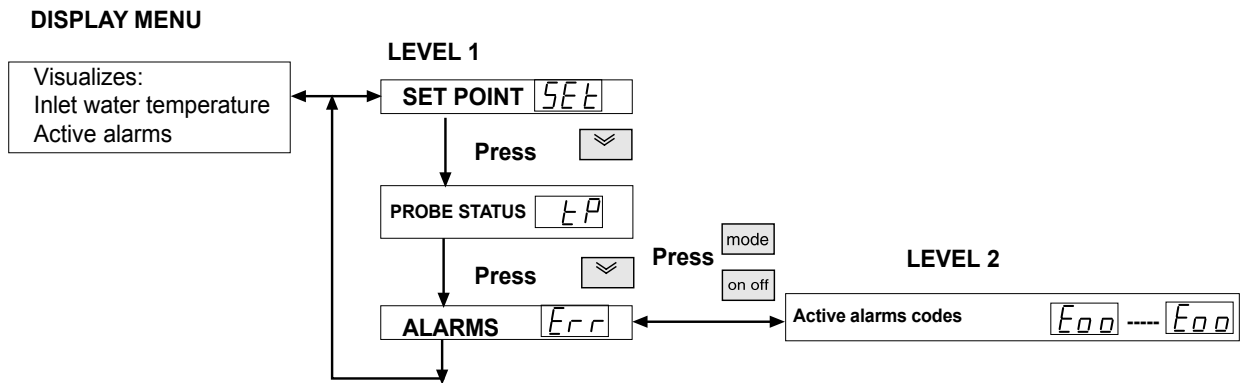

The unit self-protect through safety devices, when any of these safety devices detect an anomaly, shown in the display in order to advice the installer.

The activation of an alarm brings about:

- The display of the alarm code beginning with the letter E and follows a number, if more than one alarm will be activated, the alarm visualized would be the one with the lowest numerical value.- The blocking of some or all the outputs, depending on the type of alarm.

E00 This display is not an alarm, it indicates that unit is turn off from ON /OFF remote.

VIS (Visualization) :Indicates the type of alarm shows on the display.

RE (Reset) : Type of reset: To enable the alarms:

AUT: AUTOMATIC RESET: Some alarms are automatically reset, when the cause is no longer present, they disappear from the display.

MAN: MANUAL RESET: Pressing ON/OFF button, for **more than 2 seconds**.

If the alarm conditions have been removed, the instrument returns to the normal operation and the alarm relay is de-energized. If on the other hand, the alarm conditions persist, then call for technical service.

STANDARD EXTENSION CARD (EX 1)

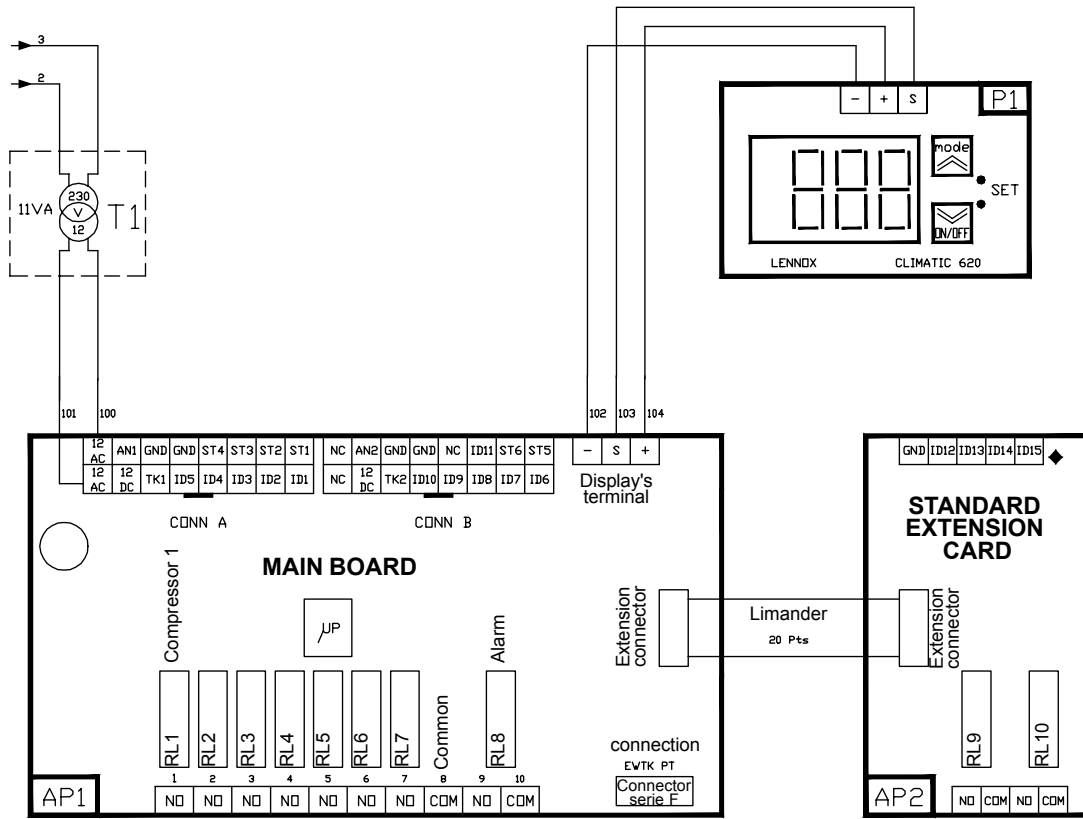

LENNOX EXTENSION CARD (EX 2)

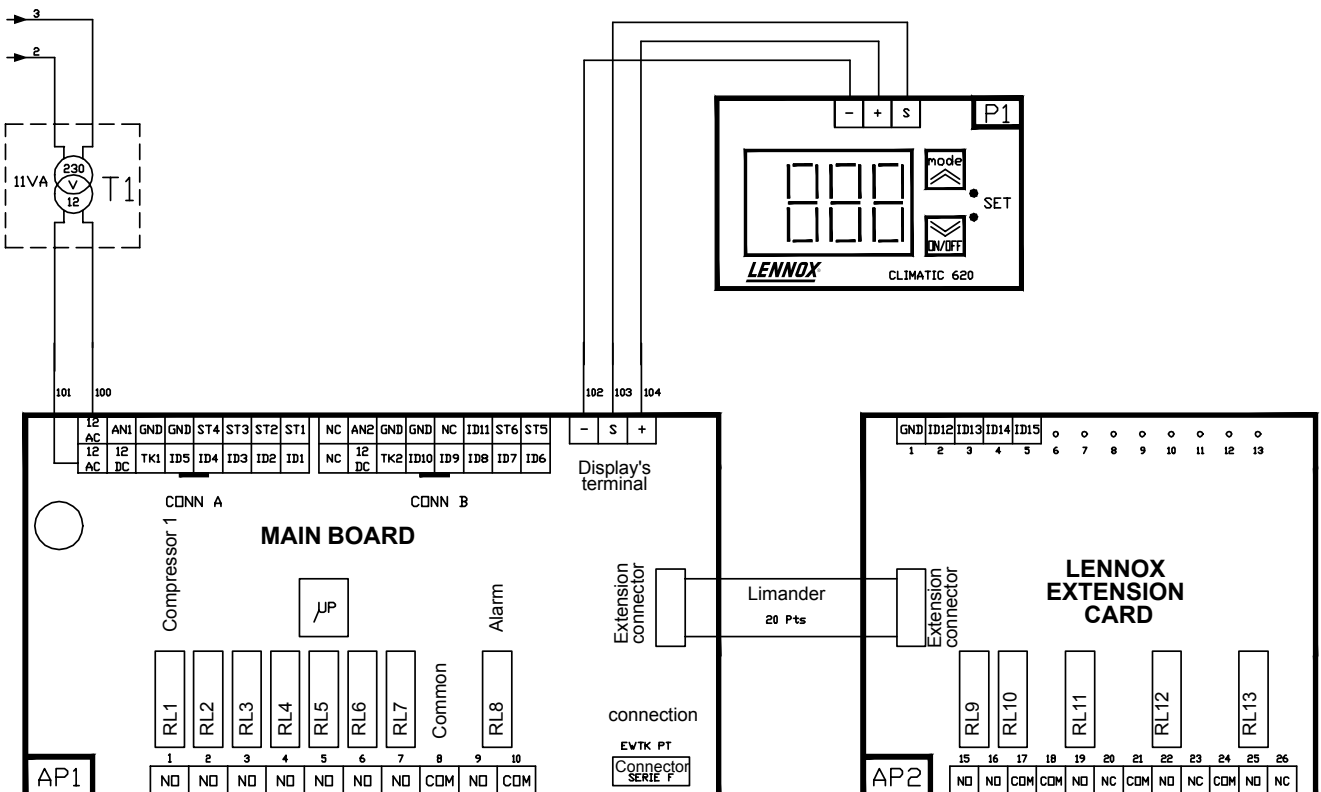

OUTPUTS (for Chiller WA)										
	1 circuit 3 compressors 2 Fans		1 circuit 3 compressors 3 Fans		2 circuits 4 compressors 2 Fans common		2 circuits 4 compressors 3 Fans common		2 circuits 4 compressors 4 Fans	
RL1	CM1	Comp 1 Cir 1	CM1	Comp 1 Cir 1	CM1	Comp 1 Cir 1	CM1	Comp 1 Cir 1	CM1	Comp 1 Cir 1
RL2	CM2	Comp 2 Cir 1	CM2	Comp 2 Cir 1	CM2	Comp 2 Cir 1	CM2	Comp 2 Cir 1	CM2	Comp 2 Cir 1
RL3	CM3	Comp 3 Cir 1	CM3	Comp 3 Cir 1	CM3	Comp 1 Cir 2	CM3	Comp 1 Cir 2	CM3	Comp 1 Cir 2
RL4	n.u.		n.u.		CM4	Comp 2 Cir 2	CM4	Comp 2 Cir 2	CM4	Comp 2 Cir 2
RL5	CF2	Fan 2 Cir 1 TOR	CF2	Fan 2 Cir 1 TOR	CF2	Fan 2 TOR	CF2	Fan 2 TOR	CF2	Fan 2 Cir 1 TOR
RL6	CF3	Fan 1 Cir 1 GV TOR	CF3	Fan 1 GV & 3 Cir 1 TOR	CF3	Fan 1 GV TOR	CF3	Fan 1 GV & 3 TOR	CF3	Fan 1 GV Cir 1 TOR
RL7	TP	Pump	TP	Pump	TP	Pump	TP	Pump	TP	Pump
RL8	Pf	Alarm	Pf	Alarm	Pf	Alarm	Pf	Alarm	Pf	Alarm
RL9 (Ex1) or (Ex2)	n.u.		n.u.		n.u.		n.u.		CF5	Fan 2 Cir 2 TOR
RL10 (Ex1) or (Ex2)	n.u.		n.u.		n.u.		n.u.		CF6	Fan 1 GV Cir 2 TOR
RL11 (Ex2)	n.u.		n.u.		n.u.		n.u.		n.u.	
RL12 (Ex2)	n.u.		n.u.		n.u.		n.u.		n.u.	
RL13 (Ex2)	n.u.		n.u.		n.u.		n.u.		n.u.	
TK1*	CF1	Fan 1 Cir 1 PV prop./TOR	CF1	Fan 1 Cir 1 PV prop./TOR	CF1	Fan 1 PV prop./TOR	CF1	Fan 1 PV prop./TOR	CF1	Fan 1 Cir 1 PV prop./TO
TK2*	n.u.		n.u.		n.u.		n.u.		CF4	Fan 1 Cir 2 PV prop./TO
AN1	n.u.		n.u.		n.u.		n.u.		n.u.	
AN2	n.u.		n.u.		n.u.		n.u.		n.u.	

INPUTS (for Chiller WA)										
ID1	HD1	HP Cir 1	HD1	HP Cir 1	HD1	HP Cir 1	HD1	HP Cir 1	HD1	HP Cir 1
ID2	LD1	LP Cir 1	LD1	LP Cir 1	LD1	LP Cir 1	LD1	LP Cir 1	LD1	LP Cir 1
ID3	PfCF1	Term. Fan Cir 1	PfCF1	Term. Fan Cir 1	PfCF1	Term. Fan	PfCF	Term. Fan	PfCF1	Term. Fan Cir 1
ID4	PfCP1	Term. Cp Cir 1	PfCP1	Term. Cp Cir 1	PfCP1	Term. Cp Cir 1	PfCP1	Term. Cp Cir 1	PfCP1	Term. Cp Cir 1
ID5	n.u.		n.u.		HD2	HP Cir 2	HD2	HP Cir 2	HD2	HP Cir 2
ID6	n.u.		n.u.		LD2	LP Cir 2	LD2	LP Cir 2	LD2	LP Cir 2
ID7	n.u.		n.u.		n.u.		n.u.		PfCF2	Term. Fan Cir 2
ID8	n.u.		n.u.		PfCP2	Term. Cp Cir 2	PfCP2	Term. Cp Cir 2	PfCP2	Term. Cp Cir 2
ID9	n.u.		n.u.		n.u.		n.u.		n.u.	
ID10	Sc	Rem. On/Off	Sc	Rem. On/Off	Sc	Rem. On/Off	Sc	Rem. On/Off	Sc	Rem. On/Off
ID11	FS	Flow Switch	FS	Flow Switch	FS	Flow Switch	FS	Flow Switch	FS	Flow Switch
ID12 (Ex1) or (Ex2)	n.u.		n.u.		n.u.		n.u.		n.u.	
ID13 (Ex1) or (Ex2)	n.u.		n.u.		n.u.		n.u.		n.u.	
ID14 (Ex1) or (Ex2)	n.u.		n.u.		n.u.		n.u.		n.u.	
ID15 (Ex1) or (Ex2)	n.u.		n.u.		n.u.		n.u.		n.u.	
ST1	Tw1	H2O Inlet	Tw1	H2O Inlet	Tw1	H2O Inlet	Tw1	H2O Inlet	Tw1	H2O Inlet
ST2	Twu1	H2O Outlet cir1	Twu1	H2O Outlet cir1	Twu1	H2O Outlet cir1	Twu1	H2O Outlet cir1	Twu1	H2O Outlet cir1
ST3	Tc1	T cond cir1	Tc1	T cond cir1	Tc1	T cond cir1	Tc1	T cond cir1	Tc1	T cond cir1
ST4	Ta	Tamb	Ta	Tamb	Ta	Tamb	Ta	Tamb	Ta	Tamb
ST5	n.u.		n.u.		n.u.		n.u.		n.u.	
ST6	n.u.		n.u.		Tc2	T cond cir2	Tc2	T cond cir2	Tc2	T cond cir2

* **NOTA** : ON TK1 AND TK2 OUTPUTS, FANS CAN BE ON/OFF (FOR STD VERSION) OR PROPORTIONNAL (STD PLUS, LN, SLN, HE)

 Main board

 Ex1
Standard Extension Board

 Ex2
Lennox Extension Board

PV : Low speed
GV : High speed
TOR : ON/OFF
n.u. : Not used

OUTPUTS (for Condensing Units RA)										
	1 circuit 3 compressors 2 Fans		1 circuit 3 compressors 3 Fans		2 circuits 4 compressors 2 Fans common		2 circuits 4 compressors 3 Fans common		2 circuits 4 compressors 4 Fans	
RL1	CM1	Comp 1 Cir 1	CM1	Comp 1 Cir 1	CM1	Comp 1 Cir 1	CM1	Comp 1 Cir 1	CM1	Comp 1 Cir 1
RL2	CM2	Comp 2 Cir 1	CM2	Comp 2 Cir 1	CM2	Comp 2 Cir 1	CM2	Comp 2 Cir 1	CM2	Comp 2 Cir 1
RL3	CM3	Comp 3 Cir 1	CM3	Comp 3 Cir 1	CM3	Comp 1 Cir 2	CM3	Comp 1 Cir 2	CM3	Comp 1 Cir 2
RL4	n.u.		n.u.		CM4	Comp 2 Cir 2	CM4	Comp 2 Cir 2	CM4	Comp 2 Cir 2
RL5	CF2	Fan 2 Cir 1 TOR	CF2	Fan 2 Cir 1 TOR	CF2	Fan 2 TOR	CF2	Fan 2 TOR	CF2	Fan 2 Cir 1 TOR
RL6	CF3	Fan 1 Cir 1 GV TOR	CF3	Fan 1 GV & 3 Cir 1 TOR	CF3	Fan 1 GV TOR	CF3	Fan 1 GV & 3 TOR	CF3	Fan 1 GV Cir 1 TOR
RL7	TP	Pump	TP	Pump	TP	Pump	TP	Pump	TP	Pump
RL8	Pf	Alarm	Pf	Alarm	Pf	Alarm	Pf	Alarm	Pf	Alarm
RL9 (Ex1) or (Ex2)	n.u.		n.u.		n.u.		n.u.		CF5	Fan 2 Cir 2 TOR
RL10 (Ex1) or (Ex2)	n.u.		n.u.		n.u.		n.u.		CF6	Fan 1 GV Cir 2 TOR
RL11 (Ex2)	n.u.		n.u.		n.u.		n.u.		n.u.	
RL12 (Ex2)	n.u.		n.u.		n.u.		n.u.		n.u.	
RL13 (Ex2)	n.u.		n.u.		n.u.		n.u.		n.u.	
TK1*	CF1	Fan 1 Cir 1 PV prop./TOR	CF1	Fan 1 Cir 1 PV prop./TOR	CF1	Fan 1 PV prop./TOR	CF1	Fan 1 PV prop./TOR	CF1	Fan 1 Cir 1 PV prop./TO
TK2*	n.u.		n.u.		n.u.		n.u.		CF4	Fan 1 Cir 2 PV prop./TO
AN1	n.u.		n.u.		n.u.		n.u.		n.u.	
AN2	n.u.		n.u.		n.u.		n.u.		n.u.	

INPUTS (for Condensing Units RA)										
ID1	HD1	HP Cir 1	HD1	HP Cir 1	HD1	HP Cir 1	HD1	HP Cir 1	HD1	HP Cir 1
ID2	LD1	LP Cir 1	LD1	LP Cir 1	LD1	LP Cir 1	LD1	LP Cir 1	LD1	LP Cir 1
ID3	PfCF1	Term. Fan Cir 1	PfCF1	Term. Fan Cir 1	PfCF	Term. Fan	PfCF	Term. Fan	PfCF1	Term. Fan Cir 1
ID4	PfCP1	Term. Cp Cir 1	PfCP1	Term. Cp Cir 1	PfCP1	Term. Cp Cir 1	PfCP1	Term. Cp Cir 1	PfCP1	Term. Cp Cir 1
ID5	n.u.		n.u.		HD2	HP Cir 2	HD2	HP Cir 2	HD2	HP Cir 2
ID6	n.u.		n.u.		LD2	LP Cir 2	LD2	LP Cir 2	LD2	LP Cir 2
ID7	Sc	Rem. On/Off	Sc	Rem. On/Off	Sc	Rem. On/Off	Sc	Rem. On/Off	PfCF2	Term. Fan Cir 2
ID8	n.u.		n.u.		PfCP2	Term. Cp Cir 2	PfCP2	Term. Cp Cir 2	PfCP2	Term. Cp Cir 2
ID9	Term2	Step 2	Term2	Step 2	Term2	Step 2	Term2	Step 2	Term2	Step 2
ID10	Term3	Step 3	Term3	Step 3	Term3	Step 3	Term3	Step 3	Term3	Step 3
ID11	n.u.		n.u.		Term4	Step 4	Term4	Step 4	Term4	Step 4
ID12 (Ex1) or (Ex2)	n.u.		n.u.		n.u.		n.u.		n.u.	
ID13 (Ex1) or (Ex2)	n.u.		n.u.		n.u.		n.u.		n.u.	
ID14 (Ex1) or (Ex2)	n.u.		n.u.		n.u.		n.u.		Sc	Rem. On/Off
ID15 (Ex1) or (Ex2)	n.u.		n.u.		n.u.		n.u.		n.u.	
ST1	n.u.		n.u.		n.u.		n.u.		n.u.	
ST2	Term1	Step 1	Term1	Step 1	Term1	Step 1	Term1	Step 1	Term1	Step 1
ST3	Tc1	T cond cir1	Tc1	T cond cir1	Tc1	T cond cir1	Tc1	T cond cir1	Tc1	T cond cir1
ST4	Ta	Tamb	Ta	Tamb	Ta	Tamb	Ta	Tamb	Ta	Tamb
ST5	n.u.		n.u.		n.u.		n.u.		n.u.	
ST6	n.u.		n.u.		Tc2	T cond cir2	Tc2	T cond cir2	Tc2	T cond cir2

* **NOTA** : ON TK1 AND TK2 OUTPUTS, FANS CAN BE ON/OFF (FOR STD VERSION) OR PROPORTIONNAL (STD PLUS, LN, SLN, HE)

 Main board

 Ex1
Standard Extension Board

 Ex2
Lennox Extension Board

PV : Low speed
GV : High speed
TOR : ON/OFF
n.u. : Not used

Technical data :

	Typical	Min.	Max.
Power supply voltage	12V~	10V~	14V~
Power supply frequency	50Hz/60Hz	---	---
Power	5VA	---	---
Insulation class	1	---	---
Protection grade	Front panel IP0	---	---
Operating temperature	25°C	0°C	60°C
Operating humidity (non-condensing)	30%	10%	90%
Storage temperature	25°C	-20°C	85°C
Storage humidity (non-condensing)	30%	10%	90%

Electromechanical features :

110/230 V digital <i>outputs</i>	n° 8, 5 A resistive relays; ¼ hp 230V~; 1/8 hp 125VAC (on base module) the total amount of relays current must be lower than 10A n° 2, 5 A resistive relays; ¼ hp 230V~; 1/8 hp 125V~ (on <i>expansion</i> module 1 "one") n° 3, 8 A resistive relays; ¼ hp 230V~; 1/4 hp 125V~ (on <i>expansion</i> module 2 "two") n° 3, 5 A resistive relays; ¼ hp 230V~; 1/8 hp 125V~ (on <i>expansion</i> module 2 "two")
Analogue <i>outputs</i>	n° 2 triac, DC piloting <i>outputs</i> or configurable 4-20 mA <i>outputs</i>
Analogue <i>inputs</i>	n° 4 NTC R ₂₅ 10KΩ (base board) n° 2 configurable input or 4-20mA o r NTC R ₂₅ 10KΩ(base board) n° 2 configurable input or 4-20mA o r NTC R₂₅ 10KΩ(on expansion module 2 "two")
Digital <i>inputs</i>	N° 11 voltage-free <i>digital inputs</i> (on base module) N° 4 voltage-free <i>digital inputs</i> (on <i>expansion</i> module)
Terminals and connectors	N° 1 10-way high voltage connectors, step 7.5(base board) N° 2 16-way rapid clamp connectors for low voltage, step 4.2, AWG 16-28(base board) N° 1 p2.5 5-way connector for remote control and programming with external <i>copy card</i> , AWG 24-30(base board) n° 1 20-way connector for connection of <i>expansion</i> (base board) n° 1 3-way screw terminal for <i>remote keyboard</i> (base board) n° 1 5-way screw terminal for digital inputsΩ(on expansion module 1/2 "one-two") n° 1 12-way high voltage connectors, on expansion module 2 " two" n° 1 8-way screw terminal connectors, on expansion module 2 " two" n° 1 4-way high voltage connectors, on expansion module 1 " one"
Serial ports	n° 1 9600 serial port n° 1 2400 serial port

Current transformer :

The instrument must be powered with a suitable current transformer with the following features:

Primary voltage: 230V~±10%; 110V~±10%
Secondary voltage: 12V~
Power supply frequency: 50Hz; 60Hz
Power: 11VA

Regulations

The product complies with the following European Community Directives:

Council Directive 73/23/CEE and subsequent modifications
Council directive 89/336/CEE and subsequent modifications
and complies with the following harmonised regulations:
LOW VOLTAGE: EN60335 as far as applicable
EMISSION: EN50081-1 (EN55022)
IMMUNITY: EN50082-1 (IEC 1000-4-2/3/4/5)

Permitted use

This product is used to control single and dual circuit chillers and heat pumps.

To ensure safety, the controller must be installed and operated in accordance with the instructions supplied, and access to high voltage components must be prevented under regular operating conditions. The device shall be properly protected against water and dust and shall be accessible by using a tool only. The device is suitable for incorporation in a household appliance and/or similar air conditioning device.

According to the reference regulations, it is classified: In terms of construction, as an automatic electronic control device to be incorporated with independent assembly or integrated;

In terms of automatic operating features, as a type 1 action control device, with reference to manufacturing tolerances and drifts;

As a class 2 device in relation to protection against electrical shock;

As a class A device in relation to software structure and class.

Forbidden use

Any use other than the permitted use is forbidden.

Please note that relay contacts supplied are functional and are subject to fault (in that they are controlled by an electronic component and be shorted or remain open); protection devices recommended by product standards or suggested by common sense in response to evident safety requirements shall be implemented outside of the instrument.

RESPONSIBILITY AND RESIDUAL RISKS

shall not be held liable for any damage incurred as a result of:

installation/use other than those intended, and, in particular, failure to comply with the safety instructions specified by applicable regulations and/or provided in this document;

use with equipment which does not provide adequate protection against electric shocks, water and dust under the effective conditions of installation;

use with equipment which permits access to hazardous parts without the use of tools;

installation/use with equipment which does not comply with current *regulations* and legislation.

BELGIUM : LENNOX BENELUX N.V./S.A.
tél. : + 32 3 633 30 45
fax : + 32 3 633 00 89
e-mail : info.be@lennoxbenelux.com

CZECH REPUBLIC : LENNOX JANKA
tél. : + 420 2 510 88 111
fax : + 420 2 579 10 393
e-mail : janka@janka.cz

FRANCE : LENNOX FRANCE
tél. : + 33 4 72 23 20 20
fax : + 33 4 78 20 07 76
e-mail : accueil@lennoxfrance.com

GERMANY : LENNOX DEUTSCHLAND GmbH
tél. : + 49 69 42 09 79 0
fax : + 49 69 42 09 79 40
e-mail : info.de@lennoxdeutschland.com

MIDDLE EAST : LENNOX DISTRIBUTION
tél. : + 971 4 262 9309
fax : + 971 4 266 7082
e-fax : + 1 240 368 73 62
Mobile : 971 50 4510669
e-mail : mmrifai@emirates.net.ae

NETHERLANDS : LENNOX BENELUX B.V.
tél. : + 31 33 2471 800
fax : + 31 33 2459 220
e-mail : info@lennoxbenelux.com

POLAND : LENNOX POLSKA Sp. z o. o.
tél. : + 48 22 832 26 61
fax : + 48 22 832 26 62
e-mail : info@lennoxpolska.pl

PORTUGAL : LENNOX CLIMATIZAÇÃO LDA.
tél. : +351 22 999 84 60
fax : +351 22 999 84 68
e-mail : info@lennoxportugal.com

RUSSIA : LENNOX DISTRIBUTION MOSCOW
tél. : + 7 095 246 07 46
fax : + 7 502 933 29 55
e-mail : lennox.dist.moscow@mtu-net.ru

SLOVAKIA : LENNOX SLOVAKIA
tél. : + 421 2 44 87 19 27
fax : + 421 2 44 88 64 72

SPAIN : LENNOX REFAC S.A.
tél. : + 34 915 40 18 10
fax : + 34 915 42 84 04
e-mail : marketing@lennox-refac.com

UKRAINE : LENNOX DISTRIBUTION KIEV
tél. : + 380 44 213 14 21
fax : + 380 44 213 14 21
e-mail : jankauk@uct.kiev.ua

UNITED KINGDOM : LENNOX INDUSTRIES LTD
tél. : + 44 1604 599400
fax : + 44 1604 594200
e-mail : ukmarketing@lennoxind.com

OTHER EUROPEAN COUNTRIES, AFRICA, LENNOX DISTRIBUTION :
tél. : + 33 4 72 23 20 14
fax : + 33 4 72 23 20 28
e-mail : marketing@lennoxdist.com



LENNOX[®]