

OPERATING MANUAL

Enertronic Control System

2

The integrated control system for Lennox chillers
in the Ecologic and Seconscrew ranges

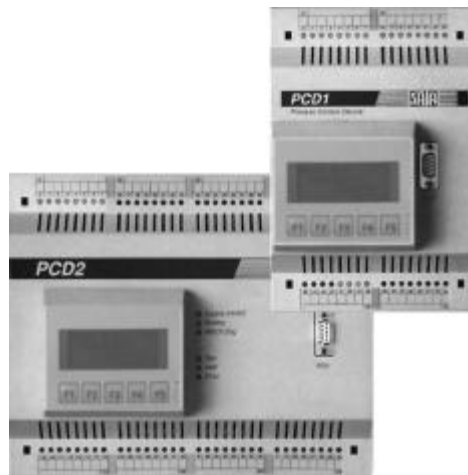

Manufacturer
Lennox Benelux B.V.
Postbus 1028, 3860 BA NIJKERK
Watergoorweg 87, 3861 MA NIJKERK
Netherlands
Tel.: ++31 (0)33-2471800
Fax: ++31 (0)33-2459220

CONTENTS

1.	PREFACE.....	4
2.	VERSIONS.....	5
2.1.	SINGLE CIRCUIT CONFIGURATION.....	5
2.2.	DOUBLE CIRCUIT CONFIGURATION.....	5
3.	HARDWARE.....	6
3.1.	HARDWARE OF SINGLE CIRCUIT VERSION.....	6
3.2.	HARDWARE OF DOUBLE CIRCUIT VERSION.....	7
3.3.	FUNCTION LEDs.....	7
3.4.	INPUTS AND OUTPUTS OF SINGLE CIRCUIT VERSION EQUIPPED WITH SCROLL COMPRESSORS.....	8
3.4.1.	Digital outputs of single circuit version equipped with scroll compressors.....	8
3.4.2.	Digital inputs of single circuit version equipped with scroll compressors.....	9
3.4.3.	Analog inputs of single circuit version equipped with scroll compressors.....	9
3.5.	INPUTS AND OUTPUTS OF SINGLE CIRCUIT VERSION EQUIPPED WITH A SCREW-TYPE COMPRESSOR.....	10
3.5.1.	Digital outputs of single circuit version equipped with a screw-type compressor.....	10
3.5.2.	Digital inputs of single circuit version equipped with a screw-type compressor.....	11
3.5.3.	Analog inputs of single circuit version equipped with a screw-type compressor.....	11
3.6.	INPUTS AND OUTPUTS OF DOUBLE CIRCUIT VERSION EQUIPPED WITH SCROLL COMPRESSORS.....	12
3.6.1.	Digital outputs of double circuit version equipped with scroll compressors.....	12
3.6.2.	Analog outputs of double circuit version equipped with scroll compressors.....	13
3.6.3.	Digital inputs of double circuit version equipped with scroll compressors.....	13
3.6.4.	Analog inputs of double circuit version equipped with scroll compressors.....	14
3.7.	INPUTS AND OUTPUTS OF DOUBLE CIRCUIT VERSION EQUIPPED WITH SCREW-TYPE COMPRESSORS.....	15
3.7.1.	Digital outputs of double circuit version equipped with screw-type compressors.....	15
3.7.2.	Analog outputs of double circuit version equipped with screw-type compressors.....	16
3.7.3.	Digital inputs of double circuit version equipped with screw-type compressors.....	16
3.7.4.	Analog inputs of double circuit version equipped with screw-type compressors.....	17
3.8.	TRANSFER FUNCTION OF ANALOG SENSORS.....	18
4.	SAFETY FEATURES.....	19
4.1.	SAFETY FEATURES FOR THE EVAPORATOR.....	19
4.1.1.	Transmission pump of evaporator.....	20
4.2.	SAFETY FEATURES FOR THE COMPRESSOR(S).....	22
4.3.	SAFETY FEATURES FOR THE CONDENSERS.....	23
4.4.	GENERAL SAFETY FEATURES.....	23
4.5.	GENERAL MACHINE RESET.....	23

5.	CONTROLS	24
5.1.	CAPACITY CONTROL	24
5.1.1.	Water outlet temperature control.....	24
5.1.1.1.	Setpoint.....	24
5.1.1.2.	Analog setpoint adjustment.....	25
5.1.1.3.	Operation with two setpoints.....	25
5.1.2.	Economiser operation	25
5.1.3.	Preference switch	25
5.1.4.	Peak load limiting.....	25
5.2.	CONTROL OF AIR-COOLED CONDENSERS.....	26
5.2.1.	Discrete control	26
5.2.2.	Pulse width control.....	26
5.2.3.	Control of condenser fans using frequency controllers	27
5.3.	CONTROL OF WATER-COOLED CONDENSER.....	27
5.4.	CONTROLLING THE ELECTRONIC EXPANSION VALVE	28
6.	OPERATION	29
6.1.	OVERVIEW OF OPERATING FUNCTIONS	30
6.1.1.	Specific functions	32
6.1.1.1.	Setpoint of water outlet control.....	32
6.1.1.2.	Setpoint of condenser control	32
6.1.1.3.	Setpoint of EVe's	32
6.1.1.4.	Reset mode	33
6.1.1.5.	Test mode	33
6.1.2.	Diagnose function	33

1. PREFACE

The Enertronic Control System 2 provides the functionality required to protect, control and operate your Lennox Ecologic or Seconscrew chiller. It has the ability to operate those processes that take place in your chiller to the best advantage, thus guaranteeing efficient operation throughout the life of the machine.

Operation of the Enertronic Control System 2 is based around a number of software and hardware modules. These modules are combined to form a specific control system for the Lennox chillers. The hardware for the control system comes in two versions, namely :

- Single circuit configuration
- Double circuit configuration

These user instructions describe the operation and control of both configurations, including the necessary hardware. However, the availability of the different functions and the presence of the different hardware modules are determined by the configuration of your Lennox chiller.

COPYRIGHT

TO DETERMINE THE RELEVANT FUNCTIONALITY FOR YOUR APPLICATION, THIS USER MANUAL MUST BE CONSULTED IN CONJUNCTION WITH THE USER INSTRUCTIONS SPECIFIC TO YOUR LENNOX CHILLER.

FOR ALL GUIDELINES PERTAINING TO SAFETY, USE AND MAINTENANCE AND WARRANTY, REFERENCE SHOULD ALSO BE MADE TO THE USER INSTRUCTIONS APPLYING TO YOUR SPECIFIC LENNOX CHILLER

ALL THE TECHNICAL AND TECHNOLOGICAL INFORMATION CONTAINED IN THIS MANUAL, INCLUDING ANY DRAWING AND TECHNICAL DESCRIPTIONS PROVIDED BY US, REMAIN THE PROPERTY OF LENNOX BENELUX B.V. AND MUST NOT BE UTILISED (EXCEPT IN THE OPERATION OF THIS PRODUCT), REPRODUCED, ISSUED TO OR MADE AVAILABLE TO THIRD PARTIES WITHOUT THE PRIOR AGREEMENT OF LENNOX BENELUX B.V.

2. VERSIONS

The Enertronic Control System 2 is an independently operating control system which provides the same functionality for both the single circuit machine and the double circuit machine. This functionality can be subdivided into three main groups :

- Safety functions
- Control functions
- Operating functions

In terms of hardware, a distinction is made between machines equipped with scroll compressors and machines using screw-type compressors. The hardware is the same. But the functionality of the control system is different because additional components have to be activated with machines using screw-type compressors. This manual refers where necessary to the machine type.

2.1. Single circuit configuration

The single circuit configuration is made up from one hardware configuration integrating two configurations which are different when it comes to using inputs and outputs. This configuration is used amongst others for the following machine ranges:

- Single circuit machines using scroll compressors:
WA-40E to WA-110E
WW-45E to WW-130E
WS-45E to WS-130E
- Single circuit machines using screw-type compressors:
SC-W 160E to SC-W 205E
SC-S 160E to SC-S 205E

2.2. Double circuit configuration

The double circuit configuration is made up from one hardware configuration integrating two configurations which are different when it comes to using inputs and outputs. This configuration is used amongst others for the following machine ranges:

- Double circuit machines using scroll compressors:
WA-90D to WA-230D
WW-105D to WW-255D
WS-105D to WS-255D
- Double circuit machines using screw-type compressors:
WA-285D to WA-430D
SC-W 240D to SC-W 410D
SC-S 240D to SC-S 410D

FOR ALL CONFIGURATIONS, ONLY THOSE FUNCTIONS RELEVANT TO YOUR APPLICATION ARE AVAILABLE.

INTEGRATING CERTAIN OPTIONS INTO A MACHINE MAY RESULT IN A SINGLE CIRCUIT MACHINE BEING EQUIPPED WITH HARDWARE WHICH IS COMMONLY USED FOR DOUBLE CIRCUIT MACHINES. IN THAT CASE THE INPUTS AND OUTPUTS OF CIRCUIT 2 ARE NOT USED.

3. HARDWARE

The hardware for the Enertronic Control System 2 consists of a programmable logic controller (PLC). This PLC collects information from the chiller in the form of digital (1 or 0) and analog (0-10 volt and resistance) signals. The status of the digital inputs is indicated by LEDs (Light Emitting Diodes). Using these signals, the software in the PLC will generate control tasks for the main chiller components. Digital outputs, implemented as relay contacts and transistors, control the switching equipment for the main chiller components in order to perform the specified control tasks. The status of the digital outputs is also indicated by LEDs.

3.1. Hardware of single circuit version

Figure 1 shows the control system for the single circuit version

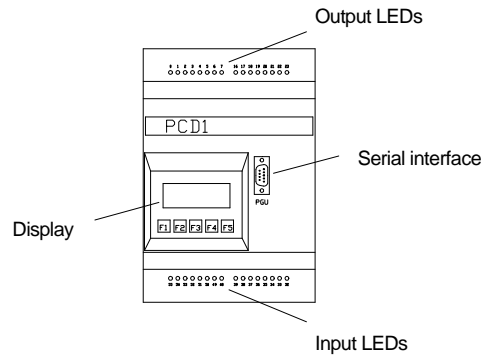

Figure 1, Single circuit control system

! NOTE:

Removing the cover without cutting off the power may provoke damage to the hardware.

3.2.

Figure 2 shows an overview of the control system for the double circuit

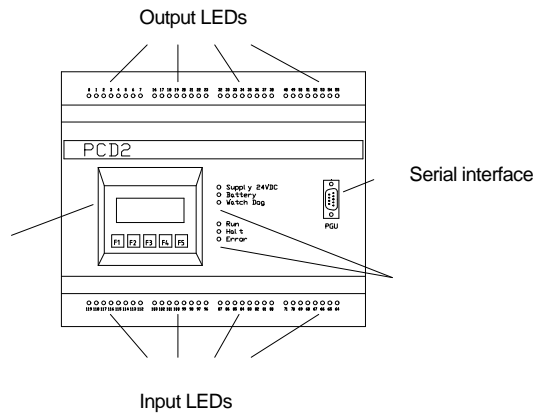

Figure 2, Double circuit control system

NOTE:

Restarting the system over without cutting off the power may provoke damage to the hardware.

according to the machine version and the options you have chosen.

Function LEDs

The function LEDs provide information concerning the correct operation of the control system. In normal operation, the 'Supply 24VDC' and 'Run' LEDs will show a yellow light. If the status of the 'Battery' LED shows red, you should contact the service department at Lennox. One exception to this is the status of the 'Battery' LED. When this LED shows red, this indicates that the back up battery in the control system is flat. Provided the machine is connected to the mains, the battery should be replaced during the periodic maintenance of your chiller. If the battery should become flat while the machine is disconnected from the mains voltage, only the temporarily stored information (e.g. hour counter) will be lost. The software stored in non-volatile memory is not affected. The functioning of the chiller cannot therefore be adversely affected by the battery running low. The standard life of a battery is 2 to 5 years.

Note: the function LEDs are n

3.4. Inputs and outputs of single circuit version equipped with scroll compressors

This applies amongst others to machine types:

WA-40E to WA-110E
WW-45E to WW-130E
WS-45E to WS-130E

The outputs numbered 0 to 23 are located on the top of the control. The inputs are grouped on the bottom of the control, numbered 32 to 55 inclusive. The status of the respective input or output is indicated by LEDs (except for analog inputs). The following tables show the different inputs and outputs. Where applicable, the status of the respective LED indicator during normal operation is also shown.

3.4.1. Digital outputs of single circuit version equipped with scroll compressors

Number	Function	LED indicator
0	Control compressor 1	*
1	Control compressor 2	*
2	Control compressor 3	*
3	Not used	n/a
4	Not used	n/a
5	Not used	n/a
16	Control condenser fan 1	*
17	Control condenser fan 2	*
18	Control condenser fan 3 / high-speed fan 1	*
19	Control expansion valve 1	*
20	Control expansion valve 2	*
21	Control evaporator heating	*
22	Control transmission pump evaporator circuit	*
23	Failure indication	On

Table 1 , Numbering of digital outputs

* = Depending on present operating circumstances and machine configuration

3.4.2.

Number	Function	
32	Starting command	On
33	Contact for flow or pump switch	On
34	Failure contact pump unit (optional)	On
35	High pressure protection input	On
36	Safety chain compressor 1	On
37	Safety chain compressor 2	*
38	Safety chain compressor 3	*
39	Safety chain condenser	On

Table 2, Numbering of digital inputs

* = Dependent on machine configuration

3.4.3. Analog inputs of single circuit version equipped with scroll compressors

Number	Function	LED indicator
48	Low pressure transmitter	n/a
49	High pressure transmitter	n/a
50	External setpoint adjustment (0-10VDC, optional)	n/a
51	Not used	n/a
52	Suction gas temperature sensor	n/a
53	Not used	n/a
54	Ambient temperature sensor	n/a
55	Water outlet temperature sensor	n/a

Table 3, Numbering of analog inputs

Inputs and outputs of single circuit version equipped with a screw type compressor

This applies amongst others to machine types:

SC W 160E to SC-
SC S 160E to SC-

view there are differences because the machines are equipped with screw- pe compressors.

3.5.1.

-type compressor

Number		LED indicator
0		*
1		*
2		*
3		n/a
4		On
5		*
16		*
17		*
18	-speed fan 1	*
	Control economiser	*
	Control expansion valve 1	*
	Control exp	*
22		*
23		n/a

Table 4

* = Depending on present operating circumstances and machine configuration

3.5.2. Digital inputs of single circuit version equipped with a screw-type compressor

Number	Function	LED indicator
32	Starting command	On
33	Contact for flow or pump switch	On
34	Failure contact pump unit (optional)	On
35	High pressure protection input	On
36	Motor overload protection compressor 1	On
37	Thermistor / phase sequential protection compressor	On
38	Oil level protection compressor 1 (optional)	On
39	Safety chain condenser circuit	On

Table 5, Numbering of digital inputs

* = Dependent on machine configuration

3.5.3. Analog inputs of single circuit version equipped with a screw-type compressor

Number	Function	LED indicator
48	Low pressure transmitter	n/a
49	High pressure transmitter	n/a
50	External setpoint adjustment (0-10VDC, optional)	n/a
51	Not used	n/a
52	Suction gas temperature sensor	n/a
53	Not used	n/a
54	Ambient temperature sensor	n/a
55	Water outlet temperature sensor	n/a

Table 6 , Numbering of analog inputs

Inputs and outputs of double circuit version equipped with scroll compr

This applies amongst others to machine types:

WA- -230D
 WW- -255D
 WS- -255D

In this case as well, the outputs, numbered from 0 to 55 inclusive, are on top of the control and the inputs, numbered 64 to 119, are on the bottom.
 version. The tables below summarise the inputs and outputs used:

3.6.1.

Number	Function	
0	Control compressor 1 circuit 1	*
	Control compressor 2 circuit 1	*
	Control compressor 3 circuit 1	*
	Control compressor 1 circuit 2	*
	Control compressor 2 circuit 2	*
	Control compressor 3 circuit 2	*
	Control condenser fan 1 circuit 1	*
	Control condenser fan 2 c	*
18	-speed fan 1	*
	Control expansion valve 1 circuit 1	*
	Control expansion valve 2 circuit 1	*
	Control evaporator heating	
22	Control transmission pump evaporator circuit	
23	Failure indication	On
	Control condenser fan 1 circuit 2	*
	Control condenser fan 2 circuit 2	*
	Control condenser fan 3 circuit 2/ high speed fan 1	
35	Control expansion valve 1 circuit 2	
36	Control expansion valve 2 circuit 2	
37	Not used	
38	Not used	n/a
	Not used	n/a

7 , Numbering of digital outputs

* = Depending on present operating circumstances and machine configuration

3.6.2. Analog outputs of double circuit version equipped with scroll compressors

Number	Function	LED indicator
48	Water control valve circuit 1 (0-10VDC, optional)	n/a
49	Water control valve circuit 2 (0-10VDC, optional)	n/a
50	Fan speed control circuit 1 (0-10VDC, optional)	n/a
51	Fan speed control circuit 2 (0-10VDC, optional)	n/a

Table 8 , Numbering of analog outputs

3.6.3. Digital inputs of double circuit version equipped with scroll compressors

Number	Function	LED indicator
80	Starting command	On
81	Contact for flow or pump switch	On
82	Peak load limiting	On
83	High pressure protection input circuit 1	On
84	Safety chain compressor 1 circuit 1	On
85	Safety chain compressor 2 circuit 1	On
86	Safety chain compressor 3 circuit 1	*
87	Safety chain condenser circuit 1	On
96	Failure contact pump unit (optional)	On
97	Input to activate second setpoint (optional)	*
98	Not used	n/a
99	High pressure protection input circuit 2	On
100	Safety chain compressor 1 circuit 2	On
101	Safety chain compressor 2 circuit 2	On
102	Safety chain compressor 3 circuit 2	*
103	Safety chain condenser circuit 2	On

Table 9, Numbering of digital inputs

* = Depending on present operating circumstances and machine configuration

3.6.4. Analog inputs of double circuit version equipped with scroll compressors

Number	Function	LED indicator
64	External setpoint adjustment (0-10VDC, optional)	n/a
65 to 67	Not used	n/a
68	Water inlet temperature sensor (lon, optional)	n/a
69 t to 71	Not used	n/a
112	Low pressure transmitter circuit 1	n/a
113	High pressure transmitter circuit 1	n/a
114	Low pressure transmitter circuit 2	n/a
115	High pressure transmitter circuit 2	n/a
116	Suction gas temperature sensor circuit 1	n/a
117	Suction gas temperature sensor circuit 2	n/a
118	Ambient temperature sensor	n/a
119	Water outlet temperature sensor	n/a

Table 10 , Numbering of analog inputs

3.7. Inputs and outputs of double circuit version equipped with screw-type compressors

This applies amongst others to machine types:

WA-285D to WA-430D
SC-W 240D to SC-W 410D
SC-S 240D to SC-S 410D

The inputs and outputs are located as outlined for the previous version. But from a functional point of view there are differences because the machines are equipped with screw-type compressors.

3.7.1. Digital outputs of double circuit version equipped with screw-type compressors

Number	Function	LED indicator
0	Control compressor 1	*
1	Control 75% capacity stage compressor 1	*
2	Control 100% capacity stage compressor 1	*
3	Control compressor 2	*
4	Control 75% capacity stage compressor 2	*
5	Control 100% capacity stage compressor 2	*
16	Control condenser fan group 1 circuit 1	*
17	Control condenser fan group 2 circuit 1	*
18	Control condenser fan group 3 circuit 1/ high-speed fan 1	*
19	Control economiser circuit 1	*
20	Control expansion valve 1 circuit 1	*
21	Control expansion valve 2 circuit 1	*
22	Control evaporator heating	*
23	Control transmission pump evaporator circuit	*
32	Control condenser fan group 1 circuit 2	*
33	Control condenser fan group 2 circuit 2	*
34	Control condenser fan group 3 circuit 2/ high-speed fan 1	*
35	Control economiser circuit 2	*
36	Control expansion valve 1 circuit 2	*
37	Control expansion valve 2 circuit 2	*
38	Failure indication	On
39	Not used	n/a

Table 11 , Numbering of digital outputs

* = Depending on present operating circumstances and machine configuration

3.7.2. Analog outputs of double circuit version equipped with screw-type compressors

Number	Function	LED indicator
48	Water control valve circuit 1 (0-10VDC, optional)	n/a
49	Water control valve circuit 2 (0-10VDC, optional)	n/a
50	Fan speed control circuit 1 (0-10VDC, optional)	n/a
51	Fan speed control circuit 2 (0-10VDC, optional)	n/a

Table 12, Numbering of analog outputs

3.7.3. Digital inputs of double circuit version equipped with screw-type compressors

Number	Function	LED indicator
80	Starting command	On
81	Contact for flow or pump switch	On
82	Peak load limiting	On
83	High pressure protection input circuit 1	On
84	Motor overload protection compressor 1	On
85	Thermistor / phase sequential protection compressor 1	On
86	Oil level protection compressor 1 (optional)	On
87	Safety chain condenser circuit 1	On
96	Failure contact pump unit (optional)	On
97	Input to activate second setpoint (optional)	*
98	Not used	n/a
99	High pressure protection input circuit 2	On
100	Motor overload protection compressor 2	On
101	Thermistor / phase sequential protection compressor 2	On
102	Oil level protection compressor 2 (optional)	On
103	Safety chain condenser circuit 2	On

Table 13, Numbering of digital inputs

* = Depending on present operating circumstances and machine configuration

3.7.4. Analog inputs of double circuit version equipped with screw-type compressors

Number	Function	LED indicator
64	External setpoint adjustment (0-10VDC, optional)	n/a
65 to 67	Not used	n/a
68	Water inlet temperature sensor (lon, optional)	n/a
69 t to 71	Not used	n/a
112	Low pressure transmitter circuit 1	n/a
113	High pressure transmitter circuit 1	n/a
114	Low pressure transmitter circuit 2	n/a
115	High pressure transmitter circuit 2	n/a
116	Suction gas temperature sensor circuit 1	n/a
117	Suction gas temperature sensor circuit 2	n/a
118	Ambient temperature sensor	n/a
119	Water outlet temperature sensor	n/a

Table 14 , Numbering of analog inputs

3.8. Transfer function of analog sensors

In some cases (e.g. when troubleshooting) the transfer function of the analog measurement transducer must be known. This is as follows for the low and high pressure transmitters:

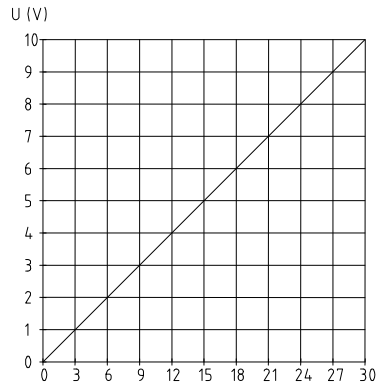

Figure 3, Transfer function of high pressure sensor

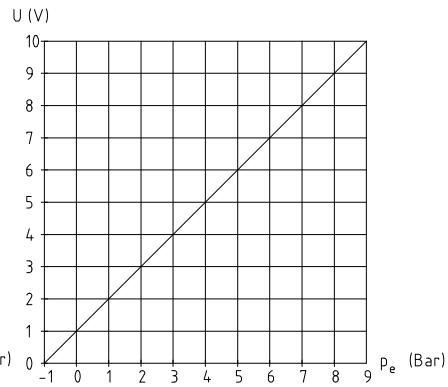

Figure 4, Transfer function of low pressure sensor

Note: Pe = Effective pressure, or manometer pressure

The temperature sensors (water outlet, ambient air, suction gas) are of the type PT 2000. The relationship between temperature and resistance is as follows:

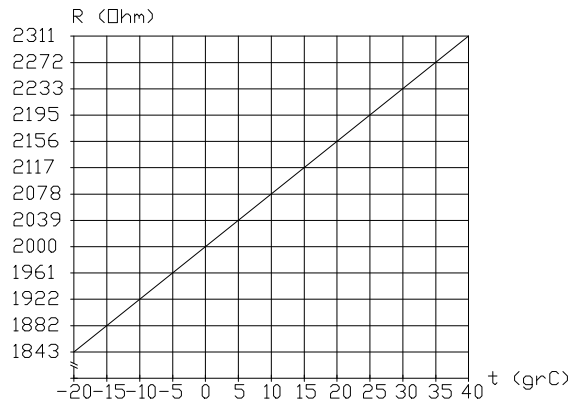

Figure 5, Sensor resistance/temperature relationship

4. SAFETY FEATURES

The Enertronic Control System 2 has extensive safety features for the different components used in your Lennox chiller. The safety features can be divided into four main groups, i.e.:

- Safety features for the evaporator
- Safety features for the compressors
- Safety features for the condensers
- General safety features

4.1. Safety features for the evaporator

The evaporator on your Lennox chiller is protected from freezing by the Enertronic Control System 2. This is primarily achieved by monitoring the flow or differential pressure switch in the hydraulic system. An opened contact on this switch will lead after 5 seconds to disengaging of the compressors in your chiller. Too low a water outlet temperature will result in the disengaging of the compressors and engaging of the heating tape. If your Lennox chiller is designed with a hydraulic module or pump unit, the electric heater unit in the integrated buffer tank is engaged at the same time as the heating tape. If due to unforeseen circumstances the water outlet temperature drops still further, the controller will switch the chiller off (frost failure) using an electronic locking device. Too low an evaporation temperature in a refrigerant circuit, which may also result in freezing, is prevented by disengaging the respective refrigerant circuit when the suction pressure of the compressors is lower than the permitted minimum over a certain time period. (LP failure, see safety features for the compressors.)

Cause	Result	Limit values	Failure?	Reset required?
Low water outlet temperature	All compressors off; evaporator heating on, heating on in buffer tank (optional)	T1, <3.5°C	No	No
Risk of freezing	Machine blocked	T2, <2.5°C	Yes	Yes, general reset
Low ambient temperature	Transmission pump evaporator on	T4; < 5.0°C (T4;<-6°C at 34% glycol)	No	No
Flow or pressure difference switch off	Machine stop after 5 sec.	Machine dependent	Yes	No
Too low evaporation temperature	Appropriate refrigerant circuit off	See 'safety features for the compressors'	Yes	Yes, general reset

Table 15 , Evaporator safety features

* = If glycol is used, a different value will apply, see figures on p. 21.

4.1.1. Transmission pump of evaporator

The transmission pump in the hydraulic circuit will be switched on at ambient temperatures below 5°C. If a water/glycol mixture is used, the pump will be switched on at a lower ambient temperature, according to the glycol content. The switch-on point used for a given glycol content can be found by reading the temperature from Figure 6 and adding 1.5 K to this value. For instance, if the glycol content is 34% (or higher), the pump is switched on the moment the ambient temperature drops below -6°C.

The pump also starts if the water temperature drops below 3.5°C. If a water/glycol mixture with a glycol content of 34% or higher is used, the pump is switched on at a water temperature below -7.5°C. (This is exactly the limit at which the compressors are disengaged and the evaporator heating is engaged, see Figure 6.)

Once all conditions for releasing the chiller (including external start command) have been satisfied, the transmission pump will be switched on first. After a 2 minutes' pump pre-run time, the chiller will be released. A failure indication is generated if the contact of the flow switch is interrupted for longer than 5 seconds. At that moment, the cooling capacity is switched off. If the cooling demand ceases to exist by eliminating the external start command, the compressors will stop and the transmission pump will switch off after 10 minutes (lag time).

THE GLYCOL PERCENTAGE SPECIFIED AT THE TIME OF ORDERING HAS BEEN TAKEN INTO ACCOUNT IN THE SOFTWARE.

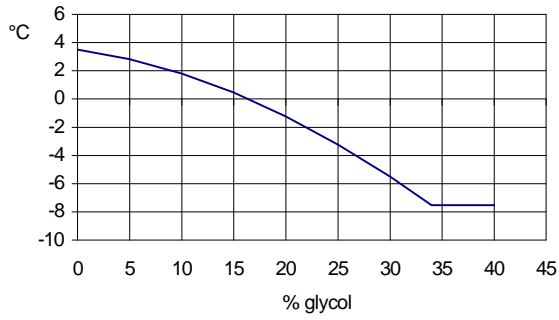

Figure 6 shows the relationship between the glycol percentage and the disengaging of all cooling capacity as well as the engaging of the evaporator heating and the heater unit in the buffer tank (optional).

Figure 6, Disengaging in the event of low water outlet temperature

Figure 7 shows, dependent on the percentage of glycol applied, the limit values for the water outlet temperature at which a frost failure will occur.

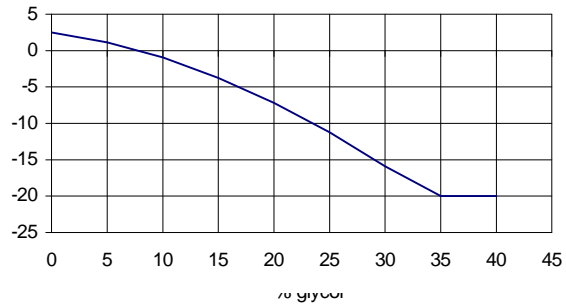

Figure 7, Frost failure limit values

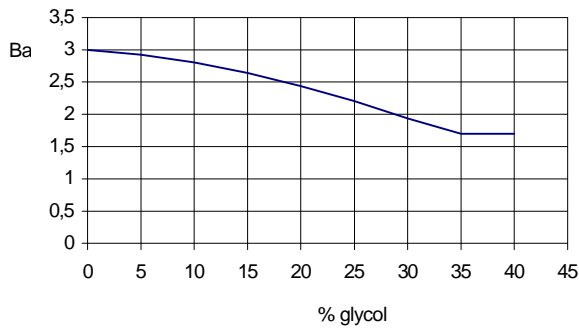

Figure 8 shows the relation between the values at which (after a certain time delay) a low pressure failure is detected, and the glycol percentage applied in the secondary circuit.

Figure 8, Low pressure detection values

4.2. Safety features for the compressor(s)

The compressors in your Lennox chiller can be protected in different ways against external or undesired operating conditions. The possible safety features and their characteristics are shown in the following table.

Cause	Result	Limit values	Failure?	Reset required?
Engaging or interruption of the mains voltage	Delay in engaging for oil warning	Maximum 6 hours *	No	No
Disengaging lowest capacity stage of single cooling circuit	Anti-cycling active; circuit remains disengaged	10 min if operating time > 5 min 30 min if operating time < 5 min	No	No
High discharge pressure	Reduction in cooling capacity (unloading)	0.94 x maximum discharge pressure	No	No
Too high discharge pressure	Compressor stop	Pressure switch value	Yes	Yes, on pressure switch
Low suction pressure (delayed)	Compressor stop after 6 min.	P1; 3 bar**	Yes	Yes, general reset
Low suction pressure (direct)	Immediate compressor stop	0.2 bar	Yes	Yes, general reset
High motor temperature (screw compressors)	Compressor stop	Firmly set	Yes	No, automatic after cooling
High motor temperature (screw-type compressors)	Compressor stop	Firmly set	Yes	Yes, general reset
Faulty phase sequence in electrical supply (screw-type compressors)	Compressor stop	Anti-clockwise phase rotation	Yes	Yes, general reset
Oil level too low (screw-type compressors, split chiller)	Compressor stop	Firmly set	Yes	Yes, general reset
High motor current	Compressor stop	Machine dependent	Yes	Yes, on motor starters

Table 16 , Compressor safety features

* = Interruption < 30 min: no wait time (except poss. anti-cycling), interruption > 30 minutes: wait time = time interruption lasts. Maximum = 6 hours. (e.g. on first start-up).

** = With use of glycol, see Figure 8 (previous page).

4.3. Safety features for the condensers

The condenser fans in your Lennox chiller are protected against overloading. This is achieved by internal protection elements and overload relays. In both cases, a failure will result in disengaging of the respective refrigerant circuit and the generation of a failure indication. When an internal motor protection trips, it is reset automatically after it has cooled down. If the fault is caused by an overload relay tripping, this must be resolved by resetting the relevant relay.

4.4. General safety features

The table below shows the safety features which are not directly related to the evaporator, compressor or condenser on your Lennox chiller, but which do have a direct effect on the operation of the machine.

Cause	Result	Limit values	Failure?	Reset required?
Ambient temperature too low	Machine stop	0°C or -20°C**	No	No
Faulty temperature sensor (water outlet, ambient or suction gas temperature)	Machine stop	Measured value < -50°C or > +60°C	Yes	No
Impermissibly small I action of expansion device*	Machine blocked	I < -20, for more than 5 min.	Yes	Yes, general reset
Impermissibly large I action of expansion device*	Machine blocked	I > 12, for more than 1 hour	Yes	Yes, general reset
Fault on transmission pump in evaporator circuit (optional)	Machine stop	Determined by pump type and protection	Yes	No

Table 17, General safety features

* = See control of electronic expansion valve, Chapter 5

**= Dependent on your chiller version

4.5. General machine reset

If one of the safety features mentioned in this chapter trips, and needs to be cancelled by a general machine reset, you must use the display module. A general machine reset can then be initiated via the reset menu (F2, F2, F1, F3). (For an explanation, see Chapter 0, **Erreur ! Référence non valide pour un signet.**)

5. CONTROLS

To operate your Lennox chiller as efficiently as possible, the control functions for the main chiller components are integrated into the Enertronic Control System. A distinction is made between:

- Capacity control
- Condenser control
- Control of electronic expansion valve

5.1. Capacity control

To bring the cooling capacity of your Lennox chiller in line with the loading in your application, the cooling capacity supplied is adjusted by the engaging or disengaging of the compressors or capacity stages (screw-type compressors). The engaging or disengaging of cooling capacity is performed on the basis of the water outlet temperature.

5.1.1. Water outlet temperature control

This control procedure enables the temperature of the water leaving the chiller to conform as accurately as possible to the required value (setpoint). Staged engaging of cooling capacity also modifies the water outlet temperature in steps. This 'step response' can vary depending on the number of compressors / capacity stages per compressor and the layout of the hydraulic system. The water outlet temperature controller uses an adaptive principle to calculate the ideal engaging and disengaging values for the compressor or capacity stage each time a compressor is engaged. In other words, the optimum bandwidth for each compressor is set each time one is engaged. This bandwidth is restricted to a minimum of +/- 0.5K and a maximum of +/- 2.0K with respect to the setpoint.

To adapt the operation of your Lennox chiller perfectly to your application, there are a number of options to modify the setpoint of the water outlet temperature control.

5.1.1.1. Setpoint

As mentioned earlier, the setpoint is the desired value for the chilled medium leaving the chiller (water or water / glycol mix). This value can be modified manually using the display module on the control. For water applications, a setting range of 6°C to 12°C applies. In the case of water / glycol mixtures (\geq 34% glycol), the maximum range of -5°C to 12°C applies.

5.1.1.2. Analog setpoint adjustment

Analog setpoint adjustment provides the possibility of increasing or decreasing the operating range of your chiller continuously to a maximum of 10K. This is achieved by converting a 0-10 VDC signal (sent from an external control circuit) into a setpoint setting (corresponding to 0 - 10K). The display module (F2, F1, F4) is used to select whether the 0-10 VDC signal results in an increase or decrease in the setpoint. (A decrease is naturally only possible in the case of glycol applications!)

5.1.1.3. Operation with two setpoints

Operating with two setpoints means that by closing a potential free contact, you can choose to activate a second setpoint. In comfort applications this function may, for example, be used if dehumidification is required. In process applications, this function may be used for ice buffer operation. The value of the second setpoint must be specified when ordering your chiller.

5.1.2. Economiser operation

If your chiller is designed with screw-type compressors, a subcooling system will, under certain conditions, come into effect to ensure even more efficient operation of your chiller. This system is termed 'economiser operation' and provides more subcooling of the liquid refrigerant fed to the expansion device.

5.1.3. Preference switch

In the case of chillers with two refrigerant circuits, based on the number of operating hours per circuit or a failure occurring, the preference for the circuit that will be engaged first is switched.

5.1.4. Peak load limiting

An input is reserved on the control system for activating peak load limiting. If a potential free contact associated with this input is closed (for example, during peak take-off of your electricity supply), then in the case of a two circuit chiller, the compressors in the second refrigerant circuit are disengaged. By doing so, you can temporarily halve the electricity consumption (and naturally the cooling capacity) of your Lennox chiller under full load.

5.2. Control of air-cooled condensers

To adapt the condenser capacity to the cooling capacity to be supplied under different outside air conditions, a pair of controls are available: discrete control (on-off), pulse-width control and control using frequency controllers. The aim of these controls is to keep the condensation temperature as low as possible. The desired condensation temperature (35°C) is reduced even more to make as efficient as possible use of the chiller when operating under partial load. (See figure 9.)

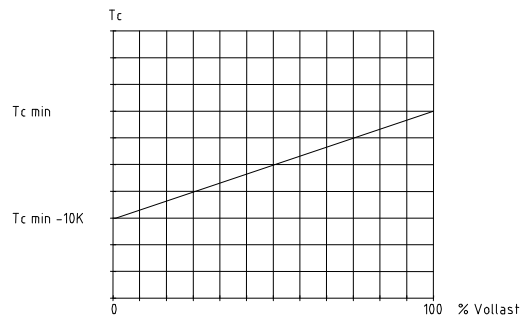

Figure 9, Reduction in condensation temperature when operating under partial load

5.2.1. Discrete control

This type of condenser control operates according to the 'conventional' principle of engaging and disengaging condenser fans. If the condensation temperature rises by 5K above the desired value, a fan will be switched on. If the condensation temperature is still above the specified value after 30 sec., another fan will be switched on. *The time constant of 30 seconds will be reduced to 1 sec. if the condensation temperature rises above 0.9 x the maximum value.* If, after switching on one fan and the elapse of a fixed time (75 sec), the condensation temperature has dropped to a value lower than the desired value, the appropriate fan will be switched off. The switch-on value for this fan will be set to the desired value + 10K.

5.2.2. Pulse width control

The principle on which this control is based is the switching on and off of a fan over a short period (cycle time = 5 sec). By varying the engaging and disengaging time, the speed of this fan can be set to any desired value between standstill and full load.

By using this type of control on the first fan of a condenser, the capacity of this condenser can be modulated. Thus, a condensation temperature may be maintained at exactly the desired value, provided the environmental conditions permit so.

IN AIR-COOLED ECOLOGIC CHILLERS USING SCROLL COMPRESSORS THE FIRST FAN OF EACH CIRCUIT IS PULSE WIDTH CONTROLLED , THE OTHER FANS BEING DISCRETELY CONTROLLED.

IN AIR-COOLED ECOLOGIC CHILLERS USING SCREW-TYPE COMPRESSORS THE FIRST TWO FANS OF EACH CIRCUIT ARE PULSE WIDTH CONTROLLED, THE OTHER FANS BEING DISCRETELY CONTROLLED

5.2.3. Control of condenser fans using frequency controllers

Machines that do not allow pulse width control (for instance, split air-cooled machines) can be controlled using frequency controllers. The frequency controllers are activated from the Enertronic Control System. Activating is also done using the condensation temperature. The Enertronic Control System generates a PI action based on the difference between the measured and desired condensation temperatures. This control action is converted into a 0-10VDC signal available at an analog output. It is possible to activate one frequency controller per circuit.

5.3. Control of water-cooled condenser

To adapt the condenser capacity to the cooling capacity to be supplied under different ambient conditions, water control valves can be used. The water control valve is intended to control the capacity of the water-cooled condenser. Activating of the water control valves is also done using the condensation temperature. The difference between the measured and desired condensation temperatures is adopted to calculate a PI action. This action is converted into a 0-10VDC signal available at an analog output. It is possible to activate one water control valve per circuit. For the desired condensation temperature, refer to Chapter 5.2.

5.4. Controlling the electronic expansion valve

The Enertronic Control System 2 provides the exact refrigerant dosage to the evaporator. It achieves this by using process data provided by different measurement points in the chiller. Two 'open / shut' solenoid valves connected in parallel are used as the control device. These valves are operated with a certain time delay, so that the evaporator is fed with a uniform flow of refrigerant. The correct dosage is obtained by operating the valves using pulse-width control. The control action for the pulse-width control is determined by a calculated "feed forward" value, corrected using a P and I action based on the superheating achieved. The superheating to be achieved will be about 6K.

IN CERTAIN MACHINE CONFIGURATIONS ANOTHER VALUE MAY APPLY FOR SUPERHEATING.

The superheating will be increased if, as the result of a very high water temperature, an impermissibly high loading of the compressors may result ('MOP' effect).

As already stated in the "general safety features", too great a correction of the "feed forward" value by the I action will result in a failure indication.

6. OPERATION

Your Enertronic 2 chiller control system has a display unit containing 5 function keys. Using this display and the intelligence integrated in the software, your Lennox chiller can be operated simply and its operating status can be determined. The display has a 4-line LCD screen (Figure 7). As soon as one of the function keys is pressed, the LCD screen will light up. If no key is pressed for 1 hour, the lighting is dimmed. Using the function keys certain 'selection screens' or menus are selected. The tasks performed by the various function keys depend on the menu selected. Using an access code, certain operating parameters in your Lennox chiller can be modified.

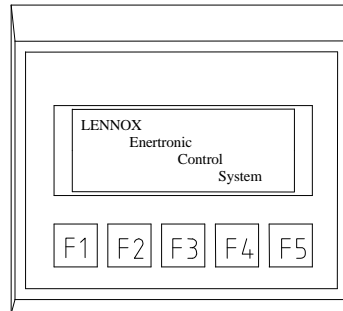

Figure 10, Display module

The following pages explain the various menus. In Table 18, you will find a schematic overview of the various menus.

IT IS VERY IMPORTANT THAT OPERATING OR MAINTENANCE PERSONNEL ARE FAMILIAR WITH THE OPERATION OF THE DISPLAY SO THAT INFORMATION REGARDING THE OPERATION OF YOUR LENNOX CHILLER CAN BE RETRIEVED EFFICIENTLY.

6.1. Overview of operating functions

The operations that can be performed using the display module can be roughly divided into four groups: 'Measurements, Settings, Diagnose, Status'. In sequence, these functions provide the following options:

Measurements: This allows a choice to be made to read out the different values measured in your Lennox chiller.

Settings: The functions in the group 'settings' can be used to modify the desired values for different control circuits. Reset and test modes are also part of this group.

Diagnose: Using this function, the current operating status of your Lennox chiller can be determined very effectively.

Status: 'Status' stores functions that provide information concerning the functioning of specific components in your Lennox chiller.

These groups can be selected with the keys **F1 to F4** from the **main menu**. The function keys can again be used to select a submenu within a group. Some menus provide the option, sometimes after keying in an access code, of operating or modifying specific things within the Enertronic Control System. The function key **F5** always has the same function, that is, to return to the **previously** selected menu.

THE NEXT PAGE PROVIDES AN OVERVIEW OF THE VARIOUS MENUS AND THEIR FUNCTIONS.

Note:

- The 'options menu' (F1, F3) is not applicable to your Lennox chiller.
- The messages relating to the second refrigerant circuit are not important in the case of a single circuit chiller.

	Level 1	Level 2	Level 3	Level 4	Parameter	
Main menu	F1 Measurements	F1 Refrigerant	F1 Circuit 1		Condensing pressure (bar) Condensing temperature (°C) Evaporating pressure (bar) Evaporating temperature (°C)	
			F2 Circuit 2		Condensing pressure (bar) Condensing temperature (°C) Evaporating pressure (bar) Evaporating temperature (°C)	
		F2 Secondary			Evaporator, water outlet temp. (°C) Setpoint water outlet control (°C) Ambient temperature (°C) External control signal (V)	
		F2 Settings	F1 Settings	F1 Setpoint water outlet control		Adjust F2=down F3=up (°C)
				F2 Setpoint condenser control		Adjust F2=down F3=up (°C)
				F3 Setpoint EVe control		Adjust F2=down F3=up (°C)
	F4 External setpoint adjust				F2 = increase F3 = decrease (Only glycol applications!)	
	F2 Reset / test	F1 Reset mode			F3=activate	
			F2 Test mode		F3=activate* (minutes; max 60)	
	F3 Access				F1 t/m F5 for access	
	F3 Diagnose				Overall diagnose Diagnose circuit 1 Diagnose circuit 2 Sequencer	
	F4 Status	F1 Circuits			Percentage 1/2 Hours ran 1/2 Starts /2	
			F2 EVe's	F1 Eve circuit 1	Feed forward action Integrating action Total extension Superheat (K)	
			F2 Eve circuit 2	Feed forward action Integrating action Total extension Superheat (K)		

Table 18, Functions of display module

* = only accessible with the correct 'access code

6.1.1. Specific functions

A number of specific functions require further explanation.

6.1.1.1. Setpoint of water outlet control

This can be used to modify the desired value of the water outlet temperature control. Changes of up to +6K with respect to the standard setpoint are possible. The standard setpoint (usually 6°C) is determined by the configuration of your Lennox chiller. The setpoint may also be lowered to -5.0 °C as long as your chiller is configured for glycol operation and the hydraulic system is filled with a water / glycol mixture with a sufficiently high degree of protection against freezing. Reducing or raising the desired value is achieved by pressing keys F2 or F3.

IN PARTICULAR, CHANGING THE SETPOINT TO A VALUE BELOW THE FACTORY SETTING CAN TRIP THE SAFETY FEATURES OF YOUR LENNOX CHILLER IF THERE IS INSUFFICIENT WATER IN THE HYDRAULIC SYSTEM.

CERTAIN MACHINE CONFIGURATIONS WILL NOT PERMIT THE MINIMUM VALUE FOR THE SETPOINT TO BE SELECTED. PLEASE CONSULT THE RELEVANT TECHNICAL SPECIFICATION!

6.1.1.2. Setpoint of condenser control

This can be used to modify the desired value for the condenser control system. The value can lie between 25°C and 55°C. The desired value is lowered or raised by pressing keys F2 and F3 respectively.

THE VALUE CAN ONLY BE MODIFIED IF ACCESS IS GAINED USING THE 'ACCESS FUNCTION'. INCORRECT SETTINGS CAN LEAD TO FAULTS IN THE CHILLER..

6.1.1.3. Setpoint of EVE's

This is used to adjust the desired value for the control of the superheating (or the control of the electronic expansion valves). The value can lie between 4K and 15K. The desired value is lowered or raised by pressing keys F2 and F3 respectively.

THE VALUE CAN ONLY BE MODIFIED IF ACCESS IS GAINED USING THE 'ACCESS FUNCTION'. INCORRECT SETTINGS CAN LEAD TO FAULTS OR DAMAGE TO THE CHILLER.

6.1.1.4. Reset mode

This menu allows the machine to be reset using function key F3. This reset may be necessary if the locking safety feature is tripped by the Enertronic Control System (Chapter 4).

REPEATED RESETTING OF THE INTERLOCKS AS A CONSEQUENCE OF INCORRECT SIZING OF THE HYDRAULIC SYSTEM, THE CHILLER, OR OTHER SETTINGS CAN RESULT IN DAMAGE TO THE CHILLER.

6.1.1.5. Test mode

The test mode provides qualified service personnel with access to a number of functions (crankcase heater delay, blockage with low ambient temperature, anti-cycling timers) whereby a rapid diagnosis can be made of the operation of your Lennox chiller. Test mode remains active for a maximum of one hour, after which it must be reactivated.

OPERATION IS ONLY POSSIBLE ONCE ACCESS HAS BEEN GAINED USING THE 'ACCESS FUNCTION'. IMPROPER USE OF TEST MODE WILL LEAD TO FAILURE IN OR DAMAGE TO THE CHILLER.

6.1.2. Diagnose function

Tables 19 to 21 inclusive provide information regarding the possible messages that can be generated by the diagnose function (F3).

Diagnose circuit 1	10	Circuit OK
	11	Low pressure failure circuit 1
	14	High pressure failure circuit 1
	15	Oil level compressor 1 too low (optional)
	16	Motor overload protection compressor 1 tripped
	17	Thermistor / phase sequential protection compressor 1 tripped
	19	Temperature protection condenser fan(s) circuit 1 tripped
	21	Anti-cycling protection compressor 1 tripped
	22	High pressure capacity reduction circuit 1 active
	24	High pressure capacity reduction circuit 1 > 12, for t > 1 hour
	25	High pressure capacity reduction circuit 1 < -20, for t < 5 minutes
	26	Suction gas temperature sensor circuit 1 defective

Table 19, Diagnosis register of circuit 1

Diagnose circuit 2	30	Circuit OK
	31	Low pressure failure circuit 2
	34	High pressure failure circuit 2
	35	Oil level compressor 2 too low (optional)
	36	Motor overload protection compressor 2 tripped
	37	Thermistor / phase sequential protection compressor 2 tripped
	39	Temperature protection condenser fan(s) circuit 2 tripped
	41	Anti-cycling protection compressor 2 tripped
	42	High pressure capacity reduction circuit 2 active
	44	Action EVe circuit 2 > 12, for t > 1 hour
	45	Action EVe circuit 2 < -20, for t < 5 minutes
	46	Suction gas temperature sensor circuit 2 defective

Table 20, Diagnosis register of circuit 2

Overall diagnosis	50	General preset values OK
	51	Delay for oil heating active
	52	Machine blocked due to too low ambient temperature
	53	Machine blocked due to too low water outlet temperature
	54	Frost protection tripped (control)
	56	Contact on flow switch not closed
	57	No start command present
	66	Water outlet temperature sensor defective
	67	Ambient temperature sensor defective
	68	Advance time transmission pump in evaporator circuit active
	69	Lag time transmission pump in evaporator circuit active
	70	Protection transmission pump / pump unit tripped
	71	No start command from LON network present
	72	Peak load limiting active

Table 21, General diagnosis register

Sequence	1 = circuit 2 starts after 1
	2 = circuit 2 starts after 2

Table 22, Starting sequence of cooling circuits

Manufacturer
Lennox Benelux B.V.
Postbus 1028, 3860 BA NIJKERK
Watergoorweg 87, 3861 MA NIJKERK
Netherlands
Tel.: ++31 (0)33-2471800
Fax: ++31 (0)33-2459220