

CONTROL AND REGULATION
WITH CLIMATIC

RTK

BASIS PROGRAM

ROOFTOP
Air conditioning unit

LIST OF CONTENTS

CLIMATIC control.....	Page 2
Set points.....	Page 5
Configuration.....	Page 5
On-Off function	Page 5
Stand by function	Page 6
Regulation.....	Page 7
Off loading autorisation	Page 7
Compressor.....	Page 8
Proportional load.....	Page 9
Incident codes.....	Page 9
Board links (J9).....	Page 12
RS-232 link to a (11) computer or B.M.S.	Page 12
J-BUS adresse table.....	Page 13
Variables.....	Page 16
Display	Page 19
Definition of incident codes	Page 21

CLIMATIC control.

Characteristics.

Outputs.

Potential free all-or-nothing actuator

Contact limits:

AC: 10 A 250 V resistive load
4 A 250 V resistive load.

With an inductive load, an RC (resistive capacitive) circuit must be installed on the terminals.

Analogue output

Supplies a voltage of 0 to 10 Volt dc.

Inputs. (Shielded wire is mandatory)

Resistive sensor:

C.T.N. measurement range: 200 Ω to 600 K Ω

Display.



The display has 5 keys:

+ : By pressing this key, the values of the setpoints and variables displayed can be increased.

- : By pressing this key, the values of the setpoints and variables displayed can be decreased.

H : Enables readout and adjustment of hours, minutes and days.

Setting the time on the CLIMATIC control :

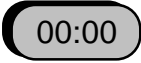
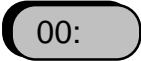
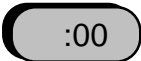
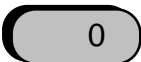
-  Press the H key once, The time is displayed.
-  Press the H key a second time H, the hours are displayed. Modify using + or -.
-  Press the H key a third time, the minutes are displayed. Modify using + or -.
-  press the H key a fourth time, the day of the week is displayed. Modify using + or -.

Note.: Sunday = 1, Monday = 2, ... , Saturday = 7

C : Enables access to and modification of the setpoints. These variables are displayed in the corresponding units. When the key is pressed, the setpoint number (00 to 15) appears, when the key is released, the value of the variable is displayed.

Each press of the C key scrolls up the next setpoint. The value of the setpoint displayed can be modified with the + and - keys.

V : This key gives access to internal variables. When it is pressed, the number of the variable is displayed and when it is released, the value of that variable is displayed. To change addresses, use the + and - keys.

Remark :

A **manual** reset procedure requiring the user to press several keys simultaneously may be necessary to clear certain defaults.

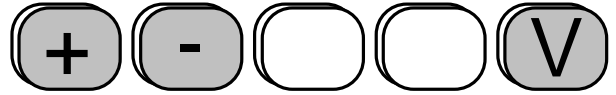

To check the wiring to a board input, call up the address corresponding to the sensor or contact.

Analysis of information :

When the pointer points to an address between 0 and 15, one of the following cases applies :

- if the board input is shorted, the figure 99,5 will be displayed.
- if the board input is open ended, the figure -28 will be displayed.
- if a sensor or resistance is placed between the two terminals, a temperature will be displayed.

If a contact is wired without a sensor,

- if the contact is closed, the figure 1 is displayed if the unit is L (logic), or 255 if the unit is U (unit).
- if the contact is open, the figure 0 is displayed if the unit is L (logic), 000 if the unit is U (unit).

CLIMATIC RS 232 LINK

CLIMATIC boards can be connected with a 4 wire to a personal computer either directly, or using a phone modem, or to a programmable automated system in J-BUS mode via a bridge.

If such a connection is made, all the CLIMATIC variables can be monitored, or modified if necessary from a remote location.

CLIMATIC control variables

Units

CLIMATIC variables can be used under four types of units :

/C : this unit is used to express temperature values (amounts). The CLIMATIC control works with a temperature range from -28.0 to 99.5 in increments of 0,5.
This units can be recognised on the display by the presence of the decimal point.

/K : this unit is used to express temperature differences. The CLIMATIC works with a range from 000.0 to 127.5 in increments of 0,5.
This unit can be recognised by the presence of a decimal point and by display of 3 digits for the whole number part.

/U : this unit enables visualisation of amounts (percentages, times, counter values, The CLIMATIC works with a range from 000 to 255 in increments of 1.
These units can be recognised on the display by the absence of the decimal point.

/N : this unit is identical to /U units.

Variables using these units are not visible on the display.

/L : this unit enables visualisation of logic values 'OFF' 0 or 'ON' 1

This unit can be recognised by the presence of a figure 0 or a figure 1.

Organisation of variables

The Z80 microprocessor manages 256 internal variables.

Distribution of the variables is as follows:

from variable nr 000 to variable nr 015	Temperature sensor inputs
from variable nr 016 to variable nr 031	Hygrometry sensor inputs or potential free contacts
from variable nr 032 to variable nr 120	Operating variables, not stored on shutdown
from variable nr 121 to variable nr 122	Analogue output values 000=0V / 255=10V
from variable nr 123 to variable nr 127	Hour counter on-off status

from variable nr 128 to variable nr 143
from variable nr 144 to variable nr 175
from variable nr 176 to variable nr 178
from variable nr 179 to variable nr 181
from variable nr 182 to variable nr 184
from variable nr 185 to variable nr 187
from variable nr 188 to variable nr 190
from variable nr 192 to variable nr 207
from variable nr 208 to variable nr 223
from variable nr 224 to variable nr 255

Logic outputs (relays)
Pre-assigned variables
1st hour counter, stored on shutdown
2nd hour counter, stored on shutdown
3rd hour counter, stored on shutdown
4th hour counter, stored on shutdown
5th hour counter, stored on shutdown
Setpoints, stored on shutdown
Inter-board variables, stored on shutdown
Operating variables, stored on shutdown

All variables stored on shutdown are saved in battery (Li) maintained RAM (6116) in case 12V ac power supply is lost.

*A jumper located to the left of the battery
must be placed in position **T**
when the unit is put into service for the first time.*

A read-only memory or EPROM contains the variable management program on the board. Depending on the type of program and the type of unit, use of the variables may be different.

SETPOINTS.

Stpt. nr0	CONSA	C	Desired conditioned space temperature	C ₁
Stpt. nr1	MORTE	K	Dead band between heating and cooling	C ₂
Stpt. nr2		N		
Stpt. nr3		N		
Stpt. nr4	T_VOLET	C	Outdoor t°. threshold for free-cooling lock-out	
Stpt. nr5	T_CHAUD	C	Outdoor t°. threshold for electric heater lock-out	
Stpt. nr6	T_FROID	C	Outdoor t°. threshold for compressor operation lock-out	
Stpt. nr7	MINIAIR	U	Minimum % of outdoor air intake	C ₃
Stpt. nr8	DV_J	U	Daily setback time	C ₄
Stpt. nr9	FV_J	U	Time of return to Normal Operation after Daily Setback	C ₅
Stpt. nr10	DV_H	U	Time and Day of Weekly Setback	
Stpt. nr11	FV_H	U	Time and day of return to Normal after Weekly setback	
Stpt. nr12	P_ANTI	U	End of setback anticipation ramp	
Stpt. nr13	FRIMAIR	U	Regulation parameters	
Stpt. nr14	MA_AR_D	U	On/Off	
Stpt. nr15	INIT	U	Initialisation function	
248	MODE_RT	U	Configuration setpoint	
249	DING_A	U	Integration duration setpoint	
250	ENCL_F	K	Setpoint Cooling regulation initiation threshold	
251	DIFET_F	K	Setpoint Cooling regulation differential threshold	
252	ENCL_C	K	Setpoint Heating regulation initiation threshold	
253	DIFET_C	K	Setpoint Heating regulation differential threshold	

Quick call up of the setpoint in readable form on the display ↗

*To adjust supplementary setpoints (248 to 253) :
Adjust setpoint n°015 to the number of the supplementary setpoint concerned,
then adjust setpoint n°013 to the required value.*

Caution :

*For setpoints in K units, multiply the setpoint value in nr 013 by 2 :
(e.g. 1K = 002U)*

*For setpoints in C units, add 28 to the setpoint value in nr 013 then multiply by 2
(e.g. 22C ~> (22 + 28) ^ 2 = 100U)*

CONFIGURATION.

The MODE_RT setpoint enables certain functions to be obtained

- bit n°0 : **001** : Fan stoppage in dead band
- bit n°1 : **002** : Fan stoppage in dead band after heating
- bit n°2 : **004** : No backup resistance heating during defrost
- bit n°3 : **008** : HEAT PUMP then 3-way valve
- bit n°4 : **016** : Cancellation of the HEAT PUMP function
- bit n°5 : **032** :
- bit n°6 : **064** :
- bit n°7 : **128** :

The selection of several functions at the same time is made by adding values together

ON-OFF FUNCTION.

The system is declared « On » if setpoint nr 14 is at 001.

- On units fitted with a display with complete readout,
- If the 'Local / Remote' button [S5] is 'ON' then,
- The « On » button [S3] at 'ON' will force setpoint nr 14 to a value of 001.
- The « Off » button [S3] at 'OFF' will force setpoint nr 14 to a value of 001.

STANDBY (UNOCCUPIED) FUNCTION.

CLIMATIC clock function

If DV_J, setpoint n°08, has a value of 022 and FV_J, setpoint n°09, has a value of 006 then the daily unoccupied period will be activated every day at 22.00 hours until 6.00 hours the next morning.

If DV_H, setpoint n°10, has a value of 207 and FV_H, setpoint n°11, has a value of 082, the weekly unoccupied period will be activated on the 7th day (Saturday) at 20.00 hours [20 7] until the 2nd day (Monday) at 8.00 hours [08 2].

The weekly function takes precedence over the daily function

Full message display

If the 'Local / Remote' button [S5] is 'ON' then button [S1] at 'ON' will force the unit into unoccupied mode.

External contact

Closing input X12 on the CLIMATIC board forces the unit into unoccupied mode.

Cancellation of standby functions

CLIMATIC clock

To cancel the daily program, set the DV_J, setpoint nr 08, & FV_J, setpoint nr 09, to the same value.
To cancel the weekly program, set the DV_H, setpoint nr 10, & FV_H, setpoint nr 11, to the same value.

Full message display

If the 'Local / Remote' button [S5] is at 'ON' then Setting button [S2] at 'ON' will cancel any request for Standby mode.

External contact

Closing contact X13 on the CLIMATIC control board will cancel any requests for Standby mode.

Anticipated start-up at the end of Standby mode

If the Roof-top unit is in standby mode through the action of the CLIMATIC clock, the unit can be restarted before the time set in setpoint, depending on the outdoor air temperature.

The number of hours of anticipation is calculated with the following formula:

$$\text{Hours} = \frac{(+10^{\circ}\text{C} - T_{\text{EXT}}) \times \text{PANTI}}{16}$$

For example, if the outdoor air temperature is +0°C, with the loading ramp set at 006 and the end of standby set for 8h00, under these conditions, the number of hours of anticipation = 3, and the Roof-top unit will start at 5h00 instead of 8h00.

Regulation.

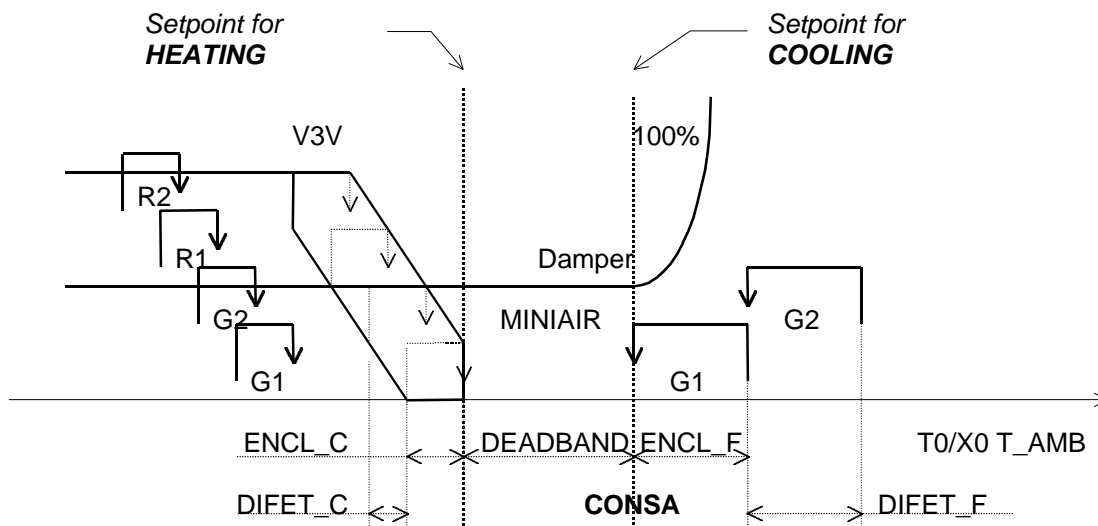

Offsetting the conditioned space temperature setpoint

The required temperature for the conditioned space is adjustable with the CONSA setpoint (setpoint nr 00). This setpoint value can be «offset» by action on a remote potentiometer, by $\pm 5^{\circ}\text{C}$ to either side of the setpoint. This option should be wired to terminal X1 on the CLIMATIC control.

Offloading authorisation.

Economiser

Outdoor air temperature

Use of the Economiser function is authorised if :
 $T_{\text{EXT}} < T_{\text{AMB}}$ and if $T_{\text{EXT}} > \text{setpoint. } T_{\text{VOLET}}$

Enthalpy function.

A calculation of the weight of water in a given volume of air can be made by the CLIMATIC control, if the humidity sensor corresponding to this function is wired to terminals X3. If such is the case, and under certain outdoor air conditions, the economiser function will be locked out and the outdoor air intake damper will be positioned at the minimum outdoor air intake position.

Full message display

If the 'Local / Distance' button [S5] is at 'ON' then
If button [D4] is 'ON' the damper is forced into the « 100% return air recycling » position.
If button [D5] is 'ON' the economiser function is cancelled.
If button [D6] is 'ON' the damper will be forced into the « 100%. Outdoor air » position.

Compressors

Outdoor air temperature

Compressor cooling is authorised if :
 $T_{\text{EXT}} > \text{setpoint. } T_{\text{FROID}}$

Full message display

If the 'Local / Distance' button [S5] is at 'ON' then
If button [D2] is at 'ON' compressor operation is forced to 50%.
If button [D3] is at 'ON' forces offloading of 100% of compressor operation.

External contact

Shunting terminals 216 (10 kΩ resistor in series with SP12 on CLIMATIC input X6) forces 50% compressor offloading.
Shunting terminals 218 ((10 kΩ resistor in series with SP11 on CLIMATIC input X5) forces 100% compressor offloading.

Electric resistance heaters

Outdoor air temperature

Electric resistance heater operation is authorised if :
T_EXT < Setpoint. T_CHAUD or during the defrost phase

Full message display

If the 'Local / Distance' button [S5] is at 'ON' then
If button [D1] is at 'ON' the electric resistance heaters are offloaded 100%.

External contact

Closing input X10 on the CLIMATIC board forces 100% offloading of the electric heaters.

Compressor.

Anti-short cycle

The CLIMATIC program includes a function to prevent compressors from being started up too frequently. This totally prohibits compressor start up, even if the control thermostat is calling for cooling, if the time that has elapsed since the previous start up is lower than 6 minutes.
Variables ANTICCx must be at 000 for compressor start up to be authorised.

Compressor operating time equalisation.

The CLIMATIC program is designed to manage compressor operating time equalisation to within four hours.

Defrost function

On heat pump Roof-top units with air cooled condensers, reverse cycle operation phases are programmed to enable defrosting of the outdoor condenser coil.

If the two conditions listed below are met for more than 45 minutes, a defrost cycle will be initiated :

- 1° Operation of the unit in heat pump mode.
- 2° Outdoor air temperature lower than +10°C.

The duration of the cycle is programmed for 2 to 3 minutes, compressor by compressor

If the outdoor air temperature rises back above the +10°C and if the two conditions above were true for 1 minute, a forced defrost cycle is initiated.

Proportional.

The two proportional outputs are driven by all-or-nothing motors. The position of the outdoor air damper or the valve is transmitted to the CLIMATIC by a repeater potentiometer.

3 way valve

2,2 KΩ potentiometer

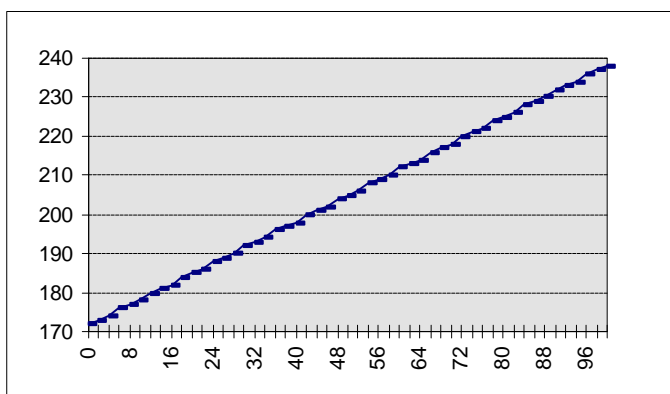

Economiser

2,2 KΩ potentiometer

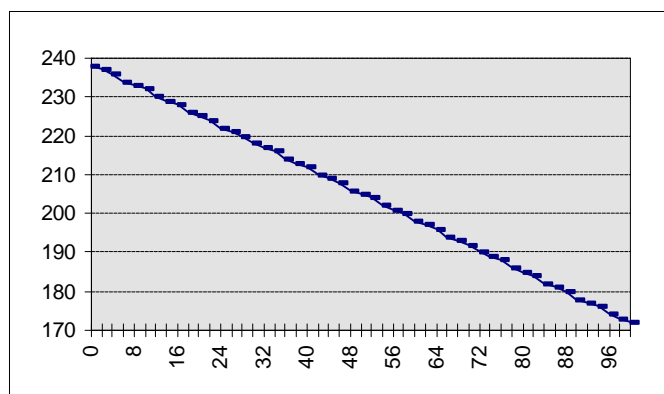

Incident codes.

000	No incidents	
004	Filters dirty	X7
012	Discharge air overtemperature	X4
022	Discharge air under temperature	X4
081	Faulty return air or room temperature sensor	X0
083	Faulty discharge air temperature sensor	X4
084	Faulty outdoor air temperature sensor	X2
091	Fan default (<i>KVS safety chain</i>)	X8
115	High pressure default on compressor nr 1	X9
117	Low pressure default on compressor nr 1	X10
125	High pressure default on compressor nr 2	X5
127	Low pressure default on compressor nr 2	X6

004

Information on dirty filters.

CLIMATIC X7; Pressure switch SP5

If the filter pressure switch opens for more than 1 minute, the CLIMATIC generates a filter dirty default. Incident code **004** is displayed, the general default signal contact is activated, the unit does not shut down.

Discharge air temperature safety

CLIMATIC X4; BT14; ST41

Discharge high limit

1st safety level

If the air discharge temperature is +40°C or more, heating regulation stages off progressively. The regulation cycle picks up and operates normally once the temperature has dropped back to less

than 35°C.

012

2nd safety level

If the air discharge temperature is +60°C or greater, the safety thermostat is activated. This safety device resets itself automatically when the temperature drops back under 55°C. Incident code **012** is displayed, the general default contact is activated.

Low air discharge temperature limit

1st safety level

If the air discharge temperature is +10°C or lower, cooling regulation is progressively staged off. The regulation cycle picks up and operates normally once the temperature has risen above 15°C.

2nd safety level

If the discharge air temperature is +8°C or lower, the Roof-Top automatically positions its outdoor air damper into the 100% return air position. This safety level is cleared when the temperature rises above +12°C.

022

3rd safety level

If the discharge air temperature is +2°C or lower for more than 15 minutes and 15 minutes after start up of the ventilation, the low discharge air temperature safety thermostat opens and the Roof-Top unit is completely shut down. Incident code **022** is displayed, , the general default contact is activated.

This safety protection is cleared when the temperature rises above +15°C. In addition, the fault condition is maintained if the fault occurs three times in the same day, in which case the unit has to be reset manually. This default counter is reset every day at 20.00h if the number of counts has not exceeded 3.

Note: On a Roof-top unit equipped with a hot water heating coil, the temperature limit threshold is set at +6°C and the delay before fault recognition is 5 seconds. In addition, if the antifreeze protection thermostat trips, the 3rd safety level is immediately adopted and held, and the thermostat then the CLIMATIC control have to be manually reset.

Sensor status

081

Room thermostat missing or defective.

CLIMATIC X0; BT10

083

Discharge air thermostat defective.

CLIMATIC X4; BT14

084

Outdoor air thermostat defective.

CLIMATIC X2; BT12

The absence or defective operation of the conditioned space sensor, discharge air sensor or outdoor air sensor can cause incorrect operation of the control system. In this case, a safety device trips and all components are stopped with the exception of the fans. Incident code **081** for the conditioned space sensor, **083** for the discharge sensor and **084** for the outdoor air temperature sensor, is displayed; the general default contact is activated.

091

Fan contactor contacts have not made when the CLIMATIC demands fan operation.

CLIMATIC X8; KVS

- The fire safety thermostat, or fire safety insert, has opened. *ST1, terminals 11 & 12*
- One of the « Klixons » on the electric resistance heaters has opened. *ST2, ST3 & ST4*
- The thermal protection device on the air handling fan has tripped. *ST5*

The fire safety thermostat, the fan motor thermal protection device, and the electric heater protection thermostats (Klixons) all act directly on the fan motor contactor. This information is transmitted to the CLIMATIC control by the contactors auxiliary contact.

If the CLIMATIC control gives the command for fan operation and 5 seconds later, the auxiliary contact is still open, the fan safety protection cuts in and the entire Roof-Top unit is shut down. Incident code **091** is displayed, the general default contact is activated.

This safety trip out is maintained, and manual reset is mandatory.

If the Roof-Top unit is equipped with a servo-motor driven damper, detection time is increased to 2 minutes.

Note: This incident code will also be displayed if the auxiliary contact is shunted.

115

The high pressure switch on circuit x1x or x2x is, or has been, open.
CLIMATIC X9, X10; SP1, SP2

125

If the contact of the high pressure switch opens and if the compressor has been running for more than 5 seconds, the high pressure safety protection is tripped and the compressor is shut down. Incident code **115** or **125** is displayed, depending on which compressor is concerned, the general default contact is activated.

The compressor will be authorised to start up again as soon as the contact is closed.

This safety condition is held if it happens 3 times in the same day, in which case reset must be done manually. Cut-out counters are reset to zero every evening at 20h.00 if there has been no more than 3 cut-outs.

117

The low pressure switch on circuit x1x or x2x is, or has been, open.
CLIMATIC X5, X6; SP11, SP12

127

If the low pressure switch opens and if the compressor has been operating for more than 2 minutes, low pressure safety protection is activated and the compressor is stopped. This safety protection is not taken into account during the defrost cycle on Roof-Top heat pumps.

Incident code **117** or **127** is displayed, depending on which compressor is concerned. The general default contact is activated.

The compressor will be authorised to start up again as soon as the contact is closed. This safety condition is held if it happens 3 times in the same day, in which case reset must be done manually. Cut-out counters are reset to zero every evening at 20h.00 if there has been no more than 3 cut-outs.

Board links (J9).

Setpoint setback potentiometer

If the inter-board link is used, a single control box with a potentiometer connected to the unit with CLIMATIC board nr 0 is sufficient, since the other units receive the setback value via the common information bus.

Enthalpy function.

If the inter-board link is used, a single outdoor air relative enthalpy sensor connected to the unit with CLIMATIC board nr 0 is sufficient, since the other units receive the enthalpy value via the common information bus.

Zoning.

If the inter-board link is used, the CLIMATIC control calculates the number of units demanding cooling then the number of units demanding heat.

If the number of units demanding cooling is greater than or equal to the number of units demanding heat heating regulation will be inhibited on the latter.

By the same principle, if the number of units demanding heat is greater than the number of units demanding cooling, cooling regulation will be inhibited on the latter.

RS-232 (J11) link to a computer or B.M.S.

Some commands, available through dry contacts, connected to the 24EL can be triggered via the RS-232 port. These commands can be accessed through the ORDI variable at address 221.

Note :

To enable the CLIMATIC to take account of the ORDI variable, the following conditions must be satisfied :

Either variable GTC, at address 220, must be greater than zero.

Or bit nr 7 of the MA_AR_D setpoint, setpoint nr 14 address 206, must be active.

The variable GTC enables account to be taken of the validity of the link between the CLIMATIC and the BMS.. The CLIMATIC decrements the GTC variable by one unit every second. The B.M.S. program must periodically regenerate this value. A dropped link or the stoppage of the B.M.S. will result in zeroing the validation variable and return the CLIMATIC to free-standing operation.

Codes for the ORDI variable, address 221.

- Bit nr 0 : Unoccupied
- Bit nr 1 : Forced occupation
- Bit nr 2 : Electric resistance heater shutdown
- Bit nr 3 : 50% compressor capacity reduction
- Bit nr 4 : 100% compressor capacity reduction
- Bit nr 5 : Forced operation at 0% outdoor air
- Bit nr 6 : Forced operation at minimum outdoor air
- Bit nr 7 : Forced operation at 100% outdoor air

Table of J-BUS addresses

Unit conversions

/C Temperature Range from -28.0 to +99.5 in increments of 0.5

Write $Octet = (T + 28) \times 2$ e.g. $(22.5 + 28) \times 2 = 101$

Read $T = \left(\frac{Octet}{2} \right) - 28$ e.g. $\left(\frac{101}{2} \right) - 28 = 22.5$

/K Temperature Range from 0.0 to +127.5 in increments of 0.5

Write $Octet = T \times 2$ e.g. $1.5 \times 2 = 003$

Read $T = \left(\frac{Octet}{2} \right)$ e.g. $\left(\frac{003}{2} \right) = 1.5$

/U Unit Range from 000 to +255 in increments of 1

Write $Octet = U$ e.g. $48 = 048$

Read $U = Octet$ e.g. $048 = 48$

/L Logical Range "OFF" 0 or "ON" 1

Write $Off = 000$
 $On = 255$

Read $000 = Off$
 $255 = On$

CLIMATIC		
CONSA	/C	192
MORTE	/K	193
T_VOLET	/C	196
T_CHAUD	/C	197
T_FROID	/C	198
ENCL_F	/K	250
DIFET_F	/K	251
ENCL_C	/K	252
DIFET_C	/K	253
HE	/U	146
MN	/U	145
JS	/U	147
RAH	/U	167
DING	/U	249
MINIAIR	/U	199
DV_J	/U	200
FV_J	/U	201
DV_H	/U	202
FV_H	/U	203
P_ANTI	/U	204
ORDI	/U	221
GTC	/U	220
MA_AR_D	/U	206

Write	J-BUS
Required conditioned space temperature	00h
Deadband between heating and cooling	01h
Outdoor air T° threshold for free-cooling inhibition	05h
Outdoor air T° threshold for electric heater inhibition	06h
Outdoor air T° threshold for cp cooling inhibition	07h
Cooling regulation cut-in threshold	09h
Cooling regulation differential threshold	0Ah
Heating regulation cut-in threshold	0Bh
Heating regulation differential threshold	0Ch
Hours	30h
Minutes	31h
Day of the week	32h
Clock reset	33h
<i>Force once to 255 after each clock reset</i>	
Integration time	34h
% for minimum outdoor air	35h
Time for start of daily unoccupied period	36h
Time for end of daily unoccupied period	37h
Time and day of start of weekly unoccupied period	38h
Time and day of end of weekly unoccupied period	39h
Anticipation gradient	3Ah
Component off-loading	3Bh
<i>bit nr 0 : Unoccupied mode</i> <i>bit nr 1 : Forced unoccupied mode</i> <i>bit nr 2 : Electric resistance heater offloading</i> <i>bit nr 3 : 50% compressor capacity reduction</i> <i>bit nr 4 : 100% compressor capacity reduction</i> <i>bit nr 5 : Forced operation at 0% outdoor air</i> <i>bit nr 6 : Forced operation at minimum outdoor air</i> <i>bit nr 7 : Forced operation at 100% outdoor air</i> <i>The CLIMATIC program only takes account of these bits if the BMS variable is greater than 0.</i>	
BMS link validity	3Ch
<i>This must be greater than 0 if the ORDI variable is used.</i> <i>The CLIMATIC program decrements this value by 1 unit per second</i>	
ON/OFF	3Dh
<i>bit nr 0 : Unit ON/OFF</i> <i>bit nr 1 : Unit control via switch A14 (customer)</i>	

CLIMATIC		
T_AMB	/C	000
T_EXT	/C	002
T_SOUF	/C	004
H_EXT	/U	019
DEGI	/U	079
POST_V	/U	097
VANNE	/U	121
VOLET	/U	122
S_SONDE	/U	224
ST_SOUF	/U	225
DEF_VS	/U	227
DEF_G1	/U	229
DEF_G2	/U	230
PANNE	/U	255
TO_VS0	/U	176
TO_VS1	/U	177
TO_VS2	/U	178
TO_G10	/U	179
TO_G11	/U	180
TO_G12	/U	181
TO_G20	/U	182
TO_G21	/U	183
TO_G22	/U	184
VENT_S	/L	128
COMP_G1	/L	129
COMP_G2	/L	130
INJ_G1		
VENTC12	/L	133
ALARME	/L	135
VIC_G12	/L	137
CHAU_1	/L	139
CHAU_2	/L	140
CLIENT	/L	142
MA_AR	/L	096
INOCCUP	/L	098
ANTICIP	/L	099
HORSSEL	/L	100

Read	J-BUS
Room or return air temperature	80h
Outdoor air temperature	81h
Discharge air temperature	82h
Indoor air relative humidity	A1h
Defrost function <i>= number of the compressor currently in defrost mode</i>	A2h
Duration of post-ventilation after heating (seconds)	A3h
Proportional heating or cooling valve or triac	A4h
Proportional air damper	A5h
Sensor status <i>bit nr 0 : Outdoor air sensor faulty</i> <i>bit nr 1 : Discharge air sensor faulty</i> <i>bit nr 2 : Room air sensor faulty</i>	A6h
Discharge air temperature safety <i>bit nr 0 : 1 high level limit</i> <i>bit nr 1 : 1° low level limit</i> <i>bit nr 2 : 2 low level limit</i> <i>bit nr 3 : 3 low level limit (Alarm)</i> <i>bit nr 4 : 2 low level limit (Alarm)</i>	A7h
Discharge fan default <i>bit nr 0 : Filter pressure switch</i> <i>bit nr 2 : Fan motor contactor (Stoptherm, D.I.)</i>	A8h
Compressor nr 1 default <i>bit nr 0 : Low pressure switch</i> <i>bit nr 1 : High pressure switch</i>	AAh
Compressor nr 2 default <i>bit nr 0 : Low pressure switch</i> <i>bit nr 1 : High pressure switch</i>	ABh
Incident codes	AFh
VENT_S (+1 every minute)	B0h
VENT_S (+1 every 4 hours)	B1h
VENT_S (+1 every 1000 hours)	B2h
COMP_G1 (+1 every minute)	B3h
COMP_G1 (+1 every 4 hours)	B4h
COMP_G1 (+1 every 1000 hours)	B5h
COMP_G2 (+1 every minute)	B6h
COMP_G2 (+1 every 4 hours)	B7h
COMP_G2 (+1 every 1000 hours)	B8h
Discharge fan	C0h
Compressor group nr 1	C1h
Compressor group nr 2 or Hot gas injection compressor group nr 1	C2h
Condenser fans group nr 1 & nr 2	C5h
General default signal	C7h
Cycle changeover valve groups nr 1 & nr 2	C9h
Crankcase heater 1st stage	CBh
Crankcase heater 2nd stage	CCh
Miscellaneous customer control	CEh
Unit ON/OFF status	D0h
Unoccupied function	D1h
End of unoccupied period anticipation function	D2h
Building frost protection function	D3h

Variables.

0	T0	T_AMB	C	Conditioned space or return air temperature
2	T2	T_EXT	C	Outdoor air temperature
4	T4	T_SOUF	C	Discharge air temperature
16	X0	X0	U	CLIMATIC reference voltage adjustment
17	X1	POTTEMP	U	Temperature offset potentiometer
19	X3	H_EXT	U	Outdoor air relative humidity
30	X14	POT_ECO	U	Proportional economiser potentiometer
31	X15	POT_V3V	U	3-way proportional heating valve potentiometer
32	NV0	AUX_VS	L	Discharge fan auxiliary contact
33	NV1	P_FIL	L	Clogged filter pressure switch
34	NV2	P_BP_G1	L	Evaporator refrigerant pressure switch unit 1
35	NV3	P_BP_G2	L	Evaporator refrigerant pressure switch unit 2
36	NV4	P_HP_G1	L	Discharge pressure switch unit 1
37	NV5	P_HP_G2	L	Discharge pressure switch unit 2
38	NV6	MA_RE	L	100% electric heat offloading switch
39	NV7	MA_50	L	50% compressor offloading switch
40	NV8	MA_100	L	100% compressor offloading switch
41	NV9	C_RRECY	L	100% recycled air forcing switch
42	NV10	C_RMINI	L	Forced Economiser function cancellation switch
43	NV11	C_RNEUF	L	100% outdoor air forcing switch
44	NV12	C_VEIL	L	Forced standby operation switch
45	NV13	C_RELAN	L	Repeat forced standby operation switch
46	NV14	LOCAL	L	Local/Remote display button
66	N2	CONSA_A	C	Real value of conditioned space temperature setpoint
67	N3	CONSA_S	C	Real value of discharge air temperature setpoint
75	N11	PROF	U	Cooling control power factor
76	N12	PROC	U	Heating control power factor
77	N13	STEP_GF	U	Number of compressor stages for cooling operation
78	N14	STEP_GC	U	Number of compressor stages for heating operation
79	N15	DEGI	U	Defrost function
80	N16	STEP_RC	U	Number of electric heat stages
83	N19	ENTHA	L	Enthalpy control function
90	N26	FLAG	L	Calculation variable
96	V0	MA_AR	L	Unit on/off status
97	V1	POST_V	U	Post-ventilation after heating (seconds)
98	V2	VEILLE	L	Standby function
99	V3	ANTICIP	L	Anticipation function for end of standby
100	V4	HORSGEL	L	Building frost protection function
101	V5	OK_AIR	L	Correct airflow status
102	V6	REGUL_G	U	Unit start request
104	V8	ANTICC1	U	Anti short-cycle function, unit nr 1
105	V9	ANTICC2	U	Anti short-cycle function, unit nr 2
108	V12	REGUL_R	U	Request for start-up of electric heat
110	V14	REGUL_C	U	Opening of the proportional valve for heating
111	V15	REGUL_V	U	Opening of outdoor air damper
112	V16	DISPO_V	U	Availability of outdoor air damper
113	V17	REGUL_S	U	Request for fan start-up
115	V19	TT_SOUF	L	Working variable
118	V22	OK	L	Variable for display
119	V23	LEC	L	Variable for display
128	A0	VENT_S	L	Discharge fan
129	A1	COMP_G1	L	Compressor on unit nr 1
130	A2	INJ_G1	L	Hot gas injection valve on unit nr 1
130	A2	COMP_G2	L	Compressor on unit nr 2
131	A3	VIC_G12	L	Cycle inversion valves on units nr 1 & nr 2
132	A4	VENTC12	L	Condenser fans on units nr 1 & nr 2
133	A5	CHAU_1	L	1st stage of electric resistance heat
134	A6	CHAU_2	L	2nd stage of electric resistance heat

135	A7	ALARME	L	General default
136	A8	ECO_M	L	Outdoor air damper closing command
137	A9	ECO_P	L	Outdoor air damper opening command
138	A10	CHAUD_M	L	3-way heating valve closing command
139	A11	CHAUD_P	L	3-way heating valve opening command
149	NSER	NSER	U	Serial number
165	NCAR	NCAR	U	CLIMATIC board number
166	PRECAR	PRECAR	U	Presence of linked boards
176	TO00	TO_VS0	U	VENT_S(+1 every minute)
177	TO01	TO_VS1	U	VENT_S(+1 every 4 hours)
178	TO02	TO_VS2	U	VENT_S(+1 every 1000 hours)
179	TO10	TO_G10	U	COMP_G1 (+1 every minute)
180	TO11	TO_G11	U	COMP_G1 (+1 every 4 hours)
181	TO12	TO_G12	U	COMP_G1 (+1 every 1000 hours)
182	TO20	TO_G20	U	COMP_G2 (+1 every minute)
183	TO21	TO_G21	U	COMP_G2 (+1 every 4 hours)
184	TO22	TO_G22	U	COMP_G2 (+1 every 1000 hours)
192	CO0	CONSA	C	Requested conditioned space temperature
193	CO1	MORTE	K	Dead-band between cooling and heating
196	CO4	T_VOLET	C	Outdoor air temp. threshold for free cooling inhibition
197	CO5	T_CHAUD	C	Outdoor air temp. threshold for electric heat inhibition
198	CO6	T_FROID	C	Outdoor air temp. threshold for compressor inhibition
199	CO7	MINIAIR	U	Minimum % of outdoor air
200	CO8	DV_J	U	Time of start of daily unoccupied period
201	CO9	FV_J	U	Time of end of daily unoccupied period
202	CO10	DV_H	U	Time and day of start of weekly unoccupied period
203	CO11	FV_H	U	Time and day of end of weekly unoccupied period
204	CO12	PANTI	U	Ramp for end of unoccupied period anticipation function
205	CO13	FRIMAIR	U	Control parameters
206	CO14	MA_AR_D	U	On/OFF
207	CO15	INIT	U	Initialisation function
208	CM0	MPOTART	K	Transmitted temperature potentiometer
210	CM2	MT_ECO	U	Transmitted enthalpy function
211	CM3	T_EXT_C	C	Transmitted outdoor air temperature
212	CM4	ZONE_0	U	Zoning function variable
213	CM5	ZONE_1	U	Zoning function variable
214	CM6	ZONE_2	U	Zoning function variable
215	CM7	ZONE_3	U	Zoning function variable
216	CM8	ZONE_4	U	Zoning function variable
217	CM9	ZONE_5	U	Zoning function variable
218	CM10	ZONE_6	U	Zoning function variable
219	CM11	ZONE_7	U	Zoning function variable
220	CM12	GTC	U	B.M.S. dialogue confirmation
221	CM13	ORDI	U	Component offloading (binary) by the B.M.S.
222	CM14	NBC	L	Inter-board variable
223	CM15	NBCM	U	Inter-board variable
224	IN0	S_SONDE	U	Sensor status
225	IN1	ST_SOUF	U	Discharge safety
227	IN3	DEF_VS	U	Discharge fan default
229	IN5	DEF_G1	U	Compressor nr 1 default
230	IN6	DEF_G2	U	Compressor nr 2 default
234	IN10	TO_SOUF	U	Low discharge air temperature default cut-out counter
235	IN11	TO_VS	U	Discharge fan default counter
236	IN12	TOPBP12	U	Low pressure cut-out counter unit nr 1 & nr 2
238	IN14	TOPHP12	U	High pressure cut-out counter unit nr 1 & nr 2
242	IN18	TOGEL12	U	Freeze-up time on compressors nrs 1 & 2
244	IN20	TO_DEGI	U	Defrost cycle duration
245	IN21	TO_RST	U	Re-start counter

246	IN22	MAXI_F	U	Number of conditioned space cooling control stages
247	IN23	MAXI_C	U	Number of conditioned space heating control stages
248	IN24	MODE_RT	U	Configuration setpoint
249	IN25	DING_A	U	Integration time setpoint
250	IN26	ENCL_F	K	Cooling control cut-in threshold setpoint
251	IN27	DIFET_F	K	Cooling control differential threshold setpoint
252	IN28	ENCL_C	K	Heating control cut-in threshold setpoint
253	IN29	DIFET_C	K	Heating control differential threshold setpoint
254	IN30	AFFICHE	U	Variable for display
255	IN31	PANNE	U	Incident code

DISPLAY.

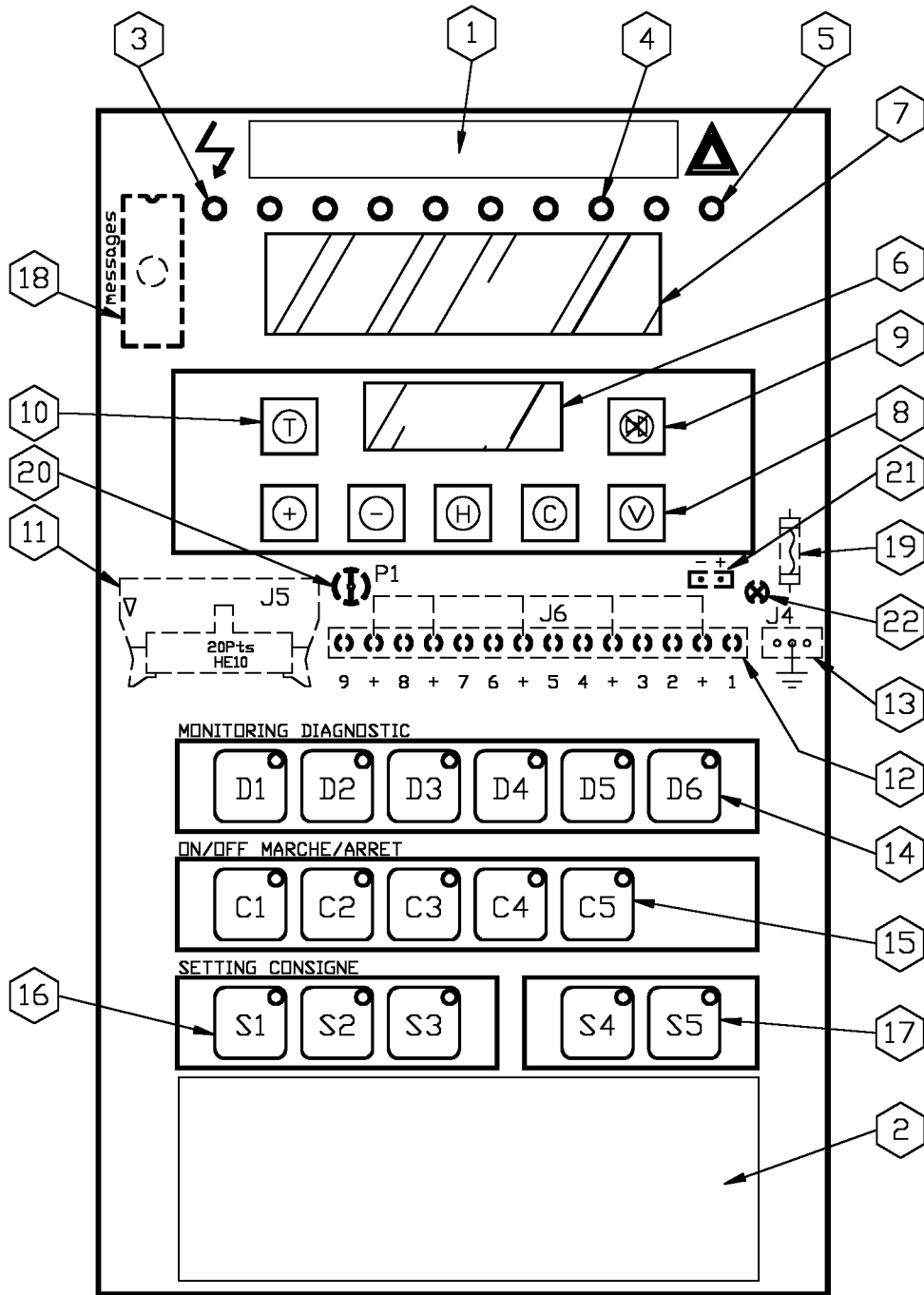

LEGEND :

- 1** Green LED description leaflet, *removable from the rear.*
- 2** Keys D1 to D6, C1 to C5 & S1 to S5 description leaflet, *removable from the rear.*
- 3** Yellow « power on » LED
- 4** Eight green LEDs
- 5** Red default LED
- 6** Digital display

- 7** Alpha-digital display, *describes the value displayed on the digital display.*
- 8** CLIMATIC function keys, *see page 2.*
- 9** Buzzer clearing key, *the buzzer is an option.*
- 10** Language change, *Two languages are available : French or English.*
- 11** 20 pin CLIMATIC connector on the rear.
- 12** Nine potential-free contacts for the eight green LEDs and the red LED.
- 13** 12 VAC power connector
- 14** Six keys for the offloading functions.
- 15** Five shortcut keys for calling up setpoints.
- 16** Three function keys for Start-Stop-Standby.
- 17** Two keys, one for resetting the safety devices, the other for selecting Remote/Local mode.

Selecting the Remote mode deactivates keys **14 **15** **16** and their functions are no longer taken into account by the CLIMATIC program.**

- 18** Message and key configuration EPROM
- 19** Slow-Blow 1A fuse protecting green LEDs and lighting for the two LCD displays.
- 20** Alpha-digital display contrast adjustment potentiometer, on rear side.
- 21** Two-pin connector for the buzzer, on the rear side (option).

Before replacing the display, recover the message EPROM from the old display, as well as the description leaflets.

The leaflets are located behind the removable panels at the rear of the display.

If there is no display, check the power supply to the CLIMATIC. The display power supply is used only for the LCD display and the 10 LEDs on the upper section of CL 07.

DEFINITION OF INCIDENT CODES.

000	No defaults	RT	MA	CAT	ORD
------------	-------------	----	----	-----	-----

Airflow defaults **PAN_DA**

001	Incorrect airflow	RT	MA		ORD
004	Clogged filters	RT	MA		ORD

Heating defaults **PAN_C**

011	Electric heating coil default	RT	MA		ORD
012	Discharge air overtemperature	RT	MA		ORD
013	Return or room air under temperature				ORD
014	Default on gas burner nr 1	RT			
015	Default on gas burner 2	RT			
016	Default on gas burner 3	RT			
017	Gas heat exchanger overtemperature	RT			

Mechanical cooling defaults **PAN_F**

022	Discharge air under temperature	RT	MA		ORD
023	Return or room air overtemperature				ORD

Humidity defaults **PAN_H**

031	Humidifier default				ORD
032	Return air relative humidity too low				ORD
033	Return air relative humidity too high				ORD

C.A.T. specific defaults **PAN_CAT**

041	Default, pump nr 1 or nr 2 circuit nr 1			CAT	
042	Default, pump nr 3 or nr 4 circuit nr 2			CAT	
043	Default, pump nr 5 or nr 6 circuit nr 3			CAT	
044	Domestic hot water circulating pump default			CAT	
045	Regulated water circuit circulating pump default			CAT	
046	Default indicator, boiler nr 1			CAT	
047	Default indicator, boiler nr 2			CAT	
048	Boiler water level default			CAT	
049	Retention tank level default			CAT	
051	Temperature too low, circuit nr 1			CAT	
052	Temperature too low, circuit nr 2			CAT	
053	Temperature too low, circuit nr 3			CAT	
054	Temperature too low, domestic hot water circuit			CAT	
055	Temperature too low, boiler circuit			CAT	

Miscellaneous defaults **PAN_D**

071	Temperature sensor default, water loop outlet nr 1			CAT	
072	Temperature sensor default, water loop outlet nr 2			CAT	
073	Temperature sensor default, water loop outlet nr 3			CAT	
074	Temperature sensor default, domestic hot water outlet			CAT	
075	Temperature sensor default, boiler return water			CAT	
076	Temperature sensor default, boiler leaving water			CAT	

081	Temperature sensor default, return air or room air	RT	MA		ORD
082	Humidity sensor default, return air RH				ORD
083	Temperature sensor default, discharge air	RT	MA		ORD
084	Temperature sensor default, outdoor air	RT	MA	CAT	
085	Temperature sensor default, chilled water				ORD
086	Temperature sensor default, hot water				ORD
089	Inter-board link default	RTw			
091	Ventilation default (Firestat, Stop therms, no 24V power supply)	RT	MA		ORD
092	Fan thermal safety cutout on 1st condenser or cooling tower				ORD
093	Fan thermal safety cutout on 2nd condenser or pump				ORD
094	Customer specific default contact	RT	MA		
095	Water leakage default				ORD
096	Condenser water temperature too low	RT	MA		
097	Condenser water overtemperature	RT	MA		
098	Humidifier or water flow default	RT	MA		
099	Smoke default	RT	MA		

Compressor defaults **PAN_1 PAN_2 PAN_3 PAN_4**

1n1 : n = number of the compressor concerned

1n1	Discharge temperature sensor faulty				ORD
1n2	Subcooling temperature sensor faulty				ORD
1n3	Evaporator refrigerant temperature sensor faulty				ORD
1n4	Tripped internal electric motor protection				ORD
1n5	High pressure default	RT	MA		ORD
1n6	Discharge overtemperature	RT	MA		ORD
1n7	Low pressure default	RT	MA		ORD
1n8	Refrigeration circuit empty				ORD

LENNOX[®]

Siège social - Headoffice :

Les Meurières - BP 71
69780 MIONS - FRANCE

Tél - Phone : +33 (0)4 72 23 20 20

Fax : +33 (0)4 72 23 20 28

Ref :

CLIM_RTK/ANGLAIS/12-97

Les caractéristiques techniques et spécifications figurant dans cette notice sont données à titre indicatif. Le constructeur se réserve le droit de les modifier sans préavis ni obligation pour lui de modifier identiquement les matériels déjà livrés.

The specifications and technical characteristics in this booklet are given for information purposes. The manufacturer reserves the right to modify them without prior notice or obligation to modify in a similar manner the equipment previously supplied.