

## Brief description of KR 15 controllers



Page 2

1. **Function of the controller**

Page 4

2. **Terminal connections**

Page 5

3. **Technical data**

Page 6

4. **Initial operation**

Page 9

5. **Manual mode / external mode**

**Supply air temperature regulation**

Page 20

6. **Trouble-shooting and fault messages**

Page 24

7. **Safety and precautions**

# 1. Function of the controller

**KR15 = 1500 Watt –  
for wheel diameter from 5000 mm**

## Special features:

- the controllers are usable worldwide
- all known regulations are taken into account by us for construction of the controller
- it is therefore the most modern generation of controllers by far
- the controllers are operated using only three buttons. The results and queries are displayed in a lighted, two-part display
- In hardwired condition, the controller is immediately ready to operate after turning on the mains voltage
- Faults are shown in the display



- The latest processor technology
- CE - tested
- Housing IP 54
- Short-circuit-proof output
- EN 55011 tested
- EN 61000-3 tested
- EN 61000-4-2 tested
- EN 61000-4-4 (Burst) tested
- EN 61000-4-5 (Surge) tested
- EN 61800-3 tested
- Every individual module is tested
- Detailed error message
- Thermal contact monitoring / PTC-resistor
- Two-row, colour, illuminated LCD display
- Operating report
- Start-up and discharge circuit
- Menu-controlled programming

#### Optional accessories:

- Rotor control including function display
- Enthalpy sensor



- Clear LCD text display
- 3 languages GER/EN/NL
- Three-button operation
- External control signal processing
- Self-cleaning mode
- Priority speed adjustable 1 max. frequency
- Max. frequency adjustable 50-120 Hz
- Summer operating mode including function display
  - Enthalpy comparison
  - Temperature comparison
  - Temperature changeover
- Supply air temperature regulation
- Sequential circuit
  - including function display
- 0-10 V DC analogue output
- External fan output

- ThermaGard MWTM active supply air temperature sensor
- TPT 1000 temperature sensor

## 2. Terminals at the control units KR 15

A supply voltage of +24 volts DC is applied to terminals 4, 7 and 9.

+15 volts DC is applied to terminal 11.

+10 V DC is applied to terminals 16 and 19 for the enthalpy sensor.

Changeover contacts shown in de-energised position

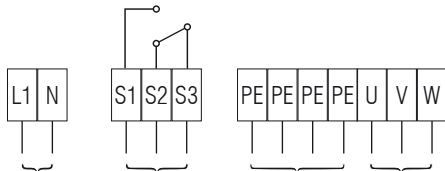
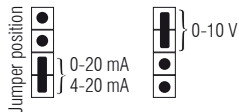

Mains (230Volt) 50-60 Hz

Error message:  
During operation S1 and S3 closed  
By occurring of defects or net failure!  
S2 and S3 closed

3-phase AC motor (3x230 Volt)  
in delta connection  
with standard motors 230/400 Volt

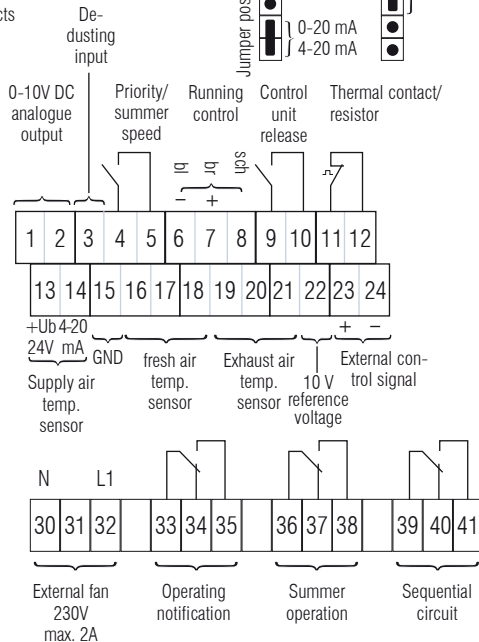

## Technical Data

<b>Controller typ</b>	<b>KR 15</b>
<b>Output</b>	1,5 kW
<b>Fuse (internal)</b>	16 A
<b>Mains voltage</b>	220-240 Volt / 50-60 Hz 1~
<b>Weight</b>	8000 g
<b>Environmental temperature</b>	from -10°C bis +40°C (for temperatures lower than 0°C it is necessary to switch on the mains voltage to the device without the motor running so that the controller can warm up)
<b>temperature adjustment range (only KR 4 Z / KR 7 Z)</b>	Air supply temperature regulation 10°C - 40°C /summer switchover 18°C - 42°C Other adjustment ranges must be specifically set
<b>Type of protection</b>	IP 54
<b>Output frequency</b>	0-120 Hz (factory setting 80 Hz)
<b>Frequency resolution</b>	0,08 Hz
<b>Controller signal</b>	0-10 V, 0-20 mA, 4-20 mA
<b>Fault message relay</b>	Potential-free changeover contact, 250 V AC, 1 A capacity
<b>Motor connecting line</b>	The connecting line must be shielded; chokes should be provided for lengths of over 50 m. Please inquire!
<b>Dimensions</b>	L=355 mm B=266 mm H=168 mm

## 4. Initial operation of the KR 15 controller

The KR control unit is operated entirely by means of three buttons. Selections are made with the left (▲) and right (▼) button. The middle button (◀) is used to confirm the selection. If all three buttons are pressed at the same time, programming mode opens.

### Initial operation

After connection to the mains voltage, the software version appears briefly in the display.

```
KR_V : x . x      D / E
```

Then for connected controller enabling:

```
Nom. freq. :    00Hz  
Act. freq.  :    00Hz
```

If the controller is not enabled, this appears:

```
Contr. blocked!  
Act. freq.  :    00Hz
```

```
Hardware error:  
E: 01!
```

```
Error! Motor  
High temperature
```

The system must be checked in accordance with the display.

Start by pressing all three buttons: (▲) (◀) (▼) A message appears after about 2 seconds:

```
  P l e a s e   w a i t !
```

The control unit takes you through the menu items when the motor has stopped.

### Moving through the menu items

You have a choice of English, German or Dutch. Other menu languages are also available on request. The language is changed by means of the selection buttons ▲ ▼.

```
  D e u t s c h
```



```
  E n g l i s h
```



```
  N e d e r l a n d s
```

Confirm by pressing the Enter key (↵) The following will then appear:

```
  M a n u a l   o p e r a t i o n
```



```
  E x t e r n a l
  D r i v e
```



```
  I n p u t t e m p e r a t u r e
  r e g u l a t o r
```

As before, make your choice using the selection buttons and confirm with Enter (↵).

In accordance with your choice, the control unit then leads you through the menu options for „Manual operation“, „External control“ or „Supply air temperature regulation“, as described below.

## Manual operation

The following appears:

```
Man. frequency:
00 Hz
```

A frequency can be set using the selection button, which is used as soon as programming has been carried out and the start command has been given (using ).

## External control:

The following appears:

```
Start point:
05%
```

The starting point can be set between 0-40% and relates to the control signal. With a setting of 10%, the control unit only reacts with a control signal of 1 volt. This prevents interference voltages leading to unintended operation of the control unit.

## Supply air temperature regulation

After confirmation, the following menu appears:

```
Set point:
16 °C
```

The supply air temperature required is set using this menu (between 0° C - 40°C).

The PI control unit is activated for supply air temperature regulation. This control maintains the target value set at a constant level. The Klingenburg temperature sensor with active output is required for this (ThermasGard MWTM):



```
P - Verstärkung
0.2-5.0      01.0
```

The amplification factor is set here. **Attention:** The value should not be set  $> 1.0$ , as otherwise excessive under and over-oscillation may come about.

```
Integrationszeit
0.1-99.9    01.0s
```

This affects the response time of the control system. The greater the time, the slower the response time.

## 5. Manual mode / External mode / Supply air temperature regulation

When the Enter button (↵) is pressed, the following appears:

```
Minimal
Frequency    00Hz
```

This menu can be used to set a minimum frequency of 0-10 Hz for purpose-built products, which is used when the control unit is released. If there is a control signal that requires a higher speed, the control unit adjusts to this requirement (standard setting 00 Hz).

```
Maximal
Frequency    80Hz
```

The maximum final frequency that the control unit uses with a full control signal (10 volts DC) can be set using this menu from 50 - 120 Hz. at max. frequency, the rotor should rotate at approx. 10 revs./min the max. speed is determined by the design of the drive unit. **Attention!** All Klingenburg motors are suitable for frequencies up to 120 Hz.

The control unit has a programmable priority frequency, which is also controlled with the contact closed (terminal 4 and 5) and a 0-10 volt signal. This contact can easily be used to operate at frost speed, for example, or for summer operation.

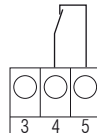

Example:

### Optional: Frost protection thermostat

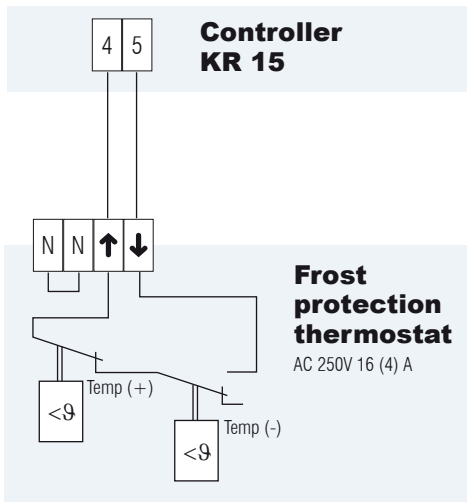

This menu can be used to select the term that should appear on the display when the contact is activated:

O	p	t	i	o	n	a	l		i	n	p	u	t	:	
P	r	e	c	e	d	e	n	c	e		i	n	p	u	t



O	p	t	i	o	n	a	l		i	n	p	u	t	:
F	r	o	s	t		i	n	p	u	t				



O	p	t	i	o	n	a	l		i	n	p	u	t	:
S	u	m	m	e	r		i	n	p	u	t			



O	p	t	i	o	n	a	l		i	n	p	u	t	:
									o	f	f	!		

In the next menu, the frequency can be set in the range 0 - maximum frequency. For example:

S	o	m	m	e	r		f	r	e	q	u	e	n	c	y
							1	6	H	z					

When the contact is closed, the term selected appears on the display during operation, together with the current frequency:

F	r	o	s	t		o	p	e	r	a	t	i	o	n
A	c	t	.	f	r	e	q	.	:		1	6	H	z

You can then select the summer function. If a summer circuit has not been ordered, you select:

			S	u	m	m	e	r	-							
			f	u	n	c	t	i	o	n		o	f	f	!	

Otherwise, you set the summer circuit using the sensor supplied:

```
Summer -
switchover
```

```
Summerswitch
Temperaturecomp.
```

```
Summerswitch
Enthalpycompare
```

If „summer operation off“ or „summer enthalpy comparison“ is selected, the „switching point“ menu appears following confirmation with the Enter button (↵). If „summer circuit“ or „summer temperature comparison“ is selected and confirmed using the Enter button (↵) the following appears:

```
Nom. freq.:
25°C.
```

The temperature set activates summer operation and can be adjusted in 1°C steps in the range between 18-42°C. When the reference temperature has been selected and confirmed with the Enter button (↵) the following menu appears:

```
Switchpoint:
50%
```

This is used to set the switching point of the sequential relay as a percentage of the max. frequency.

Continuation of menu description on page 17.

## Definition of terms

### Summer operation

Your rotational heat exchanger can, of course, not only be used for heat recovery, but also as a „cooler“. If the exhaust air is colder than the external air in summer, the rotor can save valuable cooling power if it runs at maximum speed and pre-cools the external air.

The KR 15 can check the summer conditions itself. Various versions are available for summer operation:

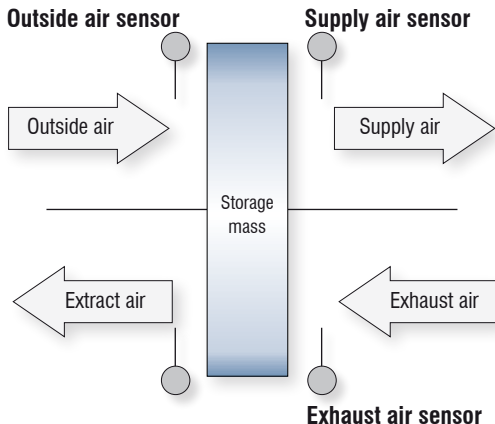

## Enthalpy comparison switch

If the external air enthalpy is higher than the exhaust air enthalpy, the rotor can use the exhaust air to cool the incoming external air. Two enthalpy sensors are required for the enthalpy comparison circuit.

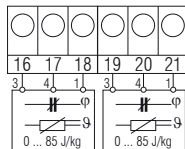

External air  
enthalpy sensor

Exhaust air  
enthalpy sensor

## Temperature comparison circuit

If the exhaust air is colder than the external air, the rotor can use it to cool the incoming external air. Two temperature sensors are required for the temperature comparison circuit:

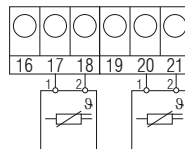

External air  
sensor  
PT 1000

Exhaust air  
sensor  
PT 1000

## Temperature changeover

When a pre-determined external air temperature is exceeded, the rotor switches to cooling. For the summer circuit, a temperature sensor is required that measures the external temperature. A „❄️“ on the display indicates that summer operation has been activated.

Nom. freq. :	80 Hz *
Act. freq. :	80 Hz

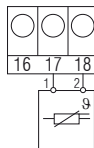

External air sensor  
PT 1000

## Supply air temperature regulation

The supply air temperature required can be set between 0°C - 40°C. The active ThermaGard MWTM temperature sensor is required to determine the supply air temperature. The Premium control unit can regulate the supply air temperature required through the PI control.

The display during supply air temperature regulation (sample display):

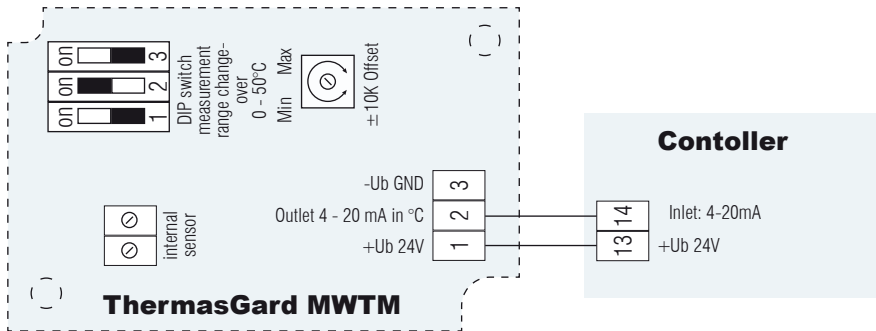
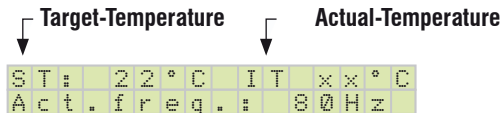

## Sequential circuit

The sequential circuit has a potential-free changeover contact. As a result, a heating register can be fitted downstream, for example. The changeover point can be set between 5% and 100% of the maximum speed in 5% steps. A „#“ in the centre of the display indicates that the sequential switch has been activated. When the sequential relay is activated, contacts 39 and 41 are closed.

S	o	l	l	f	r	e	q	.	:	8	0	H	z	#
A	ct	.	f	r	e	q	.	:	8	0	H	z		

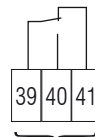

Sequential circuit

## Summer operation

Summer operation can be selected by means of a relay and is indicated by a „\*“ . Contacts 36 / 38 are then connected.

N	o	m	.	f	r	e	q	.	:	8	0	H	z	*
A	ct	.	f	r	e	q	.	:	8	0	H	z		

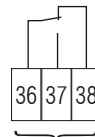

Summer operation

## 0-10 V analogue output

Here there is the option to access the current control signal in analogue form and to display it through the GLT (PLC) or to connect an external rev counter.



+ GND  
U<sub>a</sub>



## Continuation of the menu description from page 11

The following then appears:

			C	l	e	a	n	i	n	g				
a	k	t	i	v	e		2	0		M	i	n		

bzw.

			C	l	e	a	n	i	n	g				
						o	f	f	!					

The default value for cleaning mode is pre-set to 20 mins.

It is essential that the control unit release is set throughout the operating period of the ventilation system and that it is controlled exclusively by means of the control signal or the keyboard. The cleaning mode ensures that the rotor moves at regular intervals by about half a revolution if no demands are made of it through the control signal or keyboard for more than 20 mins.

The cleaning interval can be set to 40, 60, 80 or 100 minutes using the selection button  .

			C	l	e	a	n	i	n	g				
a	k	t	i	v	e		1	0	0		M	i	n	

Confirm by pressing the Enter button ()

The rotation of the rotor can be monitored with the running control.

If you have ordered the control unit with the „Running Control“ option, select:

```
Runcontrol
aktive!
```

else

```
Runcontrol
off!
```

The running control is switched on/off using the selection buttons (▲) (▼), and confirmed using the Enter button (↵). During operation, the running control function is indicated by a black panel (■) (>10Hz).

```
Nom.freq.: 80Hz ■
Act.freq.: 80Hz
```

The running control is not active with frequencies in the range 0-10 Hz.

If the ventilation is unfavourable, air flowing in at an angle can cause unintended operation of the rotating air-to-air heat exchanger. The control unit has a DC brake that builds up a holding torque on the motor when the rotor is at a standstill.

```
DC-Brake off
```



```
DC-Brake on
```

The braking force can be set in % steps and should only be increased until the rotor stops moving.

```
DC-brak. effect
15%
```

In order for the changes entered to take effect, it is necessary to save them.

```
Store Data?
```

Press the Enter button (↵) to save the values.

```
stored!
```

Pressing the selection buttons (▲) (▼) rejects the changes.

```
Not  
stored!
```

The control unit returns to its previous setting.

The following appears on the display in manual operation:



```
HF: 00 Hz IF: 00 Hz
```

Press the Enter button (↵) to start the control unit in manual operation.

The following appears in external operation:



```
SF: 00 Hz IF: 00 Hz
```

If a requirement is made by the control signal, the target frequency is displayed and the control unit goes into operation.

If the following appears instead, for example:

```
Hardware error:
E: 01!
```

check the fault using the list below.

By simultaneously pressing    , the error message is reset.

```
Controller reset!
```

## 6. Troubleshooting table for the KR 15 control unit

(No display visible)

- Test fuse / Check mains voltage

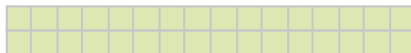

- Control unit not released. **No error message!**

```
Contr. blocked
Act. freq.: 00Hz
```

- Test thermal contact/PTC resistor
- The error message contact is triggered when the overheating fault occurs.
- Connection of thermal contact/PTC resistor to control unit.
- A supply voltage of 24V must be applied to terminals 4, 7 and 9 to ground (terminal 6 or 15). If no voltage is present, check control cable, remove any short circuit.
- Check rotor operation control sensor.

				E	r	r	o	r	!		M	o	t	o	r				
				H	i	g	h		t	e	m	p	e	r	a	t	u	r	e

				E	r	r	o	r	!										
				R	u	n	c	o	n	t	r	o	l		e	r	r	o	r

#### For operation with running control, check:

- distance of proximity switch from rotor
- Connection of proximity switch to the control unit
- that V-belt has not jumped off
- V-belt tension
- check settings

#### Although there is a control signal, the following appears:

N	o	m	.	f	r	e	q	.	:		0	0	H	z
A	c	t	.	f	r	e	q	.	:		0	0	H	z

or

M	a	n	.	f	r	e	q	.	:		0	0	H	z
A	c	t	.	f	r	e	q	.	:		0	0	H	z

- Position of the jumper matches description
- Is there a control signal?
- Connection of the control signal to the control unit (polarity)

#### For operation without running control:

- change programming of control unit  
(see description of Running Control)

- The control unit has been set to manual operation

## 6. Error codes

In addition to a fault in the running control and the motor overheating, the control unit recognises 7 different faults. These faults are indicated by means of a two-digit error code on the display:

```
Hardware error:
E:  xx!
```

01	Overvoltage (motor / rotor blocked, short circuit between U, V, W)
05	Overload (controller / motor overloaded)
09	Mains under voltage
14	Earth fault
15	Mains overvoltage
21	Overtemperature in the power amplifier, environmental temperature too high, controller overloaded
99	Software error

The control unit is ready for operation again when the fault has been rectified and the error has been acknowledged by disconnecting the mains voltage or pressing the three buttons simultaneously.

**Attention!** A restart mode integrated into the software means that the control unit does not report an error immediately in the event of overvoltage, undervoltage and overcurrent, but attempts to reset itself within

10 minutes. If it is reset within 10 mins., the control unit continues to work in normal mode. If the KR Premium is unable to reset itself as a result of a longer fault, the error message is triggered through the error message output after 10 mins. and the error code appears on the control unit display.

**Warning!** This function brings about an automatic restart of the frequency inverter and thus of the drive in the event of a fault, once the set waiting period has passed - if there is still a start command present. It must be ensured that no one is put in danger in the event of a restart.

## Troubleshooting table for sensor operation

The following troubleshooting table should also be considered when the sensor is in operation:

Type of fault	Checks:
No supply air temperature regulation	Check sensor, connection and programming
No enthalpy comparison	10 volts of DC voltage must be applied to terminals 16 and 19 against terminal 18
No summer operation	Check programming and connection

If you have any questions about the control unit or its components, please always specify the device type and serial number of the rotary heat exchanger.

## 7. Safety and precautions

Before installation and initial operation of the frequency converter, please read through the product handbook carefully and observe all warnings and safety precautions. Make sure that the product manual is easily reachable in the area of the frequency converter.

### Definition of tips:

**Warning!** Failure to comply with this information could cause death, severe bodily injury or significant physical damage.

**Caution!** Failure to comply with this information could cause minor bodily injury or physical damage.

**General:** During operation it must be ensured that the mains voltage is constantly on.

### Warning!

- This frequency converter creates dangerous electrical voltage and controls dangerous rotating parts. Failure to comply with the information in this manual could cause death, severe bodily injury or significant physical damage.
- The installation, initial operation and maintenance of this drive may only be performed by expert staff that are well versed in the functionality and equipment as well as the machine.
- The device contains intermediate circuit capacitors that also carry out switchover of dangerously high voltages on the grid side. After switching off the voltage, wait at least 15 minutes before opening the device and working on it. Please be sure that no live parts are touched.
- The ground fault safety serves only as protection for the frequency converter and not as personal protection. In accordance with VDE 0160 (German abbreviation for the Association for Electrical, Electronic & Information Technologies), the three-phase frequency converter must not be operated on a leakage current circuit breaker, because a possible direct current component will reduce the sensitivity of the leakage current circuit breaker in the event of a fault.
- The provisions of VDE 0160 should be observed as protective measures.
- Ground the frequency converter to the connection provided for it.
- To avoid injury and damage, do not touch any parts within the housing – not with hands or any kind of object – when mains voltage is present or the intermediate circuit capacitor is not loaded. Do not work on wiring or test signals when mains voltage is present.



- Pay special attention when the automatic restart is activated. To avoid injury from possible uncontrolled restart of the frequency converter after a power outage, install a switch element on the grid side that de-energises in a power outage and can only be turned on after return of voltage by manual confirmation (e.g., contactor, etc.).
- Ensure that the input voltage corresponds with the voltage listed on the label. Environmental influences such as high temperature and high humidity are to be avoided as well as dust, dirt and aggressive gases.
- The install location should be a well-ventilated location away from direct sunlight. Install the device on a non-flammable, vertical wall that does not transmit vibrations. Do not connect mains voltage to the output terminals U/T1, V/T2, W/T3.
- Please contact the motor or machine manufacturer if standard motors with a frequency of  $> 60$  Hz will be operated.
- All frequency converters are tested for dielectric strength and insulation resistance measurements. Insulation resistance measurements, for example, in the course of inspection, must not be conducted between the power terminals and earth. Do not carry out insulation resistance measurements on the control terminals.
- During operation it must be ensured that the mains voltage is constantly on. Control commands and operating signals (such as start/stop) must only be implemented via the control terminals or the control panel and not by switching the mains supply or a motor contactor.
- Do not install capacitors or overvoltage arrestors in the motor lead.

### **Caution!**

- In order to guarantee that your Klingenburg frequency converter operates securely and reliably, all respective safety regulations, such as accident prevention regulations, VDE regulations, etc., must be observed.
- As these regulations could contain different details within the German speaking areas, the user must observe the requirements that are valid for their area.
- Klingenburg GmbH cannot exonerate the user from the obligation to follow the most current safety regulations. The technical data and descriptions in these operating instructions are compiled according to the best of our knowledge and belief. Product improvements are constantly performed. For this reason, Klingenburg GmbH reserves the right to make such changes without prior notice.
- Despite the careful creation of these instructions, Klingenburg GmbH cannot be held liable for errors or damage which arise from use of this manual.

**You can enter the values you have set here:**

Mode of operation						
Manual set point						
Starting point						
Min. frequency						
Max. frequency						
Priority input						
Cleaning mode						
Running control						
DC brake						
Braking torque						
Supply air temp. [°C]						
P factor						
I time						



Klingenburg GmbH  
Boystraße 115  
D-45968 Gladbeck, Germany

Tel.: +49-20 43-96 36-0  
Fax: +49-20 43-7 23 62  
E-mail: [klingenburg@klingenburg.de](mailto:klingenburg@klingenburg.de)  
[www.klingenburg.de](http://www.klingenburg.de)