

ENG Weather compensated controller for mixing heating circuits

DEU Witterungsgeführte Heizungsregler des Mischerheizkreises

ITA Regolatore climatico per circuiti di riscaldamento miscelati

FRE Régulateur de vanne mélangeuse pour circuits de chauffage

PROMATIC CMP25-2



**Weather compensated controller for mixing heating circuits
PROMATIC CMP25-2**

ENG

**Witterungsgeführte Heizungsregler des Mischerheizkreises
PROMATIC CMP25-2**

DEU

**Weersafhankelijke regelaar voor mengverwarmingscircuits
PROMATIC CMP25-2**

DUT

**Régulateur de vanne mélangeuse pour circuits de chauffage
PROMATIC CMP25-2**

FRE

Weather compensated controller for mixing heating circuits

PROMATIC CMP25-2

ENG



INTRODUCTION

PROMATIC CMP25-2 controller is a modern designed, microprocessor-driven device made with digital and SMT technology.

It is intended to control mixing heating circuit with radiator or surface heating systems. CMP25-2 features multi-channel program timer for time-dependent room heating.

CMP25-2 controllers can be connected to network and operate as uniform control system for multi heating circuits.



For initial setup see **Initial controller setup**, page 9!

CONTENTS

USER MANUAL

CONTROLLER DESCRIPTION	8
Controller appearance	8
Operation mode indication	8
INITIAL SETUP OF CONTROLLER	9
Procedure of initial setup	9
MAIN DISPLAY AND NAVIGATION	11
Main display description and design	11
Description of symbols shown on display	11
Symbols for operation mode	11
Symbols for user functions	12
Symbols for temperature and data overview	12
Symbols for protection functions	13
Symbols for communication of controllers in network	13
Symbols for notice and warnings	13
Basic screen navigation	14
Locking / unlocking the screen	14
Display for help, notices and warnings	15
ENTRY AND NAVIGATION THROUGH THE MENU	16
Menu structure and description	17
Temperature settings	20
User functions	21
Operation mode	22
Time programs	23
Basic settings	26
Data Overview	27

SERVICE SETTINGS MANUAL

SERVICE SETTINGS	28
Basic parameters	28
Heat curve	30
Service parameters	32
Floor drying parameters	35
Factory settings	36

INSTALLATION MANUAL

CONTROLLER INSTALLATION	37
Installation onto mixing valve	37
Controller's electric connection.....	39
Connection of mains.....	39
Connection of sensors, room units and BUS.....	39
Connection of digital room unit DD2+	40
Connection of room sensor	40
Marking and installation of temperature sensors	41
Operation mode by sensor failure	42
Expanding the system on multiple heating circuits	42
HYDRAULIC AND ELECTRIC SCHEMES	44
TECHNICAL DATA.....	47
DECLARATIONS AND STATEMENTS	48
Conformity with standards and directives	48
Disposal of old electrical & electric equipment	48

USER AND SETTINGS MANUAL

ENG

CONTROLLER DESCRIPTION

CONTROLLER APPEARANCE



- ① Graphic display with touch panel.
- ② Button  - Esc, Help.

OPERATION MODE INDICATION



Illuminated button:
green - closing of mixing valve
red - opening of mixing valve

INITIAL SETUP OF CONTROLLER

Controller PROMATIC CMP25-2 is equipped with innovative solution “EASY START” for easy setup with the help of setup wizard.

PROCEDURE OF INITIAL SETUP

CMP25-2 V1.0r0

When you connect the controller to the power supply for the first time or by reset, the software version is shown. Next, the setup wizard runs.

STEP 1 - DISPLAY ORIENTATION

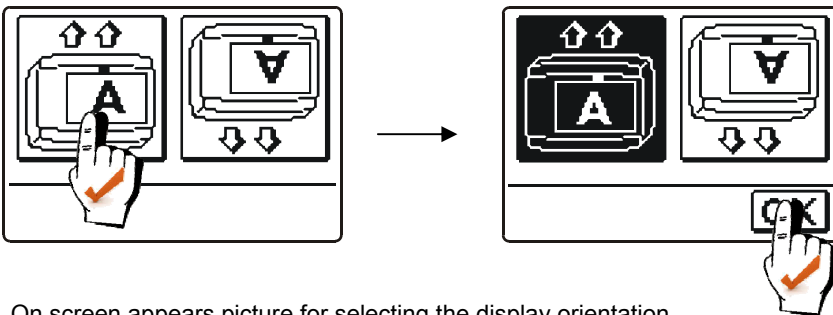

On screen appears picture for selecting the display orientation. Press icon where letter **A** is normally readable.

After selecting proper display orientation, press button **OK** to confirm your selection.

STEP 2 - OPENING OF THE MIXING VALVE

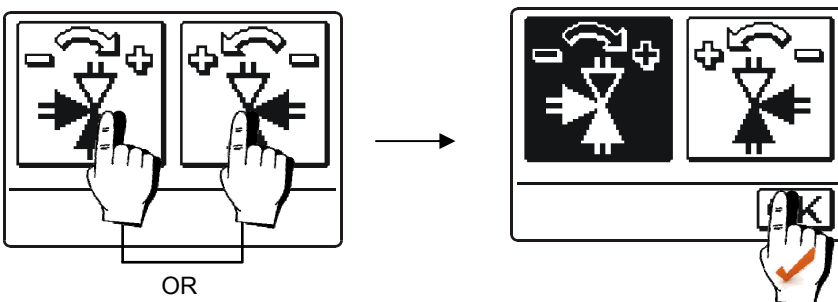

OR

Press icon which indicates the proper direction (**+**) of mixing valve opening.

After selecting proper valve opening direction, press button **OK** to confirm your selection.

STEP 3 - LANGUAGE SELECTION

ENG

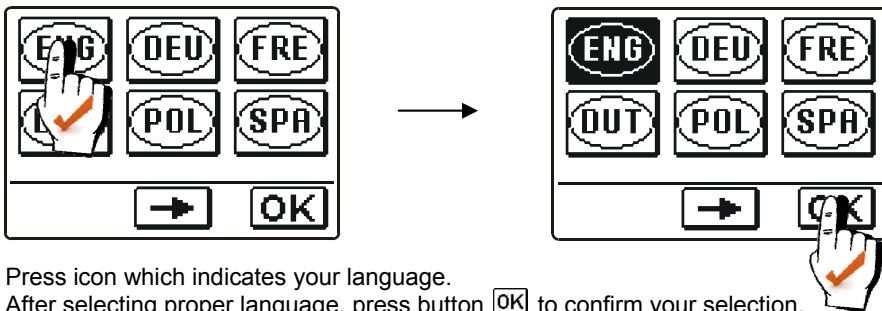

Press icon which indicates your language.
After selecting proper language, press button **OK** to confirm your selection.

STEP 4 - HYDRAULIC SCHEME

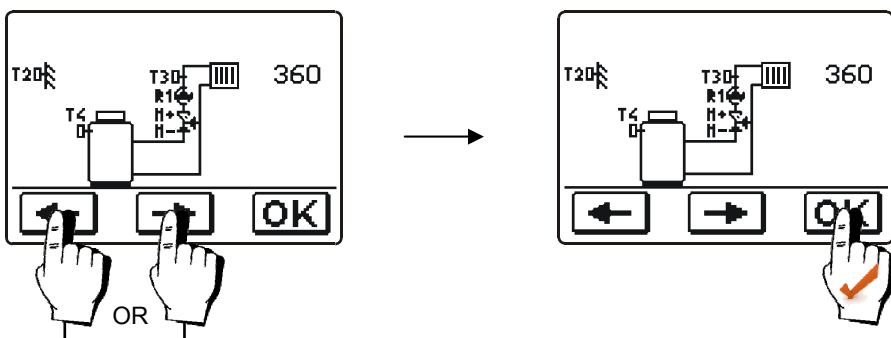

Select scheme for controller operation.
Confirm your selection with button **OK**.

STEP 5 - HEAT CURVE STEEPNESS

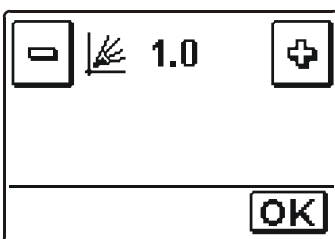

Press buttons **-** and **+** to set requested heat curve steepness. Confirm your selection with button **OK**.

Heat curve steepness is detailed described on pages 30 and 31.



Selected hydraulic scheme, screen orientation direction, rotation direction and language can be at any time changed in service settings or with reset of controller!



RESET

*Switch off power supply of the controller. Hold button **⏻** and switch on power supply. Controller resets and runs initial setup.*

MAIN DISPLAY AND NAVIGATION

All important data of controller operation are shown on the graphic LCD display which is intended also for setting the controller.

DISPLAY DESCRIPTION AND DESIGN

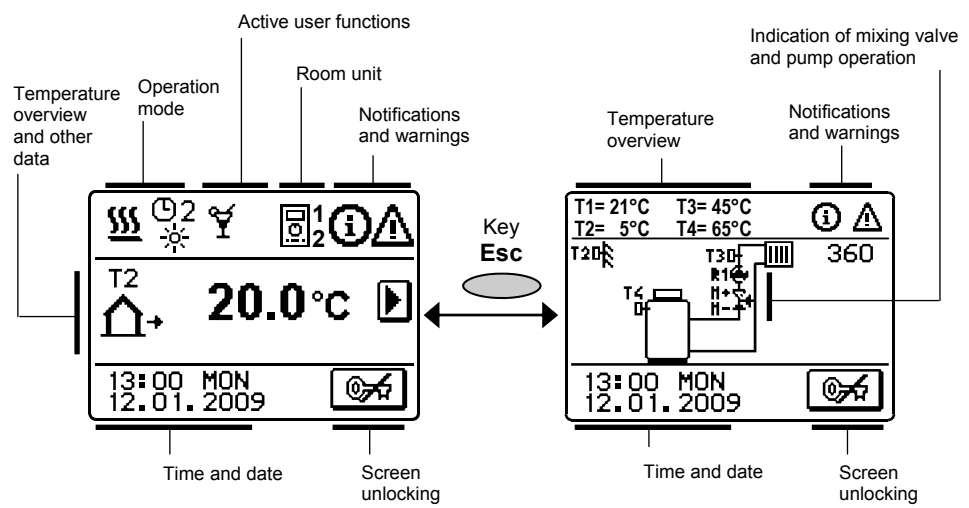









DESCRIPTION OF SYMBOLS SHOWN ON THE DISPLAY

SYMBOLS FOR OPERATION MODE











Symbol	Description
	Heating mode
	Cooling mode
	Room heating according to program timer - day temperature
	Room heating according to program timer - night temperature
	Heating according to the set-point day temperature
	Heating according to the set-point night temperature
	Switch off
	Manual operation

SYMBOLS FOR USER FUNCTIONS



ENG

Symbol	Description
	Party
	Eco
	Holiday
	Floor drying is active 01/ - day of drying 25 - drying duration (days)
	Automatic switchover to summer mode
	Heating with constant stand pipe temperature is active
	Remote activation
	Boost heating







SYMBOLS FOR TEMPERATURE AND DATA OVERVIEW

Symbol	Description
	Measured temperature
	Calculated or set-point temperature
	Indoor (Room) temperature
	Outdoor temperature
	Stand-pipe temperature
	Return-pipe temperature
	Boiler temperature
	Mixing valve - closing (flashing indicates trend for closing)
	Mixing valve - opening (flashing indicates trend for opening)
	Circulation pump
T1, T2, T3, T4 TR TA TQ	Temperature measured on sensor T1, T2, T3 or T4. Temperature measured on room unit DD2+. Outdoor temperature, acquired t BUS connection. Boiler temperature, acquired from BUS connection.



SYMBOLS FOR PROTECTION FUNCTIONS

Symbol	Description
	Liquid fuel boiler overheating protection
	Frost (indoor) protection

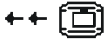







SYMBOLS FOR COMMUNICATION OF CONTROLLERS IN NETWORK

Symbol	Description
	Devices, connected to the communication line COM1
	First (1) or second (2) room unit DD2+ is connected
	Rank of controller and BUS connection COM1/COM2
	Independent controller - not connected to bus
	First controller in bus connection
	Intermediate controller in bus connection
	Last controller in bus connection

SYMBOLS FOR NOTICE AND WARNINGS

Symbol	Description
	<p>Notice</p> <p>In case of exceeding the maximum temperature or activation of protection function, the controller indicates the event with flashing symbol on the display. If the maximum temperature is no longer exceeded or if the protection function is turned off, a lited symbol indicates a recent event.</p> <p>Press HELP to open the screen to check notifications.</p>
	<p>Warning</p> <p>In the event of sensor failure, bus or com connection error, the controller indicates the failure with flashing symbol on the display. If the issue is resolved or no longer present, a lited symbol indicates a recent event.</p> <p>Press HELP to open the screen for warnings.</p>

BASIC SCREEN NAVIGATION



Button	Function of button
	Screen unlocking / locking
	Help
	Menu entrance
	Move to next data
	Move forward / backward in menu or data
	Increasing / decreasing the data value
	Confirmation
	Confirmation and return to the previous menu or selection

LOCKING/UNLOCKING THE DISPLAY

If you want to change the controller settings or overview the operation data. Press the button  to unlock the screen.

The screen is automatically locked 60 s after the last key is pressed.

DISPLAY FOR HELP, NOTICES AND WARNINGS

First unlock the screen by pressing the button . Press button  to open the screen for help, notices and warnings is opened.

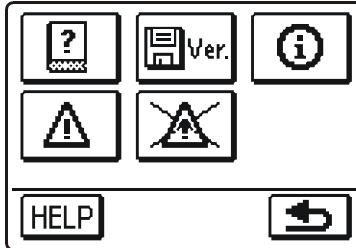

Available possibilities:



Short manual

Short manual for use of the controller.





Controller version

Overview of controller type and software version.



Notices

List of exceeding the maximum temperatures and activated protection functions. By pressing the buttons  and  move through the list of notifications. Press  to exit the list.



Warnings

The list of sensors failures and other components.

By pressing the buttons  and  move through the list of warnings. Press  to exit the list.



Delete warnings

By pressing this button all sensors that are not connected will be deleted from the list of failures.

Note: Failures of sensors that are required for controller operation can not be deleted.

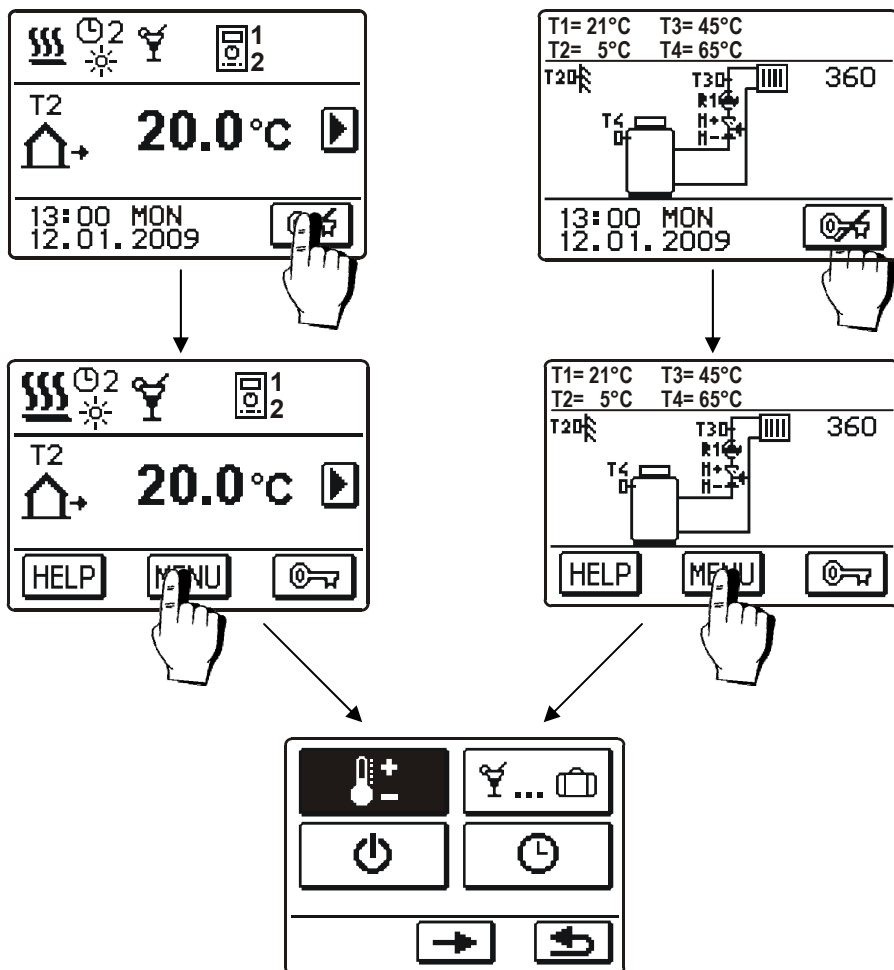

ENTRY AND NAVIGATION THROUGH THE MENU

To unlock the screen press button . To enter the menu press button .



To move around the menu, press icons displayed on the screen.



If menu features more than one full screen of selections, press button  to move on the next screen or button  to move to the previous screen.

MENU STRUCTURE AND DESCRIPTION



TEMPERATURE SETTINGS



Day temperature



Night temperature



USER FUNCTIONS



Party



Eco



Holiday



Deactivation of function



OPERATION MODE



Time program operation mode



Day temperature operation mode



Night temperature operation mode



Switch OFF



Heating or cooling operation mode selector



Manual operation mode



TIME PROGRAMS



Time program 1



Time program 2



Time program 3



Time program 4

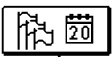

BASIC SETTINGS



User language



Time and date



DISPLAY SETTINGS



Duration of active display illumination and menu autoexit



Intensity of active display illumination



Intensity of inactive display illumination



Contrast



DATA OVERVIEW

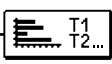

Diagrams of measured temperatures for last week

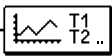

Diagrams of measured temperatures for last day



Special service data



CONTROLLER PARAMETERS



P1 Basic settings



P2 Settings for heating circuit

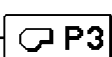

P3 Settings for heat source

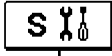

SERVICE PARAMETERS



S1 Basic settings



S2 Settings for heating circuit

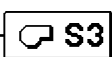

S3 Settings for heat source



FACTORY SETTINGS



Reset of all controller parameters



Reset of time programs



Reset of all controller settings and restart of initial setup



Save user settings



Load user settings







TEMPERATURE SETTINGS

ENG

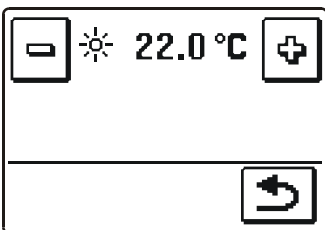

Day temperature





Use buttons  and  to set the temperature.
Confirm and return to the previous screen by pressing button .

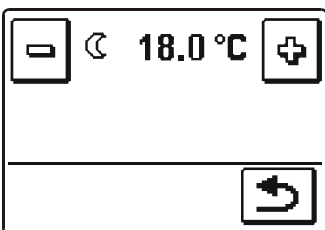

Night temperature



Use buttons  and  to set the temperature.
Confirm and return to the previous screen by pressing button .

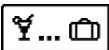

USER FUNCTIONS

User functions provide additional comfort and benefits by use of the controller. Following user functions are available in the menu:



PARTY

Press icon **PARTY** to activate comfort temperature operation mode. To adjust function press the PARTY icon once again. A new screen opens.

Use buttons and to set the temperature and time when the function will finish.

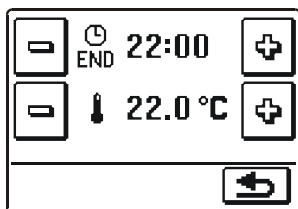

Setting of time, when the function will finish

Temperature setting



ECO

Press icon **ECO** to activate economic temperature operation mode. To adjust function press the ECO icon once again. A new screen opens.

Use buttons and to set the temperature and time when the function will finish.

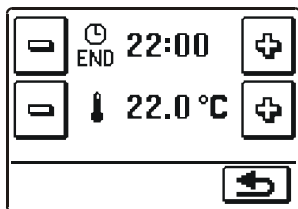

Setting of time, when the function will finish

Temperature setting



HOLIDAY

Press icon **HOLIDAY** to activate comfort temperature operation mode to selected date. To adjust function press the HOLIDAY icon once again. A new screen opens.

Use buttons and to set the temperature and date when the function will finish.

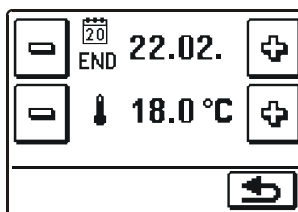

Setting of date, when the function will finish

Temperature setting

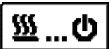



OPERATION MODE

Six operation modes are available:



Operation according to time program

Operation takes course according to selected time program. If a room unit is connected, icon  is displayed (number indicates room which unit controls the heating circuit). If the controller operates without room unit control, icon  is displayed.



Operation according to day temperature

Controller operates in day temperature mode



Operation according to night temperature

Controller operates in night temperature mode



Switch-off

Select this function to switch off the controller. Active remains frost protection when heating and overheating protection when cooling.



Heating or cooling operation mode selector



Cooling control is thermostatic according to the required room temperature and a constant stand pipe temperature.



For cooling operation mode it is necessary to connect a room sensor or room unit. System for cold water supply needs to be activated.



Manual mode

This mode is used for testing the system or in case of malfunction.

A new screen opens where mixing valve can be manual opened or closed and circulation pump can be switched on or off.

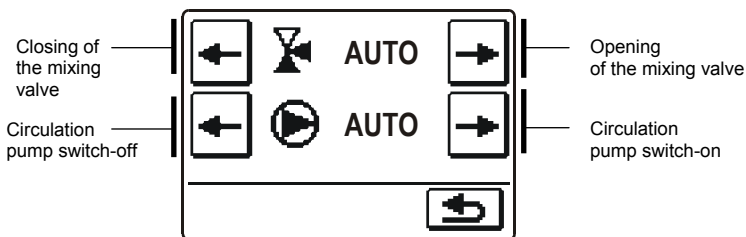



Press button  to confirm and exit to the previous screen.

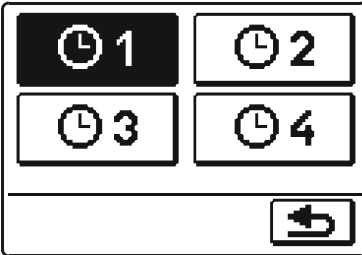

Time program selection

Four independent time programs are available.





When the required time program is selected, press button  to confirm and return to the previous screen.

TIME PROGRAM copying and editing

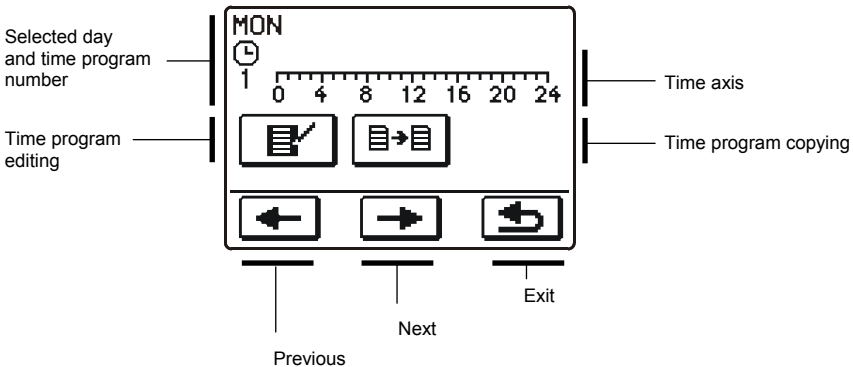
If we press on already selected time program icon a new screen opens.







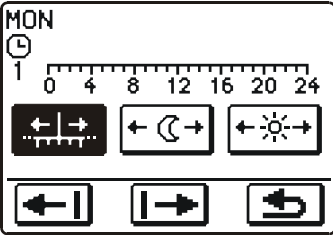

First, by pressing buttons  and  select the day whose program course you want to edit or copy it to other days.

 **Time program editing**



Icons on screen have the following meaning:



- | | | | |
|--|---|---|--|
|  | Free cursor movement. |  | Move to left. |
|  | Night temperature interval / erase of day temperature interval. |  | Move to right. |
|  | Day temperature interval / erase of night temperature interval. |  | Save time program changes and return to the previous screen. |

With the help of above listed icons we draw requested course of time program.

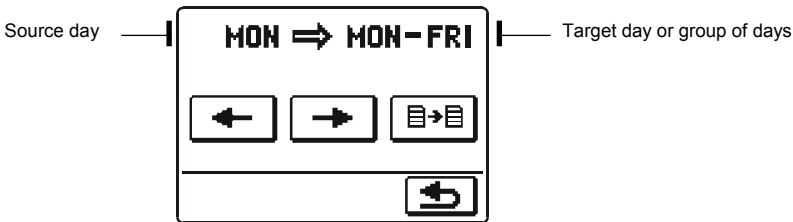
 **The time program copying**



Icons on screen have the following meaning:

- | | | |
|---|---|---|
|  |  | Selection of day or more days together (MON, TUE, WEN, THU, FRI, SAT, SUN, MON-FRI, MON-SUN, SAT-SUN) in which you want to copy the time program. |
|  | Copying | |

Factory time program settings

⌚ 1

Day	Day temperature period
MON - FRI	06:00 - 22:00
SAT - SUN	07:00 - 22:00

⌚ 2

Day	Day temperature period
MON - FRI	05:00 - 7:30 13:30 - 22:00
SAT - SUN	07:00 - 22:00

⌚ 3

Day	Day temperature period
MON - FRI	06:00 - 08:30 11:00 - 13:30 16:00 - 22:00
SAT - SUN	07:00 - 22:00

⌚ 4

Day	Day temperature period
MON - FRI	14:00 - 22:00
SAT - SUN	07:00 - 22:00



BASIC SETTINGS

ENG

This Menu is intended for user language, time, date and display settings.



Language

Screen for language selection is opened:

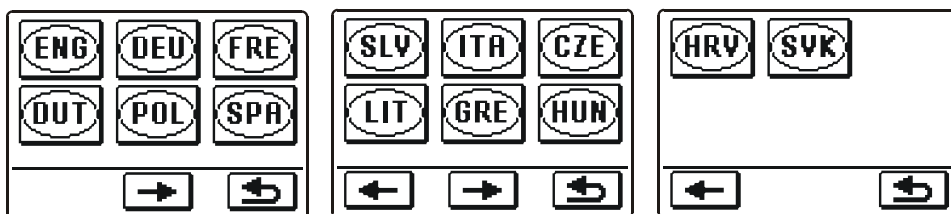

Use buttons and to move between language selection screens.

Select language you wish to use by pressing the icon. Confirm your selection and exit to the previous screen by pressing button



Time and date

Screen for time and date setting is opened:

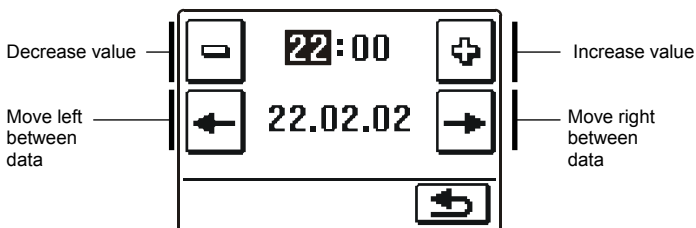

Confirm your setting and exit to the previous screen by pressing button



Display settings

There are four settings available:

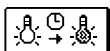

Time of active illumination and menu-autoexit

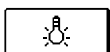



Intensity of active illumination



Intensity of inactive illumination



Contrast

Change each particular setting with buttons  and . Confirm your setting and exit to the previous screen by pressing button .

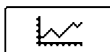

DATA OVERVIEW

In the Menu there are icons to access the following information about controller operation:



DIAGRAMS OF MEASURED TEMPERATURES FOR LAST WEEK

Graphical representation of temperatures for each sensor, by days. Temperatures are recorded for the last week of operation.



DIAGRAMS OF MEASURED TEMPERATURES FOR LAST DAY



Detailed graphical representation of temperatures of sensors for current day. The frequency of records is set by parameter P1.7. Such temperature display is used primarily for the analysis of the heating system at startup, service or in case of failure.



SPECIAL SERVICE DATA.

Diagnostic data for service department.



Between the graphs of individual sensors you can move with the key . Use keys  and  to move between days.

SERVICE SETTINGS MANUAL

ENG

CONTROLLER PARAMETERS

All additional settings and adjustments of controller performance are carried out by means of parameters. Three groups of parameters are available.

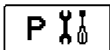

Basic parameters

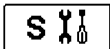

Service parameters

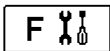

Floor drying parameters



Only those parameters that are used in the selected hydraulic scheme are visible. From the selected hydraulic schemes depend also the factory setting values of parameters.

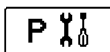

BASIC PARAMETERS

The basic parameters are listed in groups **P1** - basic settings, **P2** - settings for heating circuit, **P3** - settings for heat sources.

Content of basic parameters is displayed as follows:

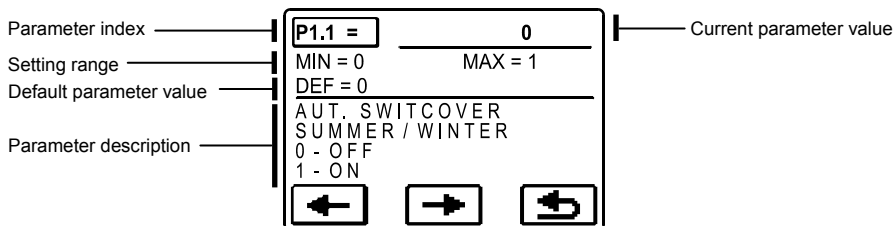

The desired parameter change is shown in the example below, for parameter P1.1.

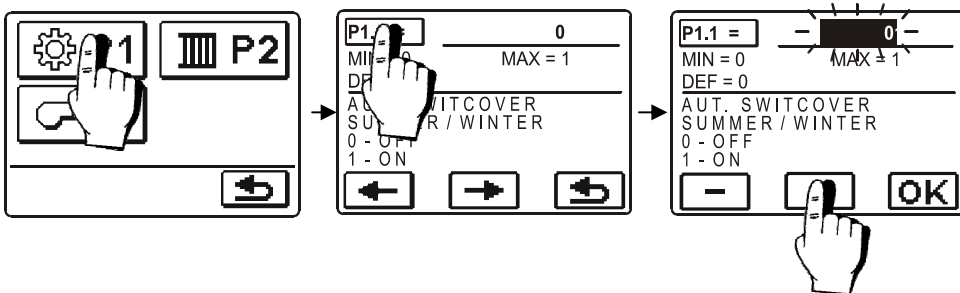

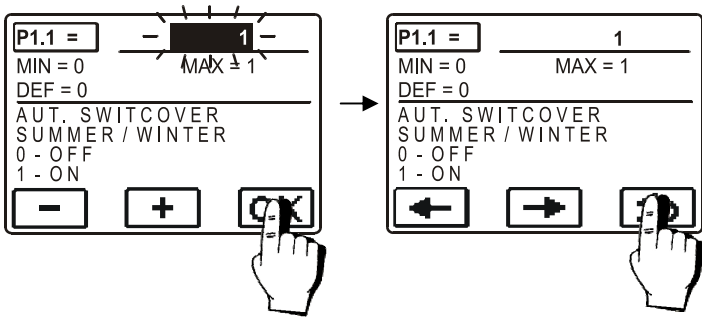

P1

Basic settings :

Parameter	Function	Parameter description	Setting range	Default value
P1.1	AUT. SWITCHOVER SUMMER/WINTER	Automatic switch-off of heating in accordance to average one-day outdoor temperature.	0- NO 1- YES	0
P1.2	AVERAGE OUTDOOR TEMP. FOR SUMMER/WINTER SWITCHOVER	Setting of average one-day outdoor temperature at which the heating should switch-off.	10 ÷ 30 °C	18
P1.4	REQUESTED ROOM TEMPERAT. BY FROST PROTECTION	Setting of room temperature when heating is switched off.	2 ÷ 12	6
P1.5	TEMPERATURE ROUND UP	You set the accuracy of displayed temperatures.	0- 0.1 °C 1- 0.2 °C 2- 0.5 °C 3- 1 °C	2
P1.6	AUT. SHIFT OF CLOCK TO SUMMER/WINTER TIME	With the help of a calendar, the controller carries out the automatic changeover between summer and winter time.	0- NO 1- YES	1
P1.7	PERIOD OF TEMPERAT. LOGGING (MINUTES)	By setting this field you define how often the measured temperatures are saved.	1 ÷ 30 min	5
P1.8	TONES	By setting this field you define sound signals of the controller.	0- OFF 1- KEYPAD	1
P1.9	ADVANCED TEMPERATURE SCREEN	Advanced screen means that while checking temperatures you can see measured and required or calculated temperature.	0- NO 1- YES	1

P2

Settings for heating circuit :

Parameter	Function	Parameter description	Setting range	Default value
P2.1	HEAT CURVE STEEPNESS	Heating curve steepness tells us, what temperature is required for the heating bodies by a determined outdoor temperature. The steepness setting depends on the type of heating system (floor, wall, radiator, convector heating) and insulation of the building.	0,2 ÷ 2,2	0,7 - floor 1,0 - radiators

Settings for heating circuit :

Parameter	Function	Parameter description	Setting range	Default value
P2.2	PARALLEL SHIFT OF HEATING CURVE	Parallel shift of heating curve (calculated stand pipe temperature). <i>Use this setting to eliminate deviation between actual and set-point room temperature.</i>	-15 ÷ 15 K	0
P2.3	DURATION OF BOOST HEATING	Duration of boosted room temperature by changeover from night to day heating period.	0 ÷ 200 min	0
P2.4	ROOM TEMPERATURE INCREASE BY BOOST HEATING	Setting of boost temperature by changeover from night to day heating period.	0 ÷ 8 K	4
P2.5	PRIORITY OF D. H. W. WARMING	Setting if d. h. w. warming has priority to room heating.	0- NO 1- YES	0

Settings for heat source :

Parameter	Function	Parameter description	Setting range	Default value
P3.1	MINIMUM BOILER TEMPERATURE	Setting of minimal boiler temperature.	10 ÷ 90 °C	40

HEAT CURVE

Heating curve steepness tells us, what temperature is required for the heating bodies by a determined outdoor temperature. The steepness setting depends on the type of heating system (floor, wall, radiator, convector heating) and insulation of the building.

Adjusting the heating curve steepness

If you have enough data, you can determine the heating curve steepness with a calculation, otherwise from experience, based from the evaluation of heating system dimensioning and building insulation.

The steepness is set correct, if the room temperature remains stable, even by large outdoor temperature changes.

Until the outdoor temperature remains above + 5 °C, you can adjust the room temperature with changing day or night temperature or with parallel shift of the heating curve.

If it gets colder in the building, while the outdoor temperature is dropping, then the heat curve steepness is set too low - you should increase the setting.

If the object by low outdoor temperatures gets warmer, the heat curve steepness needs to be decreased.

The maximum steepness increase/decrease should not be greater than 0,1 to 0,2 units at one observation. At least 24 hours must expire between two observations.

Preferred settings of the heating curve steepness:

Heating system:	Setting range:
floor heating	0,2 - 0,8
wall heating	0,6 - 1,0
radiator heating	0,8 - 1,4



With adjusting the heat curve steepness, the controller is tuned with the building. For optimal controller operation, the right setting of the heat curve steepness is very important.

Diagram of heat curves

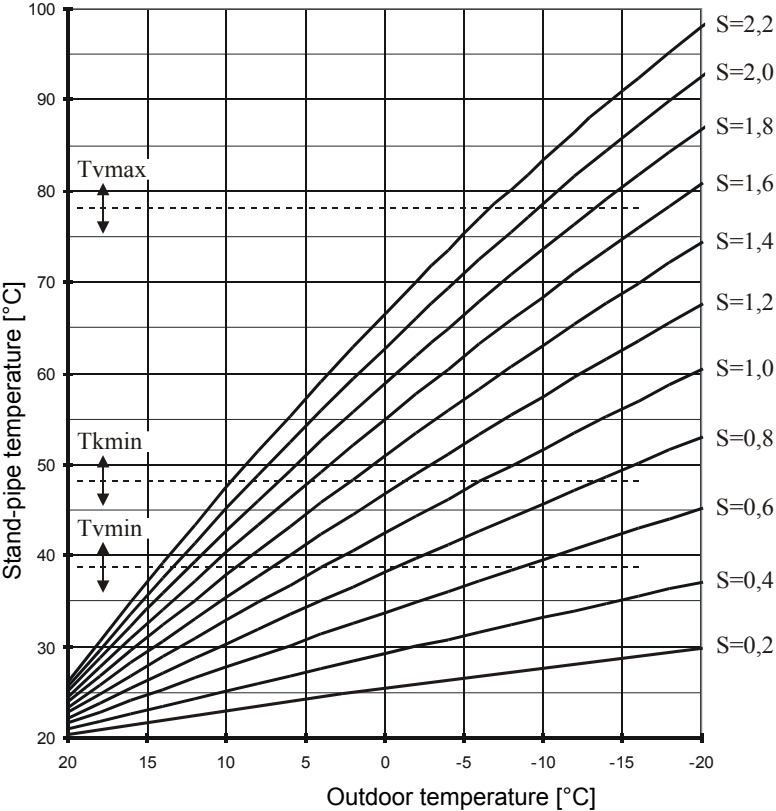



SERVICE PARAMETERS

ENG

Service parameters are classified into groups **S1** - basic settings, **S2** - settings for heating circuit, **S3** - settings for heat source.

The contents of service parameters are displayed as follows:

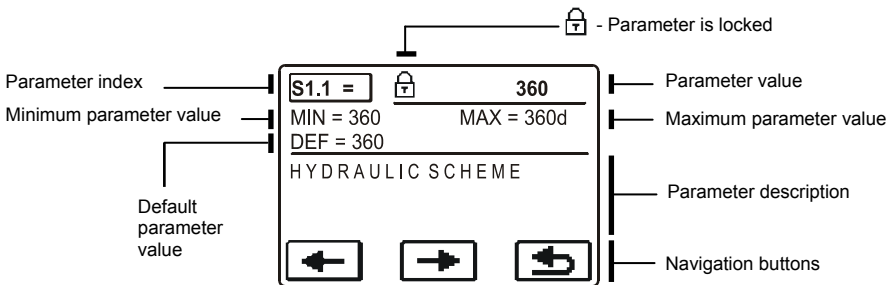

The desired parameter is changed in the same way as the basic parameters P. Service parameters are locked and must be unlocked before editing.

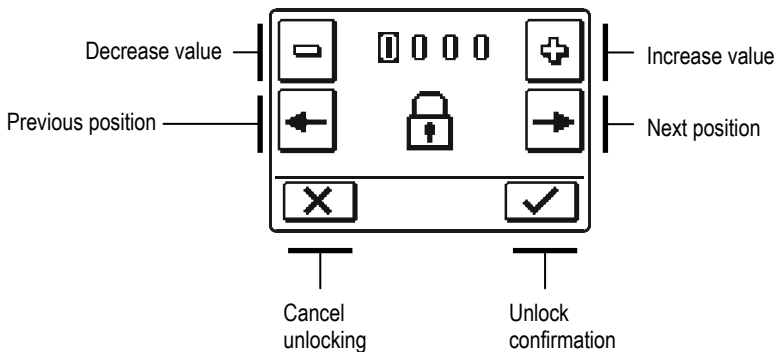

The default unlock code for service parameters is 0001.

Basic settings



Parameter	Function	Parameter description	Setting range	Default value
S1.1	HYDRAULIC SCHEME	Selection of hydraulic scheme.	360 ÷ 360d	360
S1.2	CODE FOR UNLOCKING THE SERVICE SETTINGS	This setting enables the change of code which is necessary to unlock the service settings. WARNING! Keep new code on a safe place. Without this code is impossible to change service settings.	0000 ÷ 9999	0001
S1.3	TEMPERATURE SENSOR TYPE	Selection of temperature sensors Pt1000 or KTY10.	0 - PT1000 1 - KTY10	0
S1.4	ACTUATOR OPENING DIRECTION	Setting of actuator turning direction - valve opening.	0- RIGHT 1- LEFT	0
S1.5	DISPLAY ORIENTATION	Setting of display orientation.	0 - REGULAR 0° 1 - ROTATED 180°	0
S1.6	SELECTION OF SENSOR T1 FUNCTION	Set the operation mode for sensor T1. If return pipe sensor is selected, a limitation of temperature difference between stand and return pipe needs to be set with parameter S2.13.	0- ROOM SENSOR 1- RETURN PIPE SENSOR	0
S1.7	SELECTION OF SENSOR T4 FUNCTION	Set the operation mode for sensor T4. If return pipe sensor is selected, a limitation of temperature difference between stand and return pipe needs to be set with parameter S2.13.	0- BOILER SENSOR 1- RETURN PIPE SENSOR	0
S1.8	REMOTE ACTIVATION VIA BUS	Selection if remote activation can be activated only local or also from master controller.	1- LOCALY 2- FROM MASTER	1
S1.9	ANTI-BLOCK FUNCTION FOR PUMP AND VALVE	All outputs that haven't been activated in the last week are activated on Friday at 20:00 for 60 seconds.	0- OFF 1- ON	0
S1.17	SENSOR T1 CALIBRATION	Correction of displayed measured temperature for sensor T1.	-5 ÷ 5 K	0
S1.18	SENSOR T2 CALIBRATION	Correction of displayed measured temperature for sensor T2.	-5 ÷ 5 K	0
S1.19	SENSOR T3 CALIBRATION	Correction of displayed measured temperature for sensor T3.	-5 ÷ 5 K	0
S1.20	SENSOR T4 CALIBRATION	Correction of displayed measured temperature for sensor T4.	-5 ÷ 5 K	0



Settings for heating circuit

Parameter	Function	Parameter description	Setting range	Default value
S2.1	INFLUENCE OF ROOM TEMPERAT. DEVIATION	Set the value of gain of room temperature deviation. Lower value means lower influence, higher value means higher influence.	0,0 ÷ 3,0	1
S2.2	INFLUENCE OF ROOM SENSOR T1	Set whether the room sensor influences the controller operation. This function is active only if parameter S1.6=0 (room sensor).	1- YES 2- NO	1

Parameter	Function	Parameter description	Setting range	Default value
S2.3	INFLUENCE OF DD2+ ROOM SENSOR	Set whether the room unit influences the controller operation. # 1 only the sensor from the first room unit has influence # 2 only the sensor from the second room unit has influence # 1 & 2 sensor from the both room units have influence AUTO sensors from the room unit which control the heating circuit have influence	1- AUTO 2- #1 3- #2 4- #1&2 5- NO	1
S2.4	PUMP OPERATION MODE	Setting of pump operation mode. Settings have the following meaning: 1 - STAND. (circulation pump of mixing circuit - regular) 2 - P1 (operation according to time program P1= OFF) 3 - P2 (operation according to time program P2= OFF) 4 - P3 (operation according to time program P3= OFF) 5 - P4 (operation according to time program P4= OFF) 6 - SEL. PROG. (operation according to selected time program)	1 - STAND. 2- P1=OFF 3- P2=OFF 4- P3=OFF 5- P4=OFF 6 - SEL. PROG.	1
S2.5	MINIMUM STAND-PIPE TEMPERATURE	Setting of minimum stand-pipe temperature limitation.	10 ÷ 90 °C	20
S2.6	MAXIMUM STAND-PIPE TEMPERATURE	Setting of maximum stand-pipe temperature limitation.	20 ÷ 150 °C	45 - floor 85 - radiator
S2.7	DEAD ZONE OF MIXING VALVE CONTROL	Setting of stand-pipe temperature span in which mixing valve control is in stand-by.	1,0 ÷ 3,0 K	1
S2.8	MIXING VALVE P - CONSTANT	Setting of mixing valve position correction intensity. Smaller value means shorter movements, higher value means longer movements,	0,5 ÷ 2,0	1
S2.9	MIXING VALVE I - CONSTANT	Setting of mixing valve control frequency - how often mixing valve position is being controlled. Smaller value means low frequency, higher value means higher frequency.	0,4 ÷ 2,5	1
S2.10	MIXING VALVE D - CONSTANT	Sensitivity of mixing valve for stand-pipe temperature changes. Smaller value means low sensitivity, higher value means high sensitivity.	0,4 ÷ 2,5	1
S2.11	MINIMUM STAND-PIPE TEMPERATURE FOR COOLING	Setting of minimum stand-pipe temperature in cooling mode. CAUTION! Too low stand-pipe temperature can cause dewing of heating bodies and pipelines.	10 ÷ 20 °C	15
S2.12	HEATING-OFF TEMPERATURE SHIFT	Shift of calculated stand-pipe temperature for heating switch-off.	-10 ÷ 10 K	0
S2.13	LIMITATION OF TEMP. DIFFERENCE BETWEEN STAND AND RETURN PIPE	Setting of maximal difference between stand-pipe and return-pipe temperature. Limiting the highest power of heating system .	3 ÷ 30 K	10
S2.14	CONSTANT STAND-PIPE TEMPERATURE	Selection of operation with constant stand-pipe temperature. Setting range is 10 ÷ 140 °C. <i>This function deactivates weather compensated control of mixing valve.</i>	0 - NO 1 - YES	0
S2.15	CIRCULATION PUMP SWITCH-OFF DELAY (MINUTES)	Setting of delayed circulation pump switch-off when there is no requirement for heating.	0 ÷ 10 min	5

Settings for heat sources



Parameter	Function	Parameter description	Setting range	Default value
S3.1	MAXIMUM BOILER TEMPERATURE	Setting of maximal boiler temperature.	60 ÷ 160 °C	90
S3.2	BOILER TEMPERATURE INCREASE FOR MIXING CIRCUIT	Setting of difference between boiler temperature and calculated stand-pipe temperature.	0 ÷ 25 K	5

FLOOR DRYING PARAMETERS

In group F1 are parameters for floor drying:



The procedure for setting floor drying parameters is the same as for the service settings (see page 32).

Floor drying parameters



Parameter	Function	Setting range	Default value
F1.1	ACTIVATION OF FLOOR DRYING	0- NO 1- YES	0
F1.2	INTERVAL 1: DURATION	1 ÷ 15 days	10
F1.3	INTERVAL 1: START TEMPERATURE	10 ÷ 60 °C	20
F1.4	INTERVAL 1: END TEMPERATURE	10 ÷ 60 °C	20
F1.5	INTERVAL 2: DURATION	1 ÷ 15 days	5
F1.6	INTERVAL 2: START TEMPERATURE	10 ÷ 60 °C	20
F1.7	INTERVAL 2: END TEMPERATURE	10 ÷ 60 °C	50
F1.8	INTERVAL 3: DURATION	1 ÷ 15 days	10
F1.9	INTERVAL 3: START TEMPERATURE	10 ÷ 60 °C	50
F1.10	INTERVAL 3: END TEMPERATURE	10 ÷ 60 °C	50
F1.11	INTERVAL 4: DURATION	1 ÷ 15 days	5
F1.12	INTERVAL 4: START TEMPERATURE	10 ÷ 60 °C	50
F1.13	INTERVAL 4: END TEMPERATURE	10 ÷ 60 °C	20

Floor drying profile - default setting:

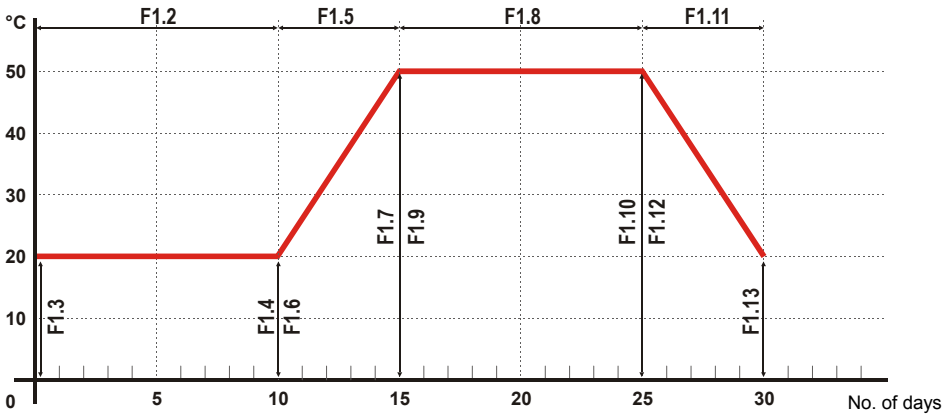

FACTORY SETTINGS

In this menu are tools to help with the controller settings.



RESET OF ALL CONTROLLER PARAMETERS

Restores all settings of parameters P1, P2, P3, S1 (except S1.1), S2, S3 and F1 to default values.



RESET OF TIME PROGRAMS

Restores default time programs.



RESET OF ALL CONTROLLER SETTINGS AND RESTART INITIAL SETUP

Restores all parameters to default values and starts the initial setup.



SAVE USER SETTINGS

Save all the controller settings as the user's settings.



LOAD USER SETTINGS

Load previously saved user settings.

INSTALLATION MANUAL

CONTROLLER INSTALATION

Install the controller in dry room, where it is not directly exposed to strong electromagnetic fields. Press the controller directly onto the mixing valve. Disassembling or opening of the controller is not needed and not allowed.

INSTALLATION ONTO MIXING VALVE

Installation example shown on the picture bellow is valid for mixing valves of the following manufacturers: Esbe, Seltron, Somatherm, Acaso, Ivar, Wip, Paw, BRV, Imit, Hora, Barberi, Olymp, Hoval.

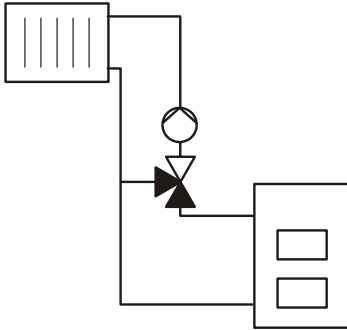

Example of installation onto 3 way mixing valve.

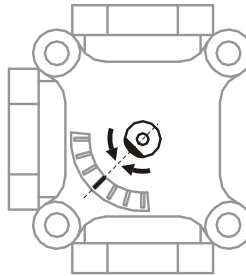

1a

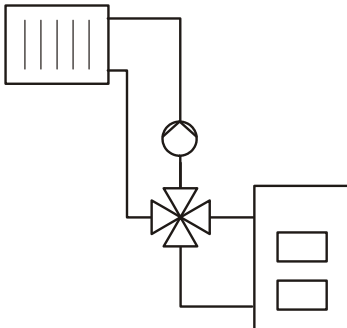

Example of installation onto 4 way mixing valve.

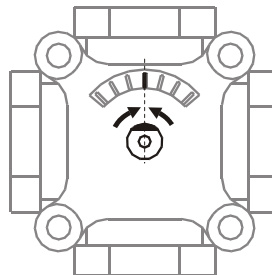

1b



The mixing valve needs to be turned in the middle position.

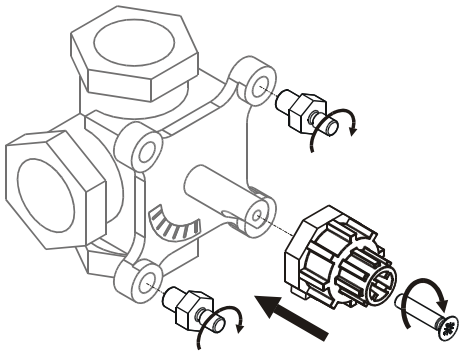

Installation onto 3 way mixing valve.

2a

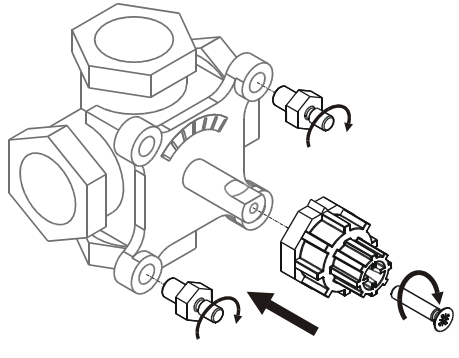

Installation onto 4 way mixing valve.

2b

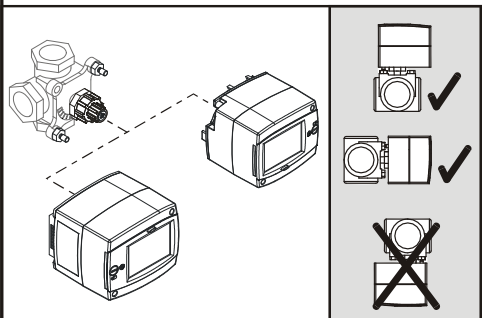
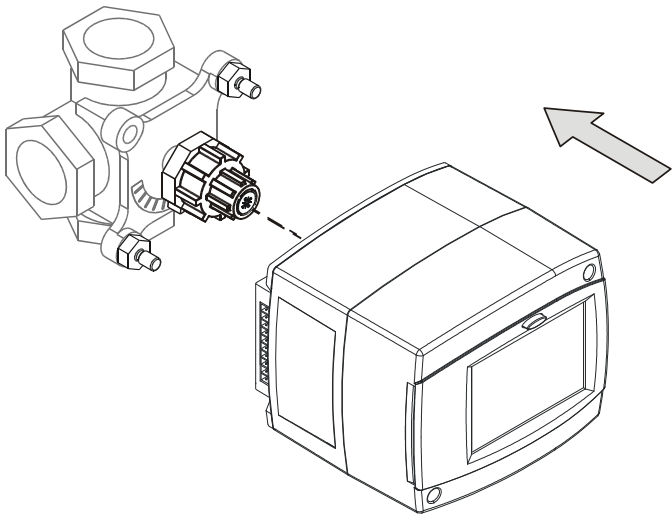

3

CONTROLLER'S ELECTRIC CONNECTION



Pictures, diagrams and text in this manual are intended solely as an example and the manufacturer does not accept any responsibility for them. If you use content of this manual as a base for your project, then you carry also full responsibility for it. Responsibility of publisher for unprofessional, wrong and false information and consecutive damage are explicitly excluded. We retain the right for technical errors, mistakes, changes and corrections without prior notice.

Installation of controlling devices should be done by an expert with suitable qualification or by an authorised organisation. Before you deal with the main wiring, make sure that the main switch is switched off.

You have to follow the rules for low-voltage installations IEC 60364 and VDE 0100, law prescriptions for prevention of accidents, law prescriptions for environmental protection and other national regulations.

Not following the rules this may lead to serious injuries such as burns or even risk of death.

CONNECTION OF MAINS

All mains connection are made by means of built-in cables. Cable for power supply from the network is equipped with schuko plug. Other power supply cable is intended for connection of pump.

CONNECTION OF SENSORS, ROOM UNITS AND BUS

Layout of connectors is shown in picture.

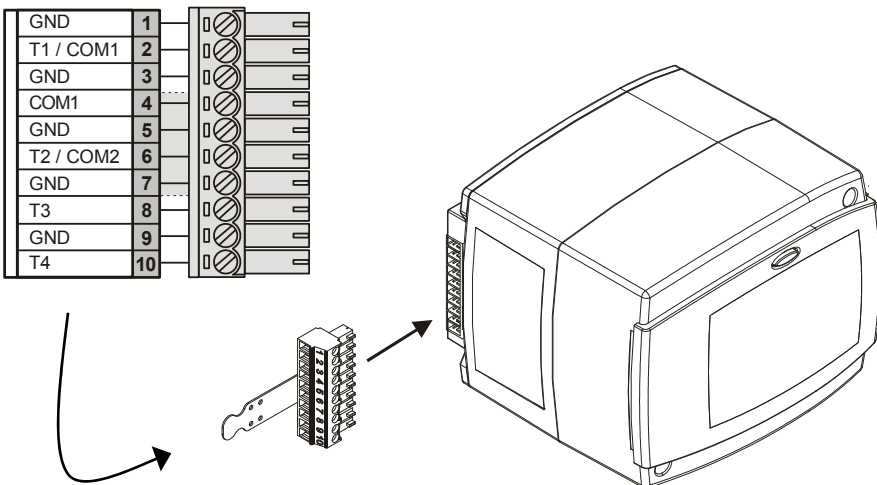

CONNECTION OF DIGITAL ROOM UNIT DD2+

The room unit is used to measure room temperature, to adjust day and night temperature and to set operation mode. Maximum two room units can be connected to the controller. Before connecting the room unit it is necessary to set the coding switches on the back side of the room unit.

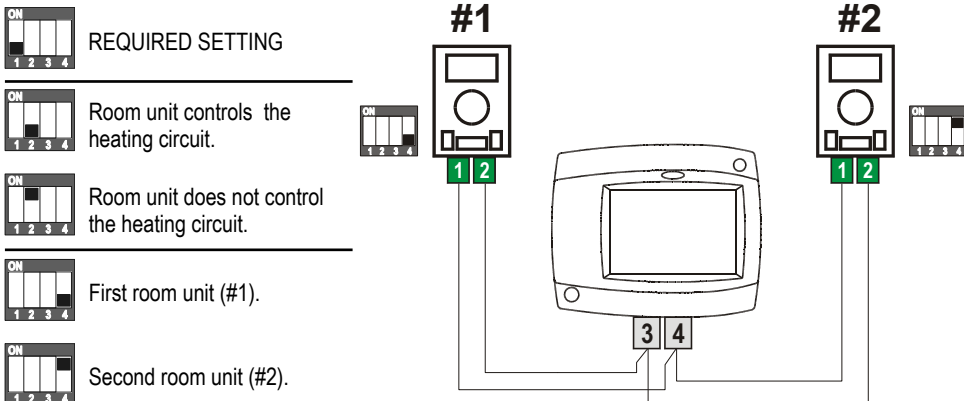

CONNECTION OF ROOM SENSOR

Room sensor is used to measure the room temperature, the same as digital room unit DD2+. It improves efficiency of room temperature control. For controller operation room sensor isn't required. When the room sensor is connected, set parameter S1.6 = 0.

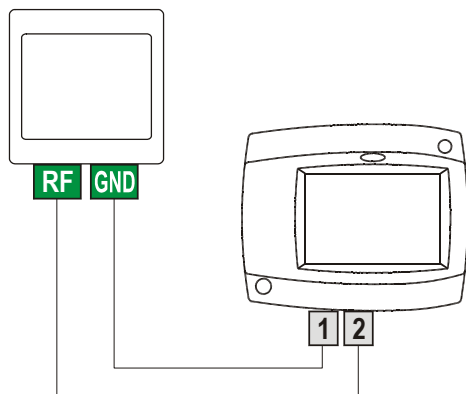

i Connection of room sensor is possible on schemes 360 and 360b.

MARKING AND DESCRIPTION OF TEMPERATURE SENSORS

Outdoor sensor

Outdoor sensor is intended for installation on north or northwest outer wall, approximately 2 m above the ground. Installation above windows or ventilation ducts isn't allowed.

Mount sensor in a way to prevent influence of thermal losses (through the wall) on a sensor. In other case temperature measurement will be false.

Surface sensor

Surface sensor is intended for installation on pipelines above circulation pump or mixing valve. Clean the contact surface where the sensor will be mounted. Fix the sensor with a spring.

Immersion sensor

Immerse the sensor till the end of the sleeve on the heat source. Fix the sensor with a screw or a clip.

Room sensor or room unit

Room sensor or room unit is mounted on the inner wall of the living room, which is not exposed to the sun and away from heat sources and drafts. First take off the lid, then screw the base to the location ca. 1.5 meters above the ground. Installation is possible on standard flush-mounted box or directly on the wall. For electrical connection two-wire signal cable is needed. Radiators with thermostatic valves need to be fully open in a room where room unit is mounted.

TABLE: Temperature sensors' resistance type Pt1000:

Temperature [°C]	Resistance [Ω]	Temperature [°C]	Resistance [Ω]	Temperature [°C]	Resistance [Ω]	Temperature [°C]	Resistance [Ω]
-20	922	35	1136	90	1347	145	1555
-15	941	40	1155	95	1366	150	1573
-10	961	45	1175	100	1385	155	1592
-5	980	50	1194	105	1404	160	1611
0	1000	55	1213	110	1423	165	1629
5	1020	60	1232	115	1442	170	1648
10	1039	65	1252	120	1461	175	1666
15	1058	70	1271	125	1480	180	1685
20	1078	75	1290	130	1498	185	1703
25	1097	80	1309	135	1415	190	1722
30	1117	85	1328	140	1536	195	1740

OPERATION MODE BY SENSOR FAILURE

If one of the temperature sensors fails, then the controller adjusts itself to the most suitable operation mode:

Outdoor temperature sensor isn't connected or has a malfunction

The controller operates as a P-controller according to room temperature deviation. If the room sensor is also in error, the controller will maintain constant stand-pipe temperature which is:

- by radiator heating for 25 °C higher as the set day or night temperature
- by floor heating for 10 °C higher as the set day or night temperature

Stand pipe temperature sensor isn't connected or has a malfunction

The controller assumes a 120 °C stand-pipe temperature and stops room heating. Heating can be reactivated only by manual operation mode.

Room temperature sensor or room unit isn't connected or has a malfunction

Room heating operates normally, with respect of outdoor temperature.

Return pipe temperature sensor isn't connected or has a malfunction

Room heating operates normally, without limitation of temperature difference between stand and return pipe.

Boiler temperature sensor isn't connected or has a malfunction

The controller assumes a 85 °C boiler temperature and functioning normally.

EXPANDING THE SYSTEM TO MULTIPLE HEATING CIRCUITS

BUS connection of controllers CMP25-2 :

By BUS connection, any number of controllers CMP25-2 can be connected with each other.

Important: The outdoor and the boiler temperature sensor need to be connected in the last controller.

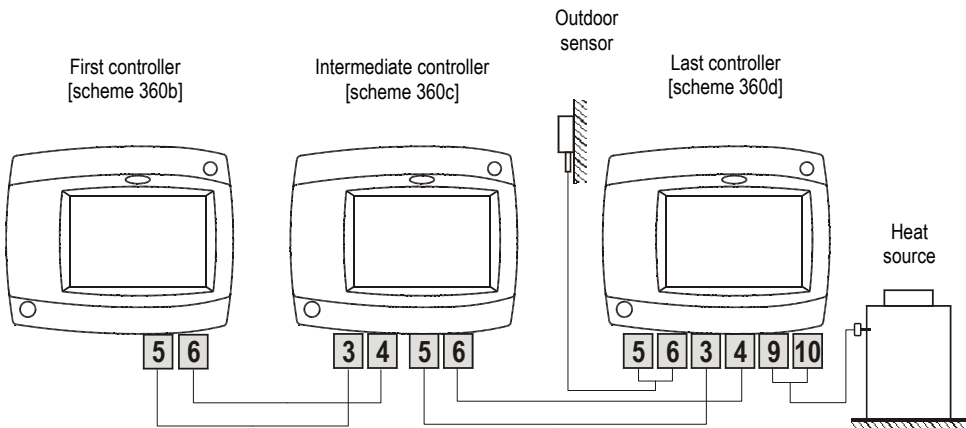

BUS connection of controllers CMP25-2 and WDC10B, WDC10 or WDC20:

By Bus connection, you can connect with each other any number of controllers WDC and CMP25-2. The first controller (WDC) controls the heat sources, while others control only heating circuits.

Important: The outdoor and the boiler temperature sensor need to be connected in the first controller.

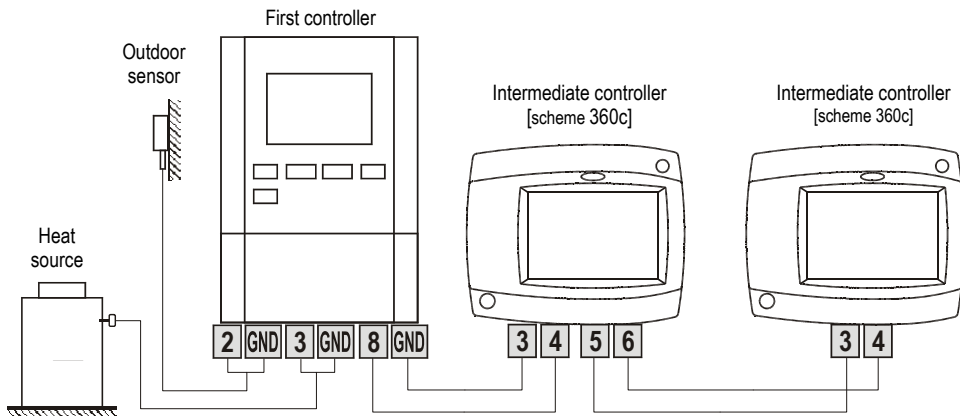

BUS connection of controllers CMP25-2 and D10, D20:

By Bus connection, you can connect with each other any number of controllers D10, D20 and CMP25-2. The first controller controls the heat sources, while others only control the heating circuits.

Important: The outdoor and the boiler temperature sensor need to be connected in the first controller.

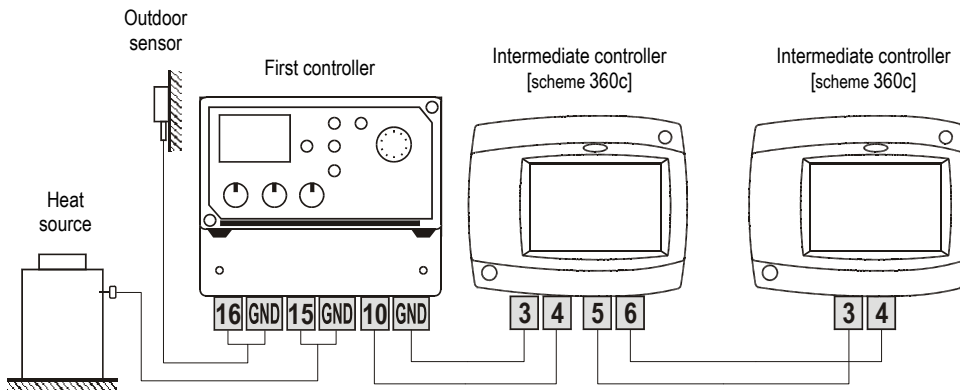

IMPORTANT

CAUTION: Installation schemes show the operation principle and do not contain all auxiliary and safety elements! When installing you have to follow valid rules!

----- Optional sensor. Not needed for controller operation.



*For controller operation room unit or room sensor is not needed.
Room unit or room sensor connection is described on page 40.*

Scheme 360
Standalone mixing circuit

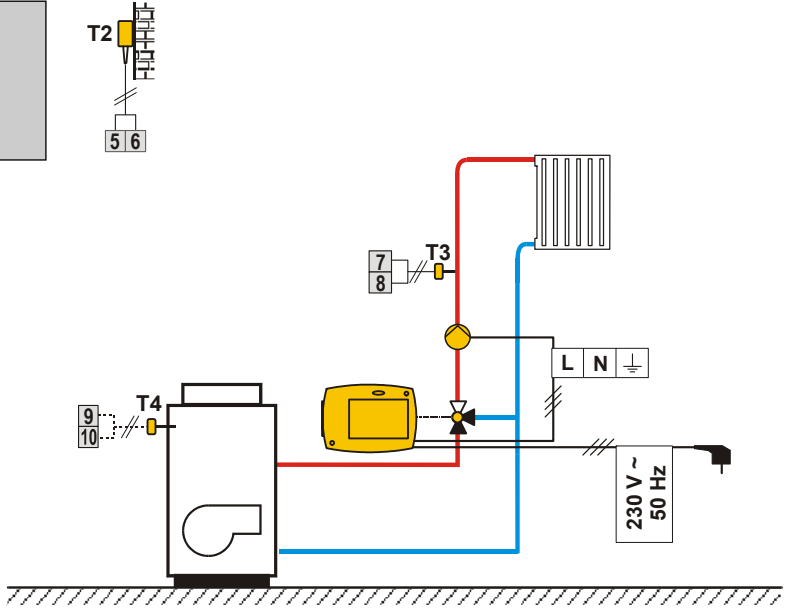

Scheme 360b
Multiple mixing circuits
(first controller in bus connection)

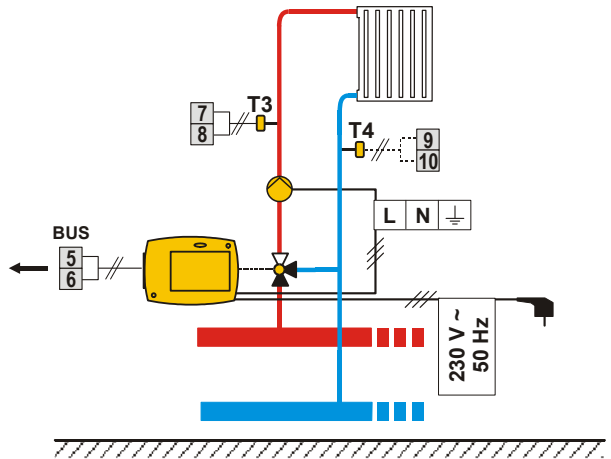
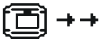

i *BUS connection of controllers is described on pages 42 and 43.*

Scheme 360c
Multiple mixing circuits
(intermediate controller in bus connection)

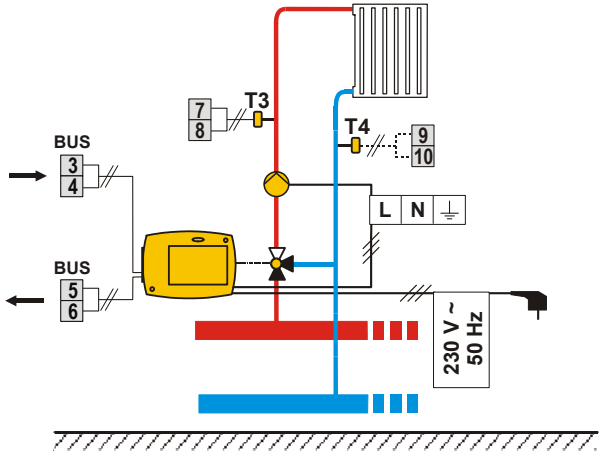

i BUS connection of controllers is described on pages 42 and 43

Scheme 360d
Multiple mixing circuits
(last controller in bus connection)

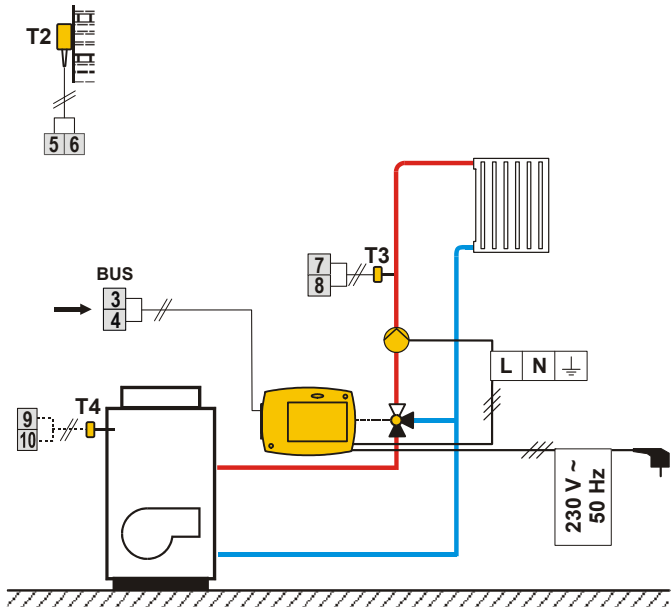
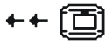

i BUS connection of controllers is described on pages 42 and 43

General technical data

Power supply.....	230 V ~ , 50 Hz,
Consumption	Max. 4 VA
Pump output.....	230 V ~ / 4 (2) A
Housing	ABS - thermoplastic
Dimensions (w x h x d):	84 x 105 x 100 mm
Weight	900 g ÷ 950 g
Color / material.....	dark grey / PC
Degree of protection.....	IP42 by EN 60529
Safety class.....	II by EN 60730-1
Type of operation	Tip 1B by EN 60730-1
Ambient temperature.....	0 to +40 °C
Storing temperature.....	-20 to +70 °C

Technical specifications:

Day temperature setting range:.....	10 °C ÷ 30 °C
Night temperature setting range:.....	10 °C ÷ 30 °C
Heat curve setting range:	0.2 ÷ 2.2
Frost protection temperature:	+ 6 °C (adjustable)
Dead zone range of PI controller:.....	± 0.7 K ÷ ± 1.5 K
Temp. sensor type:.....	Pt1000 or KTY-10
Program timer:.....	multi channel program timer

DECLARATIONS AND STATEMENTS

CONFORMITY WITH STANDARDS AND DIRECTIVES

Weather compensated controller PROMATIC CMP25-2 meets the requirements and rules of the following directives:

- Directive for Electromagnetic compatibility 2004/108/EC,
- Low voltage directive 2006/95/EC,
- Directive for hazardous substances in electric and electronic appliances (Rohs) 2002/95/EC.

PRODUCT DESCRIPTION:

Weather compensated controller for central heating systems

MODEL NAME:

CMP25-2

APPLIED STANDARDS:

EN60730-1, EN60730-2-9,
EN60730-2-11, EN60730-2-14,
EN12098-1, EN61000-6-1, EN55014-1.



DISPOSAL OF OLD ELECTRICAL & ELECTRONIC EQUIPMENT

Discarding old electrical and electronic equipment (valid for EU member states and other European countries with organized separate waste collection).



This symbol on the product or packaging means the product cannot be treated as a household waste and it has to be disposed of separately via designated collection facilities for old electrical and electronic equipment (OEEO). The correct disposal and separate collection of your old appliance will help prevent potential negative consequences for the environment and human health. It is a precondition for reuse and recycling of used electrical and electronic equipment. For more detailed information about disposal of your old appliance, please contact you city office, waste disposal service or the shop where you purchased the product.

Witterungsgeführter Heizungsregler des Mischerheizkreises

PROMATIC CMP25-2

DEU



EINLEITUNG

Die Regler PROMATIC CMP25-2 sind moderne, von Mikroprozessoren gesteuerte Geräte. Die Regler benutzen digitale und SMT- Technologie.

Sie dienen der Regelung der Radiatorheizungen oder Fußbodenheizungen. Die Regulierung erfolgt durch den Mischerheizkreis. Die Vorprogrammierung der Raumheizung erfolgt mittels einer eingebauten digitalen Mehrkanaluhr.

Die Regler CMP25-2 können ins Netz verbunden werden und fungieren als ein einheitliches Regelungssystem mit mehreren Heizkreisen.



Für die erste Inbetriebnahme des Reglers, siehe REGLEREINSTELLUNG BEI DER ERSTEN INBETRIEBNAHME (Seite 53)!

INHALT

BEDIENUNGS- UND EINSTELLUNGSANLEITUNGEN

BESCHREIBUNG DES REGLERS.....	52
Aussehen des Reglers CMP25-2	52
Betriebsartsignalisierung	52
REGLEREINSTELLUNG BEI DER ERSTEN INBETRIEBNAHME.....	52
Verlauf der Einstellung	52
GRAPHISCHER LCD DISPLAY	55
Aussehen des Displays	55
Beschreibung der Symbole am Display.....	55
Symbole zur Darstellung der Betriebsart des Reglers	55
Symbole zur Darstellung der Benutzerfunktionen	56
Symbole zur Darstellung der Temperatur und anderen Daten	56
Symbole zur Darstellung der Schutzfunktionen.....	57
Symbole zur Darstellung der Kommunikation der Angeschlossene Geräte	57
Warnsymbole	57
Grundnavigation im Display	58
Display Ent- und Zusperrern.....	58
Hilfebildschirm, Meldungen und Warnungen.....	59
Offnen des Menüs und der Navigation	60
Menüstruktur und Menübeschreibung	61
Temperatureinstellung.....	64
Benutzerfunktionen	65
Betriebsartenwahl.....	66
Zeitprogramme	67
Grundeinstellungen	70
Daten kontrolle	71

WARTUNGSANLEITUNGEN

Reglerparameter	72
Grundparameter	72
Heizkurve	74
Wartungsparameter.....	76
Die Parameter der Estrichrocknung	79
Werkseinstellungen	80

MONTAGEANLEITUNGEN

MONTAGE DES REGLERS	81
Montage auf das Mischventil	81
Elektrisches Anschluss des Reglers	83
Anschlüsse für die Stromversorgung	83
Anschlüsse für Fühler und BUS Verbindungen	83
Anschluss der Raumeinheit DD2+	84
Anschluss des Raumfühlers	84
Montagebeschreibung und Temperaturfühlerbezeichnung	85
Betriebsbeschreibung bei Fühlerstörung	86
Systemerweiterung auf mehrere Heizkreise	86
HYDRAULIKSCHEMEN	88
TECHNISCHE DATEN.....	91
ERKLÄRUNGEN UND GARANTIE	92
CE-Konformitätserklärung	92
Entsorgung von gebrauchten Elektrischen und Elektronischen Geräten	92

BEDIENUNGS- UND EINSTELLUNGSANLEITUNGEN

BESCHREIBUNG DES REGLERS

AUSSEHEN DES REGLERS CMP25-2

DEU

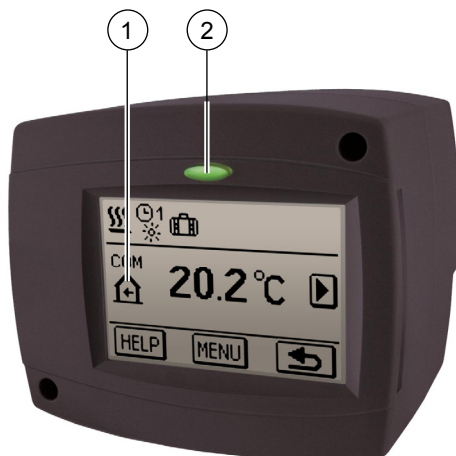

① Graphischer Touch-Screen.

② Taste  - Esc.

BETRIEBSARTSIGNALISIERUNG



LED Licht leuchtet:

Grün - das Mischventil schließt

Rot - das Mischventil öffnet

REGLEREINSTELLUNG BEI DER ERSTEN INBETRIEBNAHME

Die Heizungsregler CMP25-2 beinhalten eine innovative Lösung "EASY START", die eine einfache Einstellung mit Hilfe eines Assistenten ermöglicht.

VERLAUF DER EINSTELLUNG

CMP25-2 V1.0r0



Bei der Ersteinsschaltung des Reglers ans Netz oder nach dem Reset des Reglers wird, nach der Angabe der Programmversion der Assistent zum Einstellen des Reglers aktiviert.

DEU

1. SCHRITT - DISPLAYDREHUNG

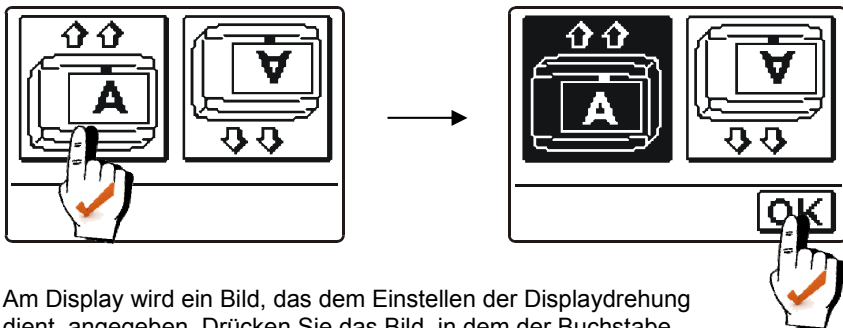

Am Display wird ein Bild, das dem Einstellen der Displaydrehung dient, angegeben. Drücken Sie das Bild, in dem der Buchstabe **A** richtig gedreht ist. Nachdem Sie die richtige Displaydrehung gewählt haben, bestätigen Sie die mit dem Drücken auf die Taste **OK**.

2. SCHRITT - ÖFFNEN DES MISCHVENTILS

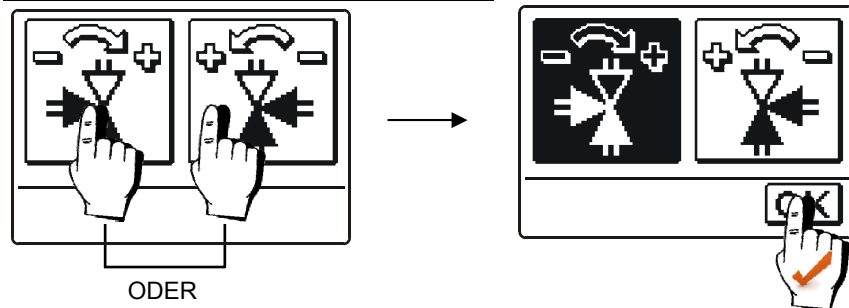

ODER

Drücken sie das Feld, in dem die richtige Drehrichtung zum Öffnen (+) des Mischventils angezeigt wird. Nachdem sie die richtige Drehrichtung angewählt haben, bestätigen sie die mit Drücken der Taste **OK**.

3. SCHRITT - SPRACHENAUSWAHL

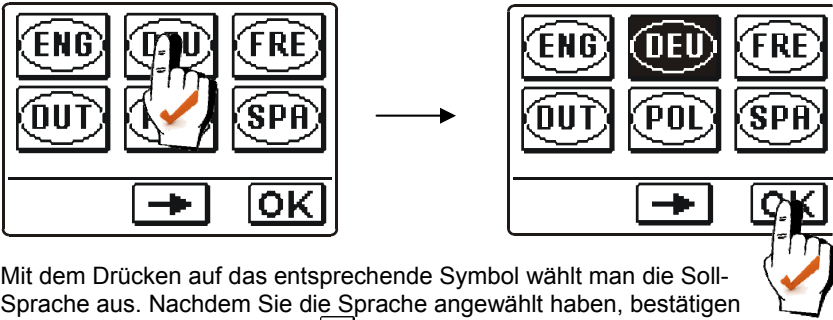

Mit dem Drücken auf das entsprechende Symbol wählt man die Soll-Sprache aus. Nachdem Sie die Sprache angewählt haben, bestätigen Sie die mit drücken der Taste **OK**.

4. SCHRITT - HYDRAULIKSCHEMAAUSWAHL

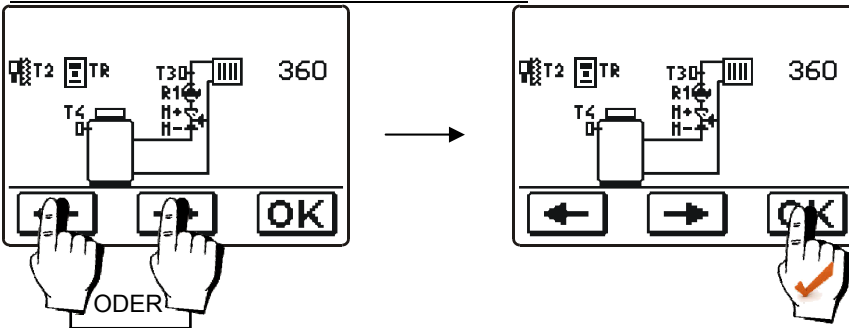

Das Hydraulikschema des Reglerbetriebs auswählen. Die Wahl mit Drücken der Taste **OK** bestätigen.

5. SCHRITT - HEIZKURVENSTELTHEIT

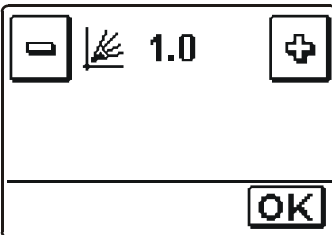

Mit den Tasten **-** und **+** wird der Soll-Wert der Heizkurve eingestellt. Die Einstellung bestätigt man mit der Taste **OK**.

Die Bedeutung der Heizkurvensteilheit ist auf den Seiten 74 und 75 detailliert beschrieben.



Das Hydraulik Schema, Display Richtung, Drehrichtung und die Sprache können wir jederzeit in den Serviceeinstellungen ändern oder den Regler zurücksetzen (Reset).



RESET - erneutes Einstellen des Reglers!

*Schalten sie die Stromversorgung des Reglers aus. Drücken und halten Sie die Taste **○** und stellen die Stromversorgung wieder her.*

Der Regler wird zurückgesetzt und kann erneut Eingestellt werden.

GRAPHISCHER LCD DISPLAY

Das graphische Display hat ein berührungsempfindliches Display, welches neben der Daten über die Leistung auch zur Einstellung der Reglerfunktion dient. Am LCD Display können Informationen über die Leistung des Reglers durchgeblättert werden und die Betriebseinstellungen geändert werden.

AUSSEHEN DES DISPLAYS

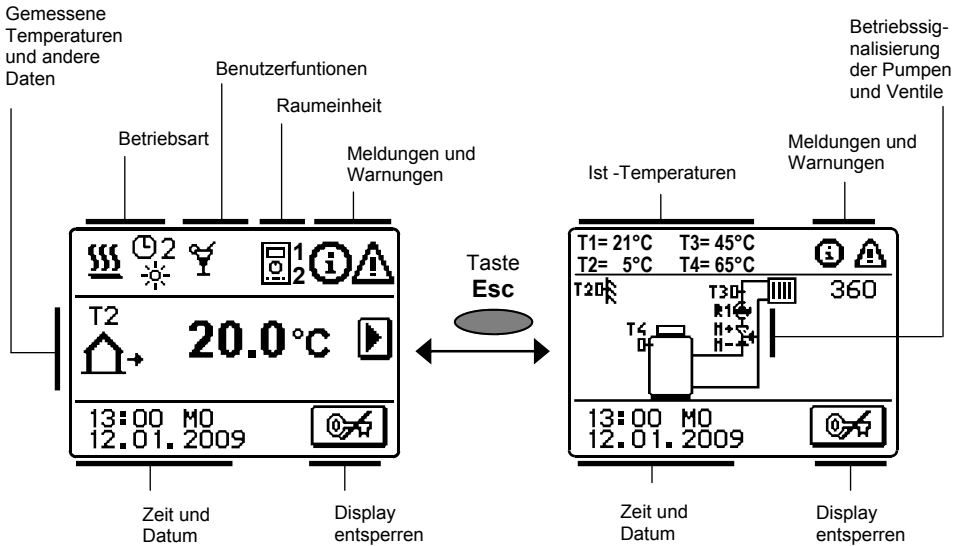









BESCHREIBUNG DER SYMBOLE AM DISPLAY











SYMBOLE ZUR DARSTELLUNG DER BETRIEBSART DES REGLERS

Symbol	Beschreibung
SSS	Heizung
☃	Kühlung
☉ C2	Automatikbetrieb nach Zeitprogramm - Tagestemperatur
☾ C2	Automatikbetrieb nach Zeitprogramm - Nachttemperatur
☀	Tagestemperaturbetrieb
☾	Nachttemperaturbetrieb
⏻	Aus
✋	Manueller Betrieb



SYMBOLE ZUR DARSTELLUNG DER BENUTZERFUNKTIONEN

Symbol	Beschreibung
	Party
	Eco
	Urlaub
	Estrichtrocknung 01/ - aktueller Tag 25 - dauer
	Sommerbetrieb
	Konstantere Vorlauftemperaturbetrieb
	Fernschaltung
	Boost Heizung







SYMBOLE ZUR DARSTELLUNG DER TEMPERATUR UND ANDERE DATEN

Symbol	Beschreibung
	Die Ist-Temperatur
	Die ausgerechnete oder Soll-Temperatur
	Raumtemperatur
	Außentemperatur
	Vorlauftemperatur
	Rücklauftemperatur
	Kesseltemperatur
	Mischventil - schließen (blinken weist auf die Schließnotwendigkeit hin)
	Mischventil - öffnen (blinken weist auf die Öffnungsnotwendigkeit hin)
	Umwälzpumpe aktiv
T1, T2, T3, T4 TR TA TQ	Temperatur des Fühlers T1, T2, T3 oder T4. Temperatur der Raumeinheit DD2+. Außentemperatur, die durch der Bus-Verbindung erhalten wurde. Kesseltemperatur, die durch der Bus-Verbindung erhalten wurde.

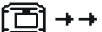

SYMBOLE ZUR DARSTELLUNG DER SCHÜTZFUNKTIONEN

Symbol	Beschreibung
	Kesselüberhitzungsschutz
	Frostschutz

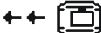







SYMBOLE ZUR DARSTELLUNG DER KOMMUNIKATION DER ANGESCHLOSSENEN GERÄTE

Symbol	Beschreibung
	Geräte, die an die Kommunikationslinie COM angeschlossen sind
	Raumeinheit DD2+ ist angeschlossen
	Reglerstatus in der BUS Verbindung COM1/COM2
	Selbständiger Regler - nicht in der bus Verbindung
	Hauptregler in der BUS Verbindung
	Untergeordneter Regler - Zwischenregler in der BUS Verbindung
	Untergeordneter Regler - letzter Regler in der BUS Verbindung

WARNSYMBOLS

Symbol	Beschreibung
	Meldung Im Falle einer Überschreitung der maximalen Temperatur oder des Einschaltens der Schutzfunktion blinkt auf der Anzeige ein entsprechendes Symbol. Wenn die maximale Temperatur nicht mehr überschritten ist oder sich die Schutzfunktion wieder abgeschaltet hat, wird auf der Anzeige ein entsprechendes Symbol angezeigt. Mit dem Drücken der Taste HELP können Sie die vorhandenen Meldungen durchsehen.
	Warnung Im Falle einer Störung des Fühlers, der Bus-Verbindung oder der Com-Verbindung blinkt auf der Anzeige ein entsprechendes Symbol. Im Falle, dass die Störung beseitigt wurde, wird auf der Anzeige ein entsprechendes Symbol angezeigt. Mit dem Drücken der Taste HELP können Sie die vorhandenen Warnungen durchsehen.

GRUNDNAVIGATION IM DISPLAY

Taste	Funktion der Taste
	Display zusperren und entsperren
	Hilfe
	Menüanwahl
	Bewegen zu nächsten Daten
	Das Menü oder die Daten nach vorne/nach hinten durchblättern
	Wertzunahme oder Wertabnahme
	Bestätigung der Einstellung
	Bestätigung der Einstellung und Zurücksetzung auf das vorige Menü oder Anwahl

DISPLAY ENT- UND ZUSPERREN

Wenn man die Reglereinstellungen verändern möchte oder die Betriebsdaten durchblättern möchte, muss das Display erst mit dem Drücken auf die Taste  entsperrt werden. Das Display wird 60 s nach dem letzten Drücken einer beliebigen Taste automatisch zugesperrt.

HILFEBILDSCHIRM, MELDUNGEN UND WARNUNGEN

Mit dem Drücken der Taste **HELP** können Sie den Hilfebildschirm, Meldungen und Hinweise abrufen. Es öffnet sich ein neues Fenster mit folgenden Möglichkeiten.

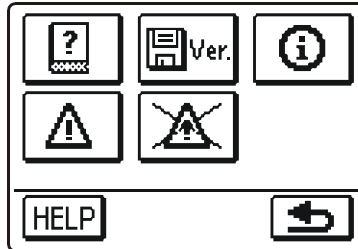

Verfügbare Möglichkeiten:



Kurze Einleitungen

Kurze Einleitungen für Regler betrieb.





Version des Reglers

Anzeige des Modells und der Softwareversion des Reglers.





Meldungen

Liste der Überschreitungen der maximalen Temperatur und der Aktivierungen der Schutzfunktionen. Mit dem Drücken der Tasten  und  können Sie sich durch die Liste der Meldungen bewegen.

Mit der Taste  können Sie die Liste der Ereignisse verlassen.



Warnungen

Liste der Fühlerstörungen, Störungen der Bus- und Com-Verbindung. Mit dem Drücken der Tasten  und  können Sie sich durch die Liste der Warnungen bewegen.

Mit der Taste  können Sie die Liste der Ereignisse verlassen.





Löschung der Warnungen

Mit dem Drücken der Taste können Sie alle Fühler, die nicht angeschlossen sind aus der Fehlerliste löschen.

Achtung: Fühler, die für das Funktionieren des Reglers notwendig sind, können nicht gelöscht werden.

ÖFFNEN DES MENÜS UND DER NAVIGATION

Das Display wird mit dem Drücken der Taste  entsperrt. Ins Einstellmenü gelangt man mit Drücken der Taste .

DEU

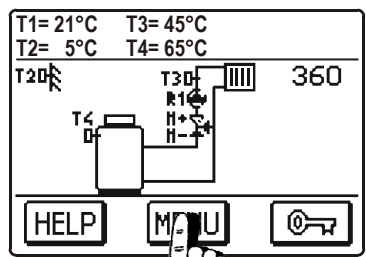
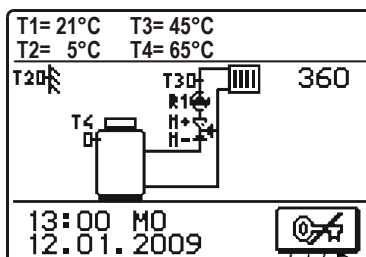
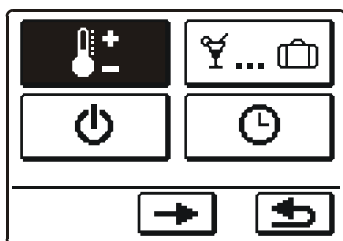
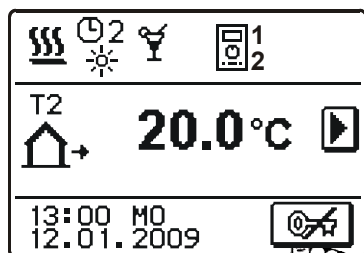

Innerhalb des Menüs bewegt man sich durch Drücken der Ikonen, die am Display angezeigt werden.



Wenn im Menü auf einmal mehrere Displayanzeigen vorkommen, kann man sich Zwischen denen mit dem Drücken der Taste  oder  bewegen.

MENÜSTRUKTUR UND MENÜBESCHREIBUNG



TEMPERATUREINSTELLUNGEN

- Tagestemperatur
- Nachttemperatur



BENUTZERFUNKTIONEN

- Party
- Eco
- Urlaub
- Funktion abschalten



BETRIEBSART

- Automatikbetrieb
- Tagestemperaturbetrieb
- Nachttemperaturbetrieb
- Regler abschalten
- Heizung / Kühlung Umschaltung
- Manueller Betrieb



ZEITPROGRAMME

- Zeitprogramm 1
- Zeitprogramm 2
- Zeitprogramm 3
- Zeitprogramm 4

GRUNDEINSTELLUNGEN

- Sprachenauswahl
- Zeit und Datum
- DISPLAY EINSTELLUNG**
 - Dauer der aktiven Displaybeleuchtung und Menu Autoausgang
 - Intensität der aktive Displaybeleuchtung
 - Intensität der inaktiven Displaybeleuchtung
 - Kontrast

DATEN KONTROLLE

- Graphische Darstellungen der gemessenen Temperaturen für die vergangene Woche
- Graphische Darstellungen der Temperaturen des aktuellen Tages
- Spezielle Wartungsdaten

GRUNDPARAMETER

- P1** Grundeinstellungen
- P2** Mischerheizkreiseinstellungen
- P3** Wärmequelleneinstellungen

WARTUNGSPARAMETER

- S1** Grundeinstellungen
- S2** Mischerheizkreiseinstellungen
- S3** Wärmequelleneinstellungen

**WERKSEINSTELLUNGEN**

Reset der Regler Parameter



Reset der Zeitprogramme



Reset des Reglers und erneuter Start der Ersteinstellung



Benutzereinstellungen speichern



Benutzereinstellungen laden





TEMPERATUREINSTELLUNG

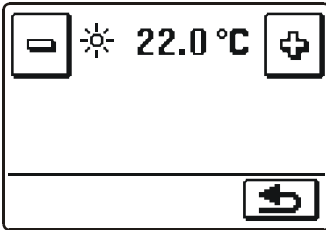

Tagestemperatur





Mit den Tasten  und  wird der Soll-Wert der Temperatur eingestellt. Die Einstellung bestätigt man mit der Taste  und blättert auf das vorige Display zurück.

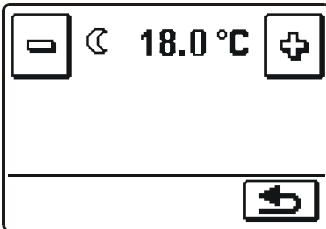

Nachttemperatur



Mit den Tasten  und  wird der Soll-Wert der Temperatur eingestellt. Die Einstellung bestätigt man mit der Taste  und blättert auf das vorige Display zurück.

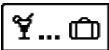



BENUTZERFUNKTIONEN

Die Benutzerfunktionen ermöglichen einen zusätzlichen Komfort und Funktionalität beim Gebrauch des Reglers. Im Menü stehen Ihnen folgende Benutzerfunktionen zur Verfügung:



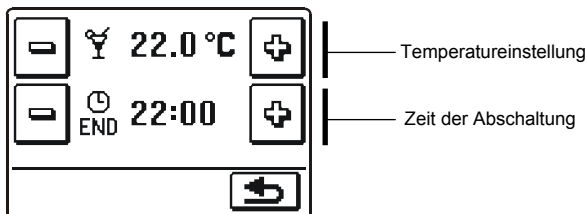

PARTY

Mit drücken der Party Taste schalten wir die Raumheizung auf Komforttemperatur. Zur Einstellung der Party-Funktion, drücken sie noch einmal das Party-Symbol. Mit den Tasten  und  wählt man die Soll-Temperatur und die Zeit der Abschaltung der Funktion aus.



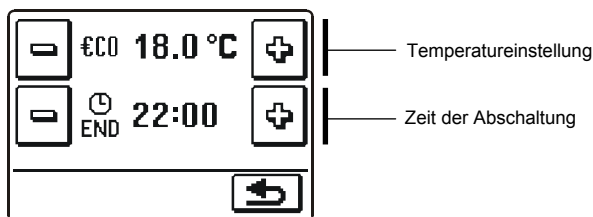

ECO

Mit drücken der ECO Taste schalten wir die Raumheizung auf sparsame Temperatur. Zur Einstellung der Eco-Funktion, drücken sie noch einmal das Eco-Symbol. Mit den Tasten  und  wählt man die Soll-Temperatur und die Zeit der Abschaltung der Funktion aus.



URLAUB

Mit drücken der URLAUB Taste schalten wir die Raumheizung auf eine besonders sparsame Temperatur, bis zum einen gewünschten Datum. Zur Einstellung der Urlaub-Funktion, drücken sie noch einmal das Urlaub-Symbol. Mit den Tasten  und  wählt man die Soll-Temperatur und das Datum der Abschaltung der Funktion aus. Das Abschalten erfolgt um 00.00 Uhr, des eingestellten Tages.

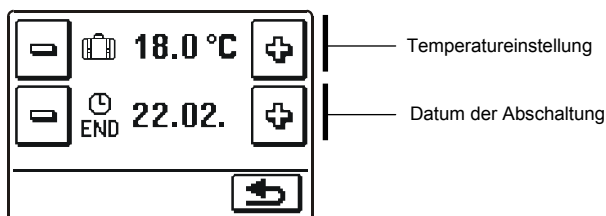

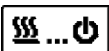



BETRIEBSARTENWAHL

Man kann zwischen sechs Arten des Reglerbetriebs auswählen.



Betrieb nach Zeitprogramm

Der Betrieb erfolgt nach Ablauf der gewählten Zeit-Programm. Wenn die Raumeinheit angeschlossen ist, wird das Symbol  angezeigt (Die Zahl sagt uns, welche Raumeinheit Auswirkungen auf den Heizkreis hat). Wenn der Regler ohne die Raumeinheit funktioniert zeigt er die Ikone  an.



Betrieb nach Tagestemperatur

Der Regler arbeitet in Hinsicht auf die Einstellung der Soll-Tagestemperatur.



Betrieb nach Nachttemperatur

Der Regler arbeitet in Hinsicht auf die Einstellung der Soll-Nachttemperatur.



Ausschalten des Reglers

Wählen wir aus wenn wir den Regler ausschalten wollen. Aktiv bleibt der Frostschutz wenn der Heizungs-Modus ausgewählt ist. Wenn der Kühlbetrieb ausgewählt ist, bleibt der Überhitzungsschutz aktiv.



Auswahl Raumheizung / Raumkühlung



Der Kühlbetrieb arbeitet thermostatisch an Hand der Gewünschten Raumtemperatur und mit der Konstanten Vorlauftemperatur.



Für den Kühlbetrieb muss ein Raumfühler oder eine Raumeinheit angeschlossen sein und das Zufuhrsystem für Kühlungswassers eingeschaltet.



Manueller Betrieb

Diese Betriebsart wird für das Testen des Heizsystems oder bei Störungen benutzt.

Eine neue Anzeige erscheint. Hier kann das Mischventil manuell geschlossen oder geöffnet werden und die Pumpe ein- oder ausgeschaltet werden.

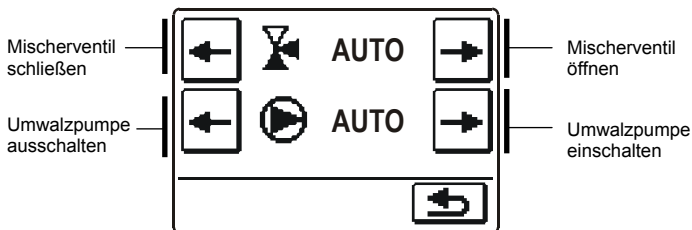

Mit der Taste  die Einstellung bestätigen und auf das vorige Display zurückblättern.



Zeitprogramm Auswählen

Zur Auswahl stehen Ihnen Vier, von einander unabhängige Zeitprogramme zur Verfügung.

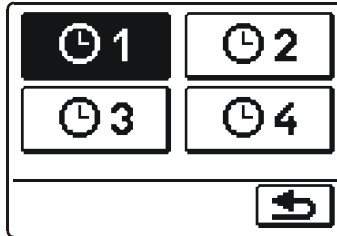

Nachdem man das gewünschte Zeitprogramm angewählt hat, bestätigt man es mit der Taste und blättert auf das vorige Display zurück.

Änderungen im Zeitprogramm

Um das Zeitprogramm zu ändern, muss man die Ikone zwei Mal drücken. Eine neue Anzeige erscheint:

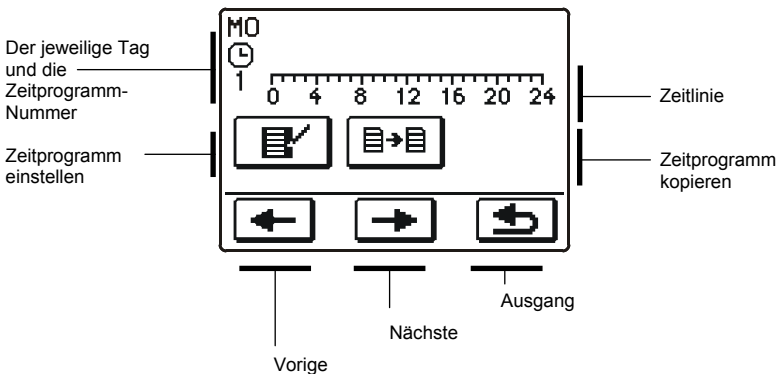

Erst mit den Tasten und den Tag, an dem die Veränderung im Zeitprogramm stattfinden soll anwählen oder den Tag in andere Wochentage kopieren.

Zeitprogramm einstellen

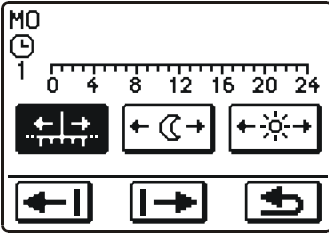

Die Bedeutung der Displaytaste ist wie folgt:



Freie Bewegung entlang der Zeitlinie



Darstellung des Heizintervalls auf der Nachttemperatur / Tagesintervall löschen



Darstellung des Heizintervalls auf der Tagestemperatur / Nachtintervall löschen



Bewegung nach links



Bewegung nach rechts



Auf das vorige Display zurückblättern und die Änderungen im Zeitprogramm speichern

Mit Hilfe der genannten Tasten wird der Verlauf des Zeitprogramms für den jeweiligen Tag dargestellt.

Zeitprogramm kopieren

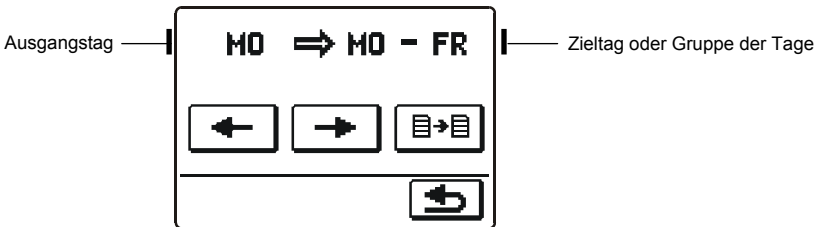

Die Bedeutung der Displaytasten ist wie folgt:



Die Wahl des Wochentages oder Gruppe der Tage (MO, DI, MI, DO, FR, SA, SO, MO-FR, MO-SO, SA-SO) in die man das Zeitprogramm des jeweiligen Tages kopieren möchte.



Kopieren

Werkseinstellungen der Zeitprogramme

🕒 1

Tag	Raumheizung in Betrieb
MO.-FR.	06:00 - 22:00
SA.-SO.	07:00 - 22:00

🕒 2

Tag	Raumheizung in Betrieb
MO.-FR.	05:00 - 7:30 13:30 - 22:00
SA.-SO.	07:00 - 22:00

🕒 3

Tag	Raumheizung in Betrieb
MO.-FR.	06:00 - 08:30 11:00 - 13:30 16:00 - 22:00
SA.-SO.	07:00 - 22:00

🕒 4

Tag	Raumheizung in Betrieb
MO.-FR.	14:00 - 22:00
SA.-SO.	07:00 - 22:00

DEU



GRUNDEINSTELLUNGEN

Das Menü dient zur Einstellung der Sprache, der Zeit und des Datums sowie der Einstellung des Displays.



Sprache

Die Soll- Sprache wird wie folgt eingestellt:

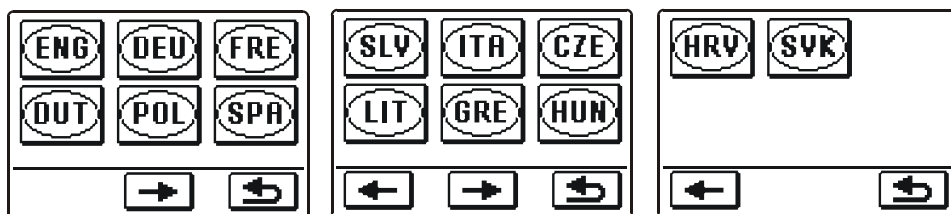

Mit den Tasten oder bewegt man sich durch die Displays mit den Sprachen.

Mit dem Drücken der Ikone wählt man die Soll-Sprache aus.

Die Wahl bestätigt man mit der Taste und blättert auf das vorige Display zurück.



Zeit und Datum

Die genaue Zeit und das genaue Datum wird wie folgt eingestellt:

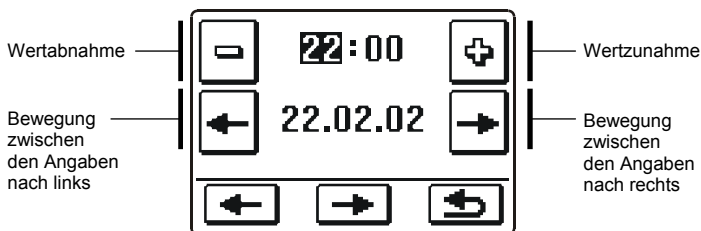

Die Einstellung bestätigt man mit der Taste und blättert auf das vorige Display zurück.



Display Einstellung

Ihnen stehen vier Einstellungsarten zur Verfügung:



Zeit der Aktiven (intensivere) Display Beleuchtung und Automatisches Verlassen des Menüs ins Hauptmenü.



Intensität der aktiven Displaybeleuchtung



Intensität der inaktiven Displaybeleuchtung



Kontrast

Die einzelne Einstellung wird mit den Tasten  und  Verändert. Die Einstellung bestätigt man mit der Taste  und blättert auf das vorige Display zurück.



DATEN KONTROLLE

Im Menü befinden sich Ikonen, die Ihnen einen Zugang zu den folgenden Betriebsarten des Reglers ermöglichen:

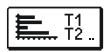

GRAPHISCHE DARSTELLUNGEN DER GEMESSENEN TEMPERATUREN FÜR DIE VERGANGENE WOCH

Detaillierte grafische Übersicht von Tages Fühlertemperaturen gemessen in der vergangenen Woche.

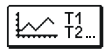

GRAPHISCHE DARSTELLUNGEN DER TEMPERATUREN DES AKTUELLEN TAGES



Detaillierte grafische Übersicht der einzelnen Temperaturen in einen Tag für alle Fühler. Wie oft die Temperaturen gespeichert werden, stellt man mit dem Parameter S1.5 ein. Solche Temperaturübersicht ist sinnvoll für die Analyse des Heizsystems, der Einstellung und Service.



SPEZIELLE WARTUNGSDATEN

Dienen zur Diagnostik bei Wartungsarbeiten.



Sie können sich zwischen graphischen Darstellungen der jeweiligen Fühler, mit drücken der tasten  bewegen. Mit drücken der Tasten  und  bewegen sie sich zwischen den Tagen im Graph.

WARTUNGSANLEITUNGEN

REGLERPARAMETER

Alle anderen Einstellungen und Anpassungen des Reglerbetriebes werden mit Hilfe der Reglerparameter ausgeführt. Im Menü stehen Ihnen 3 Gruppen zur Verfügung und zwar:



Grundparameter



Wartungsparameter



Estrichrocknung



Es werden nur die Parameter, die sich auf das Hydraulikschema auswirken angezeigt. Von dem gewählten Hydraulikschema hängen auch die Werte der Werkseinstellungen für die Parameter ab.



GRUNDPARAMETER

Die Grundparameter befinden sich in den Gruppen **P1** - Grundeinstellungen, **P2** - Mischerheizkreiseinstellungen, **P3** - Wärmequelleneinstellungen.

Inhalt der Grundparameter wird wie folgt angezeigt:

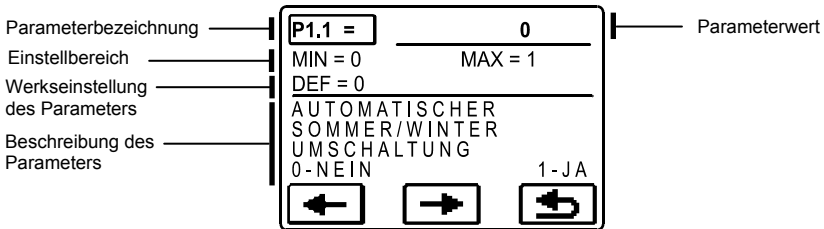

Die gewünschte Parameteränderung wird am unteren Beispiel am Parameter P1.1 gezeigt :

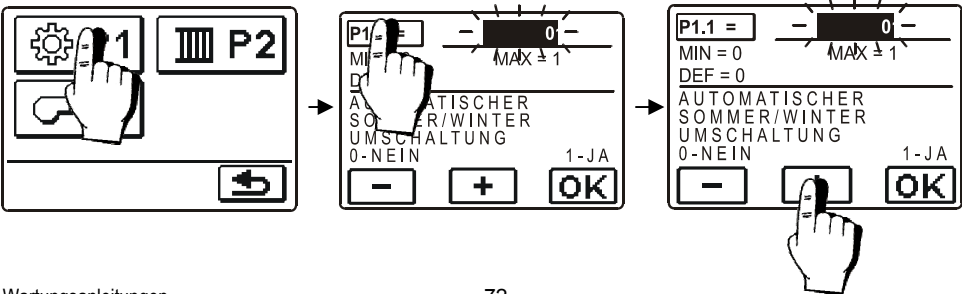

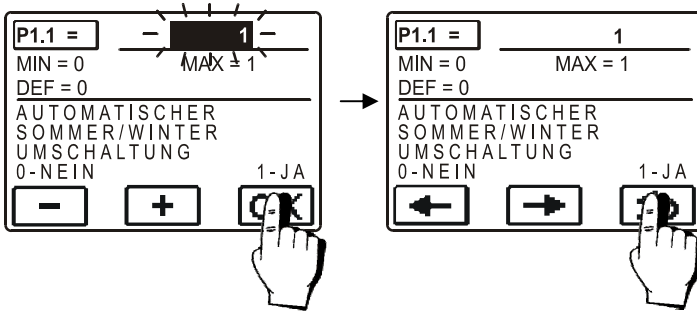

⚙️ P1 :

Grundeinstellungen

Parameter	Parameterbezeichnung	Beschreibung des Parameters	Einstellungsbereich	Übernommener Wert
P1.1	AUTOMATISCHER SOMMER/WINTER UMSCHALTUNG	Der Regler schaltet Heizung automatisch aus, wenn die durchschnittliche Eintagestemperatur höher ist als die eingestellte Umschalttemperatur.	0- NEIN 1- JA	1
P1.2	DURCHSCHNITTSAUSSEN-TEMPERATUR FÜR AUT. SOMMER-/WINTER UMSCHALTUNG	Einstellung der durchschnittlichen Ein-Tages-außen-Temperatur, bei der die Heizung automatisch abgeschaltet wird.	10 ÷ 30 °C	18
P1.4	GEWÜNSCHTE RAUMTEMPERATUR BEI FROSTSCHUTZ	Anwahl der gewünschten Raumtemperatur für den Zeitraum, wenn die Heizung ausgeschaltet ist.	2 ÷ 12 °C	6
P1.5	DARSTELL. DER TEMPERATURRUNDUNG	Bestimmung der Darstellung der Temperaturrundung der gemessenen Temperatur.	0- 0.1 °C 1- 0.2 °C 2- 0.5 °C 3- 1 °C	2
P1.6	AUTOMATISCHER ÜBERGANG DER UHR AUF SOMMER-/WINTERZEIT	Mit Hilfe des Kalenders, schaltet der Regler automatisch auf die Sommer- und Winterzeit um.	0- NEIN 1- JA	1
P1.7	AUFZEICHNUNGSPERIODE	Mit der Einstellung wird das Zeitintervall des Speicherns der gemessenen Temperaturen bestimmt.	1 - 30 min	5
P1.8	SIGNALTÖNE	Einstellung der Signaltöne des Reglers	0- AUS 1- TASTATUR	1
P1.9	FORTGESCHRITTENE DARSTELLUNG DER TEMPERATUREN	Fortgeschrittene Darstellung bedeutet, dass beim Durchblättern der Temperaturwerte die Ist- und Soll-Temperatur oder die ausgerechnete Temperatur angezeigt wird.	0- NEIN 1- JA	1

Mischerheizkreiseinstellungen

Parameter	Parameterbezeichnung	Beschreibung des Parameters	Einstellungsbereich	Übernommener Wert
P2.1	HEIZKURVESTEILHEIT	Die Steilheit der Heizkurve bestimmt, wie hoch an Hand der Außentemperatur die Temperatur der Heizkörper sein soll. Der Wert der Heizkurvensteilheit ist vor allem von der Art des Heizsystems abhängig (Fußboden-, Wand-, Radiator-, und Konvektorheizung) und von der Wärmedehnung des Gebäudes.	0,2 ÷ 2,2	0,7 - Fußboden 1,0 - Radiatoren
P2.2	PARALLELVERSCHIEBUNG DER HEIZKURVE	Einstellen der Parallelverschiebung der Heizkurve (die errechnete Vorlauftemperatur). <i>Das Einstellen dient der Aufhebung der Differenz zwischen gewünschter und Ist-Temperatur.</i>	-15 ÷ 15 K	0
P2.3	DAUER DER BOOST-HEIZUNG	Die Zeitdauereinstellung für die höhere gewünschte Raumtemperatur beim Übergang vom Nachttemperatur-Intervall auf das Tagestemperatur-Intervall.	0 ÷ 200 min	0
P2.4	RAUMTEMPERATURERHÖHUNG BEI BOOST-HEIZUNG	Das Einstellen der Temperaturhöhe für die höhere gewünschte Raumtemperatur beim Übergang vom Nachttemperatur-Intervall auf das Tagestemperatur-Intervall.	0 ÷ 8 K	4
P2.5	VORRANG DER BRAUCHWASSERERWÄRMUNG	Das Einstellen des Vorrangs der Brauchwassererwärmung bzw. der Raumheizung.	0- NEIN 1- JA	0

Wärmequelleneinstellungen

Parameter	Parameterbezeichnung	Beschreibung des Parameters	Einstellungsbereich	Übernommener Wert
S3.1	MINIMALE KESSELTEMPERATUR	Das Einstellen der minimalen Temperatur des Kessels.	10 ÷ 90 °C	40

HEIZKURVE

Die Steilheit der Heizkurve bestimmt, wie hoch an Hand der Außentemperatur die Temperatur der Heizkörper sein soll. Der Wert der Heizkurvensteilheit ist vor allem von der Art des Heizsystems abhängig (Fußboden-, Wand-, Radiator-, und Konvektorheizung) und von der Wärmedehnung des Gebäudes.

Bestimmung der Heizkurvensteilheit

Wenn genügend Daten zur Verfügung stehen, wird die Heizkurvensteilheit rechnerisch bestimmt, am sonstigen auf der Grundlage der Bemessungen des Heizsystems und der Wärmedämmung des Objekts.

Die Heizkurvensteilheit ist richtig eingestellt, wenn die Zimmertemperatur auch bei starken Schwankungen der Außentemperatur unverändert bleibt.

So lange die Außentemperatur über + 5 °C bleibt, wird die Zimmertemperatur mit der Veränderung der Einstellung der Tages- bzw. der Nachttemperatur geregelt oder mit der Parallel Verschiebung (Parameter P2.2).

Wenn es im Gebäude, bei niedrigeren Außentemperaturen kälter wird, ist die Steilheit zu niedrig und muss höher gesetzt werden.

Wenn es im Gebäude, bei niedrigeren Außentemperaturen wärmer wird, ist die Steilheit zu hoch und muss niedriger gesetzt werden.
 Die Schwankungen (hoch und niedrig) der Steilheit sollten nicht größer als 0,1 bis 0,2 Einheiten auf Beobachtungsintervall sein. Der Zeitabstand zwischen den Beobachtungen sollte mindestens 24 Stunden oder mehr betragen.

Wert der Steilheit der Heizkurve im Normalfall:

Heizsystem:	Einstellungsbereich:
Fußboden	0,2 - 0,8
Wand	0,6 - 1,0
Radiator	0,8 - 1,4



Mit der Einstellung der Heizkurve wird der Regler dem zu regulierenden Objekt angepasst. Die richtige Einstellung der Heizkurvensteilheit ist von großer Bedeutung für optimale Reglerfähigkeit.

Heizkurvendiagramm

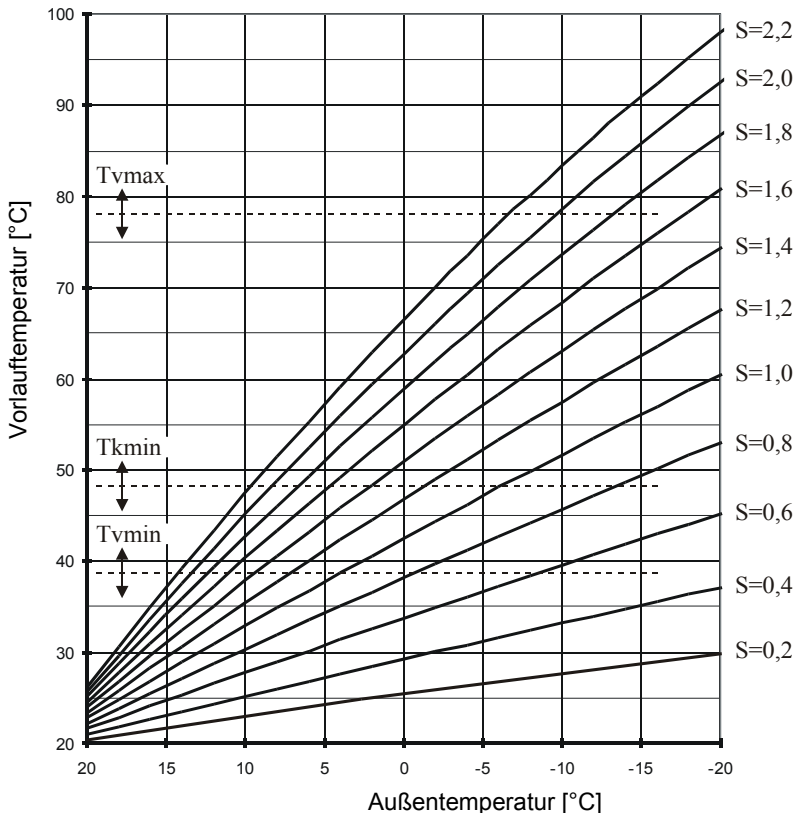



WARTUNGSPARAMETER

In Wartungsparameter befinden sich in den Gruppen **P1** - Grundeinstellungen, **P2** - Mischerheizkreiseinstellungen, **P3** - Wärmequelleneinstellungen.

Der Inhalt der Wartungsparameter wird wie folgt ausgeschrieben:

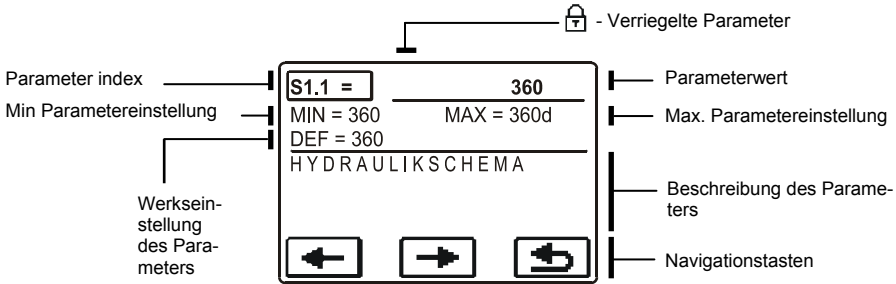

Die gewünschten Parametern werden Geändert in der gleichen Weise wie die Grundeinstellung (P). Wartungsparameter sind gesperrt und müssen vor dem Ändern des Codes entsperrt werden.

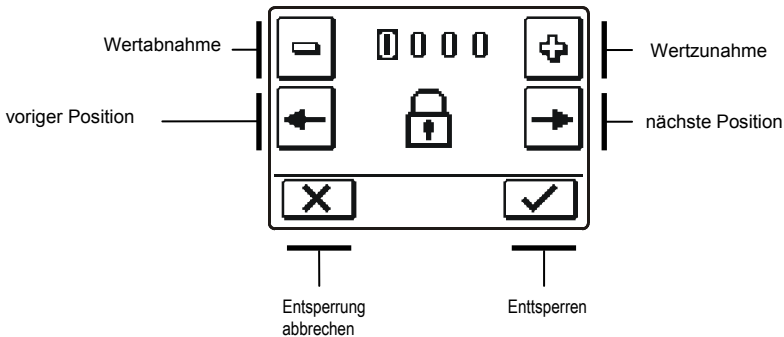

Die Werkseinstellung des Codes, für aufschließen der Service Parameter, ist 0001.

Grundeinstellungen



Parameter	Parameterbezeichnung	Beschreibung des Parameters	Einstellungsbereich	Übernommener Wert
S1.1	HYDRAULIKSCHEMA	Auswahl des gewünschten Hydraulikschemas.	360 ÷ 360d	360
S1.2	ENTSPERRKODE FÜR AUFSCHLISSUNG DER WARTUNGSEINSTELLUNGEN	Die Einstellung ermöglicht eine Veränderung des Codes, notwendig für die Aufschlüsselung der Wartungseinstellungen. ACHTUNG! Den neuen Code sorgfältig aufbewahren, da ohne den Code keine Veränderung der Wartungseinstellungen möglich ist.	0000 ÷ 9999	0001
S1.3	TEMPERATURFÜHLERTYP	Den Temperaturfühlertyp Pt1000 oder KTY10 anwählen.	0- PT1000 1- KTY10	0
S1.4	DREHRICHTUNG DES STELLMOTORS	Einstellen der Drehrichtung des Stellmotors, die das Öffnen des Mischventils bewirkt.	0- RECHTS 1- LINKS	0
S1.5	DISPLAYDREHUNG	Das Einstellen der Displaydrehung.	0- NORMAL 0° 1- DREHUNG 180°	0
S1.6	AUSWAHL DER FÜHLERFUNKTION T1	Mit der Funktion wählt man die Betriebsart des Fühlers T1. Wenn Sie den Rücklauffühler Auswählen, stellen Sie mit dem Parameter S2.13 die maximale Differenz zwischen Vorlauf und Rücklauf.	0- RAUMFÜHLER 1- RÜCKLAUFFÜHLER	0
S1.7	AUSWAHL DER FÜHLERFUNKTION T4	Mit der Funktion wählt man die Betriebsart des Fühlers T4. Wenn Sie den Rücklauffühler Auswählen, stellen Sie mit dem Parameter S2.13 die maximale Differenz zwischen Vorlauf und Rücklauf.	0- KESSELFÜHLER 1- RÜCKLAUFFÜHLER	0
S1.8	FERNSCHALTUNG BEI BUS-VERBINDUNGEN	Hier wählt man an, ob bei der Fernschaltung nur die lokale Fernschaltung berücksichtigt wird oder ob auch die Fernschaltung des Hauptreglers berücksichtigt wird.	1- LOKAL 2- MIT BUS	1
S1.9	ANTIBLOKIERFUNKTION FÜR PUMPE UND VENTIL	Wenn über die Woche keiner der Relaisausgänge eingeschaltet wurde, schaltet sich die am Freitag um 20.00 Uhr, für die Dauer von 60 s, selbständig ein.	0- AUS 1- EIN	0
S1.17	FÜHLERABGLEICH T1	Abweichung bei dem angezeigten, gemessenen Temperaturwert des Fühlers T1, kann hier nachkorrigiert werden.	-5 ÷ 5 K	0
S1.18	FÜHLERABGLEICH T2	Abweichung bei dem angezeigten, gemessenen Temperaturwert des Fühlers T2, kann hier nachkorrigiert werden.	-5 ÷ 5 K	0
S1.19	FÜHLERABGLEICH T3	Abweichung bei dem angezeigten, gemessenen Temperaturwert des Fühlers T3, kann hier nachkorrigiert werden.	-5 ÷ 5 K	0
S1.20	FÜHLERABGLEICH T4	Abweichung bei dem angezeigten, gemessenen Temperaturwert des Fühlers T4, kann hier nachkorrigiert werden.	-5 ÷ 5 K	0

DEU

Mischerheizkreiseinstellungen



Parameter	Parameterbezeichnung	Beschreibung des Parameters	Einstellungsbereich	Übernommener Wert
S2.1	AUSWIRKUNG DER RAUMTEMPERATUR	Einstellen der Auswirkung der Raumtemperaturabweichung auf die errechnete Vorlauftemperatur. Niedrige Werte bedeuten eine Kleinere Auswirkungen und höhere Werte stärkere Auswirkungen auf den Regler.	0,0 ÷ 3,0	1
S2.2	T1 RAUMFÜHLEREINFLUSS	Mit der Einstellung bestimmen wir ob der Fühler auf die Funktionsweise des Reglers Einfluss hat. Diese Funktion hat nur Bedeutung wenn mit dem Parameter S1.6 der Raumfühler ausgewählt ist. (S1.6=0)	1- JA 2- NEIN	1
S2.3	DD2+ FÜHLEREINFLUSS	Mit der Funktion stellen wir ein, ob der Fühler der Raumeinheit Einfluss auf den Betrieb des Reglers hat. #1 Einfluss hat nur der Fühler der ersten Raumeinheit #2 Einfluss hat nur der Fühler der zweiten Raumeinheit #1&2 Fühler der ersten und der zweiten Raumeinheit haben Einfluss AUTO bedeutet, das Einfluss der Fühler der Raumeinheit hat, der dem Heizkreis steuert	1 - AUTO 2 - #1 3 - #2 4 - #1&2 5 - NEIN	1
S2.4	BETRIEBSART DER UMWÄLZPUMPE	Einstellung der Betriebsart der Umwälzpumpe. Einstellungen haben folgende Bedeutung: 1- STAND. (Umwälzpumpe Mischkreis - Standard) 2- P1 (Arbeitet nach Zeitprogramm P1) 3- P2 (Arbeitet nach Zeitprogramm P1 P2) 4- P3 (Arbeitet nach Zeitprogramm P1 P3) 5- P4 (Arbeitet nach Zeitprogramm P1 P4) 6-GEW. PROG. (Arbeitet nach dem Ausgewählten Zeitprogramm)	1- STAN. 2- P1 3- P2 4- P3 5- P4 6-GEW. PROG.	1
S2.5	MINIMALE VORLAUFTEMPERATUR	Das Einstellen der Begrenzung der minimalen Vorlauftemperatur.	10 ÷ 90 °C	20
S2.6	MAXIMALE VORLAUFTEMPERATUR	Das Einstellen der Begrenzung der maximalen Vorlauftemperatur.	20 ÷ 150 °C	45 - Fußboden 85 - Radiator
S2.7	STILLSTAND DES MISC-HVENTILREGELUNG	Das Einstellen des Abweichungsbereichs der Vorlauftemperatur, bei der die Mischventilregelung still steht bzw. inaktiv ist.	1,0 ÷ 3,0 K	1
S2.8	P -KONSTANTE MISC-HVENTIL	Die Einstellung legt fest, wie Intensiv der Regler die Stellung des Mischers korrigiert. Ein Niedriger Wert bedeutet kürzere Verschiebungen, ein größerer Wert bedeutet Längere Verschiebungen	0,5 ÷ 2,0	1
S2.9	I -KONSTANTE MISC-HVENTIL	Die Einstellung legt fest, wie oft der Regler die Stellung des Mischers korrigiert. Ein niedrigerer Wert bedeutet eine seltener und ein höherer Wert eine häufigere Korrektur der Lage des Mischers.	0,4 ÷ 2,5	1
S2.10	D -KONSTANTE MISC-HVENTIL	Das Einstellen der Auswirkungsintensität der Vorlauftemperaturänderung auf die Funktion des Mischventilreglers.	0,4 ÷ 2,5	1
S2.11	MINIMALE VORLAUFTEMPERATUR FÜR KÜHLUNG	Das Einstellen der minimalen Vorlauftemperatur für die Kühlung. ACHTUNG! Eine zu niedrige Temperatur kann Kondensbildung an Heizkörpern und Rohrleitungen verursachen.	10 ÷ 20 °C	15
S2.12	AUSSCHALTPUNKTVERSCHIEBUNG DER HEIZUNG	Einstellen der Verschiebung der errechneten Vorlauftemperatur, bei der die Heizung ausgeschaltet wird.	-10 ÷ 10 °c	0

Parameter	Parameterbezeichnung	Beschreibung des Parameters	Einstellungsbereich	Übernommener Wert
S2.13	DIFFERENZBESCHRÄNK. ZWISCHEN VORLAUF UND RÜCKLAUF	Das Einstellen der maximalen erlaubten Differenz zwischen Vorlauf und Rücklaufleitung. Auf diese Weise wird die maximale Leistung des Heizkreises begrenzt.	3 ÷ 30 K	10
S2.14	KONSTANT VORLAUF-TEMPERATUR	Hier wählt man die Konstante Regelung der Vorlauftemperatur aus. Der Einstellungsbereich der Konstanten Temperatur ist 10 ÷ 140 °C. VORSICHT: Durch diese Funktion wird die Regelung in Abhängigkeit von der Außentemperatur aufgehoben.	0- NEIN 1- JA	0
S2.15	AUSSCHALTVERZÖGERUNG DER UMWÄLZPUMPE (MINUTEN)	Mit der Einstellung stellen sie die Ausschaltverzögerung der Umwälzpumpe ein, wenn es keine Heizungsanforderung gibt.	0 ÷ 10 Min	5



Wärmequelleneinstellungen :

Parameter	Parameterbezeichnung	Beschreibung des Parameters	Einstellungsbereich	Übernommener Wert
S3.1	MAXIMALE KESSELTEMPERATUR	Das Einstellen der maximalen Kesseltemperatur.	60 ÷ 160 °C	90
S3.2	KESSELTEMPERATURERHÖHUNG WEGEN MISCHHEIZKREIS	Das Einstellen des Wertes, um den die Kesseltemperatur höher sein soll als die errechnete Vorlauftemperatur.	0 ÷ 25 K	5



DIE PARAMETER DER ESTRICHTROCKNUNG

In der F1-Gruppe, sind die Parameter zur Einstellung der Estrichrocknung.



Das Verfahren zur Einstellung der Parameter, ist der gleiche wie für die Wartungsparameter (siehe Seite 76).

Trocknen des Estrichs :

Parameter	Parameterbezeichnung	Einstellungsbereich	Übernommener Wert
F1.1	AKTIVIEREN DER ESTRICHTROCKNUNG	0- NEIN 1- JA	0
F1.2	INTERVALL 1: DAUER	1 ÷ 15 Tage	10
F1.3	INTERVALL 1: START-TEMPERATUR	10 ÷ 60 °C	20
F1.4	INTERVALL 1: END-TEMPERATUR	10 ÷ 60 °C	20
F1.5	INTERVALL 2: DAUER	1 ÷ 15 Tage	5
F1.6	INTERVALL 2: START-TEMPERATUR	10 ÷ 60 °C	20
F1.7	INTERVALL 2: END-TEMPERATUR	10 ÷ 60 °C	50
F1.8	INTERVALL 3: DAUER	1 ÷ 15 Tage	10
F1.9	INTERVALL 3: START-TEMPERATUR	10 ÷ 60 °C	50
F1.10	INTERVALL 3: END-TEMPERATUR	10 ÷ 60 °C	50
F1.11	INTERVALL 4: DAUER	1 ÷ 15 Tage	5
F1.12	INTERVALL 4: START-TEMPERATUR	10 ÷ 60 °C	50
F1.13	INTERVALL 4: END-TEMPERATUR	10 ÷ 60 °C	20

Trocknen des Estrichs - Werkseinstellungen:

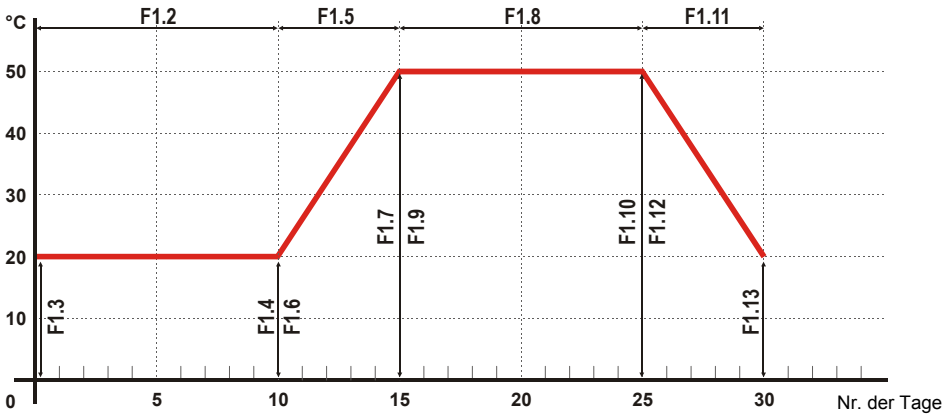

WERKSEINSTELLUNGEN

Im Menü befinden sich Softwarewerkzeuge, für leichteres Einstellen des Reglers. Ihnen stehen fünf Befehle zur Verfügung:



RESET DER REGLER PARAMETER

Stellt alle Parametereinstellungen P1, P2, P3, S1 (außer S1.1), S2, S3 und F auf Werkseinstellungen zurück.



RESET DER ZEITPROGRAMME

Stellt alle Zeitprogramme auf die Werkseinstellungen.



RESET DES REGLERS UND ERNEUTER START DER REGLEREINSTELLUNG BEI DER ERSTEN INBETRIEBNAHME

Setzt den Regler auf die Werkseinstellungen und aktiviert die Anfangsprozedur.



SPEICHERN DER BENUTZEREINSTELLUNGEN

Speichert alle Eingestellten Werte des Reglers als Benutzereinstellungen.



BENUTZEREINSTELLUNGEN LADEN

Lädt die vorher gespeicherten Benutzereinstellungen.

MONTAGEANLEITUNGEN

MONTAGE DES REGLERS

Montieren Sie den Regler in einen inneren trockenen Ort, wo er keinem starken elektromagnetischen Feld ausgesetzt sein wird. Den Regler direkt auf das Mischerventil montieren. Dazu braucht und darf man den Regler nicht auseinandernehmen oder öffnen.

MONTAGE AUF DAS MISCHERVENTIL

Die Montageart, die unten dargestellt wird, gilt für Mischerventile der folgenden Hersteller: Esbe, Seltron, Somatherm, Acaso, Ivar, Wip, Paw, BRV, Imit, Hora, Barberi, Olymp, Hoval.

DEU

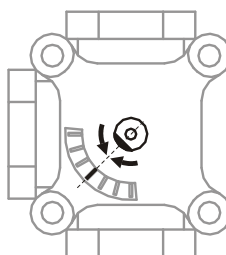
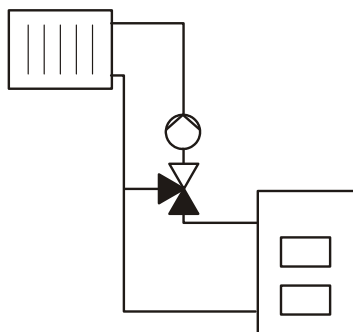

1a

Beispiel der Montage auf das Dreiwegventil.

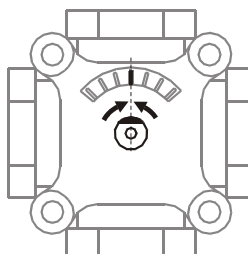
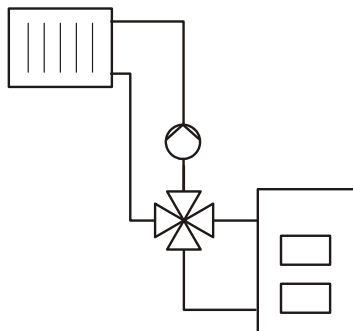

1b

Beispiel der Montage auf das Vierwegventil.



Das Mischerventil in die mittlere Lage drehen.

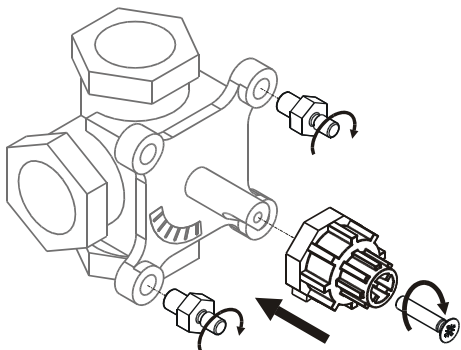

Beispiel:
Montagebeispiel auf das Dreiwegventil.

2a

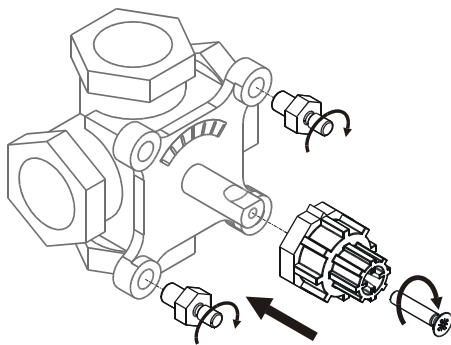

Beispiel:
Montagebeispiel auf das Vierwegventil.

2b

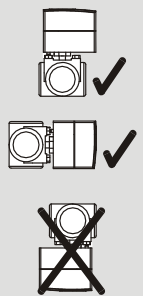
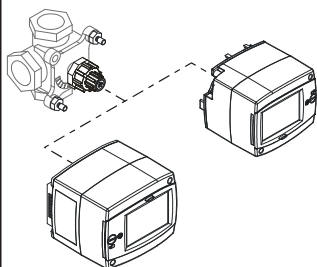
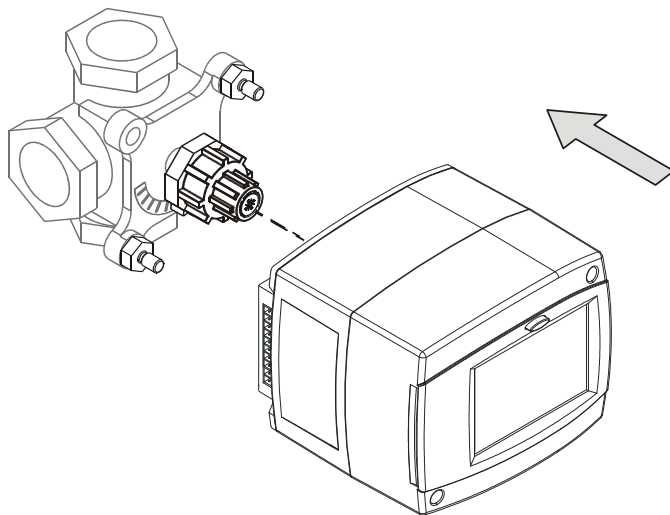

3

ELEKTRISCHES ANSCHLUSS DES REGLERS



Die Zeichnungen und die Texte in der vorliegenden Anleitung haben lediglich Beispielcharakter, für die der Herausgeber keine Verantwortung übernimmt. Benutzen Sie in diesen Anleitungen vermittelte Inhalte, geschieht dies auf das eigene Risiko und Sie tragen die Verantwortung. Der Herausgeber haftet nicht für unsachgemäße, unvollständige und falsche Angaben und die daraus resultierende Schäden werden grundsätzlich ausgeschlossen. Alle Rechte vorbehalten. Technische Änderungen und Irrtümer und das Recht auf Veränderung vorbehalten.

Der Anschluss des Reglers soll nur vom qualifizierten Fachpersonal oder einem bevollmächtigten Industriebetrieb durchgeführt werden. Bevor in die Verdrahtung gegriffen wird, sicherstellen, dass der Hauptschalter ausgeschaltet ist. Beachten Sie die Vorschriften für Niederspannungsinstallationen IEC 60364 und VDE 0100, sowie auch gesetzliche Regeln und Vorschriften der Verhütung vor Berufsunfällen, Vorschriften im Umweltschutz und sonstige nationalen Vorschriften.

Das Nichtbeachten der Anweisungen kann Personenschäden, wie Verbrennungen zu Folge haben und kann Lebensgefährten sein.

ANSCHLÜSSE FÜR DIE STROMVERSORGUNG

Netzverbindungen sind schon eingebaut. Das Zufuhrkabel der Stromversorgung hat einen Erdungsstecker für eine Netzspannung von 230 V~. Der zweite Netzkabel dient dem Anschluss der Umwälzpumpe.

ANSCHLÜSSE FÜR FÜHLER , RAUMEINHEITEN UND BUS

Layout der Anschlüsse ist im Bild dargestellt.

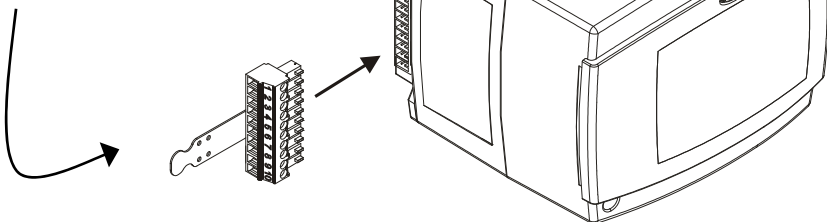
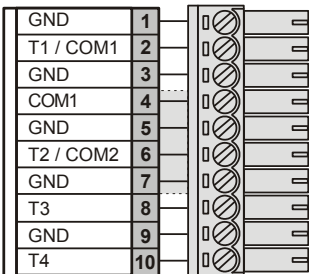

ANSCHLUSS DER RAUMEINHEIT DD2 +

Mit der Raumeinheit messen wir die Raumtemperatur, stellen die Tag und Nacht Temperatur ein und wählen die Betriebsart aus. Auf ein Steuergerät können bis maximal zwei Raumeinheiten angeschlossen werden. Bevor Sie die Raumeinheit anschließen, ist eine Einstellung der Kodier Schalter auf der Rückseite der Raumeinheit notwendig.



NOTWENDIGE
EINSTELLUNG



Die Raumeinheit steuert
den Heizkreis.



Die Raumeinheit steuert
den Heizkreis nicht.



Die erste Raumeinheit (#1).



Die zweite Raumeinheit (#2).

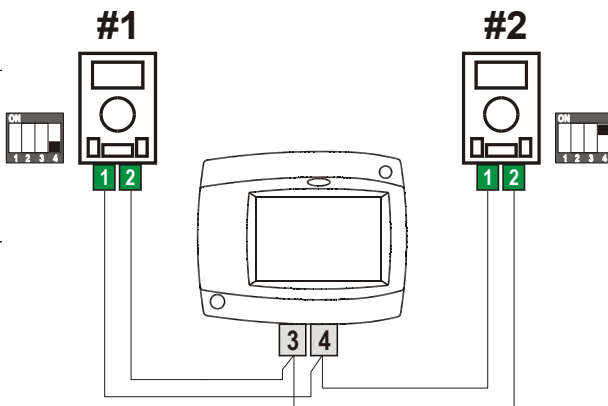

Der Einfluss des eingebauten Temperaturfühlers der DD2+, wird unabhängig von den Kodier-Schaltern eingestellt. Siehe S2.3 Parameter-Einstellung.

ANSCHLUSS DES RAUMFÜHLERS

Der Raumfühler wird für das Messen der Raumtemperatur verwendet genau wie der Fühler der digitalen Raumeinheit DD2+. Dies verbessert die Regelung der gewünschten Raumtemperatur. Für das Funktionieren des Reglers ist der Raumfühler nicht notwendig. Beim Anschluss des Raumfühlers müssen Sie den Parameter S1.6=0 einstellen.

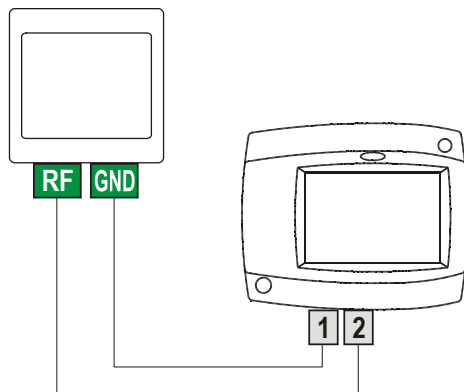

Anschluss des Raumfühlers ist möglich nur bei Schemen 360 und 360b.

MONTAGEBESCHREIBUNG UND TEMPERATURFÜHLERBEZEICHNUNG

Außentemperaturfühler

Den Außentemperaturfühler an nördliche oder nordöstliche Fassade, ca. 2 Meter hoch montieren. Eine Montage oberhalb der Fenstern oder Entlüfter ist nicht erlaubt. Zuerst den Schutzdeckel abnehmen und dann die zwei Befestigungsschrauben entfernen. Mit der beigelegten Wandschraube den Fühler an der vorgesehenen Stelle einschrauben. Den Kabel durch die Einführung von unten einführen und anschließen.

Anlegetemperaturfühler

Den Fühler VF an Vorlaufleitung über die Umwälzpumpe bzw. hinter den Mischventil montieren. Die Leitung an der ausgesuchten Stelle gut reinigen. Den Fühler darauf stellen und mit der beigefügten Rohrschelle befestigen.

Tauchtemperaturfühler

Bei der Montage achten, dass der Fühler tief genug in der Hülse steckt. Gegen Bewegung wird der Fühler mit Klemme und Schraube gesichert.

Raumfühler oder Raumeinheit

Die Raumeinheit an die Innenwand des Wohnzimmers befestigen. Dazu suchen Sie sich die schattige Wand aus, die von jeglicher Wärmequelle oder Durchzug entfernt ist. Zuerst den Schutzdeckel abnehmen, dann den Sockel an die vorgesehene Stelle, ca. 1,5 Meter über Fußboden, montieren. Der Fühler kann auch an eine Standard-Unterputzdose oder direkt an die Wand montiert werden. Für den elektrischen Anschluss brauchen Sie einen zweiadrigen Signalkabel. Falls im Raum in dem sich die Raumeinheit befindet, an Heizungskörper Thermostatventile eingebaut sind, müssen die geöffnet sein.

TABELLE: Widerstand der Temperaturfühler des Typs Pt1000

Temperatur [°C]	Widerstand [Ω]	Temperatur [°C]	Widerstand [Ω]	Temperatur [°C]	Widerstand [Ω]	Temperatur [°C]	Widerstand [Ω]
-20	922	35	1136	90	1347	145	1555
-15	941	40	1155	95	1366	150	1573
-10	961	45	1175	100	1385	155	1592
-5	980	50	1194	105	1404	160	1611
0	1000	55	1213	110	1423	165	1629
5	1020	60	1232	115	1442	170	1648
10	1039	65	1252	120	1461	175	1666
15	1058	70	1271	125	1480	180	1685
20	1078	75	1290	130	1498	185	1703
25	1097	80	1309	135	1415	190	1722
30	1117	85	1328	140	1536	195	1740

BETRIEBSBESCHREIBUNG BEI FÜHLERSTÖRUNG

Wenn einer der Temperaturfühler ausfällt, dann justiert sich der Regler auf den verwendbarsten Betriebsmodus:

Außentemperaturfühler ist Außerbetrieb oder Defekt

Der Regler funktioniert in dem Fall als P-Regler in Hinsicht auf die Raumtemperaturabweichung. Wenn der Raumtemperaturfühler auch beschädigt ist, wird die Vorlauftemperatur mit konstanter Temperatur reguliert, die bei:

- Radiatorheizung 25 °C mehr als eingestellte Tages bzw. Nachttemperatur ist
- Fußbodenheizung 10 °C mehr als eingestellte Tages bzw. Nachttemperatur ist

Vorlauftemperaturfühler ist Außerbetrieb oder Defekt

Der Regler erkennt, dass die Vorlauftemperatur 120 °C beträgt und schaltet die Raumheizung aus. Die Heizung kann nur noch manuell weiter betrieben werden.

Raumtemperaturfühler ist Außerbetrieb oder Defekt

Der Regler funktioniert normal, in Abhängigkeit von der Außentemperatur.

Rücklaufauftemperaturfühler ist Außerbetrieb oder Defekt

Die Raumheizung funktioniert normal ohne Differenzbeschränkung zwischen Vor- und Rücklauf.

Kesseltemperaturfühler ist Außerbetrieb oder Defekt

Die Steuerung übernimmt eine 85 °C Kesseltemperatur und funktioniert normal.

SYSTEMERWEITERUNG AUF MEHRERE HEIZKREISE

BUS-Verbindung der CMP25-2 Regler:

Mit der Bus-Verbindung können Sie eine beliebige Anzahl von CMP25-2 Reglern miteinander verbinden.

Wichtig: *Der Außen-Temperaturfühler und der Kesseltemperaturfühler werden immer an den letzten untergeordneten Regler Angeschlossen.*

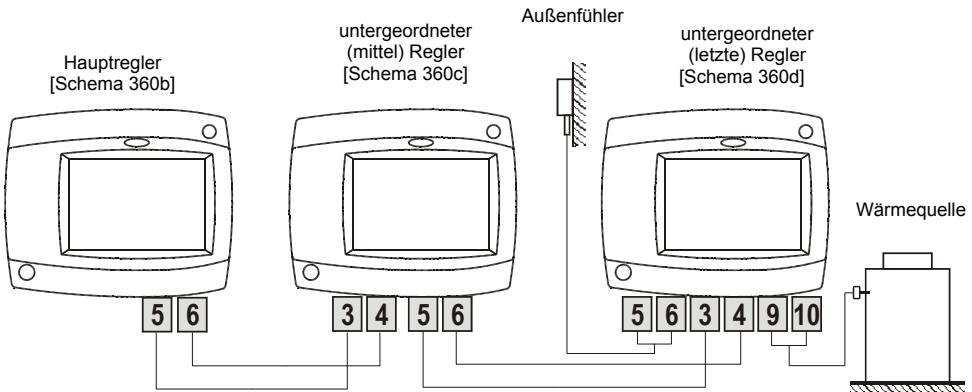

BUS-Verbindung zwischen CMP25-2 und WDC10B, WDC10 oder WDC20 Reglern:

Mit der Bus-Verbindung können Sie eine beliebige Anzahl von WDC und CMP25-2 Reglern miteinander verbinden. Der Hauptregler WDC steuert die Wärmequellen, während die anderen nur die Heizkreise steuern.

Wichtig: Der Aussen-Temperaturfühler und der Kesseltemperaturfühler werden immer an den Hauptregler Angeschlossen.

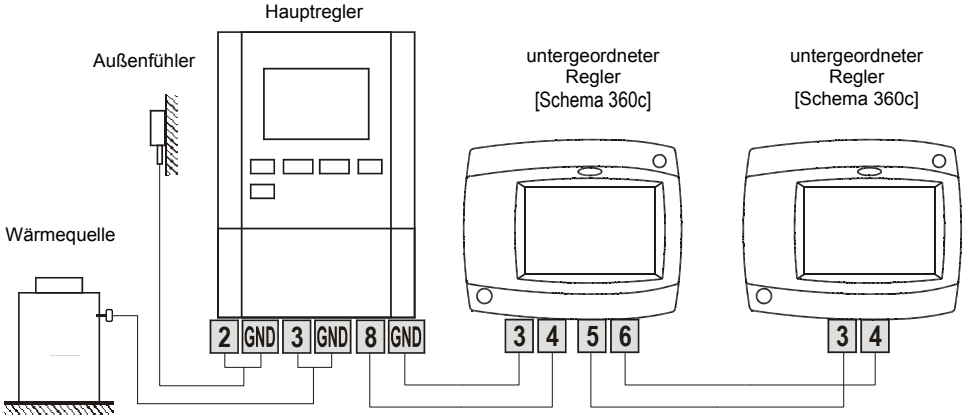

BUS-Verbindung zwischen CMP25-2 und D10, D20 Reglern:

Mit der Bus-Verbindung können Sie eine beliebige Anzahl von D10, D20 und CMP25-2 Reglern miteinander verbinden. Der Hauptregler D10 oder D20 steuert die Wärmequellen, während die anderen nur die Heizkreise steuern.

Wichtig: Der Aussen-Temperaturfühler und der Kesseltemperaturfühler werden immer an den Hauptregler Angeschlossen.

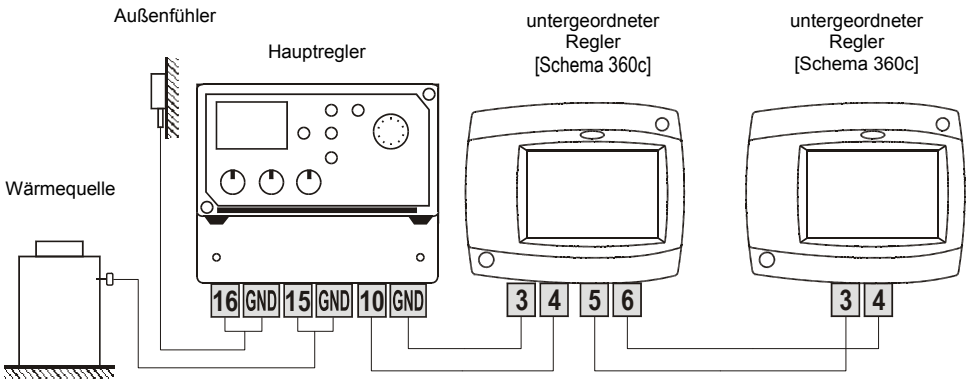

WICHTIG

BEMERKUNG: Die gesamten Netzverbindungen sind am N und \perp verbunden.

ACHTUNG: Die Installationsschemas verweisen auf den Betriebsprinzip und verfügen nicht über alle Hilfs- oder Sicherheitselemente. Bei der Montage die gültigen Vorschriften beachten!

----- Optional Fühler. Für das Funktionieren der Regelung nicht erforderlich.



Anschließung eines Raumfühlers oder einer Raumeinheit ist für den Betrieb des Reglers nicht erforderlich. Anschluss des Raumfühlers und der Raumeinheit ist auf den Seiten 83 bis 84 beschrieben.

Schema 360
Alleinstehender
Mischerheizkreis

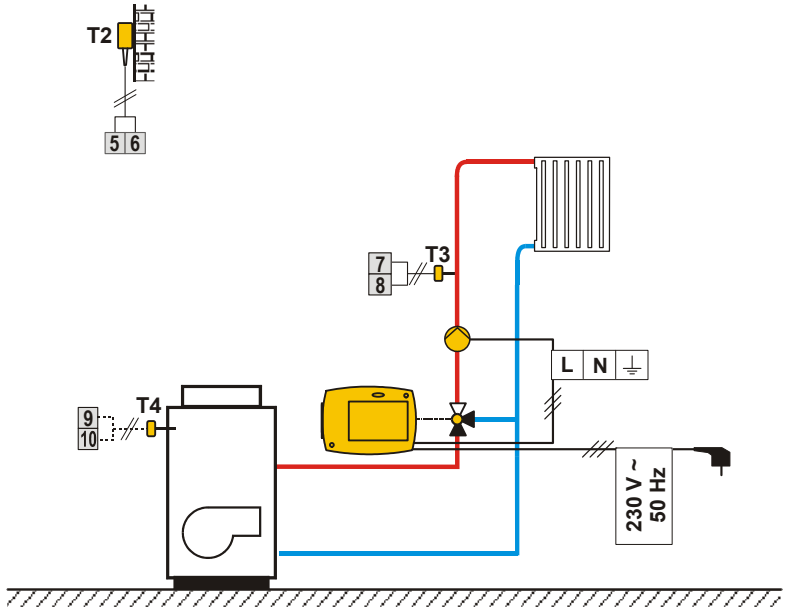

DEU

Schema 360b
Mischerheizkreis,
(führender Regler
in bus Verbindung)

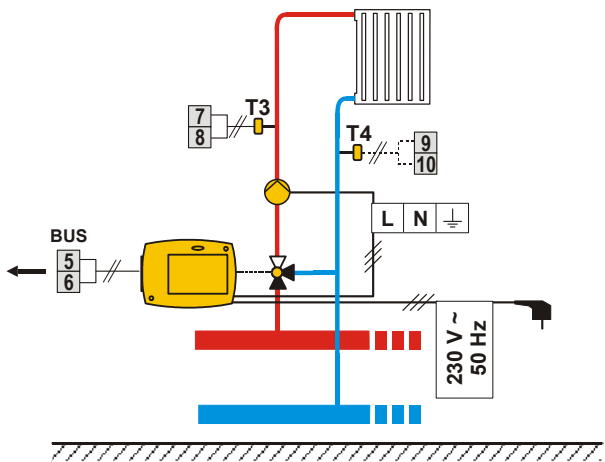

*BUS Verbindung der
Regler ist auf den Seiten
86 und 87 beschrieben.*

Schema 360c -
Mischerheizkreis,
untergeordneter
(mittel) Regler in
bus Verbindung

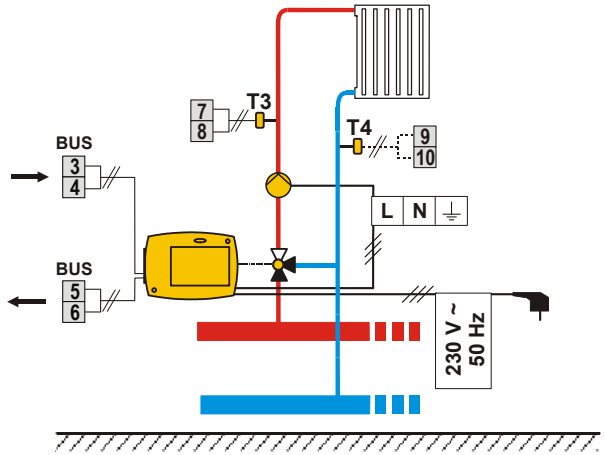

i BUS Verbindung der
Regler ist auf den Seiten
86 und 87 beschrieben.

Schema 360d -
Mischerheizkreis,
unabhängig ge-
steuerte Wärme-
quelle, unterge-
ordneter (letzte)
Regler in bus
Verbindung

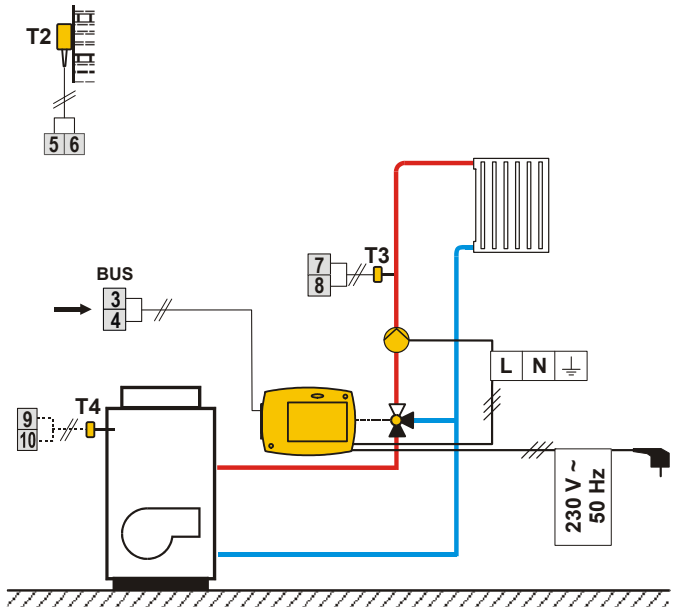

i BUS Verbindung der
Regler ist auf den
Seiten 86 und 87
beschrieben.

Allgemeine technische Daten

Stromversorgung	230 V ~ , 50 Hz,
Leistungsaufnahme	Max. 4 VA
Pumpenausgang	230 V ~ / 4 (2) A
Reglergehäuse	ABS -Thermoplast
Dimensionen (B x H x T):	84 × 105 × 100 mm
Gewicht	900 g ÷ 950 g
Farbe/ Material	dunkelgrau / PC
Schutzart	IP42 gem. EN 60529
Schutzklasse	II gem. EN 60730-1
Betriebsartyp	Typ 1B gem. EN 60730-1
Umgebungstemperatur	0 bis +40 °C
Umgebungstemperatur bei der Lagerung.....	-20 bis +70 °C

Technische Daten

Einstellungsbereich der Tagestemperatur:	10 °C ÷ 30 °C
Einstellungsbereich der Nachttemperatur:	10 °C ÷ 30 °C
Einstellungsbereich der Heizkurvensteilheit:	0.2 ÷ 2.2
Frostschutztemperatur:	+ 6 °C (einstellbar)
Breite der Totlage für Regler PI:	± 0.7 K ÷ ± 1.5 K
Temperaturfühlerartyp:	Pt1000 oder KTY10
Programmuhr:	Programmuhr mit mehreren Kanälen

DEU

ERKLÄRUNGEN

CE - KONFORMITÄTSERKLÄRUNG

Der Kompaktregler PROMATIC CMP25-2 entspricht folgenden Richtlinien und Normen:

- EU-Niederspannungsrichtlinie (LVD) 2006/95/EC,
- EU-Richtlinie für Elektromagnetische Verträglichkeit (EMC) 2004/108/EEC,
- EU-Richtlinie Elektro- und Elektronikschrott, Stoffverbote (RoHS) 2002/95/EC.

PRODUKT BESCHREIBUNG:

Witterungsgeführte Regler

MODEL:

CMP25-2

ANGEWANDTE NORMEN:

EN 60730-1, EN 60730-2-9, EN 60730-2-11,
EN 60730-2-14, EN12098-1, EN61000-6-1, EN55014-1.



ENTSORGUNG VON GEBRAUCHTEN ELEKTRISCHEN UND ELEKTRONISCHEN GERÄTEN

Entsorgung von gebrauchten elektrischen und elektronischen Geräten

(Anzuwenden in den Ländern der Europäischen Union und anderen europäischen Ländern mit einem separaten Sammelsystem für diese Geräte).



Das Symbol auf dem Produkt oder seiner Verpackung weist darauf hin, dass dieses Produkt nicht als normaler Haushaltsabfall zu behandeln ist, sondern an einer Annahmestelle für das Recycling von elektrischen und elektronischen Geräten abgegeben werden muss. Durch Ihren Beitrag zum korrekten Entsorgen dieses Produkts schützen Sie die Umwelt und die Gesundheit Ihrer Mitmenschen. Umwelt und Gesundheit werden durch falsches Entsorgen gefährdet. Materialrecycling hilft den Verbrauch von Rohstoffen zu verringern. Weitere Informationen über das Recycling dieses Produkts erhalten Sie von Ihrer Gemeinde, den kommunalen Entsorgungsbetrieben, oder dem Geschäft, in dem Sie das Produkt gekauft haben.

PROMATIC CMP25-2



INTRODUZIONE

I regolatori PROMATIC CMP25-2 sono moderni apparecchi controllati a microprocessore, realizzati secondo la tecnologia digitale ed SMT.

I regolatori sono destinati alla regolazione di sistemi di riscaldamento a termosifoni e a pannelli radianti. La regolazione avviene attraverso un circuito di riscaldamento miscelato. Per la programmazione oraria del riscaldamento dei locali viene installato un orologio multicanale digitale programmabile.

I regolatori PROMATIC CMP25-2 possono essere collegati in rete tra loro o con i regolatori Promatic D10, D20, WDC10B, WDC10 e WDC20, funzionando così come un sistema di regolazione unico per diversi circuiti di riscaldamento.



Per il primo avvio del regolatore si veda il capitolo CONFIGURAZIONE DEL REGOLATORE AL PRIMO AVVIO (pagina 97)!

CONTENUTO

ISTRUZIONI PER L'USO

DESCRIZIONE DEL REGOLATORE	96
Aspetto del regolatore PROMATIC CMP25-2	96
Indicazione di funzionamento	96

CONFIGURAZIONE DEL REGOLATORE AL PRIMO AVVIO.....	97
Configurazione delle impostazioni.....	97

DISPLAY LCD GRAFICO.....	99
Descrizione e aspetto dello schermo.....	99
Descrizione dei simboli visualizzati sul display.....	99
Simboli per la visualizzazione del funzionamento	99
Simboli per la visualizzazione delle funzioni impostate dall'utente.....	100
Simboli per la visualizzazione delle temperature e degli altri dati.....	100
Simboli per le funzioni impostate dall'utente	101
Simboli per la visualizzazione della comunicazione tra le apparecchiature collegate	101
Simboli per le comunicazioni e le avvertenze.....	101
Navigazione di base sul display	102
Blocco e sblocco del display	102
Schermo per l'aiuto, le comunicazioni e le avvertenze.....	103

ACCESSO E NAVIGAZIONE NEL MENÙ.....	104
Struttura e descrizione del menù.....	105
Impostazione delle temperature	108
Funzioni dell'utente	109
Modalità di funzionamento	110
Programmi orari.....	111
Impostazioni di base.....	114
Controllo dei dati	115

ISTRUZIONI PER LE IMPOSTAZIONI DI SERVIZIO

PARAMETRI DEL REGOLATORE.....	116
Parametri generali	116
Curva climatica.....	118
Parametri di servizio.....	120
Parametri per l'asciugatura del massetto	123
Impostazioni di fabbrica.....	124

ISTRUZIONI PER L'INSTALLAZIONE

INSTALLAZIONE DEL REGOLATORE	125
Installazione sulla valvola di miscelazione	125
Allacciamento elettrico del regolatore.....	127
Adattatori per tensioni di rete	127
Adattatori per sensori e connessione BUS.....	127
Allacciamento dell'unità digitale interna DD2+	128
Allacciamento del sensore da interno.....	128
Modalità di installazione e indicazione dei sensori di temperatura	129
Modalità di funzionamento in caso di guasto dei sensori	130
Ampliamento del sistema a più circuiti di riscaldamento	130
 SCHEMI IDRAULICI ED ELETTRICI.....	 132
 DATI TECNICI.....	 135
 DICHIARAZIONI E GARANZIA	 136
Dichiarazione del produttore di conformità del prodotto	126
Smaltimento apparecchiature elettriche ed elettroniche in disuso.....	136
Annotazioni	136

ISTRUZIONI PER L'USO

DESCRIZIONE DEL REGOLATORE

ASPETTO DEL REGOLATORE PROMATIC CMP25-2



① Display grafico touch screen

② Tasto  - Esc, Help.

INDICAZIONE DI FUNZIONAMENTO



Tasto luminoso:

verde – valvola di miscelazione chiusa

rosso – valvola di miscelazione aperta

CONFIGURAZIONE DEL REGOLATORE AL PRIMO AVVIO

I regolatori climatici PROMATIC CMP25-2 sono dotati di una soluzione innovativa “EASY START” che permette di regolare con semplicità il regolatore attraverso una procedura guidata.

CONFIGURAZIONE DELLE IMPOSTAZIONI



Alla prima connessione del regolatore in rete ovvero dopo il reset del regolatore, in seguito alla visualizzazione della versione e del logo, si avvia una procedura guidata per la configurazione delle impostazioni del regolatore.

STEP 1 – ORIENTAMENTO DEL DISPLAY

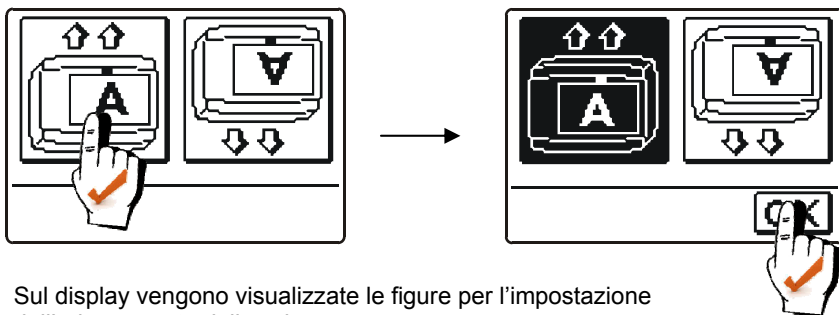

Sul display vengono visualizzate le figure per l'impostazione dell'orientamento dello schermo.

Premere sulla figura indicante la lettera **A** nel senso corretto. Una volta selezionato l'orientamento corretto dello schermo, confermare l'impostazione premendo il tasto **OK**.

STEP 2 – APERTURA DELLA VALVOLA DI MISCELAZIONE

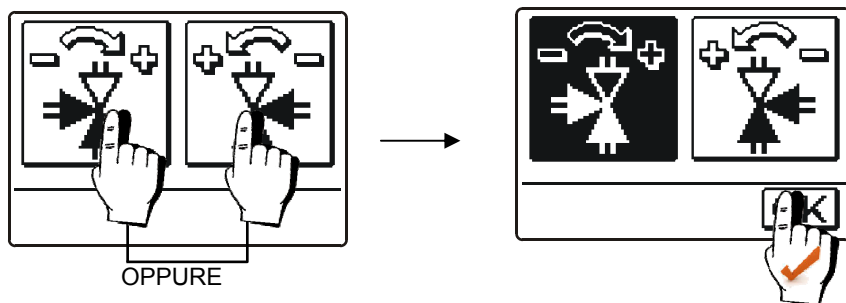

Premere sulla figura indicante il senso di apertura corretto (+) della valvola di miscelazione. Una volta selezionato il senso corretto, confermare l'impostazione premendo il tasto **OK**.

STEP 3 – SELEZIONE LINGUA

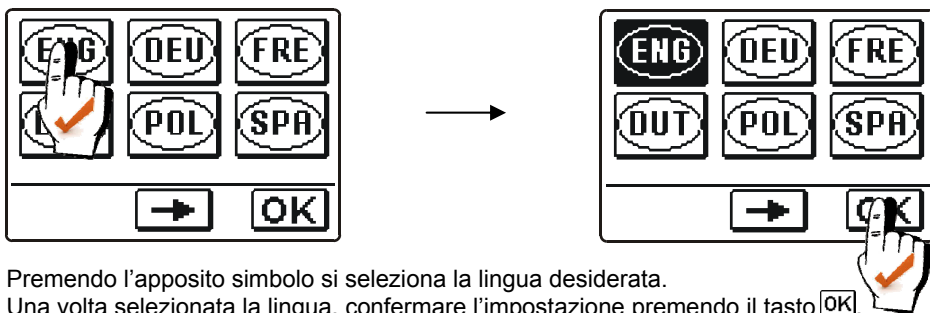

STEP 4 – SCHEMA IDRAULICO

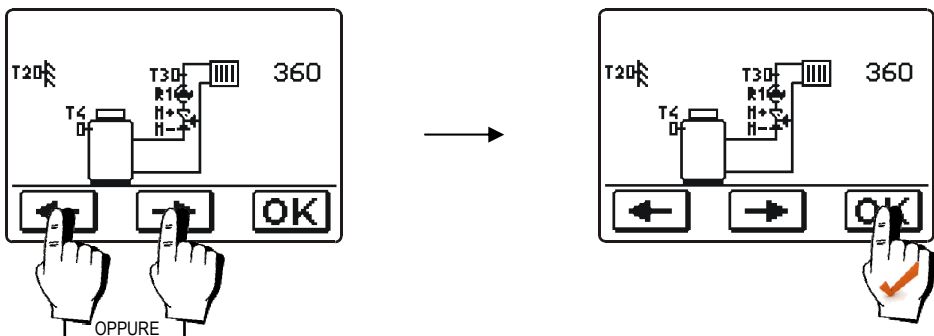

STEP 5 – INCLINAZIONE DELLA CURVA CLIMATICA

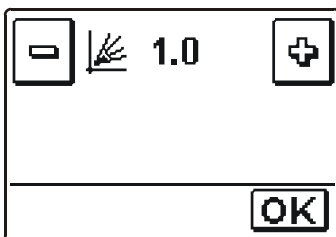

Il significato dell'inclinazione della curva climatica è descritto in modo dettagliato a pagina 118 e 119.



Lo schema idraulico, l'orientamento dello schermo, la direzione di rotazione e la lingua possono essere modificati in qualsiasi momento nelle impostazioni di servizio mediante i parametri o effettuando il reset del regolatore!



RESET - Staccare il regolatore dall'alimentazione. Tenere premuto il tasto **○** e inserire l'alimentazione. Il regolatore resetta tutte le impostazioni e attiva un servizio automatico per la configurazione del regolatore.

DISPLAY LCD GRAFICO

Il display grafico è touch screen e, oltre a visualizzare le informazioni relative al funzionamento, serve per impostare il regolatore. Sul display LCD si possono verificare le informazioni sul funzionamento del regolatore e modificare le impostazioni del funzionamento.

DESCRIZIONE E ASPETTO DELLO SCHERMO

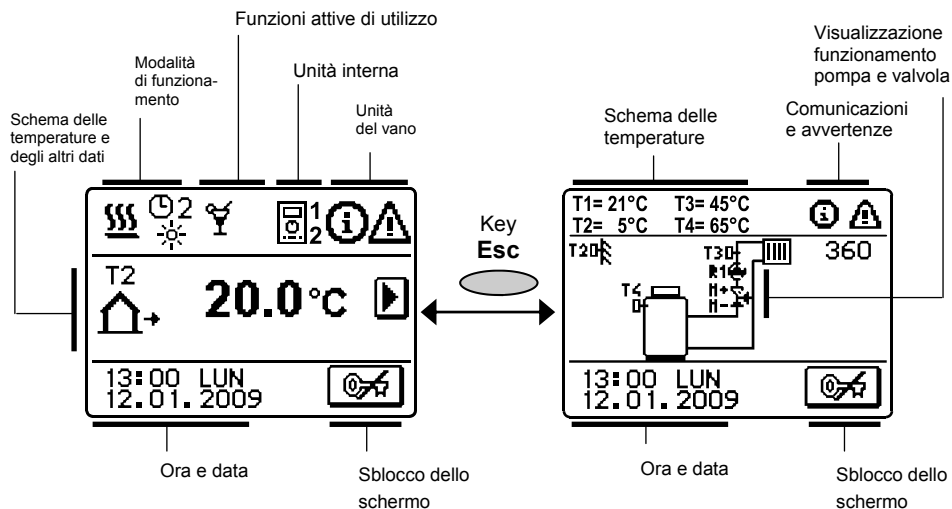









DESCRIZIONE DEI SIMBOLI VISUALIZZATI SUL DISPLAY











SIMBOLI PER LA VISUALIZZAZIONE DEL FUNZIONAMENTO

Simbolo	Descrizione
	Riscaldamento dei locali.
	Raffreddamento dei locali.
	Funzionamento secondo il programma orario impostato – temperatura diurna
	Funzionamento secondo il programma orario impostato – temperatura notturna.
	Funzionamento secondo la temperatura diurna.
	Funzionamento secondo la temperatura notturna.
	Spegnimento del regolatore.
	Funzionamento manuale.



SIMBOLI DELLE FUNZIONI IMPOSTATE DALL'UTENTE

Simbolo	Descrizione
	É inserita la funzione »PARTY«.
	É inserita la funzione »ECO«.
	É inserita la funzione »VACANZE«.
	É inserita la funzione per asciugare il massetto. 01/ - giorno di asciugatura 25 - durata dell'asciugatura
	Commutazione automatica al funzionamento estivo.
	É inserito il funzionamento con una temperatura costante della condotta di mandata.
	Accensione telecomandata.
	Riscaldamento »Boost«.





SIMBOLI PER LA VISUALIZZAZIONE DELLE TEMPERATURE E ALTRI DATI

Simbolo	Descrizione
	Temperatura rilevata.
	Temperatura calcolata o desiderata.
	Temperatura del locale.
	Temperatura esterna.
	Temperatura della condotta di mandata.
	Temperatura della condotta di ritorno.
	Temperatura della caldaia.
	Valvola di miscelazione - chiusura (quando lampeggia è necessario chiuderla).
	Valvola di miscelazione - apertura (quando lampeggia è necessario aprirla).
	Pompa di circolazione.
T1, T2, T3, T4	Temperatura rilevata sul sensore T1, T2, T3 o T4.
TR	Temperatura rilevata nell'unità abitativa DD2+.
TA	Temperatura esterna ottenuta secondo la connessione BUS.
TQ	Temperatura della caldaia ottenuta secondo la connessione BUS.

SIMBOLI PER LE FUNZIONI DI PROTEZIONE

Simbolo	Descrizione
	Protezione dal surriscaldamento della caldaia per il riscaldamento corrente.
	Protezione dal congelamento dei locali.

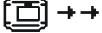

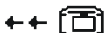
SIMBOLI PER LA VISUALIZZAZIONE DELLA COMUNICAZIONE TRA LE APPARECCHIATURE COLLEGATE

Simbolo	Descrizione
	Apparecchi collegati alla linea di comunicazione COM1.
	È collegata la prima (1) o la seconda (2) unità ambiente DD2+.
	Stato del regolatore e della connessione BUS COM1/COM2.
	Regolatore autonomo – non è nella connessione BUS.
	Regolatore principale collegato alla connessione BUS.
	Regolatore dipendente intermedio collegato alla connessione BUS
	Regolatore dipendente finale collegato alla connessione BUS.

SIMBOLI PER LE COMUNICAZIONI E LE AVVERTENZE

Simbolo	Descrizione
	<p>Comunicazione</p> <p>In caso di superamento della temperatura massima o di inserimento della funzione di protezione, il regolatore ci avverte con un simbolo lampeggiante sul display. Se la temperatura massima non viene più superata o se la funzione di protezione si è già staccata, ci segnala l'evento accaduto il simbolo acceso. Schiacciando il tasto HELP richiamiamo sullo schermo la memoria delle avvertenze.</p>
	<p>Avvertenza</p> <p>In caso di guasto al sensore, un errore al collegamento BUS o un errore al collegamento com, il regolatore ci avvisa con un simbolo lampeggiante sul display. Se l'errore viene eliminato ovvero non è più presente, ci segnala l'evento accaduto il simbolo acceso. Schiacciando il tasto HELP richiamiamo sullo schermo il memoria delle avvertenze.</p>



NAVIGAZIONE DI BASE SUL DISPLAY

Tasto	Funzione del tasto
	Blocco/sblocco del display.
	Help.
	Spostamento al dato successivo.
	Accesso al menù
	Spostamento avanti/ indietro nei menù o nei dati.
	Aumento e riduzione del valore dei dati.
	Conferma dell'impostazione.
	Conferma dell'impostazione e ritorno al menù o alla selezione precedente.

BLOCCO E SBLOCCO DEL DISPLAY

Se si desiderano modificare le impostazioni del regolatore o controllare le informazioni sul funzionamento, è necessario premere innanzitutto il tasto  per sbloccare lo schermo. Lo schermo si blocca automaticamente 60 s dopo aver schiacciato uno qualsiasi dei tasti.

SCHERMO PER L'AIUTO, LE COMUNICAZIONI E LE AVVERTENZE

Innanzitutto sblocciamo lo schermo schiacciando il tasto . Premendo il tasto  apriamo lo schermo per l'aiuto, le comunicazioni e le avvertenze.

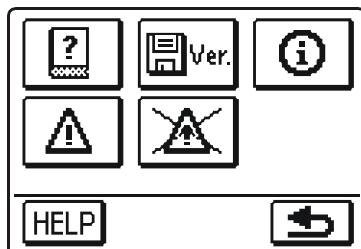

Ci sono a disposizione le seguenti possibilità:



Brevi istruzioni

Brevi istruzioni per l'utilizzo del regolatore.





Versione del regolatore

Descrizione del tipo e della versione software del regolatore.





Comunicazioni

Elenco dei superamenti delle temperature massime e dell'attivazione delle funzioni di protezione. Schiacciando sul tasto  e  ci spostiamo sull'elenco delle comunicazioni. Con il tasto  lasciamo l'elenco.



Avvertenze

Elenco dei guasti ai sensori e agli altri gruppi.

Schiacciando sul tasto  e  ci spostiamo sull'elenco delle comunicazioni. Con il tasto  lasciamo l'elenco.





Cancellazione delle avvertenze

Schiacciando il tasto si effettua la cancellazione dall'elenco dei guasti tutti i sensori non collegati.

Attenzione: *I sensori che sono obbligatori per il funzionamento del regolatore non possono essere cancellati.*

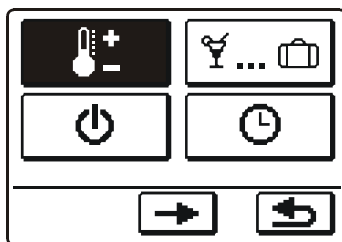
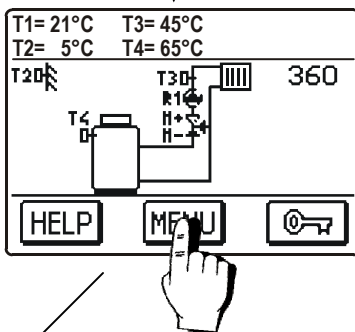
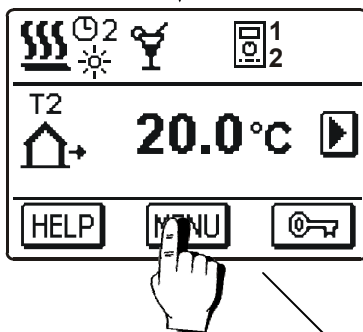
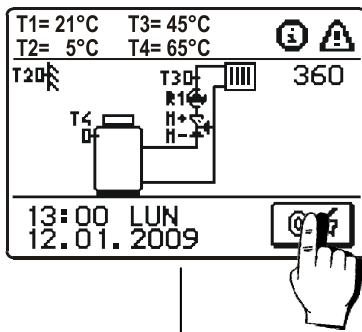
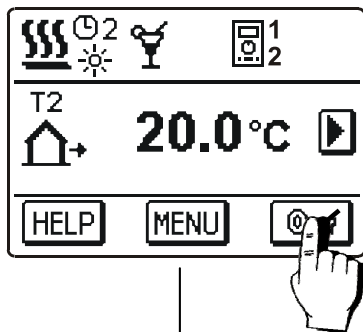

ACCESSO E NAVIGAZIONE NEL MENÙ

Innanzitutto sbloccare lo schermo premendo il tasto . Entrare nei menù di configurazione premendo il tasto .



Per spostarsi all'interno del menù premere le icone raffigurate sul display.



Se ad un determinato livello del menù esistono diverse schermate dotate di tasti, è possibile spostarsi da una schermata all'altra premendo i tasti  e .

STRUTTURA E DESCRIZIONE DEL MENÙ

IMPOSTAZIONE DELLA TEMPERATURA

 Temperatura diurna

 Temperatura notturna

FUNZIONI IMPOSTATE DALL'UTENTE

 PARTY

 ECO

 Vacanze

 Disattivazione della funzione

MODALITÀ DI FUNZIONAMENTO

 Funzionamento secondo il programma orario

 Funzionamento con temperatura diurna

 Funzionamento con temperatura notturna

 Spegnimento

 Riscaldamento o refrigerazione degli ambienti

 Modalità manuale

PROGRAMMI ORARI

 Programma orario 1

 Programma orario 2

 Programma orario 3

 Programma orario 4



IMPOSTAZIONI DI BASE



Lingua dell'utente.



Ora e data



IMPOSTAZIONI DEL DISPLAY

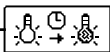

Durata della retroilluminazione



Intensità dell'illuminazione attiva



Intensità dell'illuminazione inattiva



Contrasto



VERIFICA DEI DATI



Schema delle temperature nell'arco di una settimana

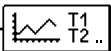

Schema dettagliato delle temperature del giorno

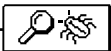

Particolari dati di assistenza tecnica



PARAMETRI DI BASE



Impostazioni di base



Impostazioni per il circuito di riscaldamento



Impostazioni per la fonte di calore



IMPOSTAZIONI DI SERVIZIO



Parametri generali



Impostazioni per il circuito di riscaldamento

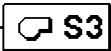

Impostazioni per la fonte di calore



IMPOSTAZIONI DI FABBRICA



Reset dei parametri del regolatore



Reset dei programmi orari



Reset del regolatore e riavvio della prima configurazione



Salvataggio delle impostazioni dell'utente



Ripristino delle impostazioni dell'utente





IMPOSTAZIONE DELLE TEMPERATURE

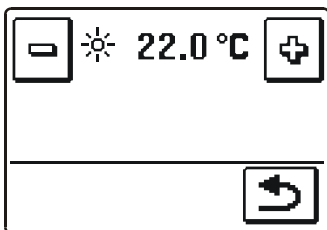

Impostazione della temperatura diurna





Con i tasti  e  impostare il valore della temperatura desiderato.
Premere il tasto  per confermare l'impostazione e tornare alla schermata precedente.

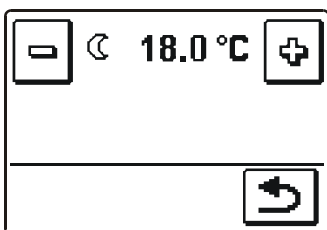

Impostazione della temperatura notturna



Con i tasti  e  impostare il valore della temperatura desiderato.
Premere il tasto  per confermare l'impostazione e tornare alla schermata precedente.

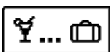



FUNZIONI DELL'UTENTE

Le funzioni dell'utente garantiscono ulteriore confort e vantaggi nell'utilizzo del regolatore. Nel menù sono disponibili le seguenti funzioni dell'utente:



Funzione PARTY

Premendo l'icona **PARTY** inseriamo il riscaldamento ad una temperatura confort. Per impostare la funzione Party è necessario premere ancora una volta sull'icona Party. Si apre una nuova schermata. Con i tasti  e  impostiamo la temperatura desiderata e l'ora di spegnimento della funzione.

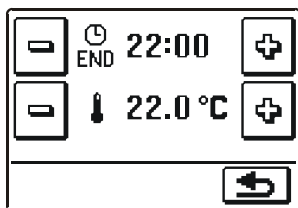



Impostazione dell'ora di spegnimento della funzione

Impostazione della temperatura

€CO

Funzione ECO

Premendo l'icona **ECO** inseriamo il riscaldamento ad una temperatura di risparmio. Per impostare la funzione ECO è necessario premere ancora una volta sull'icona ECO. Si apre una nuova schermata. Con i tasti  e  impostiamo la temperatura desiderata e l'ora di spegnimento della funzione.

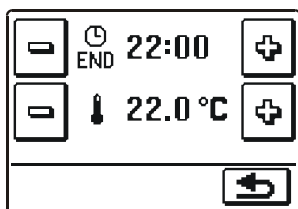



Impostazione dell'ora di spegnimento della funzione

Impostazione della temperatura

€CO

Funzione VACANZE

Premendo l'icona **VACANZE** inseriamo il riscaldamento ad una specifica temperatura di risparmio fino alla data desiderata. Per impostare la funzione Vacanze è necessario premere ancora una volta sull'icona Vacanze. Si apre una nuova schermata. Con i tasti  e  impostiamo la temperatura desiderata e la data in cui viene disattivata tale funzione. Lo spegnimento avviene alle ore 00:00 della data impostata

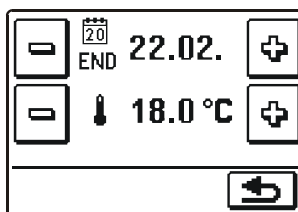

Impostazione della data in cui si disattiva la funzione

Impostazione della temperatura





MODALITÀ DI FUNZIONAMENTO

È possibile scegliere tra sei modalità di funzionamento del regolatore.



Funzionamento secondo il programma orario.

Il funzionamento avviene secondo il programma orario prescelto. Se è collegata l'unità ambiente appare l'icona  (il numero ci dice quale unità ambiente influisce sul circuito). Se il regolatore funziona senza l'unità ambiente appare solo l'icona .



Funzionamento secondo la temperatura diurna

Il regolatore funziona secondo la temperatura diurna impostata.



Funzionamento secondo la temperatura notturna

Il regolatore funziona secondo la temperatura notturna impostata.



Disattivazione

La scegliamo quando desideriamo disattivare il regolatore. Rimane attiva la protezione contro il congelamento se è stato scelto come modalità di funzionamento il riscaldamento. Se è stata scelta come modalità di funzionamento la refrigerazione, rimane una protezione attiva contro il surriscaldamento.



Scelta tra riscaldamento o refrigerazione dei locali



La regolazione della refrigerazione avviene termicamente staticamente in relazione alla temperatura interna desiderata e con limitazione del punto di condensazione.



Per il funzionamento della refrigerazione deve essere collegato il sensore dell'unità o l'unità ambiente e inserito il sistema per l'apporto dell'acqua refrigerante.



Funzionamento manuale

Viene utilizzato nei controlli del sistema di riscaldamento o in caso di guasto.

Si apre una nuova schermata, dalla quale è possibile aprire e chiudere manualmente la valvola di miscelazione e inserire o disinserire la pompa di circolazione.

Chiusura della valvola di miscelazione

Spegnimento della pompa di circolazione

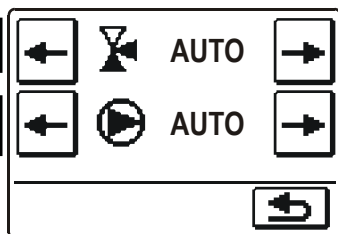

Apertura della valvola di miscelazione

Accensione della pompa di circolazione

Premere il tasto  per confermare l'impostazione e tornare alla schermata precedente.



Selezione del programma orario

Sono disponibili quattro diversi programmi orari indipendenti tra loro.

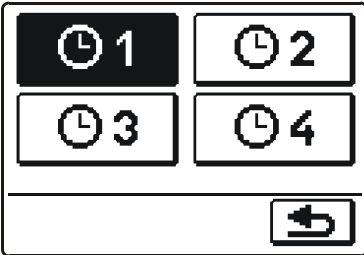



Una volta selezionato il programma orario desiderato, premere il tasto  per confermare la scelta e tornare alla schermata precedente.

Configurazione e copia del PROGRAMMA ORARIO

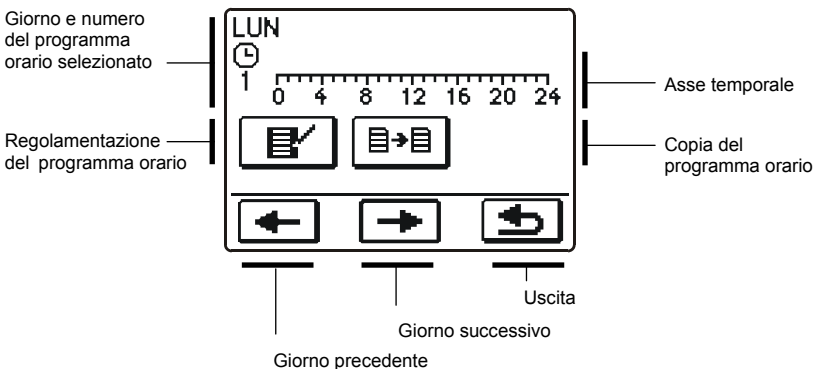
Premendo nuovamente sull'icona del programma orario selezionato si apre una nuova schermata:



Premendo i tasti  e  selezionare innanzitutto il giorno per il quale si desidera configurare il programma orario e copiarlo su altri giorni.

Configurazione del programma orario

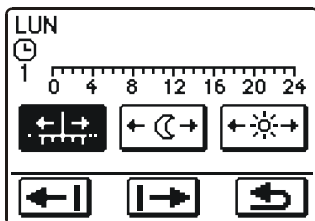

Il significato dei tasti visualizzati sul display è il seguente:



Navigazione libera lungo l'asse temporale



Definizione dell'intervallo di riscaldamento secondo la temperatura diurna / cancellazione dell'intervallo notturno



Definizione dell'intervallo di riscaldamento secondo la temperatura notturna cancellazione dell'intervallo diurno



Spostamento a sinistra



Spostamento a destra



Ritorno alla schermata precedente e salvataggio delle modifiche del programma orario

Grazie ai tasti descritti è possibile stabilire lo svolgimento desiderato del programma orario per il giorno selezionato.

Copia del programma orario

Giorno di partenza

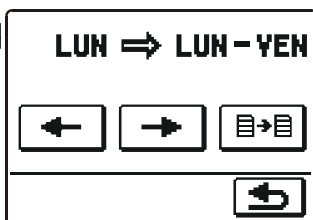

Giorno o giorni di arrivo

Il significato dei tasti visualizzati sul display è il seguente:



Selezione del giorno o di più giorni contemporaneamente (LUN, MAR, MER, GIO, VEN, SAB, DOM, LUN-VEN, LUN-DOM, SAB-DOM) sui quali si desidera copiare il programma orario del giorno selezionato.



Copia.

Impostazioni iniziali dei programmi orari

🕒 1

Giorno	Giornata temperatura periodo.
LUN.-VEN.	06:00 - 22:00
SAB.-DOM.	07:00 - 22:00

🕒 2

Giorno	Giornata temperatura periodo.
LUN.-VEN.	05:00 - 7:30 13:30 - 22:00
SAB.-DOM.	07:00 - 22:00

🕒 3

Giorno	Giornata temperatura periodo.
LUN.-VEN.	06:00 - 08:30 11:00 - 13:30 16:00 - 22:00
SAB.-DOM.	07:00 - 22:00

🕒 4

Giorno	Giornata temperatura periodo.
LUN.-VEN.	14:00 - 22:00
SAB.-DOM.	07:00 - 22:00

ITA



IMPOSTAZIONI DI BASE

Il menù è destinato all'impostazione della lingua dell'utente, dell'ora, della data e del display.



Lingua

Selezionare la lingua dell'utente desiderata come segue:

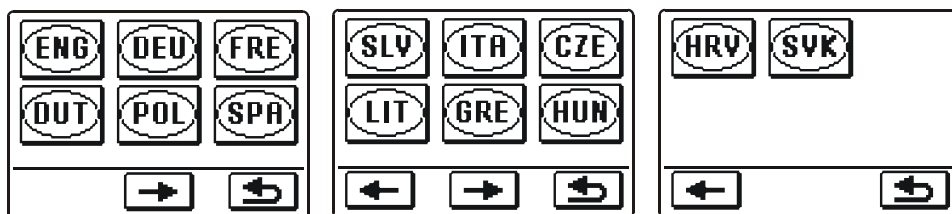

Premere i tasti e per spostarsi da una schermata all'altra nell'elenco delle lingue disponibili.



Selezionare la lingua desiderata premendo il tasto corrispondente. Premere il tasto per confermare la lingua selezionata e tornare alla schermata precedente.

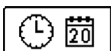

Ora e data

Si apre una schermata per la configurazione dell'ora e della data:

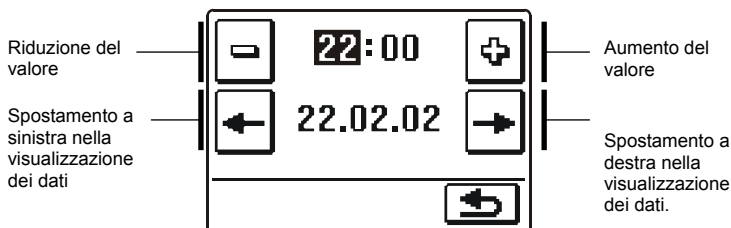

Premere il tasto per confermare le impostazioni e tornare alla schermata precedente.



Impostazione del display

Sono disponibili quattro diverse impostazioni:



Durata della retroilluminazione attiva e uscita automatica dal menù





Intensità dell'illuminazione attiva



Intensità dell'illuminazione inattiva



Contrasto

Modificare le singole impostazioni premendo i tasti  e . Premere il tasto  per confermare le impostazioni e tornare alla schermata precedente.



CONTROLLO DEI DATI

Nel menù ci sono le icone per accedere ai seguenti dati sul funzionamento del regolatore:

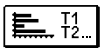

SCHEMA DELLE TEMPERATURE NELL'ARCO DI UNA SETTIMANA

Schema grafico dell'andamento della temperatura, in base ai giorni, per ciascun sensore. Le temperature sono annotate per l'ultima settimana di funzionamento.

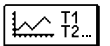

SCHEMA DETTAGLIATO DELLE TEMPERATURE PER LA GIORNATA IN CORSO



Schema grafico dettagliato dell'andamento della temperatura, per la giornata in corso, per ciascun sensore. La frequenza dell'annotazione delle temperature viene impostata con il parametro P.1.7. Tale presentazione delle temperature serve soprattutto per un'analisi del funzionamento del sistema di riscaldamento all'avvio, durante l'assistenza o in caso di guasto.



SPECIALI DATI PER L'ASSISTENZA TECNICA

Servono al servizio tecnico di assistenza per la diagnostica.



*Tra i grafici dei singoli sensori ci spostiamo con il tasto .
Con i tasti  e  ci spostiamo tra i giorni.*

ISTRUZIONI PER LE IMPOSTAZIONI DI SERVIZIO

PARAMETRI DEL REGOLATORE

Tutte le ulteriori impostazioni e modifiche del funzionamento del regolatore avvengono attraverso i parametri. Nel menù ci sono a disposizione tre gruppi di parametri e precisamente:

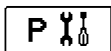

Parametri generali

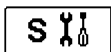

Parametri di servizio



Parametri per l'asciugatura del massetto



Vediamo solo quei parametri che si utilizzano nello schema idraulico selezionato. Dallo schema idraulico selezionato dipendono anche i valori di fabbrica delle impostazioni dei parametri.

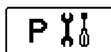

PARAMETRI GENERALI

I parametri generali sono suddivisi in gruppi **P1** – impostazioni generali, **P2** – impostazioni per il circuito di riscaldamento, **P3** – impostazioni per le fonti di calore.

Il contenuto dei parametri di base viene evidenziato in questo modo:



Il parametro desiderato viene modificato così come indicato nell'esempio sottostante per il parametro P1.1:

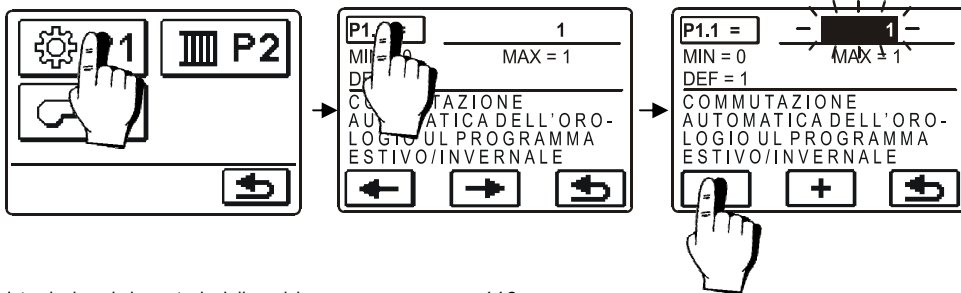

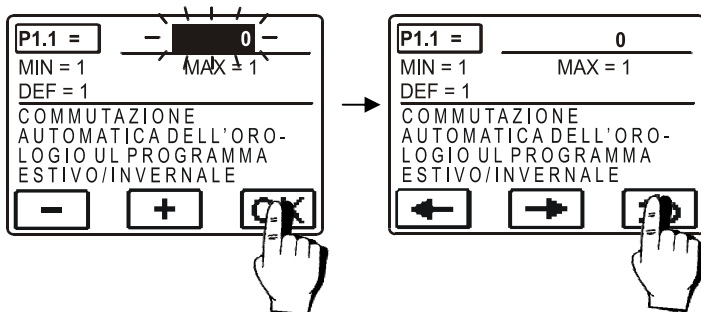

Impostazioni di base :

Parametro	Denominazione del parametro	Descrizione del parametro	Intervallo di impostazione	Impostazione presente
P1.1	COMMUTAZIONE AUTOMATICA DELL'OROLOGIO SUL PROGRAMMA ESTIVO/INVERNALE	Il regolatore, grazie al calendario, effettua automaticamente la commutazione dell'orologio dal programma estivo a quello invernale e viceversa.	0- NO 1- SI	1
P1.2	TEMPERATURA ESTERNA MEDIA PER L'ACCENSIONE AUTOMATICA ESTIVO/INVERNALE	Funzione per l'accensione e la disattivazione automatica a seconda della temperatura media esterna.	10 ÷ 30 °C	18
P1.4	TEMPERATURA AMBIENTE DESIDERATA PER LA PROTEZIONE ANTIGELO	Imposta la temperatura interna desiderata a riscaldamento spento.	2 ÷ 12°C	6
P1.5	ARROTONDAMENTO DELLA VISUALIZZAZIONE DELLA TEMPERATURA	Stabilisce il valore a cui arrotondare la temperatura rilevata visualizzata.	0- 0.1 °C 1- 0.2 °C 2- 0.5 °C 3- 1 °C	2
P1.6	CAMBIO AUTOMATICO DELL'OROLOGIO SUL PROGRAMMA ESTIVO/INVERNALE	Il regolatore, grazie al calendario, effettua automaticamente il cambio dell'orologio dal programma estivo a quello invernale e viceversa.	0- NO 1- SI	1
P1.7	PERIODO DI SALVATAGGIO DELLE TEMPERATURE RILEVATE	Imposta in quale intervallo di tempo vengono salvate le temperature rilevate.	0 ÷ 100%	5
P1.8	TONI	Con l'impostazione stabiliamo quando il regolatore emette dei segnali sonori.	0- DISATTIVATO 1- TASTI	1
P1.9	VISUALIZZAZIONE AVANZATA DELLE TEMPERATURE	Quando si controllano le temperature, la visualizzazione avanzata permette di visualizzare la temperatura rilevata e la temperatura desiderata o calcolata.	0- NO 1- SI	1



Impostazioni per il circuito di riscaldamento miscelato :

Parametro	Denominazione del parametro	Descrizione del parametro	Intervallo di impostazione	Impostazione presente
P2.1	CURVA CLIMATICA	L'inclinazione della curva climatica indica la temperatura necessaria per ciascun calorifero in base ad una determinata temperatura esterna. Il valore dell'inclinazione dipende principalmente dal tipo di sistema di riscaldamento (a pavimento, a parete, a termosifone, a convezione) e dall'isolamento termico dell'edificio.	0,2 ÷ 2,2	0,7 - pavimento 1,0 - termosifone
P2.2	SPOSTAMENTO PARALLELO DELLA CURVA CLIMATICA	Imposta uno spostamento parallelo della curva climatica (temperatura calcolata della condotta di mandata). L'impostazione va utilizzata per eliminare la discrepanza tra la temperatura interna desiderata e la temperatura interna effettiva.	-15 ÷ 15K	0
P2.3	DURATA DEL RISCALDAMENTO BOOST	Imposta il periodo di aumento della temperatura interna desiderata a cavallo tra l'intervallo di riscaldamento notturno e quello diurno.	0 ÷ 200 min	0
P2.4	AUMENTO DELLA TEMPERATURA IN CASO DI RISCALDAMENTO BOOST	Imposta il valore dell'aumento della temperatura interna desiderata a cavallo tra l'intervallo di riscaldamento notturno e quello diurno.	0 ÷ 8K	4
P2.5	PRECEDENZA DEL RISCALDAMENTO DELL'ACQUA SANITARIA	Imposta se il riscaldamento dell'acqua sanitaria ha la precedenza sul riscaldamento dei locali.	0- NO 1- Sì	0



Impostazioni per le fonti di calore :

Parametro	Denominazione del parametro	Descrizione del parametro	Intervallo di impostazione	Impostazione presente
P3.1	TEMPERATURA MINIMA DELLA CALDAIA	Imposta la temperatura minima della caldaia.	10 ÷ 90 °C	40

CURVA CLIMATICA

L'inclinazione della curva climatica indica la temperatura necessaria per ciascun calorifero in base ad una determinata temperatura esterna. Il valore dell'inclinazione dipende principalmente dal tipo di sistema di riscaldamento (a pavimento, a parete, a termosifone, a convezione) e dall'isolamento termico dell'edificio.

Determinazione dell'inclinazione della curva climatica

L'inclinazione della curva climatica può essere stabilita secondo un calcolo basato su un sufficiente numero di informazioni a propria disposizione oppure empiricamente sulla base della valutazione del dimensionamento del sistema di riscaldamento e dell'isolamento termico dell'edificio. L'inclinazione della curva climatica è selezionata correttamente quando la temperatura dell'ambiente rimane invariata anche in caso di importanti variazioni della temperatura esterna.

Fino a quando le temperature esterne sono superiori a +5 °C, la temperatura interna viene regolata modificando le impostazioni della temperatura diurna o notturna ovvero con lo spostamento parallelo della curva climatica (parametro P2.2).

Se, in caso di temperature esterne inferiori, la temperatura nell'edificio si alza, significa che l'inclinazione è troppo alta, pertanto è necessario abbassarla. Il valore dell'innalzamento o dell'abbassamento dell'inclinazione non deve superare le 0,1 o 0,2 unità per ciascun rilevamento. L'intervallo tra i rilevamenti deve essere di almeno 24 ore o più.

I valori comuni di configurazione dell'inclinazione della curva climatica:

Sistema di riscaldamento:	Valori di configurazione:
a pavimento	0,2 - 0,8
a parete	0,6 - 1,0
a termosifone	0,8 - 1,4



L'impostazione della curva climatica permette di adattare il regolatore all'edificio che si desidera regolare.

La corretta impostazione dell'inclinazione della curva climatica è molto importante per il funzionamento ottimale del regolatore.

Diagramma delle curve climatiche

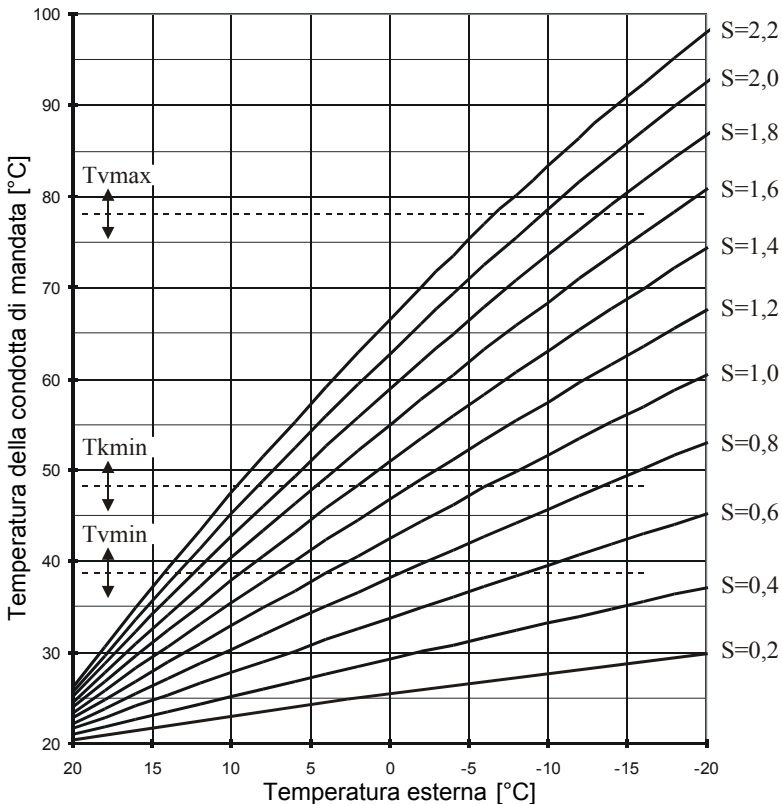



PARAMETRI DI SERVIZIO

I parametri di servizio sono suddivisi in gruppi **S1** – impostazioni generali, **S2** – impostazioni per il circuito di riscaldamento miscelato, **S3** – impostazioni per le fonti di calore.

I dati relativi a ciascun parametro di servizio sono visualizzati nel seguente modo:

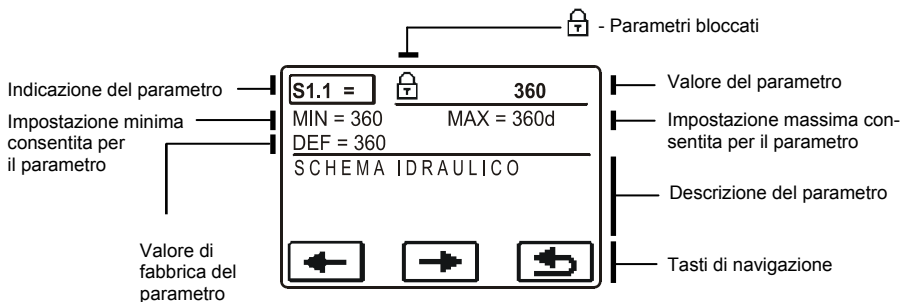

Il parametro desiderato lo modifichiamo allo stesso modo delle impostazioni di base P. I parametri di servizio sono bloccati e devono essere sbloccati con un codice prima di essere cambiati.

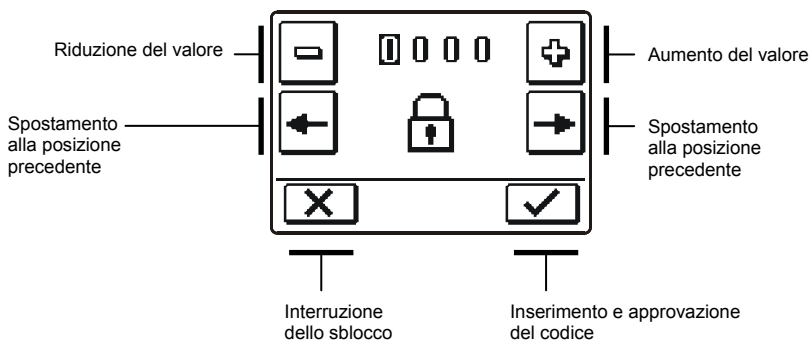

L'impostazione di fabbrica del codice per lo sblocco dei parametri di servizio è 0001.

Impostazioni generali

Parametro	Denominazione del parametro	Descrizione del parametro	Intervallo di impostazione	Impostazione presente
S1.1	SCHEMA IDRAULICO	Seleziona lo schema idraulico desiderato.	360 ÷ 360d	360
S1.2	CODICE DI SBLOCCO DELLE IMPOSTAZIONI DI SERVIZIO	L'impostazione permette di modificare il codice necessario per lo sblocco delle impostazioni di servizio. ATTENZIONE: È necessario salvare accuratamente il nuovo codice, in quanto senza di esso non è possibile apportare modifiche alle impostazioni di servizio.	0000 - 9999	0001
S1.3	TIPO DI SENSORI DI TEMPERATURA	Seleziona il tipo di sensori di temperatura Pt1000 o KTY10	0- PT1000 1- KTY10	0
S1.4	SENSO DI CIRCOLAZIONE DELL'AVVIO DEL MOTORE	Imposta il senso di circolazione dell'avvio del motore, ovvero il senso di apertura della valvola di miscelazione.	0- A DESTRA 1- A SINISTRA	0
S1.5	ORIENTAMENTO DEL DISPLAY	Imposta l'orientamento del display.	0- NORMALE 0° 1- ROTAZIONE DI 180°	0
S1.6	SELEZIONE DEL SENSORE T1	Con l'impostazione si stabilisce la modalità di funzionamento del sensore T1. Se si seleziona un sensore della condotta di ritorno con il parametro S2.13 viene impostata la discrepanza massima tra la condotta di mandata e la condotta di ritorno.	0- TEMP. INTERNA 1- TEMP. DELLA COND. DI RITORNO	0
S1.7	SELEZIONE DEL SENSORE T4	Con l'impostazione si stabilisce la modalità di funzionamento del sensore T4. Se si seleziona un sensore della condotta di ritorno con il parametro S2.13 viene impostata la discrepanza massima tra la condotta di mandata e la condotta di ritorno.	0- TEMP. DELLA CALDAIA 1- TEMP. DELLA COND. DI RITORNO	0
S1.8	ACCENSIONE A DISTANZA CON CONNESSIONE BUS	Seleziona se in caso di accensione a distanza si tiene conto solo dell'accensione a distanza locale o anche dell'accensione a distanza del regolatore principale.	1- LOCALE 2- PRINCIPALE	1
S1.9	FUNZIONE ANTIBLOCCAGGIO PER LE POMPE E LE VALVOLE	Se durante la settimana non si fosse inserita una qualsiasi delle uscite a relé, questa si inserisce autonomamente il venerdì alle 20:00 e funziona per 10 s.	0- OFF 1- ON	0
S1.17	CALIBRATURA DEL SENSORE T1	Corregge la rilevazione della temperatura del sensore T1.	-5 ÷ 5 K	0
S1.18	CALIBRATURA DEL SENSORE T2	Corregge la rilevazione della temperatura del sensore T2.	-5 ÷ 5 K	0
S1.19	CALIBRATURA DEL SENSORE T3	Corregge la rilevazione della temperatura del sensore T3.	-5 ÷ 5 K	0
S1.20	CALIBRATURA DEL SENSORE T4	Corregge la rilevazione della temperatura del sensore T4.	-5 ÷ 5 K	0

Impostazioni per il circuito di riscaldamento miscelato

Parametro	Denominazione del parametro	Descrizione del parametro	Intervallo di impostazione	Impostazione presente
S2.1	IMPATTO DELLA TEMPERATURA INTERNA	Imposta l'impatto della discrepanza della temperatura interna per il calcolo della temperatura della condotta di mandata. Un valore basso indica un impatto ridotto, un valore alto un impatto maggiore.	0,0 ÷ 3,0	1

Parametro	Denominazione del parametro	Descrizione del parametro	Intervallo di impostazione	Impostazione presente
S2.2	INFLUENZA DEL SENSORE INTERNO T1	Con l'impostazione si stabilisce se il sensore interno influisce sul funzionamento della regolazione. Tale funzione ha senso solo se con il parametro S1.6 è stato selezionato un sensore interno (S1.6=0).	1- Sì 2- NO	1
S2.3	INFLUENZA DEL SENSORE DD2+	Con l'impostazione si stabilisce se il sensore dall'unità interna influisce sul funzionamento della regolazione. #1 significa che influisce solo il sensore della prima unità interna #2 significa che influisce solo il sensore della seconda unità interna #1&2 significa che influiscono i sensori della prima e della seconda unità interna AUTO significa che influisce il sensore di quell'unità Interna che alimenta il circuito di riscaldamento	1 - AUTO 2 - #1 3 - #2 4 - #1&2 5 - NO	1
S2.4	MODALITÀ DI FUNZIONAMENTO DELLA POMPA	Imposta la modalità di funzionamento della pompa di circolazione. Le impostazioni hanno il seguente significato: 1- STAND. (pompa di circolazione del circuito miscelato - standard) 2- P1 (funzionamento in base al programma orario P1) 3- P2 (funzionamento in base al programma orario P2) 4- P3 (funzionamento in base al programma orario P3) 5- P4 (funzionamento in base al programma orario P4) 6- PR. SEL. (funzionamento in base al programma orario selezionato).	1- STAND. 2- P1 3- P2 4- P3 5- P4 6- PROG. OR. SEL.	1
S2.5	TEMPERATURA MINIMA DELLA CONDOTTA DI MANDATA	Imposta il limite della temperatura minima della condotta di mandata.	10 ÷ 90 °C	20
S2.6	TEMPERATURA MASSIMA DELLA CONDOTTA DI MANDATA	Imposta il limite della temperatura massima della condotta di mandata	20 ÷ 150°C	45 - pavimento 85 - termosifone
S2.7	ZONA MORTA DI REGOLAZIONE DELLA VALVOLA DI MISCELAZIONE	Imposta l'intervallo di discrepanza della temperatura della condotta di mandata a cui la regolazione della valvola di miscelazione è spenta o inattiva.	1,0 ÷ 3,0K	1
S2.8	COSTANTE P DELLA VALVOLA DI MISCELAZIONE	Imposta la velocità di regolazione della valvola di miscelazione. Un valore basso indica una risposta più lenta, un valore alto una risposta più rapida nella regolazione.	0,5 ÷ 2,0	1
S2.9	COSTANTE I DELLA VALVOLA DI MISCELAZIONE	Imposta l'intensità dell'impatto della modifica della temperatura della condotta di mandata sul funzionamento della regolazione della valvola di miscelazione.	0,4 ÷ 2,5	1
S2.10	COSTANTE D DELLA VALVOLA DI MISCELAZIONE	Imposta l'intensità dell'impatto della modifica della temperatura della condotta di mandata sul funzionamento della regolazione della valvola di miscelazione.	0,4 ÷ 2,5	1
S2.11	TEMPERATURA MINIMA DELLA CONDOTTA DI MANDATA PER LA REFRIGERAZIONE	Imposta la temperatura minima consentita della condotta di mandata durante la refrigerazione. ATTENZIONE: L'impostazione di una temperatura troppo bassa può causare la condensa dei caloriferi e delle condutture.	10 ÷ 20°C	15
S2.12	SPOSTAMENTO DEL PUNTO DI SPEGNIMENTO DEL RISCALDAMENTO	Impostiamo lo spostamento della temperatura rilevata della condotta di mandata in cui viene spento il riscaldamento.	-10 ÷ 10°C	0

Parametro	Denominazione del parametro	Descrizione del parametro	Intervallo di impostazione	Impostazione presente
S2.13	LIMITAZIONE DELLA DIFFERENZA TRA COND. DI MANDATA E RITORNO	Imposta la differenza massima consentita tra le condotte di mandata e di ritorno. In questo modo si assicura una distribuzione equa dell'energia disponibile nei sistemi con più circuiti di riscaldamento.	3 ÷ 30 K	10
S2.14	TEMPERATURA COSTANTE DELLA CONDOTTA DI MANDATA	Selezioniamo se deve funzionare la regolazione con la temperatura costante della condotta di mandata. L'intervallo di impostazione della temperatura costante è 10 ÷ 140 °C. ATTENZIONE Tale funzione disattiva la regolazione in funzione della temperatura esterna.	0- NO 1- SI	0
S2.15	RITARDO NELLO SPEGNIMENTO DELLA POMPA DI CIRCOLAZIONE (MINUTI)	Con l'impostazione si stabilisce il periodo di ritardo nello spegnimento della pompa di circolazione quando non c'è bisogno di usare il riscaldamento.	1 ÷ 10 min	5

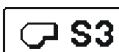

Impostazioni dei parametri – Fonti di calore :

Parametro	Denominazione del parametro	Descrizione del parametro	Intervallo di impostazione	Impostazione presente
S3.1	TEMPERATURA MASSIMA DELLA CALDAIA	Imposta la temperatura massima della caldaia.	60 ÷ 160°C	90
S3.2	AUMENTO DELLA TEMPERATURA DELLA CALDAIA PER LE ESIGENZE DEL CIRCUITO DI RISCALDAMENTO MISCELATO	L'impostazione indica di quanto deve essere maggiore la temperatura della caldaia rispetto alla temperatura della condotta di mandata calcolata.	0 ÷ 25K	5

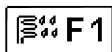

PARAMETRI DI ASCIUGATURA DEL MASSETTO

Nel gruppo **F1** ci sono i parametri per l'impostazione dell'asciugatura del massetto.



La procedura per l'impostazione dei parametri di asciugatura del massetto è uguale a quella per le impostazioni di servizio (vedi pagina 120).



Parametri di asciugatura del massetto :

Parametro	Denominazione del parametro	Intervallo di impostazione	Impostazione presente
F1.1	ATTIVAZIONE DI ASCIUGATURA DEL MASSETTO	0- NO 1- YES	0
F1.2	INTERVALLO 1: DURATA	1 ÷ 15 days	10
F1.3	INTERVALLO 1: TEMPERATURA INIZIALE	10 ÷ 60 °C	20
F1.4	INTERVALLO 1: TEMPERATURA FINALE	10 ÷ 60 °C	20
F1.5	INTERVALLO 2: DURATA	1 ÷ 15 days	5
F1.6	INTERVALLO 2: TEMPERATURA INIZIALE	10 ÷ 60 °C	20
F1.7	INTERVALLO 2: TEMPERATURA FINALE	10 ÷ 60 °C	50
F1.8	INTERVALLO 3: DURATA	1 ÷ 15 days	10
F1.9	INTERVALLO 3: TEMPERATURA INIZIALE	10 ÷ 60 °C	50
F1.10	INTERVALLO 3: TEMPERATURA FINALE	10 ÷ 60 °C	50
F1.11	INTERVALLO 4: DURATA	1 ÷ 15 days	5
F1.12	INTERVALLO 4: TEMPERATURA INIZIALE	10 ÷ 60 °C	50
F1.13	INTERVALLO 4: TEMPERATURA FINALE	10 ÷ 60 °C	20

Profilo di asciugatura del massetto – impostazione di fabbrica:

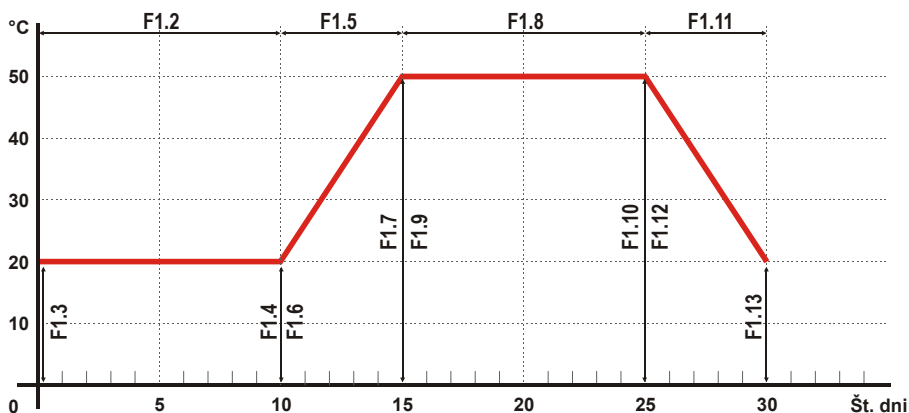

IMPOSTAZIONI DI FABBRICA

Nel menù si trovano gli strumenti a supporto delle impostazioni del regolatore.



RESET DI TUTTE LE IMPOSTAZIONI DEL REGOLATORE

Ripristina i valori di fabbrica di tutte le impostazioni dei parametri **P1, P2, P3, S1** (tranne **S1.1**), **S2, S3** e **F1**.



RESET DEI PROGRAMMI ORARI

Cancella i programmi orari impostati e ripristina le impostazioni di fabbrica dei programmi orari.



RESET DEL REGOLATORE E RIAVVIO DELLA PRIMA CONFIGURAZIONE

Ripristina tutti i parametri con i valori di fabbrica e riavvia la prima impostazione del regolatore.



SALVATAGGIO DELLE IMPOSTAZIONI DELL'UTENTE

Salva tutte le impostazioni del regolatore come impostazioni dell'utente.



CARICAMENTO DELLE IMPOSTAZIONI DELL'UTENTE

Carica le impostazioni dell'utente già salvate.

ISTRUZIONI PER L'INSTALLAZIONE

INSTALLAZIONE DEL REGOLATORE

Il regolatore va installato in un luogo asciutto, all'interno, dove non sia esposto a un forte campo elettromagnetico. L'installazione va effettuata direttamente sulla valvola di miscelazione e, per installarlo, non è necessario smontare o aprire il regolatore.

INSTALLAZIONE SULLA VALVOLA DI MISCELAZIONE

Le modalità di installazione sotto descritte valgono per le valvole di miscelazione dei seguenti produttori: Esbe, Seltron, Somatherm, Acaso, Ivar, Wip, Paw, BRV, Imit, Hora, Barberi, Olymp, Hoval.

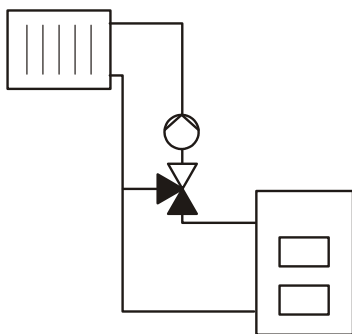

Esempio di installazione su valvola a tre vie

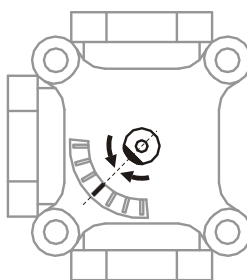

1a

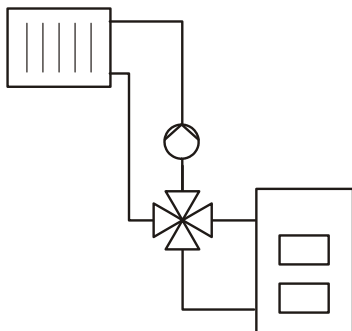

Esempio di installazione su valvola a quattro vie

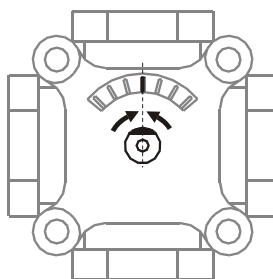

1b



La valvola di miscelazione va posta in posizione media.

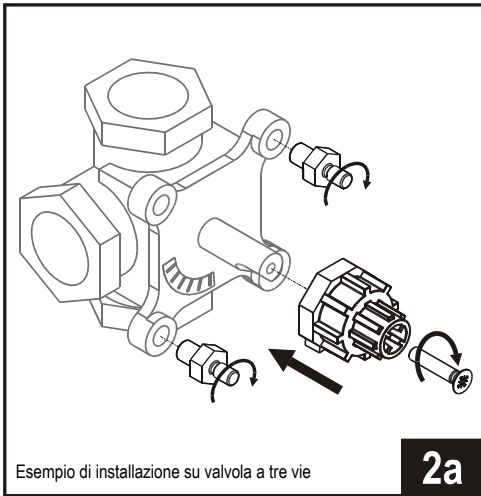

Esempio di installazione su valvola a tre vie

2a

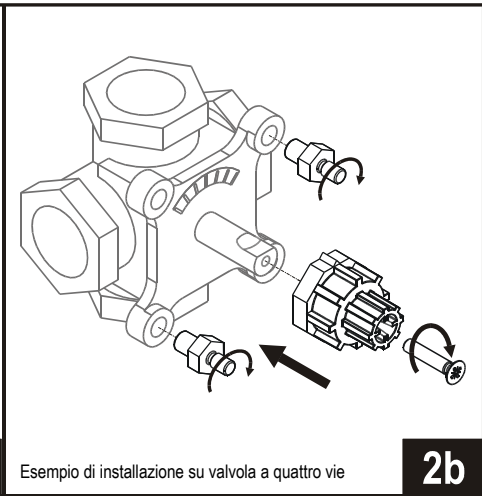

Esempio di installazione su valvola a quattro vie

2b

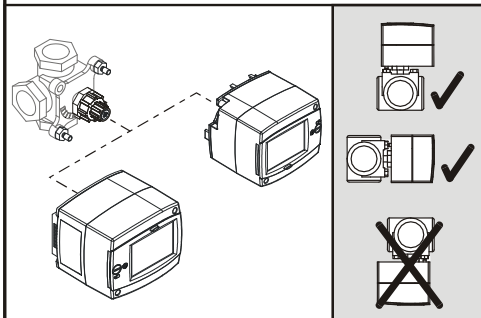
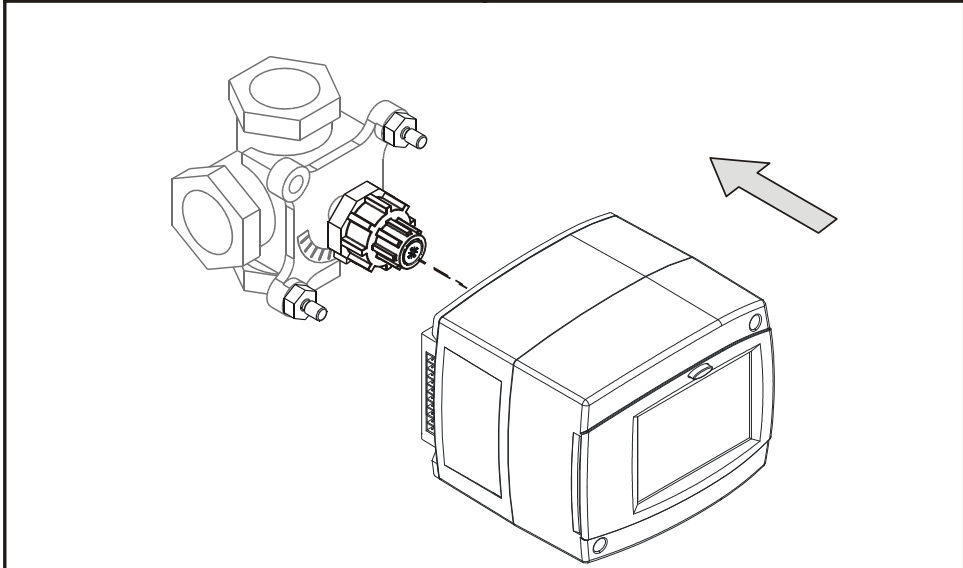

3

ALLACCIAMENTO ELETTRICO DEL REGOLATORE



Le immagini e i testi riportati nel presente manuale hanno il puro scopo illustrativo e l'editore non si assume alcuna responsabilità a riguardo. Se ci si attiene ai contenuti del presente manuale, ci si assume la piena responsabilità in merito. L'editore è espressamente esonerato dalle responsabilità imputabili all'utilizzo non accurato, errato o irregolare dei dati e dai danni che ne derivano. Sono ammissibili eventuali errori o imprecisioni tecniche e si riserva la facoltà di apportare modifiche senza preavviso.

L'allacciamento degli apparecchi di termoregolazione deve essere effettuato da un professionista in possesso della qualificazione necessaria o da una ditta autorizzata. Prima di intervenire sull'impianto elettrico, assicurarsi che l'interruttore generale sia spento.

È necessario tenere in considerazione le norme in materia di impianti a bassa tensione IEC 60364 e VDE 0100, le disposizioni di legge in materia di prevenzione degli incidenti, le disposizioni di legge in materia di tutela dell'ambiente e la restante legislazione vigente. La mancata osservanza delle istruzioni può portare a infortuni gravi, come le scottature, o anche alla morte.

ADATTATORI PER TENSIONI DI RETE

Gli adattatori di rete sono già integrati. Il cavo di allacciamento alla tensione di rete è dotato di una presa per la messa a terra per una tensione di rete di 230 V~. L'altro cavo di rete è destinato all'allacciamento della pompa di circolazione.

ADATTATORI PER SENSORI, UNITÀ INTERNE E CONNESSIONE BUS

Il significato degli adattatori è raffigurato nell'immagine

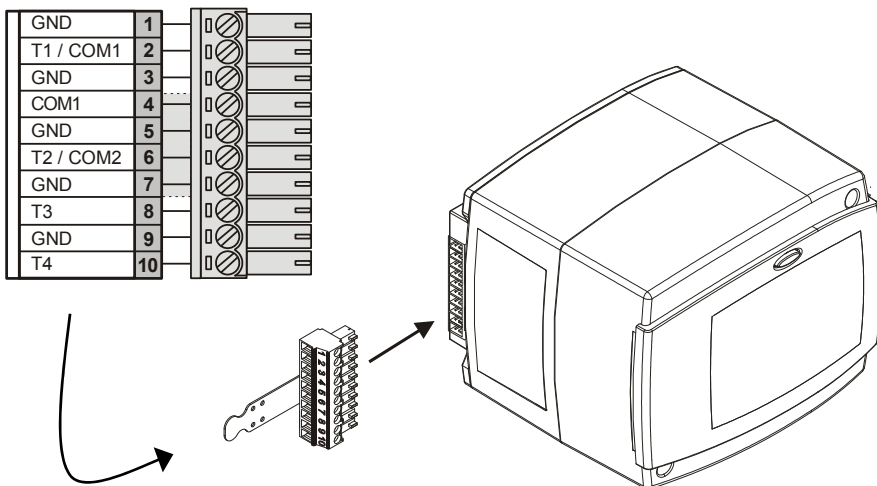

ALLACCIAMENTO DELL'UNITÀ DIGITALE INTERNA DD2+

Con l'unità interna misuriamo la temperatura interna, impostiamo la temperatura diurna e notturna e selezioniamo la modalità di funzionamento. Su un regolatore possiamo allacciare al massimo due unità interne. Prima di allacciare l'unità interna è necessario effettuare la configurazione degli interruttori sul retro dell'unità interna.



IMPOSTAZIONE
OBBLIGATORIA



L'unità interna alimenta il
circuito di riscaldamento.



L'unità interna non alimenta il
circuito di riscaldamento.



Prima unità interna(#1).



Seconda unità interna (#2).

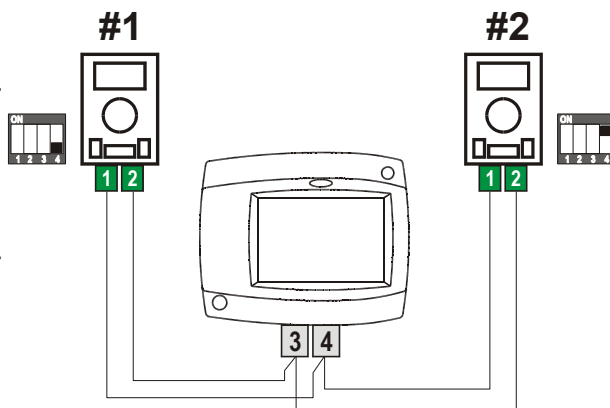

ALLACCIAMENTO DEL SENSORE DA INTERNO

Il sensore da interno si utilizza per la misurazione della temperatura interna, in modo uguale al sensore da interno dell'unità ambiente digitale DD2+. In tal modo migliora la regolazione della temperatura interna desiderata. Per il solo funzionamento del regolatore non è obbligatorio il sensore da interno. Quando allacciamo il sensore da interno si richiede l'impostazione del parametro S1.6=0.

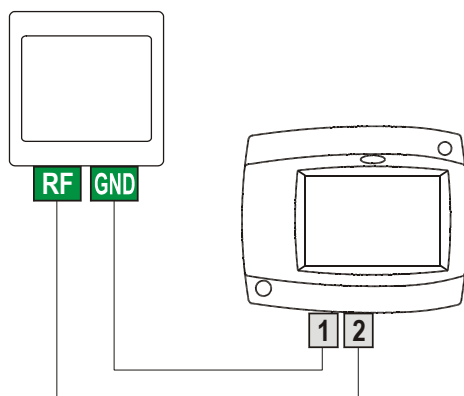

*L'allacciamento del sensore interno
è possibile con lo schema 360 e
360b.*

MODALITÀ DI INSTALLAZIONE E INDICAZIONE DEI SENSORI DI TEMPERATURA

Sensore di temperatura esterna

Il sensore di temperatura esterna va installato sulla facciata esposta a nord o nordovest, a circa 2 m da terra. La facciata esposta a sud non è adatta all'installazione.

L'installazione sopra le finestre o gli aeratori non è consentita. Innanzitutto rimuovere il coperchio di sicurezza e svitare le due viti del coperchio. Con la vite a muro inclusa fissare il sensore nel luogo selezionato. Inserire il cavo nel sensore facendolo passare dal cavo sul fondo del sensore e allacciare il sensore.

Sensore di superficie

Il sensore di superficie va installato sul tubo del condotto di mandata sulla pompa di circuito o dietro la valvola di miscelazione. Pulire accuratamente la parte di tubo selezionata. Posizionare il sensore sulla parte selezionata e fissarlo con la molla inclusa.

Sensore a immersione

Durante l'installazione prestare attenzione a che il sensore sia posizionato ad una profondità sufficiente all'interno del tubo in modo tale da essere in contatto diretto con le pareti del tubo. Se necessario utilizzare uno spessore per premere il sensore contro la parete del tubo. Per evitare che si muova, fissare il sensore con un morsetto a vite.

Sensore da interno o unità ambiente

L'unità ambiente va installata sulla parete interna di un ambiente, lontano dalla luce solare diretta, dalle fonti di calore e dalle correnti d'aria. Rimuovere innanzitutto il coperchio e fissare con le viti il supporto nel luogo selezionato a circa 1,5 metri da terra.

L'installazione può avvenire normalmente con una cassetta posta sotto malta o direttamente sulla parete. Per l'allacciamento elettrico è necessario un cavo di segnale a due fili. Se sui radiatori del locale in cui è installata l'unità ambiente sono presenti valvole termostatiche, queste ultime

Resistenza dei sensori di temperatura del tipo Pt1000:

Temperatura [°C]	Resistenza [Ω]	Temperatura [°C]	Resistenza [Ω]	Temperatura [°C]	Resistenza [Ω]	Temperatura [°C]	Resistenza [Ω]
-20	922	35	1136	90	1347	145	1555
-15	941	40	1155	95	1366	150	1573
-10	961	45	1175	100	1385	155	1592
-5	980	50	1194	105	1404	160	1611
0	1000	55	1213	110	1423	165	1629
5	1020	60	1232	115	1442	170	1648
10	1039	65	1252	120	1461	175	1666
15	1058	70	1271	125	1480	180	1685
20	1078	75	1290	130	1498	185	1703
25	1097	80	1309	135	1415	190	1722
30	1117	85	1328	140	1536	195	1740

MODALITÀ DI FUNZIONAMENTO IN CASO DI GUASTO DEI SENSORI

In caso di guasto di uno dei sensori di temperatura, il regolatore cerca autonomamente la modalità di funzionamento più adeguata.

Il sensore di temperatura esterna non è collegato o non funziona

Il regolatore in questo caso funziona come un regolatore P rispetto alla discrepanza della temperatura interna. Se non funziona neanche il sensore di temperatura interna, il regolatore regola la condotta di mandata in relazione alla temperatura costante, che corrisponde:

- Nel caso di riscaldamento a termosifone di 25 °C superiore all'impostazione della temperatura diurna e notturna
- Nel caso di riscaldamento a pavimento di 10 °C superiore all'impostazione della temperatura diurna e notturna

Il sensore di temperatura della condotta di mandata non è collegato o non funziona

Il regolatore considera che la temperatura della condotta di mandata sia di 120 °C e cessa di riscaldare i locali. Il riscaldamento può essere riattivato solo in modalità manuale.

Il sensore di temperatura interna non è collegato o non funziona

Il regolatore funziona indisturbato in relazione alla temperatura esterna.

Il sensore di temperatura della condotta di ritorno non è collegato o non funziona

Il riscaldamento funziona indisturbato, senza limitazione della differenza tra condotta di mandata e ritorno.

Il sensore della caldaia non è collegato o non funziona

Il regolatore considera che la temperatura della caldaia è di 85 °C e funziona indisturbato.

AMPLIAMENTO DEL SISTEMA A PIÙ CIRCUITI DI RISCALDAMENTO

Con la connessione BUS è possibile collegare tra loro più regolatori CMP25-2.

Importante: *Il sensore della temperatura esterna e il sensore della temperatura della caldaia si allacciano sempre all'ultimo regolatore dipendente*

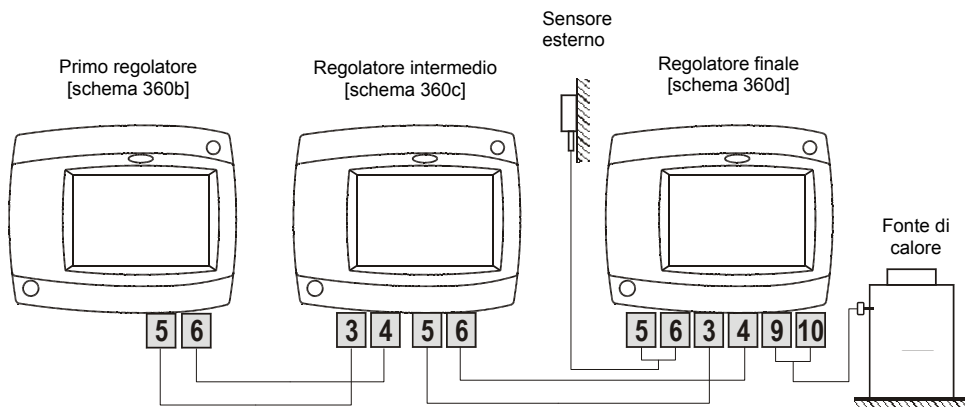

Connessione BUS tra regolatori CMP25-2 con il regolatore WDC10B, WDC10 oppure WDC20:

Con la connessione BUS possiamo allacciare tra di loro un numero qualsiasi di regolatori WDC e CMP25-2. Il primo regolatore (WDC) alimenta fisicamente le fonti di calore, gli altri invece solo i circuiti di riscaldamento.

Importante: *Il sensore della temperatura esterna e della temperatura della caldaia si allacciano sempre al primo regolatore.*

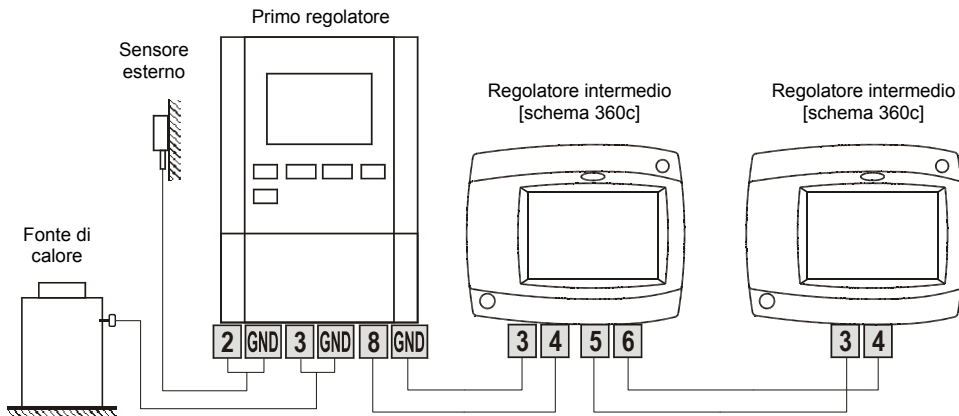

Connessione BUS tra regolatori CMP25-2 con il regolatore D10, D20:

Con la connessione BUS possiamo allacciare tra di loro un numero qualsiasi di regolatori D10/D20 e CMP25-2. Il primo regolatore (D10, D20) alimenta fisicamente le fonti di calore, gli altri invece solo i circuiti di riscaldamento.

Importante: *Il sensore della temperatura esterna e della temperatura della caldaia si allacciano sempre al regolatore principale.*

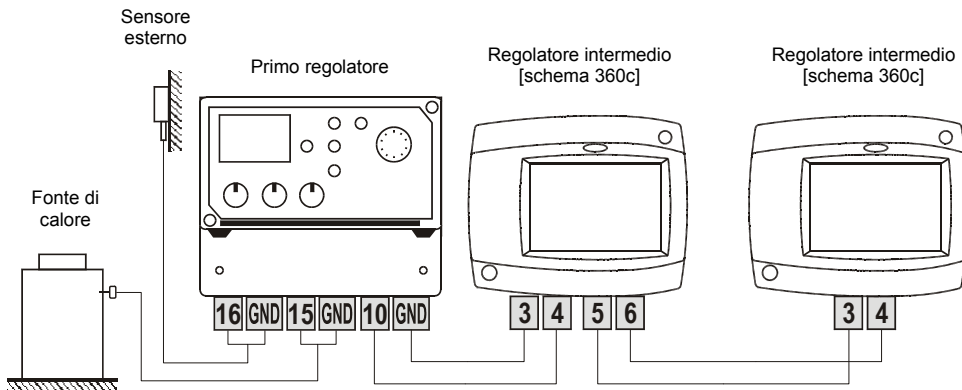

IMPORTANTE

ATTENZIONE: Gli schemi di installazione illustrano il principio di funzionamento e non contengono tutti gli elementi aggiuntivi e di sicurezza. Durante l'installazione attenersi alle disposizioni di legge vigenti

----- Sensore optional. Non è necessario per il funzionamento dello schema.



L'allacciamento dell'unità interno o del sensore interno non è obbligatorio per il funzionamento del regolatore. L'allacciamento dell'unità interna e del sensore interno è descritto a pagina 128.

Schema 360

Circuito di riscaldamento miscelato autonomo

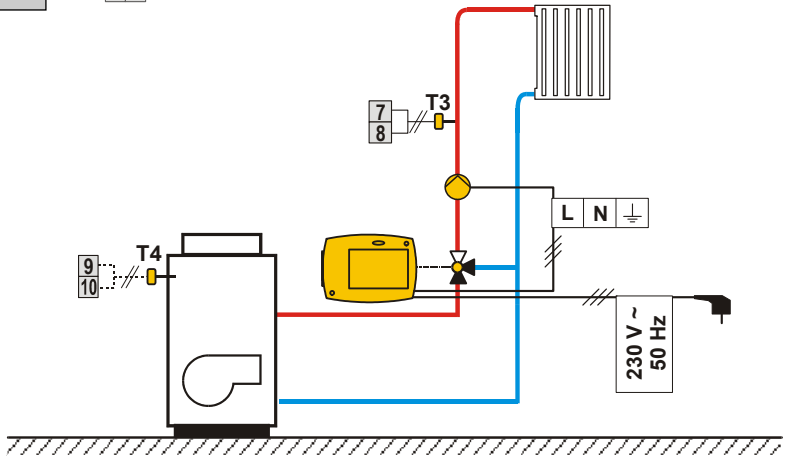
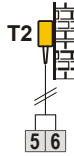

Schema 360b

Diversi circuiti miscelati (primo regolatore in conn. BUSi).

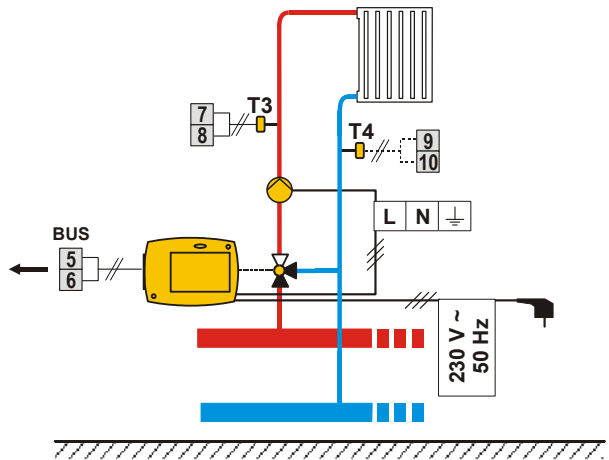
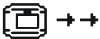

La connessione BUS dei regolatori è descritta a pagina 130 e 131.

Scheme 360c

Diversi circuiti miscelati
(intermedio regolatore in
conn. BUSi).

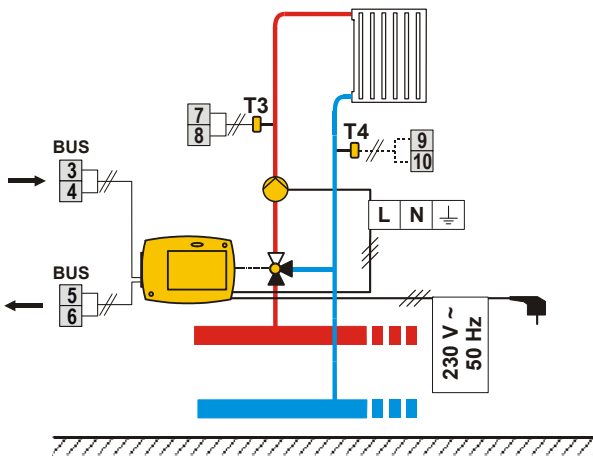

La connessione BUS dei
regolatori è descritta a
pagina 130 e 131.

Scheme 360d

Diversi circuiti miscelati
(ultimo regolatore in
conn. BUSi).

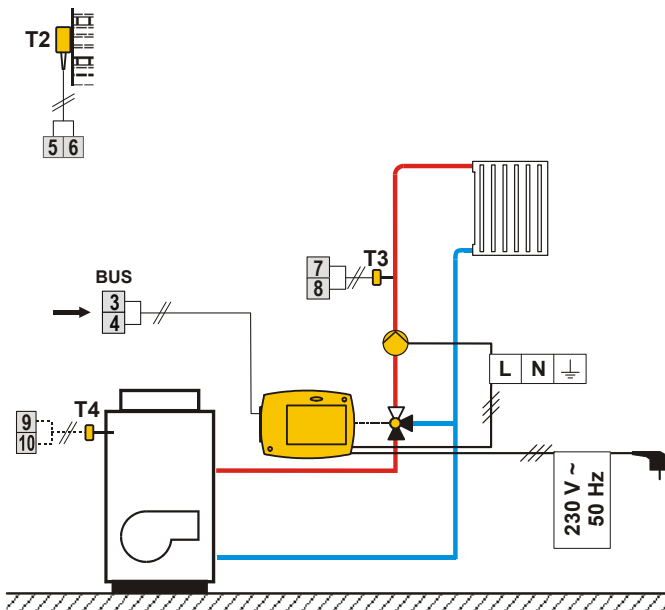
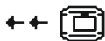

La connessione BUS
dei regolatori è
descritta a pagina
130 e 131.

DATI TECNICI

Dati tecnici generali

Tensione di alimentazione.....	230V~, 50Hz
Consumo di funzionamento.....	max 4 VA
Uscita per la pompa	230V~ / 4 (2) A
Scocca del regolatore.....	ABS – termoplastico
Dimensioni (l x h x s).....	84 x 105 x 100 mm
Peso.....	900 g ÷ 950 g
Colore/Materiale	grigio scuro / PC
Grado di protezione.....	IP24 secondo EN 60529
Classe di protezione.....	II secondo EN 60730-1
Tipo di funzionamento	Tipo 1B secondo EN 60730-1
Temperatura circostante tollerata.....	da 0 a +40°C
Temperatura di conservazione.....	da -20° a +70°C

Caratteristiche tecniche

Intervallo di impostazione della temperatura diurna:	10°C ÷ 30°C
Intervallo di impostazione della temperatura notturna:	10°C ÷ 30°C
Intervallo di impostazione della curva climatica:.....	0,2 ÷ 2,2
Temperatura antigelo:	+ 6°C (impostabile)
Ampiezza della zona morta del regolatore PI:.....	± 0,7K ÷ ± 1,5K
Tipo di sensori di temperatura:	Pt1000 o KTY-10
Orologio programmabile:.....	orologio programmabile multicanale

DICHIARAZIONI

CONFORMITÀ AGLI STANDARD E ALLE NORMATIVE

I regolatori climatici compatti CMP25-2 sono conformi alle disposizioni delle seguenti direttive:

- Direttiva sulla bassa tensione 2006/95/CE (Low voltage directive)
- Direttiva sulla compatibilità elettromagnetica 2004/108/CE (Electromagnetic Conformity)
- Direttiva sulle sostanze pericolose nelle apparecchiature elettriche ed elettroniche 2002/95/CE (Rohs).

DESCRIZIONE DEL PRODOTTO:

Regolatore climatico compatto

NOME DEI MODELLI:

CMP25-2

STANDARD UTILIZZATI:

EN60730-1, EN60730-2-9,
EN60730-2-11, EN60730-2-14,
EN12098-1, EN61000-6-1, EN55014-1.



SMALTIMENTO DELLE APPARECCHIATURE ELETTRICHE ED ELETTRONICHE IN DISUSO

Smaltimento delle apparecchiature elettriche ed elettroniche in disuso (valido per gli Stati membri dell'Unione Europea e gli altri Paesi europei che attuano la raccolta differenziata dei rifiuti)



Questo simbolo, stampato su questo prodotto o sulla relativa confezione, indica che questo prodotto non deve essere smaltito come rifiuto indifferenziato, ma consegnato in un centro di raccolta per apparecchiature elettriche ed elettroniche in disuso. Con il corretto smaltimento di questo prodotto eviterete un impatto negativo sull'ambiente e sulla salute umana che potrebbe essere causato da uno smaltimento inadeguato. Il riciclo dei materiali riduce il consumo di materie prime.

Per maggiori informazioni circa il riciclo di questo prodotto, potete contattare gli uffici competenti, il servizio locale di smaltimento dei rifiuti oppure il negozio in cui è stato acquistato.

PROMATIC CMP25-2



INTRODUCTION

Le régulateur PROMATIC CMP25-2 est d'une conception moderne, un appareil muni de microprocesseurs avec une technologie digitale et SMT.

Il est conçu pour contrôler les mélanges de circuits de chauffage avec radiateurs ou des systèmes de chauffage de surface.

Le CMP25-2 est composé d'un programme minuteur à canaux multiples pour un chauffage ambiant en fonction du temps.

Les régulateurs CMP25-2 peuvent être reliés à un réseau et fonctionnent comme un système de contrôle uniforme pour des circuits de chauffage multiples.



*Pour le réglage initial, voir le **réglage initial du régulateur** en page 141 !*

INDEX

MANUEL D'UTILISATION ET DE RÉGLAGES

DESCRIPTION DU RÉGULATEUR	140
Aspect du régulateur CMP25-2	140
Indication du mode de fonctionnement.....	140
RÉGLAGE INITIAL DU RÉGULATEUR	141
Procédure de réglage initial.....	141
AFFICHAGE PRINCIPAL ET NAVIGATION	143
Description et conception de l'affichage	143
Description des symboles figurant sur l'affichage	143
Symboles des modes de fonctionnement.....	143
Symboles des fonctions d'utilisation	144
Symboles des températures et vue d'ensemble des données	144
Symboles pour la protection des fonctions	145
Symboles de communication des régulateurs dans le réseau	145
Symboles des avis et de avertissements	145
Navigation de base sur l'écran	146
Verrouillage et déverrouillage de l'écran	146
Affichage de l'aide, des avis et des avertissements	147
ACCÈS ET NAVIGATION PAR LE MENU	148
Structure du menu et description	149
Réglage de la température	152
Fonctions d'utilisation	153
Mode de fonctionnement	154
Programmes minuteurs	155
Réglages de base	158
Vue d'ensemble des données	159

MANUEL DE RÉGLAGE

MANUEL DE RÉGLAGE	160
Paramètres de base	160
Courbe de chauffe.....	162
Paramètres de services.....	164
Paramètres de séchage du sol.....	168
Réglages par défaut.....	169

MANUEL DE MONTAGE

INSTALLATION DU RÉGULATEUR	170
Installation sur la vanne mélangeuse	170
Raccordement électrique du régulateur	172
Raccordement des conduites	172
Raccordement des sondes, des unités climatiques et du BUS	172
Raccordement des unités climatique digitale DD2+	173
Raccordement de la sonde de température intérieure	173
Marquage et installation des sondes de température	174
Mode de fonctionnement avec sonde défaillante	175
Expansion du système sur plusieurs circuits de chauffage	175
SCHEMAS HYDRAULIQUE ET ÉLECTRIQUE	177
CARACTÉRISTIQUES TECHNIQUES	180
DÉCLARATIONS ET RECOMMANDATIONS	181
Déclaration de conformité	181
Recyclage des appareils électriques et électroniques.....	181

MANUEL D'UTILISATION ET DE RÉGLAGES

DESCRIPTION DU RÉGULATEUR

ASPECT DU RÉGULATEUR CMP25-2



- ① Affichage graphique avec écran tactile.
- ② Bouton  - Échap (Esc), Aide (Help).

INDICATION DU MODE DE FONCTIONNEMENT



Bouton illuminé :

Vert - fermeture de la vanne mélangeuse.

Rouge - ouverture de la vanne mélangeuse.

RÉGLAGE INITIAL DU RÉGULATEUR

Le régulateur CMP25-2 est équipé d'une solution innovatrice « EASY START » pour un réglage facile avec l'assistant d'installation.

PROCÉDURE DE RÉGLAGE INITIAL

CMP25-2 V1.0r0

Lorsque vous branchez le régulateur à une source électrique pour la première fois ou en faisant une réinitialisation, la version du logiciel est affichée. Ensuite, l'assistant d'installation se met en marche.



ÉTAPE 1 - ORIENTATION DE L'AFFICHAGE

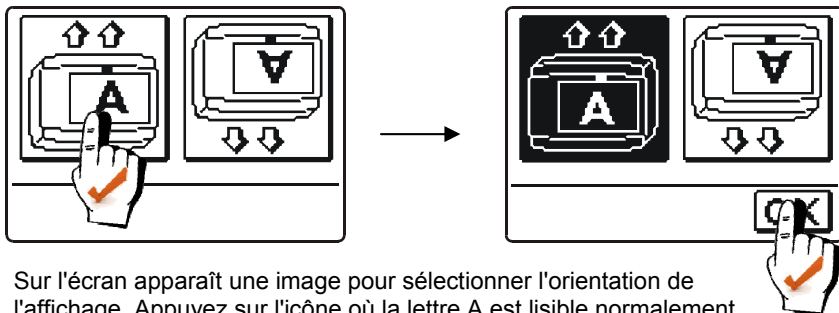

Sur l'écran apparaît une image pour sélectionner l'orientation de l'affichage. Appuyez sur l'icône où la lettre A est lisible normalement. Après avoir sélectionné l'orientation correcte de l'affichage, appuyez sur le bouton **OK** pour confirmer votre sélection.

ÉTAPE 2 - OUVERTURE DE LA VANNE MÉLANGEUSE

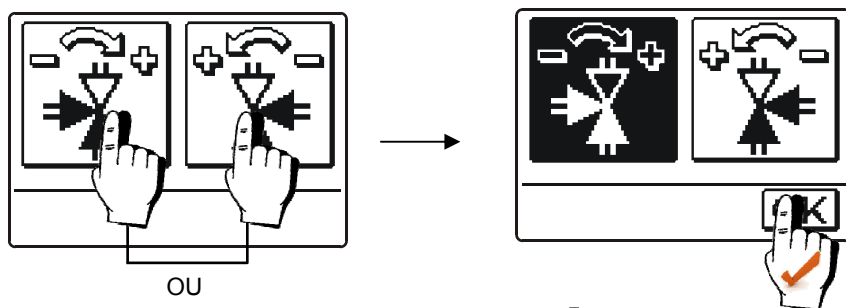

OU

Appuyez sur l'icône qui indique la bonne direction (**+**) de l'ouverture de la vanne mélangeuse. Après avoir sélectionné la bonne direction de l'ouverture de la vanne mélangeuse, appuyez sur le bouton **OK** pour confirmer votre sélection.

Étape 3 - SÉLECTION DE LA LANGUE

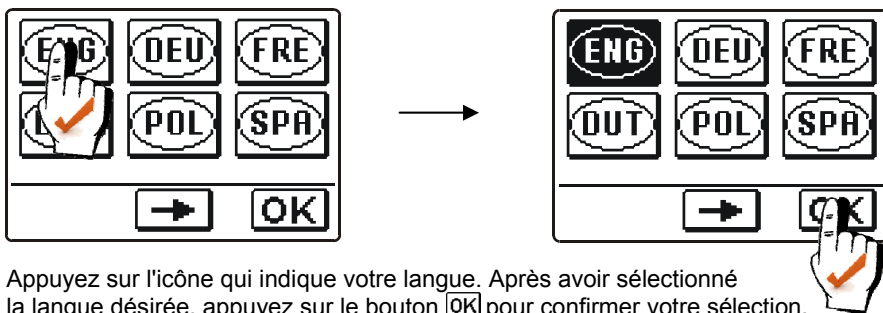

Étape 4 - RÉGIME HYDRAULIQUE

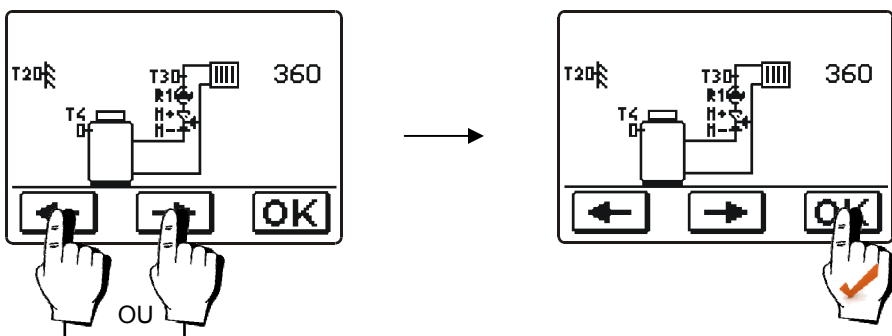

Étape 5 - INCLINAISON DE LA COURBE DE CHAUFFE

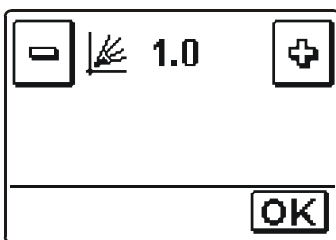

Appuyez sur les boutons **-** ou **+** pour régler l'inclinaison de la courbe de chauffe désirée. Confirmez votre sélection avec le bouton **OK**.

L'inclinaison de la courbe de chauffe est décrite en détail aux pages 162 et 163.



La sélection du régime hydraulique, l'orientation de l'affichage, la rotation de la direction et la langue peuvent être changées à tout moment ou en faisant une réinitialisation du régulateur !



RÉINITIALISATION

Éteindre la source électrique du régulateur. Maintenir le bouton  et allumer la source électrique. Le régulateur se réinitialise et commence le réglage initial.

AFFICHAGE PRINCIPAL ET NAVIGATION

Toutes les données importantes sur le fonctionnement du régulateur sont affichées sur l'écran graphique LCD qui est également destiné au réglage du régulateur.

DESCRIPTION ET CONCEPTION DE L'AFFICHAGE

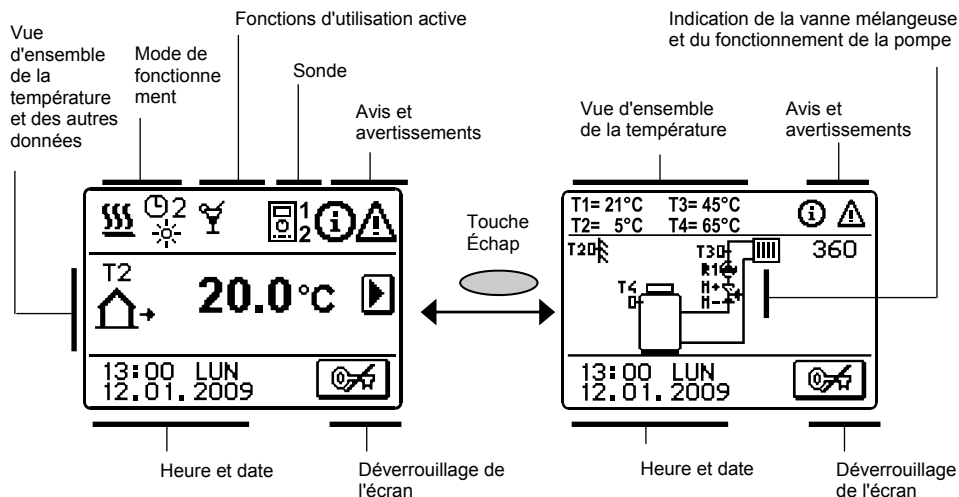









DESCRIPTION DES SYMBOLES FIGURANT SUR L'AFFICHAGE











SYMBOLES DES FONCTIONS D'UTILISATION

Symbole	Description
SSS	Mode de chauffage
☼	Mode de climatisation
G2	Chauffage selon le programme minuteur - température de jour
G2	Chauffage selon le programme minuteur - température de nuit
☼	Chauffage à une température assignée pour la température de jour
☾	Chauffage à une température assignée pour la température de nuit
⏻	Éteindre
✋	Mode manuel



SYMBOLES DU MODE D'UTILISATION

Symbole	Description
	Mode Fête activé
	Mode Éco activé
	Mode Vacances activé
	Mode Séchage du sol activé 01/ - jour de séchage 25 durées du séchage (jours)
	Changement automatique en mode été
	Chauffage avec température de départ constante activé
	Activation à distance
	Augmentation du chauffage







SYMBOLES POUR LA TEMPÉRATURE ET VUE D'ENSEMBLE DES DONNÉES

Symbole	Description
	Température mesurée
	Température assignée ou calculée
	Température intérieure
	Température extérieure
	Température de départ
	Température de retour
	Température de la chaudière
	Vanne mélangeuse - fermeture (le clignotement indique la tendance à la fermeture)
	Vanne mélangeuse - fermeture (le clignotement indique la tendance à l'ouverture)
	Pompe de circulation
T1, T2, T3, T4	Température mesurée sur les sondes T1, T2, T3 ou T4.
TR	Température mesurée sur l'unité climatique DD2+.
TA	Température extérieure obtenue par l'intermédiaire d'un racc.BUS.
TQ	Température de la chaudière obtenue par l'intermédiaire d'un racc. BUS.

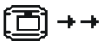

SYMBOLES DE PROTECTION DES FONCTIONS

Symbole	Description
	Protection contre la surchauffe de la chaudière à combustible liquide
	Protection contre le gel (intérieur)









SYMBOLES DE COMMUNICATION DES RÉGULATEURS DANS UN RÉSEAU

Symbole	Description
	Appareils raccordés à la ligne de communication COM1
	Première (1) ou deuxième (2) unité climatique DD2+ branchée
	Ordre de raccordement de régulateurs et de BUS COM1 / COM2
	Régulateur indépendant - n'est pas relié au BUS
	Premier régulateur relié au BUS
	Régulateur intermédiaire relié au BUS
	Dernier régulateur relié au BUS

SYMBOLES DES AVIS ET DES AVERTISSEMENTS

Symbole	Description
	<p>Avis</p> <p>En cas de dépassement de la température maximale de l'activation de la fonction de protection, le régulateur indique l'événement avec un symbole clignotant sur l'affichage. Si la température maximale n'est plus dépassée ou si la fonction de protection est désactivée, un symbole illuminé indique l'événement récent.</p> <p>Appuyez sur HELP pour ouvrir l'écran et vérifier les avis.</p>
	<p>Avertissement</p> <p>En cas de défaillance de la sonde, du BUS ou de la connexion COM, le régulateur indique la défaillance avec un symbole clignotant sur l'affichage. Si le problème est résolu ou n'existe plus, un symbole illuminé indique un événement récent.</p> <p>Appuyez sur HELP pour ouvrir l'écran et vérifier les avis.</p>

NAVIGATION DE BASE SUR L'ÉCRAN

Bouton	Fonction du bouton
	Verrouillage / Déverrouillage de l'écran
	Aide
	Accès au menu
	Continuation à l'information suivante
	Continuation / Retour dans le menu ou les informations
	Augmentation / Diminution de la valeur de la donnée
	Confirmation
	Confirmation et retour au menu précédent ou sélection

VERROUILLAGE ET DÉVERROUILLAGE DE L'ÉCRAN

Pour modifier un réglage du régulateur ou pour une vue d'ensemble des données. Appuyez sur le bouton  pour déverrouiller l'écran. L'écran se verrouille automatiquement lorsqu'aucun bouton n'est activé pendant plus de 60 secondes.

AFFICHAGE DE L'AIDE, DES AVIS ET DES AVERTISSEMENTS

D'abord déverrouillez l'écran en appuyant sur le bouton . Puis, appuyez sur le bouton **HELP** pour ouvrir l'écran d'aide, des avis et des avertissements.

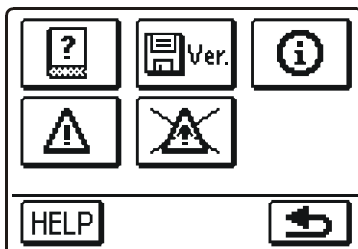

Possibilités disponibles :



Court manuel

Court manuel pour l'utilisation du régulateur





Version du régulateur

Vue d'ensemble du type de régulateur et de la version du logiciel





Avis

Liste de dépassements de la température maximale et des fonctions de protection activées. En appuyant sur les boutons  et , passez à travers la liste des avis. Appuyez sur  pour sortir de la liste.



Avertissements

Liste des défaillances de sondes et autres composants.

En appuyant sur les boutons  et , passez à travers la liste des avertissements. Appuyez sur  pour sortir de la liste.





Supprimer les avertissements

En appuyant sur ce bouton, toutes les sondes qui ne sont pas branchées seront supprimées de la liste des défaillances.

Note : Les défaillances des sondes qui sont requises pour le fonctionnement du régulateur ne peuvent pas être supprimées.

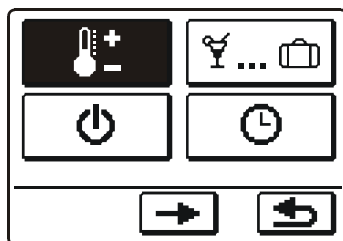
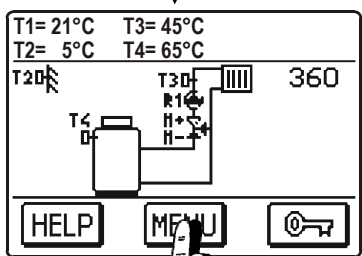
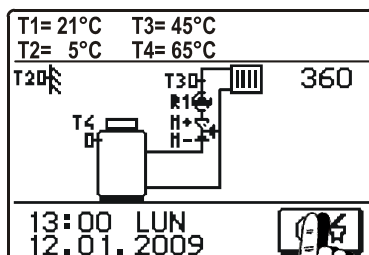
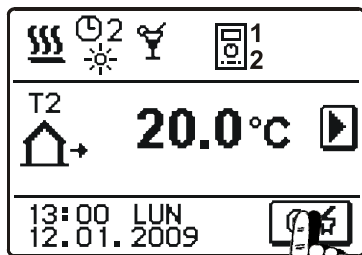

ACCÈS ET NAVIGATION DANS LE MENU

Pour déverrouiller l'écran, appuyez sur le bouton . Pour accéder au menu, appuyez sur le bouton .



Pour naviguer dans le menu, appuyez sur les icônes de l'écran.



Si le menu contient plus qu'un écran complet de sélections, appuyez sur le bouton  pour passer à l'écran suivant ou sur le bouton  pour revenir à l'écran précédent.

STRUCTURE DU MENU ET DESCRIPTION



RÉGLAGES DE LA TEMPÉRATURE



Température de jour



Température de nuit

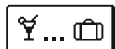

FONCTIONS D'UTILISATION



Fête



Éco



Vacances



Désactivation de la fonction



MODES DE FONCTIONNEMENT



Mode de fonctionnement avec programme minuteur



Mode de fonctionnement pour température de jour



Mode de fonctionnement pour température de nuit



Éteindre



Sélection du mode de fonctionnement Chauffage ou Climatisation



Manuel du mode de fonctionnement



PROGRAMMES MINUTEURS



Programme minuteur 1



Programme minuteur 2



Programme minuteur 3



Programme minuteur 4

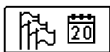

RÉGLAGES DE BASE



Langue

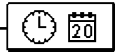

Heure et date



AFFICHAGE DU RÉGLAGE

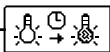

Durée de l'illumination de l'écran



Intensité de l'illumination de l'écran actif



Intensité de l'illumination de l'écran au repos



Contraste



VUES D'ENSEMBLE DES DONNÉES



Diagrammes des températures mesurées pour la dernière semaine

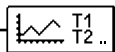

Diagrammes des températures mesurées pour la dernière journée

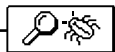

Données de services spéciaux



PARAMÈTRES DU RÉGULATEUR



Réglages de base



Réglages pour le circuit de chauffage



Réglages de la source de chaleur



PARAMÈTRES DE SERVICES



Réglages de base



Réglages pour le circuit de chauffage

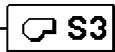

Réglages de la source de chaleur



RÉGLAGES PAR DÉFAUT



Réinitialisation de tous les paramètres du régulateur



Réinitialisation de tous les programmes minuteurs



Réinitialisation du réglage du régulateur et recommencement du réglage initial



Sauvegarder et les réglages d'utilisation



Mettre les réglages d'utilisation





RÉGLAGE DE LA TEMPÉRATURE

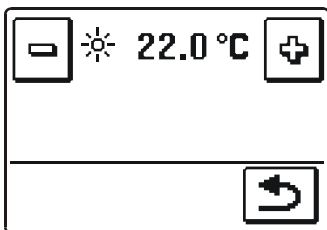

Réglage de la température de jour





Utilisez les boutons  et  pour régler la température.
Confirmez et revenez à l'écran précédent en appuyant sur le bouton .

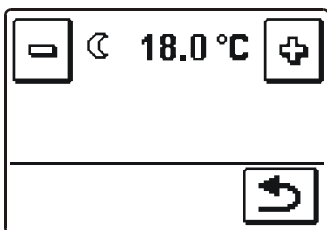

Réglage de la température de nuit



Utilisez les boutons  et  pour régler la température.
Confirmez et revenez à l'écran précédent en appuyant sur le bouton .

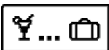

FONCTIONS D'UTILISATION

Les fonctions de l'utilisateur offrent un confort additionnel et des avantages liés à l'utilisation du régulateur. Les fonctions de l'utilisateur suivantes sont disponibles dans le menu :



Mode - Fête

Appuyez sur l'icône **FÊTE** pour activer le mode de fonctionnement de la température de confort. Pour ajuster la fonction, appuyez encore une fois sur l'icône FÊTE. Un nouvel écran s'ouvre, utilisez les boutons et pour régler la température et l'heure à laquelle la fonction s'arrêtera.

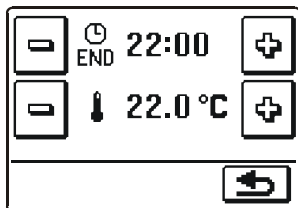

— Réglage de l'heure à laquelle la fonction s'arrêtera

— Réglage de la température



Mode - Éco

Appuyez sur l'icône **ÉCO** pour activer le mode de fonctionnement de la température économique. Pour ajuster la fonction, appuyez encore une fois sur l'icône ÉCO. Un nouvel écran s'ouvre, utilisez les boutons et pour régler la température et l'heure à laquelle la fonction s'arrêtera.

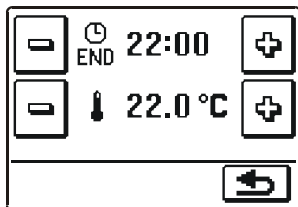

— Réglage de l'heure à laquelle la fonction s'arrêtera

— Réglage de la température



Mode VACANCES

Appuyez sur l'icône **VACANCES** pour activer le mode de fonctionnement de la température de confort. Pour ajuster la fonction, appuyez encore une fois sur l'icône VACANCES. Un nouvel écran s'ouvre, utilisez les boutons et pour régler la température et l'heure à laquelle la fonction s'arrêtera.

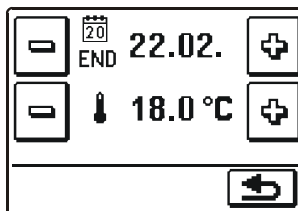

— Réglage de l'heure à laquelle la fonction s'arrêtera

— Réglage de la température

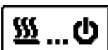



MODE DE FONCTIONNEMENT

Six modes de fonctionnement sont disponibles :



Fonctionnement selon un programme minuteur.

Le fonctionnement s'effectue selon le programme minuteur sélectionné. Si une unité climatique est reliée, l'icône  apparaît (le nombre indique la pièce que l'unité climatique contrôle). Si le régulateur fonctionne sans unité climatique de contrôle, l'icône  apparaît.



Fonctionnement selon la température de jour

Le régulateur fonctionne en mode température de jour.



Fonctionnement selon la température de nuit

Le régulateur fonctionne en mode température de nuit.



Éteindre

Sélectionnez cette fonction pour éteindre le régulateur. La protection contre le gel reste active lors du chauffage et la protection contre la surchauffe lors de la climatisation.



Sélection du mode de fonctionnement de chauffage ou de refroidissement.



Le contrôle de refroidissement est thermostatique selon la température ambiante choisie et une température constante de la température de départ



Pour le mode de fonctionnement pour la climatisation, il est nécessaire de brancher une sonde ou une unité climatique et d'activer le système d'alimentation en eau froide.



Mode manuel

Ce mode est utilisé pour tester le système de chauffage ou en cas de fonctionnement défectueux.

Un nouvel écran s'ouvre et vous pouvez ouvrir ou fermer manuellement la vanne mélangeuse et allumer ou fermer la pompe de circulation.

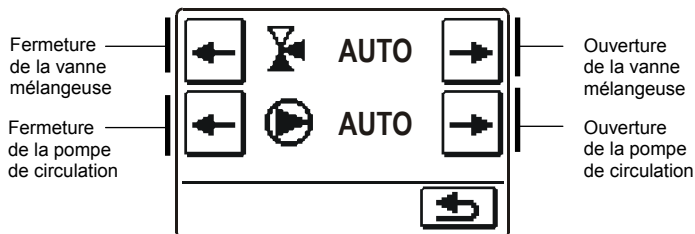



Appuyez sur le bouton  pour confirmer et revenir à l'écran précédent.

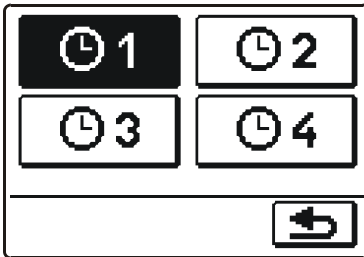

Sélection du programme minuteur

Quatre programmes minuteurs indépendants sont disponibles.





Lorsque le programme requis est sélectionné, appuyez sur le bouton  pour confirmer et revenir à l'écran précédent.

Copier et modifier le programme minuteur

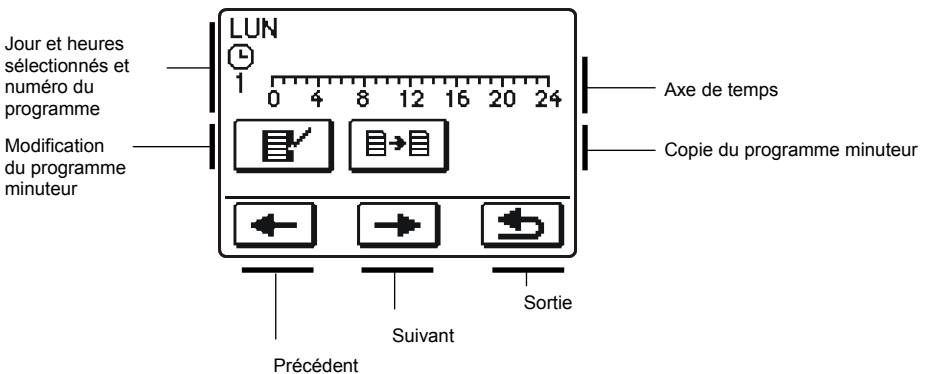
Si vous appuyez sur l'icône du programme minuteur déjà sélectionné, une nouvelle fenêtre s'ouvre.







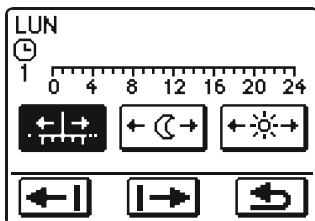

D'abord, en appuyant sur les boutons  et , sélectionnez le jour ayant le programme que vous voulez modifier ou copier aux autres jours.

Modifier le programme minuteur



Les icônes sur l'écran ont la signification suivante :



- | | | | |
|--|---|---|---|
|  | Mouvement libre du curseur |  | Aller vers la gauche. |
|  | Intervalle de la température de nuit / effacer l'intervalle de la température de jour |  | Aller vers la droite |
|  | Intervalle de la température de jour / effacer l'intervalle de la température de nuit |  | Enregistrer les modifications du programme minuteur et retour à l'écran précédent |

Avec l'aide des icônes ci-dessus mentionnées, nous établissons le programme minuteur.

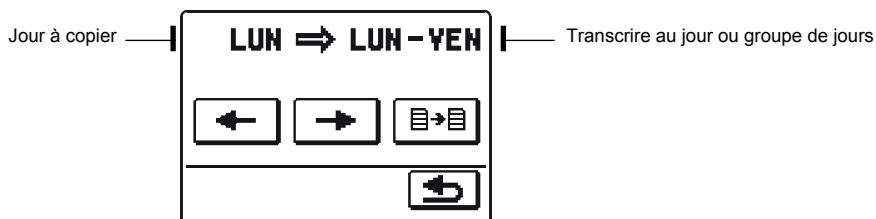
Copier le programme minuteur



Les icônes sur l'écran ont les significations suivantes :

- | | | |
|---|---|--|
|  |  | Sélection du jour ou de plusieurs jours ensemble (LUN, MAR, MER, JEU, VEN, SAM, DIM, LUN-VEN, LUN-DIM, SAM-DIM) duquel ou desquels vous voulez copier le programme minuteur. |
|  | Copie. | |

Réglage par défaut des programmes minuteurs

🕒 1

Jour	Périodes de température de jour
LUN - VEN	06:00 - 22:00
SAM - DIM	07:00 - 22:00

🕒 2

Jour	Périodes de température de jour
LUN - VEN	05:00 - 7:30 13:30 - 22:00
SAM - DIM	07:00 - 22:00

🕒 3

Jour	Périodes de température de jour
LUN - VEN	06:00 - 08:30 11:00 - 13:30 16:00 - 22:00
SAM - DIM	07:00 - 22:00

🕒 4

Jour	Périodes de température de jour
LUN - VEN	14:00 - 22:00
SAM - DIM	07:00 - 22:00

FRE



RÉGLAGES DE BASE



Le menu est prévu pour la langue, l'heure, la date et les réglages d'affichage.

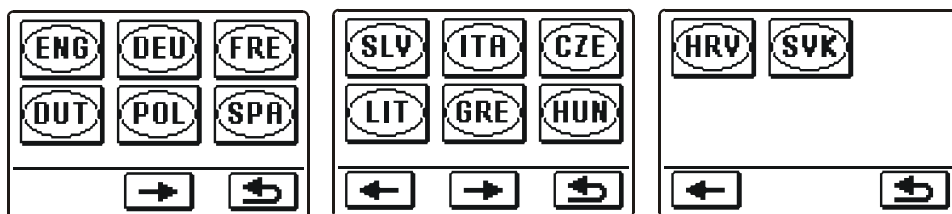

Langue

L'écran pour la sélection de la langue est ouvert :



Utilisez les boutons  et  pour naviguer à travers la sélection de langues.

Sélectionnez la langue désirée en appuyant sur l'icône. Confirmez votre sélection et retour à l'écran précédent en appuyant sur le bouton .

FRE

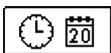

Heure et date

L'écran pour le réglage de l'heure et de la date est ouvert :

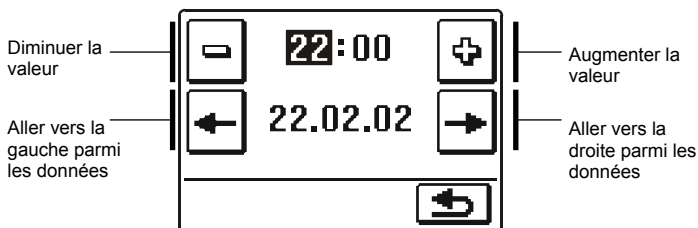

Confirmez votre sélection et retour à l'écran précédent en appuyant sur le bouton .



Affichage des réglages

Il y a quatre réglages disponibles :



Temps de l'illumination active et sortie automatique du menu





Intensité de l'illumination active



Intensité de l'illumination inactive



Contraste

Changez chaque réglage à l'aide des boutons  et . Confirmez votre sélection et retour à l'écran précédent en appuyant sur le bouton .



VUE D'ENSEMBLE DES DONNÉES

Dans le menu, il y a des icônes pour accéder aux informations suivantes concernant le fonctionnement du régulateur :

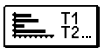

DIAGRAMMES DES TEMPÉRATURES MESURÉES LA SEMAINE DERNIÈRE

Représentation graphique des températures pour chaque sonde, par jour.
Les températures enregistrées sont celles de la dernière semaine de fonctionnement.

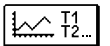

DIAGRAMMES DES TEMPÉRATURES MESURÉES LE DERNIER JOUR



Représentation graphique détaillée des températures des sondes pour la journée en cours.
La fréquence des enregistrements est réglée avec le paramètre P1.
Un tel affichage de la température est utilisé principalement pour l'analyse du système de chauffage au départ, en service ou en cas de défaillance.



DONNÉES SUR LES SERVICES SPÉCIAUX

Données de diagnostics pour le département de service.



Vous pouvez naviguer entre les différents graphiques des sondes individuelles avec le bouton . Utilisez et les boutons  et  pour naviguer entre les différents jours.

MANUEL DE RÉGLAGES

PARAMÈTRES DU RÉGULATEUR

Tous les réglages additionnels et les ajustements de la performance du régulateur sont réalisés par le biais de paramètres. Trois groupes de paramètres sont disponibles.

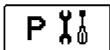

Paramètres de base

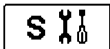

Paramètres des services

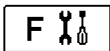

Paramètres de séchage du sol



Nous voyons seulement les paramètres qui sont utilisés dans le schéma hydraulique. Les valeurs des paramètres par défaut dépendent aussi des schémas hydrauliques sélectionnés.

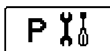

PARAMÈTRES DE BASE

Les paramètres de base sont listés dans les groupes **P1** - Réglages de base, **P2** - Réglages pour le circuit de chauffage, **P3** - Réglages pour les sources de chaleur.

Le contenu des paramètres de base est affiché de la façon suivante :

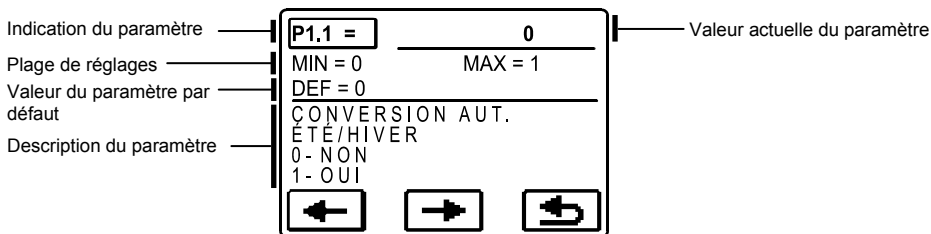

La modification du paramètre désiré est illustrée dans l'exemple ci-dessous, pour le paramètre P1.1

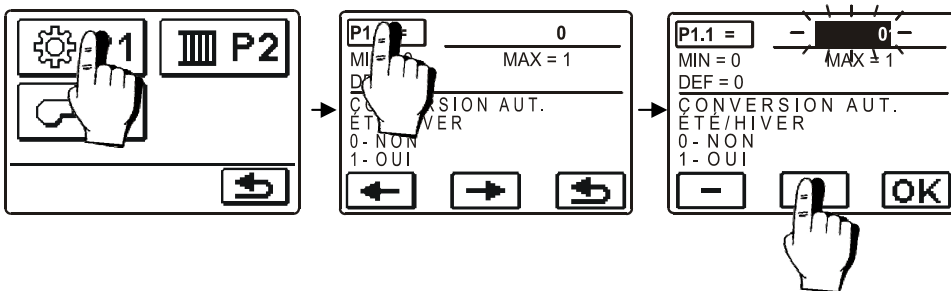

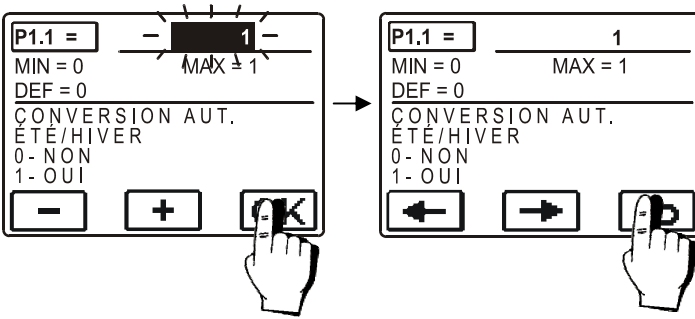

Réglages de base P1 :

Paramètre	Description du paramètre	Description	Possibilités de réglage	Valeur reprise
P1.1	CONVERSION AUTOMATIQUE ÉTÉ/HIVER	La régulation commute automatiquement sur l'horaire été/hiver.	0- NON 1- OUI	1
P1.2	TEMPÉRATURE EXTÉRIEURE MOYENNE POUR LE CHANGEMENT ÉTÉ/HIVER	Ce réglage définit la température extérieure moyenne quotidienne à laquelle le chauffage s'éteint automatiquement.	10 ÷ 30 °C	18
P1.4	TEMPÉRATURE AMBIANTE EN PROTECTION CONTRE LE GEL	Sélectionnez la température souhaitée pour la période où le chauffage est éteint.	2 ÷ 12°C	6
P1.5	REPRÉSENTATION DE L'ARRONDI DE TEMPÉRATURE	Détermination de la représentation de l'arrondi de la température mesurée.	0- 0.1 °C 1- 0.2 °C 2- 0.5 °C 3- 1 °C	2
P1.6	CONVERSION AUTOMATIQUE HEURE ÉTÉ/HIVER	La régulation commute automatiquement sur l'horaire été/hiver.	0- NON 1- OUI	1
P1.7	PÉRIODE D'ENREGISTREMENT	Ce réglage permet de déterminer les intervalles de temps pour la mesure de température.	1 ÷ 30 min	5
P1.8	SONNERIES	Ce réglage définit quand le régulateur émet un signal sonore.	0- DÉSACTIVÉ 1- BOUTONS	1
P1.9	REPRÉSENTATION AVANCÉE DES TEMPÉRATURES	Lors de la navigation parmi les valeurs de température, les températures actuelle, cible ou calculée sont affichées.	0- NON 1- OUI	1

FRE

Réglages pour le circuit de chauffage



Paramètre	Description du paramètre	Description	Possibilités de réglage	Valeur reprise
P2.1	COURBE DE CHAUFFE	L'inclinaison de la courbe de chauffe nous indique la température requise pour les corps de chauffage pour une température extérieure déterminée. Le réglage de l'inclinaison dépend du type de système de chauffage (sol, mur, radiateurs, convecteurs de chauffage) et de l'isolation du bâtiment.	0,2 ÷ 2,2	0,7 - sol 1,0 - radiateurs
P2.2	MOUVEMENT PARALLÈLE DE LA COURBE DE CHAUFFE	Mouvement parallèle de la courbe de chauffe (température calculée de départ). Utilisez ce réglage pour éliminer les variations entre la température ambiante désirée et réelle.	-15 ÷ 15 K	0
P2.3	DURÉE DE L'AUGMENTATION DU CHAUFFAGE	Durée de l'augmentation de la température ambiante en changeant du mode chauffage de nuit au mode chauffage de jour.	0 ÷ 200 min	0
P2.4	HAUSSE DE TEMPÉRATURE PAR AUGMENTATION DU CHAUFFAGE	Réglage de la hausse de température en changeant du mode chauffage de nuit au mode chauffage de jour.	0 ÷ 8 K	4
P2.5	PRIORITÉ DU RÉCHAUFFEMENT DES EAUX SANITAIRES	Réglage si le réchauffement des eaux sanitaires a priorité sur le chauffage ambiant.	0- NON 1- OUI	0



Réglages pour la source de chaleur

Paramètre	Description du paramètre	Description	Possibilités de réglage	Valeur reprise
P3.1	TEMPÉRATURE MINIMUM DE LA CHAUDIÈRE	Réglage de la température minimum de la chaudière.	10 ÷ 90 °C	40

COURBE DE CHAUFFE

L'inclinaison de la courbe de chauffe nous indique la température requise pour les corps de chauffage pour une température extérieure déterminée. Le réglage de l'inclinaison dépend du type de système de chauffage (sols, murs, radiateurs, convecteurs de chauffage) et de l'isolation du bâtiment.

Réglage de l'inclinaison de la courbe de chauffe

Si vous avez assez de données, vous pouvez déterminer l'inclinaison de la courbe de chauffe par un calcul, ou par expérience, à partir d'une évaluation du système de chauffage et de l'isolation du bâtiment.

L'inclinaison est configurée correctement lorsque la température ambiante demeure stable, même lors de grandes différences de température extérieure.

Jusqu'à ce que la température extérieure demeure au-dessus de + 5 °C, vous pouvez ajuster la température ambiante en changeant entre la température de jour ou de nuit, ou avec un décalage parallèle de la courbe de chauffe.

Si la température ambiante se refroidit lors d'une chute de température extérieure, alors l'inclinaison de la courbe de chauffe est configurée trop basse - vous devriez augmenter le réglage.

Si la température ambiante se réchauffe lors de température extérieure plus chaude, l'inclinaison de la courbe de chauffe a besoin d'être réduite. L'augmentation ou la réduction maximum de l'inclinaison de la courbe de chauffe ne devrait pas être supérieure à 0,1 ou 0,2 unité lors d'une observation. Une période d'au moins 24 heures doit passer entre deux observations.

Réglages préférés de l'inclinaison de la courbe de chauffe :

Système de chauffage :	Réglage de l'écart :
Chauffage par le sol	0,2 - 0,8
Chauffage par le mur	0,6 - 1,0
Chauffage par radiateurs	0,8 - 1,4



En ajustant l'inclinaison de la courbe de chauffe, le régulateur est réglé avec le bâtiment. Pour un fonctionnement optimal du régulateur, le bon réglage de l'inclinaison de la courbe de chauffe est très important.

Diagramme de la courbe de chauffe

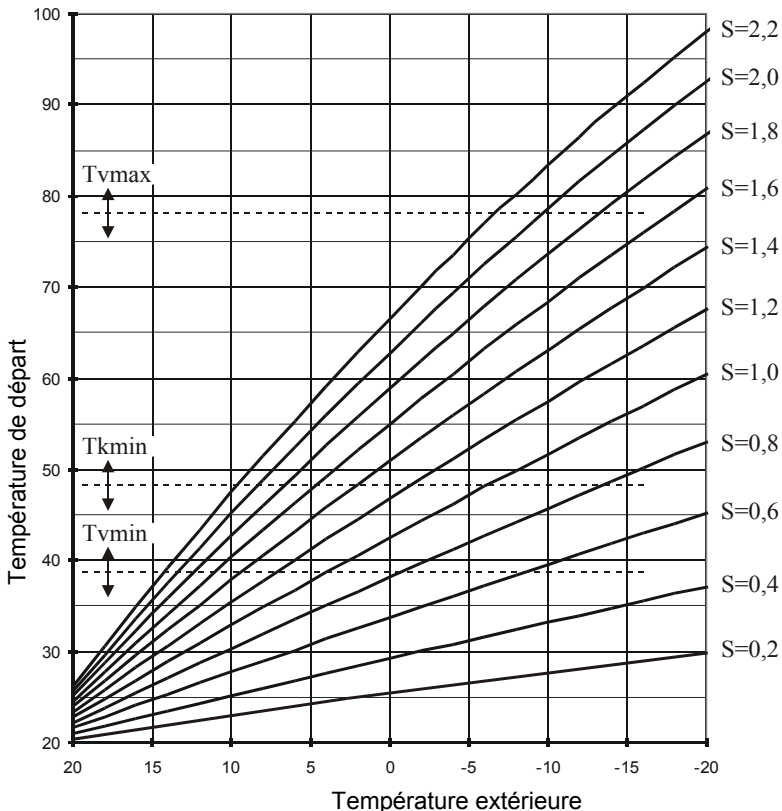

FRE

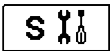

PARAMÈTRES DE SERVICES

Les paramètres de services sont classés dans les groupes **S1** - Réglages de base, **S2** - Réglages pour le circuit de chauffage, **S3** - Réglages pour la source de chaleur.

Le contenu des paramètres de services sont affichés de la façon suivante :

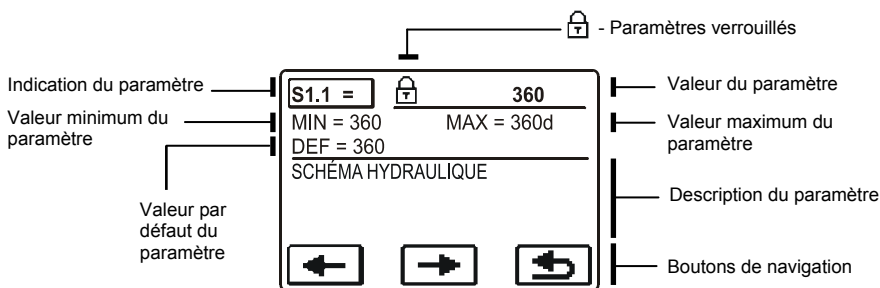

Les paramètres désirés changent de la même façon que les paramètres de base P. Les paramètres de services sont verrouillés et doivent être déverrouillés avant de changer le code.

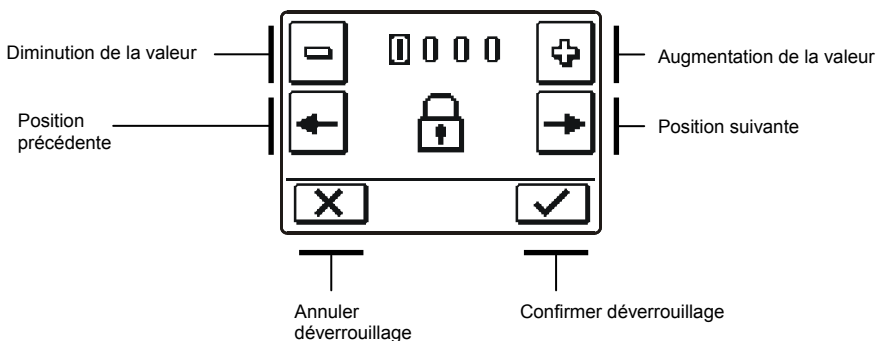

Le code de déverrouillage par défaut pour les paramètres de services est 0001.

Réglages de base



Para- mètre	Description du paramètre	Description	Possibilités de réglage	Valeur reprise
S1.1	SCHÉMA HYDRAULIQUE	Choix du schéma hydraulique	360 ÷ 360d	360
S1.2	CODE BLOQUÉ POUR LA MISE À NU DES RÉGLAGES D'ENTRETIEN	Le réglage permet une modification du code, nécessaire à la mise à nu du réglage d'entretien. ATTENTION! Enregistrez directement le code, car sans celui-ci il est impossible de procéder aux réglages d'entretien.	0000 - 9999	0001
S1.3	TYPE SONDE TEMPÉRATURE	Choisir le type de sonde Pt1000 ou KTY10.	0- PT1000 1- KTY10	0
S1.4	SENS DE L'OUVERTURE DE L'ACTIONNEUR	Réglage du sens de l'ouverture de l'actionneur- ouverture de vanne mélangeuse.	0- DROITE 1- GAUCHE	0
S1.5	ORIENTATION DE L'AFFICHAGE	Réglage de l'orientation de l'affichage.	0- NORMAL 0° 1- ROTATION DE 180°	0
S1.6	SÉLECTION DE LA SONDE T4	Ce réglage détermine le mode de fonctionnement de la sonde T4. Lorsque la sonde de température de retour est sélectionnée, le paramètre S2.13 définit la différence maximale entre la température de départ et la température de retour.	0- TEMP. AMBIANTE 1- TEMP. DE RETOUR	0
S1.7	SÉLECTION DE LA SONDE T1	Ce réglage détermine le mode de fonctionnement de la sonde T1. Lorsque la sonde de température de retour est sélectionnée, le paramètre S2.13 définit la différence maximale entre la température de départ et la température de retour.	0- TEMP. DE LA CHAUDIÈRE 1- TEMP. DE RETOUR	0
S1.8	ACTIVATION À DISTANCE VIA BUS	La sélection de l'activation à distance se fait pour une activation locale ou pour une activation du régulateur maître.	1- LOCALE 2- RÉGULATEUR MAÎTRE	1
S1.9	FONCTION ANTI-BLOCAGE DES POMPES ET SOUPAPES	Si, pendant la semaine, aucune sortie de relais n'est utilisée, démarrage automatique le vendredi à 20h00 pour une durée de 60 secondes.	0- OFF 1- ON	0
S1.17	EQUILIBRAGE SONDE T1	Tout écart de la température mesurée par la sonde T1 peut être corrigé via ce paramètre.	-5 à +5 K	0
S1.18	EQUILIBRAGE SONDE T2	Tout écart de la température mesurée par la sonde T2 peut être corrigé via ce paramètre.	-5 à +5 K	0
S1.19	EQUILIBRAGE SONDE T3	Tout écart de la température mesurée par la sonde T3 peut être corrigé via ce paramètre.	-5 à +5 K	0
S1.20	EQUILIBRAGE SONDE T4	Tout écart de la température mesurée par la sonde T4 peut être corrigé via ce paramètre.	-5 à +5 K	0

Réglages pour le circuit de chauffage :

Paramètre	Description du paramètre	Description	Possibilités de réglage	Valeur reprise
S2.1	INFLUENCE SUR LA DÉVIATION DE LA TEMPÉRATURE AMBIANTE	Ceci règle de combien l'écart de température ambiante devrait augmenter. Un montant inférieur signifie une plus petite influence tandis qu'un montant supérieur signifie une plus grande influence.	0,0 ÷ 3,0	1
S2.2	INFLUENCE DE LA SONDE DE TEMPÉRATURE AMBIANTE T1	Ce réglage détermine si la sonde de température ambiante influe sur le fonctionnement de contrôle. Cette fonction ne s'applique que si la sonde d'ambiance est sélectionnée au paramètre S1.6 (S1.6=0).	0- NON 1- OUI	1
S2.3	INFLUENCE DE LA SONDE DD2+	Ce réglage détermine si la sonde de température ambiante influe sur le fonctionnement du contrôle. #1 signifie que seule la sonde de la première pièce a une influence #2 signifie que seule la sonde de la deuxième pièce a une influence #1&2 signifie que la première et la deuxième sonde de température ambiante ont une influence AUTO signifie que la sonde de température ambiante qui contrôle le circuit de chauffage a une influence.	1 - AUTO 2 - #1 3 - #2 4 - #1&2 5 - NON	1
S2.4	MODE DE FONCTIONNEMENT DE LA POMPE DE CIRCULATION	Ce réglage définit le mode de fonctionnement de la pompe de circulation. Explication des réglages : 1- STAND. (Vanne mélangeuse de pompe de circulation - standard) 2- P1 (fonctionnement selon le programme minuteur P1) 3- P2 (fonctionnement selon le programme minuteur P2) 4- P3 (fonctionnement selon le programme minuteur P3) 5- P4 (fonctionnement selon le programme minuteur P4) 6- SEL. PR. (fonctionnement selon le programme minuteur sélectionné)	1- ST. 2- P1 3- P2 4- P3 5- P4 6- SEL. PR.	1
S2.5	TEMPÉRATURE MINIMUM DE DÉPART	Réglage de la limite minimum de la température de départ.	10 ÷ 90 °C	20
S2.6	TEMPÉRATURE MAXIMUM DE DÉPART	Réglage de la limite maximum de la température de départ.	20 ÷ 150°C	45 - sol 85 - radiateurs
S2.7	ZONE MORTE DU RÉGULATEUR DE LA VANNE MÉLANGEUSE	Réglage de l'intervalle de température de départ à laquelle la vanne mélangeuse est en attente.	1,0 ÷ 3,0 K	1
S2.8	CONSTANTE P DE LA VANNE MÉLANGEUSE	Ce réglage détermine l'intensité avec laquelle le régulateur ajuste la position de la vanne mélangeuse. Un montant inférieur signifie des mouvements plus courts tandis qu'un montant supérieur signifie des mouvements plus longs de la vanne mélangeuse.	0,5 ÷ 2,0	1
S2.9	CONSTANTE I DE LA VANNE MÉLANGEUSE	Ce réglage détermine la fréquence à laquelle le régulateur ajuste la position de la vanne mélangeuse. Un montant inférieur signifie des ajustements moins fréquents de la position de la vanne mélangeuse tandis qu'un montant supérieur signifie des ajustements plus fréquents.	0,4 ÷ 2,5	1

Paramètre	Description du paramètre	Description	Possibilités de réglage	Valeur reprise
S2.10	CONSTANTE D DE LA VANNE MÉLANGEUSE	Sensibilité de la vanne mélangeuse pour les changements de température de départ. Une petite valeur signifie une petite sensibilité, une plus grande valeur signifie une plus grande sensibilité.	0,4 ÷ 2,5	1
S2.11	TEMPÉRATURE MINIMUM DE DÉPART POUR LA RÉFRIGÉRATION	Réglage de la température minimum de départ en mode Réfrigération. Attention ! Une température de départ trop basse peut provoquer la condensation des corps de chaleur et de la tuyauterie.	10 ÷ 20°C	15
S2.12	DÉPLACEMENT DE LA TEMPÉRATURE DE FERMETURE DU CHAUFFAGE	Ce réglage change la température calculée de la température de départ à laquelle le chauffage s'éteint.	-10 ÷ 10°C	0
S2.13	LIMITATION DE LA DIFFÉRENCE ENTRE LA TEMPÉRATURE DE DÉPART ET DE RETOUR	Ce réglage détermine la différence maximale autorisée entre la température de départ et la température de retour. Il est utilisé pour limiter la puissance maximale du circuit de chauffage.	3 ÷ 30 K	10
S2.14	TEMPÉRATURE CONSTANTE DE DÉPART	Ce réglage sélectionne si le contrôle devrait fonctionner selon la température constante de départ. La plage de réglages de la température constante est 10 ÷ 140 °C. AVERTISSEMENT ! Cette fonction éteint le contrôle selon la température extérieure.	0- NON 1- OUI	0
S2.15	DÉLAI DE LA DÉSACTIVATION DE LA POMPE DE CIRCULATION (EN MINUTES)	Ce réglage définit le temps de délai avant que la pompe de circulation s'éteigne - lorsque le chauffage n'est pas nécessaire.	1 ÷ 10 min	5



Réglages pour les sources de chaleur :

Paramètre	Description du paramètre	Description	Possibilités de réglage	Valeur reprise
S3.1	TEMPÉRATURE MAXIMUM DE LA CHAUDIÈRE	Réglage de la température maximum de la chaudière.	60 ÷ 160°C	90
S3.2	AUGMENTATION DE LA TEMPÉRATURE DE LA CHAUDIÈRE POUR LA VANNE MÉLANGEUSE	Réglage de la différence entre la température de la chaudière et la température de départ.	0 ÷ 25K	5

Dans le groupe F1 sont des paramètres de séchage du sol:



La procédure pour régler les paramètres du séchage du sol est la même que pour le réglage des services (voir page 164).



Paramètres de séchage du sol :

Para-mètre	Description du paramètre	Possibilités de réglage	Valeur reprise
F1.1	ACTIVATION DU SÉCHAGE DU SOL	0 - NON 1 - OUI	0
F1.2	INTERVALLE 1: DURÉE	1 ÷ 15 jours	10
F1.3	INTERVALLE 1: TEMPÉRATURE DÉBUT	10 ÷ 60°C	20
F1.4	INTERVALLE 1: TEMPÉRATURE FIN	10 ÷ 60°C	20
F1.5	INTERVALLE 2: DURÉE	1 ÷ 15 jours	5
F1.6	INTERVALLE 2: TEMPÉRATURE DÉBUT	10 ÷ 60°C	20
F1.7	INTERVALLE 2: TEMPÉRATURE FIN	10 ÷ 60°C	50
F1.8	INTERVALLE 3: DURÉE	1 ÷ 15 jours	10
F1.9	INTERVALLE 3: TEMPÉRATURE DÉBUT	10 ÷ 60°C	50
F1.10	INTERVALLE 3: TEMPÉRATURE FIN	10 ÷ 60°C	50
F1.11	INTERVALLE 4: DURÉE	1 ÷ 15 jours	5
F1.12	INTERVALLE 4: TEMPÉRATURE DÉBUT	10 ÷ 60°C	20
F1.13	INTERVALLE 4: TEMPÉRATURE FIN	10 ÷ 60°C	50

Profil du séchage du sol - réglage par défaut :

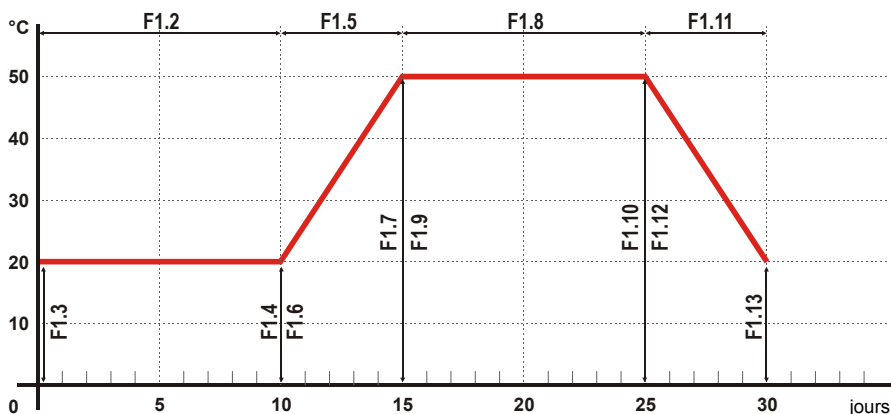



RÉGLAGE PAR DÉFAUT

Dans le menu vous trouverez les outils permettant de vous aider à régler le régulateur. Remettez le régulateur aux réglages désirés en sélectionnant :



RÉINITIALISER TOUS LES PARAMÈTRES DU RÉGULATEUR

Restaure tous les paramètres de réglage P1, P2, P3, S1 (excepté S1.1), S2, S3 et F1 au réglage par défaut.



RÉINITIALISER LES PROGRAMMES MINUTEURS

Restaure les programmes minuteurs par défaut.



RÉINITIALISER TOUS LES RÉGLAGES DU RÉGULATEUR ET REDÉMARRER LE RÉGLAGE INITIAL

Restaure tous les paramètres aux valeurs par défaut et démarre le réglage initial.



ENREGISTRER LES RÉGLAGES DE L'UTILISATEUR

Enregistre tous les réglages en tant que réglages de l'utilisateur



CHARGER LES RÉGLAGES DE L'UTILISATEUR

Charger les réglages de l'utilisateur précédemment enregistrés.

MANUEL DE MONTAGE

MONTAGE DU RÉGULATEUR

Le régulateur a besoin d'être installé directement sur une vanne mélangeuse, dans une pièce sèche et non exposée à de forts champs électromagnétiques. Le régulateur n'a besoin que d'être pressé sur la vanne mélangeuse. Le démontage ou l'ouverture du régulateur n'est pas nécessaire et n'est pas autorisé.

MONTAGE SUR LA VANNE MÉLANGEUSE

Les exemples d'une installation montrée dans les illustrations ci-dessous est valable pour toutes les vannes mélangeuses des fabricants suivants : Esbe, Seltron, Somatherm, Acaso, Ivar, Wip, Paw, BRV, Imit, Hora, Barberi, Olymp, Hoval.

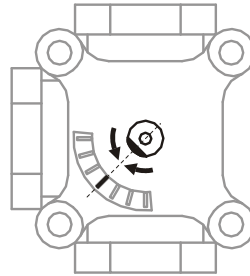
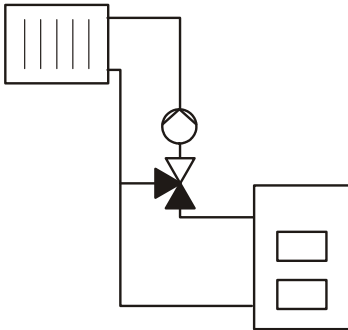

Exemple d'une installation sur une vanne mélangeuse à trois voies.

1a

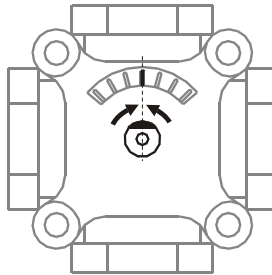
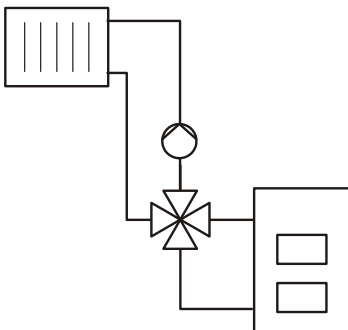

Exemple d'une installation sur une vanne mélangeuse à quatre voies.

1b



La vanne mélangeuse doit être dans la position du milieu.

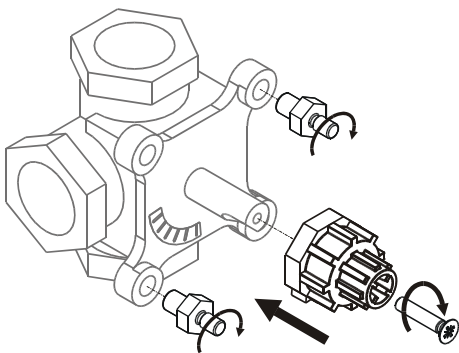

Exemple d'une installation sur une vanne mélangeuse à trois voies.

2a

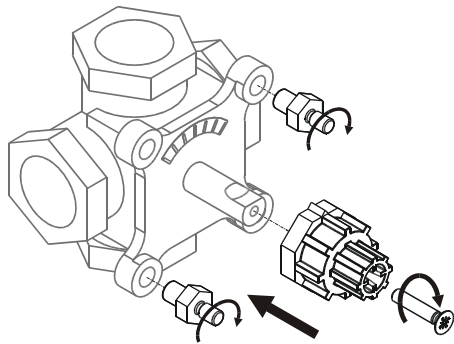

Exemple d'une installation sur une vanne mélangeuse à quatre voies.

2b

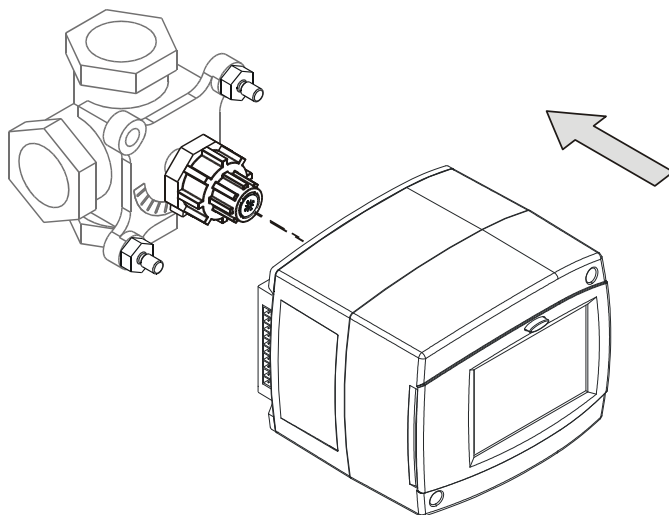

FRE

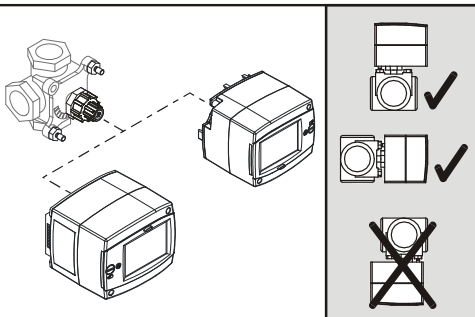

3

RACCORDEMENT ÉLECTRIQUE DU RÉGULATEUR



Les illustrations, les diagrammes et le texte dans ce manuel sont destinés uniquement à titre d'exemple et le fabricant n'en assume aucune responsabilité. Si vous utilisez le contenu de ce manuel comme base à votre projet, alors vous en assumez aussi toute la responsabilité. La responsabilité de l'éditeur pour faute professionnelle, mauvaise et fausse information et dommages consécutifs sont explicitement exclus. Nous nous réservons le droit à des erreurs techniques, fautes, changements et corrections sans avis préalable.

L'installation du dispositif de régulation devrait être effectuée par un expert avec les qualifications requises ou par une organisation autorisée. Avant de toucher le câblage principal, assurez-vous que l'interrupteur principal est éteint. Vous devez suivre les règles d'installation à basse tension CEI 60364 et VDE 0100, selon le règlement sur la prévention des accidents, le règlement sur la protection environnementale et autres réglementations nationales.

Ne pas suivre les règles peut provoquer des blessures graves comme des brûlures ou même le risque de décès.

RACCORDEMENT DES CONDUITES

Tous les raccordements au réseau sont faits par l'intermédiaire de câbles intégrés. Le câble d'alimentation électrique du réseau est équipé d'une prise Schuko. L'autre câble d'alimentation électrique est prévu pour le raccordement de la pompe.

RACCORDEMENT DES SONDES, DES UNITÉS CLIMATIQUES ET DU BUS

La description des bornes est représentée dans l'illustration ci-dessous.

GND	1
T1 / COM1	2
GND	3
COM1	4
GND	5
T2 / COM2	6
GND	7
T3	8
GND	9
T4	10

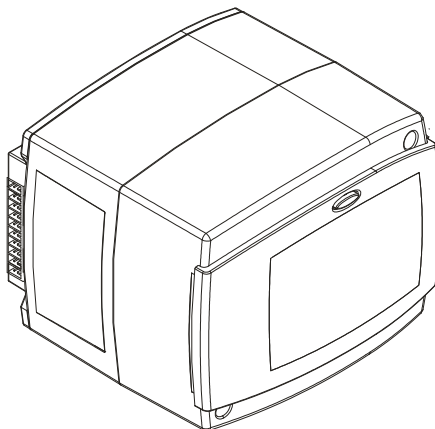
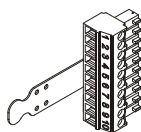

RACCORDEMENT DES UNITÉS CLIMATIQUES DIGITALES DD2+

L'unité climatique est utilisée pour mesurer la température de la pièce, pour ajuster la température de jour et de nuit et pour régler le mode de fonctionnement. Deux unités climatiques (maximum) peuvent être raccordées au régulateur. Avant le raccordement de l'unité climatique, il est nécessaire de configurer les prises codées situées à l'arrière de l'unité climatique.



RÉGLAGE REQUIS



L'unité climatique contrôle le circuit de chauffage.



L'unité climatique ne contrôle pas le circuit de chauffage.



Première unité climatique (#1).



Deuxième unité climatique (#2).

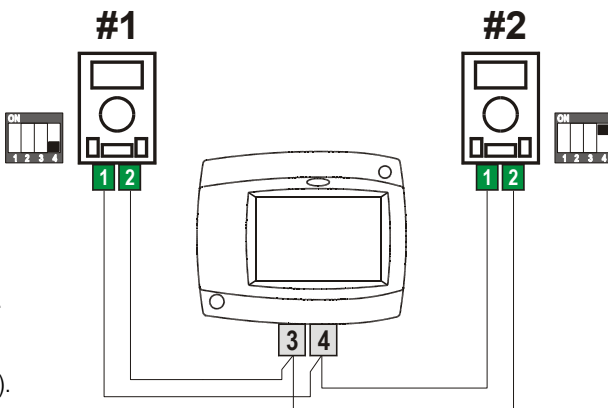

RACCORDEMENT DE LA SONDÉ DE TEMPÉRATURE INTÉRIEURE

La sonde de température intérieure est utilisée pour mesurer la température ambiante, tout comme l'unité climatique digitale DD2+. Elle améliore l'efficacité du contrôle de la température ambiante. Dans la salle de fonctionnement du régulateur, une sonde n'est pas nécessaire. Lorsque la sonde de température intérieure est branchée, réglez le paramètre S1.6 = 0.

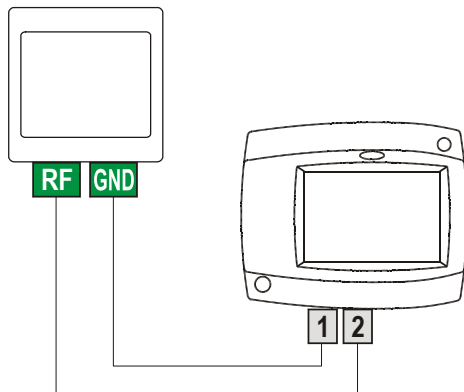

Raccordement possible de la sonde de température intérieure sur les schémas 360 et 360b.

MARQUAGE ET DESCRIPTION DES SONDES DE TEMPÉRATURE

Sonde de température extérieure

La sonde extérieure sera installée sur le côté nord ou nord-ouest du bâtiment, approximativement à deux mètres au-dessus du sol. L'installation au-dessus des fenêtres ou des sorties de ventilation n'est pas permise.

Montez la sonde de telle façon à prévenir l'influence des pertes thermiques (par le mur) sur la sonde. Dans ce cas, la mesure de la température sera faussée.

Sonde de surface

La sonde de surface est prévue pour l'installation sur tuyaux, au-dessus de la pompe de circulation ou de la vanne mélangeuse. Nettoyez la surface de contact où la sonde sera montée. Fixez la sonde avec le ressort.

Immersion de la sonde

Immergez la sonde jusqu'à la fin de la douille sur la source de chaleur. Fixez la sonde avec une vis ou une attache.

Sonde de température ambiante ou unité climatique

L'unité climatique doit être installée sur le mur intérieur d'une pièce, à l'abri des rayons du soleil, des sources de chaleur et des courants d'air. Tout d'abord, enlevez le couvercle et installez le boîtier à l'endroit choisi, à environ 1,5 mètres au-dessus du sol. L'installation peut être faite avec un boîtier de raccordement standard ou directement sur le mur. Un câble à deux fils est nécessaire pour le raccordement électrique. Les vannes thermostatiques des radiateurs doivent être

TABLEAUX : Sondes de température à résistance de type Pt-1000 :

Température [°C]	Résistance [Ω]	Température [°C]	Résistance [Ω]	Température [°C]	Résistance [Ω]	Température [°C]	Résistance [Ω]
-20	922	35	1136	90	1347	145	1555
-15	941	40	1155	95	1366	150	1573
-10	961	45	1175	100	1385	155	1592
-5	980	50	1194	105	1404	160	1611
0	1000	55	1213	110	1423	165	1629
5	1020	60	1232	115	1442	170	1648
10	1039	65	1252	120	1461	175	1666
15	1058	70	1271	125	1480	180	1685
20	1078	75	1290	130	1498	185	1703
25	1097	80	1309	135	1415	190	1722
30	1117	85	1328	140	1536	195	1740

MODE DE FONCTIONNEMENT AVEC SONDE DÉFAILLANTE

Si l'une des sondes de température devient défectueuse, alors le régulateur passe de lui-même au mode de fonctionnement le plus approprié :

La sonde de température extérieure n'est pas reliée ou a une défaillance

Le régulateur fonctionne en tant qu'un régulateur P, en fonction de la variation de la température ambiante. Si la sonde est en erreur, le régulateur maintiendra la température constante de départ avec:

- chauffage par radiateur, 25 °C de plus que la température de jour ou de nuit réglée.
- chauffage par le sol, 10 °C de plus que la température de jour ou de nuit réglée.

La sonde de température de départ n'est pas reliée ou a une défaillance

Le régulateur suppose une température de départ de 120 °C et arrête le chauffage ambiant. Le chauffage peut être réactivé seulement en mode de fonctionnement manuel.

La sonde de température intérieure n'est pas reliée ou a une défaillance

Le chauffage ambiant fonctionne normalement, en relation avec la température de extérieure.

La sonde de température de retour n'est pas reliée ou a une défaillance

Le chauffage ambiant fonctionne normalement, sans limitation de la différence entre la température de départ et de retour.

La sonde de température de la chaudière n'est pas reliée ou a une défaillance

Le régulateur suppose une température de la chaudière à 85 °C et fonctionne normalement.

EXPANSION DU SYSTÈME SUR PLUSIEURS CIRCUITS DE CHAUFFAGE

Raccordement BUS des régulateurs CMP25-2 :

Par le raccordement BUS, un nombre de régulateurs CMP25-2 peuvent être reliés entre eux.

Important : Les sondes de température extérieure et de température de chaudière doivent être raccordées au dernier régulateur.

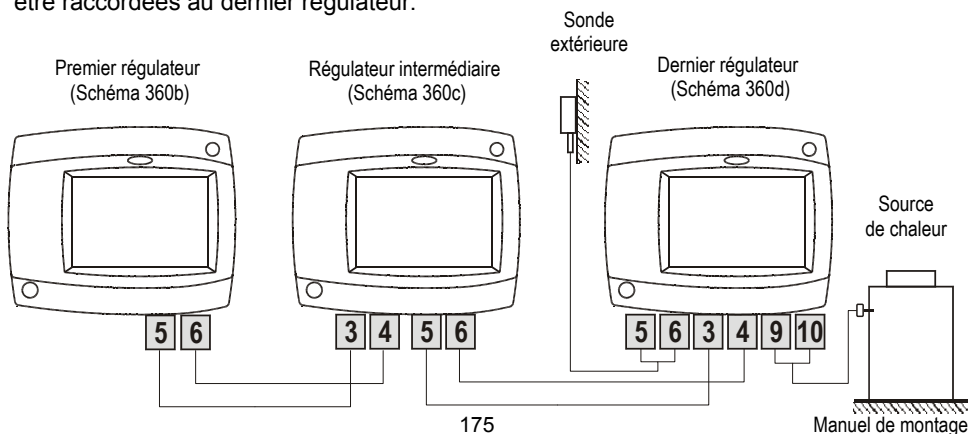

Raccordement BUS des régulateurs CMP25-2 et WDC10B, WDC10 ou WDC20:

En utilisant le raccordement BUS, nous pouvons raccorder le système avec d'autres régulateurs tels que WDC et CMP25-2. Le premier régulateur (WDC) contrôle les sources de chaleur, tandis que les autres contrôlent seulement les circuits de chauffage.

Important : Les sondes de température extérieure et de température de chaudière doivent être raccordées au premier régulateur.

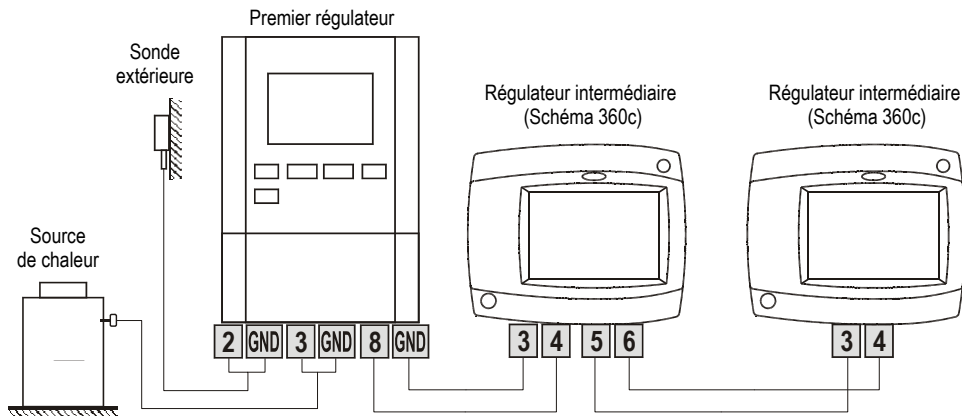

Raccordement BUS des régulateurs CMP25-2 et D10 ou D20 :

En utilisant le raccordement BUS, nous pouvons raccorder le système avec d'autres régulateurs tels que D10, D20 et CMP25-2. Le premier régulateur (D10, D20) contrôle les sources de chaleur, tandis que les autres contrôlent seulement les circuits de chauffage.

Important : Les sondes de température extérieure et de température de chaudière doivent être raccordées au premier régulateur.

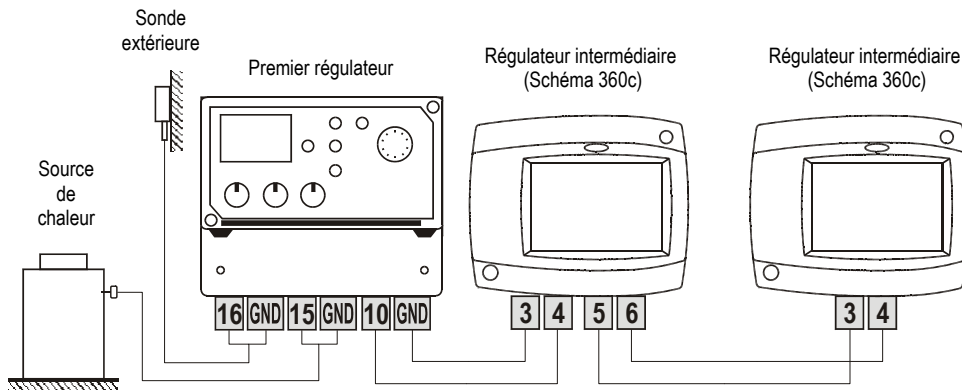

IMPORTANT

ATTENTION : Les schémas d'installation montrent le principe de fonctionnement et ne contiennent pas tous les éléments auxiliaires et de précaution ! Lors de l'installation, vous devez suivre les règlements en cours !

----- Sonde optionnelle. Non nécessaire au fonctionnement du régulateur.



Pour le fonctionnement du régulateur, une unité climatique ou une sonde de température intérieure n'est pas nécessaire.

Le raccordement de l'unité climatique ou des sondes est décrit à la page 173.

Schéma 360
Vanne mélangeuse autonome

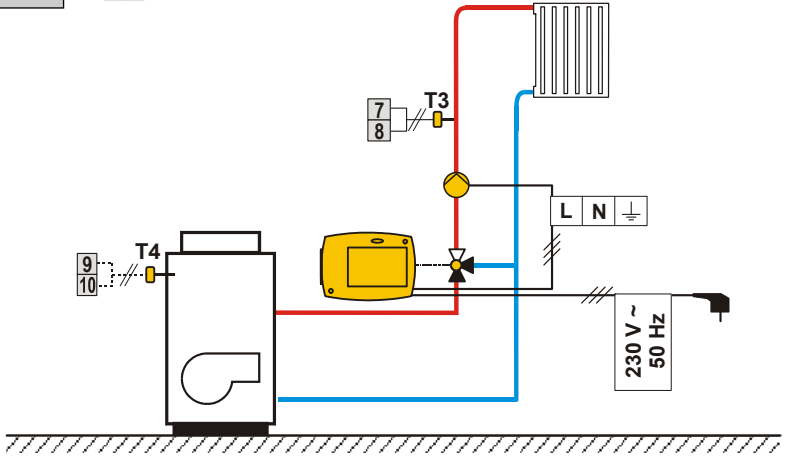
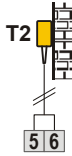

FRE

Schéma 360b
Vanne mélangeuse à circuit multiple
(premier régulateur dans le raccordement BUS)

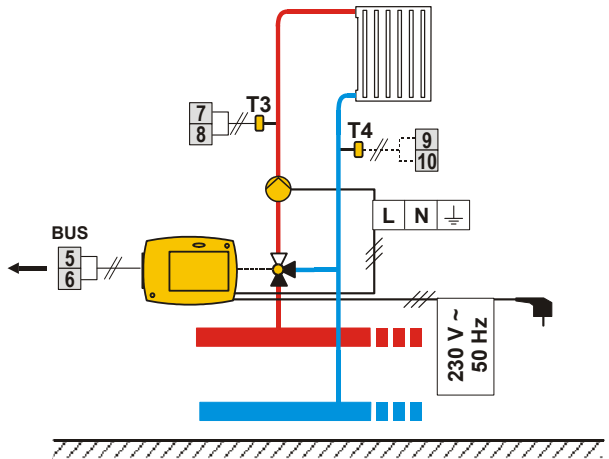
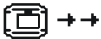

i Le raccordement BUS des régulateurs est décrit aux pages 175 et 176.

Schéma 360c

Vanne mélangeuse à circuit multiple (régulateur intermédiaire dans le raccordement BUS)

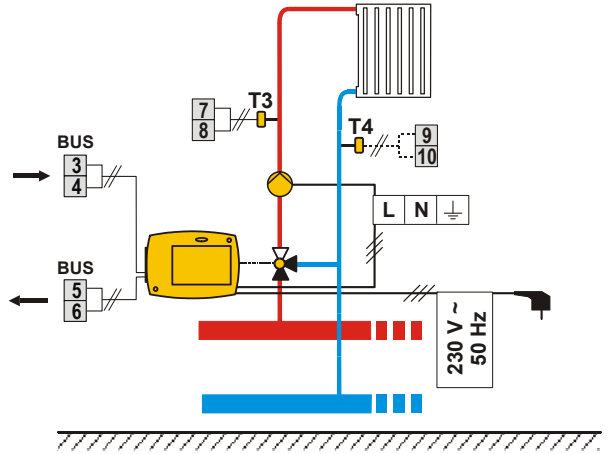

Le raccordement BUS des régulateurs est décrit aux pages 175 et 176.

Schéma 360d

Vanne mélangeuse à circuit multiple (dernier régulateur dans le raccordement BUS)

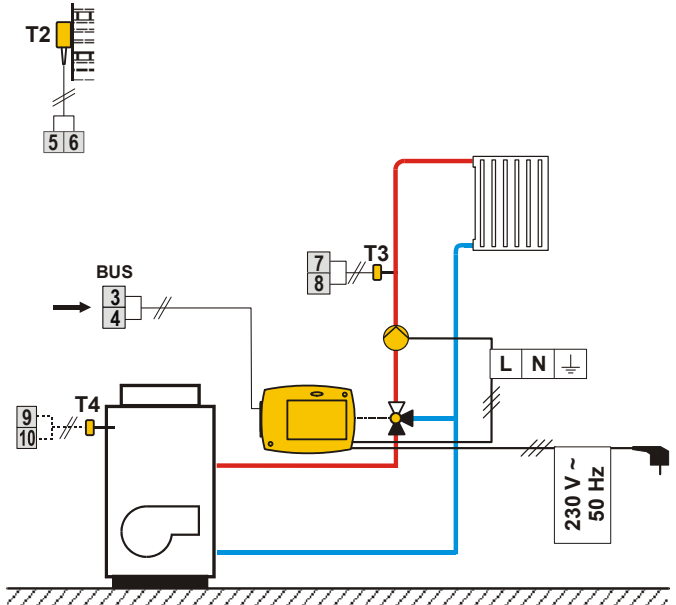
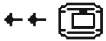

Le raccordement BUS des régulateurs est décrit aux pages 175 et 176.

FRE

CARACTÉRISTIQUES TECHNIQUES

Caractéristiques techniques générales

Tension nominale	230V~, 50Hz
Consommation propre	max 4 VA
Sortie pompe	230V~ / 4 (2) A
Boîtier du régulateur	ABS - thermoplastique
Dimensions (l x h x p)	84 x 105 x 100 mm
Poids	900 g ÷ 950 g
Couleur/matériels	gris foncé / PC
Indice de protection	IP24 selon EN 60529
Classe de protection	II selon EN 60730-1
Type de fonctionnement	Classe 1B selon EN 60730-1
Température ambiante	de 0° à + 40°C
Température de conservation	de -20° à +70°C

Caractéristiques techniques :

Réglage de la température de jour :	10°C ÷ 30°C
Réglage de la température de nuit :	10°C ÷ 30°C
Réglage de la courbe de chauffe :	0,2 ÷ 2,2
Température antigel :	+ 6°C (ajustable)
Réglage de la zone morte du régulateur PI :	± 0,7K ÷ ± 1,5 K
Type du capteur de température :	Pt1000 ou KTY-10
Programmes horaires :	programmes horaires à canaux multiples

FRE

DÉCLARATIONS ET RECOMMANDATIONS

DÉCLARATION DE CONFORMITÉ

Le régulateur climatique compact CMP25-2 est conforme aux directives suivantes :

- La directive 2004/108/CE sur les perturbations électromagnétiques,
- La directive Basse Tension 2006/95/CE,
- La directive 2002/95/EC (Rohs) sur l'utilisation de substances dangereuses dans les appareils électroniques et électriques.

DESCRIPTION DU PRODUIT :

Régulateur climatique compact pour systèmes de chauffage central

DÉSIGNATION DES MODÈLES :

CMP25-2

NORMES APPLIQUÉES :

EN60730-1, EN60730-2-9,
EN60730-2-11, EN60730-2-14,
EN12098-1, EN61000-6-1, EN55014-1.



RECYCLAGE DES APPAREILS ÉLECTRIQUES ET ÉLECTRONIQUES

Recyclage des appareils électriques et électroniques (valable pour les états membres de l'UE et les autres pays européens ayant une collecte d'ordures par triage).



Ce symbole sur le produit ou l'emballage signifie que le produit ne peut pas être considéré comme une ordure ménagère et doit être apporté séparément dans une déchetterie de collecte désignée pour les déchets d'équipements électriques et électroniques (DEEE). Le triage et le recyclage de vos vieux produits aidera à prévenir des conséquences négatives potentielles pour l'environnement et la santé humaine. Ceci constitue une condition requise de réutiliser et de recycler les équipements électriques et électroniques usés. Pour plus d'informations sur la collecte de vos vieux produits électroménagers, veuillez contacter les bureaux de votre municipalité, des services de collecte d'ordures ou le magasin où vous avez acheté le produit.

NOTES

NOTES

Software v2.0r3

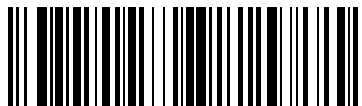

0 1 MC0 6 0 1 9 8

© 2011

We reserve the rights for changes and improvements.

Wir behalten uns das Recht auf Veränderungen und Verbesserungen vor.

Ci si riserva la facoltà di apportare modifiche e migliorie senza preavviso.

Nous réservons les droits pour des changements et des améliorations.