



HITACHI

SPLIT TYPE

INDOOR UNIT/OUTDOOR UNIT

MODEL

RAS-40CNH2 / RAC-40CNH2
RAS-50CNH2 / RAC-50CNH2

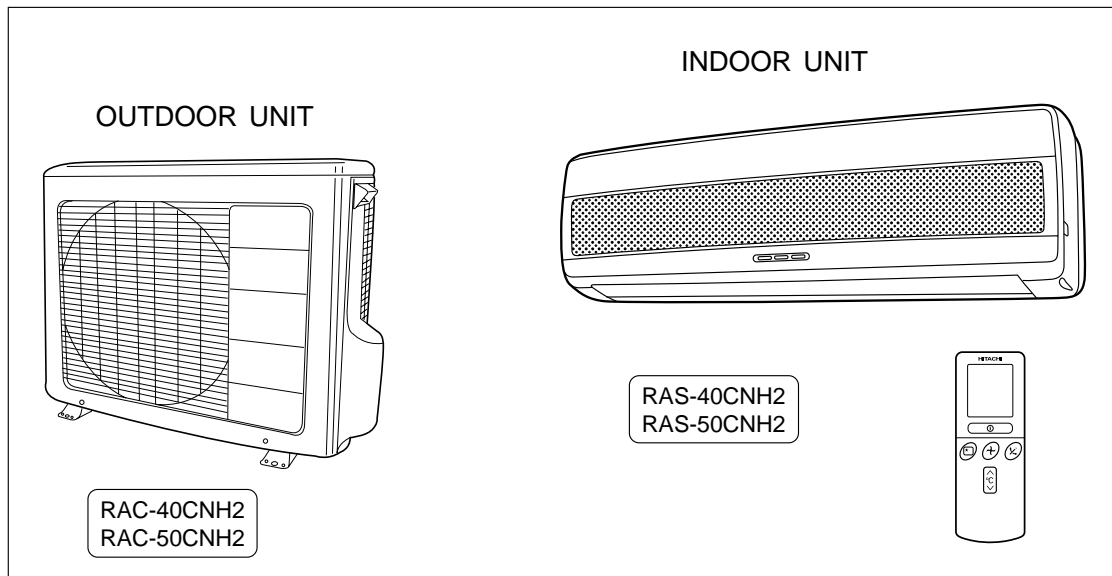

Instruction manual

Page 1~22

To obtain the best performance and ensure years of trouble free use, please read this instruction manual completely.

Bedienungsanleitung

Suite 23~44

Bitte lesen Sie diese Bedienungsanleitung aufmerksam durch, um durch richtige Bedienung jahrelangen und störungsfreien Betrieb zu gewährleisten.

Mode d'emploi

Page 45~66

Des performances optimales et un fonctionnement à long terme seront assurés en appliquant les présentes instructions après avoir entièrement lu ce mode d'emploi.

Manuale di istruzioni

Pag. 67~88

Per garantire la migliore prestazione e la più lunga duratoleggere attentamente e al completo le seguenti istruzioni.

Manual de instrucciones

Página 89~110

Para obtener el mejor funcionamiento y asegurar años de uso libre de problemas, lea cuidadosamente este manual de instrucciones.

Manual de instruções

Página 111~132

A fim de obter um bom funcionamento e de garantir uma utilização sem falhas durante muitos anos, é favor ler este manual de instruções completamente.

Οδηγίες Χειρισμού

Σελίδα 133~154

Για την καλύτερη δυνατή απόδοση και την μακροχρόνια και χωρίς προβλήματα χρήση της συσκευής αυτής, παρακαλούμε διαβάστε πλήρως τις οδηγίες χειρισμού της.

Инструкция по эксплуатации

стр. 155~176

Для обеспечения наилучших эксплуатационных характеристик и многолетней безотказной работы оборудования необходимо полностью ознакомиться с данной Инструкцией по эксплуатации.

"BESTÄGUNG" und "Bescheinigung des Herstellers/Importeurs" sind am Ende dieser Bedienungsanleitung beschrieben.





SAFETY PRECAUTION

- Please read the "Safety Precaution" carefully before operating the unit to ensure correct usage of the unit.
- Pay special attention to signs of "▲ Warning" and "▲ Caution". The "Warning" section contains matters which, if not observed strictly, may cause death or serious injury. The "Caution" section contains matters which may result in serious consequences if not observed properly. Please observe all instructions strictly to ensure safety.
- The sign indicate the following meanings.

Make sure to connect earth line.	The sign in the figure indicates prohibition.
Indicates the instructions that must be followed.	

- Please keep this manual after reading.

PRECAUTIONS DURING INSTALLATION	
WARNING	<ul style="list-style-type: none"> ● Do not reconstruct the unit. Water leakage, fault, short circuit or fire may occur if you reconstruct the unit by yourself. ● Please ask your sales agent or qualified technician for the installation of your unit. Water leakage, short circuit or fire may occur if you install the unit by yourself.
	<ul style="list-style-type: none"> ● Please use earth line. Do not place the earth line near water or gas pipes, lightning-conductor, or the earth line of telephone. Improper installation of earth line may cause electric shock.
CAUTION	<ul style="list-style-type: none"> ● A circuit breaker should be installed depending on the mounting site of the unit. Without a circuit breaker, the danger of electric shock exists. ● Do not install near location where there is flammable gas. The outdoor unit may catch fire if flammable gas leaks around it. ● Please ensure smooth flow of water when installing the drain hose.

PRECAUTIONS DURING SHIFTING OR MAINTENANCE	
WARNING	<ul style="list-style-type: none"> ● Should abnormal situation arises (like burning smell), please stop operating the unit and turn off the circuit breaker. Contact your agent. Fault, short circuit or fire may occur if you continue to operate the unit under abnormal situation.
	<ul style="list-style-type: none"> ● Please contact your agent for maintenance. Improper self maintenance may cause electric shock and fire.
	<ul style="list-style-type: none"> ● Please contact your agent if you need to remove and reinstall the unit. Electric shock or fire may occur if you remove and reinstall the unit yourself improperly.

PRECAUTIONS DURING OPERATION	
WARNING	<ul style="list-style-type: none"> ● Avoid an extended period of direct air flow for your health.
	<ul style="list-style-type: none"> ● Do not put objects like thin rods into the panel of blower and suction side because the high-speed fan inside may cause danger.
	<ul style="list-style-type: none"> ● Do not use any conductor as fuse wire, this could cause fatal accident.
	<ul style="list-style-type: none"> ● During thunder storm, disconnect and turn off the circuit breaker.





PRECAUTIONS DURING OPERATION

- The product shall be operated under the manufacturer specification and not for any other intended use.

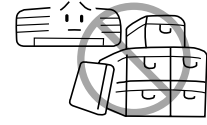

- Do not attempt to operate the unit with wet hands, this could cause fatal accident.

- When operating the unit with burning equipments, regularly ventilate the room to avoid oxygen insufficiency.

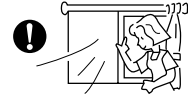

- Do not direct the cool air coming out from the air-conditioner panel to face household heating apparatus as this may affect the working of apparatus such as the electric kettle, oven etc.

- Please ensure that outdoor mounting frame is always stable, firm and without defect. If not, the outdoor unit may collapse and cause danger.



- Do not splash or direct water to the body of the unit when cleaning it as this may cause short circuit.

CAUTION

- Do not place plants directly under the air flow as it is bad for the plants.

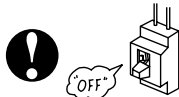
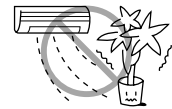

- Please switch off the unit and turn off the circuit breaker during cleaning, the high-speed fan inside the unit may cause danger.

- Turn off the circuit breaker if the unit is not to be operated for a long period.

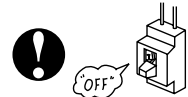

- Do not climb on the outdoor unit or put objects on it.

- Do not put water container (like vase) on the indoor unit to avoid water dripping into the unit. Dripping water will damage the insulator inside the unit and causes short-circuit.



- When operating the unit with the door and windows opened, (the room humidity is always above 80%) and with the air deflector facing down or moving automatically for a long period of time, water will condense on the air deflector and drips down occasionally. This will wet your furniture. Therefore, do not operate under such condition for a long time.
- If the amount of heat in the room is above the cooling or heating capability of the unit (for example: more people entering the room, using heating equipments and etc.), the preset room temperature cannot be achieved.





NAMES AND FUNCTIONS OF EACH PART

INDOOR UNIT

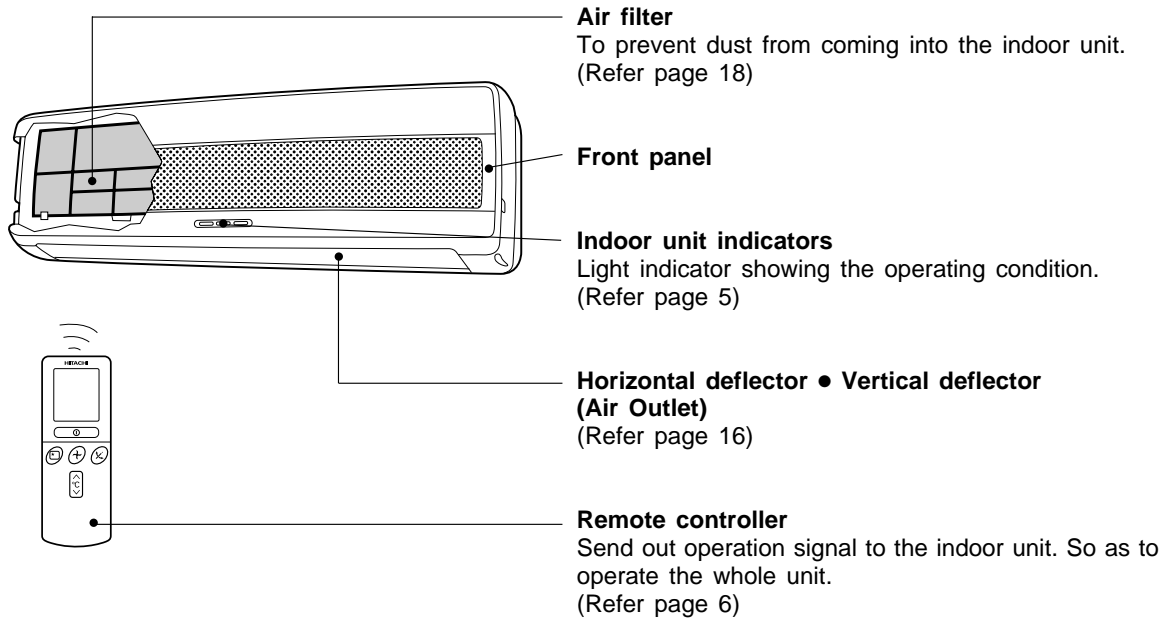

OUTDOOR UNIT

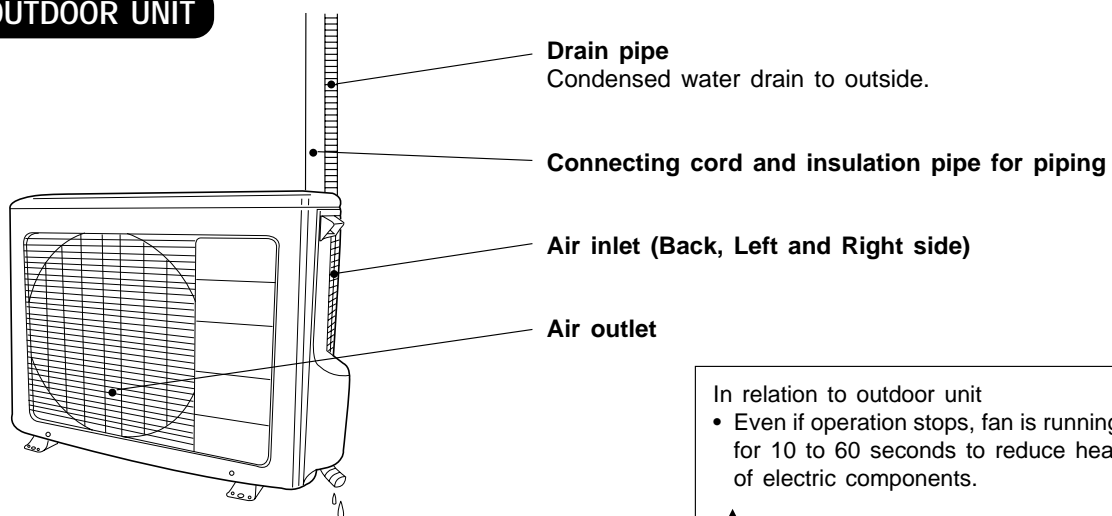

In relation to outdoor unit

- Even if operation stops, fan is running for 10 to 60 seconds to reduce heat of electric components.

CAUTION

- When heating operation, drain or defrosted water flows out from outdoor unit. Don't stop drain outlet portion in chilly area so as not to freeze these.

MODEL NAME AND DIMENSIONS

MODEL	WIDTH (mm)	HEIGHT (mm)	DEPTH (mm)
RAS-40CNH2, RAS-50CNH2	798	285	183
RAC-40CNH2, RAC-50CNH2	850	650	298





INDOOR UNIT INDICATORS

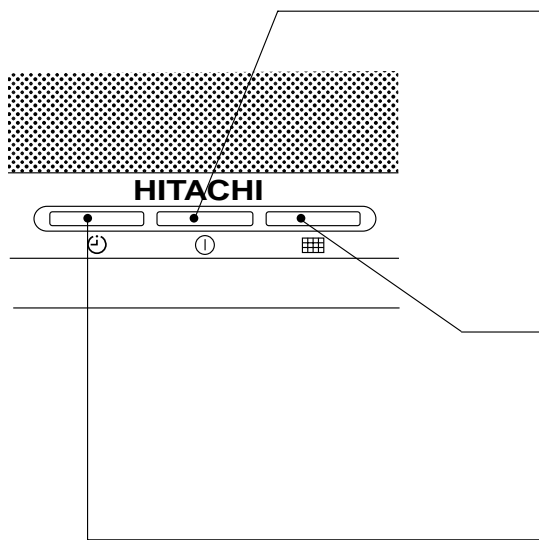

OPERATION LAMP

This lamp lights during operation.

The OPERATION LAMP flashes in the following cases during heating.

(1) During preheating

For about 2–3 minutes after starting up.

(2) During defrosting

Defrosting will be performed about once an hour when frost forms on the heat exchanger of the outdoor unit, for 5–10 minutes each time.

FILTER LAMP

When the device is operated for a total of about 100 hours, the FILTER lamp lights to indicate that it is time to clean the filter. The lamp goes out when the FILTER LAMP RESET SWITCH is pushed.

TIMER LAMP

This lamp lights when the timer is working.

OPERATION INDICATOR

- This figure shows the opening condition of front panel. Refer to page 18 in relation to how to open or close the front panel.

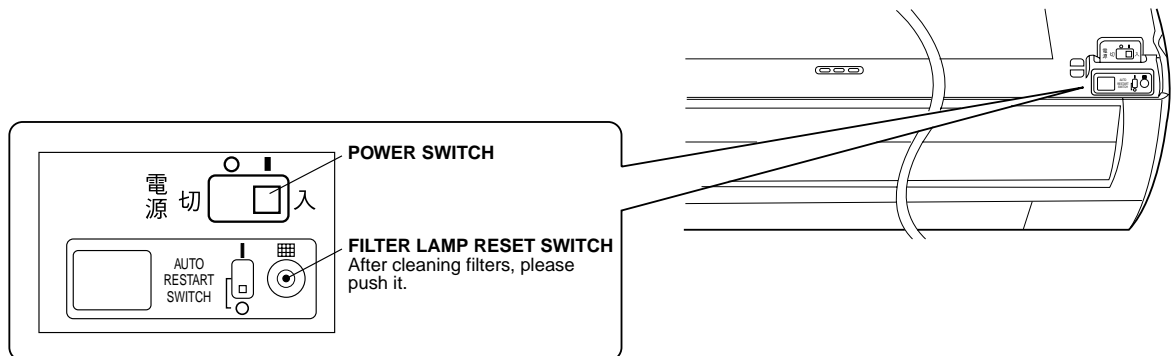

AUTO RESTART SWITCH

- In the event of power failure, the air conditioner will restart automatically in the previously selected mode once the power is restored.
- In the event of power failure during TIMER operation, the timer will be reset and the unit will stop operating.





NAMES AND FUNCTIONS OF EACH PART

REMOTE CONTROLLER

This controls the operation of the indoor unit. The range of control is about 7 meters. If indoor lighting is controlled electronically, the range of control may be shorter.

This unit can be fixed on a wall using the fixture provided. Before fixing it, make sure the indoor unit can be controlled from the remote controller.

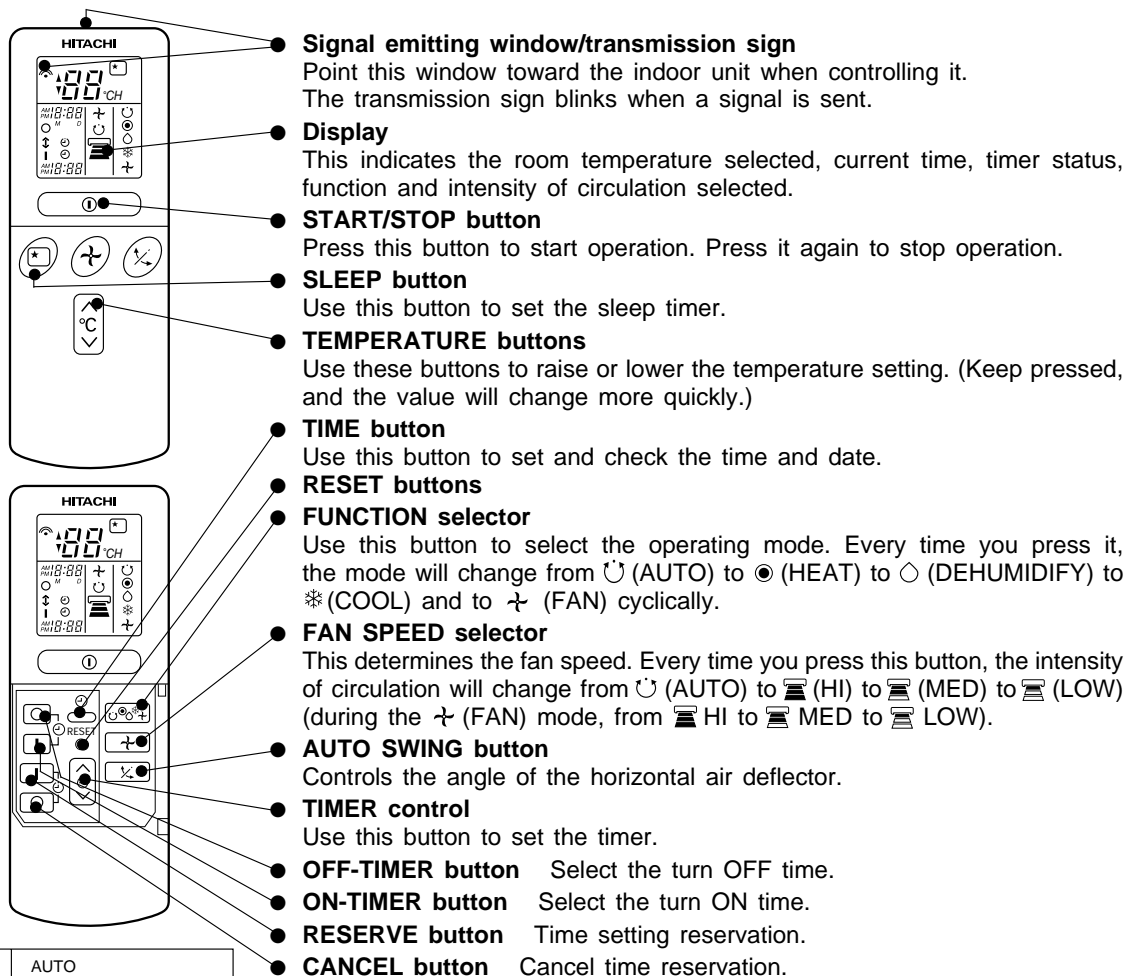

	AUTO
	HEAT
	DEHUMIDIFY
	COOL
	FAN
	FAN SPEED
	LOW
	MED
	HI
	SLEEPING
	STOP (CANCEL)
	START (RESERVE)
	START/STOP
	TIME
	TIMER SET
	TIMER SELECTOR
	ON TIMER
	OFF TIMER
	AUTO SWING

Precautions for Use

- Do not put the remote controller in the following places.
 - In direct sunlight.
 - In the vicinity of a heater.
- Handle the remote controller carefully. Do not drop it on the floor, and protect it from water.
- Once the outdoor unit stops, it will not restart for about 3 minutes (unless you turn the power switch off and on or unplug the power cord and plug it in again).
This is to protect the device and does not indicate a failure.
- If you press the FUNCTION selector button during operation, the device may stop for about 3 minutes for protection.



AUTOMATIC OPERATION

The device will automatically determine the mode of operation, HEAT or COOL, depending on the initial room temperature. The selected mode of operation will not change when the room temperature varies.

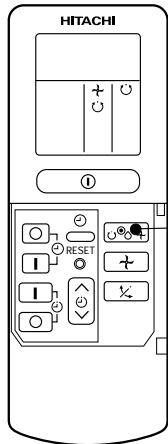

1

Press the FUNCTION selector so that the display indicates the  (AUTO) mode of operation.

- When AUTO has been selected, the device will automatically determine the mode of operation, HEAT or COOL, depending on the current room temperature.
- When AUTO is first selected, the device will determine the current room temperature and accordingly select the proper operation mode.
- When the air conditioner has adjusted the room's temperature to the near preset temperature, it will begin monitor operation. If the room temperature subsequently changes, the air conditioner will once again select the appropriate operation (heating or cooling) to adjust the temperature to the preset temperature. The monitoring operation range is $\pm 3^{\circ}\text{C}$ relative to the preset temperature.
- If the mode automatically selected by the unit is not satisfactory, manually change the mode setting (heat, dehumidify, cool or fan).
- When AUTO has been selected, the device will automatically determine the mode of operation, HEAT, COOL or Dehumidify, depending on the current room temperature and outdoor temperature.

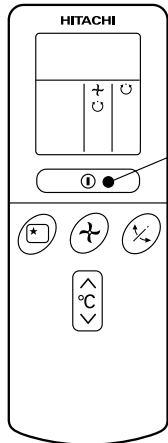

START STOP

Press the  (START/STOP) button. Operation starts with a beep. Press the button again to stop operation.

- As the settings are stored in memory in the remote controller, you only have to press the  (START/STOP) button next time.

You can raise or lower the temperature setting as necessary by maximum of 3°C .



Press the temperature button and the temperature setting will change by 1°C each time.

- The preset temperature and the actual room temperature may vary somewhat depending on conditions.
- The display does not indicate the preset temperature in the AUTO mode. If you change the setting, the indoor unit will produce a beep.

Press the  (FAN SPEED) button, AUTO and LOW is available.



HEATING OPERATION

- Use the device for heating when the outdoor temperature is under 21°C.
When it is too warm (over 21°C), the heating function may not work in order to protect the device.
- In order to keep reliability of the device, please use this device above -15°C of the outdoor temperature.

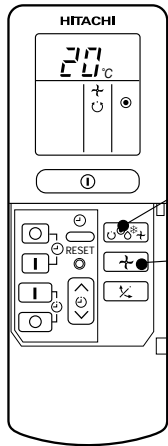

1

Press the FUNCTION selector so that the display indicates ● (HEAT).

Set the desired FAN SPEED with the ↻ (FAN SPEED) button (the display indicates the setting).

2

⌚ (AUTO): The fan speed changes automatically according to the temperature of the air which blows out.

⌚ (HI) : Economical as the room will become warm quickly.
But you may feel a chill at the beginning.

⌚ (MED) : Quiet.

⌚ (LOW) : More quiet.

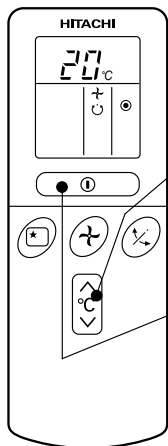

3

Set the desired room temperature with the TEMPERATURE buttons (the display indicates the setting).



The range of 18-22°C is recommended as the room temperature for heating.

If the temperature setting is 20°C, the room temperature will be controlled at around 20°C.

The temperature setting and the actual room temperature may vary somewhat depending on conditions.

START STOP

Press the ⏻ (START/STOP) button. Heating operation starts with a beep. Press the button again to stop operation.

- As the settings are stored in memory in the remote controller, you only have to press the ⏻ (START/STOP) button next time.
However, if operation stops with fan speed of "LOW", fan speed is automatically set to "AUTO" next time.



DEHUMIDIFYING OPERATION

Use the device for dehumidifying when the room temperature is over 16°C.
When it is under 15°C, the dehumidifying function will not work.

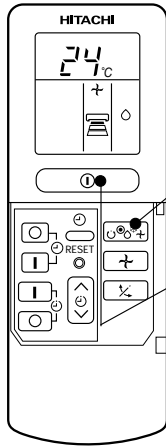

1

Press the ◊ (DEHUMIDIFY) button.
Operation start with a beep.
The FAN SPEED is set at LOW automatically.
The FAN SPEED button does not work.

STOP

Press the ① (START/STOP) button.

- When you want to change the operation mode, please use the FUNCTION selector.
- Set the desired temperature is available.
- You also can use the FUNCTION selector to select this operation.
- When dehumidifying is done using the ◊ (DEHUMIDIFY) button, the ON/OFF timer cannot be used.
If the ON/OFF timer has been set, and the ◊ (DEHUMIDIFY) button is pressed, the setting of the ON/OFF timer will be canceled.
- If you wish to use the ON/OFF timer, perform the dehumidifying operation using the FUNCTION selector.
- When dehumidifying is done using the ◊ (DEHUMIDIFY) button, the set time on the SLEEP timer can be changed using the SLEEP TIMER button.

■ Dehumidifying Function

When the room temperature is higher than the temperature setting: The device will dehumidify the room, reducing the room temperature to the preset level.

When the room temperature is lower than the temperature setting: Dehumidifying will be performed with the room temperature set slightly lower than the current room temperature, whatever the temperature setting. The function will stop (the indoor unit will stop emitting air) as soon as the room temperature becomes lower than the setting.

COOLING OPERATION

Use the device for cooling when the outdoor temperature is 22-42°C.
If humidity is very high (over 80%) indoors, some dew may form on the air outlet grille of the indoor unit.

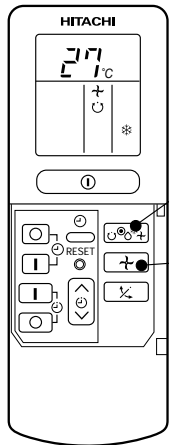

1

Press the FUNCTION selector so that the display indicates ❄️ (COOL).

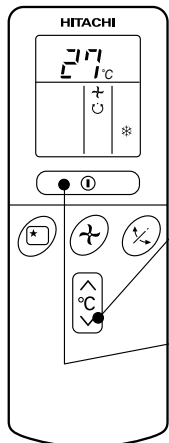

2

Set the desired FAN SPEED with the ↻ (FAN SPEED) button (the display indicates the setting).

🌀 (AUTO): The FAN SPEED is HI at first and varies to MED automatically when the preset temperature has been reached.



(HI) : Economical as the room will become cool quickly.



(MED) : Quiet.



(LOW) : More quiet.

3

Set the desired room temperature with the TEMPERATURE buttons (the display indicates the setting).



The range of 25-28°C is recommended as the room temperature for cooling.

If the temperature setting is 27°C, the room temperature will be controlled at around 27°C.

The temperature setting and the actual room temperature may vary somewhat depending on conditions.

START
STOP

Press the ⏻ (START/STOP) button. Cooling operation starts with a beep. Press the button again to stop operation. The cooling function does not start if the temperature setting is higher than the current room temperature (even though the Ⓜ (OPERATION) lamp lights). The cooling function will start as soon as you set the temperature below the current room temperature.

- As the settings are stored in memory in the remote controller, you only have to press the ⏻ (START/STOP) button next time. However, if operation stops with fan speed of "LOW", fan speed is automatically set to "AUTO" next time.



FAN OPERATION

You can use the device simply as an air circulator. Use this function to dry the interior of the indoor unit at the end of summer.

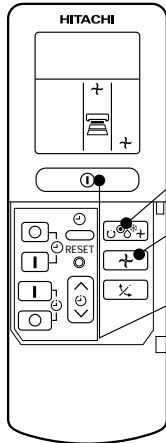

1

Press the FUNCTION selector so that the display indicates (FAN).

2

Press the (FAN SPEED) button.*

START
STOP

Press the (START/STOP) button. Fan operation starts with a beep. Press the button again to stop operation.

* Note • In the fan operation mode, only display of FAN SPEED setting will change by pressing FAN SPEED button; the actual fan speed cannot be changed directly from HI to LOW mode.

FAN SPEED (AUTO)

..... When the AUTO fan speed mode is set in the cooling/heating operation:

For the heating operation	<ul style="list-style-type: none"> • The fan speed will automatically change according to the temperature of discharged air. • When the difference of room temperature and setting temperature is large, fan starts to run at HI speed. • When the room temperature reaches setting temperature, fan speed changes to LOW automatically.
For the cooling operation	<ul style="list-style-type: none"> • When the difference of room temperature and setting temperature is large, fan starts to run at HI speed. • After room temperature reaches the preset temperature, the cooling operation, which changes the fan speed and room temperature to obtain optimum conditions for natural healthful cooling will be performed.



HOW TO SET THE TIMER

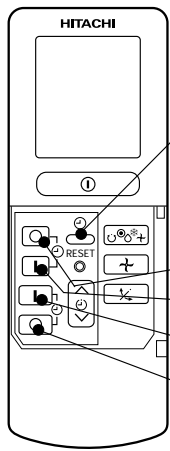

TIME, DAY, MONTH
(current time, day, month)

OFF TIMER

ON TIMER

RESERVE

CANCEL

Time, Day, Month

After you change the batteries;

1 Set the current month and day with the TIMER control button.

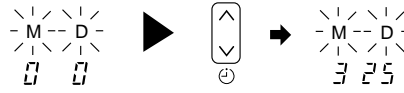

OFF-Timer

1 Press the (OFF-TIMER) button. The (OFF) mark blinks on the display.

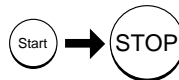

You can set the device to turn off at the present time.

ON-Timer

1 Press the (ON-TIMER) button the (ON) mark blinks on the display.

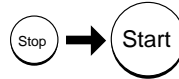

- The device will turn on at the designated times.



ON/OFF-Timer

1 Press the (ON-OFF) button so that the (OFF) mark blinks.

2 Set the turn-off time with the TIMER control button. Press the (RESERVE) button.

3 Press the (ON-TIMER) button so that the (OFF) mark lights and the (ON) mark blinks.

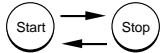

- The device will turn on (off) and off (on) at the designated times.
- The switching occurs first at the preset time that comes earlier.
- The arrow mark appearing on the display indicates the sequence of switching operations.

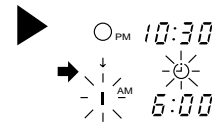
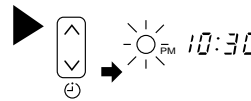
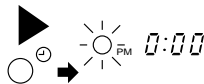

How to Cancel Reservation

Point the signal window of the remote controller toward the indoor unit, and press the (CANCEL) button.

The (RESERVED) sign goes out with a beep and the (TIMER) lamp turns off on the indoor unit.

NOTE

You can set only one of the OFF-timer, ON-timer and ON/OFF-timer.





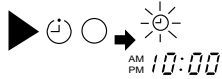

2 Set the  (TIME) button.

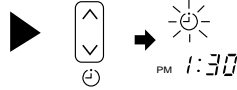

3 Set the current time with the TIMER control button.



4 Press the  (TIME) button again. The time indication starts lighting instead of flashing.







- The time indication will disappear automatically in 10 second.
- To check the current time setting, press the  (TIME) button twice.

The setting of the current time is now complete.

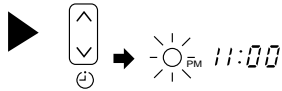
Example: The current time is 1:30 p.m.

2 Set the turn-off time with the TIMER control button.



3 Point the signal window of the remote controller toward the indoor unit, and press the  (RESERVE) button. The  (OFF) mark starts lighting instead of flashing and the sign  (RESERVED) lights. A beep occurs and the  (TIMER) lamp lights on the indoor unit.

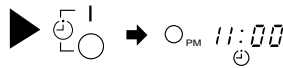



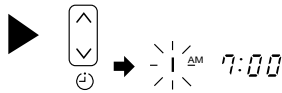

Example: The device will turn off at 11:00p.m.

The setting of turn-off time is now complete.

2 Set the turn-on time with the TIMER control button.







3 Point the signal window of the remote controller toward the indoor unit, and press the  (RESERVE) button. The  (ON) mark starts lighting instead of flashing and the  (RESERVED) sign lights. A beep occurs and the  (TIMER) lamp lights on the indoor unit.

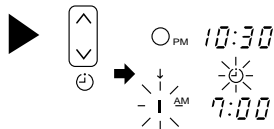

Example:
The device will automatically turn on earlier so that the preset temperature can be reached at 7:00 a.m.
The setting of the turn-on time is now complete.

4 Set the turn-on time with the TIMER control button.



5 Point the signal window of the remote controller toward the indoor unit, and press the  (RESERVE) button. The  (ON) mark starts lighting instead of flashing and the  (RESERVED) sign lights. A beep occurs and the  (TIMER) lamp lights on the indoor unit.

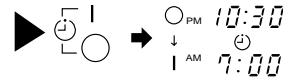

Example:
The device will turn off at 10:30 p.m. and then automatically turn on earlier so that the preset temperature can be reached at 7:00 a.m.
The settings of the turn-on/off times are now complete.

- The timer may be used in three ways: off-timer, on-timer, and ON/OFF (OFF/ON)-timer. Set the current time at first because it serves as a reference.
- As the time settings are stored in memory in the remote controller, you only have to press the  (RESERVE) button in order to use the same settings next time.





HOW TO SET THE SLEEP TIMER

Set the current time at first if it is not set before (see the pages for setting the current time). Press the  (SLEEP) button, and the display changes as shown below.

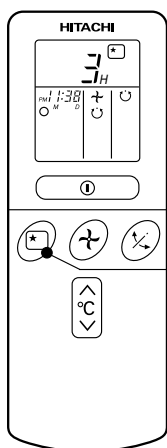

• SLEEP

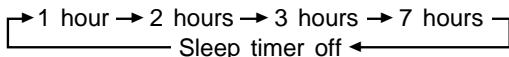
Mode	Indication
Sleep timer	

Sleep Timer: The device will continue working for the designated number of hours and then turn off.

Point the signal window of the remote controller toward the indoor unit, and press the SLEEP button.

The timer information will be displayed on the remote controller. The TIMER lamp lights with a beep from the indoor unit. When the sleep timer has been set, the display indicates the turn-off time.

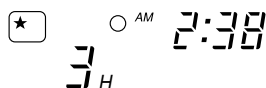

Example: If you set 3 hours sleep time at 11:38 p.m., the turn-off time is 2:38 a.m.

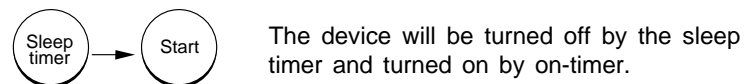

1 Set the ON-timer.

2 Press the  (SLEEP) button and set the sleep timer.

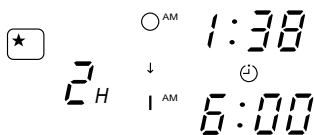

For heating:

In this case, the device will turn off in 2 hours (at 1:38 a.m.) and turn on early so that the preset temperature will be almost reached at 6:00 next morning.

How to Cancel Reservation

Point the signal window of the remote controller toward the indoor unit, and press the  (CANCEL) button.

The  (RESERVED) sign goes out with a beep and the  (TIMER) lamp turns off on the indoor unit.





Explanation of the sleep timer

The device will control the FAN SPEED and room temperature automatically so as to be quiet and good for people's health.

You can set the sleep timer to turn off after 1, 2, 3 or 7 hours. The FAN SPEED and room temperature will be controlled as shown below.

Operation with the sleep timer

Function	Operation
Heating “☉”	<p>The room temperature will be controlled 5°C below the temperature and the FAN SPEED will be set to LOW setting 30 minutes after the setting of the sleep timer.</p> <p>The room temperature is kept at about 12°C minimum.</p>
Cooling “❄️” and dehumidifying “💧”	<p>The room temperature will be controlled 2°C above the temperature and the FAN SPEED will be set to LOW setting 30 minutes after the setting of the sleep timer.</p> <p>The room temperature is kept at about 25–28°C.</p>
Fan “✚”	<p>The settings of room temperature and circulation are varied.</p>

NOTE

- If date or current time is not set, sleep timer can not be set.
- If you set the sleep timer after the off-, on/off- or off/on-timer has been set, the sleep timer becomes effective instead of the off-, on/off- or off/on-timer set earlier.
- You can not set other timer during sleep timer operation.
- After sleep timer is time-up and when press sleep button again, the sleep timer will be set as last setting.
- Sleep timer effective only once.





ADJUSTING THE AIR DEFLECTORS

- 1** Adjustment of the conditioned air in the upward and downward directions.

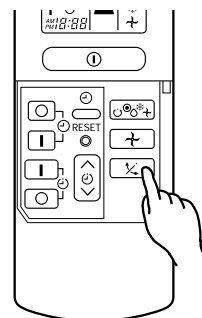
The horizontal air deflector is automatically set to the proper angle suitable for each operation. The deflector can be swung up and down continuously and also set to the desired angle using the “” (AUTO SWING) button.



- If the “” (AUTO SWING) button is pressed once, the horizontal air deflector swings up and down. If the button is pressed again, the deflector stops in its current position. Several seconds (about 6 seconds) may be required before the deflector starts to move.
- Use the horizontal air deflector within the adjusting range shown in the right figure.
- When the “” (AUTO SWING) button is pressed while the operation is stopped, the horizontal air deflector moves and stops at the position where the air outlet closes.
- When the auto swing operation is performed, if the horizontal air deflector is moved manually, the swinging range may drift. However, it will return to the original operation range after a short time.

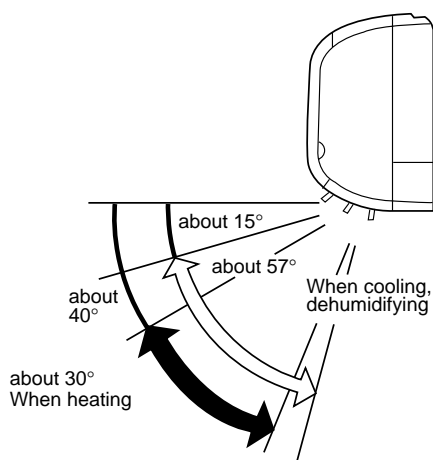

- 2** Adjustment of the conditioned air to the left and right.

Hold the vertical air deflector as shown in the figure and adjust the conditioned air to the left and right.

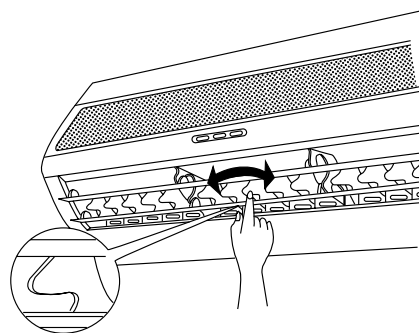

CAUTION

- When operating the unit in cooling operation with the air deflector facing down and moving automatically for a long period of time, water will condensed on the air deflector and drips down occasionally. This will wet your furniture.



HOW TO EXCHANGE THE BATTERIES IN THE REMOTE CONTROLLER

1 Remove the cover as shown in the figure and take out the old batteries.



2 Install the new batteries. The direction of the batteries should match the marks in the case.

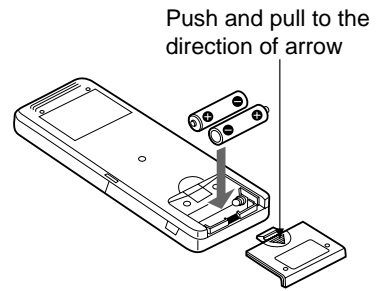

CAUTION

1. Do not use new and old batteries, or different kinds of batteries together.
2. Take out the batteries when you do not use the remote controller for 2 or 3 months.

POWER SWITCH OR CIRCUIT BREAKER

When you do not use the room air conditioner, set the power switch or circuit breaker to "OFF".

FOR USER'S INFORMATION

The Air Conditioner And The Heat Source In The Room

Caution
If the amount of heat in the room is above the cooling capability of the air conditioner (for example: more people entering the room, using heating equipments and etc.), the preset room temperature cannot be achieved.

Suitable Room Temperature

Warning
Freezing temperature is bad for health and a waste of electric power.

Ventilation

Caution
Do not close the room for a long period of time. Occasionally open the door and windows to allow the entrance of fresh air.



ATTACHING THE AIR CLEANSING AND DEODORIZING FILTERS

Before installation, be sure to stop the operation by using the remote controller.

- 1 Open the front panel.**
 - Pull up the front panel holding it at both sides by both hands and open till it locks.

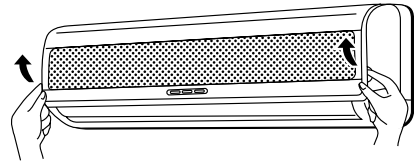

- 2 Remove the filters.**

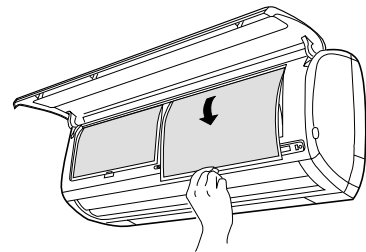

- 3 Attaching the air cleansing and deodorizing filters to indoor unit.**
 - Attach the air cleansing and deodorizing filters to the frame.

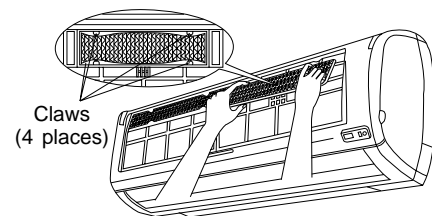

- 4 Attach the filters.**
 - Attach the filters which are placed the surface written "FRONT" up.
 - After attaching the filters, push the front panel at three arrow portion as shown in figure and close it.

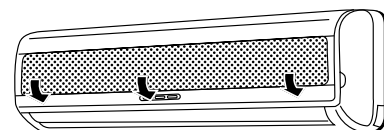
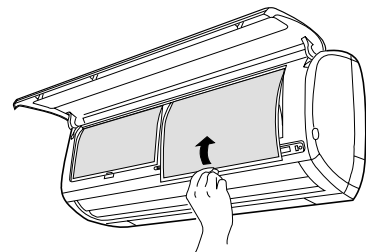

NOTE

- In case of removing the air cleansing and deodorizing filters, please follow the above procedures.
- Air cleansing deodorizing filters is disposable. Replacement every three months is recommended.
- Don't operate the unit without filter. Fault may occur if you continue.





MAINTENANCE

⚠ CAUTION

Before the cleaning, stop operation and disconnect the power supply.

1. AIR FILTER

Clean the air filters immediately as the filter lamp lights.

PROCEDURE

1 Open the front panel.

- Pull up the front panel holding it at both sides by both hands and open till it locks.

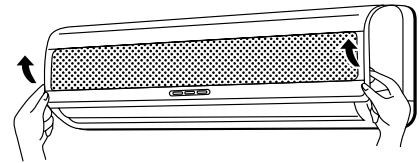

2 Remove the filters.

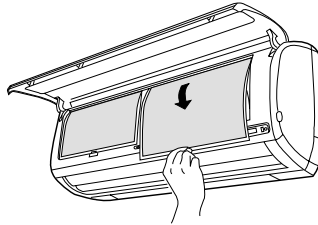

3 Remove dust of the filters using a vacuum cleaner.

- After using neutral detergent, wash with clean water and dry in shade.
- You cannot wash the air cleansing and deodorizing filter.



4 Turn off the filter lamp to push the filter lamp reset switch.

(Refer to page 5)

5 Attach the filters.

- Attaching the filters which are placed the surface written "FRONT" up.
- After attaching the filters, push the front panel at three arrow portion as shown in figure and close it.

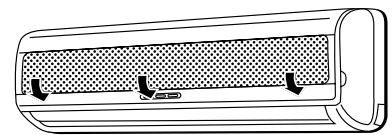

⚠ CAUTION

- Do not wash with hot water at more than 40°C. The filter may shrink.
- When washing it, shake off moisture completely and dry it in the shade; do not expose it directly to the sun. The filter may shrink.
- Don't operate the unit without filter. Fault may occur if you continue.



2. CLEANING OF FRONT PANEL

The front panel can be washed in water. It can be kept clean at all times.

- Front panel can be removed and washed in water. Clean it using a soft sponge, etc. If detergent is used, rinse well.

When the air conditioner is to be cleaned without removing the front panel, clean both the body and remote controller with a dry soft cloth.

- Wipe off water completely. If water remains on the display section or light receiver section, this could cause a malfunction.
- For removing and attaching method of the front panel, please refer to the Installation Manual.

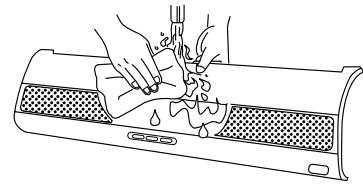

⚠ CAUTION

- Do not spray water on the unit. It may cause an electric shock.

⚠ CAUTION

- Do not splash or direct water to the body of the unit when cleaning it as this may cause short circuit.
- Never use hot water (above 40°C), benzine, gasoline, acid, thinner or a brush, because they will damage the plastic surface and the coating.



3. MAINTENANCE AT BEGINNING OF LONG OFF PERIOD

- Running the unit setting the operation mode to \rightarrow (FAN) and the fan speed to HI for about half a day on a fine day, and dry the whole of the unit.
- Turn off the circuit breaker or disconnect the power plug.

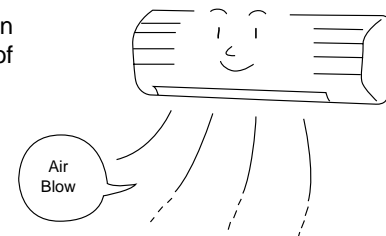



REGULAR INSPECTION

PLEASE CHECK THE FOLLOWING POINTS EVERY EITHER HALF YEARLY OR YEARLY. CONTACT YOUR SALES AGENT SHOULD YOU NEED ANY HELP.

1		Is the earth line disconnected or broken?
2		Is the mounting frame seriously affected by rust and is the outdoor unit tilted or unstable?
3		Is the plug of power line firmly plugged into the socket? (Please ensure no loose contact between them).

AFTER SALES SERVICE AND WARRANTY

WHEN ASKING FOR SERVICE, CHECK THE FOLLOWING POINTS.

CONDITION	CHECK THE FOLLOWING POINTS
	<ul style="list-style-type: none"> ● Is the fuse all right? ● Is the voltage extremely high or low? ● Is the power switch or circuit breaker "ON"?
	<ul style="list-style-type: none"> ● Is the air filter blocked with dust? ● Does sunlight fall directly on the outdoor unit? ● Is the air flow of the outdoor unit obstructed? ● Are the doors or windows opened, or is there any source of heat in the room? ● Is the set temperature suitable?



Notes

- In quiet operation or stopping the running, the following phenomena may occasionally occur, but they are not abnormal for the operation.
 - (1) Slight flowing noise of refrigerant in the refrigerating cycle.
 - (2) Slight rubbing noise from the fan casing which is cooled and then gradually warmed as operation stops.
- The odor will possibly be emitted from the room air conditioner because the various odor, emitted by smoke, foodstuffs, cosmetics and so on, sticks to it. So please clean the air filter and the evaporator regularly to reduce the odor.

- Please contact your sales agent immediately if the air conditioner still fails to operate normally after the above inspections. Inform your agent of the model of your unit, production number, date of installation. Please also inform him regarding the fault.

