

HITACHI

Inspire the Next

INSTALLATION MANUAL FOR PC-P2HTE

1. SAFETY SUMMARY

⚠ DANGER:

- DO NOT pour water into the remote controller (hereafter called “controller”). These products are equipped with electrical parts. If poured, it will cause a serious electrical shock.
- DO NOT operate switches by wet hand. It may cause an electrical shock.
- In case that the protective devices often function or the operation switches do not function well, turn OFF the main power supply and contact your service contractor of HITACHI.
- In case that other abnormalities are found, stop the system, turn OFF the main power supply and contact your service contractor of HITACHI.

⚠ WARNING:

- DO NOT perform installation work and electrical wiring connection by yourself.
In case that a service work such as repair, maintenance, etc. is required, contact your service contractor of HITACHI.
- DO NOT modify the electrical wiring. It may cause serious accidents.

2. INSTALLATION WORK

2.1. SELECTION OF INSTALLATION PLACE

■ Location of Remote Controller





- Select a suitable place for handling and determine the installation place of the controller with the customer’s acceptance.
- Especially in case that a remote control thermistor (C8) is used, pay attention to select the installation place.

NOTE:

For one remote controller, the maximum total length of the cable (including the signal wire between units) is 30 m when using 0.3 mm² cable and 500 m when using the cable thicker than 0.75 mm².

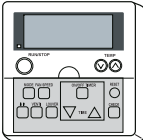
2.2. BEFORE INSTALLATION

Check the contents and the number of the accessories in the packing.

| | | | |
|---|---|---|---|
|  |  |  |  |
| Remote Control Switch, for Operation Control | 2 screws M4x16L For fixing the Holding Bracket onto the wall | 1 Band. For fixing Cable to Ring Core | Ring Core. |

2.3. INSTALLATION SPACE

In case of installing the controllers in vertical line, keep a distance more than 50 mm between the controllers vertically. If the distance is insufficient, the front cover of the controller can not open wide enough

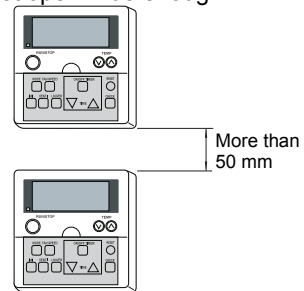

2.4. INSTALLATION PROCEDURE

1. Insert the edge of the flat head screwdriver into the dent parts at the bottom of the holding bracket, push and turn the screwdriver and remove the controller from the holding bracket as shown in the next figure.

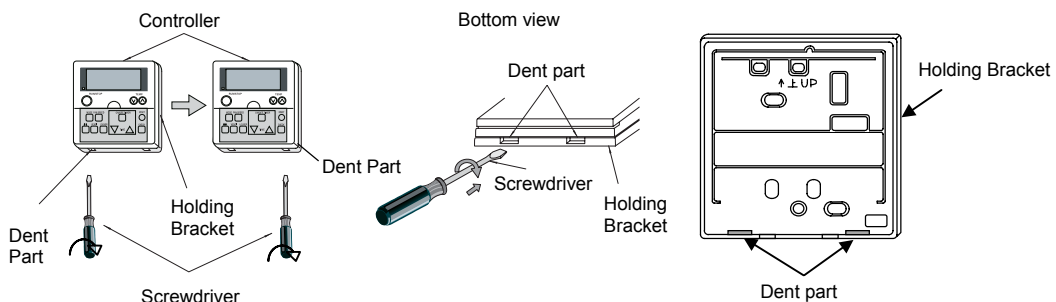

2. Attach the controller to the holding bracket as follows.

■ In case of exposing Remote Control Cable.

1. Fix the holding bracket onto the wall as shown below

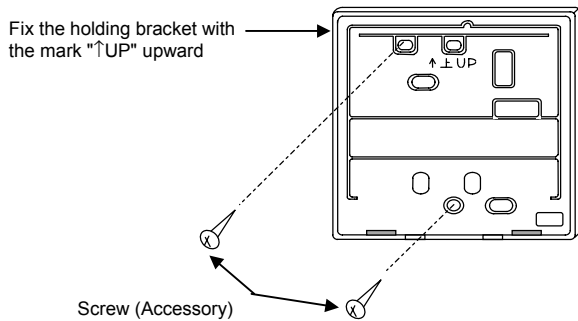

2. Attach the stopper to the cable at the inside of the draw-out hole.

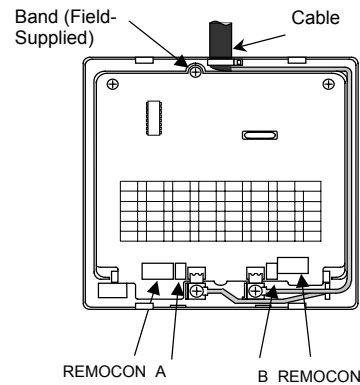

3. Lead the cable with its sheath peeled through the groove
4. Peel the insulation at the end of the cable and clamp the M3 solderless terminals

■ When Using Switch Box.

- ①. Run the cable into Field-Supplied JIS Box (JIS 8336 - 1998)

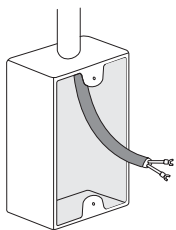

The following 5 types are available.

1. Switch Box for 1 Controller (without Cover)
2. Switch Box for 2 Controllers (without Cover)
3. Switch Box for 1 Controller (with Cover)
4. Switch Box for 2 Controllers (with Cover)
5. Outlet Box (with Cover)

Run the cable through the conduit tube in the wall.

- ②. Fix the holding bracket to the switch box

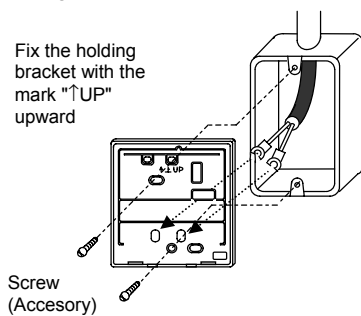

- ③. Peel the insulation at the end of the cable and clamp the M3 solderless terminals

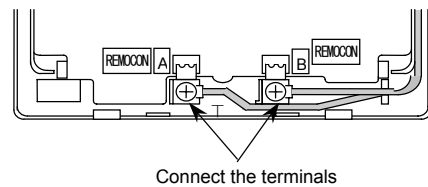

- ④. Mounting procedures.

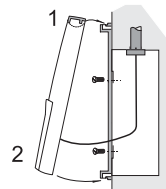

1. Insert the hooks of the controller to the holes on the top of the holding bracket.
2. Push the lower part toward the holding bracket.
3. When the click sound is heard, the controller is attached to the holding bracket and the mounting work is finished.



CAUTION:

Pay attention so that the cable may not be slack. If the cable is slack as shown in the above figure, the cable cord (especially the naked part) may be clamped at the hole and it may cause a faulty operation.

3. ELECTRICAL WIRING

3.1. STANDARD WIRING

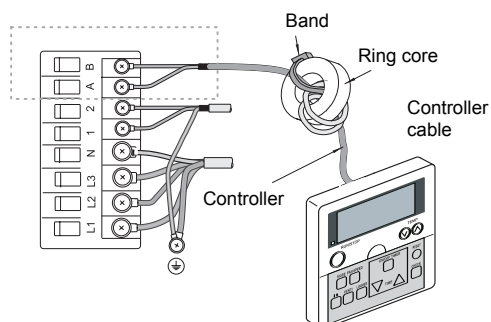

ATTENTION:

- Attach the ring core (black) (accessory) when installing the unit.
- Insert the controller cable into the ring core 2 turns as shown in the right figure before connecting to the terminal board.
If wiring is 0.75 mm² is necessary to peel the outside cover.
- Fix the cable by using the band (accessory)

CAUTION:

- Use the twist (shield) pair cable (2 x 0.75mm²) as transmitting wire cable for prevention of the malfunction (The total cable length is max. 500m). When the total cable length is within 30m, other type cable (more than 0.3mm²) can be used.
- Keep a distance more than 30 cm between the remote control cable and the transmission wire of Indoor units.
- In the case that multiple indoor units are controlled simultaneously, set the refrigerant cycle number and the address of Indoor units as indicated below.

Address of Indoor Units:

| | | | |
|-----------------------|-----------------------|-----------------------|-----------------------|
| Main unit | 1 st unit | 2 nd unit | 3 rd unit |
| | | | |
| 4 th unit | 5 th unit | 6 th unit | 7 th unit |
| | | | |
| 8 th unit | 9 th unit | 10 th unit | 11 th unit |
| | | | |
| 12 th unit | 13 th unit | 14 th unit | 15 th unit |
| | | | |

4. CHECKING PROCEDURES

1. Turn ON the power supply for all the indoor units.
2. Set the "TEST RUN" mode by pressing the "MODE" and "OK" switch simultaneously for more than 3 seconds.

ATTENTION:

In case of the control by using two Remote controllers (Main & Sub), the test running shall be operated by the main controller.

NOTE:

- The completion of the automatic address setting requires 3 to 5 minutes after turning ON the power supply.
- The total number of the connected units is indicated on the liquid crystal display.

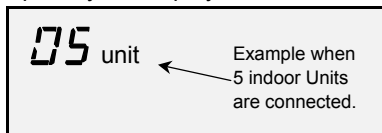

- In case that the indicated number is not correct, some abnormalities exist, incorrect wiring, the electric noise, etc.

- Turn OFF the power supply and correct the wiring after checking the following points; (Do not repeat turning ON and OFF within 10 seconds.)
- Power Supply for Indoor Unit is Not Turned ON or Incorrect Wiring.
- Incorrect Connection of Connecting Cable between Indoor Units or Incorrect Connection of Controller Cable
- Incorrect Setting of Rotary Switch (The setting is overlapped.) on the Indoor Units PCB
- Check to ensure that the "Test Run" mode is not set.

3. Canceling "Test Run" Mode

- When the unit is not operating, press the RESET switch.
- When the unit is operating, press the RUN/STOP switch.

CAUTION:

The setting of the indoor unit number can not be performed by the controller.
In case of setting the unit number, refer to the item "Address of Indoor Unit" of Item 2 "Electrical Wiring for multiple units" and perform the setting.

5. OPTIONAL SETTING AND INPUT/OUTPUT SETTING OF INDOOR UNIT

5.1. OPTIONAL SETTING MODE

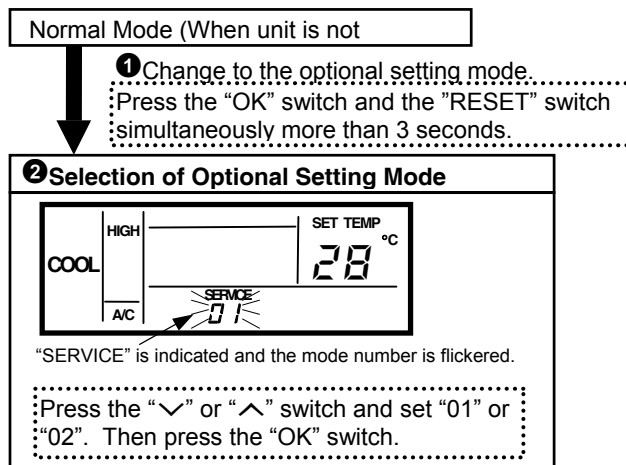

5.2. SELECTION OF INDOOR UNIT

③ Selection of Indoor Unit for Optional Setting

"01" stop flickers.

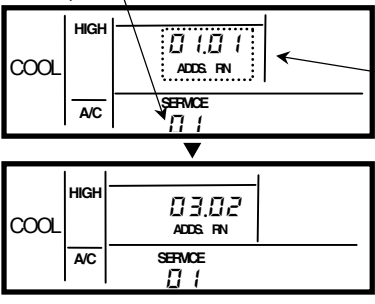

Select the indoor unit to set by pressing the "∨" or "∧" switch and press the "OK" switch.

The address of the indoor unit (ADDS) to set and the refrigerant cycle number (RN) are indicated by 0~15. (The left figure shows the Number1 cycle and Number1 indoor unit.)

<Example>
When selecting Number2 cycle and Number3 indoor unit

NOTE:

- In case that the both indications of the "ADDS." and "RN" show "AA", the same setting is performed to all the indoor units.
- The address of indoor unit not connected is not indicated.

5.3. CHANGING OF OPTIONAL FUNCTIONS AND SETTING CONDITIONS

5.3.1. OPTIONAL SETTING ITEMS

■ Optional Setting Mode (Mode Number "01")

④ Selection of Optional Setting Items

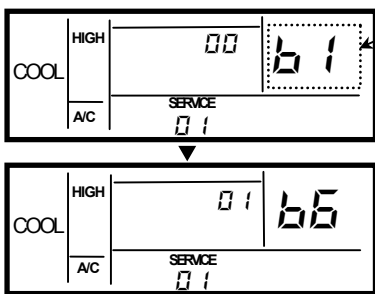

Item Code of Optional Setting

Select the item code by pressing ∆ or ∇ switch and press the "OK" switch.

<Example>
When selecting b6 and set 01 (fixing temperature)

■ Optional Setting Items

| (A) Code | Items | Individual Setting Availability | (B) Setting Conditions |
|----------|---|---------------------------------|---------------------------------|
| b1 | Cancel of Adjusting Set Temperature for Heating Operation | A | 00: Standard 01: Cancel |
| b2 | Circulator for Heating Operation | A | 00: Standard 01: Function |
| b3 | 3 Minutes Compressor OFF Guard | A | 00: Standard 01: Function |
| b4 | Period for Filter Sign | A | 00~04 *1) |
| b5 | Fixing Operation Mode | N | 00: Standard 01: Fixed |
| b6 | Fixing Setting Temperature | N | 00: Standard 01: Fixed |
| b7 | Fixing Cooling Operation | N | 00: Standard 01: Fixed |
| b8 | Automatic Cooling/Heating Operation | N | 00: Not Available 01: Available |
| b9 | Fixing Fan Speed | N | 00: Standard 01: Fixed |
| C1 | Not Prepared | — | Not Used |
| C2 | Not Prepared | — | Not Used |
| C3 | Not Prepared | — | Not Used |
| C4 | Drain Pump Operation in Heating | A | 00: Not Available 01: Available |
| C5 | Increasing Fan Speed | A | *2) |
| C6 | Increasing Fan Speed When Thermo-OFF in Heating | A | 00: Not Available 01: Available |
| C7 | Cancel of 3 Minutes Compressor OFF Guard | A | 00: Standard 01: Cancel |

i NOTE:

*1) 00: Standard; 01: 10 hours; 02: 1200 hours; 03: 2500 hours; 04: Not indication.

*2) For RPI: 00: Medium Static Pressure; 01: Hi Static Pressure; 02: Low Static Pressure
For RCI, RCIM and RCD: 00: Normal; 01: Increasing speed 1; 02: Increasing speed 2

■ Optional Setting Items (Cont.)

| (A) Code | Items | Individual Setting Availability | (B) Setting Conditions |
|-------------|---|---------------------------------------|------------------------------------|
| C8 | Remote Control Thermostat | A | 00: Not Available 01, 02: *3) |
| C9 | Not Prepared | - | Not Used |
| CA | Not Prepared | - | Not Used |
| Cb | Selection of Manual Stoppage Logic | N | 00: A Contact 01: B Contact |
| CC | Not Prepared | N | 00 |
| d1 | Power Supply ON/OFF 1 | A | 00: Not Available 01: Available |
| d2 | Not Prepared | - | Not Used |
| d3 | Power Supply ON/OFF 2 | A | 00: Not Available 01: Available |
| E1 | Ventilation Mode | A | 00~02 *4) |
| E2 | Operation To Increase Air Volume for Ventilation | A | 00: Not Available 01: Available |
| E3 | Not Prepared | - | Not Used |
| E4 | Cool Down/Warm Up Period (KPI and Econofresh) | A | 00~02 *5) |
| E5 | Not Prepared | - | Not Used |
| F1 | Not prepared | - | Not Used |
| F2 | Remote Control Main-Sub Setting | N | 00: Main 01: Sub |
| F3 | Not prepared | - | Not used |
| F4 | | | |
| F5 | | | |
| F6 | | | |
| F7 | | | |
| F8 | MODE LOCK | N | 00: Not Available 01: Available |
| F9 | TEMP LOCK | N | 00: Not Available 01: Available |
| FA | FAN LOCK | N | 00: Not Available 01: Available |
| Fb | Louver Lock | N | 00: Not Available 01: Available |
| Fc | Cooling Temperature Range Limit | N | 00~10 *6) |
| Fd | Heating Temperature Range Limit | N | 00~10 *7) |
| FE | Heating Automatic operation Temperature | N | 00: 5 °C 01: 10 °C 02: 15 °C |



NOTE:

*3) 00: Not available; 01: Control Remote control switch thermistor; 02: Average by Indoor suction thermistor and Remote Control switch thermistor.

*4) For Econofresh: 00: Not available; 01/02: All fresh Air Mode
For KPI: 00: Automatic ventilation; 01: Ventilation by total heat exchanger; 02: By pass ventilation.

*5) For Econofresh: 00: Not available; 01/02: CO₂ Sensor Mode
For KPI: 00: Standard; 01: Minutes; 02: 60 Minutes.

*6) 00: Standard, 01~10: Minimum Temperature +1~+10°C

*7) 00: Standard, 01~10: Maximum Temperature -1~ -10°C

E1~E5: For KPI only

5.3.2. INPUT/OUTPUT NUMBER

■ Input/Output Setting Mode (Mode Number “02”)

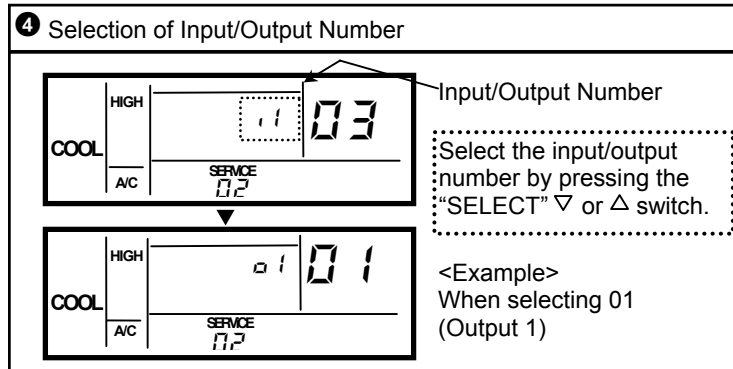

■ Input and Output Setting Mode and Connector

| Setting | | Port | Setting at Shipping | |
|----------|------------|---------|---|------------|
| Mode | Indication | | Setting Item | Indication |
| Input 1 | 11 | CN3 1-2 | Remote ON/OFF 1 | 03 |
| Input 2 | 12 | CN3 2-3 | Forbidding Remote Control after Manual Stoppage | 06 |
| Output 1 | 01 | CN7 1-2 | Operation | 01 |
| Output 2 | 02 | CN7 1-3 | Alarm | 02 |
| Output 3 | 03 | CN8 1-2 | Thermo-ON for Heating | 06 |

| Indication | Input | Output |
|------------|---|-----------------------|
| 00 | Not Set | Not Set |
| 01 | Room Thermostat (for Cooling) | Operation |
| 02 | Room Thermostat (for Heating) | Alarm |
| 03 | Remote ON/OFF 1 | Cooling |
| 04 | Remote ON/OFF 2 (Operation) | Thermo-ON for Cooling |
| 05 | Remote ON/OFF 2 (Stoppage) | Heating |
| 06 | Forbidding Remote Control after Manual Stoppage | Thermo-ON for Heating |
| 07 | Remote Cooling/Heating Change | Total Heat Exchanger |
| 08 | Not Set | Not Set |



ATTENTION:

Write down the contents of the setting in the table printed on the holding bracket.

6. TIMER OPERATION PROCEDURE

6.1. SETTING THE ACTUAL TIME AND DAY

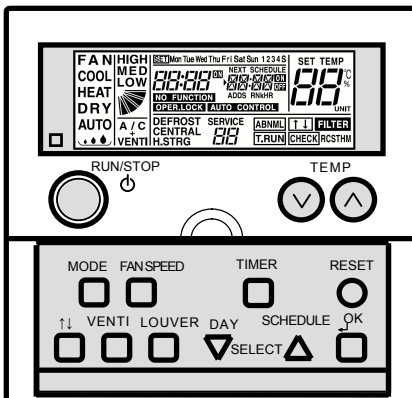

1. Press ▾ DAY switch more than 3 seconds to change the operation mode to actual time setting mode. **SET** is indicated and the day flickers. The days except the actual day are indicated.



2. Press ▾ DAY switch until the actual day flickers, then press OK switch. Selected day is indicated and “time” flickers.

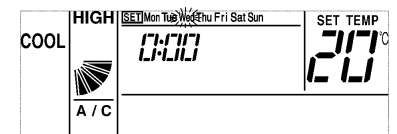

3. Press SELECT ▲ ▾ switch to adjust “Hour”, and when adjusted press OK switch. “Hour” is indicated and “minutes” flickers.

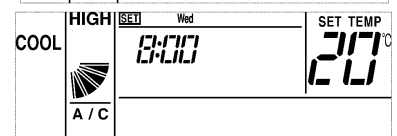

4. Press ▲ ▾ switch to adjust “minutes”, and when adjusted press OK switch. The actual time setting mode is finished and changed to normal mode. “Minutes” is indicated and **SET** is lighted off. “Seconds” starts from zero.

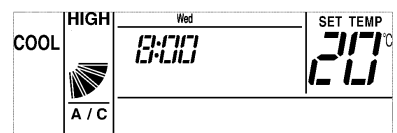

6.2. SETTING TIMER (PROGRAMMING)

1. Press TIMER switch. **SET** and SCHEDULE are indicated. Schedule Number "1" flickers and other numbers are indicated.

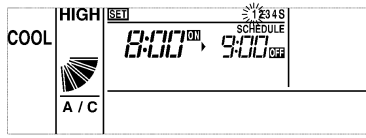

5. Press SELECT Δ / ∇ switch to adjust "minutes", and when adjusted, press OK switch. "Minutes" is indicated and "hour" of OFF time flickers.

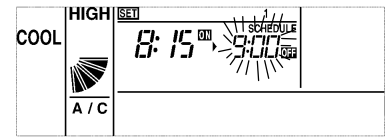

2. By pressing Δ schedule switch, schedule Number moves [1]→[2]→[3]→[4]→[S]→[1]→...

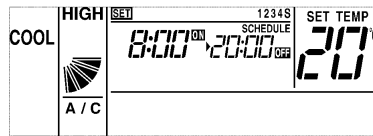

6. Set OFF time in the same way as that of ON time. After setting "minutes", OFF time is indicated. In case of selecting schedule number [1][2][3][4], the indication is changed to set the schedule Number shown in the 2. In case of selecting [S], see the chapter of setting shift temperature for details.

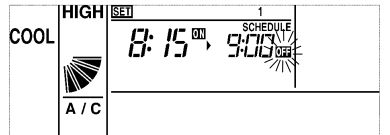

*In case of selecting [S], ON/OFF time and shift temperature can be set.

*By pressing TIMER switch, **SET** and SCHEDULE are lighted off and changed to normal mode.

3. By pressing OK switch, selected schedule Number is indicated. Other schedule number are lighted off, and "Hour" of ON time for the selected schedule Number flickers.

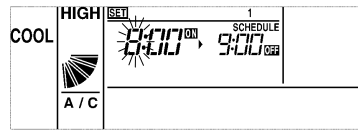

7. By pressing TIMER switch, **SET** and SCHEDULE are lighted off and back to normal mode.

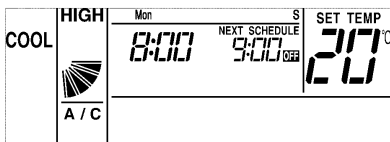

4. Press SELECT Δ / ∇ switch to adjust "hour", and when adjusted press OK switch. "Hour" is indicated and "minutes" flickers.

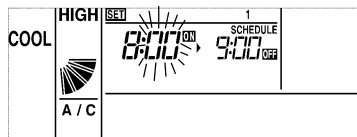

6.3. DETERMINE APPLICABLE SCHEDULE

1. Press TIMER switch more than 3 seconds and **SET** is indicated. All days and schedule Number are indicated.

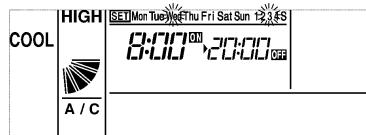

4. Press switch, and SCHEDULE is indicated, and then schedule number selected at item 3 is applied to the days set in item 2. By pressing OK switch, switch valid/invalid and SCHEDULE lights ON/OFF is appeared.

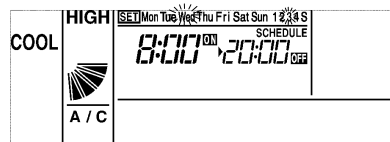

2. Press ∇ DAY switch until the day to be set flickers. By pressing it, the day flickers [Mon]→[Tue]→...→[Sun]→[Mon~Sun]→[Mon~Fri]→[Sat, Sun]→[Mon]... In case of flickering various days, the same setting is applied to the days.

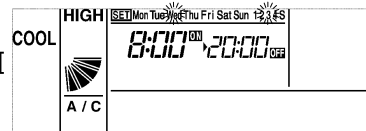

5. Press TIMER switch and **SET** lights off, and back to normal mode.

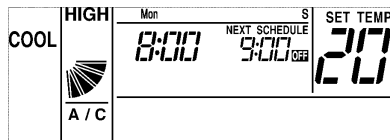

3. Press Δ SCHEDULE switch until schedule number to set flickers.

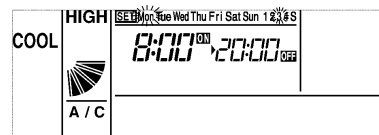

6.4. TIMER CANCELLATION

In normal mode, press SELECT Δ switch simultaneously more than 3 seconds. NEXT SCHEDULE flickers. (All the timer cancellation)

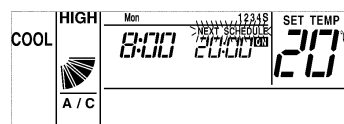

During the TIMER cancellation mode, press SELECT Δ switch simultaneously more than 3 seconds. NEXT SCHEDULE is indicated. (Timer activation)

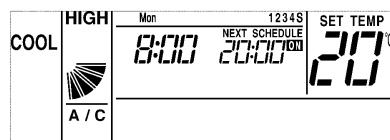

6.5. SETTING OF SHIFT TEMPERATURE (ENERGY SAVING MODE)

Increase or decrease setting temperature ($\pm 3^\circ\text{C}$ or $\pm 5^\circ\text{C}$) according to in ON time or OFF time. shift of temperature differs based on the operation mode. In case of "fan", "cooling" and "dry", from the shifting temperature: + shift. In case of "heating", from the setting temperature: - shift.

1. Perform the ON/OFF time setting operation of sub-chapter point 1 and 2, and then select "S" as a schedule number

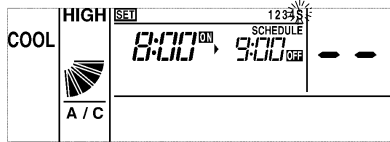

2. Perform the ON/OFF time setting operation of sub-chapter point 4 and 6, and set ON/OFF time. After setting ON/OFF time, setting temperature is indicated.

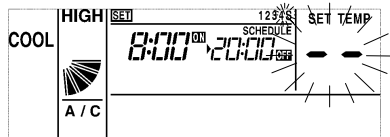

3. Select the temperature to shift by Δ / ∇ switch. "3" or "5" can be selected. In this time, if reset switch is pressed, shift temperature is not performed indicating "--". By pressing TIMER switch, temperature is indicated and change to the schedule number selection.

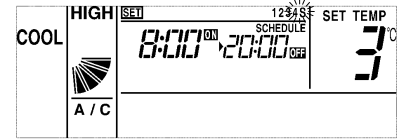

4. By pressing TIMER switch, [SET] and [SCHEDULE] light off and return to the normal mode.

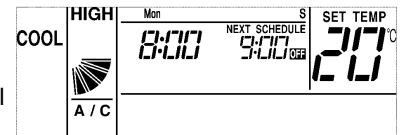

NOTE:

1. Setting temperature indication will be changed.
2. Setting temperature from CS-NET or PSC-5S is normal range, from R.C.S. can be changed in a new range.

6.6. SETTING OF HEATING AUTOMATIC OPERATION (ANTI-FREEZE PROTECTION)

If room temperature is below a certain temperature^{1*}, heating is operated automatically. In case of heating automatic operation, when room temperature reaches to setting temperature, operation is stopped.

1. In normal [MODE], press switch to change operation mode more than 3 sec. Heating automatic operation setting is valid and ON is indicated at the right side of actual time. ON flickers during heating automatic operation.

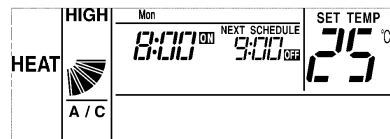

Release

While heating automatic operation is valid, press [MODE] switch to change operation mode more than 3 sec in normal mode.

Heating automatic operation setting is invalid, and ON at right side of actual time lights off.

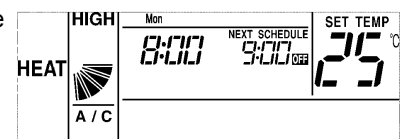

NOTE:

- *¹ (5/10/15°C) can be selected by optional setting.

6.7. METHOD OF OPERATION LOCK

To prevent incorrect switch operation, switch operation * can be locked.

*Switch to be invalid can be selected from "operation mode change", "temperature adjustment", "airflow" and "autolouver" by optional setting (F8~Fb) up to 4 items.

1. In normal mode, press ∇ / Δ SELECT switch simultaneously more than 3 sec. Operation lock is valid and OPER.LOCK is indicated. If locked switch is pressed during operation lock, OPER.LOCK flickers.

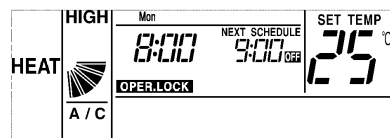

Release

While operation lock is valid, press ∇ / Δ SELECT switch simultaneously more than 3 sec in normal mode. Operation lock is invalid and OPER.LOCK lights off.

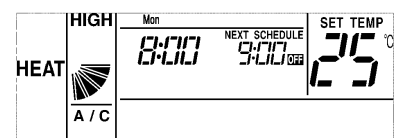

NOTE:

- From CS-NET or sub-remote controller, setting can be changed.