

# INSTALLATION MANUAL



Refrigerant  
**R407C**

## **CEILING SUSPENSION TYPE**

### **SPLIT TYPE AIR CONDITIONER** (PART NO. 9363005011)

**This air conditioner uses new refrigerant HFC (R407C).**

**For authorized service personnel only.**

 <b>WARNING!</b>	This mark indicates procedures which, if improperly performed, might lead to the death or serious injury of the user.
 <b>CAUTION!</b>	This mark indicates procedures which, if improperly performed, might possibly result in personal harm to the user, or damage to property.

#### **WARNING**

- (1) For the air conditioner to operate satisfactorily, install it as outlined in this installation manual.
- (2) Connect the indoor unit and outdoor unit with the air conditioner piping and cords available standards parts.  
This installation manual describes the correct connections using the installation set available from our standard parts.
- (3) Installation work must be performed in accordance with national wiring standards by authorized personnel only.
- (4) If refrigerant leaks while work is being carried out, ventilate the area.  
If the refrigerant comes in contact with a flame, it produces a toxic gas.
- (5) Do not turn on the power until all installation work is complete.

- Be careful not to scratch the air conditioner when handling it.
- After installation, explain correct operation to the customer, using the operating manual.
- Let the customer keep this installation manual because it is used when the air conditioner is serviced or moved.

## SELECTING THE MOUNTING POSITION

### ⚠ WARNING

Install at a place that can withstand the weight of the indoor and outdoor units and install positively so that the units will not topple or fall.

### ⚠ CAUTION

- (1) Do not install where there is the danger of combustible gas leakage.
- (2) Do not install the unit near a source of heat, steam, or flammable gas.
- (3) If children under 10 years old may approach the unit, take preventive measures so that they cannot reach the unit.

Decide the mounting position with the customer as follows:

### INDOOR UNIT

- (1) Install the indoor unit level on a strong wall which is not subject to vibration.
- (2) The inlet and outlet ports should not be obstructed : the air should be able to blow all over the room.
- (3) Do not install the unit where it will be exposed to direct sunlight.
- (4) Install the unit where connection to the outdoor unit is easy.
- (5) Install the unit where the drain pipe can be easily installed.
- (6) Take servicing, etc. into consideration and leave the spaces shown in (Fig. 1 or 2). Also install the unit where the filter can be removed.

Fig. 1

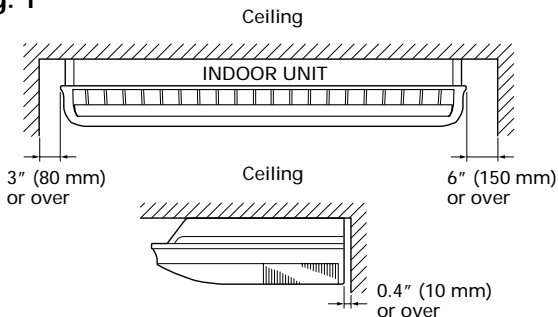

[FOR HALF CONCEALED INSTALLATION]

Fig. 2

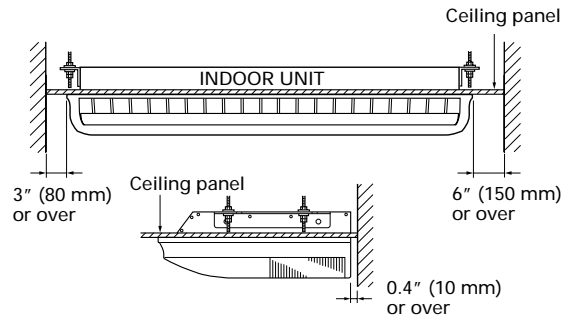
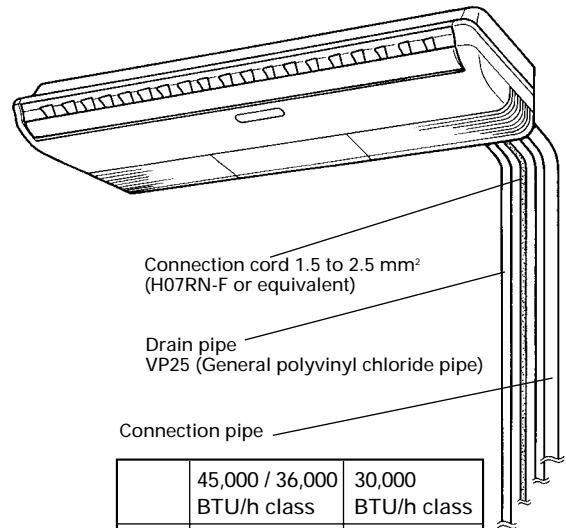

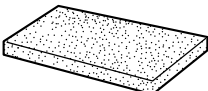





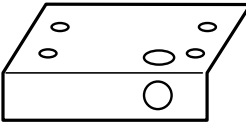

Fig. 3



	45,000 / 36,000 BTU/h class	30,000 BTU/h class
Large	ø19.05 mm	ø15.88 mm
Small	ø9.53 mm	ø9.53 mm

## STANDARD PARTS

The following installation parts are furnished.  
Use them as required.

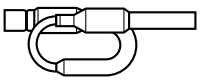
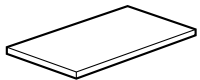
INDOOR UNIT ACCESSORIES		
Description	Q'ty	Application
Drain hose insulation 	1	Adhesive type 70 x 230
VT wire 	1	For fixing the drain hose L 280 mm
Coupler heat insulator (large) 	2	For indoor side pipe joint (large pipe)
Coupler heat insulator (small) 	1	For indoor side pipe joint (small pipe)
Nylon fastener 	Large 4 Small 4	For fixing the coupler heat insulator
Special nut A (large flange) 	4	For installing indoor unit
Special nut B (small flange) 	4	For installing indoor unit
Installation template 	1	For positioning the indoor unit
Auxiliary pipe assembly 	1	For connecting the piping
Indoor capillary tube 	1	(This part is enclosed with the 30,000 and 36,000 BTU/h versions.)
BR sheet 	2	65 x 130 x T5 (This part is enclosed with the 30,000 and 36,000 BTU/h versions.)

## CONNECTION PIPE REQUIREMENT

Table 1

	Diameter	
	Small	Large
45,000 / 36,000 BTU/h class	9.53 mm	19.05 mm
30,000 BTU/h class	9.53 mm	15.88 mm

- Use 0.7 mm to 1.2 mm thick pipe.
- Use pipe with water-resistant heat insulation.
- Use pipe that can withstand a pressure of 3,040 kPa.

## ELECTRICAL REQUIREMENT

Table 2

Connection cord (mm <sup>2</sup> )	MAX	2.5
	MIN	1.5

- Always use H07RN-F or equivalent as the connection cord.
- Install the disconnection device with a contact gap of at least 3 mm nearby the units. (Both indoor unit and outdoor unit)

# INSTALLATION PROCEDURE

Install the air conditioner as follows:

## 1. PREPARING INDOOR UNIT INSTALLATION

### REMOVE THE INTAKE GRILLE AND SIDE COVER.

- (1) Remove the two Air filters (Fig.4).
- (2) Remove the two Intake grilles (Fig.4).
  - For ④ Left rear drain and ⑤ Left drain: Remove air filters and intake grilles at three places. (Refer to "2. INDOOR UNIT INSTALLATION".)
- (3) Remove the Side cover A (Right side) and Side cover B (Right and Left side).
  - For ⑤ Left drain : Remove both the Side cover A (Right and Left side). (Refer to "2. INDOOR UNIT INSTALLATION".)
- (4) This air conditioner can be set up to intake fresh air. For information about how to install for fresh-air intake, refer to "13. FRESH-AIR INTAKE".

Fig. 4

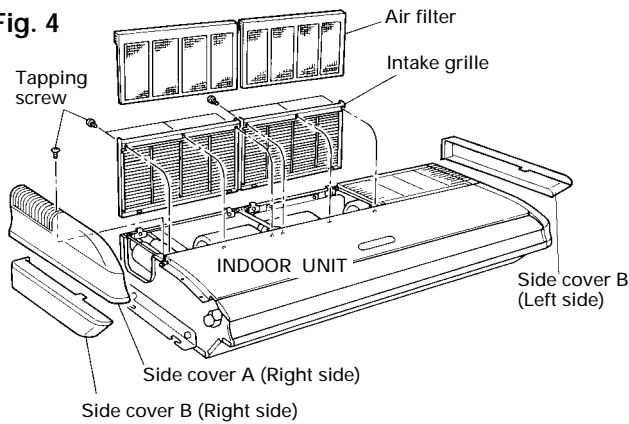

### [For Half-Concealed Installation]

- Suspension-bolt pitch should be as shown in Fig. 6.

Fig. 7

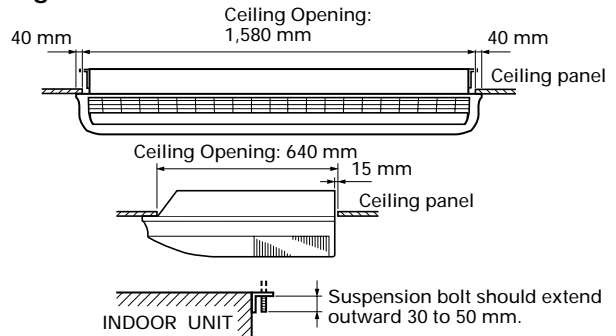

## 2. SELECT PIPING DIRECTION

Select connection piping and drain piping directions. (Fig.8)

Fig. 8

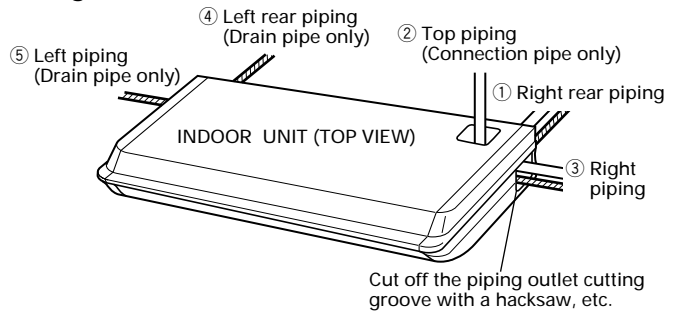

## 2. INDOOR UNIT INSTALLATION

You can use the accessory template to help you install the indoor unit. The template helps you determine the appropriate locations for suspension bolts and pipe openings (drain pipe and connection cord).

Fig. 5

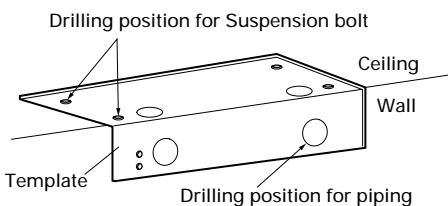

### 1. LOCATION OF CEILING SUSPENSION BOLTS

Fig. 6

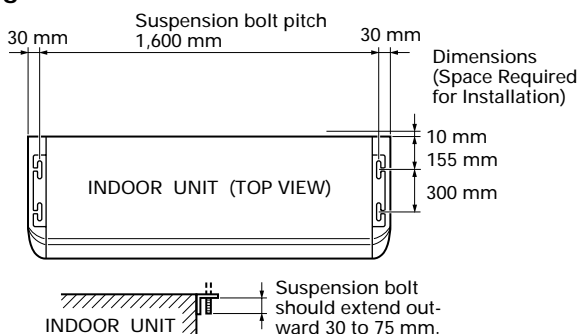

### [For ④ Left rear piping, ⑤ Left piping]

- Transfer the Drain cap and Drain cap seal.

Fig. 9

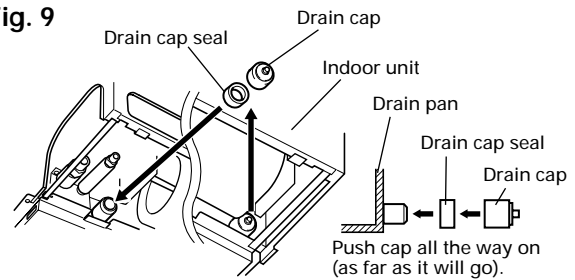

### 3. DRILLING THE HOLES AND ATTACHING THE SUSPENSION BOLTS

- (1) Drill  $\varnothing 25\text{mm}$  holes at the suspension-bolt locations.
- (2) Install the bolts, then temporarily attach Special nuts A and B and a normal M10 nut to each bolt. (The two special nuts are provided with the unit. The M10 nut must be obtained locally.) Refer to Fig. 10.

<b>Bolt Strength</b>	980 to 1,470 N (100 to 150 kgf)
----------------------	---------------------------------

Fig. 10

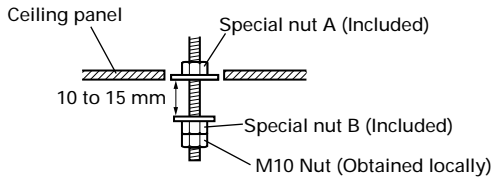

#### [If using anchor bolts]

- (1) Drill holes for anchor bolts at the locations at which you will set the suspension bolts. Note that anchor bolts are M10 bolts (to be obtained locally).
- (2) Install the anchor bolts, then temporarily attach special nut "B" (included) and a locally-procured M10 nut to each of the bolts. (See Fig. 11.)

<b>Anchor-Bolt Strength</b>	980 to 1,470 N (100 to 150 kgf)
-----------------------------	---------------------------------

Fig. 11

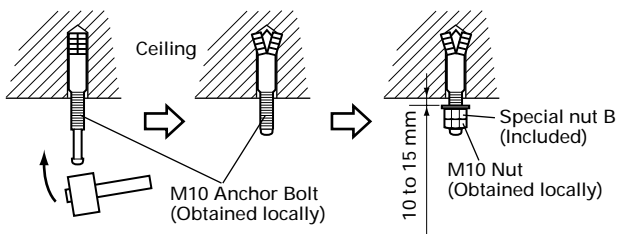

### 4. INSTALLING THE INDOOR UNIT

- (1) Lift unit so that suspension bolts pass through the suspension fittings at the sides (four places), and slide the unit back. (See Fig. 13.)

Fig. 12

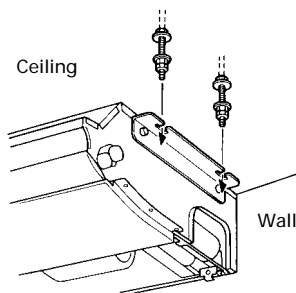
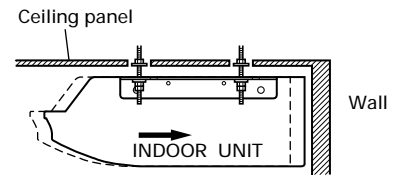

Fig. 13



- (2) Fasten the indoor unit into place by tightening-up the special "B" bolts and the M10 nuts. Make sure that unit is secure and will not shift back and forth.

#### [For Half-Concealed Installation]

When installing the indoor unit in a semi-concealed shape, make sure to reinforce the insulation of the unit on all sides. Drops of water may fall from the unit if it is not thoroughly insulated.

Fig. 14

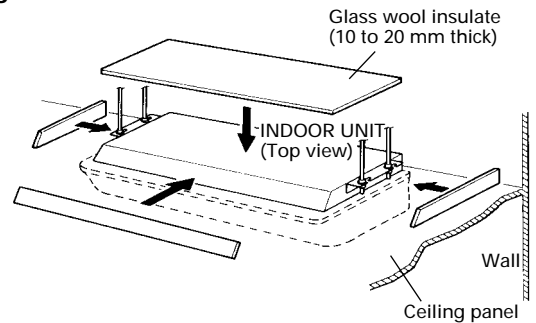

#### ⚠ CAUTION

In order to check the drainage, be sure to check a level during installation of the indoor unit. If the installation site of the indoor unit is not level, water leakage may occur.

### 3. CONNECTING THE PIPING

#### ⚠ CAUTION

- (1) Do not use mineral oil on flared part. Prevent mineral oil from getting into the system as this would reduce the lifetime of the units.
- (2) Never use piping which has been used for previous installations. Only use parts which are delivered with the unit.
- (3) While welding the pipes, be sure to blow dry nitrogen gas through them.

#### 1. FLARE PROCESSING

- (1) Cut the connection pipe with pipe cutters so that the pipe is not deformed.
- (2) Hold the pipe downwards so that cuttings cannot enter the pipe, remove the burrs.
- (3) Remove the flare nut from the indoor unit pipe and outdoor unit and assemble as shown in (Table 3) and insert the flare nut onto the pipe, and flare with a flaring tool.
- (4) Check if the flared part "L" (Fig. 15) is spread uniformly and that there are no cracks.

Table 3

Pipe	Flare nut
Small pipe (9.53 mm dia)	Small (width across flats 22 mm)
Large pipe (15.88 mm dia)	Large (width across flats 24 mm)
Large pipe (19.05 mm dia)	Large (width across flats 36 mm)

Fig. 15

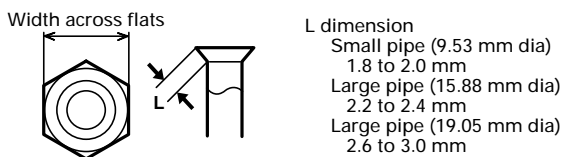

#### 2. BENDING PIPES

The pipes are shaped by your hands. Be careful not to collapse them.

Fig. 16

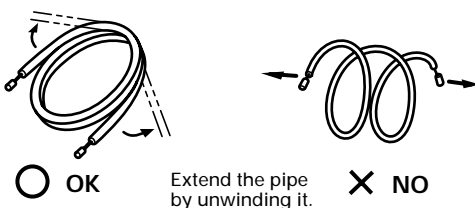

Do not bend the pipes in an angle more than 90°. When pipes are repeatedly bent or stretched, the material will harden, making it difficult to bend or stretch them any more. Do not bend or stretch the pipes more than three times.

When bending the pipe, do not bend it as is. The pipe will be collapsed. In this case, cut the heat insulating pipe with a sharp cutter as shown in Fig. 17, and bend it after exposing the pipe. After bending the pipe as you want, be sure to put the heat insulating pipe back on the pipe, and secure it with tape.

Fig. 17

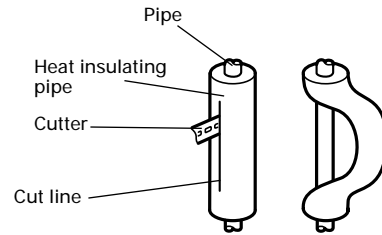

#### 3. CONNECTION PIPES

- (1) Remove the filter guide (Fig. 18).

Fig. 18

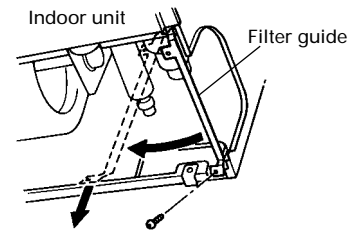

- (2) Attach the connection pipe (Fig. 19).

Fig. 19

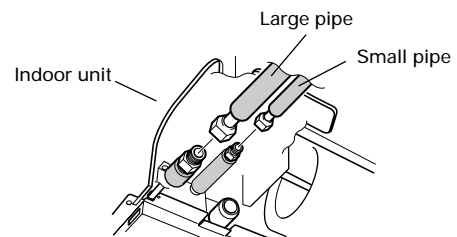

- For ② Top piping and ③ Right piping connections, use the Auxiliary pipe (large pipe) provided.

Fig. 20

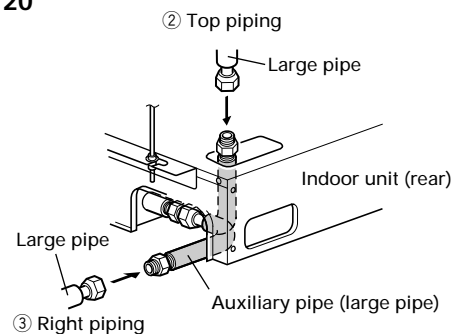

#### ⚠ CAUTION

Be sure to apply the pipe against the port on the indoor unit correctly. If the centering is improper, the flare nut cannot be tightened smoothly. If the flare nut is forced to turn, the threads will be damaged.

When the flare nut is tightened properly by your hand, hold the body side coupling with a separate spanner, then tighten with a torque wrench (Fig. 21).

Fig. 21

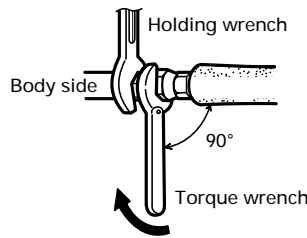

**CAUTION**  
Hold the torque wrench at its grip, keeping it in the right angle with the pipe as shown in Fig. 21, in order to tighten the flare nut correctly.

Table 4 : Flare nut tightening torque

Pipe	Tightening torque
Small pipe (9.53 mm dia)	310 to 350 kgf • cm (30.4 to 34.3 N • m)
Large pipe (15.88 mm dia)	750 to 800 kgf • cm (73.5 to 78.4 N • m)
Large pipe (19.05 mm dia)	800 to 1,000 kgf • cm (78.4 to 98 N • m)

#### 4. CONNECTING AN INDOOR CAPILLARY TUBE

These instructions refer to the 30,000 and 36,000 BTU/h versions.

##### Installation Procedure

- (1) Braze each part (connection pipe, indoor capillary tube, and branch liquid pipe) as shown in Fig. 22.
- (2) Wrap the two BR sheets around the indoor capillary tube as shown in Fig. 23.
- (3) Cover the indoor capillary tube and the branch liquid pipe with insulation (Fig. 24) and affix the insulation with tape.
- (4) Secure the insulation using the binders (Fig. 25).
  - If the joint pipe must be installed, refer to the installation installation manual for the outdoor unit for details.

Fig. 22

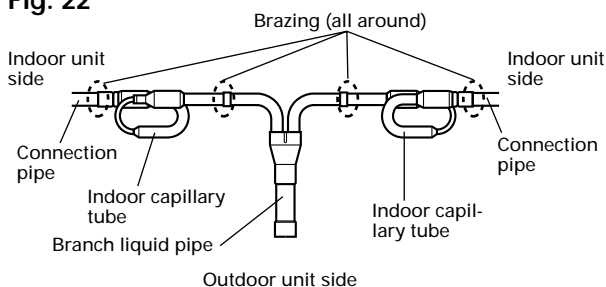

Fig. 23

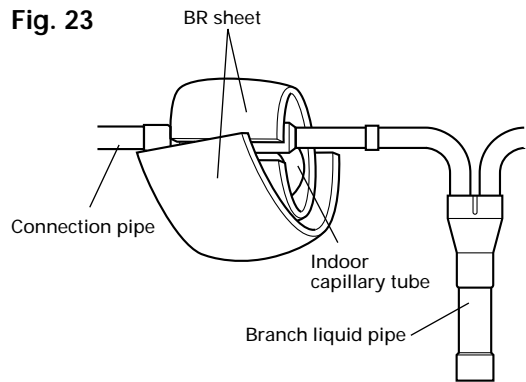

Fig. 24

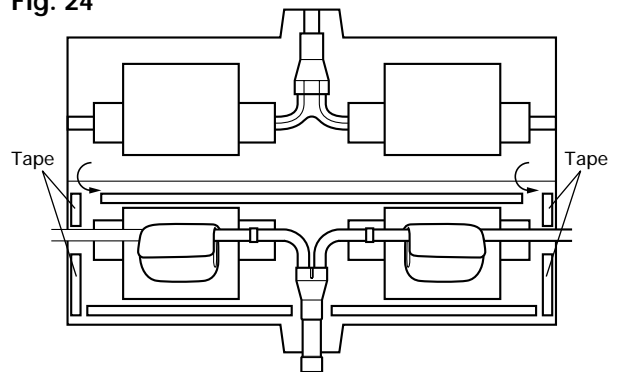
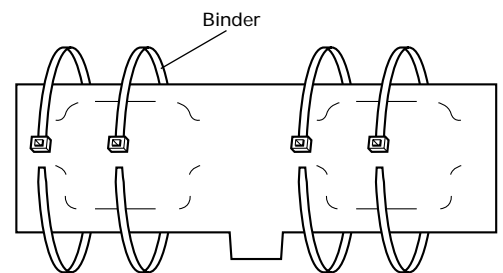

Fig. 25



#### 4. INSTALLING THE COUPLER HEAT INSULATION

After checking for gas leaks, insulate by wrapping insulation around the two parts (large and small) of the indoor unit coupling, using the coupler heat insulation.

After installing the coupler heat insulation, wrap both ends with vinyl tape so that there is no gap.

Secure both ends of the heat insulation material using nylon fasteners.

Fig. 26

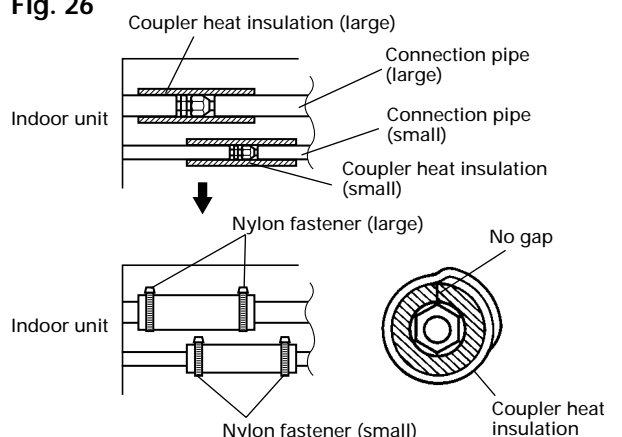

- When using an auxiliary pipe, make sure that the fastener used is insulated in the same way.

## 5. DRAIN PIPING

- Install the drain pipe with downward gradient (1/50 to 1/100) and so there are no rises or traps in the pipe.
- Use general hard polyvinyl chloride pipe (VP25) [outside diameter 38 mm].
- During installation of the drain pipe, be careful to avoid applying pressure to the drain port of the indoor unit.
- When the pipe is long, install supporters (Fig. 27).
- Do not perform air bleeding.
- Always heat insulate (8 mm or over thick) the indoor side of the drain pipe.

Fig. 27

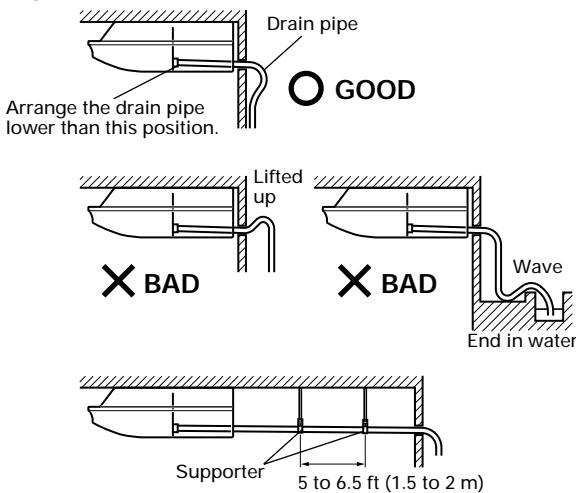

- (1) Install insulation for the drain pipe ( See Figs. 28 and 29).

Cut the included insulation material to an appropriate size and adhere it to the pipe.

Fig. 28

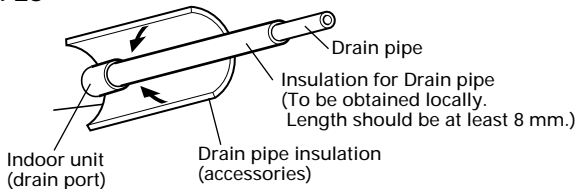
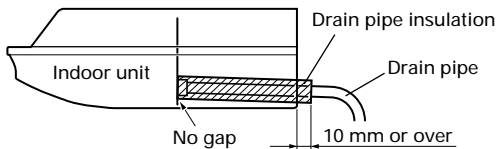
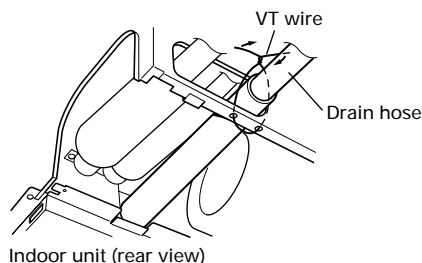

Fig. 29



- (2) If "① Right rear piping": fasten the drain pipe with VT wire so that the pipe slopes correctly within the indoor unit (Fig. 30).

Fig. 30



## 6. HOW TO CONNECT WIRING TO THE TERMINALS

### 1. IF ONE WIRE IS CONNECTED TO ONE TERMINAL BLOCK

#### A. For solid core wiring (or F-cable)

- (1) Cut the wire end with a wire cutter or wire-cutting pliers, then strip the insulation to about 15/16" (25 mm) to expose the solid wire.
- (2) Using a screwdriver, remove the terminal screw(s) on the terminal board.
- (3) Using pliers, bend the solid wire to form a loop suitable for the terminal screw.
- (4) Shape the loop wire properly, place it on the terminal board and tighten securely with the terminal screw using a screwdriver.

#### B. For strand wiring

- (1) Cut the wire end with a wire cutter or wire-cutting pliers, then strip the insulation to about 3/8" (10 mm) to expose the strand wiring.
- (2) Using a screwdriver, remove the terminal screw(s) on the terminal board.
- (3) Using a round terminal fastener or pliers, securely clamp a round terminal to each stripped wire end.
- (4) Position the round terminal wire, and replace and tighten the terminal screw using a screwdriver.

Fig. 31

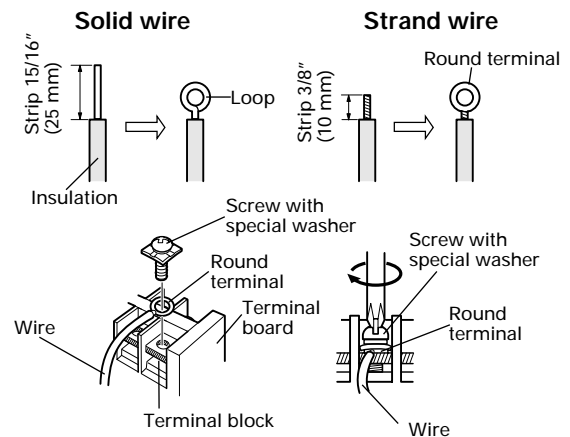

### 2. IF TWO WIRES ARE CONNECTED TO ONE TERMINAL BLOCK.

#### A. As a rule, round terminal should be used to connect to the terminal block.

- (1) Cut the wire end with a wire cutter or wire-cutting pliers, then strip the insulation to about 3/8" (10 mm) to expose the strand wiring.
- (2) Using a screwdriver, remove the terminal screw(s) on the terminal board.
- (3) Using a round terminal fastener or pliers, securely clamp a round terminal to each stripped wire end.
- (4) Position the round terminal wire, and replace and tighten the terminal screw using a screwdriver.



**Fig. 32**

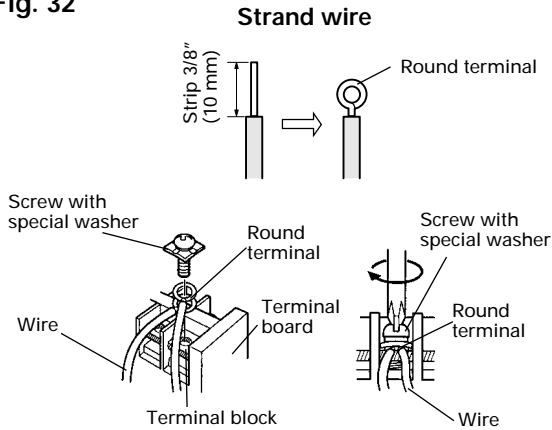

**B. If round terminal cannot be used, the following items should be followed.  
For solid core wiring (or F-cable)**

- (1) Cut the wire end with a wire cutter or wire-cutting pliers, then strip the insulation to about 1/2" (12.7 mm) to expose the solid wire.
- (2) Using a screwdriver, remove the terminal screw(s) on the terminal board.
- (3) Wires with the same diameter should be connected on both sides as shown in Fig. 33. Since connecting wires with different diameters causes the wires to heat up due to loose connections, this method should not be used.

**Fig. 33**

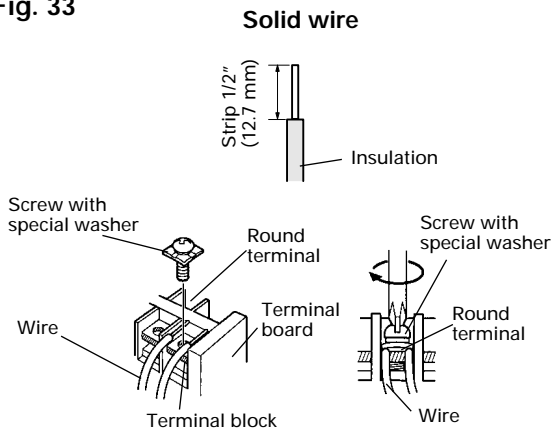

**HOW TO FIX THE CONNECTION CORD**

After passing the connection cord through the insulation tube, fasten it with the cord clamp.

**Fig. 34**

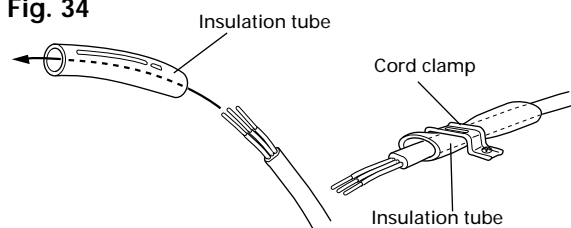

Use VW-1, 0.5 to 1.0 mm thick, PVC tube as the insulation tube.

**7. ELECTRICAL WIRING**

**⚠ WARNING**

- (1) Before starting work, check that power is not being supplied to the indoor unit.
- (2) Match the terminal board numbers and connection cord colors with those of the indoor unit. Erroneous wiring may cause burning of the electric parts.
- (3) Connect the connection cord firmly to the terminal board. Imperfect installation may cause a fire.
- (4) Always fasten the outside covering of the connection cord with the cord clamp. (If the insulation is chafed, electric leakage may occur.)
- (5) Always connect the ground wire.

- (1) Remove the two tapping screws and pull the control box downward (Fig. 35).

**Fig. 35**

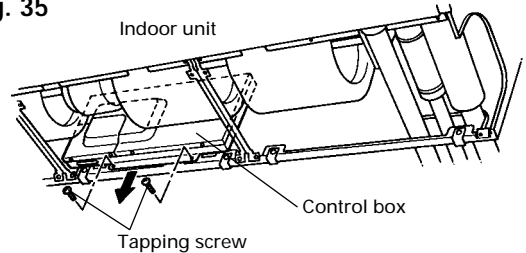

- (2) Remove the cover A and install the connection cord (Fig.36).
- (3) After wiring is complete, clamp the connection cord with the cord clamp (Fig.37).
- (4) Reattach cover A. Then fasten the control box back into its original position using the two tapping screws.
- (5) Attach the connection cord and cable clips. Make sure that they are positioned so that they will not interfere with opening and closing of the intake grille or with removal and installation of the air filters (Fig. 37).

**Fig. 36**

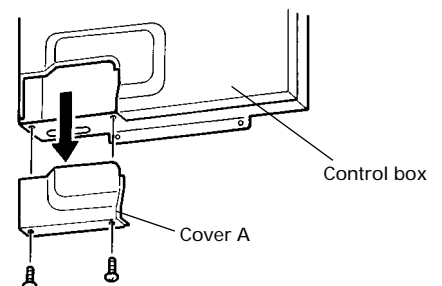
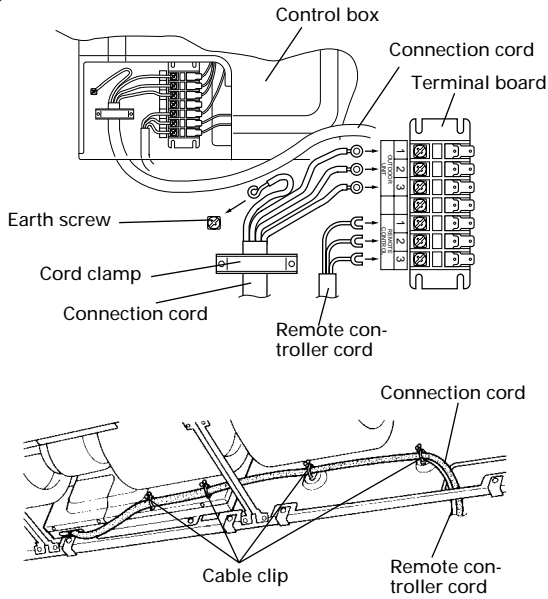

Fig. 37



**CONNECTION CORD**

**A. Simultaneous operation for buildings**

Fig. 38

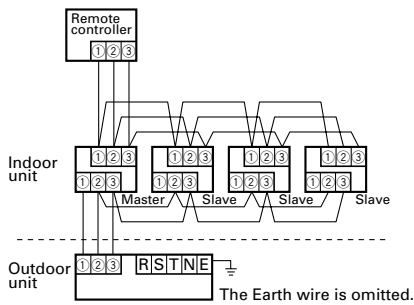

**B. Individual operation for buildings**

Fig. 41

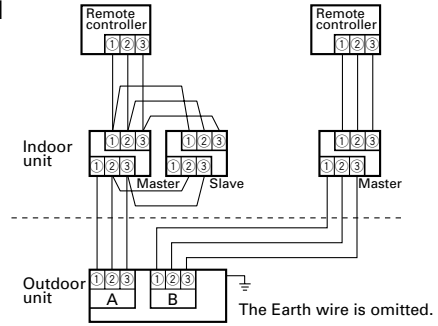

**8. PRINTED CIRCUIT BOARD SETTING**

**1. MODEL SELECT SWITCH**

Fig. 42

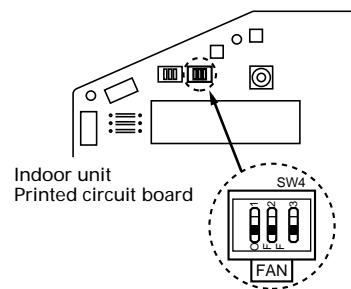

- SW4, mounted on the circuit board, should be checked.

**Table 5 : Switch Setting**

Model Name	SW4		
	1	2	3
45,000 BTU/h class	OFF	OFF	ON
36,000 BTU/h class	OFF	ON	OFF
30,000 BTU/h class	OFF	OFF	OFF

**2. MASTER/SLAVE SELECT SWITCH**

Fig. 43

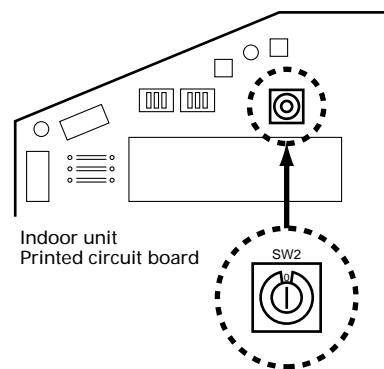

**CAUTION**

- (1) Connect a maximum of 2 wires on a single terminal block. (If 3 or more wires are connected, they could become loose and cause heating.)

Fig. 39

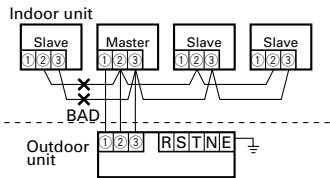

- (2) Crossovers as in (1) should not be connected when connecting wires between the master unit and slave units, and from slave unit to slave unit. (The system will not operate correctly.)

Fig. 40

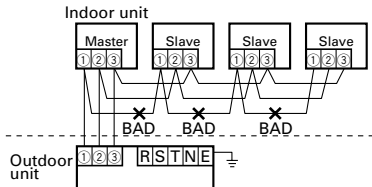

- For the master unit, set SW2 on "0". For a slave unit, set SW2 on "1~3".

**Fig. 44 [Example]**

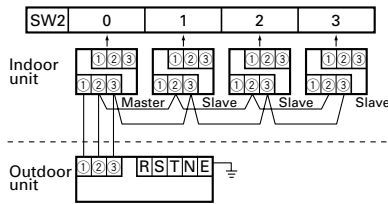

- A master unit is an indoor unit with the power line connected directly from the outdoor unit.

## 9. FINISHING

- (1) Install the filter guide.
- (2) Install the intake grilles.
- (3) Install side covers A and B (if the unit is installed in a half-concealed orientation, only install side cover A).
- (4) Install the air filters.

## 10. CUSTOMER GUIDANCE

Explain the following to the customer in accordance with the operating manual:

- (1) Starting and stopping method, operation switching, temperature adjustment, timer, air flow adjustment, and other remote controller operations.
- (2) Air filter removal and cleaning.
- (3) Give the operating and installation manuals to the customer.

## 11. REMOTE CONTROLLER INSTALLATION

- Insert the end of a flat blade screwdriver at the arrow parts of the groove at the side of the remote controller case and remove the remote controller case top by turning the screwdriver.
- Disconnect the remote controller cord from the remote controller terminal board.

**Fig. 45**

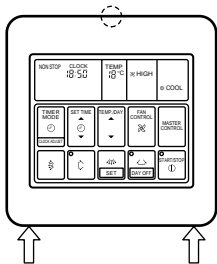

- (1) When remote controller exposed
  - 1) Make a notch in the thin part (○part of Fig. 45) at the remote controller case top and bottom with nippers, file, etc.
  - 2) Connect the remote controller cord to the remote controller terminal board specified in (Fig. 46).
  - 3) Clamp the remote controller cord sheath with the binder (small) as shown in Fig. 46.
  - 4) Cut off the excess binder.

**Fig. 46**

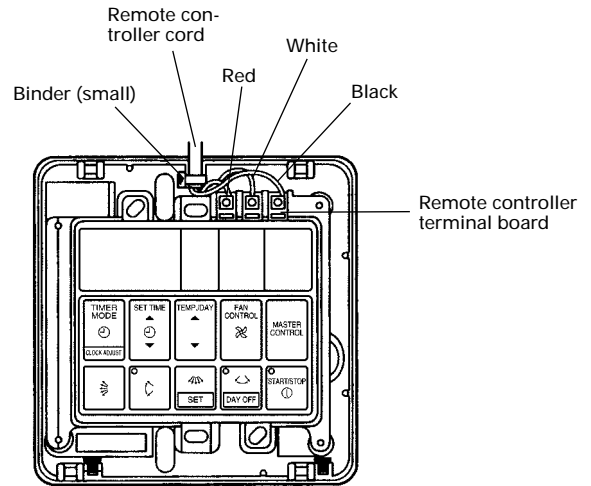

- (2) When remote controller cord embedded
  - 1) Embed the remote controller cord and box.
  - 2) Pass the remote controller cord through the hole at the remote controller case bottom and install the cord to the box (Fig. 47).
  - 3) Connect the remote controller cord to the remote controller terminal board specified in (Fig. 46).

**Fig. 47 [Example]**

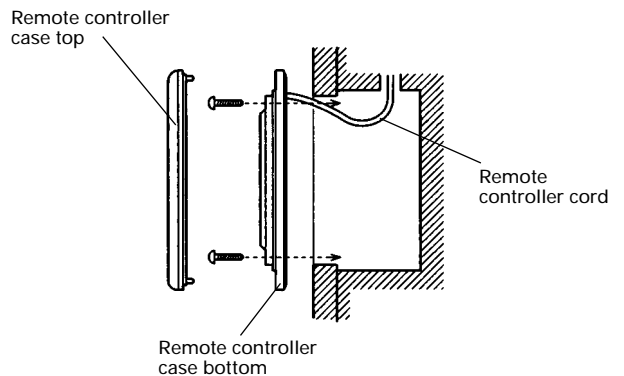

- After wiring work is complete, return the remote controller case top to its original state.

### ⚠ CAUTION

- (1) Do not bundle the remote controller cord, or wire the remote controller cord in parallel, with the indoor unit connection wire (to the outdoor unit) and the power supply cord. It may cause erroneous operation.
- (2) When installing the remote controller and cord near a source of electromagnetic waves, separate the remote controller from the source of the electromagnetic waves and use shielded cord.
- (3) Do not touch the remote controller PC board and PC board parts directly with your hands.

## 12. TEST RUNNING

### REMOTE CONTROLLER

- Supply power to the crankcase heater 12 hours before the start of operation in the winter.
- For test running, when the remote controller FAN CONTROL button and MASTER CONTROL button are pressed simultaneously for more than three seconds when the air conditioner is not running, the air conditioner starts and TEST is displayed on the remote controller display.

However, the SET TEMP. setting button does not function, but all other buttons, displays, and protection functions operate (Fig. 48).

Fig. 48

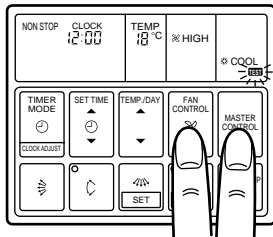

- When EE : EE blinks at the current time display, there is an error inside the air conditioner. If the SET TIME button (▼) and SET TEMP./DAY button (▼) are pressed simultaneously for more than three seconds, the self diagnosis check will start and the error contents will be displayed at the current time display. (Fig. 49) When the operation lamp lights, press the START/STOP button and after operation lamp goes off, perform the same operation. (Fig. 49) Process the error contents by referring to (Table 6).

Fig. 49

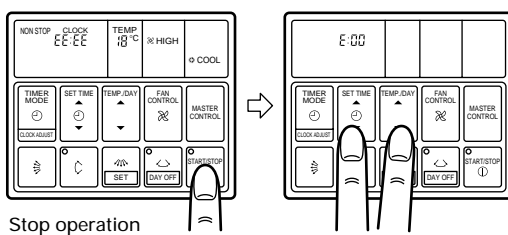

Stop operation

Table 6

Error cord	Error contents
E:00	Communication error (indoor unit ↔ remote controller)
E:01	Communication error (indoor unit ↔ outdoor unit)
E:02	Room temperature sensor open
E:03	Room temperature sensor shorted
E:04	Indoor heat exchanger temperature sensor open
E:05	Indoor heat exchanger temperature sensor shorted
E:06	Outdoor heat exchanger temperature sensor open
E:07	Outdoor heat exchanger temperature sensor shorted
E:08	Power source connection error
E:09	Float switch operated
E:0A	Outdoor temperature sensor open
E:0B	Outdoor temperature sensor shorted
E:0C	Discharge pipe temperature sensor open
E:0D	Discharge pipe temperature sensor shorted
E:0E	Outdoor low pressure abnormal
E:0F	Discharge pipe temperature abnormal
E:11	Model abnormal
E:12	Indoor fan abnormal
E:13	Outdoor signal abnormal
E:14	Outdoor EEPROM abnormal

- To stop test running, press the START/STOP button.
- For the operation method, refer to the operating manual and perform operation check.
- Check that there are no abnormal sounds or vibration sounds during test running.

### 13. FRESH-AIR INTAKE

- Open up the knockout hole for the fresh-air intake, as shown in Fig. 50. (If using half-concealed installation, open up the top knockout hole instead.)

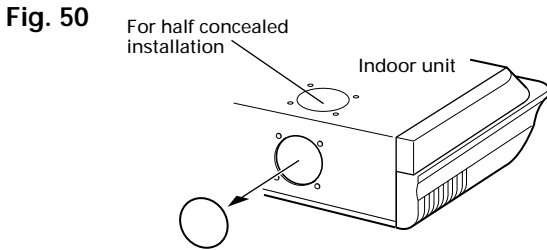

#### CAUTION

- When removing the cabinet (iron plate), be careful not to damage the indoor unit internal parts and surrounding area (outer case).
- When processing the cabinet (iron plate), be careful not to injure yourself with burrs, etc.

- Fasten the round flange (optional) to the fresh-air intake, as shown in Fig. 51. (If using half-concealed installation, attach to the top.)

Fig. 51

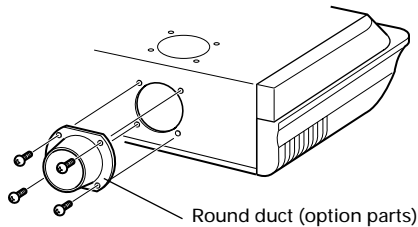

[After completing "2. INDOOR UNIT INSTALLATION" ...]

- Connect the duct to the round flange.
- Seal with a band and vinyl tape, etc. so that air does not leak from the connection.

Fig. 52

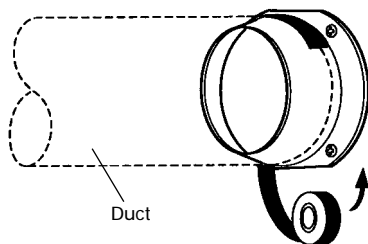

### 14. A ERROR DISPLAY

Operation can be checked by lighting and flashing of the display section OPERATION, TIMER and VERTICAL SWING lamps.

Perform judgment in accordance with the following.

Fig. 53

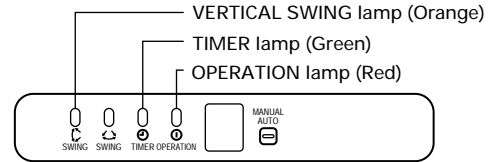

- Test running

When the air conditioner is run by pressing the remote controller test run button, the OPERATION, TIMER and VERTICAL SWING lamps flash slowly at the same time.

- Error

The OPERATION, TIMER and VERTICAL SWING lamps operate as follows (Table 7) according to the error contents.

Table 7

Error display			Error contents
OPERATION lamp	TIMER lamp	VERTICAL SWING lamp	
Blinks	Blinks	Goes off	Model information abnormal (permanent type)
Pulses 4 times	Blinks	Goes off	Drain abnormal (permanent type)
Pulses 6 times	Blinks	Goes off	Indoor fan abnormal
Pulses 2 times	Blinks	Goes off	Room air temperature thermistor open circuited
		Blinks	Room air temperature thermistor shortcircuited
Pulses 3 times	Blinks	Goes off	Piping thermistor open circuited
		Blinks	Piping thermistor short-circuited
Pulses 5 times	Blinks	Goes off	Serial communications abnormal
Blinks	Pulses 2 times	Goes off	Reverse phase wire connection abnormal
Blinks	Pulses 3 times	Goes off	Outdoor heat exchange thermistor open circuited
		Blinks	Outdoor heat exchange thermistor shortcircuited
Blinks	Pulses 6 times	Goes off	Low pressure abnormal
Blinks	Pulses 5 times	Goes off	Outdoor discharge thermistor open circuited
		Blinks	Outdoor discharge thermistor shortcircuited
Blinks	Pulses 7 times	Goes off	Discharge temperature abnormal
Blinks	Pulses 4 times	Goes off	Outdoor air temperature thermistor open circuited
		Blinks	Outdoor air temperature thermistor shortcircuited