



FUJITSU

CASSETTE TYPE AIR CONDITIONERS

TECHNICAL MANUAL



FUJITSU GENERAL LIMITED

CONTENTS

1. FEATURES	2
2. OUTLINE AND DIMENSIONS	3
2.1 INDOOR UNIT	3
2.2 OUTDOOR UNIT	4
2.3 REMOTE CONTROLLER	5
3. DATA	6
3.1 PERFORMANCE CURVE	6
3.2 TEMPERATURE RANGE	8
3.3 ADDITIONAL REFRIGERANT CHARGE	9
3.4 AIR VELOCITY DISTRIBUTION	10
3.5 DUCT CONNECTION	14
3.6 REFRIGERANT SYSTEM DIAGRAM	15
3.7 NOISE LEVEL CHECK POINTS	18
4. SPECIFICATIONS	23

1. FEATURES



• Flexible installation

Small and compact body allows space saving installation

New mechanism allows the cassette body to move 35mm downward and contributes to keeping the ceiling surface clean

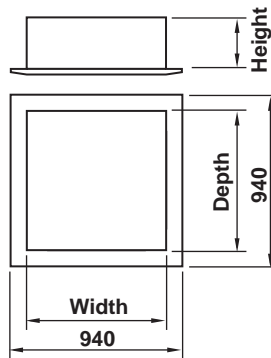

Setting space

Height	250 or 285
Width	840
Depth	840

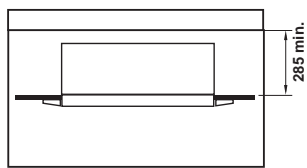

Standard setting

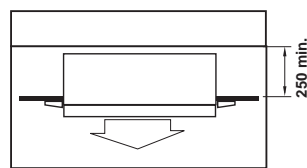

Slender setting

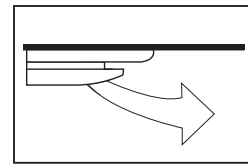

• Improvement of noise level and air distribution

Comparison of noise level (dB)

Noise level is drastically reduced by molded fan motor, bigger caliber turbo-fan and larger air flow passage.

Improvement of fan blade

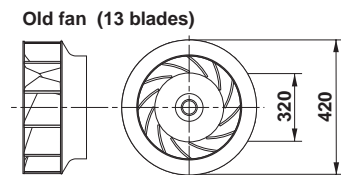

(Unit : mm)

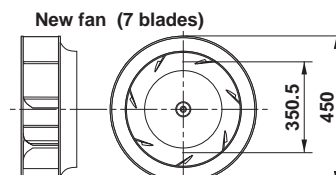

(Unit : mm)

Wide air flow

Larger air flap distributes the outlet air flow a longer distance in the horizontal direction

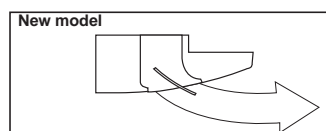
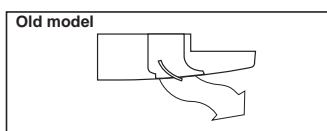

2. OUTLINE AND DIMENSIONS

2.1 INDOOR UNIT

(Unit : mm)

- MODELS : AUY30A, AUY36A, AUY45A, AUY54A
AUY30R, AUY36R, AUY45R, AUY54R

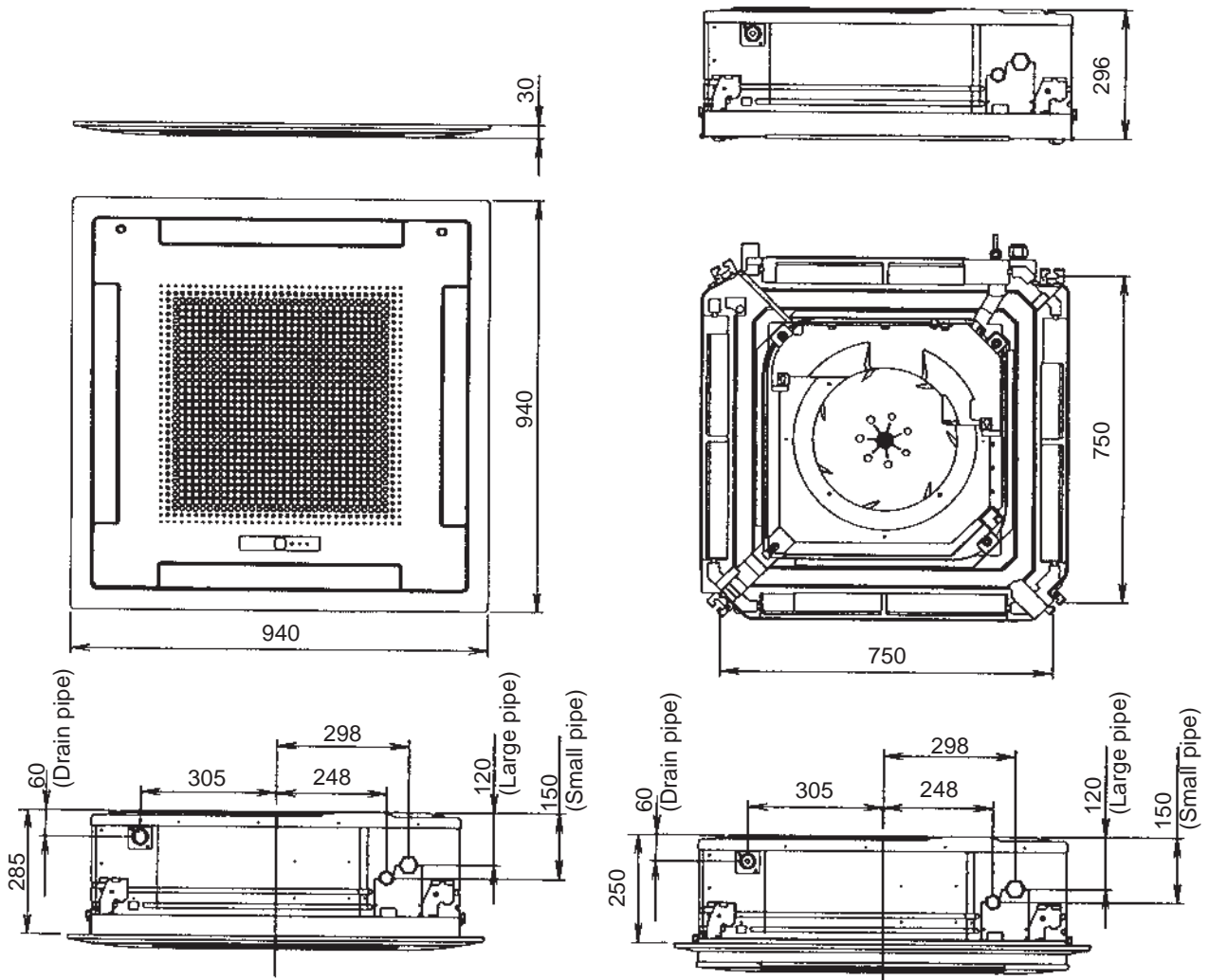

2.2 OUTDOOR UNIT

- MODELS : AOY30A, AOY30R

(Unit : mm)

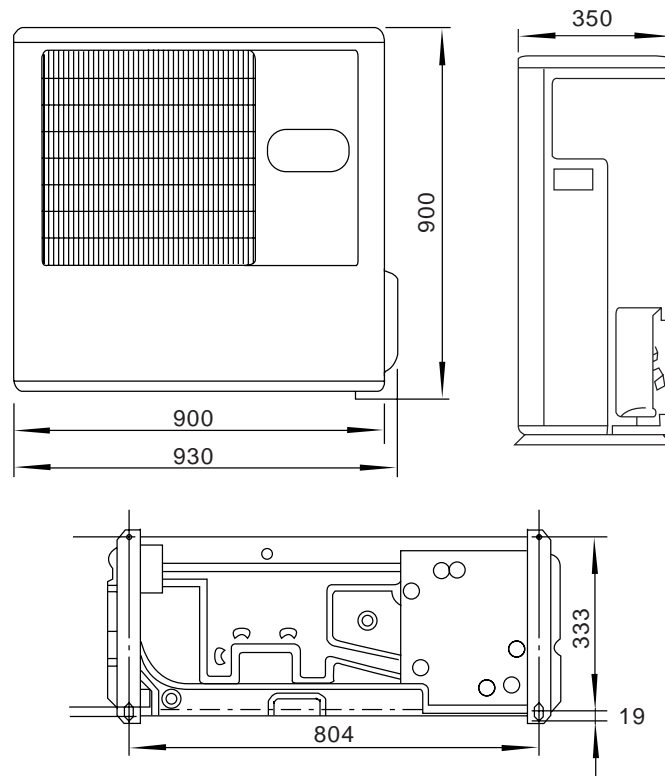

- MODELS : AOY36A(3), AOY36R(3)
AOY45A(3), AOY45R(3)
AOY54A(3), AOY54R(3)

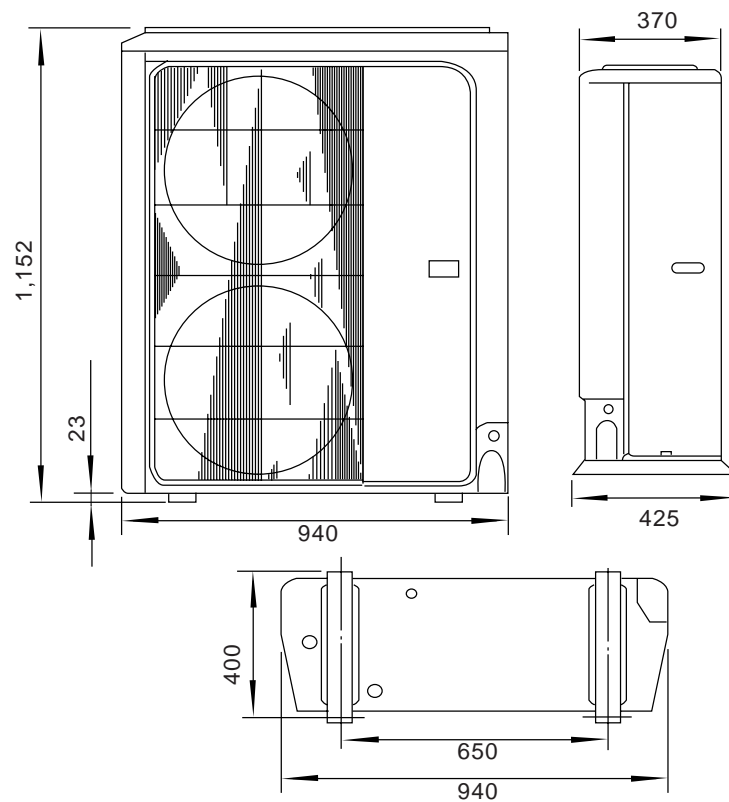

2.3 REMOTE CONTROLLER

WIRE REMOTE CONTROLLER WITH WEEKLY TIMER

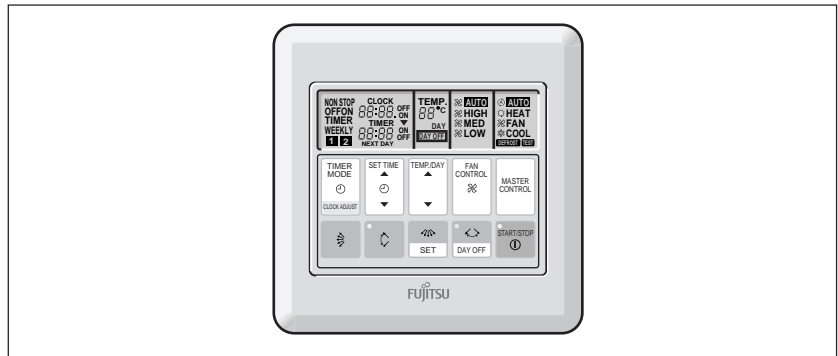

FEATURES

Three kinds of timer setup (OFF/ON/WEEKLY) are possible.

Function of weekly timer

Setting of different on-off time by day.

Setting of set on-off time twice a day.

Setting of time in 5 minute steps.

Timer operation of a reserved day can be temporarily cancelled by pushing the "DAY OFF" button.

Time setting can be left until the next day.

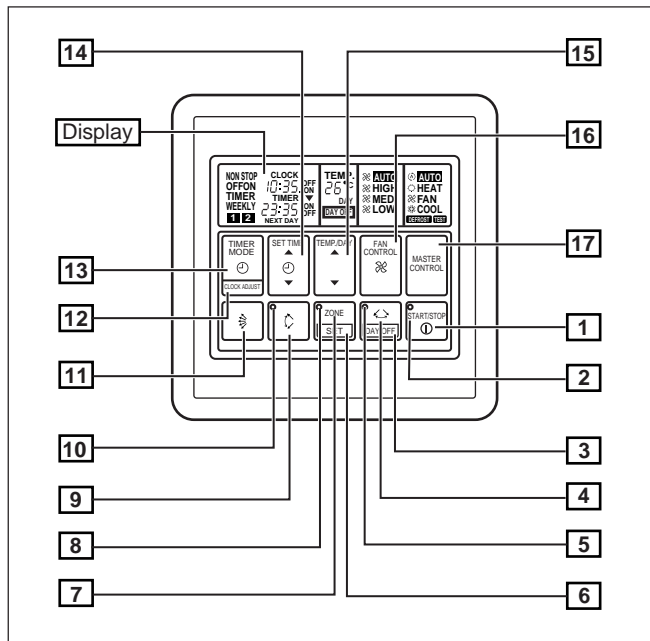

Display panel

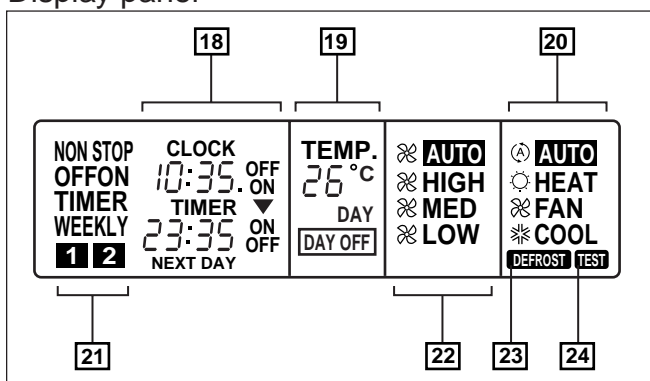

- 1 START/STOP Button
Pressed to start and stop operation.
- 2 OPERATION Lamp
Lights during operation and when the timer is on.
- 3 DAY OFF Button
Temporary cancellation of one day timer.
- 4 ENERGY SAVE Button
Turns energy efficient mode on and off.
- 5 ENERGY SAVE Button
Lights up when the unit is in the energy save mode.
- 6 SET Button
Sets the date, hour minute and on-off time.
- 7 ZONE Button
Use to turn the zone control on and off.
- 8 ZONE Lamp
Lights up when the units is in the zone control mode.
- 9 VERTICAL SWING Button
- 10 VERTICAL SWING Lamp
- 11 VERTICAL AIR FLOW DIRECTION Button
- 12 CLOCK ADJUST Button
- 13 TIMER MODE Button
Changes the timer mode (NON STOP, OFF TIMER, ON TIMER, WEEKLY TIMER).
- 14 SET TIME Button
Sets the current time and on-off time.
- 15 TEMP./DAY Button
Sets the indoor temperature / days.
- 16 FAN CONTROL Button
Selects the fan speed (AUTO, HIGH, MED, LOW).
- 17 MASTER CONTROL Button
Selects the operating mode (AUTO, HEAT, FAN, COOL).
- 18 Clock Display
- 19 Set Temperature / Day Display (TEMP./DAY)
- 20 Operation Mode Display
- 21 Timer Mode Display
- 22 Fan Speed Display
- 23 DEFROST Display
- 24 TEST Display

3. DATA

3.1 PERFORMANCE CURVE

AUY30A

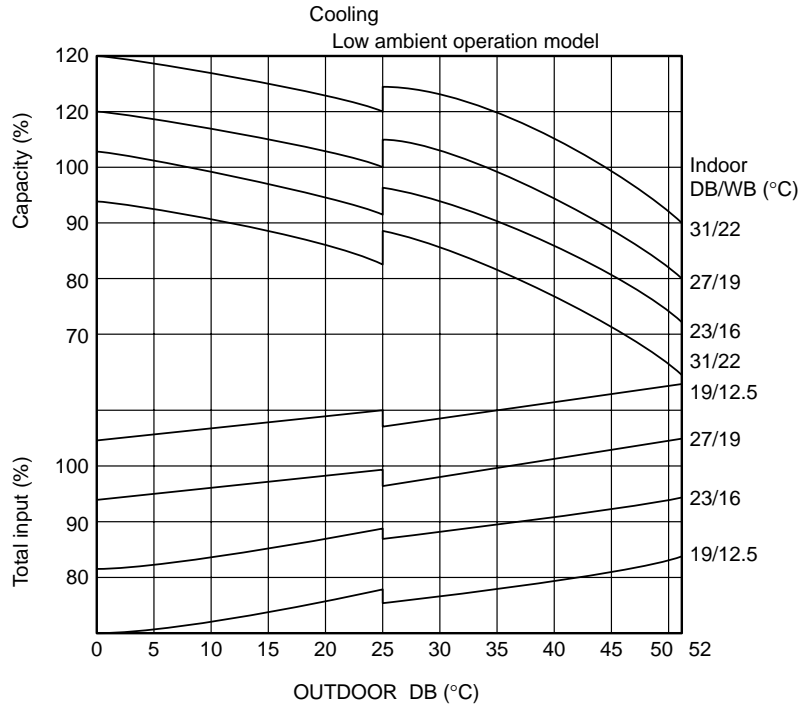

AUY30R

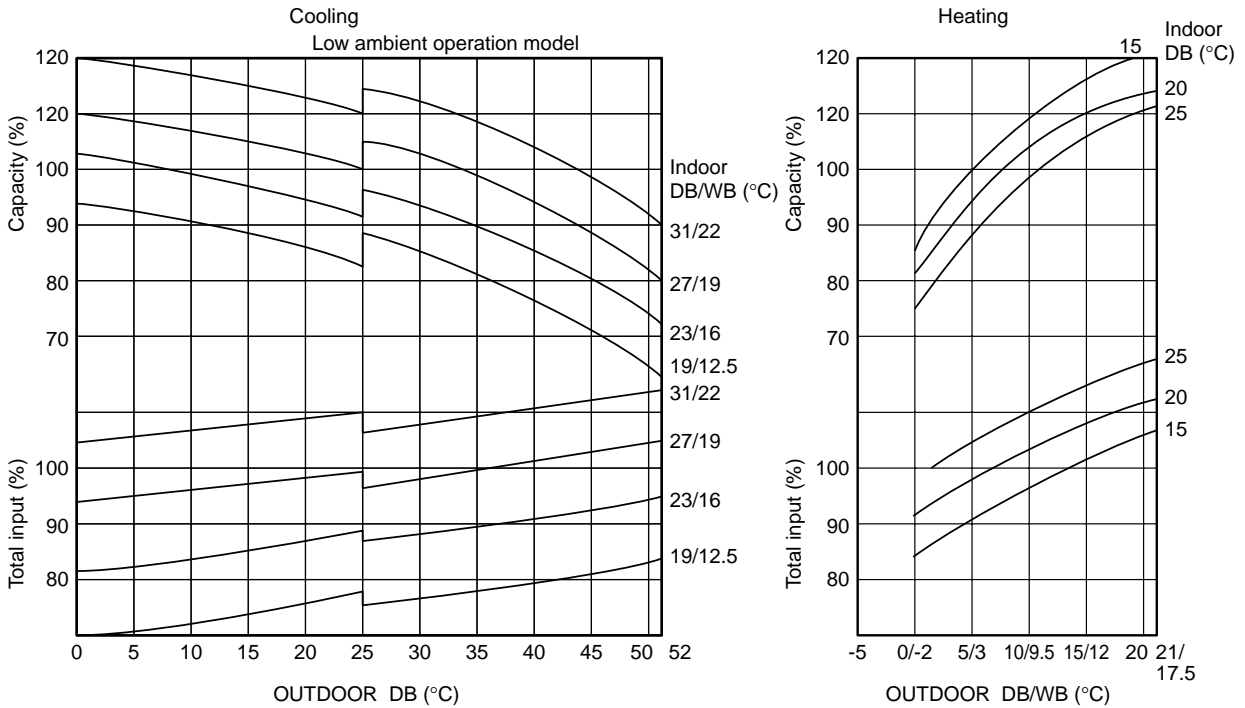

AUY36A, AUY45A, AUY54A

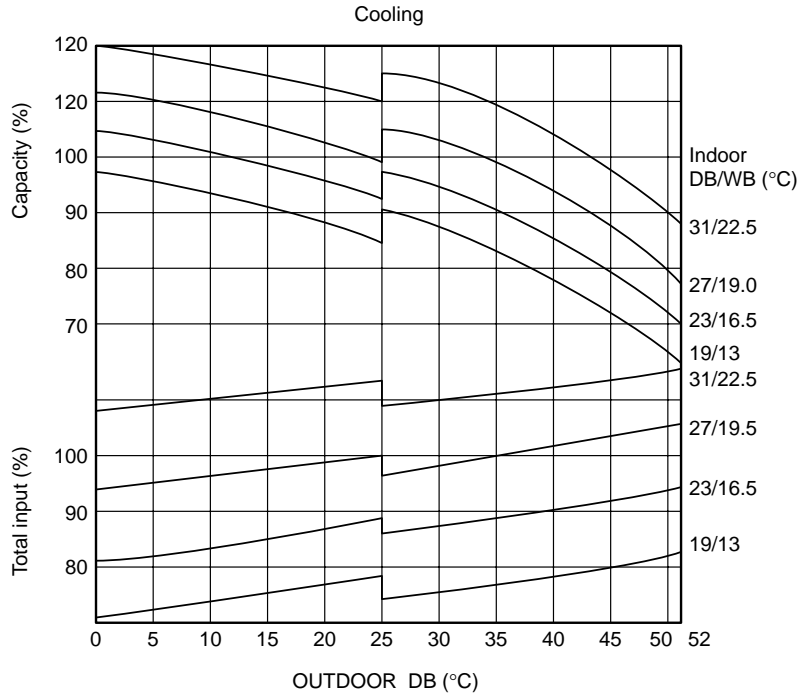

AUY36R, AUY45R, AUY54R

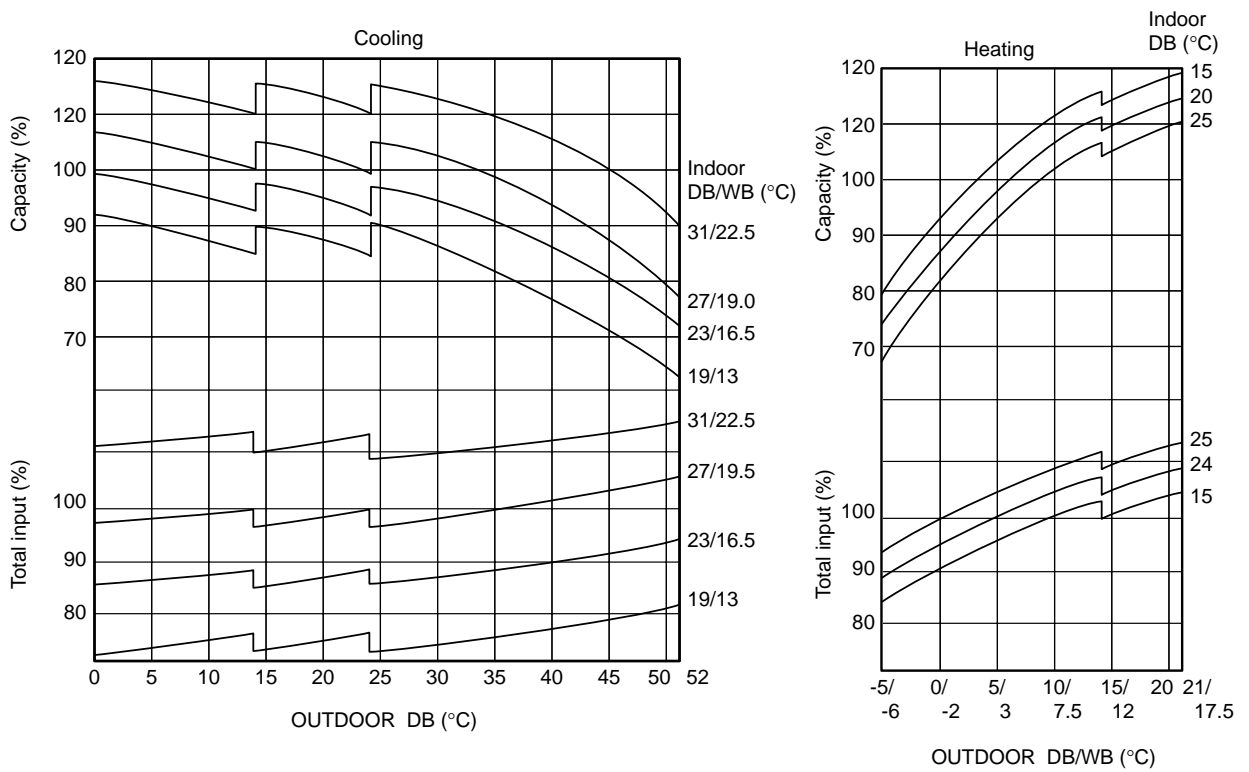

3.2 TEMPERATURE RANGE

MODEL		Temperature Range	
		Indoor Unit	Outdoor Unit
AUY30A AUY36A AUY45A AUY54A	COOL	18°C to 32°C	0°C to 52°C
AUY30R	COOL	18°C to 32°C	0°C to 52°C
	HEAT	30°C or less	-5°C to 21°C
AUY36R AUY45R AUY54R	COOL	18°C to 32°C	0°C to 52°C
	HEAT	30°C or less	-8°C to 21°C

3.3 ADDITIONAL REFRIGERANT CHARGE

PIPE LENGTH		5m (16ft)	10m (33ft)	20m (66ft)	25m (82ft)	30m (99ft)	40m (132ft)	50m (164ft)	Additional refrigerant
FULL CHARGE AMOUNT	AUY30A	2,350g(82.9oz)	2,435g(85.9oz)	2,605g(91.9oz)	2,690g(94.9oz)	2,775g(97.9oz)	—	—	17g/m (0.6 oz)
	AUY30R	2,850g(100.5oz)	3,100g(109.3oz)	3,600g(127oz)	3,850g(135.8oz)	4,100g(144.6oz)	—	—	50g/m (1.76 oz)
	AUY36A	2,300g(81.1oz)			2,500g(88.2oz)	2,700g(95.2oz)	3,100g(109.3oz)	3,500g(123.5oz)	40g/m (1.41oz/3.3ft)
	AUY36R	3,000g(10.6oz)			3,200g(112.9oz)	3,400g(119.9oz)	3,800g(134.0oz)	4,200g(148.2oz)	
	AUY45A	3,500g(123.5oz)			3,700g(130.5oz)	3,900g(137.6oz)	4,300g(151.7oz)	4,700g(165.8oz)	
	AUY45R	3,500g(123.5oz)			3,700g(130.5oz)	3,900g(137.6oz)	4,300g(151.7oz)	4,700g(165.8oz)	
	AUY54A	4,000g(141.1oz)			4,250g(149.9oz)	4,500g(158.7oz)	5,000g(176.4oz)	5,500g(194.0oz)	50g/m (1.76oz/3.3ft)
	AUY54R	3,500g(123.5oz)			3,750g(132.3oz)	4,000g(141.1oz)	4,500g(158.7oz)	5,000g(176.4oz)	

AUY30A, AUY30R

Pipe size : Liquid 9.52 mm (3/8") Gas 15.88 mm (5/8")

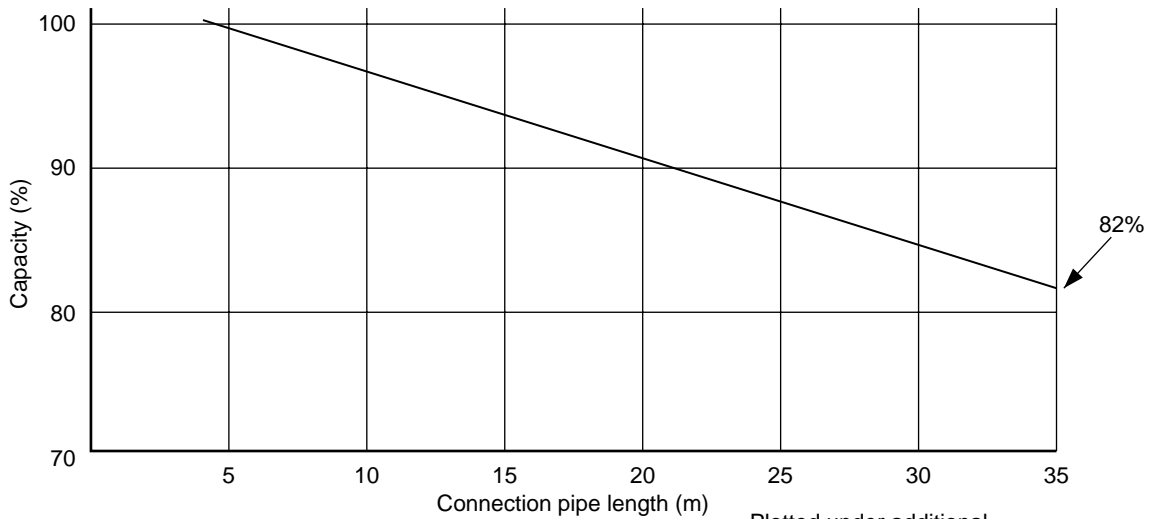

Plotted under additional refrigerant charge conditions.

AUY36A, AUY45A, AUY54A AUY36R, AUY45R, AUY54R

Pipe size : Liquid 9.52 mm (3/8") Gas 19.05 mm (3/4")

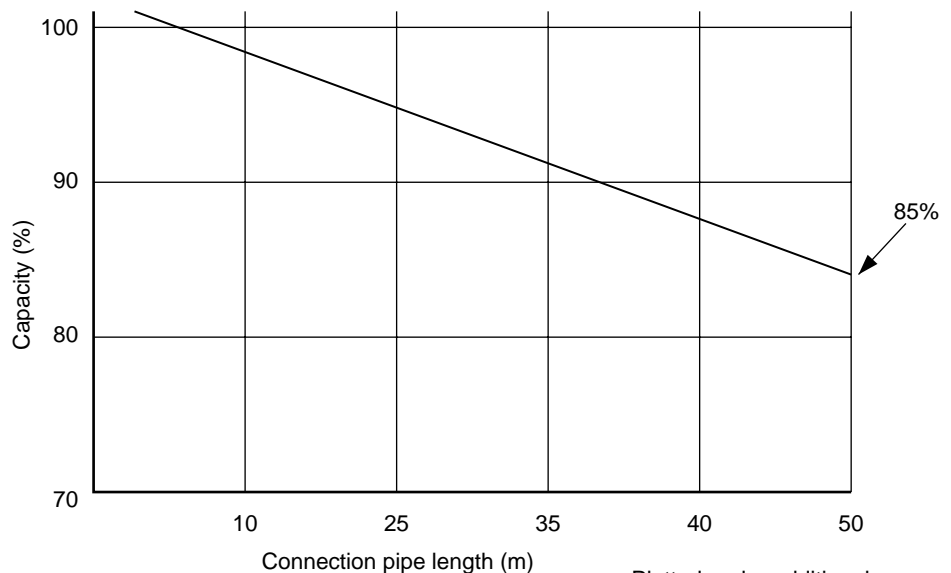

Plotted under additional refrigerant charge conditions.

3.4 AIR VELOCITY DISTRIBUTION

AUY30A, AUY30R

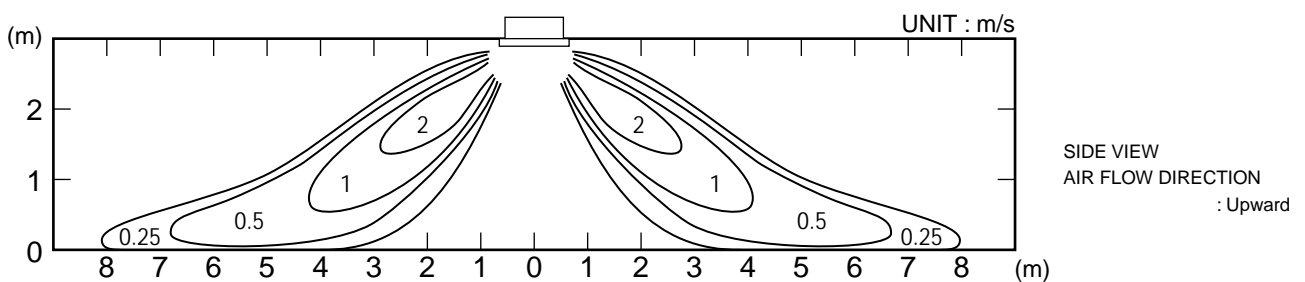
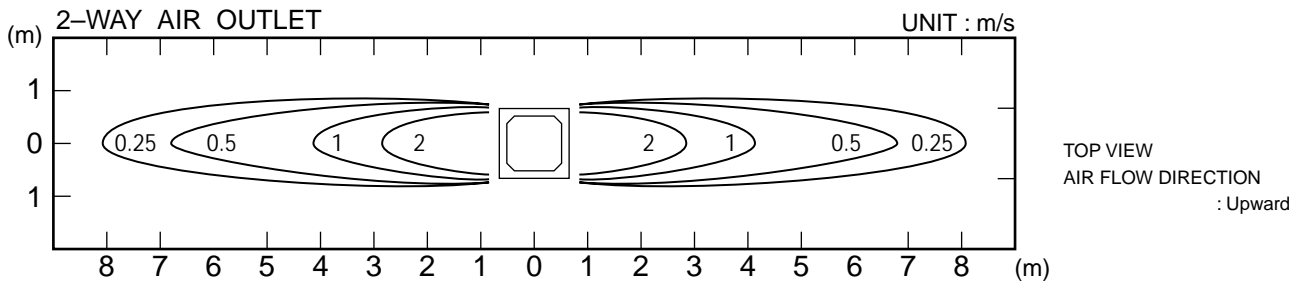
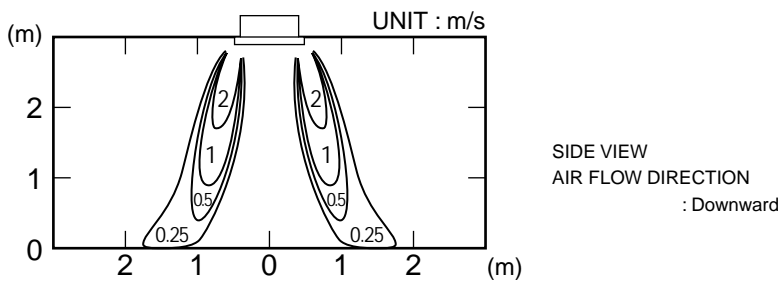
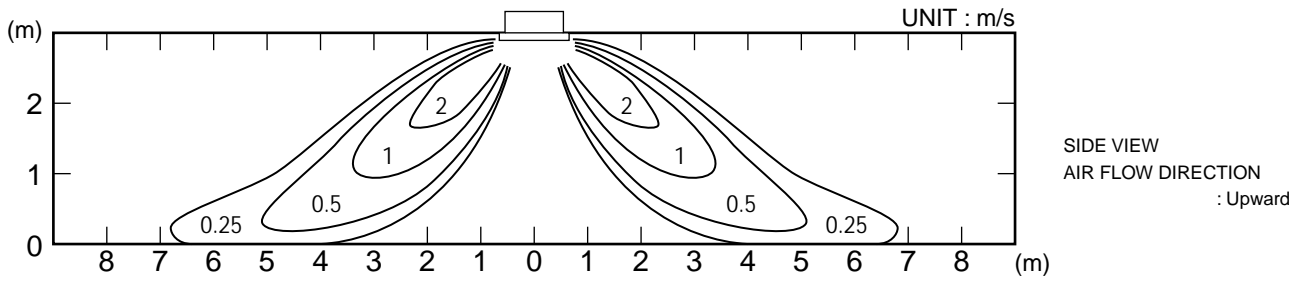
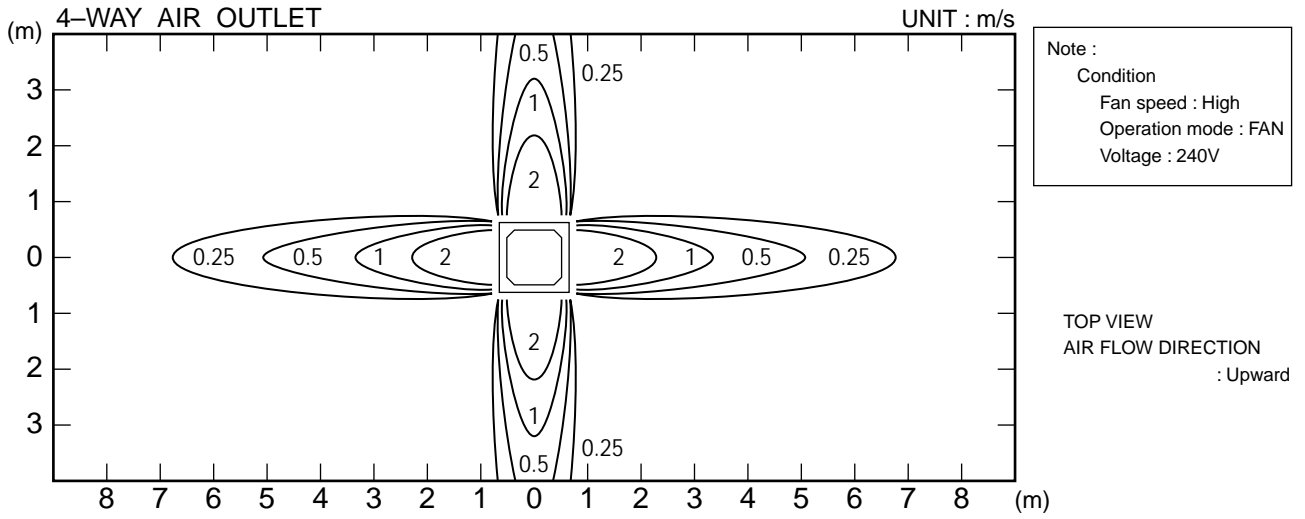

AUY36A, AUY36R

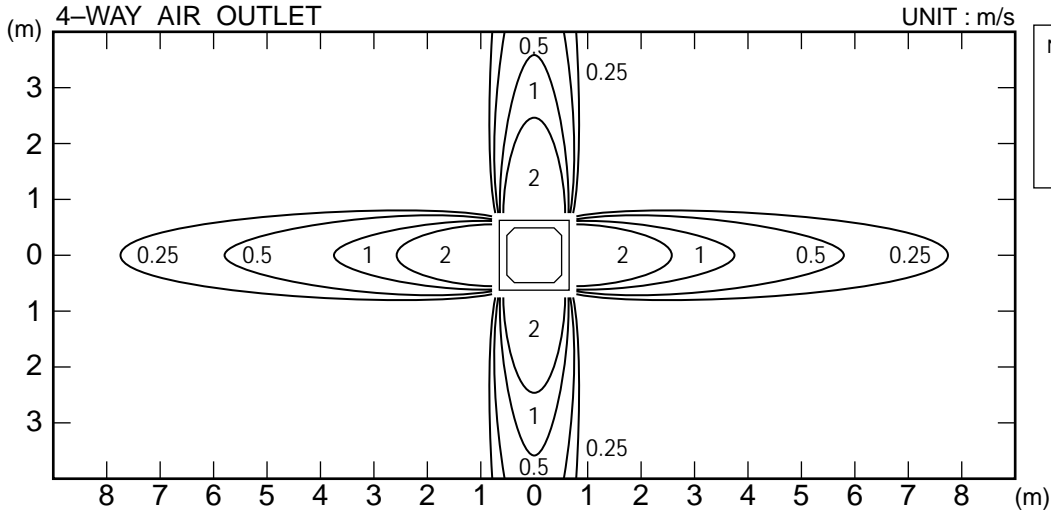

Note :
 Condition
 Fan speed : High
 Operation mode : FAN
 Voltage : 240V
 (415)

TOP VIEW
 AIR FLOW DIRECTION
 : Upward

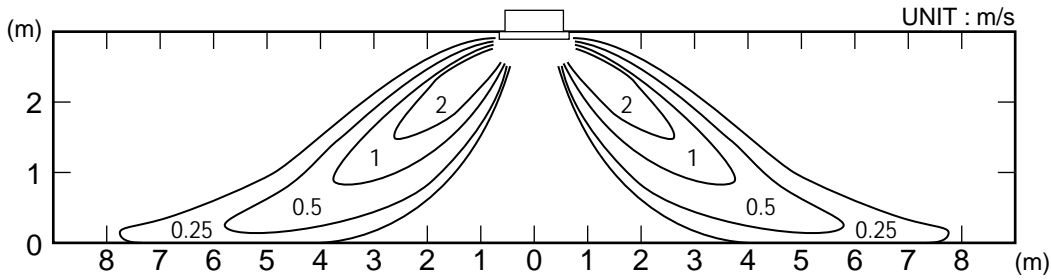

SIDE VIEW
 AIR FLOW DIRECTION
 : Upward

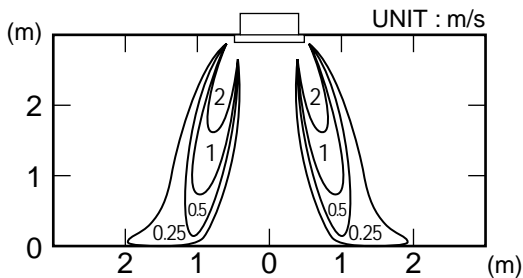

SIDE VIEW
 AIR FLOW DIRECTION
 : Downward

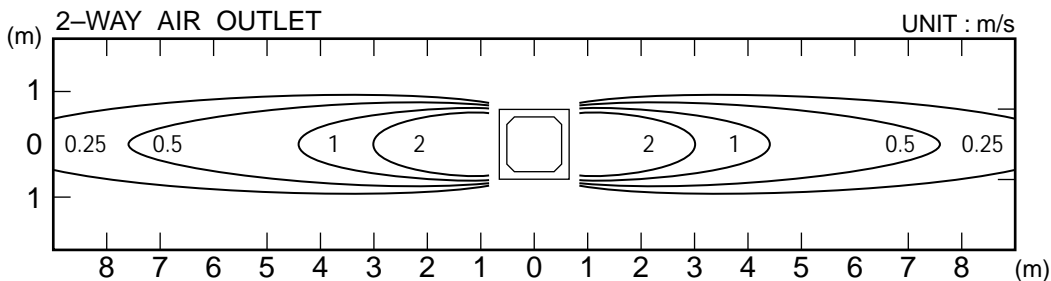

TOP VIEW
 AIR FLOW DIRECTION
 : Upward

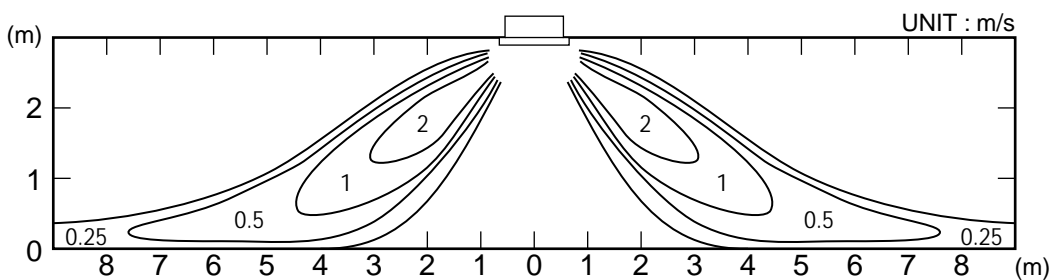

SIDE VIEW
 AIR FLOW DIRECTION
 : Upward

AUY45A, AUY45R

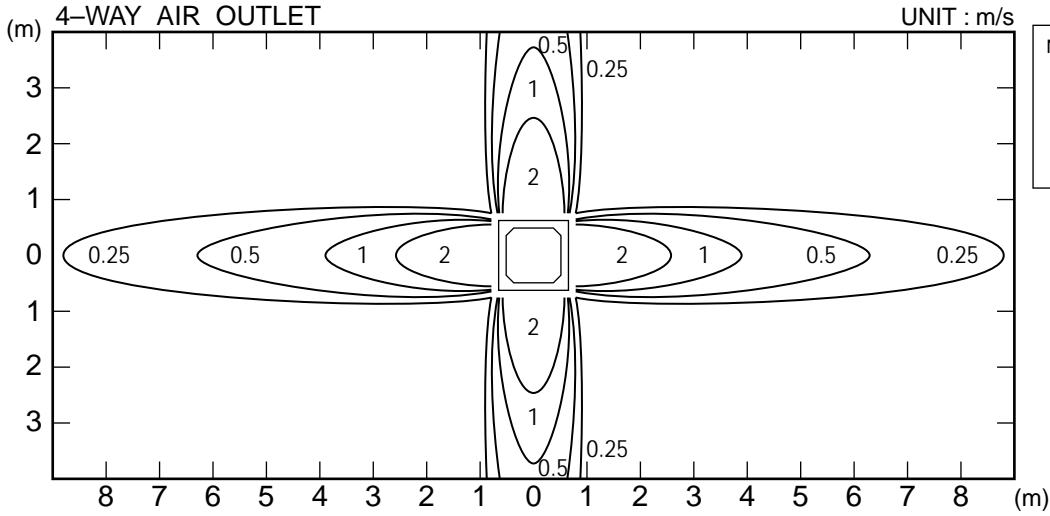

Note :
 Condition
 Fan speed : High
 Operation mode : FAN
 Voltage : 240V
 (415)

TOP VIEW
 AIR FLOW DIRECTION : Upward

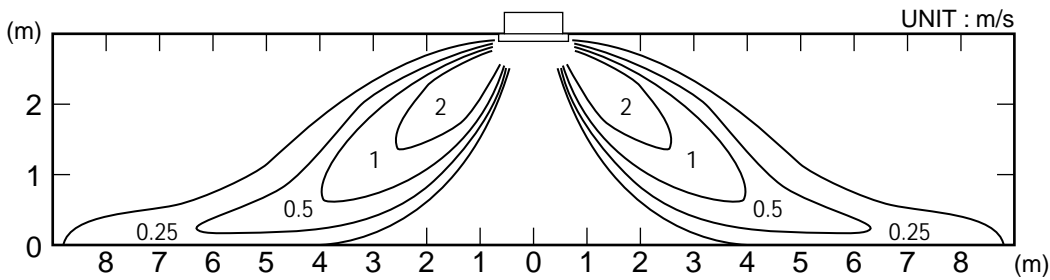

SIDE VIEW
 AIR FLOW DIRECTION : Upward

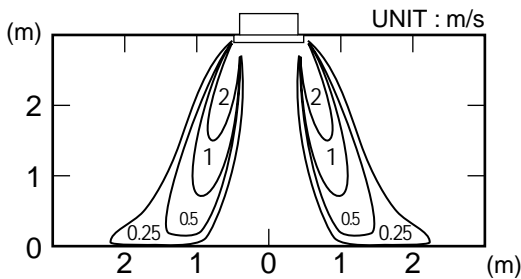

SIDE VIEW
 AIR FLOW DIRECTION : Downward

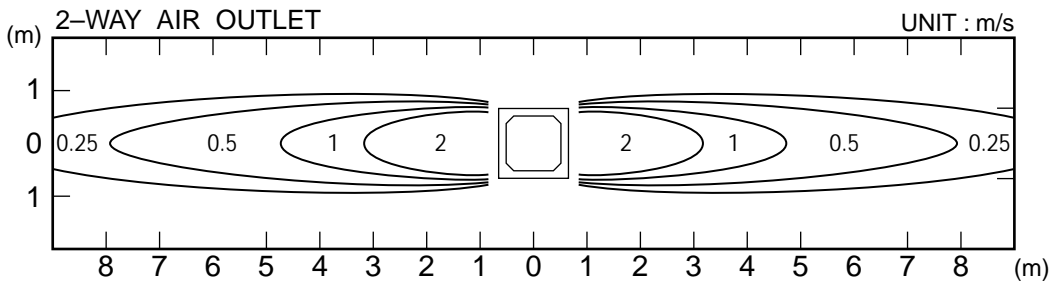

TOP VIEW
 AIR FLOW DIRECTION : Upward

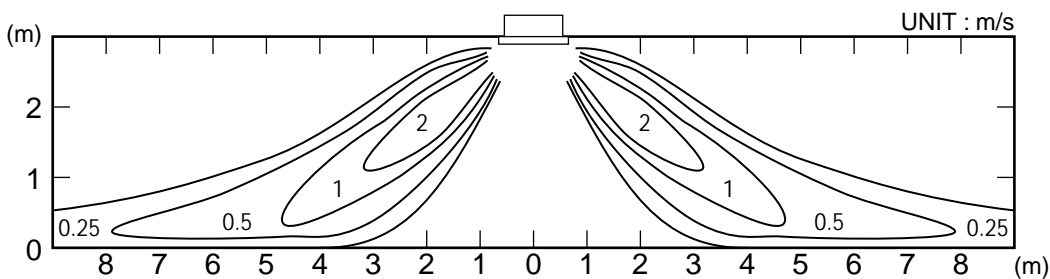

SIDE VIEW
 AIR FLOW DIRECTION : Upward

AUY54A, AUY54R

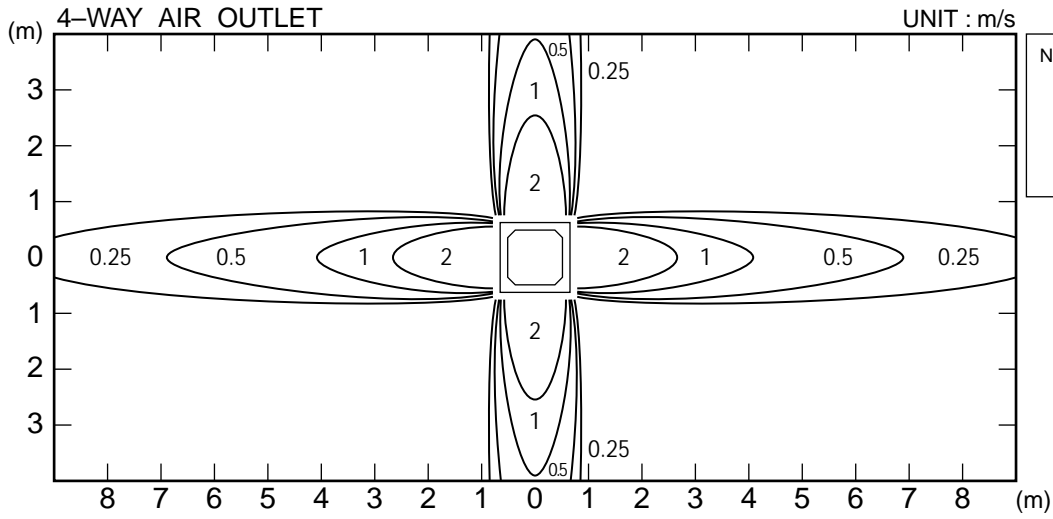

Note :
 Condition
 Fan speed : High
 Operation mode : FAN
 Voltage : 240V
 (415)

TOP VIEW
 AIR FLOW DIRECTION : Upward

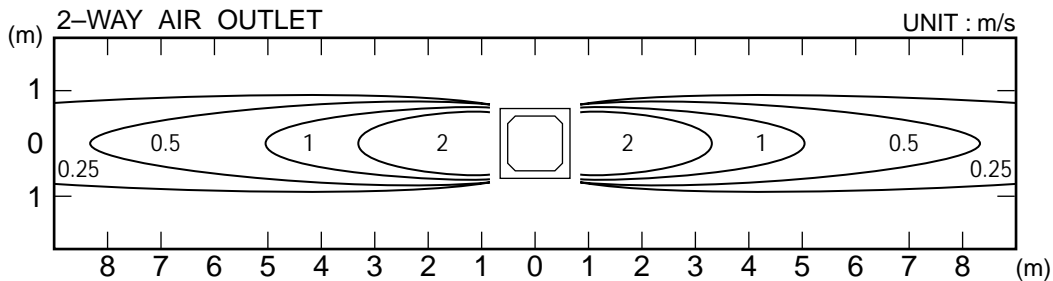
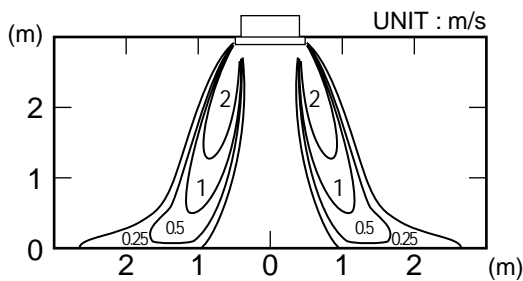
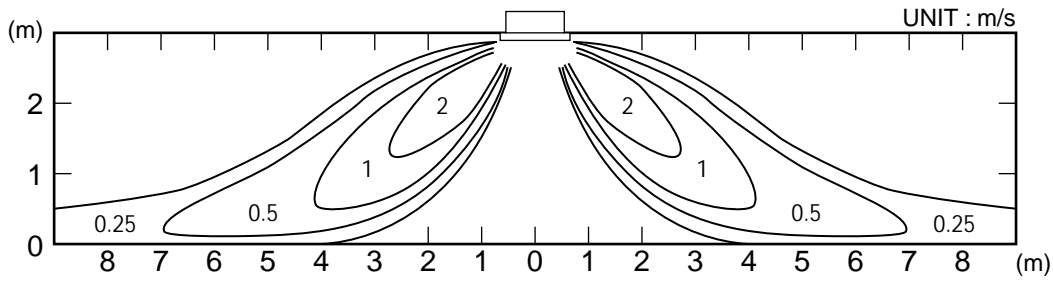

TOP VIEW
 AIR FLOW DIRECTION : Upward

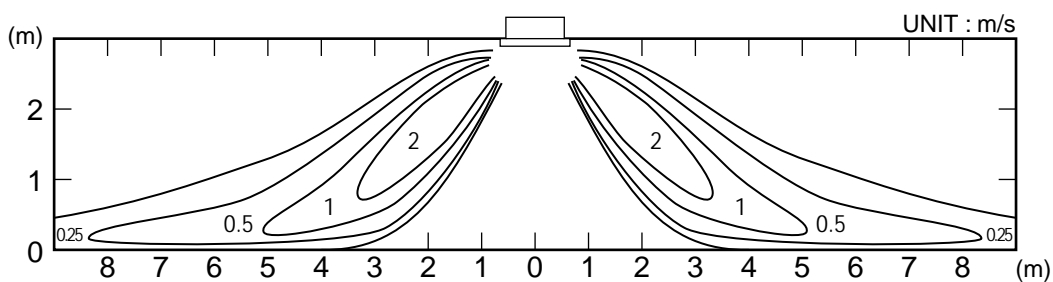

3.5 DUCT CONNECTION

OUTLET AIR

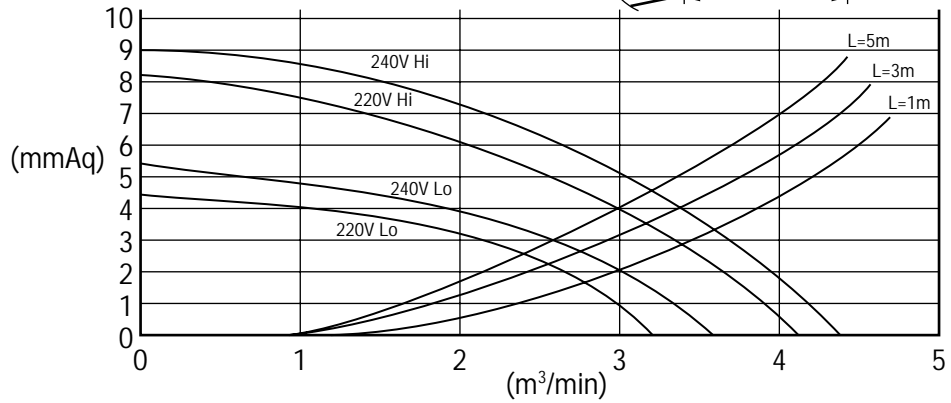
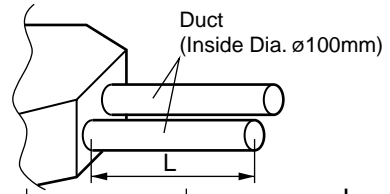
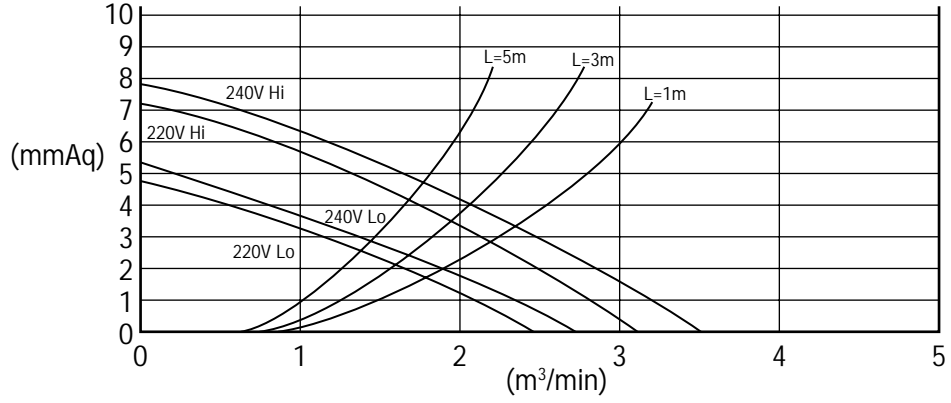
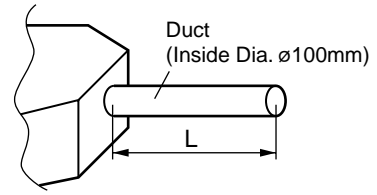

FRESH AIR

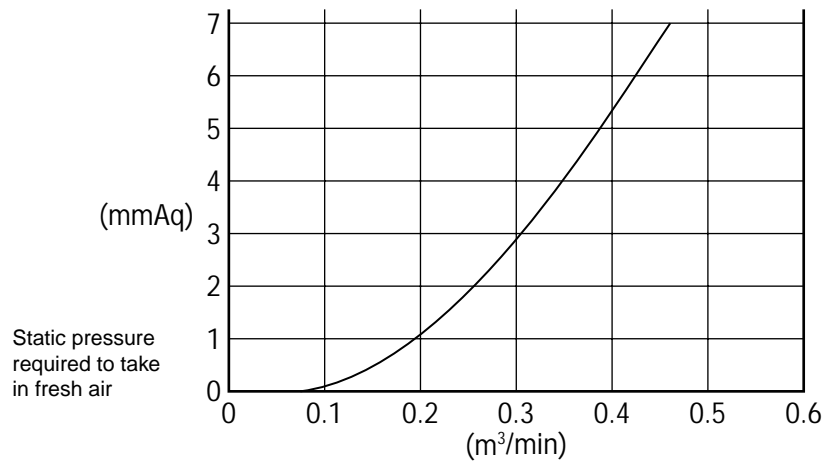
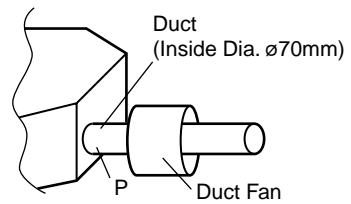

3.6 REFRIGERANT SYSTEM DIAGRAM

Models : AUY30A / AOY30A

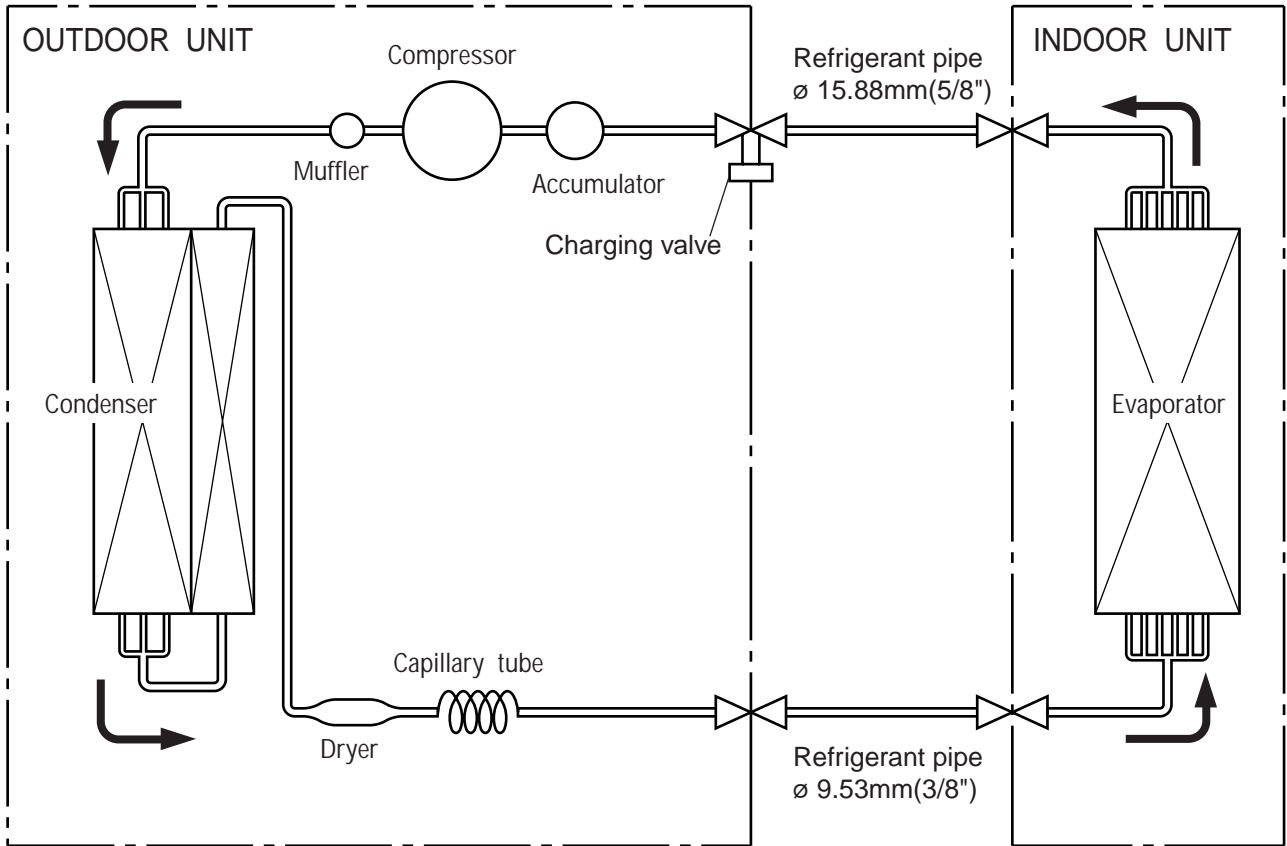

Models : AUY30R / AOY30R

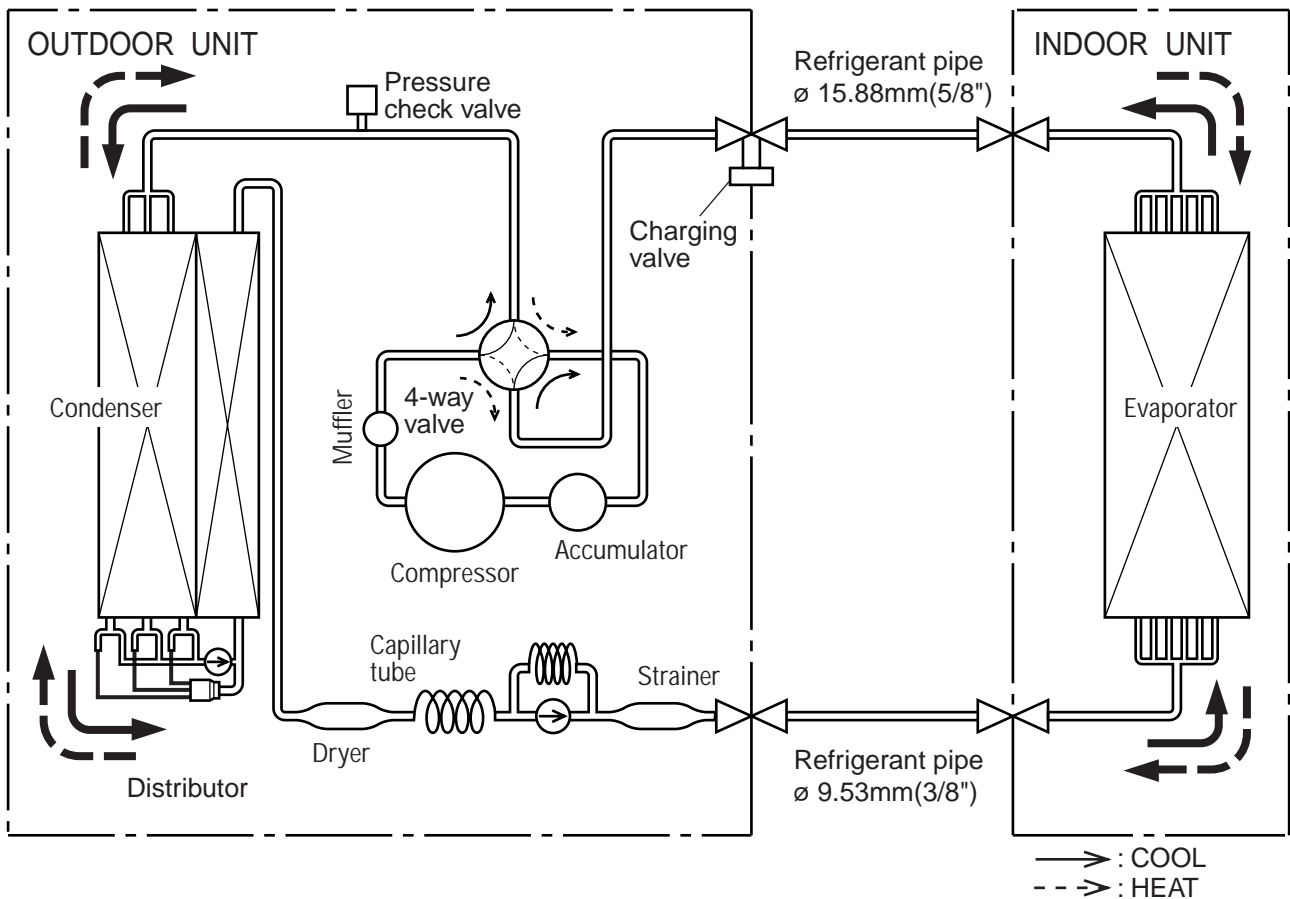

Models : AUY36A / AOY36A

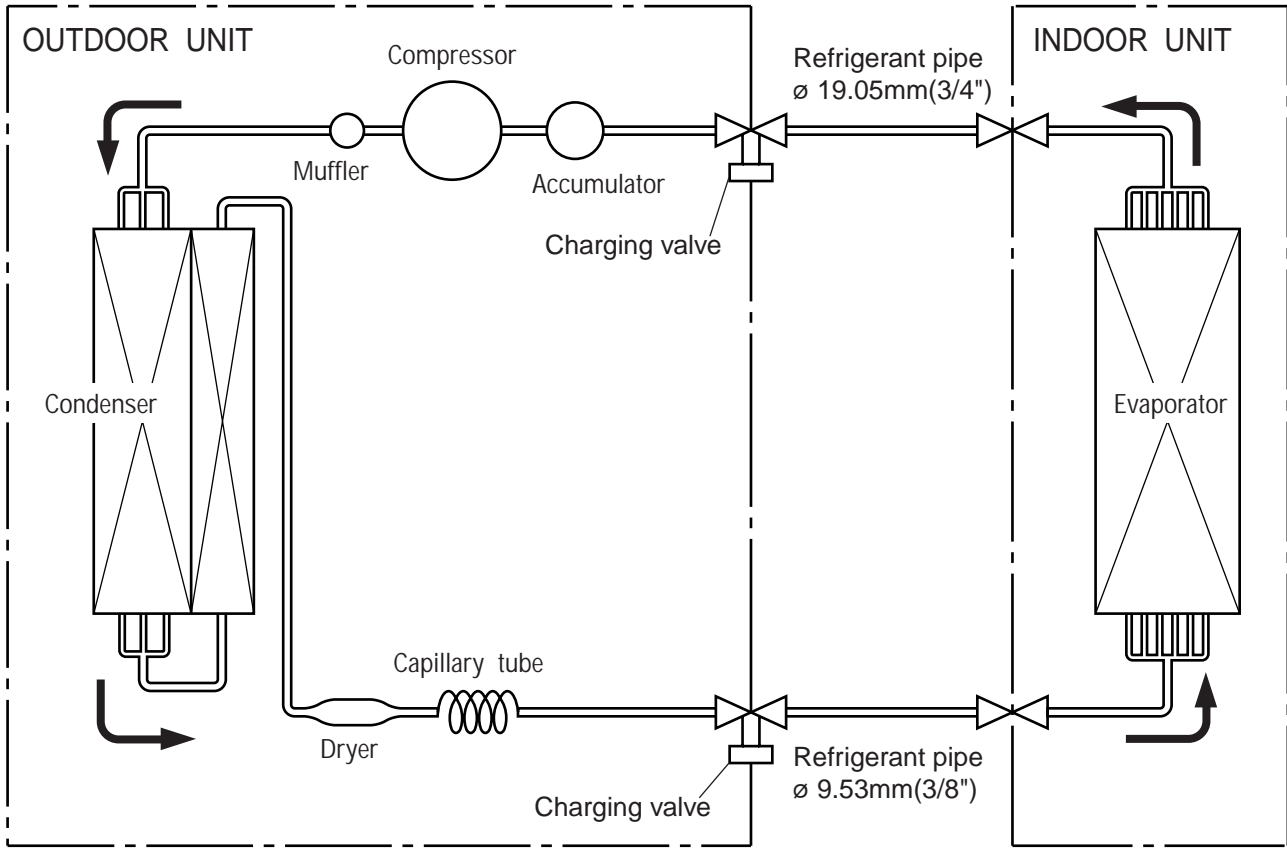

Models : AUY36R / AOY36R

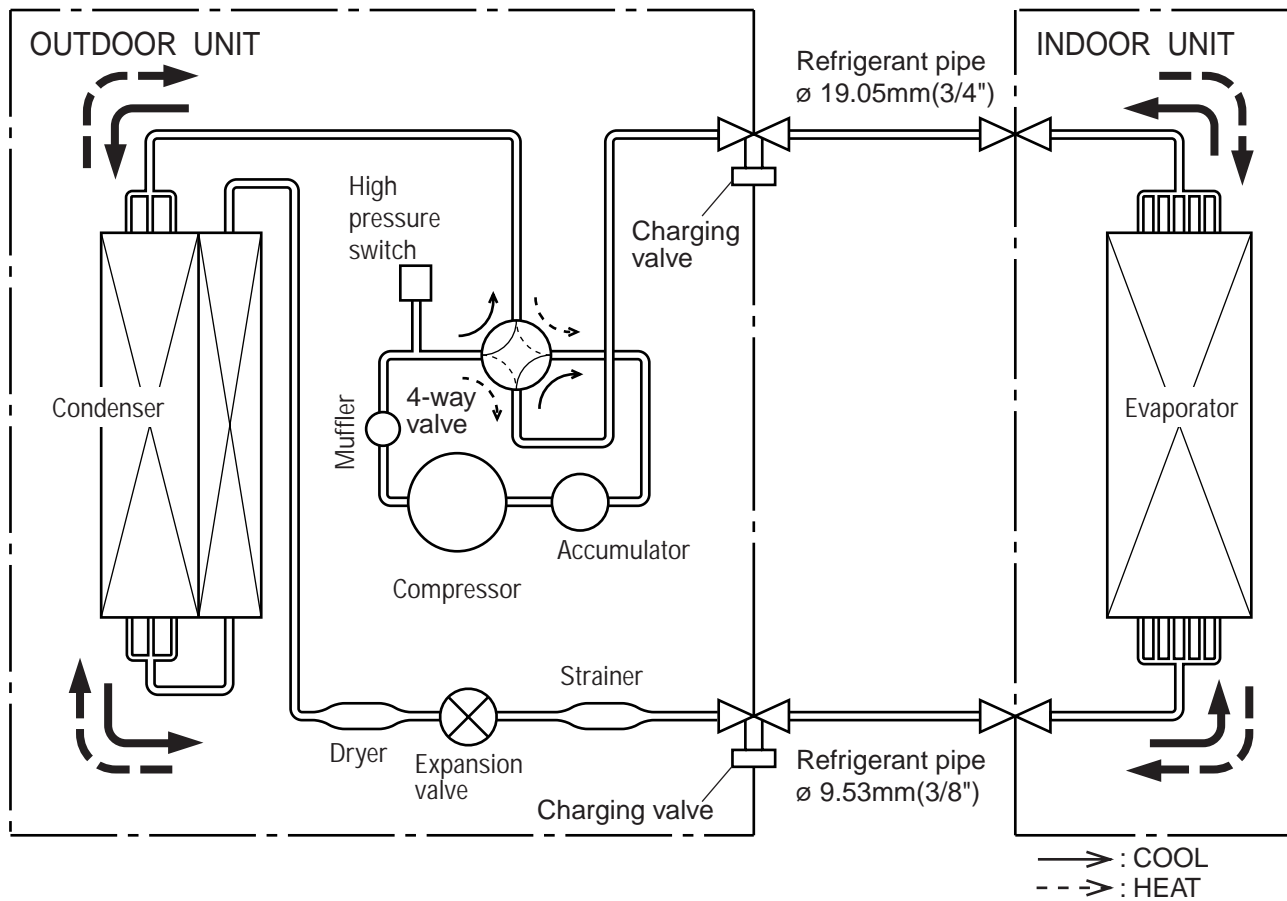

Models : AUY45A / AOY45A
 AUY54A / AOY54A

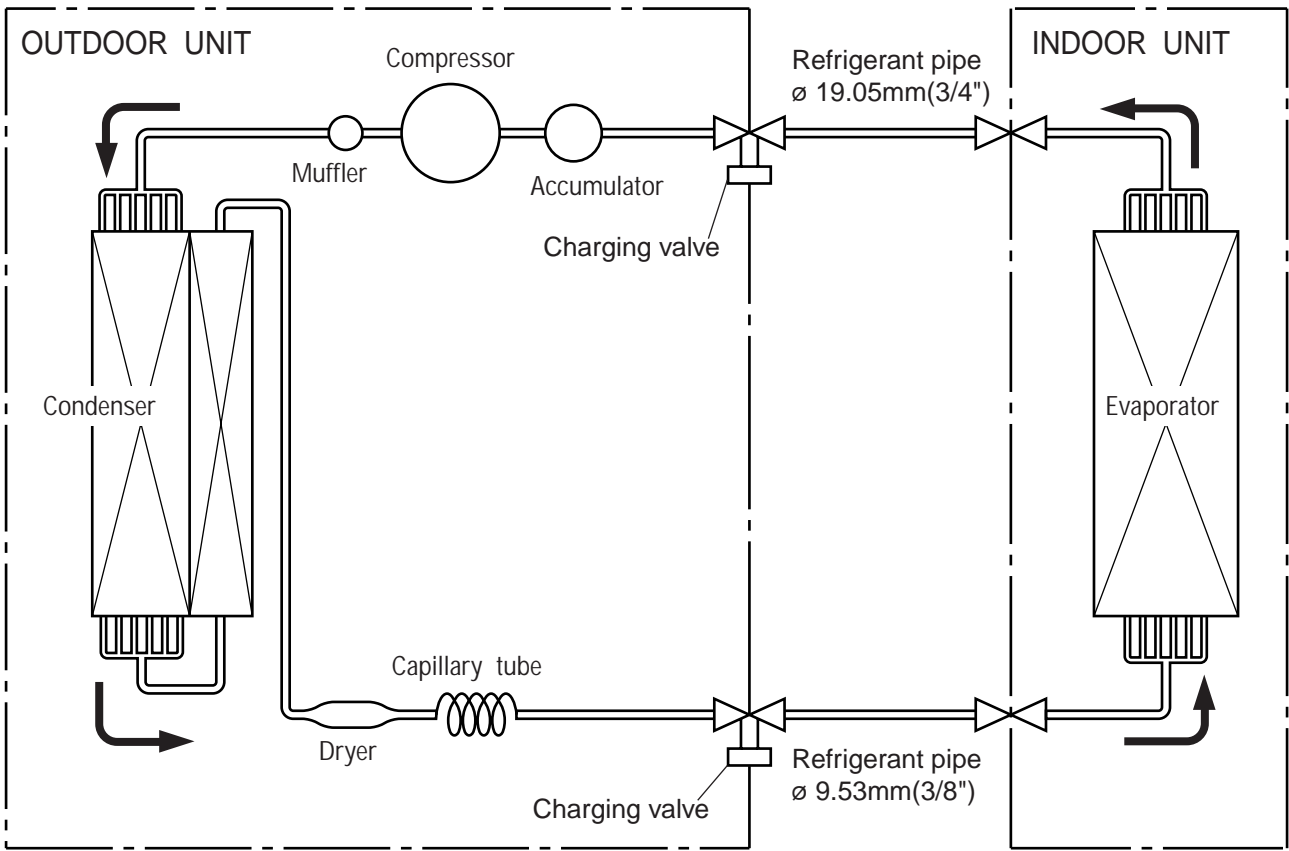

Models : AUY45R / AOY45R
 AUY54R / AOY54R

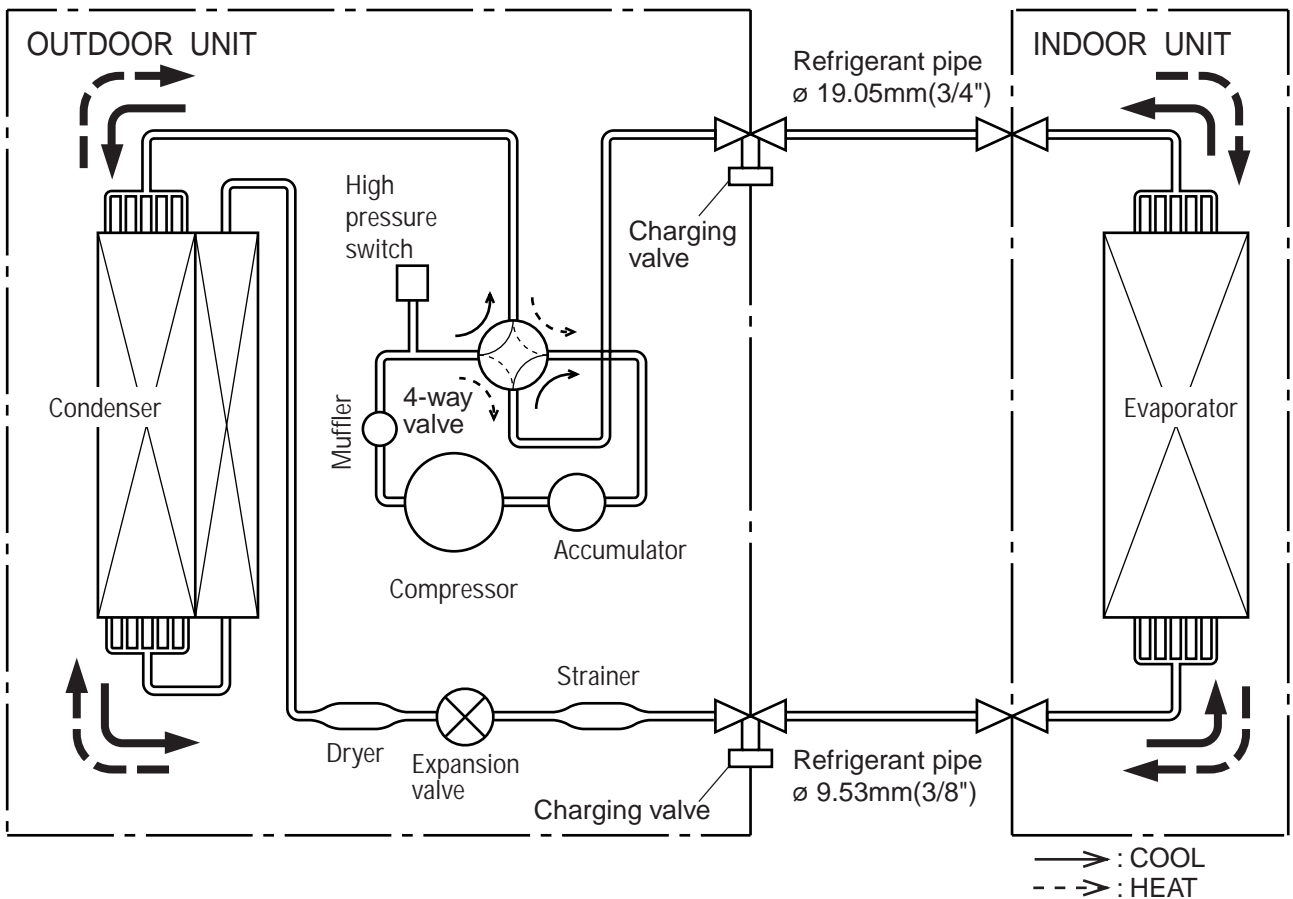

3.7 NOISE LEVEL CHECK POINTS

INDOOR UNIT

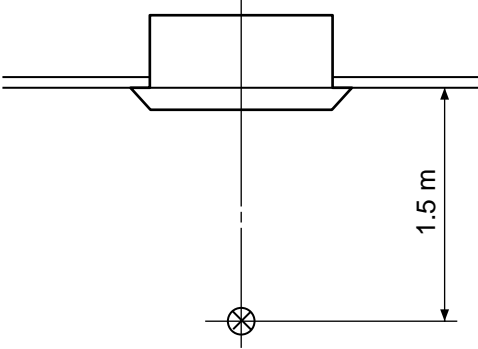

OUTDOOR UNIT

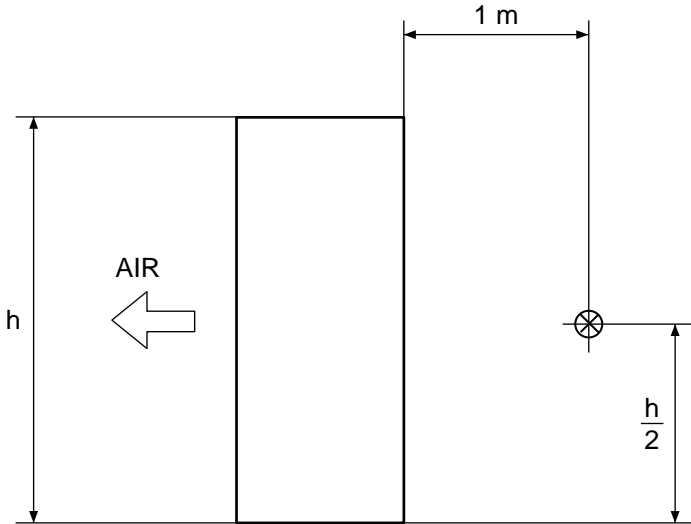

AUY30A, AUY30R

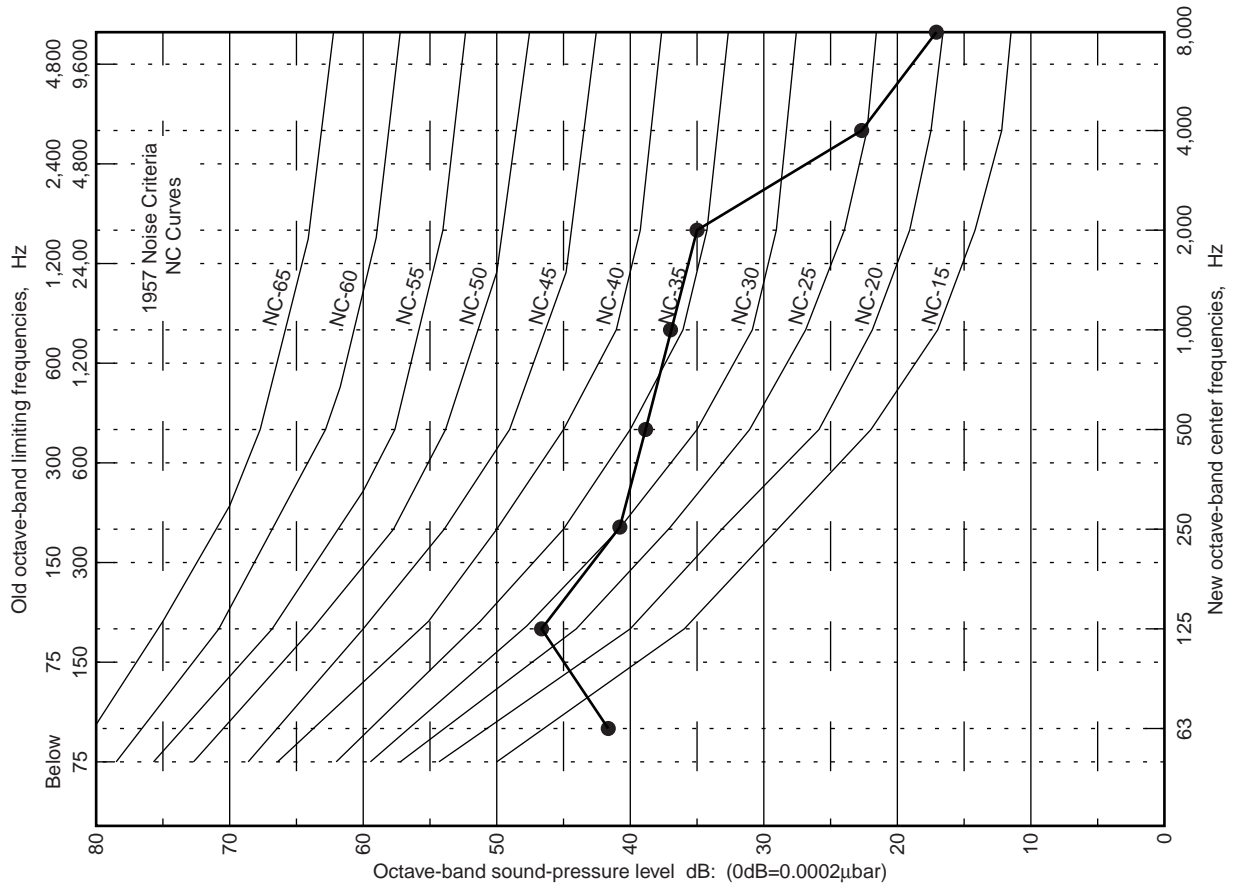

AUY36A, AUY36R

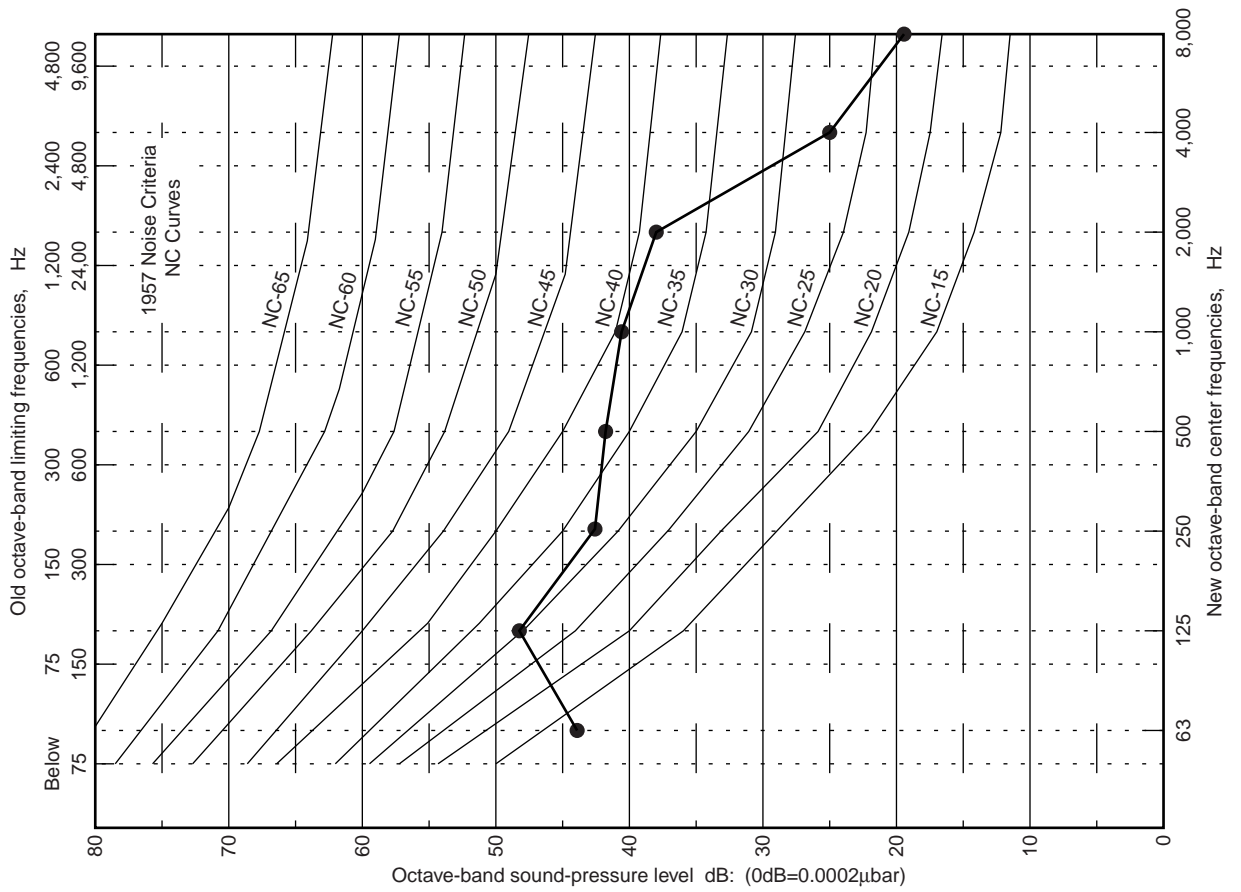

AUY45A, AUY45R

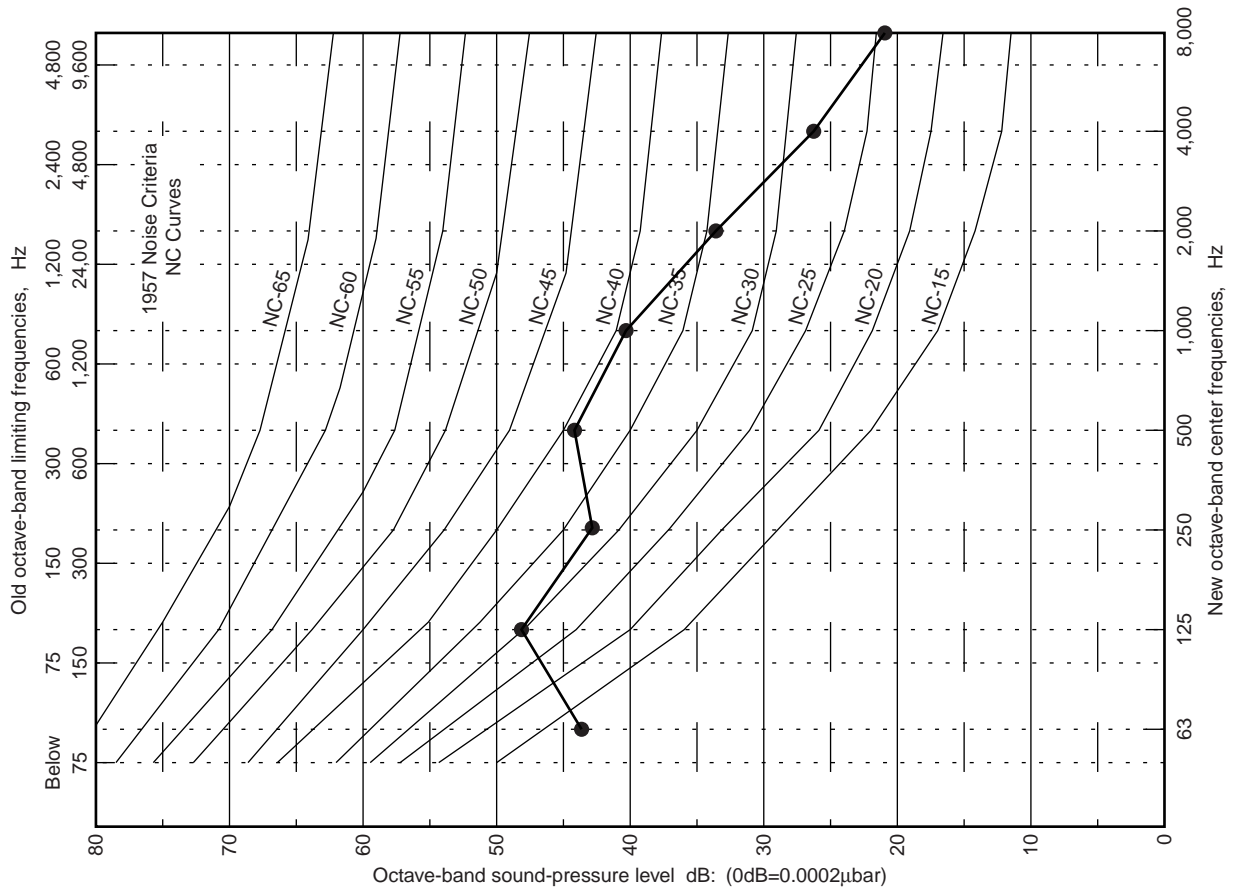

AUY54A, AUY54R

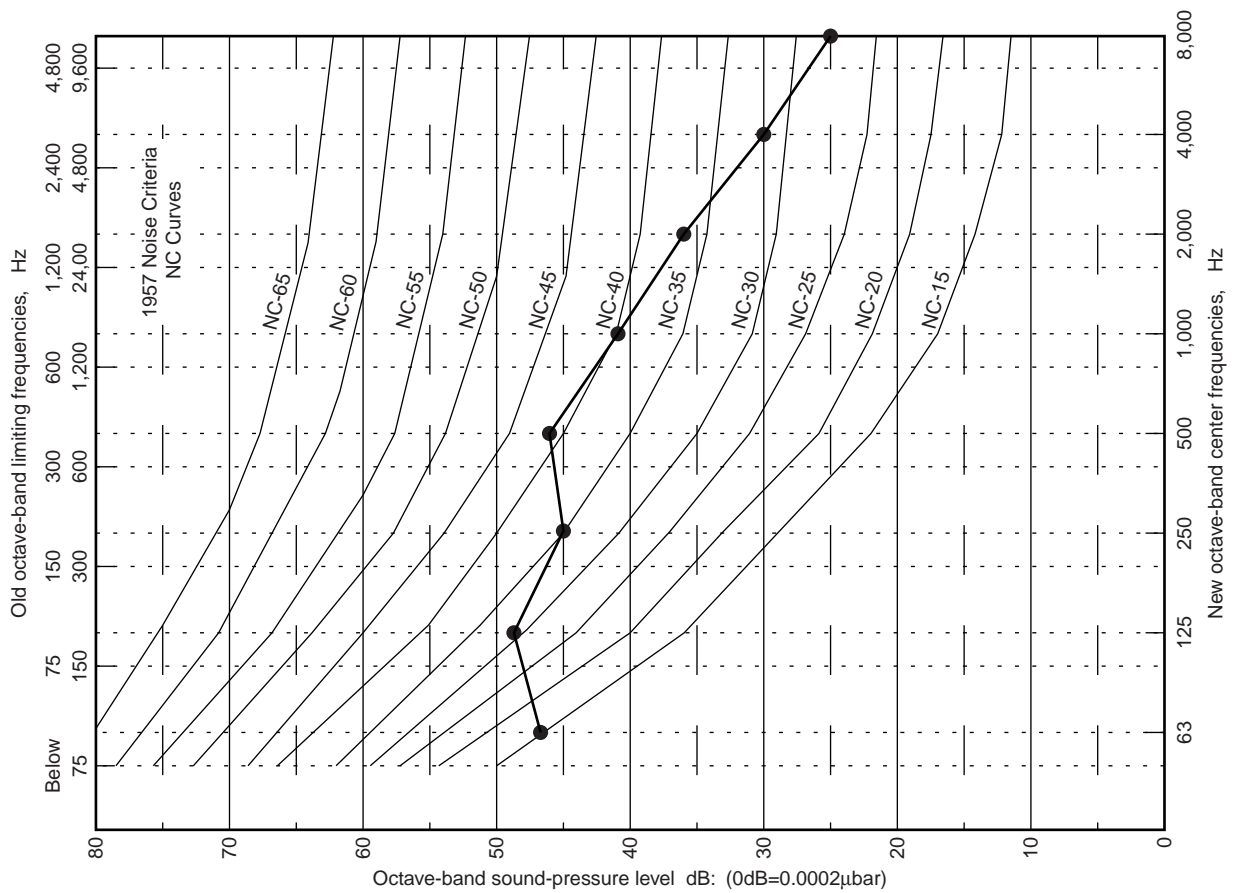

AOY30A, AOY30R

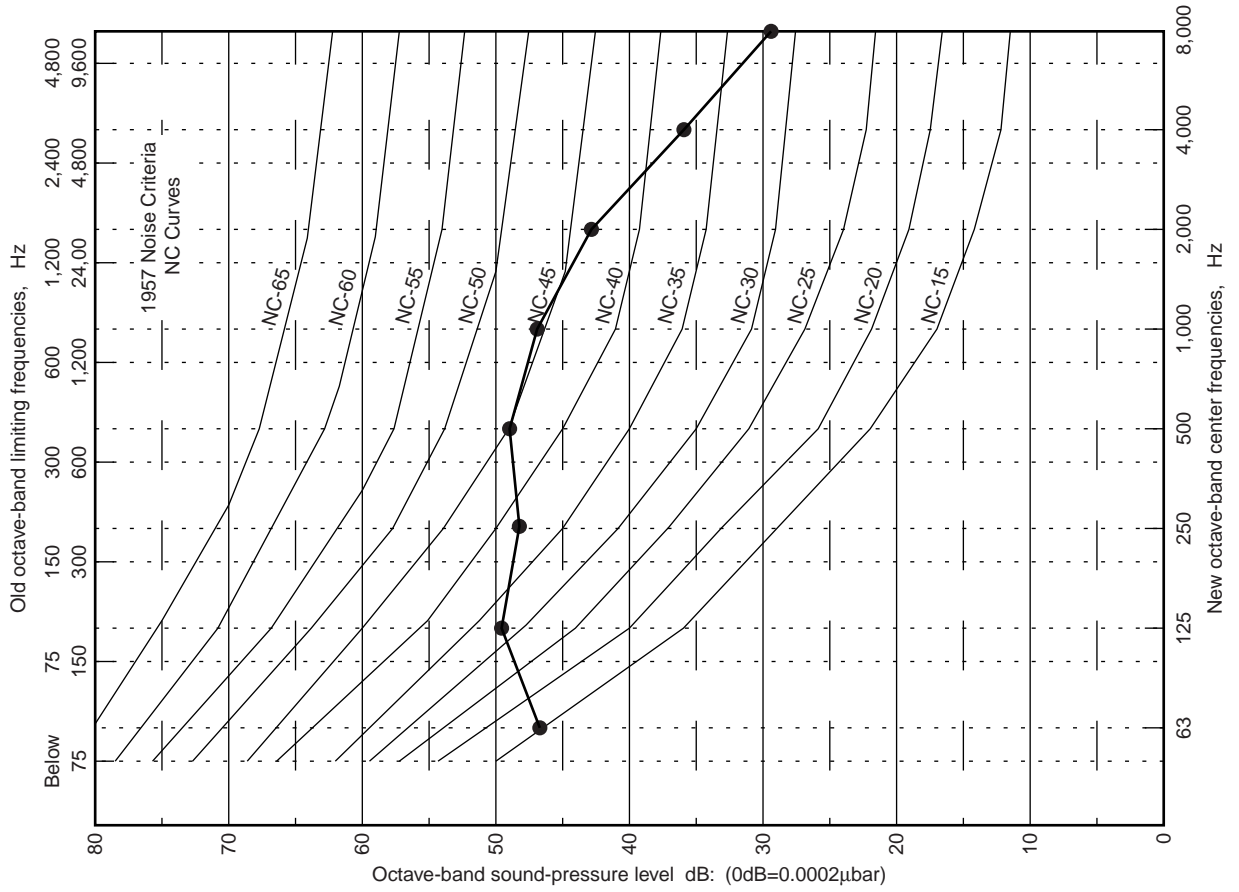

AOY36A, AOY36R

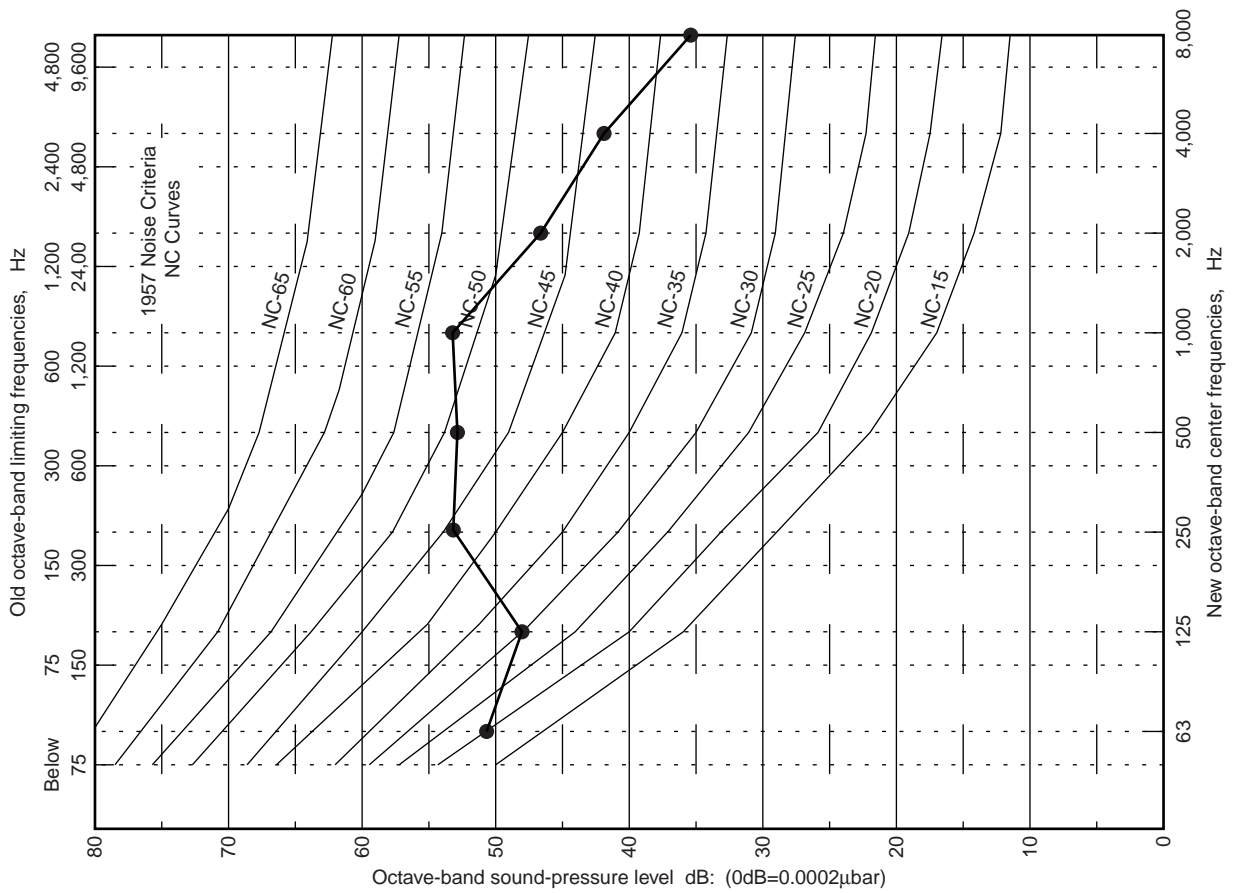

AOY45A, AOY45R

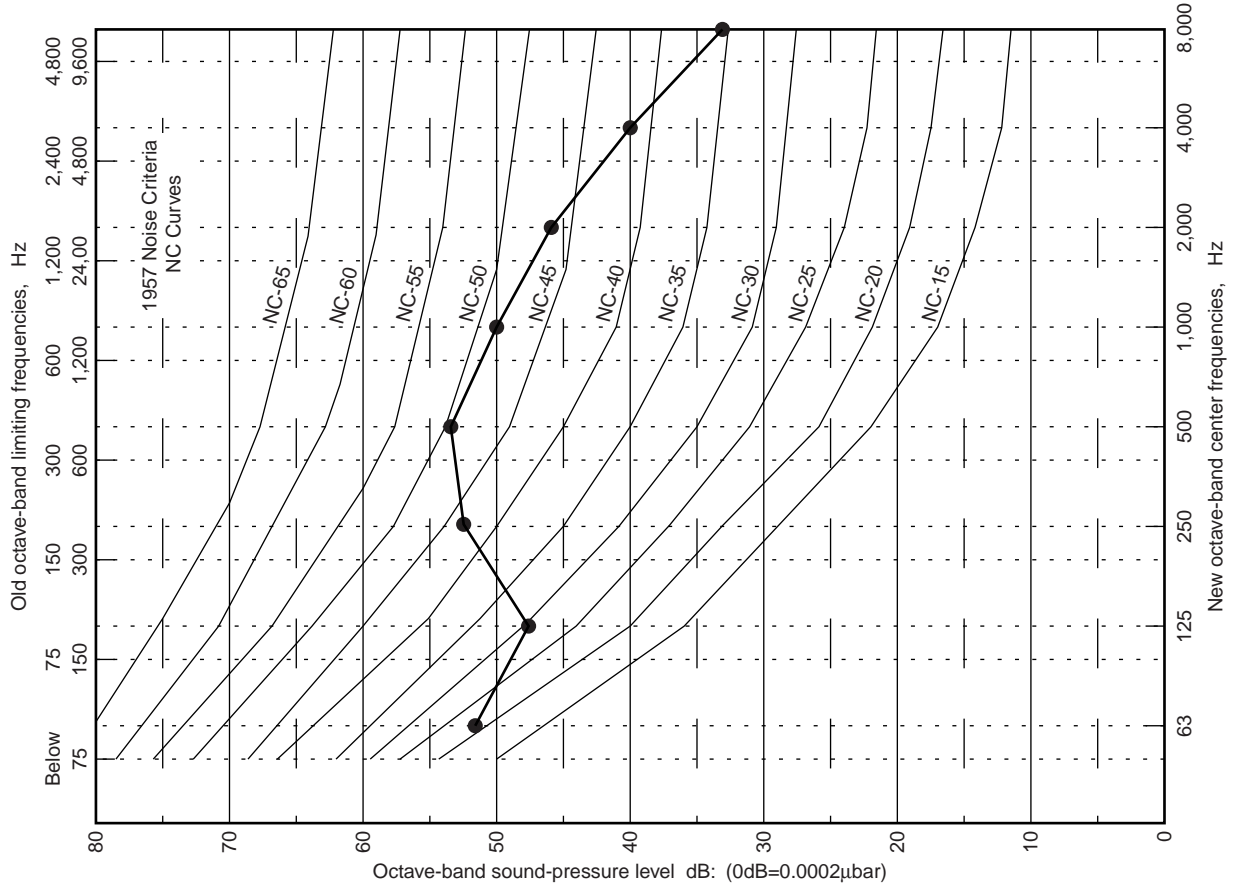

AOY54A, AOY54R

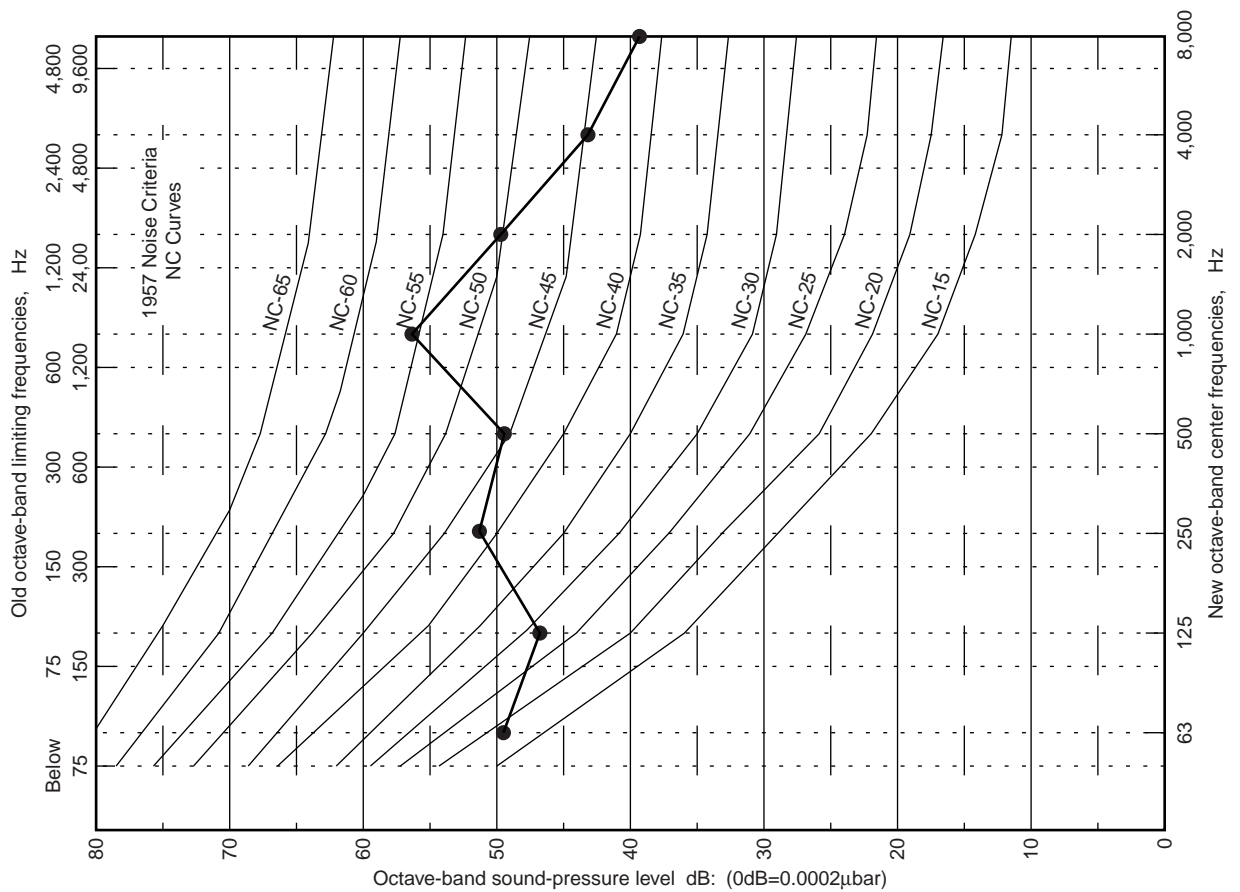

4. SPECIFICATIONS

TYPE		COOLING TYPE				COOLING & HEATING TYPE				
MODEL	IN	AUY30ALB-W	AUY36ALA3W	AUY45ALA3W	AUY54ALA3W	AUY30RLB-W	AUY36RLA3W	AUY45RLA3W	AUY54RLA3W	
	OUT	AOY30ABKL	AOY36ACF3L	AOY45ACF3L	AOY54ABF3L	AOY30RBJL	AOY36RCF3L	AOY45RCF3L	AOY54RBF3L	
POWER SOURCE	V/#/Hz	220-240/1/50	380-415/3/50	380-415/3/50	380-415/3/50	220-240/1/50	380-415/3/50	380-415/3/50	380-415/3/50	
COOLING CAPACITY	kW	8.6 - 8.8	10.3 - 10.5	12.4 - 12.7	13.9 - 14.1	8.6 - 8.8	10.3 - 10.5	12.4 - 12.7	13.9 - 14.1	
HEATING CAPACITY	kW	---	---	---	---	8.8 - 9.1	10.5 - 10.7	13.4 - 13.7	15.4 - 15.8	
RUNNING CURRENT (A)	COOLING	15.8-16.3	6.6 - 6.6	7.5 - 7.5	8.5 - 8.6	16.0 - 16.5	6.6 - 6.6	7.5 - 7.5	8.5 - 8.6	
	HEATING	---	---	---	---	14.1 - 14.6	5.9 - 5.9	7.5 - 7.5	8.5 - 8.6	
INPUT WATTS (kW)	COOLING	3.30 - 3.40	3.73 - 3.80	4.35 - 4.45	4.90 - 5.00	3.35 - 3.45	3.88 - 3.95	4.35 - 4.45	4.90 - 5.00	
	HEATING	---	---	---	---	2.90 - 3.00	3.40 - 3.45	4.25 - 4.35	4.85 - 4.90	
STARTING CURRENT	A	80	42	55	79	80	42	55	79	
MOISTURE REMOVAL	ℓ/h	4	5	6	6	4	5	6	6	
E.E.R. (kW/kW)	COOLING	2.61 - 2.59	2.76 - 2.76	2.85 - 2.85	2.84 - 2.82	2.57 - 2.55	2.65 - 2.66	2.85 - 2.85	2.84 - 2.82	
	HEATING	---	---	---	---	3.03 - 3.03	3.09 - 3.10	3.15 - 3.15	3.18 - 3.22	
FAN SPEED (r.p.m.)	HIGH	500	580	620	680	500	580	620	680	
	MED	430	500	550	580	430	500	550	580	
	LOW	360	420	470	500	360	420	470	500	
	OUTER	730	790	790	790	760	790	790	790	
AIR FLOW	INDOOR	m ³ /h	1,300	1,500	1,650	1,800	1,300	1,500	1,650	1,800
	OUTDOOR		3,320	5,900	5,500	5,500	3,450	5,900	5,500	5,500
NOISE LEVEL (dB(A))	INDOOR	HIGH	45	48	49	52	45	48	49	52
		MED	42	44	46	48	42	44	46	48
		LOW	39	39	42	44	39	39	42	44
	OUTDOOR		54.5	57.5	59	59	56	58	59	59
DIMENSIONS H x W x D (mm)	NET	IN	296 x 830 x 830							
		GRILLE	35 x 940 x 940							
		OUT	900 x 900 x 350	1,152 x 940 x 370			900 x 900 x 350	1,152 x 940 x 370		
	GROSS	IN	455 x 1,060 x 1,025							
		OUT	1,045 x 1,025 x 445	1,280 x 1,000 x 450			1,045x1,025x445	1,280 x 1,000 x 450		
WEIGHTS [NET/GROSS] (kg)	IN	47 / 60								
	OUT	85 / 97	94 / 108	102 / 116	112 / 126	85 / 97	96 / 110	108 / 122	120 / 134	
MAXIMUM PIPE LENGTH / HEIGHT		30 / 15	50 / 30			30 / 15	50 / 30			
REMOTE CONTROLLER TYPE		WIRED								



FUJITSU GENERAL LIMITED

1116, Suenaga, Takatsu-ku, Kawasaki 213-8502, Japan