



INSTRUCTION MANUAL



GB

USER TERMINAL: EVOLUTION

U	I	A	General characteristics	2
U	I	A	User interface	2
U	I	A	Main screen	3
U	I	A	Flow charts for accessing the screens	7
U	I	A	Default values	11
U	I	A	Diagram of ambient temperature control	12
U	I	A	Diagram of ambient humidity control	13
U	I	A	General information and definitions	14
U	I	A	Most common configurations	15
U	I	A	Electrical connections	16
U	I	A	Connection between pCOI boards	16
U	I	A	LAN connection between 2 or more units	17
U	I	A	Connections to the remote terminal from the board	18
U	I	A	Configuration of the terminal and the board	19
U	I	A	Displaying the network from the terminal	20
U	I	A	Troubleshooting	21

The following symbols are used in this publication and inside the unit:



User



Important



Installer



Prohibition



Assistance

In some parts of this manual, the following symbols are used:



WARNING = for actions that require special care and suitable preparation



PROHIBITED = PROHIBITED

Specialist personnel
(electrician)

Person with in-depth knowledge and experience such as to be able to recognise risks and avoid dangers that may derive from electricity (IEV 826-09-01).

The EVOLUTION controller allows independent control of all the unit operating parameters.

The controller is made up of:

- A microprocessor control board housed inside the electrical panel
- A user terminal or graphic interface

The program that resides on the control board can be used on all types of precision air-conditioning units, specifically:

- direct expansion units, water cooled or air cooled;
- water chiller units;
- direct expansion units with energy saving function;
- dual cooling units.

The main functions of the program are:

- management of the temperature and humidity in civil or technological environments;
- management of 1 or 2 scroll compressors
- management of between 1 and 3 electric heating stages for heating and post-heating;
- management of modulating valves for cooling using cold water and heating using hot water;
- management of the evaporator fan speed, when featured;
- management of an external or built-in immersed electrode humidifier;
- outlet temperature control;
- management of alarms and maintenance warnings;
- logging of up to 100 alarm events;
- management of the safety running time for each components;
- unit on/off from user terminal, remote contact, supervisory system and according to time bands;
- local network (LAN) connection for managing backup units;

- connection to local supervision networks and BMS (LonWorks, BACnet, Modbus.....).

Through the user terminal you can view and modify (by using a password) all following datas:

- values read by the probes and the corresponding calibration;
- active alarms, alarm log, configuration of the alarm digital outputs;
- configuration of the local network (LAN);
- parameter settings for serial communication with the supervisory system;
- configuration parameters and fundamental control parameters;
- operating hours and number of starts of the controlled devices;
- clock settings;
- selection between the different languages available.

Using the local network connection, the program can manage the following additional functions:

- Automatic rotation by time or event, for 1 or 2 units in stand by mode, between max 10 units connected in LAN
- management of the average temperature and humidity readings from a maximum of 10 units;
- use of just one terminal to control a maximum of 10 units;

In order to protect the program default settings, the software features two levels of password, USER for the main user settings, and FACTORY for the authorised technicians, used to modify and reset all the software parameters.

USER INTERFACE

U I A

The user interface is made up of:

- 11x15 pixel backlit LCD;
- 6 backlit buttons for scrolling and modifying the parameters.

The microprocessor board is connected to the user interface using a 4-pin telephone cable with RJ11 jack.

Technical features

Power supply	from the power board through telephone cable (cod. S90CONN00*) or from external source 18 to 30 Vdc through TCONN6J000
Power input	PGDI: 1.2 W;
Operating conditions	-20T60 °C, <90% rH non-condensing
Storage conditions	-30T70 °C, <90% rH non-condensing
Index of protection	IP65 with panel mounting, IP40 with wall mounting
Resolution	132X64
Back-lighting	green LED
Buzzer	NOT AVAILABLE
Row number	8
pLAN	default

- ALARM** button functions:
- reset the alarm (if hold for 5 seconds)
 - flashes red in the event of active alarms
 - to stop buzzer durino an alarm

button PRG:
access the configuration menu

button ESC:
exit the screens

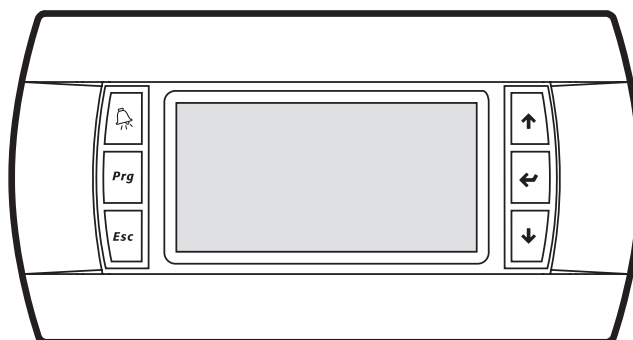

- button UP** functions:
- scroll and/or change screen
 - modify the values
 - to move inside the manu



- button ENTER** functions:
- confirm the modifications
 - access the areas for modification

- button DOWN** functions:
- scroll and/or change screen
 - modify the values
 - scroll inside the menus

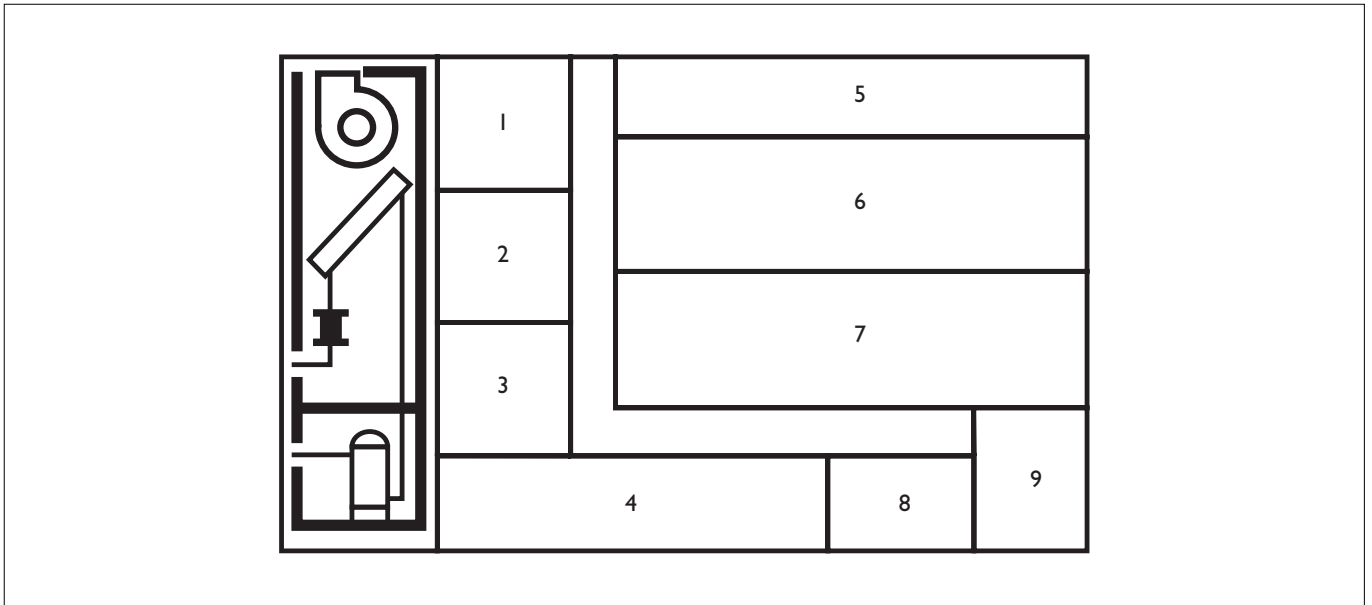









The following figure shows the layout of the main screen.



Area 1 - GENERAL STATUS OF THE UNIT.































	unit off
	unit on

Area 2 - DETAILED INDICATION OF THE UNIT STATUS.

	presence of an active alarm (flashing)
	maintenance signal (flashing)
	manual controls active (flashing)
	unit on/off from terminal (flashing)
	unit on/off from remote contact (flashing)
	unit on/off from supervisory system (flashing)
	unit on due to emergency via the network (LAN) (flashing)
STAND BY	Unit in stand-by (flashing)
	Unit ON for High Temperature Limit overcoming (flashing)
	Unit ON for Low Temperature Limit overcoming (flashing)
	Unit ON for High Humidity Limit overcoming (flashing)
	Unit ON for Low Humidity Limit overcoming (flashing)

Area 3 - ALARMS LIST

This area displays an icon that, in the event of alarms or maintenance signals, respectively indicates the type of alarm and the device that requires maintenance.

	EEPROM fault
	LAN disconnected
	Water leak (flood)
	High pressure in circuit 1
	High pressure in circuit 2
	High pressure
	Low pressure in circuit 1
	Low pressure in circuit 2
	Low pressure
	High ambient temperature
	Low ambient temperature
	High ambient humidity
	Low ambient humidity
	Air flow alarm
	Incorrect phase sequence
	Filters blocked
	Fire/smoke detected
	Wrong password (5 attempts)
	Electric heater overheat
	High water temperature
	High water temperature during dehumidification
	High humidifier current
	Low humidifier current
	No water in humidifier
	Room temperature probe fault
	Room humidity probe fault
	Outlet air temperature probe fault
	Outside air temperature probe fault
	Cold water temperature probe fault
	Hot water temperature probe fault
	Emergency mode active

EVENT OF ALARM

In case of Alarm event:

- Acoustic signalling is activated (buzzer);
- Red led under the alarm button s activated;
- Green leds on main screen are activated
- AREA 2 on main screen is showing the alarm icon;
- AREA 3 on main screen visualized an icon who represent the kind of active alarm .

With a single press on the alarm button the acoustic signalling is de-activated.

RESET OF ALARM STATUS

To make the ALARM RESET, we split the alarms in 3 different kind:

- Alarms with only Automatic Reset:
in this category we found only the alarm “LAN DISCONNECTED”.
- Alarms with Automatic/Manual Reset (based on the customer's settings on screen I3); in this category we found:
 - Ambient Temperature Limits overcoming
 - Ambient Humidity Limits overcoming
 - Chilled Water too high
 - Water Flow missing
 - Low Pressure alarm
 - Humidifier alarm
 - Air filter alarm

By default alla bove are setted with AUTOMATIC RESET.

- Alarms with only Manual Reset:

After removing the alarm cause, it's required to push alarm button for few seconds to remove completely the alarm signalling and will disappear any Alarm icon from AREA 2 and AREA 3.

With “Wrong Password Alarm”, the RESET is only manual after the right input of the correct password.

ALARM LIMITS

With User Password (screens “I”): it's possibile to modify the alarms limits setted like, Ambient Temperature Limits overcoming, Ambient Humidity Limits overcoming, Chilled water too high(2 limits: 1 for standard functiuoning, 2 for dehumidification functioning) anyway based on unit configuration.

ALARMS OUTPUTS











With User Password (screens “I”): it is possible to configure the alarms output available on the main board. Based on unit configuration we can have 1 Alarm output (marked A) or 2 Alarm outputs (marked A & B).

We can also set:

- Status of Alarm Contacts (normally Open or Closed in OFF position: in this second case we can also raise the “power missing alarm”);
- Address the desire alarm in contact A or B , depending on customer choice.

Area 4 ACTIVE COMPONENTS

This area displays icons corresponding to the devices currently installed on the unit.

 1	compressor 1 active
 2	compressor 2 active
 1 2	compressors 1 and 2 active
 1	first electric heater stage active
 2	second electric heater stage active
 1 2	first and second heater stages active (third stage active)
	Dehumidification active
	Humidification active
	Cold water valve open
	Hot water valve open
	Hot gas active

Area 5

This area displays the time and date, if the clock board is fitted.

Area 6

This area displays the room temperature currently read by the probe on the unit (even if the control is enabled based on the average of the values read by the units connected in the LAN).

Area 7



This area displays the relative humidity currently read by the probe on the unit (even if the control is enabled based on the average of the values read by the units connected in the LAN).

Area 8

This area indicates the LAN address of the unit, if connected to other units.

Area 9

This area indicates the unit on/off mode from the user terminal.

	press ENTER to switch the unit off
	press ENTER to switch the unit on

STATUS SCREENS

Starting from the main screen, pressing the UP/DOWN buttons accesses the other status screens, which are, in order:

- A WATER VALVE STATUS/OPTIONAL PROBE READINGS:** screen displaying the temperature values read by the optional probes (outlet air temperature probe, chilled water temperature probe, hot water temperature probe, outside air temperature probe) and the percentage of opening of the cold and hot water modulating valves;
- B LAN STATUS:** screen displaying the status of all the units connected in the LAN;
- C HUMIDIFIER STATUS:** screen displaying the status of the humidifier, with all the technical operating values;
- D SET POINTS:** screen displaying the active control set point; from this screen, pressing PRG and entering the first level password, accesses a further screen used to modify the set point and proportional band corresponding to each type of active control (cooling, heating, dehumidification, humidification);
- E OPERATING HOURS:** screen displaying the total operating hours of the devices installed on the unit; from this screen, following the instructions shown on the display and after entering the first level password, the operating hours for each device can be reset (set to zero), or the thresholds for activating the maintenance signal can be changed;
- F NUMBER OF STARTS:** screen displaying the total number of activations for the devices installed on the unit; from this screen, following the instructions shown on the display and after entering the first level password, the number of starts for each device can be reset
- G LOG ACCESS:** screen for accessing the display of the alarm log;
- H SOFTWARE INFO:** screen displaying information on the software installed.

MAIN LOOP SCREENS

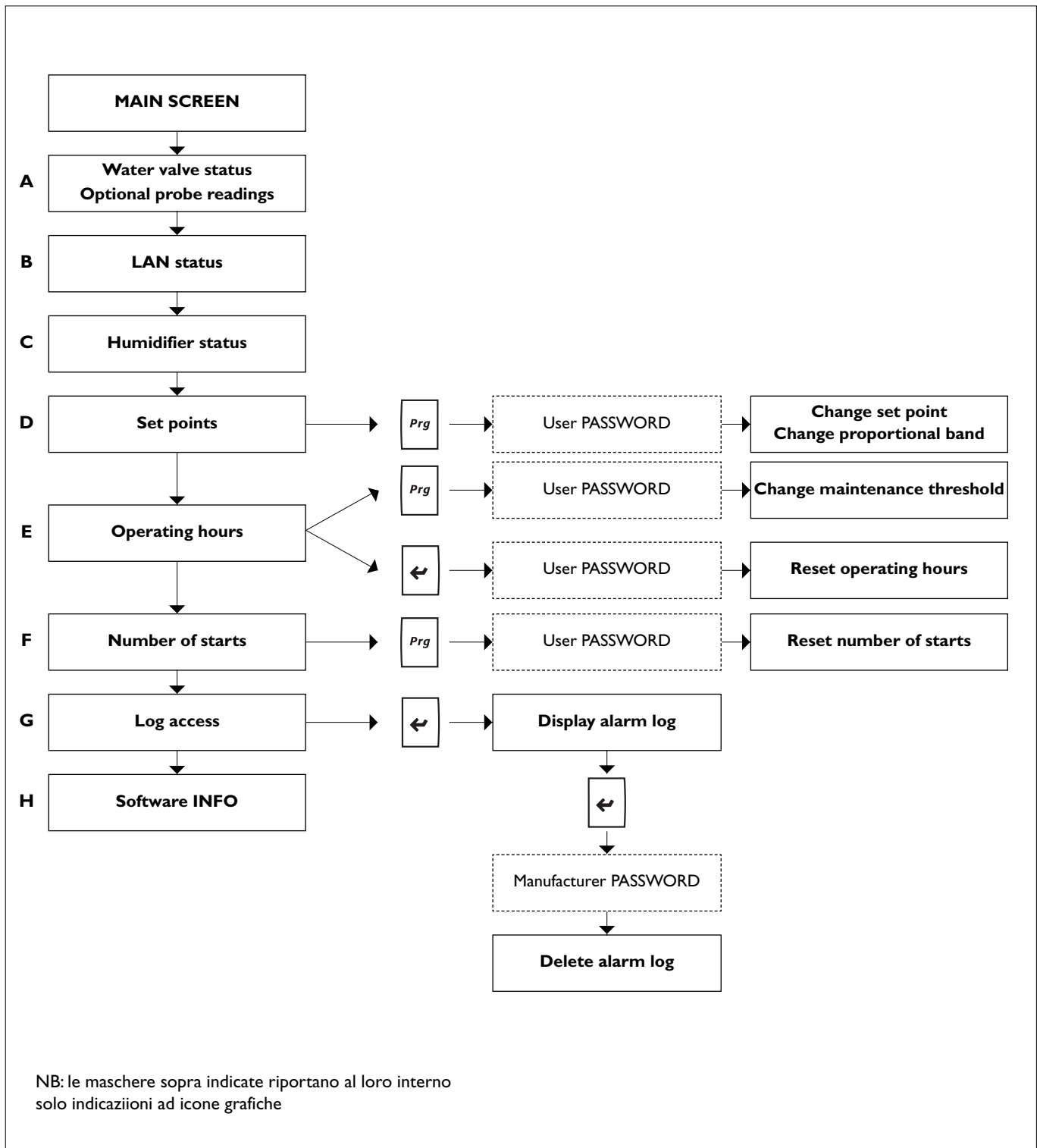

SCREENS FOR SETTING THE PARAMETERS

Starting from the main screen, pressing the PRG button and entering the correct password accesses a menu used to set all the other parameters that are not available on the status screens, as described in the previous paragraph.

Two passwords can be entered:

- **User password:** accesses the user parameters, that is, the parameters considered as being useful and easy to understand for the user;
- **Manufacturer password:** accesses all the parameters, that is, both the user parameters and the manufacturer parameters.

The complete menu items are as follows:

I SETUP (alarms setting):

this menu is used to set the thresholds for the limit alarms (high and low ambient temperature, high and low ambient relative humidity, high water temperature), the delays for some alarms, the type of reset (automatic or manual) for some alarms, and the addresses of the alarm digital outputs available on the controller;

L SETUP (LAN/serial/modem):

(user password)

this menu is used to configure the local network (LAN) and set all the corresponding parameters, as well as the serial communication parameters;

M SETUP (control settings):

(manufacturer password)

this menu is used to manually control all the devices on the unit, disabling normal automatic control;

N SETUP (clock setup):

(user password)

this menu is used to set the current time and date, if the clock board is fitted;

O TEST/ (test/manual control):

(manufacturer password)

settings that involve the configuration of the unit, that is, the devices, probes and sensors on the unit; it is also possible to check the status of each single contact (INPUT & OUTPUT) of the main board;

P SETUP (unit configuration):

(manufacturer password)

this menu is used to modify some critical parameters that are part of the control algorithm inside the control system;

Q DEFAULT SETUP:

(manufacturer password)

this menu is used to restore the default parameter values; important: this operation also deletes the alarm log (this can also be deleted on the screen displaying the log, as indicated on the display and after entering the second level password), while it does not cancel the basic configuration of the unit.

SCREENS “I”

Screen “I1”

Used to modify alarms limits for: ambient temperature, ambient humidity & chiller water temperature.

Screen “I2”

Used to modify the alarms delay and in particular:

- Air flow alarm delay after fans starting
- Ambient temperature & Humidity alarm limits delay
- Air Filters alarm delay
- Low Pressure alarm delay after compressor starting

Screen “I3”

Used to set kind of RESET: Automatic or Manual (only for alarms where it's allowed by manufacture)

Screen “I4”

Used to set STATUS of alarms contact

Screens “I5”, “I6”

Used to address the the alarm contact, type A or B.

SCREENS “L”

Screen “L1”

Used to set all parameters of LAN connection like:

- Number of units in LAN
- Temp. and Humidity average value mode activated
- Abilitation of Stand by unit
- Rotation cycle time
- Number of Stand by unit (max 2 in case we have more than 4 units connected)
- Activation of Stand by unit for overcoming limits by Master unit.

Screen “L2”

Used to modify regulation set-points on Stand by unit, is function has been activated on screen L1

Screen “L3”

Used to modify all settings related to the serial connections.

SCREENS “M”

Screen “M1”

Used to set advanced parameters for temperature and humidity control like:

- delay at start up after power back from failure
- Integral time
- Abilitation of air delivery sensor (when optino is required) and relative set points.

Screen “M2”

Used to adjust the value read by Temp. sensors.

Screen “M3”

Used to modify the PASSWORD.

SCREENS “N”

Screen “N1”

Used for clock settings

SCREENS “O”

Screen “O1” & “O2”

Used to activate manually the unit and also each single components installed on it.

Screen “O3” & “O4”

Used to check all contact available on board

SCREENS “P”

These screens are of fundamental importance for the right unit functioning. Keep strong attention before to modify them, and eventually keep in contact with the manufacturer.

Any wrong use of this screens will make immediately decline any warranty responsibility from the manufacturer.

Screen “P1”

Used to set the main important/fundamental features of each unit

Screen “P2”

Used to set eventually optional sensors

Screen “P3”

Used to set the Remote ON-OFF via el. Contact and the time constants values for water valves 3 points.

Screen “P4”

Used to modify parameters related to Electronic backward curved EC Fans, like:

- Standard speed
- Energy saving speed when unit is not in regulation.

Screen “P5”

Used to modify parameters related to Electronic backward curved EC Fans, when it is related to 3 way chilled water valve. Then this is screen is available only for AC* (chilled water unit).

Screen “P6”

Used to activate the Emergency Mode: when the dedicated contact on the board activate the Emergency mode, only the components reported inside this screen remain in ON, in order to save energy.

Screen “P7”

Used to modify and set Humidifier parameters.

Screen “P8”

Used to temporary disabling the Humidifier in order to provide its maintenance or replacement.

SETTING PARAMETERS SCREENS

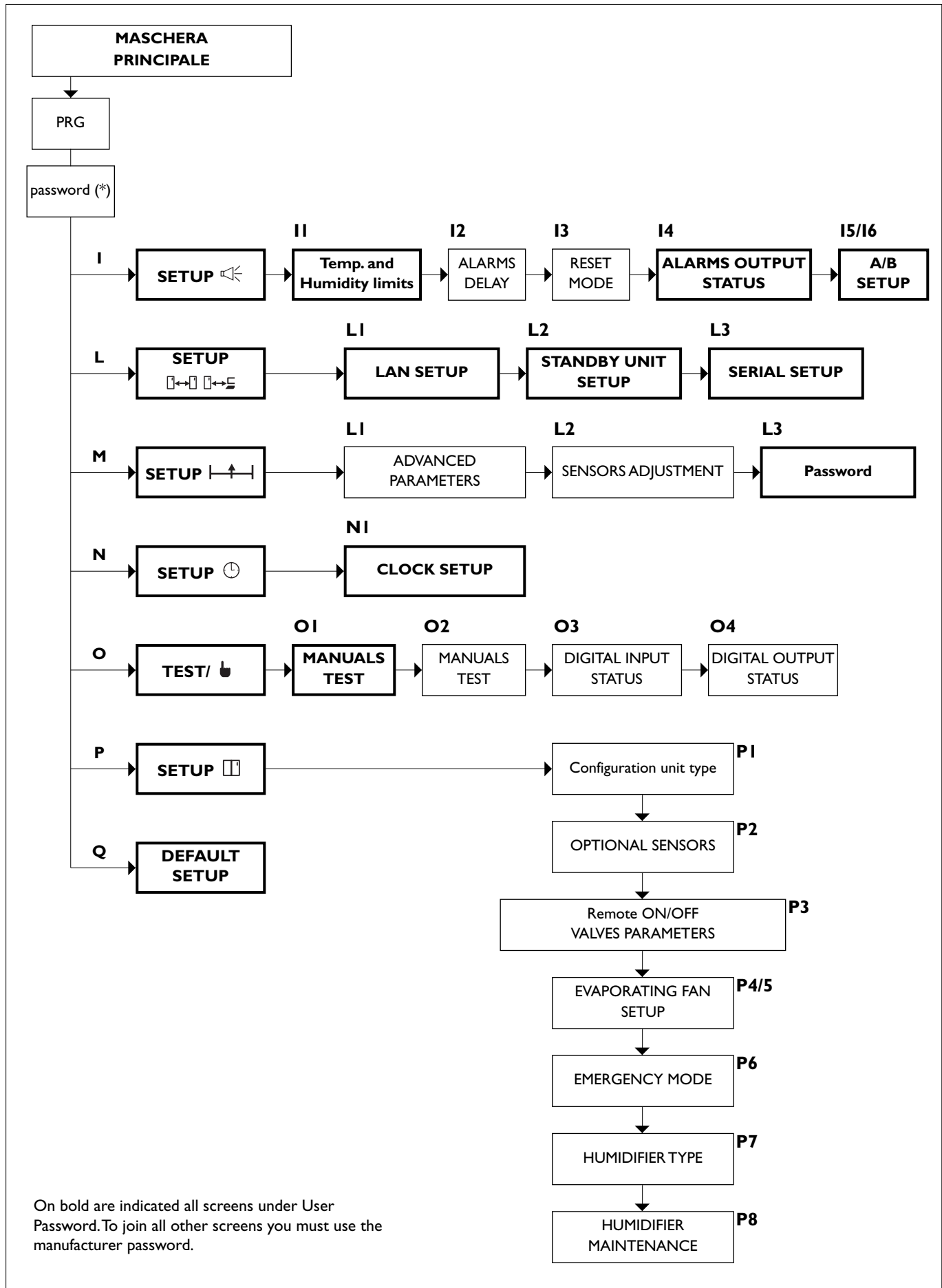

	U.M.	DEFAULT	MIN	MAX
Set points and differential band				
Cooling set point	°C	24	17	35
Cooling proportional band	°C	1.5	0.5	9.9
Heating set point	°C	24	12	30
Heating proportional band	°C	1.5	0.5	9.9
Dehumidification set point	%	55	45	90
Dehumidification proportional band	%	5	3	15
Humidification set point	%	45	10	55
Humidification proportional band	%	5	3	15
Maintenance operating hour threshold				
Fan	h	00000	00000	32767
Compressor 1	h	00000	00000	32767
Compressor 2	h	00000	00000	32767
Heaters 1	h	00000	00000	32767
Heaters 2	h	00000	00000	32767
Humidifier	h	00000	00000	32767
Alarm parameters				
High ambient temperature threshold	°C	32	20	50
Low ambient temperature threshold	°C	10	0	30
High ambient humidity threshold	%	80	30	99
Low ambient humidity threshold	%	30	0	70
High water temperature threshold	°C	15	5	50
High water temperature threshold in dehumidification	°C	7	0	30
Flow alarm delay after unit start-up	s	15	15	999
Alarm delays when exceeding temperature and humidity limits	s	60	0	999
Blocked filter alarm delay	s	8	2	999
Low pressure alarm delay after compressor start	s	180	2	999
Reset temperature limit alarm		Auto	MAN	Auto
Reset humidity limit alarm		Auto	MAN	Auto
Reset high water temperature alarm		Auto	MAN	Auto
Reset low pressure alarm		Auto	MAN	Auto
Reset humidifier Alarm		Auto	MAN	Auto
Reset water flow alarm		Auto	MAN	Auto
Select alarm output		A		
LAN parameters				
High temperature threshold to switch the unit on in standby	°C	30	20	50
Low temperature threshold to switch the unit on in standby	°C	18	0	30
High humidity threshold to switch the unit on in standby	%	75	55	90
Low humidity threshold to switch the unit on in standby	%	35	10	45
Serial parameters				
Serial address		I		
Serial baud rate	baud	1200		
Protocol		Standard		
Advanced control parameters				
Unit start delay	s	0	0	999
Control start delay after unit start-up	s	60	20	999
Integration time	s	900	0	999
Enable minimum outlet air temperature limit		Y		
Minimum outlet temperature limit set point	°C	12	0	25
Enable dehumidification function		Y		
Hot water activation set point	°C	40	20	99.9

1. Direct expansion version (DX)

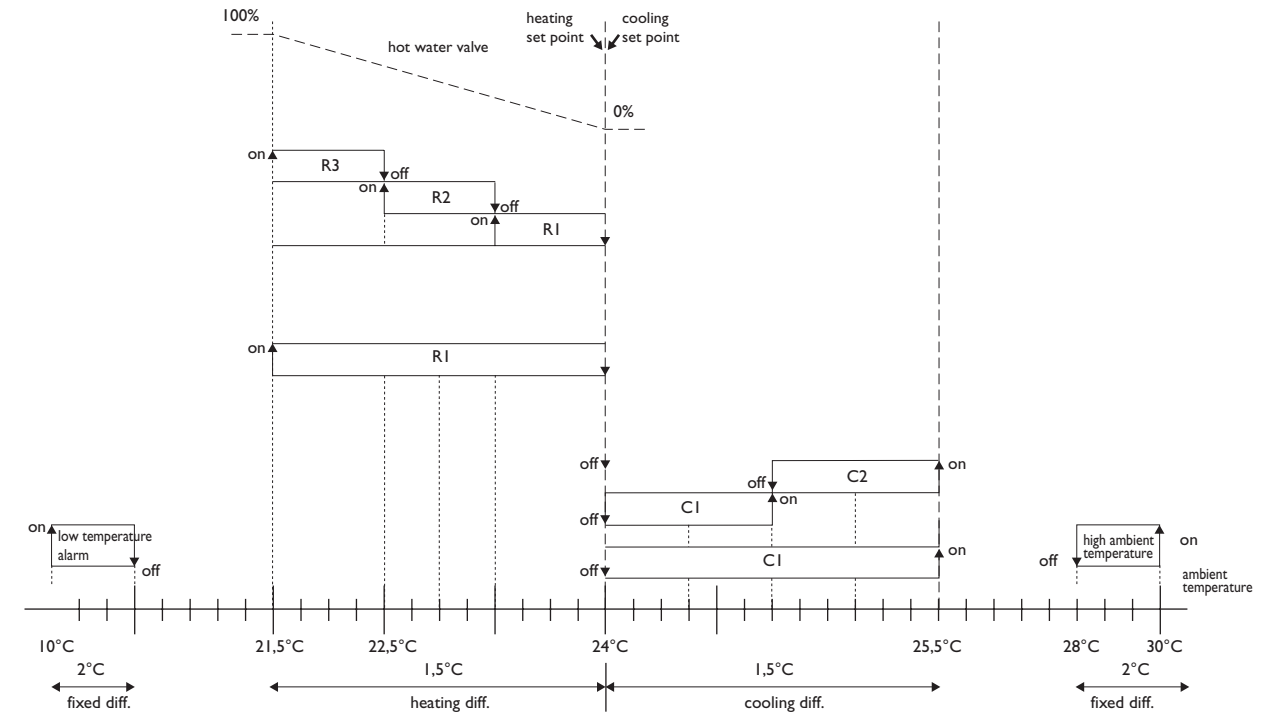

2. Chilled Water version (CW)

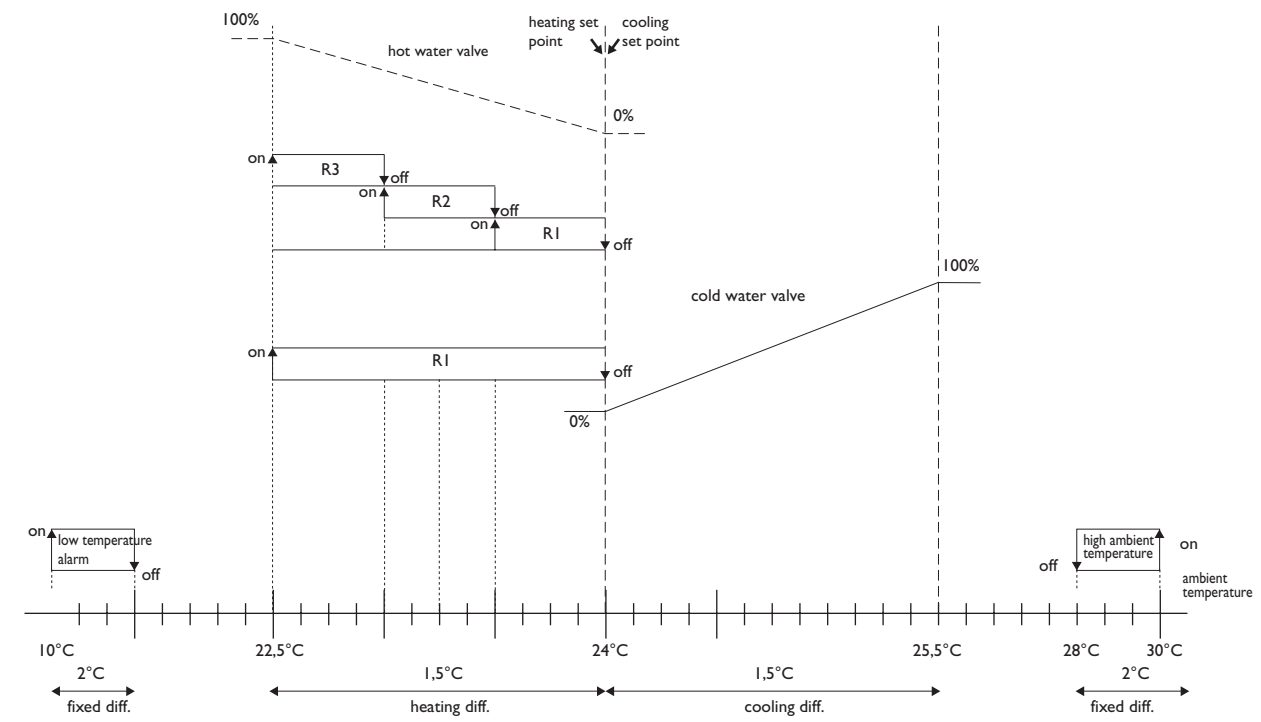

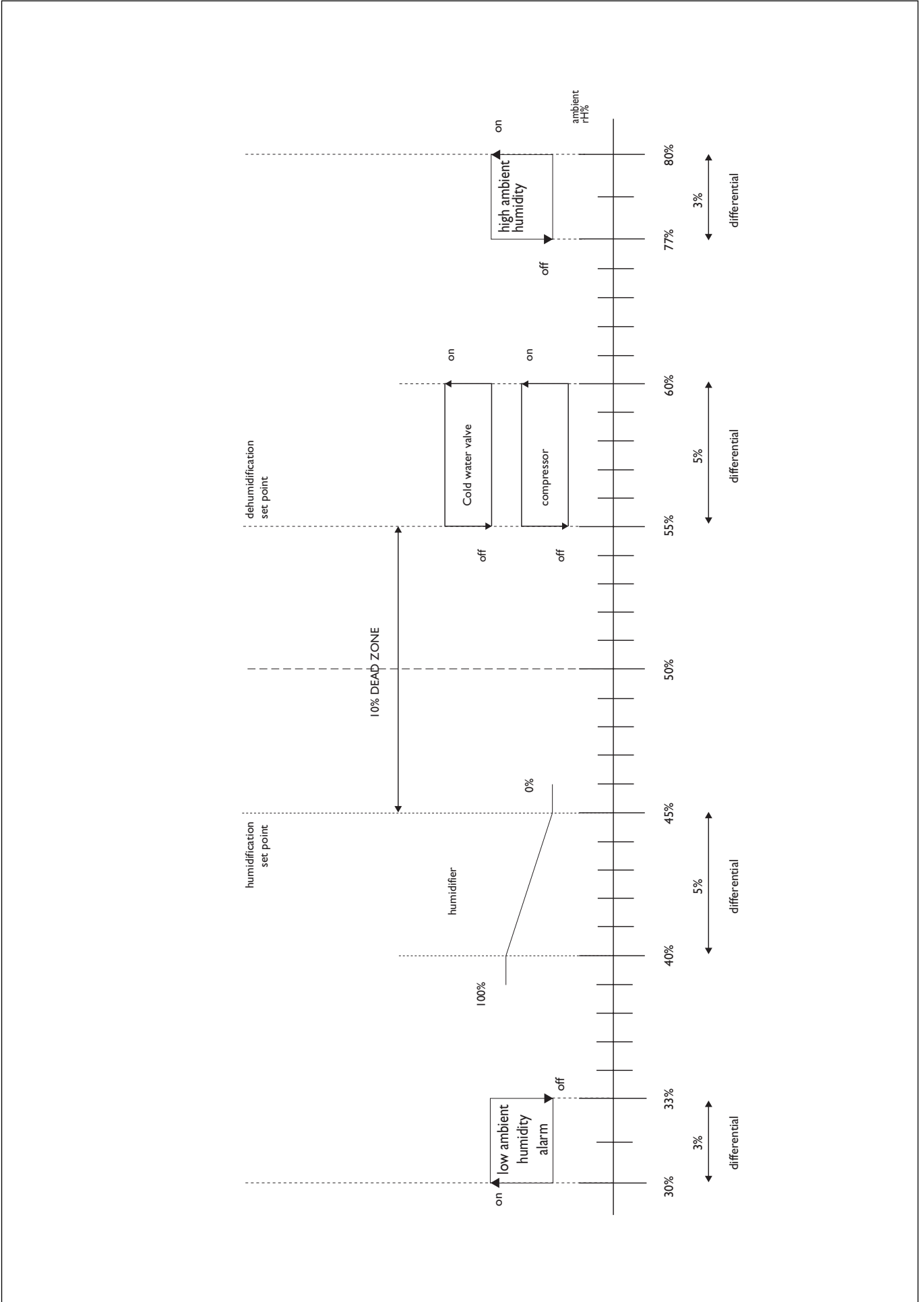

- 1 The local network connection is used to manage the operation of a series of air-conditioners operating inside the same environment, or a series of liquid chillers connected in parallel in the same installation.
- 2 The max number of units that can be connected is 10.
- 3 The maximum extension of the network connections is **500 metres**.
- 4 All the units connected in the network must have the same version of the program installed in the flash memory on the board.
- 5 A terminal can be configured as "private" or "shared":
 - a **private terminal** can display the operating status only of the unit it is connected to via telephone cable;
 - a **shared terminal** can display the operating status of all the units connected in the network.
- 6 Each board can "talk" to a maximum of 3 terminals; in common applications, generally no more than two are used: one fitted on the unit and another optional remote terminal configured as share terminal.

The priority on the remote share terminal is always the display of the alarms, even if when the alarm is activated the terminal is displaying the parameters from another unit.

- 7 To be able to communicate over a local network, the units must be configured so as to be able to send the other units the required information for correct operation.

In this regard, the first step involves assigning a progressive number to the different units (1, 2, 3,...10) and then correctly setting the addresses of the various terminals and LAN boards, and making the electrical connections, step-by-step, as described in the following paragraphs.

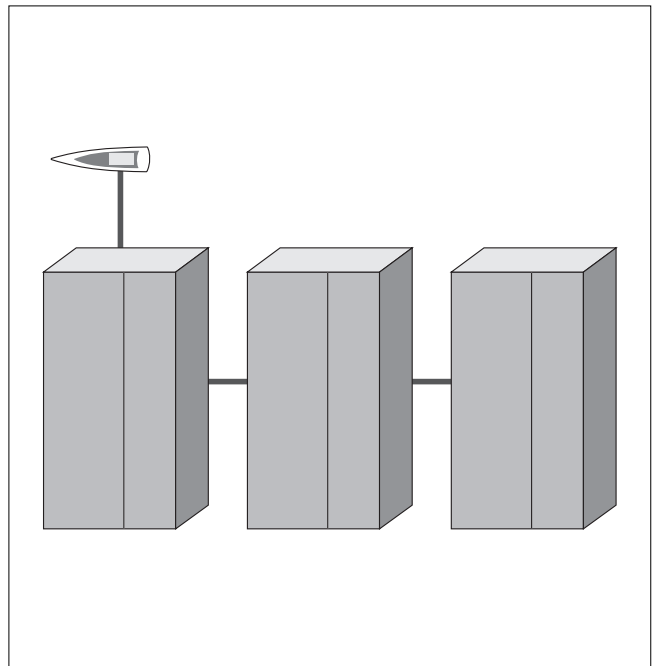
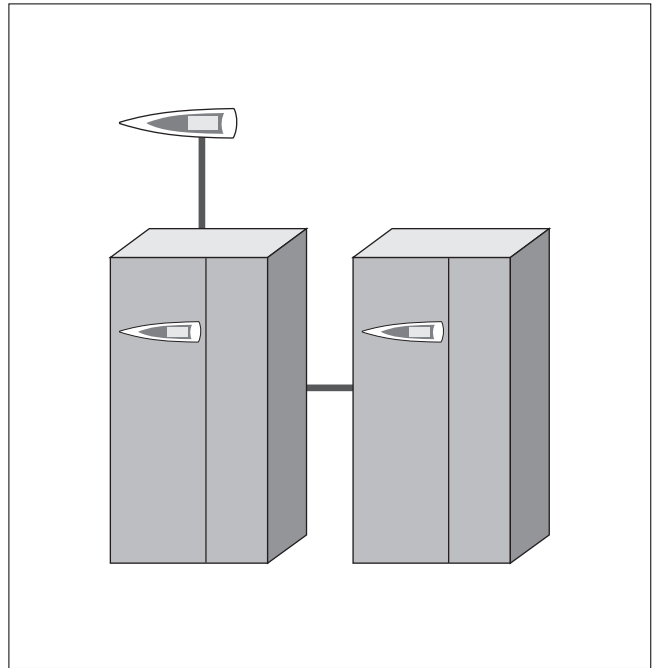

1 Up to 10 units connected in the network with just one remote share terminal

In this configuration, a power failure on the first unit will cause the terminal to shutdown, and therefore the information corresponding to the units in the network can no longer be read. Nonetheless, the other units in the network would continue to operate normally.

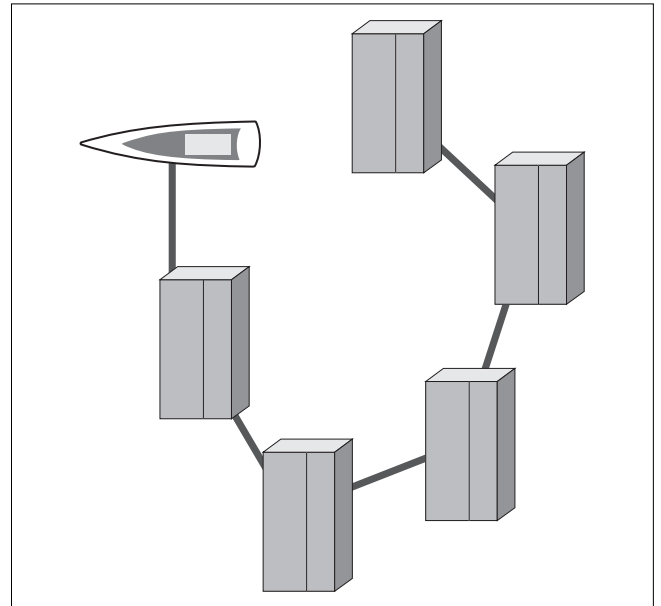

2 Up to 10 units, each with its own terminal

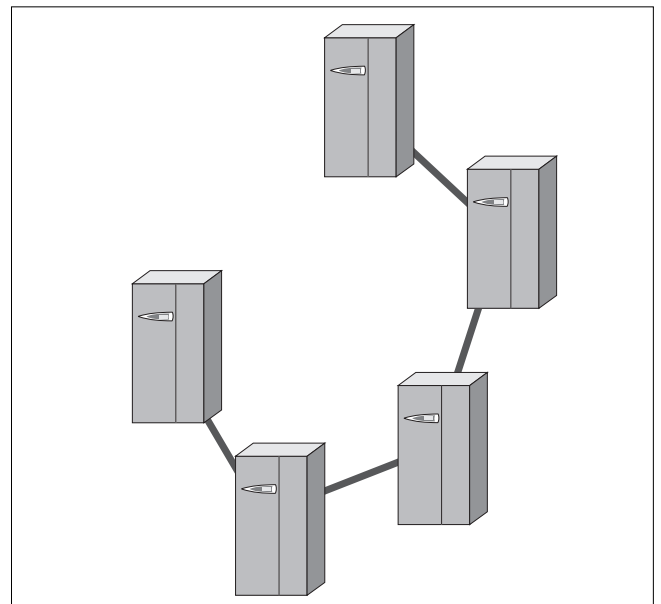

3 Up to 10 units, each with own terminal, with just one shared remote terminal

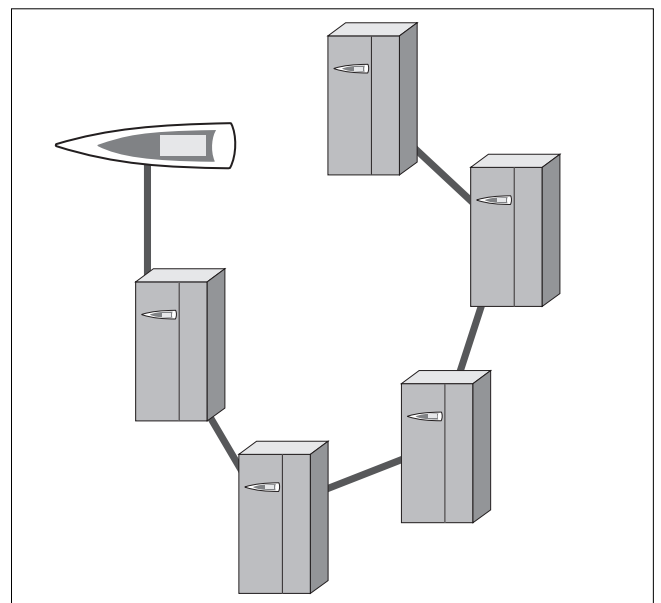

The electrical connections must be completed when the units are off and disconnected from the power supply.

The network can have different configurations, according to the maximum distance of the connections between the boards and the remote terminal; for the connections between the remote terminal and the main board, a 'T' shunt may be required, as shown in the drawing.

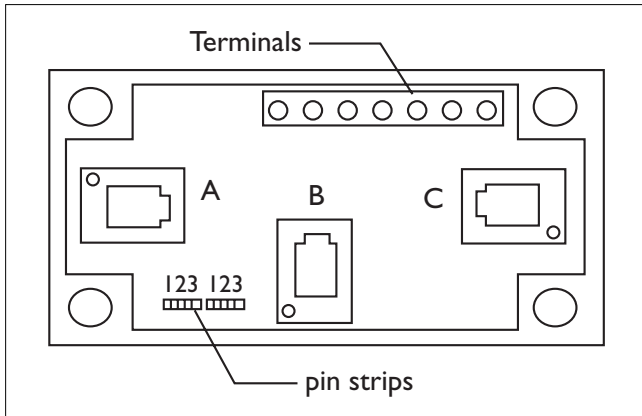

terminal	function
0	Earth (shield)
1	+VRL \approx 30Vcc
2	Gnd
3	Rx/Tx-
4	Rx/Tx+
5	Gnd
6	+VRL \approx 30Vcc

If both the jumpers are installed between 2 and 3 the flow of current is interrupted between the connectors separated by the dashed line.

If power is required on all the connectors, both the jumpers must be installed between 1 and 2.

Terminal 0 is an auxiliary terminal and can be used to earth the shield of the cable; the 'T' shunt must in any case be connected to a metallic part of the unit that is already earthed.

MAXIMUM DISTANCE BETWEEN THE TERMINAL AND THE BOARD

1 For local terminals the connection to the main board is already made using a 3-pair cable and 6-pin telephone connector. The length of this cable generally does not exceed 3 metres.

2 The remote terminals can be connected to the main board using the type of telephone cable described in point 1, with a maximum distance of 50 metres.

3 For greater distances, up to a maximum of 200 metres, a shielded cable must be used (six lead cable with shield and twisted pairs, AWG24, resistance < 80 ohm/M). The cable may have 3 or 2 pairs, depending on whether the power needs to be supplied to the terminals. The cable is not supplied by CLIMAVENETA HOME SYSTEM s.r.l.

AWG 24 cables with two twisted pairs plus shield, such as the Belden 8723 or 8102, and AWG 24 cables with three twisted pairs plus shield, Belden 8103 or similar, are recommended.

CONNECTION BETWEEN PC01 BOARDS

In this configuration, the local terminal is already connected to the main board using a telephone cable.

To complete the network wiring, the control boards should be connected in parallel using a shielded cable and with terminal J11 as the reference, as shown in the figure.

IMPORTANT: the polarity of the network must be observed: The RX/TX+ on one board must be connected to the RX/TX+ on the other boards; the same is true for RX/TX-.

Terminal on the board	Cable connections
GND	First pair (both wires)
Rx/Tx -	Second pair
Rx/Tx +	Second pair

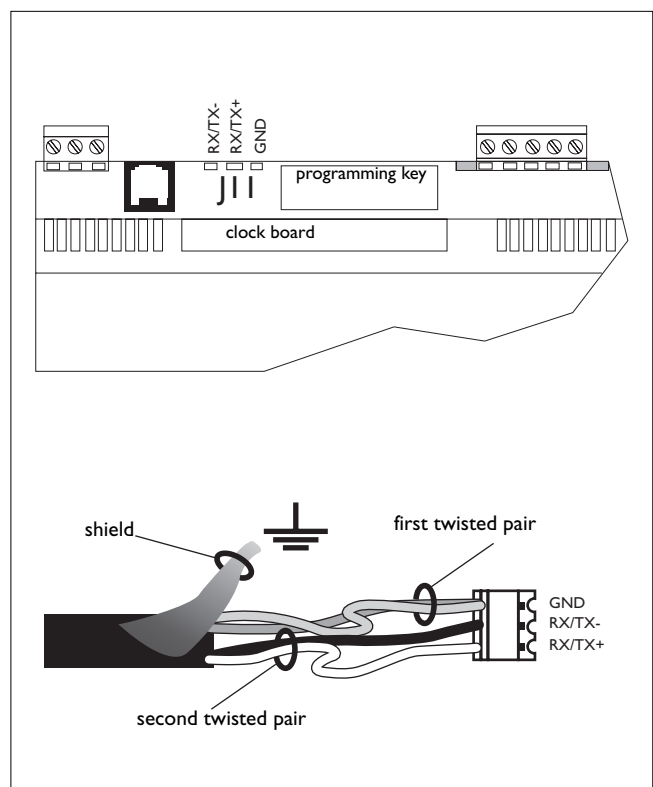

The shield on the shielded cable is earthed at a single point in the network.

Earthing the cable at different points in the network may cause control malfunctions.

The connection must be made, where possible, by fastening the cable with a metal clamp, as shown in the figure on the left.

Alternatively, use the twisted end of the shield, as long as the length of the earthed shield is as short as possible and a locking washer is used (figure on the right).

The following pages show the diagrams for a series of boards connected to the network, powered by the transformers installed in the electrical panel for each unit.

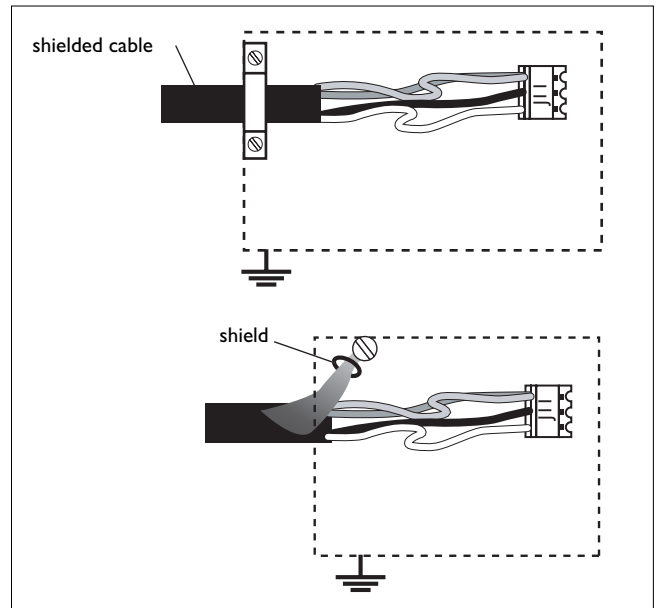

LAN CONNECTION BETWEEN 2 OR MORE UNITS

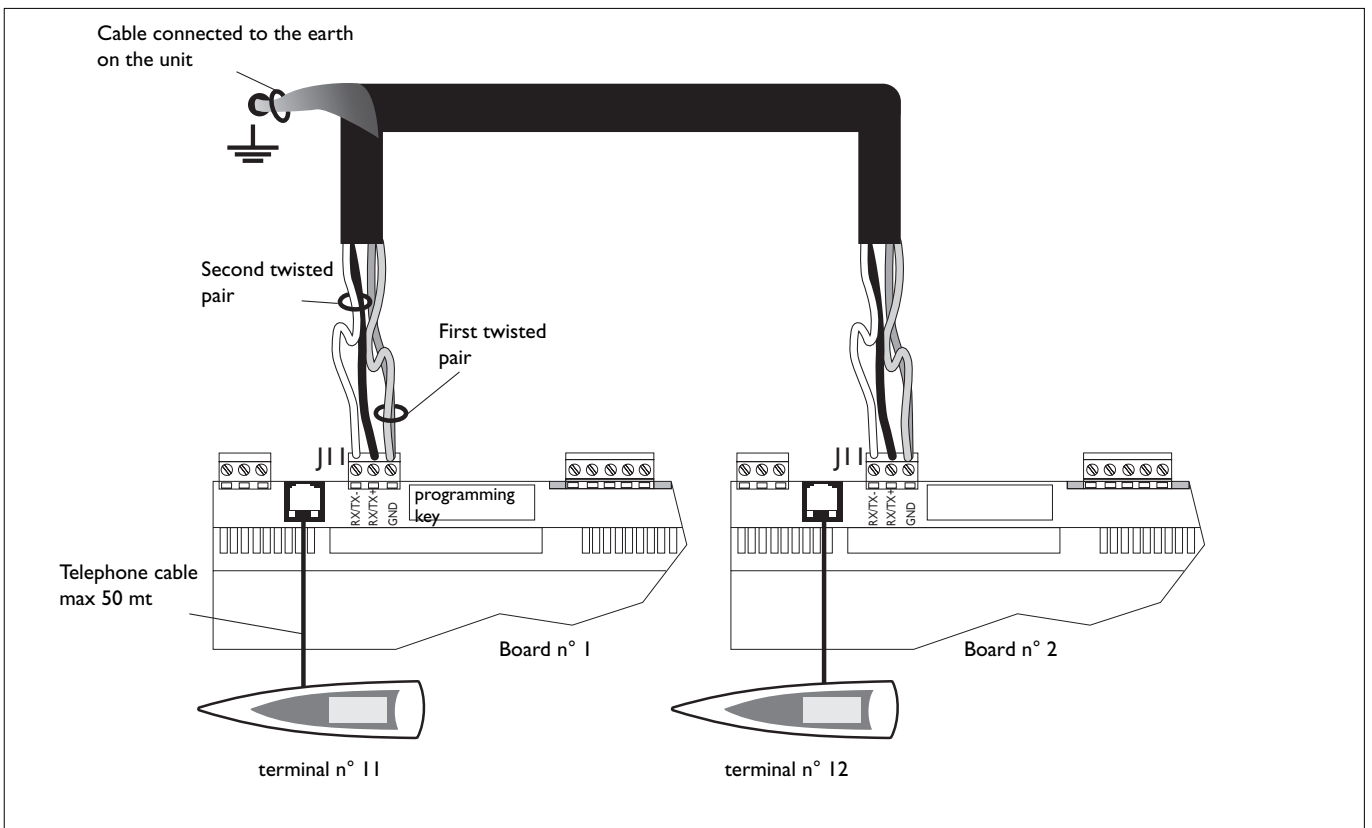

EXAMPLE OF CONNECTION TO THE REMOTE TERMINAL POWERED BY THE BOARD

This configuration requires:

- 1 the use of two 'T' shunts: one fitted on the unit and one near the remote terminal;
- 2 the use of the 3x2 shielded cable, so that the power to the remote terminal is also supplied by the board on unit 1, connected using the 'T' shunt;
- 3 near the terminal, insert the ferrite to reduce any electromagnetic disturbance.

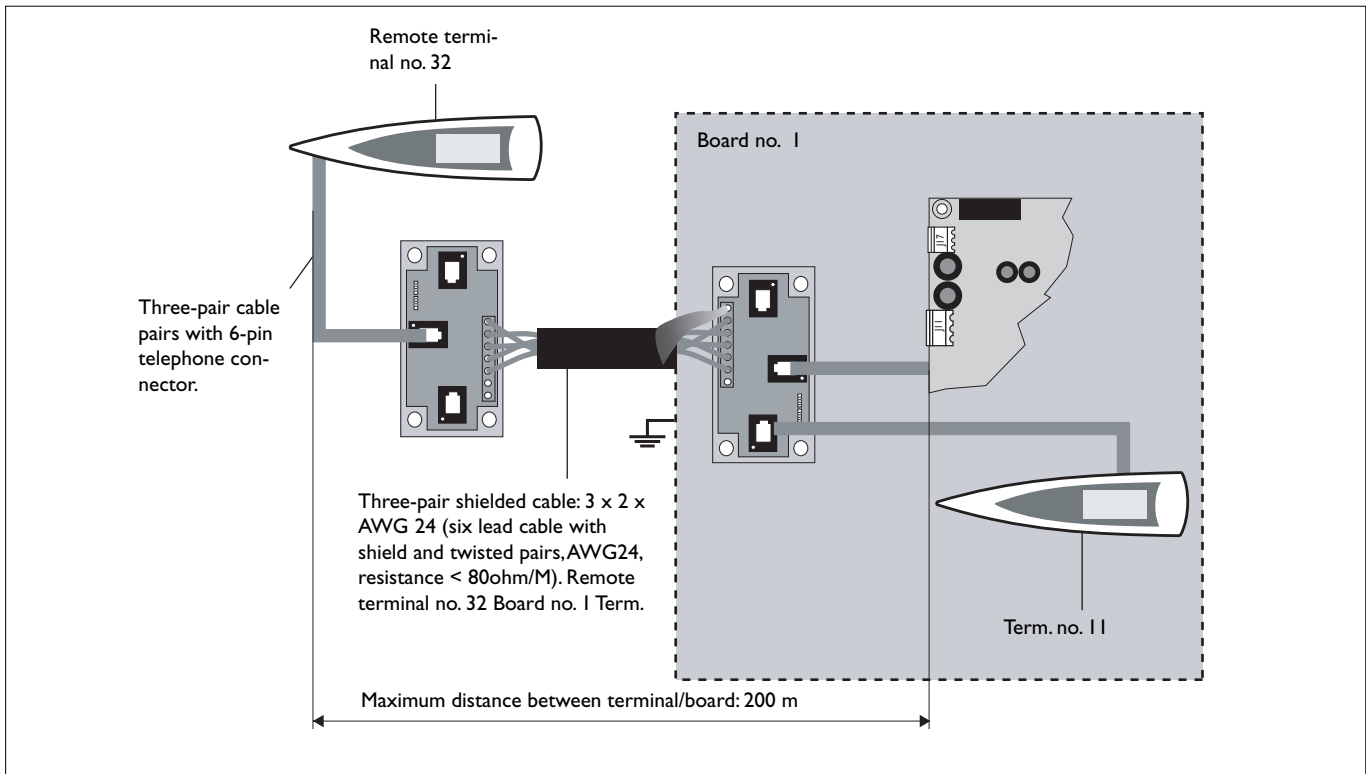

Connections for the 2 x 2 x AWG 24 CABLE
(for connecting the remote terminal: without transferring the power supply)

terminal	function	cable connections
0	Earth	shield
1	+VRL \approx 30Vcc	
2	Gnd	First pair
3	Rx/Tx -	Second pair
4	Rx/Tx +	Second pair
5	Gnd	First pair
6	+VRL \approx 30Vcc	

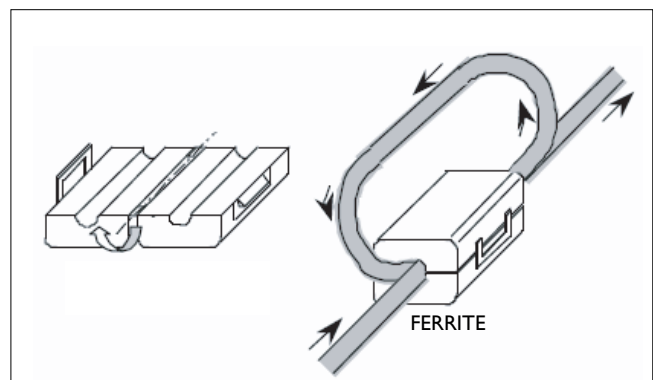

SETTING THE LOCAL NETWORK ADDRESS ON THE EVOLUTION TERMINAL AND THE pCOI BOARD

Before setting the addresses, first check the LAN connection between the boards, the connection to the remote or shared terminal, and the power supply connections to the unit.

The terminal address can be set only after having connected it to the power supply using the RJ11 telephone connector.

To enter configuration mode, press the UP ENTER DOWN buttons together (featured on all versions) for at least 5 seconds; the screen shown in Fig. 1 will be displayed, with the cursor flashing in the top left corner:

- To set the address of the terminal (display address setting), press the ENTER button once: the cursor will move to the address field (nn).
- Use the UP and DOWN buttons to select the desired value, and confirm by pressing ENTER again.

If the value selected is different from the one saved previously, the screen shown in Fig. 2 will be displayed and the new value will be saved to the permanent memory on the display.

If the field nn is set to 0, the terminal will communicate with the pCOI board using the "point-to-point" protocol (not pLAN), and the field XX will not be displayed, as it no longer has meaning.

Display address setting.....:nn
I/O Board address:xx

Display address changed

pCOI: assigning the list of private and shared terminals

Subsequently, to modify the list of terminals associated with each individual pCOI board, proceed as follows:

- enter configuration mode by pressing UP ENTER DOWN, as described in the previous paragraph;
- press the ENTER button until the cursor reaches the field XX (I/O board address) Fig. 1;
- use the UP and DOWN buttons to select the address of the desired pCOI board. The values available correspond to the pCOI boards that are effectively on line. If the pLAN network is not working correctly, or no pCOI board is available, the field cannot be modified and will show "-";
- pressing the button once again displays the sequence of screens shown in Fig. 3;
- again the ENTER button moves the cursor from one field to the next, and the UP and DOWN buttons change the value of the current field.

The field P:xx shows the address of the selected board; in the example in Fig. 3, P12 has been selected.

To exit the configuration procedure and save the data, select the field "OK ?", set Yes and confirm by pressing ENTER.

The fields in the "Adr" column represent the addresses of the terminals associated with the pCOI board with address 12, while the Priv/Shared column indicates the type of terminal.

Important: the EVOLUTION terminals cannot be configured as "Sp" (shared printer), as they have no printer output.

If the terminal remains inactive (no button is pressed) for more than 30 seconds, it automatically exits the configuration procedure without saving any changes.

Assigning the List of Private and Shared Terminals

Terminal Config
Press ENTER to continue

P12:	Adr	Priv/Shared
Trm1	02	Sh
Trm2	03	Ph
Trm3	None	--OK?NO

fig. 3

LAN ADDRESS OF THE pCOI BOARD

The address of the boards is set as described below:

- 1 Disconnect the power supply from the board UPCLM;
- 2 Remove the J11 connector (Rx/Tx-, Rx/Tx+, GND);
- 3 Connect the board on unit no. 1 to a user terminal with address = 0;
- 4 Power-up the board and at the same time hold the ALARM and UP buttons until the following screen is displayed:

SELF TESTING
PLEASE WAIT

and then

pLAN address: 1
up: increase
down: decrease
ENTER: save & exit

- 5 Press the ENTER button to accept the address of the board proposed on the display, or alternatively the UP and DOWN buttons to modify the value: set "pLAN address: 1" on unit no. 1.

(NOTE: if no button is pressed for 15 seconds, the screen disappears, and the procedure needs to be repeated from point 1.).

- 6 Confirm by pressing ENTER;
- 7 Disconnect the power supply;
- 8 Repeat the procedure from point 1 to point 4 for unit no. 2. and set "pLAN address: 2 ";

pLAN address: 2
up: increase
down: decrease
ENTER: save & exit

- 9 Replace the J11 connectors (Rx/Tx-, Rx/Tx+, GND) on the boards.
- 10 Repeat the procedure from point 1 to point 4 for the other units.

TABLE OF TERMINAL ADDRESSES AND LAN BOARD ADDRESSES

Terminal address (displayed automatically)	LAN Board Address (set using the buttons on the terminal)
11	1
12	2
13	3
14	4
15	5
16	6
17	7
18	8
19	9
20	10
Terminal address (displayed automatically)	LAN Board Address (displayed automatically)
32 (remote)	-

Fig. 1 represents a network made up of 4 units, each with its own local user terminal and with a shared remote user terminal (32) that displays the information for unit 1.
To move from one unit to the next, in sequence (1>2>3>4>no.....), simply press **ESC + DOWN**.

fig. 2

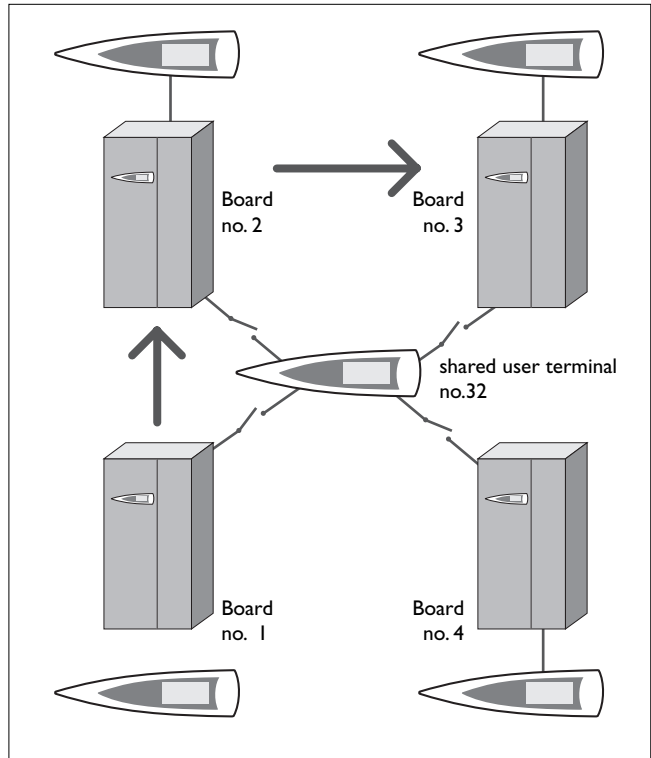

DISPLAYING THE NETWORK FROM THE TERMINAL U I A

From any terminal in the network, holding the UP + ENTER + DOWN buttons for at least 10 seconds, will display the << NetSTAT >> screen (see Fig. 2).
The NetSTAT screen shows all the LAN boards and all the terminals connected in the network, including the shared remote terminal, with the corresponding addresses.

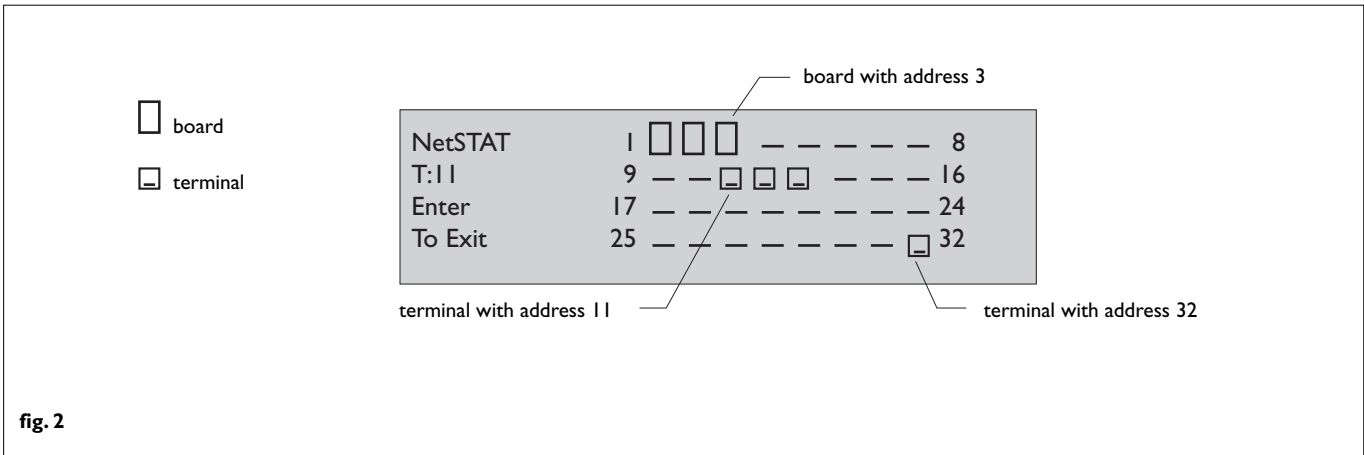

In the example, the network is made up of 3 LAN boards with addresses 1, 2, 3, and 4 user terminals with addresses 11, 12, 13 and 32.

PROBLEM	CAUSE	SOLUTION
The user terminal does not switch on or does not communicate with the unit.	The connection cable between the pCOI board and the user terminal may be detached or broken. Possible power failure to the pCOI board. Possible blown fuse on the pCOI board or in the power supply line.	Check the connection between the user terminal and the pCOI board. Check that the pCOI board is powered and on, check any fuses in the power supply line.
The user terminal is on but no icons or menu items are displayed.	The address of the pCOI board or the user terminal may be incorrect. The contrast of the display may have been adjusted by mistake	Check that the LAN address of the pCOI board and the address of the user terminal are compatible. Check by pressing the PGR+ALARM+UP buttons to increase or PGR+ALARM+DOWN to decrease the contrast.
The shared user terminal cannot communicate with the unit or the units connected in the network (LAN).	The address of the terminal may be incorrect. The connection cable between the units may be detached or broken. The connection cable may be detached or broken.	Check the LAN connection between the units. Check the connection on the three-way 'T' shunt.

If after having checked all the possible causes of the problems described here the problem has not been resolved, contact your nearest service centre for further information on how to proceed and resolve the problem.

