

Join us to create
a sustainable
future

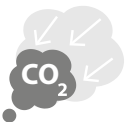

Lower CO₂ equivalent
and market-leading efficiencies



Lower CO₂
equivalents



Industry-leading
real life efficiencies



Flexibility to take care
of every room



Variable Refrigerant
Temperature

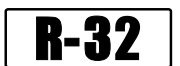

BLUEVOLUTION

Creating a sustainable future together

Determined to reduce our environmental footprint, we aim to be CO₂-neutral by 2050. A circular economy, innovation and smart use – these are the stepping stones on our path.

The time to act is now. Join us in creating a sustainable future for HVAC-R.

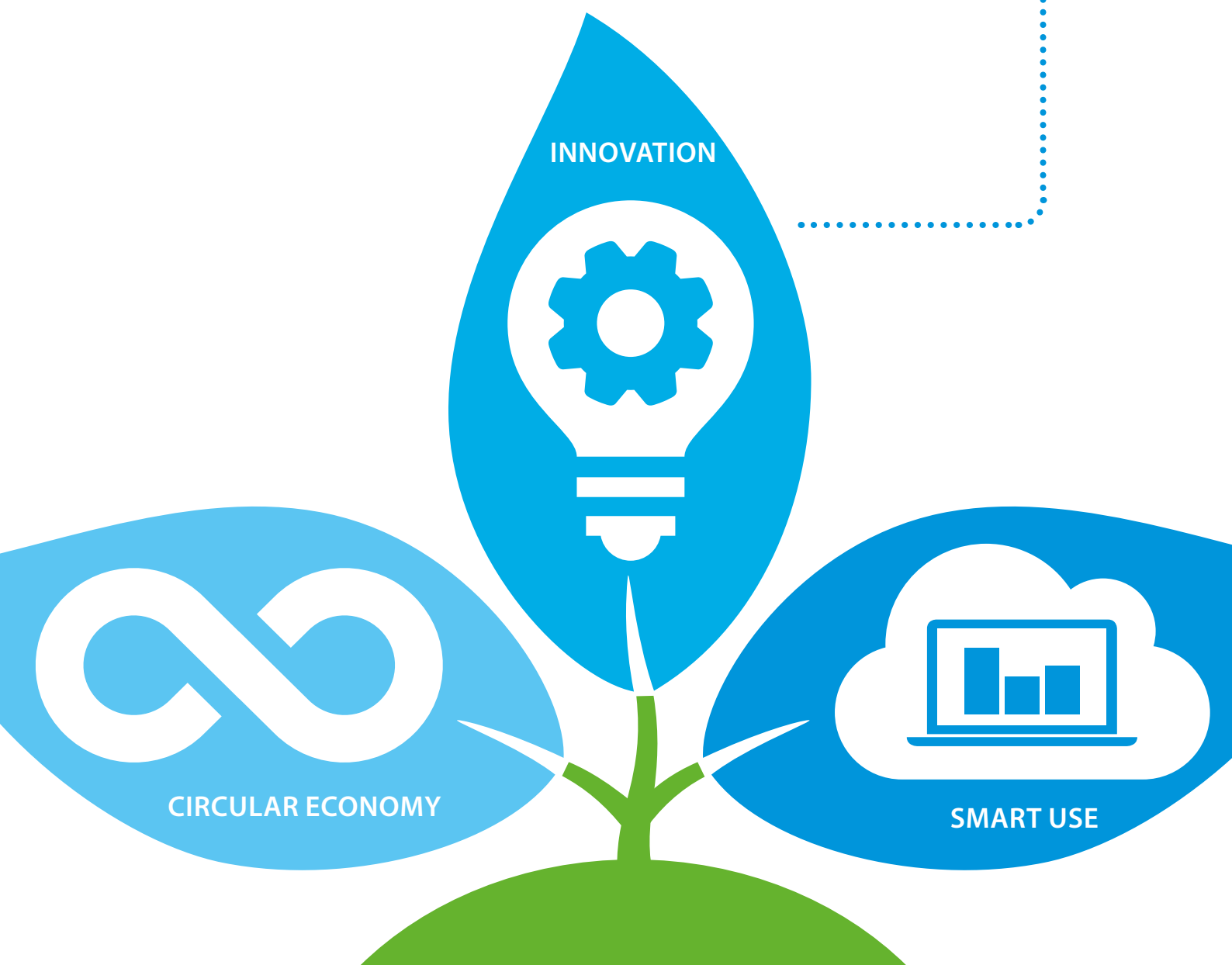

www.daikin.eu/building-a-circular-economy



INNOVATION



2013

First R-32 split
Ururu Sarara



2016

Full range of optimised
Split R-32 units
First R-32 Sky Air



2017

Full range of
optimised Sky Air R-32
units
Launch of HFO chillers



2018

Launch of
Daikin Altherma
heat pump range
on R-32



2020

Launch of
VRV 5 on R-32

Continuing our path to lower CO₂ equivalent solutions through innovation

Since the launch of Ururu Sarara in 2013, the first air conditioner to use R-32 refrigerant, we have worked to convert our portfolio to lower GWP refrigerants. The launch of the VRV 5 S-series, a completely newly developed unit specifically for R-32 refrigerant, is the latest evolution.

Advantages of R-32

- › Lower Global Warming Potential (GWP): only 1/3rd of R-410A
- › Lower refrigerant charge: 15% less compared to R-410A
- › Higher energy efficiency
- › Single component refrigerant, easy to handle and recycle

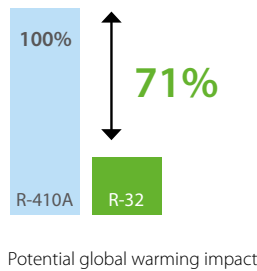

-71%

potential global warming impact

Ahead of the F-gas phase down targets

Thanks to the shift to R-32 we stay ahead of the F-gas regulation phase-down targets. In times where the VRV market is growing fast, this enables us to do our business in a sustainable way, while securing future growth.



With people in mind

- Daikin has the ambition to bring you:
- the most sustainable system;
 - easy and versatile to install;
 - with credible data.



Industry-leading
real life efficiencies

The best VRV we ever made

Lower CO₂, equivalent and
market-leading versatility



Top sustainability

- ✓ Reduced CO₂ equivalent thanks to the use of R-32 refrigerant
 - › R-32 Global Warming Potential (GWP) is 68% lower than R-410A
 - › 15% less refrigerant charge
 - Leading to a GWP reduction of 71% on system level!
- ✓ Single component refrigerant, easy to re-use and recycle
- ✓ Top sustainability over the entire lifecycle, thanks to market leading real-life seasonal efficiency
- ✓ Ideal for your green building certification, thanks to lower GWP refrigerant



BLUEEVOLUTION



BREEM®

Industry-leading serviceability and handling

- ✓ Low-height single fan range
- ✓ Easy to transport thanks to compact design
- ✓ Wide access area to easily reach all key components
- ✓ No leak check requirement for majority of installations (up to 7,4 kg of total charge)





Maximum flexibility out of the box

With Shirudo technology your VRV 5 system takes care of small room applications in your building, without the need for any additional considerations and equipment in the field.

- > Fully compliant with the latest product standard IEC60335-2-40 (Ed.6)
- > Third party CB certified by a Notified Body (SGS CEBC)

Automatic and real time leak detection, alarm and refrigerant recovery

Shirudo technology minimizes furthermore the risk of direct CO₂ eq. impact from a refrigerant leak.

The system is continuously self monitoring, and in the unlikely event of a refrigerant leak, this is immediately detected. An alarm is activated to notify tenants, while refrigerant is automatically recovered.

Best-in-class design versatility

- ✓ Sound pressure down to 39 dB(A) thanks to 5 low sound steps to suit the application
- ✓ Automatic ESP setting up to 45 Pa to allow ducting
- ✓ Low height, less than 1m high including support feet, making the unit easy to hide



Geared for comfort

- ✓ Intuitive online and voice control
- ✓ Interfaces with home control systems
- ✓ Variable Refrigerant Temperature for optimal comfort
- ✓ Specially designed new 10 class indoor unit for small, well-insulated rooms

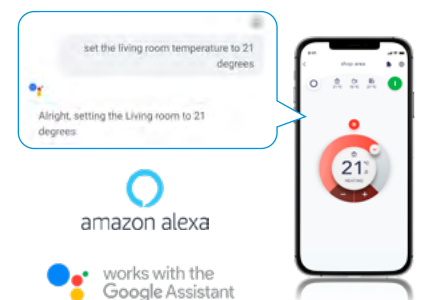

Did you know ...

different standards regarding F-gas safety regulations exist?

Two standards are applied to cover the safety regulations of refrigerants:

- › **EN378:2016**: the generic standard on refrigerants covering the **toxicity** of the refrigerant (class A or B)
- › **IEC60335-2-40 (Ed.6)**: the specific heat pump product standard covering the **flammability** of the refrigerant (1, 2L, 2, 3)

When is which standard applicable?

IEC60335-2-40 (Ed.6), being a specific product standard, prevails over any generic product standard, like EN378:2016 is.

Considering also that limitations for flammability for A2L refrigerants are stricter than the ones for toxicity, **the application area of VRV 5 is covered by IEC60335-2-40 (Ed.6)!**

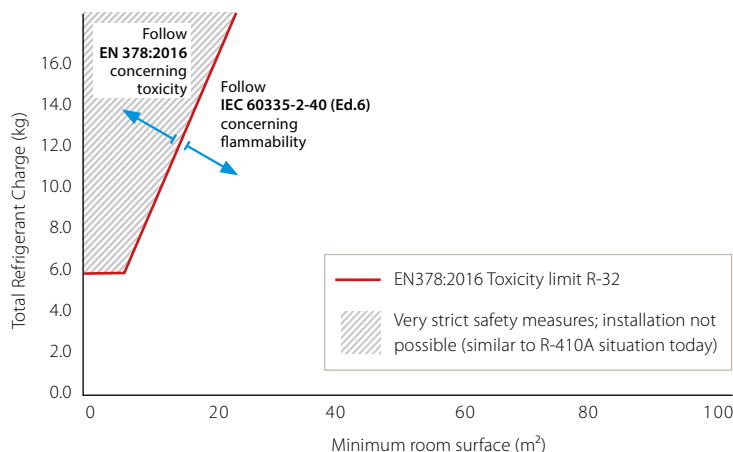

How to get the most of an R-32 VRV under IEC60335-2-40 (Ed.6)?

The product standard **IEC60335-2-40 (Ed.6)** specifies the following:

- › The minimum room surface that needs to be respected, in function of the total refrigerant quantity of the system.
- › The measures that can be implemented to relax limitations on minimum room surface in relation to the system's total refrigerant charge.

Possible measures towards flammability

- › Manufacturers have the choice to implement zero, one or two measures
- › 3 types of measures are allowed:
 - › Ventilation (natural or mechanical)
 - › Shut-off valves
 - › Alarm (local and supervisor)

The true flexibility of a system is highly depending on keeping the considerations needed to select, install and maintain a system to the minimum. **Daikin has 2 factory-integrated measures, undertaking full responsibility about compliance to product standard and offering maximum flexibility if some simple installation requirements are respected.**

Overview of room area limitation by EN378:2016 and IEC60335-2-40 (Ed.6)

Overview of minimum room surface in function of applied measures under IEC60335-2-40 (Ed.6), considering units are installed at minimum 1.8 m height and above the lowest underground floor.

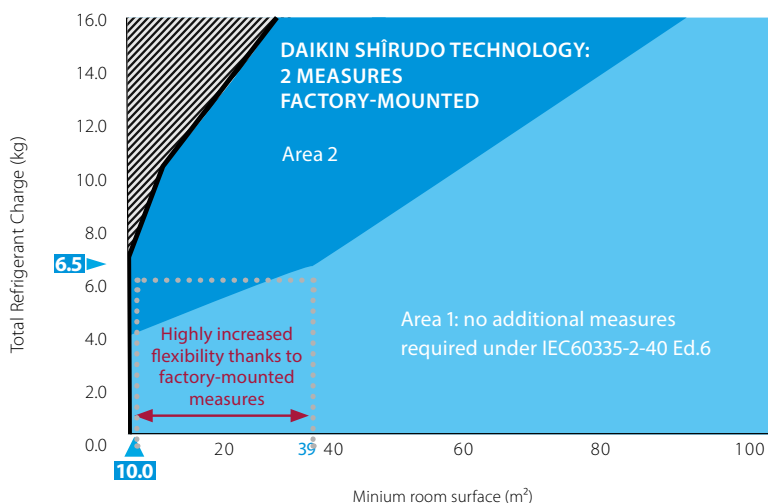

Area 1: application area without any measures

- › Typically split and Sky Air systems fall in this area thanks to very low refrigerant charges.
- › A typical mini VRV installation, with 6.5 kgs of refrigerant would require a minimum room surface of **39 m²**

Area 2: application area with 2 measures integrated

- › Daikin Shirudo technology enables to use the VRV system to its full potential with a minimum room surface down to **10 m²** (1)

(1) For applications below 10 m² contact your local Daikin representative.

- ▨ Reaction time of Daikin VRV 5 system
- Extended application area of VRV 5
- ⋯ Refrigerant charge for a typical mini VRV installation with 90~110m pipe length
- Application area without any measures

Taking care

of every room in your building

With Shirudo technology your VRV 5 system takes care of any room down to 10 m², without the need for time consuming selections and additional measures to be taken in the field.

With all measures factory-integrated, VRV 5 is the most flexible and quick to design, fully compliant to the latest product standards.

Maximum flexibility out of the box

- › Install in rooms down to **10 m²** (1)
- › Flexible design as any other VRV system
- › WebXpress selection software ensures compliance to the latest product standards

All refrigerant control measures factory-integrated

Shirudo technology includes 2 factory measures and sensors built into a VRV 5 system.

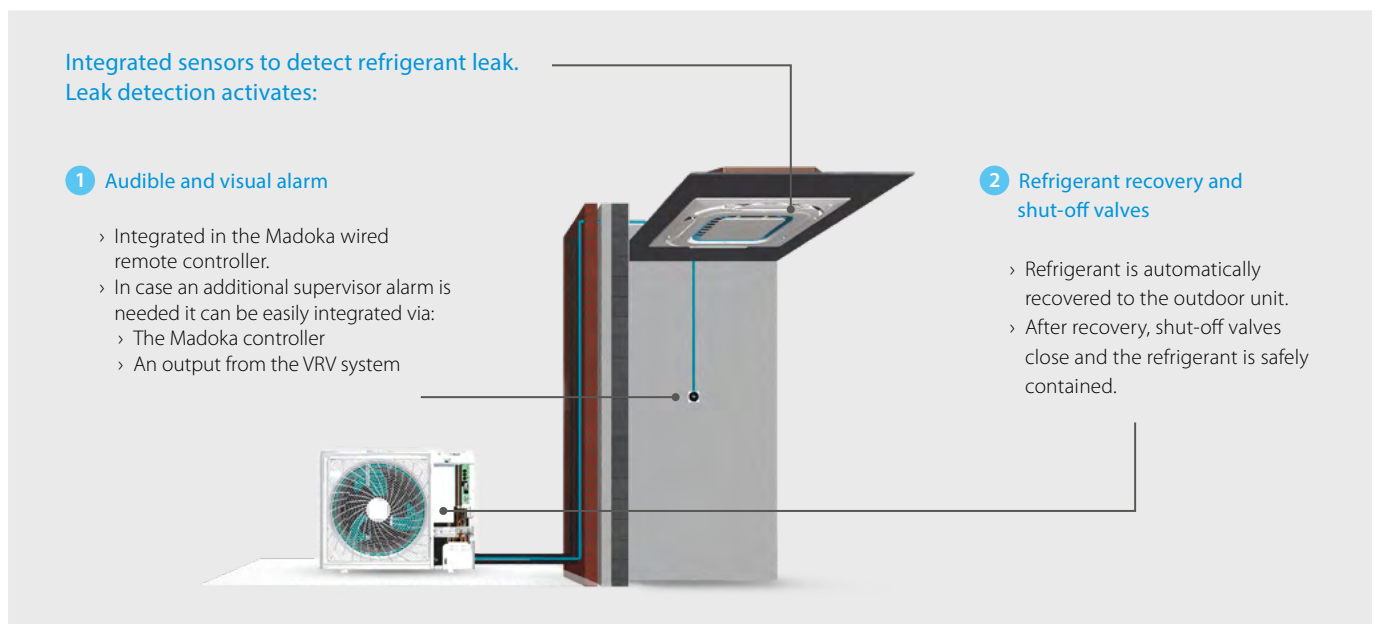

Compliance taken care of for you

- › No study or calculations needed, where and how to install outdoor unit, indoor units or piping
- › No need to design and install flammability measures
- › Third party CB certified by a Notified Body (SGS CEBC)

No liability is transferred on consultant or installer side!

Automatic, real time leak detection and refrigerant recovery

- › No leak check requirement for majority of installations (up to 7,4 kg of refrigerant charge).
- › Fully compliant to product standard (IEC60335-2-40), minimizing the risk of direct CO₂ eq. impact from a refrigerant leak.
- › Continuously self monitored system immediately detects any refrigerant leak. When a leak is detected, an alarm is activated to notify tenants and refrigerant is automatically recovered.

Check here how flexible the VRV 5 is!







Scan or click

VRV 5 outdoor unit overview

Model	Product name	Capacity class (kW)			
		4	5	6	
Air-cooled heat pump UNIQUE VRV 5 S-series Lower CO2 equivalent and market-leading flexibility > Compact single fan design saves space and is easy to install > Market-leading serviceability and handling > Reduced CO2 equivalent thanks to the use of lower GWP R-32 refrigerant and lower refrigerant charge > Tackle small room applications without any additional measures, thanks to Shirudo technology	RXYSA-AV1 / AY1 	1~	•	•	•
		3~	•	•	•



VRV 5 indoor unit overview

Type Model	Product name	Capacity class (kW)												
		10	15	20	25	32	40	50	63	71	80	100	125	140
Ceiling mounted cassette UNIQUE Round flow cassette 360° air discharge for optimum efficiency and comfort > Auto cleaning function ensures high efficiency > Intelligent sensors save energy and maximize comfort > Flexibility to suit every room layout > Lowest installation height in the market! > Widest choice ever in decoration panel designs and colors UNIQUE Fully flat cassette Unique design that integrates fully flat into the ceiling > Perfect integration in standard architectural ceiling tiles > Blend of iconic design and engineering excellence > Intelligent sensors save energy and maximize comfort > Small capacity unit developed for small or well-insulated rooms > Flexibility to suit every room layout	ROUND FLOW  FXFA-A			•	•	•	•	•	•	•	•	•	•	
	FXZA-A 			•	•	•	•	•	•					
Concealed ceiling Slim concealed ceiling unit Slim design for flexible installation > Compact dimensions enable installation in narrow ceiling voids > Medium external static pressure up to 44Pa > Only grilles are visible > Small capacity unit developed for small of well-insulated rooms > Reduced energy consumption thanks to DC fan motor Concealed ceiling unit with medium ESP Slimmest yet most powerful medium static pressure unit on the market! > Slimmest unit in class, only 245mm > Low operating sound level > Medium external static pressure up to 150Pa facilitates using flexible ducts of varying lengths > Automatic air flow adjustment function measures the air volume and static pressure and adjusts it towards the nominal air flow, guaranteeing comfort	UNIQUE FOR R-32  FXDA-A	•	•	•	•	•	•	•	•					
	 FXSA-A		•	•	•	•	•	•	•	•	•	•	•	•
Wall mounted Wall mounted unit For rooms with no false ceilings nor free floor space > Flat, stylish front panel is more easy to clean > Small capacity unit developed for small of well-insulated rooms > Reduced energy consumption thanks to DC fan motor > The air is comfortably spread up- and downwards thanks to 5 different discharge angles	 FXAA-A			•	•	•	•	•	•	•				
Cooling capacity (kW) ¹		1.1	1.7	2.2	2.8	3.6	4.5	5.6	7.1	8.0	9.0	11.2	14.0	16.0
Heating capacity (kW) ²		1.3	1.9	2.5	3.2	4.0	5.0	6.3	8.0	9.0	10.0	12.5	16.0	18.0



























Black and designer panels

Auto cleaning filter option

(1) Nominal cooling capacities are based on: indoor temperature: 27°CDB, 19°CWB, outdoor temperature: 35°CDB, equivalent refrigerant piping: 5m, level difference: 0m
 (2) Nominal heating capacities are based on: indoor temperature: 20°CDB, outdoor temperature: 7°CDB, 6°CWB, equivalent refrigerant piping: 5m, level difference: 0m



VRV 5 indoor unit benefit overview

			Ceiling mounted cassette units		Concealed ceiling units		Wall mounted unit
			FXFA-A	FXZA-A	FXDA-A	FXSA-A	FXAA-A
							
We care	 Home leave operation	During absence, indoor comfort levels can be maintained	●	●	●	●	●
	 Fan only	The air conditioner can be used as fan, blowing air without cooling or heating	●	●	●	●	●
	 Auto cleaning filter	The filter automatically cleans itself. Simplicity of upkeep means optimum energy efficiency and maximum comfort without the need for expensive or time-consuming maintenance	● (optional)		● (optional)		
	 Floor and presence sensor	The presence sensor directs the air away from any person detected in the room. The floor sensor detects the average floor temperature and ensures an even temperature distribution between ceiling and floor	●	●			
Comfort	 Draught prevention	When starting to warm up or when the thermostat is off, the air discharge direction is set horizontally and the fan to low speed, to prevent draught. After warming up, air discharge and fan speed are set as desired	●	●			
	 Whisper quiet	Daikin indoor units are whisper quiet. Also the outdoor units are guaranteed not to disturb the quiet of the neighbourhood	●	●	●	●	
	 Auto cooling-heating changeover	Automatically selects cooling or heating mode to achieve the set temperature	●	●	●	●	●
Air treatment	 Air filter	Removes airborne dust particles to ensure a steady supply of clean air	G1(2) (G3 (2) in case of auto cleaning panel)	G1(2)	●	G1(2)	●
Humidity control	 Dry programme	Allows humidity levels to be reduced without variations in room temperature	●	●	●	●	●
Air flow	 Ceiling soiling prevention	The air discharge of the indoor unit is specially designed to prevent air being blown against the ceiling to prevent ceiling stains	●	●			
	 Vertical auto swing	Possibility to select automatic vertical moving of the air discharge louvre, for uniform air flow and temperature distribution	●	●			●
	 Fan speed steps	Multiple fan speeds to select, to optimize comfort levels	5 + auto	3 + auto	3	3 + auto	3
	 Individual louver control	Individual louver control via the wired remote controller makes it simple to fix the position of each louver individually, to suit any new room configuration. Optional closure kits are available as well	●	●			
Remote control & timer	 Daikin residential controller (BRP069C51) NEW	Can control and monitor the status of your Daikin heating or air conditioning system	●	●	●	●	●
	 Weekly timer	Timer can be set to start and stop operation anytime on a daily or weekly basis	●	●	●	●	●
	 Infrared remote control	Infrared remote control with LCD to remotely control your indoor unit	● (1)	● (1)	● (1)	● (1)	● (1)
	 Wired remote control	Wired remote control to remotely control your indoor unit	Only connectable to new BRC1H52W/S/K				
	 Centralised control	Centralised control to control several indoor units from one single point	●	●	●	●	●
Other functions	 Auto-restart	The unit restarts automatically at the original settings after power failure	●	●	●	●	●
	 Self-diagnosis	Simplifies maintenance by indicating system faults or operating anomalies	●	●	●	●	●
	 Drain pump kit	Facilitates condensation draining from the indoor unit	Standard	Standard	Standard	Standard	Optional
	 Multi tenant	The indoor unit's main power supply can be turned off when leaving the building or for servicing purposes	●	●	●	●	●

(1) Must be combined with Madoka wired remote controller.

(2) Filter grade category are an indication, filters are not certified.

Next generation **VRV**



New asymmetric fan design

- › Two high ESP settings
- › Low sound levels



New casing design with 4 handles for easy carrying

Compact dimensions

- › Easy to transport thanks to compact size and single-fan design

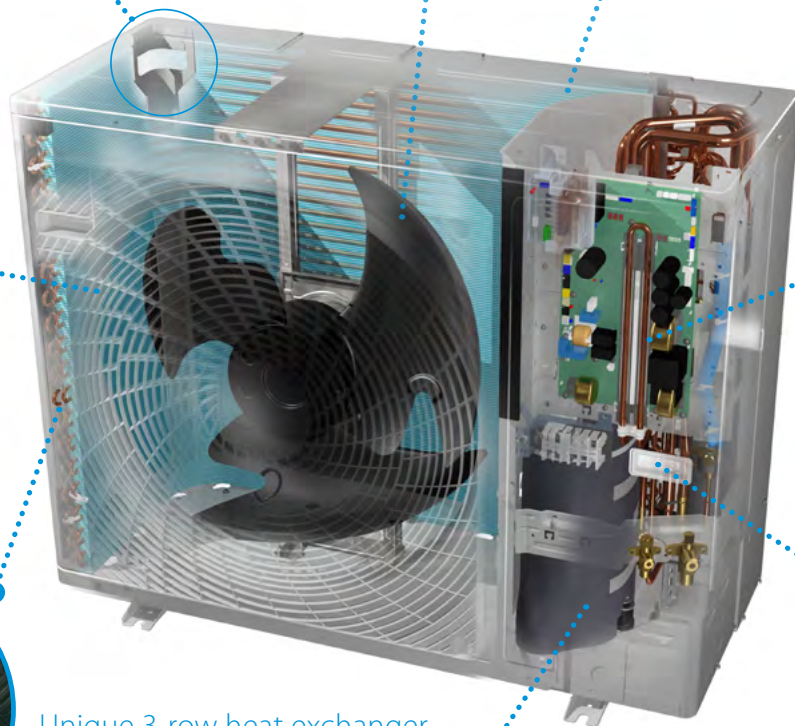
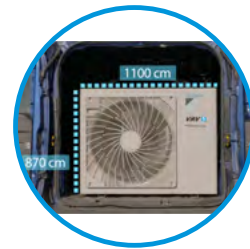

Specially designed grille

- › Low pressure drop
- › No risk for accidental reach of the fan

Refrigerant cooled PCB

With integrated:

- › cool/heat selector input
- › 7-segment display for quicker and more precise error and setting reading

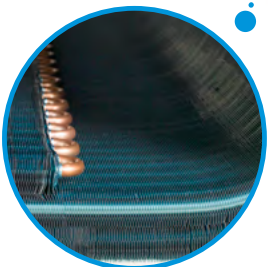

Unique 3-row heat exchanger

- › Contributes to top seasonal efficiency

New stop valves

- › Repositioned to allow front or side connection
- › Brazed for increased reliability

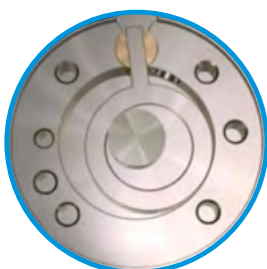

Unique Daikin swing compressor

- › No abrasion possible
- › No refrigerant leak possible
- › High seasonal efficiencies

VRV 5 S-series

Lower CO₂ equivalent and market-leading flexibility

- › Reduced CO₂ equivalent thanks to the use of lower GWP R-32 refrigerant and lower refrigerant charge
- › Top sustainability over the entire lifecycle, thanks to market leading real-life seasonal efficiency
- › Low-height single fan range
- › Easy to transport thanks to lightweight and compact design
- › Wide access area to easily reach all key components
- › Tackle small room applications without any additional measures, thanks to Shīrudo technology
- › Specially designed indoor units for R-32, ensuring low sound and maximum efficiency



Only **869mm** high!

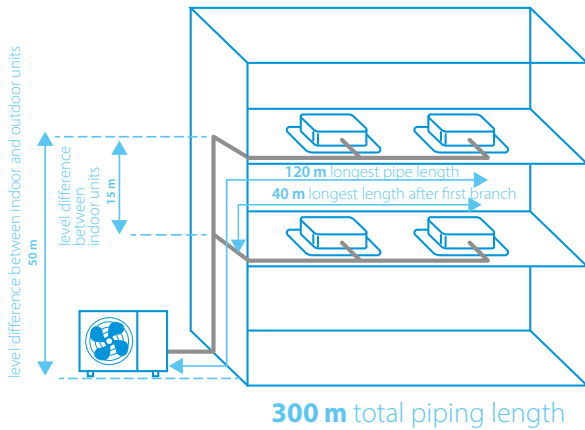

300 m total piping length

Access all technical information on RXYSA-AV1/AY1 at my.daikin.eu or click here

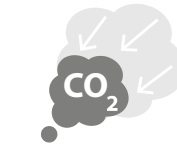

Reduced CO₂ equivalent



Flexibility to take care of every room



Already fully compliant to LOT 21 - Tier 2

Published data with real-life indoor units

Outdoor unit				RXYSA4AV1	RXYSA5AV1	RXYSA6AV1	RXYSA4AY1	RXYSA5AY1	RXYSA6AY1
Capacity range		HP		4	5	6	4	5	6
Cooling capacity	Prated,c	kW		12.1	14.0	15.5	12.1	14.0	15.5
Heating capacity	Prated,h	kW		8.4	9.7	10.7	8.4	9.7	10.7
	Max.	6°CWB	kW	14.2	16.0	18.0	14.2	16.0	18.0
Recommended combination				3xFXSA25A2VEB + 1xFXSA32A2VEB	4xFXSA32A2VEB	2xFXSA32A2VEB + 2xFXSA40A2VEB	3xFXSA25A2VEB + 1xFXSA32A2VEB	4xFXSA32A2VEB	2xFXSA32A2VEB + 2xFXSA40A2VEB
ηs,c		%		324.5	306.1	301.0	312.5	294.8	289.9
ηs,h		%		200.5	185.7	183.6	193.1	178.8	176.8
SEER				8.2	7.7	7.6	7.9	7.4	7.3
SCOP				5.1	4.7	4.7	4.9	4.5	4.5
Maximum number of connectable indoor units				13 (1)	16 (1)	18 (1)	13 (1)	16 (1)	18 (1)
Indoor index connection	Min.			50	62.5	70	50	62.5	70
	Nom.			100	125	140	100	125	140
	Max.			130	162.5	182	130	162.5	182
Dimensions	Unit	HeightxWidthxDepth	mm	869x1,100x460					
Weight	Unit		kg	102					
Sound power level	Cooling	Nom.	dBA	67	68.1	69	67	68.1	69
	Heating	Nom.	dBA	68	69.2	70	68	69.2	70
	Heating	According to ENER LOT21		57	59	60	57	59	60
Sound pressure level	Cooling	Nom.	dBA	49	51	51	49	51	51
	Heating	Nom.	dBA	50	52	52	50	52	52
Operation range	Cooling	Min.~Max.	°CDB	-5.0 ~ 46.0					
	Heating	Min.~Max.	°CWB	-20.0 ~ 16					
Refrigerant	Type/GWP			R-32/675					
	Charge		kg/TCO2Eq	3.40 / 2.30					
Piping connections	Liquid	OD	mm	9.52					
	Gas	OD	mm	15.9					
	Total piping length	system	Actual	300					
	Height Difference	OU-IU	Outdoor unit in highest position	50					
		Indoor unit in highest position	40						
Power supply	Phase/Frequency/Voltage		Hz/V	1~/50/220-240			3~/50/380-415		
Current - 50Hz	Maximum fuse amps (MFA)		A	32			16		

(1) Actual number of units depends on the indoor unit type and the connection ratio restriction for the system (being 50% <= 130%)

The most comfortable cassette
just got better



New round flow cassette



- › **Bigger louvers** and **new sensor logic** further improves equal air distribution in the room
- › **Widest ever choice in panels** for cassette units, with up to 8 different panels

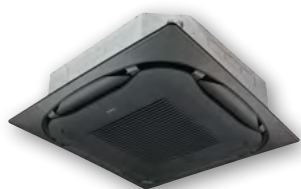

Black auto cleaning panel

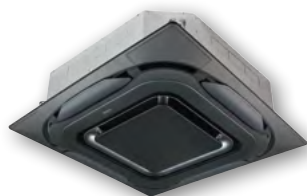

Black designer panel



Full white standard panel



White designer panel

- › Comes with the known benefits: **360° air flow discharge** and **intelligent sensors**



presence sensor floor sensor

- › **Auto cleaning** panels available in black and white

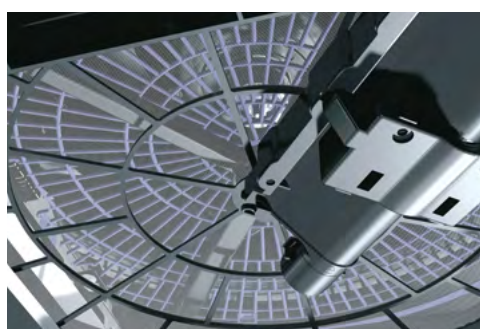

Auto cleaning filter

Dust can simply be removed using a vacuum cleaner without opening the unit.

* Available as an option

Round flow cassette

360° air discharge for optimum efficiency and comfort

- › Optimised design for R-32 refrigerant
- › Optional automatic filter cleaning results in higher efficiency & comfort and lower maintenance costs.
- › Two optional intelligent sensors improve energy efficiency and comfort
- › Widest choice ever in decoration panels: Designer, standard and autocleaning panels in white (RAL9010) and black (RAL9005)
- › Bigger louvers and unique swing pattern improve equal air distribution
- › Individual louver control: flexibility to suit every room layout without changing the location of the unit!
- › Lowest installation height in the market: 214mm for class 20-63
- › Optional fresh air intake
- › Branch duct discharge allows to optimize air distribution in irregular shaped rooms or to supply air to small adjacent rooms

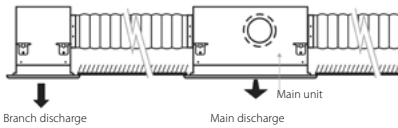

- › Standard drain pump with 675mm lift increases flexibility and installation speed

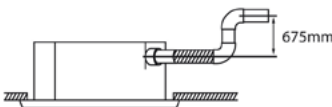

Access all technical information on FXFA-A at my.daikin.eu or click here

Indoor unit			FXFA	20A	25A	32A	40A	50A	63A	80A	100A	125A
Cooling capacity	Total capacity	at high fan speed	kW	2.20	2.80	3.60	4.50	5.60	7.10	9.00	11.20	14.00
			kW	2.50	3.20	4.00	5.00	6.30	8.00	10.00	12.50	16.00
Heating capacity	Total capacity	at high fan speed	kW	0.04			0.05		0.06	0.09	0.12	0.19
			kW	0.04			0.05		0.06	0.09	0.12	0.19
Power input - 50Hz	Cooling	at high fan speed	kW	0.04			0.05		0.06	0.09	0.12	0.19
	Heating	at high fan speed	kW	0.04			0.05		0.06	0.09	0.12	0.19
Dimensions	Unit	HeightxWidthxDepth	mm	204x840x840					246x840x840			288x840x840
Weight	Unit		kg	18		19		21		24		26
Casing	Material			Galvanised steel plate								
Decoration panel	Model			Standard panels: BYCQ140E - white with grey louvers / BYCQ140EW - full white / BYCQ140EB - black								
				Auto cleaning panels BYCQ140EGF - white / BYCQ140EGFB - black								
				Designer panels: BYCQ140EP - white / BYCQ140EPB - black								
	Dimensions	HeightxWidthxDepth	mm	Standard panels: 65x950x950 / Auto cleaning panels: 148x950x950 / Designer panels: 106x950x950					Standard panels: 5.5 / Auto cleaning panels: 10.3 / Designer panels: 6.5			
	Weight		kg	Standard panels: 5.5 / Auto cleaning panels: 10.3 / Designer panels: 6.5								
Fan	Air flow rate - 50Hz	Cooling	At high fan speed	m ³ /min	12.8	14.8	15.1	16.6	23.3	28.8	33.0	
		Heating	At high fan speed	m ³ /min	12.8	14.8	15.1	16.6	23.3	28.8	33.0	
Air filter	Type			Resin net								
Sound power level	Cooling	At high fan speed	dBA	49 (4)			51 (4)		53 (4)	55 (4)	60 (4)	61 (4)
	Heating	L/ML/M/MH/H	dBA	31/30/29/29.5/28 (4)			33/32/31/30/29 (4)		35/34/33/32/30 (4)	38/36/34/32/30 (4)	43/41/37/34/30 (4)	45/43/41/39/36 (4)
Sound pressure level	Cooling	L/ML/M/MH/H	dBA	31/30/29/29.5/28 (4)			33/32/31/30/29 (4)		35/34/33/32/30 (4)	38/36/34/32/30 (4)	43/41/37/34/30 (4)	45/43/41/39/36 (4)
	Heating	L/ML/M/MH/H	dBA	31/30/29/29.5/28 (4)			33/32/31/30/29 (4)		35/34/33/32/30 (4)	38/36/34/32/30 (4)	43/41/37/34/30 (4)	45/43/41/39/36 (4)
Refrigerant	Type/GWP			R-32 / 675								
Piping connections	Liquid	OD	mm	6.35					9.52			
	Gas	OD	mm	9.52		12.7			15.9			
	Drain			VP25 (O.D. 32 / I.D. 25)								
Power supply	Phase/Frequency/Voltage	Hz/V		1~/50/60/220-240/220								
Current - 50Hz	Maximum fuse amps (MFA) (1)	A		6								
Control systems	Infrared remote control			BRC7FA532F (2)								
	Wired remote control			BRC1H52W/S/K								

(1) MFA is used to select the circuit breaker and the ground fault circuit interrupter (earth leakage circuit breaker). For more detailed information on each combination, please refer to the electrical data drawing
 (2) Must be combined with Madoka wired remote controller.
 (3) L/ML/M/MH/H are the different fan speeds available. L= low; ML= medium low; M= medium; MH= medium high; H= high
 (4) Sound of designer panel: +3dB



Fully flat cassette

Unique design in the market that integrates fully flat into the ceiling

- › Optimised design for R-32 refrigerant
- › Fully flat integration in standard architectural ceiling tiles, leaving only 8mm
- › Remarkable blend of iconic design and engineering excellence with an elegant finish in white or a combination of silver and white
- › Two optional intelligent sensors improve energy efficiency and comfort
- › 15 class unit especially developed for small or well-insulated rooms, such as hotel bedrooms, small offices, etc.
- › Individual louver control: flexibility to suit every room layout without changing the location of the unit!

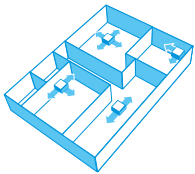

- › Optional fresh air intake
- › Standard drain pump with 630mm lift increases flexibility and installation speed

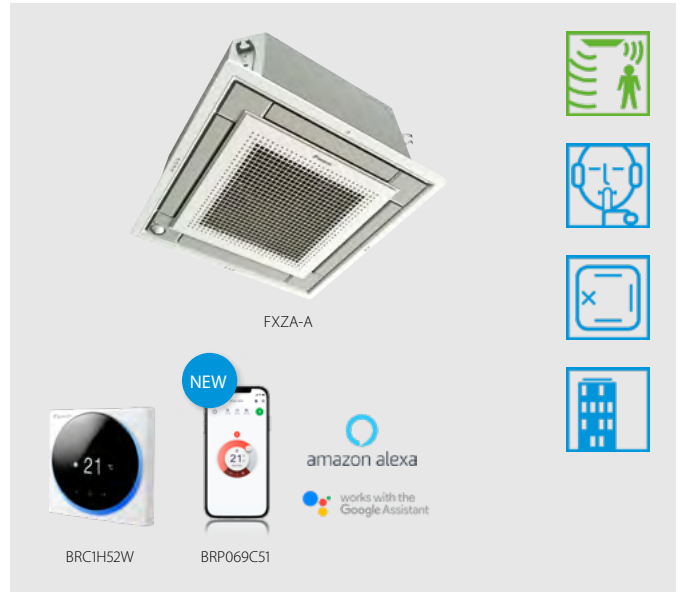
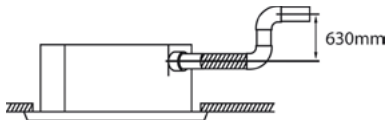

Access all technical information on FXZA-A at my.daikin.eu or click here

Indoor unit		FXZA	15A	20A	25A	32A	40A	50A		
Cooling capacity	Total capacity	At high fan speed	kW	1.70	2.20	2.80	3.60	4.50	5.60	
Heating capacity	Total capacity	At high fan speed	kW	1.90	2.50	3.20	4.00	5.00	6.30	
Power input - 50Hz	Cooling	At high fan speed	kW	0.043			0.045	0.059	0.092	
	Heating	At high fan speed	kW	0.043			0.045	0.059	0.092	
Dimensions	Unit	HeightxWidthxDepth	mm	260x575x575						
Weight	Unit		kg	15.5		16.5		18.5		
Casing	Material			Galvanised steel plate						
Decoration panel	Model			BYFQ60C2W1W						
	Colour			White (N9.5)						
	Dimensions	HeightxWidthxDepth	mm	46x620x620						
	Weight		kg	2.8						
Decoration panel 2	Model			BYFQ60C2W1S						
	Colour			SILVER						
	Dimensions	HeightxWidthxDepth	mm	46x620x620						
	Weight		kg	2.8						
Decoration panel 3	Model			BYFQ60B2W1						
	Colour			White (RAL9010)						
	Dimensions	HeightxWidthxDepth	mm	55x700x700						
	Weight		kg	2.7						
Decoration panel 4	Model			BYFQ60B3W1						
	Colour			WHITE (RAL9010)						
	Dimensions	HeightxWidthxDepth	mm	55x700x700						
	Weight		kg	2.7						
Fan	Air flow rate - 50Hz	Cooling	At high fan speed	m ³ /min	8.5	8.7	9.0	10.0	11.5	14.0
		Heating	At high fan speed	m ³ /min	8.5	8.7	9.0	10.0	11.5	14.0
Air filter	Type			Resin net						
Sound power level	Cooling	At high fan speed	dBA	49		50	51	54	60	
Sound pressure level	Cooling	Low/medium/high fan speed	dBA	25.5/28.0/31.5	25.5/29.5/32.0	25.5/30.0/33.0	26.0/30.0/33.5	28.0/32.0/37.0	33.0/40.0/43.0	
	Heating	Low/medium/high fan speed	dBA	25.5/28.0/31.5	25.5/29.5/32.0	25.5/30.0/33.0	26.0/30.0/33.5	28.0/32.0/37.0	33.0/40.0/43.0	
Refrigerant	Type/GWP			R-32 / 675						
Piping connections	Liquid	OD	mm	6.35						
	Gas	OD	mm	9.52			12.7			
	Drain			VP20 (I.D. 20/O.D. 26)						
Power supply	Phase/Frequency/Voltage			1~/50/60/220-240/220						
Current - 50Hz	Maximum fuse amps (MFA)			6						
Control systems	Infrared remote control			BRC7EB530W (standard panel) / BRC7F530W (white panel) / BRC7F530S (grey panel) (1)						
	Wired remote control			BRC1H52W/S/K						

Dimensions do not include control box

(1) Must be combined with Madoka wired remote controller.

Auto cleaning filter for concealed ceiling units



The unique automatic cleaning filter achieves higher efficiency and comfort with lower maintenance costs

Reduce running costs

- › Automatic filter cleaning ensures low maintenance costs because the filter is always clean

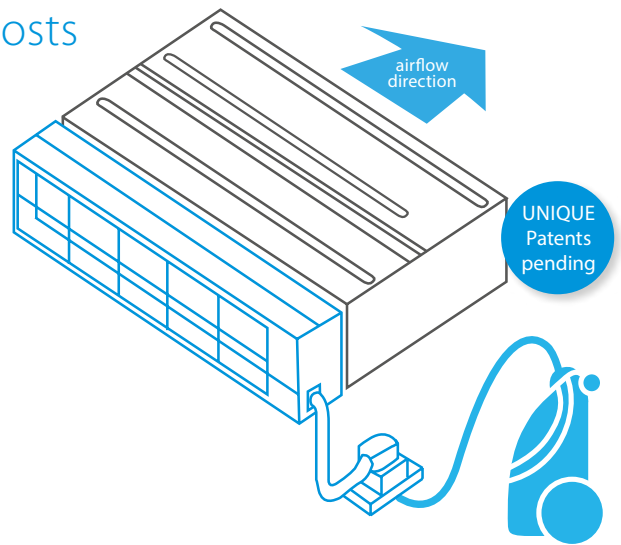
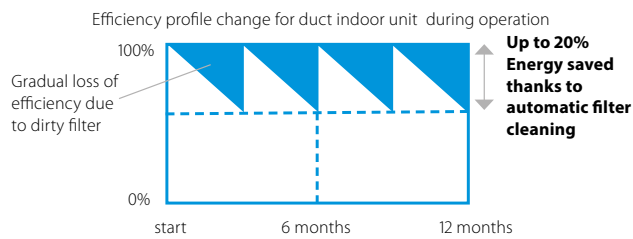

Minimal time required for filter cleaning

- › The dust box can be emptied with a vacuum cleaner for fast and easy cleaning
- › No more dirty ceilings

Improved indoor air quality

- › Optimum airflow eliminates draft and insulates sound

Superb reliability

- › Prevents clogged filters for seamless operation

Unique technology

- › Unique and innovative filter technology inspired by the Daikin auto cleaning cassette



Combination table

	Split / Sky Air				VRV						
	FDXM-F9				FXDA-A/FXDQ-A3						
	25	35	50	60	15	20	25	32	40	50	63
BAE20A62	•	•			•	•	•	•			
BAE20A82									•	•	
BAE20A102			•	•							•

How does it work?

- 1 Scheduled automatic filter cleaning
- 2 Dust collects in a dust box that's integrated into the unit
- 3 The dust can easily be removed with a vacuum cleaner



www.youtube.com/DaikinEurope



Specifications

	BAE20A62	BAE20A82	BAE20A102
Height (mm)	210		
Width (mm)	830	1,030	1,230
Depth (mm)	188		

Slim concealed ceiling unit

Slim design for flexible installation

- › Optimised design for R-32 refrigerant
- › 10 class unit especially developed for small or well-insulated rooms, such as hotel bedrooms, small offices, etc.
- › Compact dimensions, can easily be mounted in a ceiling void of only 240mm

SERIE A (15, 20, 25, 32)

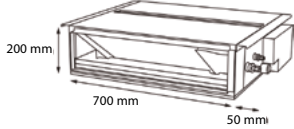

- › Medium external static pressure up to 44Pa facilitates unit use with flexible ducts of varying lengths
- › Discretely concealed in the wall: only the suction and discharge grilles are visible
- › Optional auto cleaning filter option ensures maximum efficiency, comfort and reliability by regular filter cleaning
- › Flexible installation, as the air suction direction can be altered from rear to bottom suction

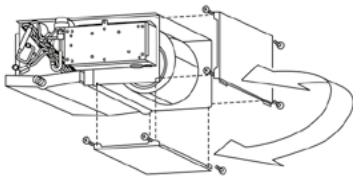

- › Standard drain pump with 600mm lift increases flexibility and installation speed

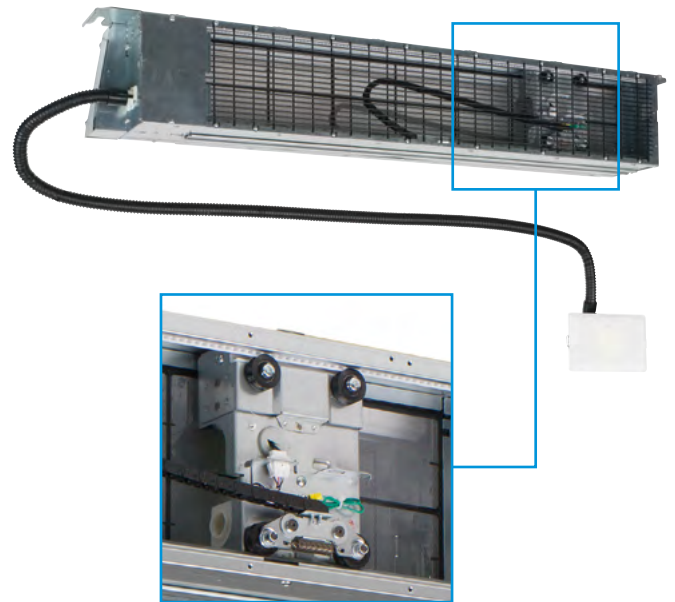
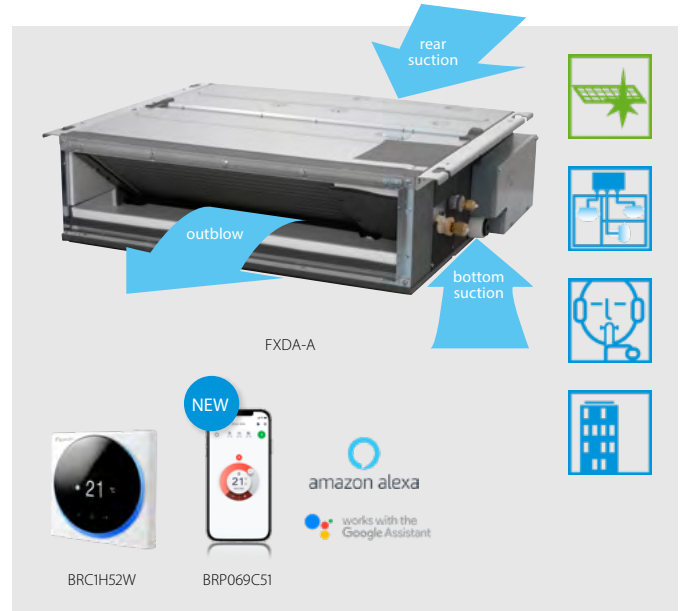
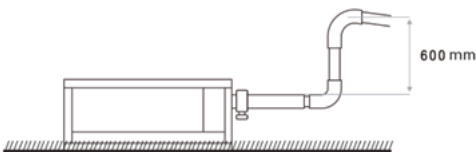

Auto cleaning filter option

Access all technical information on FXDA-A at my.daikin.eu or click here

Access all technical information on BAE20A at my.daikin.eu or click here

NEW

Indoor unit			FXDA	10A	15A	20A	25A	32A	40A	50A	63A	
Cooling capacity	Total capacity	At high fan speed	kW	1.10	1.70	2.20	2.80	3.60	4.50	5.60	7.10	
Heating capacity	Total capacity	At high fan speed	kW	1.30	1.90	2.50	3.20	4.00	5.00	6.30	8.00	
Power input - 50Hz	Cooling	At high fan speed	kW	0.042	0.057		0.068		0.075	0.096	0.107	
	Heating	At high fan speed	kW	0.042	0.057		0.068		0.075	0.096	0.107	
Required ceiling void >			mm	240								
Dimensions	Unit	HeightxWidthxDepth	mm	200x750x620				200x950x620		200x1,150x620		
Weight	Unit		kg	22.0				26.0		29.0		
Casing	Material			Galvanised steel								
Fan	Air flow rate - 50Hz	Cooling	At high fan speed	m ³ /min	5.2	6.5		8.0	10.5	12.5	16.5	
	External static pressure - 50Hz	Factory set/High pressure	Pa	10/30.0				15/44.0				
Air filter	Type			Removable / washable								
Sound power level	Cooling	At high fan speed	dB(A)	48	50		51		52	53	54	
	Low/Medium/High fan speed		dB(A)	26 / 28 / 29	27.0/31.0/32.0		27.0/31.0/33.0		28.0/32.0/34.0	29.0/33.0/35.0	30.0/34.0/36.0	
Refrigerant	Type/GWP			R-32 / 675								
Piping connections	Liquid	OD	mm	6.35								
	Gas	OD	mm	9.52				12.7				
	Drain			VP20 (I.D. 20/O.D. 26)								
Power supply	Phase/Frequency/Voltage		Hz/V	1~/50/60/220-240/220								
Current - 50Hz	Maximum fuse amps (MFA)		A	6								
Control systems	Infrared remote control			BRC4C65 / BRC4C66 (1)								
	Wired remote control			BRC1H52W/S/K								

(1) Must be combined with Madoka wired remote controller.

Concealed ceiling unit with medium ESP

Slimmest yet most powerful medium static pressure unit on the market

- Optimised design for R-32 refrigerant
- Slimmest unit in class, only 245mm (300mm built-in height) and therefore narrow ceiling voids are no longer a challenge



- Quiet operation: down to 25dBA sound pressure level
- Medium external static pressure up to 150Pa facilitates using flexible ducts of varying lengths
- Possibility to change ESP via wired remote control allows optimisation of the supply air volume
- Discretely concealed in the wall: only the suction and discharge grilles are visible
- 15 class unit especially developed for small or well-insulated rooms, such as hotel bedrooms, small offices, etc.
- Optional fresh air intake
- Flexible installation: air suction direction can be altered from rear to bottom suction and choice between free use or connection to optional suction grilles

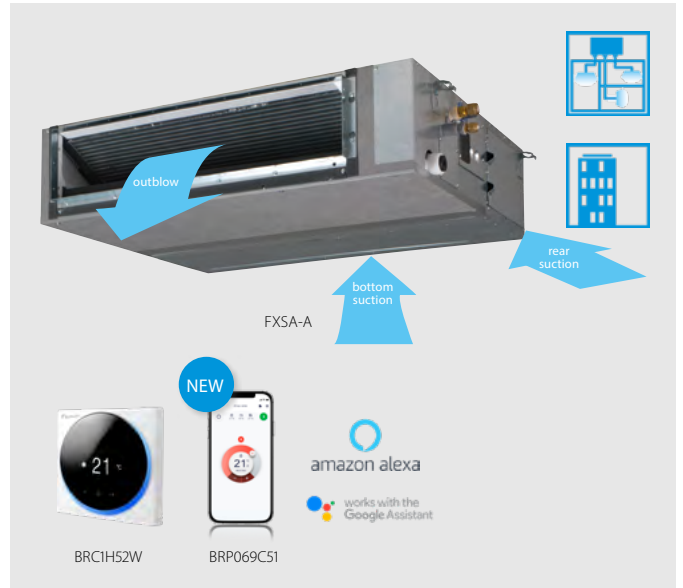

- Standard built-in drain pump with 625mm lift increases flexibility and installation speed

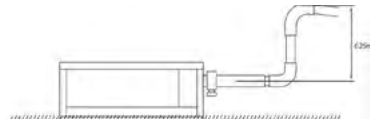

Automatic Airflow Adjustment function

Automatically selects the most appropriate fan curve to achieve the units' nominal air flow within ±10%

Why?

After installation the real ducting will frequently differ from the initially calculated air flow resistance * the real air flow may be much lower or higher than nominal, leading to a lack of capacity or uncomfortable air temperature. Automatic Airflow Adjustment function will adapt the unit's fan speed to any ducting automatically (10 or more fan curves are available on every model), making installation much faster.

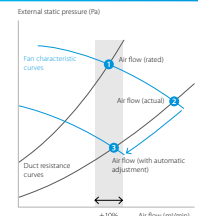

Access all technical information on FXSA-A at my.daikin.eu or click here

Indoor unit				FXSA	15A	20A	25A	32A	40A	50A	63A	80A	100A	125A	140A
Cooling capacity	Total capacity	At high fan speed	kW	1.70	2.20	2.80	3.60	4.50	5.60	7.10	9.00	11.20	14.00	16.00	
	Heating capacity	Total capacity	At high fan speed	kW	1.90	2.50	3.20	4.00	5.00	6.30	8.00	10.0	12.5	16.0	18.0
Power input - 50Hz	Cooling	At high fan speed	kW	0.086				0.147	0.150	0.183	0.209	0.285	0.326	0.382	
	Heating	At high fan speed	kW	0.086				0.147	0.150	0.183	0.209	0.285	0.326	0.382	
Dimensions	Unit	HeightxWidthxDepth	mm	245x550x800				245x700x800			245x1,000x800		245x1,400x800		245x1,550x800
Weight	Unit		kg	23.5			24.0	28.5	29.0	35.5	36.5	46.0	47.0	51.0	
Casing	Material			Galvanised steel plate											
Fan	Air flow rate - 50Hz	Cooling	At high fan speed	m ³ /min	8.7	9.0	9.5	15.0	15.2	21.0	23.0	32.0	36.0	39.0	
		Heating	At high fan speed	m ³ /min	8.7	9.0	9.5	15.0	15.2	21.0	23.0	32.0	36.0	39.0	
	External static pressure - 50Hz	Factory set/High	Pa	30/150				40/150			50/150				
Air filter	Type			Resin net											
Sound power level	Cooling	At high fan speed	dBA	54			55	60	59	61			64		
	Low/Medium/High		dBA	25.0/28.0/29.5	25.0/28.0/30.0	26.0/29.0/31.0	29.0/32.0/35.0	27.0/30.0/33.0	29.0/32.0/35.0	31.0/34.0/36.0	33.0/36.0/39.0	34.0/38.0/41.5			
Sound pressure level	Cooling	Low/Medium/High	dBA	26.0/29.0/31.5	26.0/29.0/32.0	27.0/30.0/33.0	29.0/34.0/37.0	28.0/32.0/35.0	30.0/34.0/37.0	31.0/34.0/37.0	33.0/37.0/40.0	34.0/38.5/42.0			
	Heating	Low/Medium/High	dBA	R-32 / 675											
Refrigerant	Type/GWP			R-32 / 675											
	Liquid	OD	mm				6.35						9.52		
	Gas	OD	mm				9.52			12.7			15.9		
Piping connections	Drain			VP20 (I.D. 20/O.D. 26), drain height 625 mm											
Power supply	Phase/Frequency/Voltage		Hz/V	1~/50/60/220-240/220											
Current - 50Hz	Maximum fuse amps (MFA)		A	6											
Control systems	Infrared remote control			BRC4G5 (1)											
	Wired remote control			BRC1H52W/S/K											

(1) Must be combined with Madoka wired remote controller.

Wall mounted unit

For rooms with no false ceilings nor free floor space

- › Optimised design for R-32 refrigerant
- › Flat, stylish front panel blends easily within any interior décor and is easier to clean
- › Can easily be installed in both new and refurbishment projects
- › The air is comfortably spread up- and downwards thanks to 5 different discharge angles that can be programmed via the remote control
- › Maintenance operations can be performed easily from the front of the unit



 Access all technical information on FXAA-A at my.daikin.eu or [click here](#)

Indoor unit				FXAA	15A	20A	25A	32A	40A	50A	63A
Cooling capacity	Total capacity	At high fan speed		kW	1.7	2.2	2.8	3.6	4.5	5.6	7.1
		At high fan speed		kW	1.9	2.5	3.2	4.0	5.0	6.3	8.0
Heating capacity	Total capacity	At high fan speed		kW	0.017	0.019	0.028	0.030	0.025	0.033	0.050
		At high fan speed		kW	0.025	0.029	0.034	0.035	0.030	0.039	0.060
Dimensions	Unit	HeightxWidthxDepth		mm	290x795x266				290x1,050x269		
Weight	Unit			kg	15				18.5		
Fan	Air flow rate - 50Hz	Cooling	Low/High fan speed	m ³ /min	6.5/7.1	6.5/7.9	6.5/8.3	6.5/9.4	9.8/12.2	10.9/14.2	12.9/18.2
Air filter	Type	Washable resin net									
Sound power level	Cooling	At high fan speed		dBA	51.0	52.0	53.0	55.0	58.0	63.0	
		Low/Medium/High		dBA	28.5/30.5/32.0	28.5/31.0/33.0	28.5/32.0/35.0	28.5/33.0/37.5	33.5/35.5/37.0	35.5/38.5/41.0	38.5/42.5/46.5
Sound pressure level	Heating	Low/Medium/High		dBA	28.5/31.0/33.0	28.5/31.5/34.0	28.5/32.5/36.0	28.5/33.5/38.5	33.5/36.0/38.0	35.5/39.0/42.0	38.5/43.0/47.0
Refrigerant	Type/GWP	R-32 / 675									
Piping connections	Liquid	OD	mm		6.35						
					Gas	OD	mm	9.52			
	Drain				VP13 (I.D. 15/O.D. 18)						
Power supply	Phase/Frequency/Voltage			Hz/V	1~/50/220-240						
Current - 50Hz	Maximum fuse amps (MFA)			A	6						
Control systems	Infrared remote control				BRC7EA630 (1)						
	Wired remote control				BRC1H52W/S/K						

(1) Must be combined with Madoka wired remote controller. | Contains fluorinated greenhouse gases

Outdoor units

		VRV S-series
		RXYS-AV1/AY1
	Heater tape kit - Optional electrical heater to guarantee trouble-free operation in extremely cold and humid climates (one per outdoor unit needed)	EKBPH250D
Adapters	External control adapter for outdoor unit - Allows to activate Low Noise Operation and three levels of demand control, limiting power consumption via external dry contacts. Connects to the F1/F2 communication line and requires power supply from an indoor unit, BSVQ box, or VRV-WiLL outdoor unit.	DTA104A53/61/62 - For installation into an indoor unit: exact adapter type depends on type of indoor unit. For 14-20 HP the demand PCB mounting plate is required. See Options & Accessories of indoor units
	KRC19-26A - Mechanical cool/heat selector – allows to switch an entire Heat Pump system, or one BS-box of a Heat Recovery system between cooling, heating and fan only. Connects to the A-B-C terminals of the outdoor unit / BS-box.	•
	Cool/heat selector PCB (required to connect KRC19-26A)	Standard on unit
Others	KJB111A - Installation box for remote cool/heat selector KRC19-26A	•
	EKPCAB4 - VRV configurator	•

Indoor units

		Ceiling mounted cassette units		Concealed ceiling units (duct units)
		Round flow (800x800)	4-way (600x600)	Slim
		FXFA-A	FXZA-A	FXDA-A
Panels	Decoration panel (obligatory for cassette units, optional for others, rear panel for FXLQ)	Standard panels: BYCQ140E (white) / BYCQ140EW (full white)(3) / BYCQ140EB (black) Auto cleaning (5)(6): BYCQ140EGF (white) / BYCQ140EGFB (black) Designer panels: BYCQ140EP (white) / BYCQ140EPB (black)	BYFQ60C4W1W (white panel) (19) / BYFQ60C4W1S (grey panel) (19) / BYFQ60B3W1 (standard panel) (20)	
	Panel spacer for reducing required installation height		KDBQ44B60 (standard panel)	
	Sealing kit for 3- or 2-directional air discharge	KDBHQ56B140 (7)	BDBHQ44C60 (white & grey panel)	
Individual control systems	Sensor kit	BRYQ140B (white panels) BRYQ140BB (black panels) BRYQ140C (white designer panel) BRYQ140CB (black designer panel)	R-32 models: BRYQ60A3W (white) / BRYQ60A3S (grey)	
	Infrared remote control (incl. receiver)	BRC7FA532F (white panels) / BRC7FA532FB (black panels) BRC7FB532F (white designer panel) / BRC7FB532FB (black designer panel)	BRC7F530W (9) (10) (white panel) / BRC7F530S (9) (10) (grey panel) / BRC7EB530W (9) (10) (standard panel)	BRC4C65
	BRP069C51 - Online controller	•	•	•
Centralised control systems	Madoka - BRCH52W (White) / BRCH52S (Silver) / BRCH52K (Black) - User-friendly wired remote controller with premium design	• (mandatory for R-32)	• (mandatory for R-32)	• (mandatory for R-32)
	BRC1E53A/B/C - Wired remote control with full-text interface and back-light	• (18)	• (18)	• (18)
	BRC1D52 (4) - Standard wired remote control with weekly timer	• (15) (18)	• (18)	• (18)
	DCC601A51 - Intelligent Tablet Controller	•	•	•
	DCS601C51 (12) - Intelligent Touch Controller	•	•	•
Building Management System & Standard protocol interfaces	DCS302C51 (12) - Central remote controller	•	•	•
	DCS301B51 (12) (13) - Unified ON/OFF controller	•	•	•
	DST301B51 (12) - Schedule timer	•	•	•
	RTD-NET - Modbus interface for monitoring and control	•	•	•
	RTD-10 - Modbus interface for infrastructure cooling	•	•	•
	RTD-20 - Modbus interface for retail	•	•	•
	RTD-HO - Modbus interface for hotel	•	•	•
	KLIC-DI - KNX Interface	•	•	•
	DCM601A51 - Intelligent Touch Manager	•	•	•
	EKMBOX - Modbus interface	•	•	•
Filters	DCM010A51 - Daikin PMS interface	•	•	•
	DMS502A51 - BACnet Interface	•	•	•
	DMS504B51 - LonWorks Interface	•	•	•
	Replacement long life filter, non-woven type	KAFP551K160	KAFQ441BA60	15-32: BAE20A62 / 40-50: BAE20A82 / 63: BAE20A102
Wiring and sensors	Auto cleaning filter	see decoration panel		
	KRCS - External wired temperature sensor	KRCS01-7B	KRCS01-8B	KRCS01-8B
Adapters	K.RSS - External wireless temperature sensor	SB.K.RSS_RFC (EKEWTSC-2 + K.RSS)	SB.K.RSS_FDA (EKEWTSC-1 + K.RSS)	SB.K.RSS_FDA (EKEWTSC-1 + K.RSS)
	Adapter with 2 output signals (Compressor / Error, Fan output)	KRP1BA58 (2)(7)	ERP02A50 (2)	
	Adapter with 4 output signals (Compressor / Error, Fan, Aux. heater, Humidifier output)	EKR1C12 (2)(7)	EKR1C14 (2)	ERP02A50
	Adapter for centralised external monitoring/control via dry contacts and setpoint control via 0-140Q	KRP4A53 (2)(7)	KRP4A53 (2)	KRP4A54-9
	Adapter for external central monitoring/control (controls 1 entire system)		KRP2A52	KRP2A53
	Adapter for keycard and/or window contact connection (2)(11)	BRP7A53	BRP7A53	BRP7A54
	External control adapter for outdoor unit (installation on indoor unit)			DTA104A53
	Installation box / Mounting plate for adapter PCBs (For units where there is no space in the switchbox)	KRP1H98A (7) KRP1BC101	KRP1BB101 KRP1BC101	KRP1BB101
	Wiring kit for Remote ON/OFF or Forced OFF	Standard	Standard	
	Relay PCB for output signal of refrigerant sensor	ERP01A51	ERP01A50 (2)	ERP01A51
Others	Drain pump kit	Standard	Standard	Standard
	Fresh air intake kit (direct installation type)	KDDP55C160-1 + KDDP55D160-2 (7)(8)	KDDQ44XA60	
	Air discharge adapter for round duct			

(1) Pump station is necessary for this option.

(2) Installation box is necessary for these adapters.

(3) The BYCQ140EW has white insulation. Be informed that formation of dirt on white insulation is visibly stronger and that it is consequently not advised to install the BYCQ140EW decoration panel in environments exposed to concentrations of dirt.

(4) Not recommended because of the limitation of the functions.

(5) To be able to control the BYCQ140EGF(B) the controller BRC1E or BRC1H* is needed.

(6) The BYCQ140EGF(B) is not compatible with Multi and Split Non-Inverter Outdoor units.

(7) Option not available in combination with BYCQ140EGF(B).

(8) Both parts of the fresh air intake are needed for each unit.

(9) Cannot be combined with sensor kit.

(10) Independently controllable flaps function not available.

Technical drawings

Outdoor units

RXYSA-AV1/AY1 23

FXFA-A 27

FXZA-A 29

FXDA-A 30

FXSA-A 32



FXAA-A 35

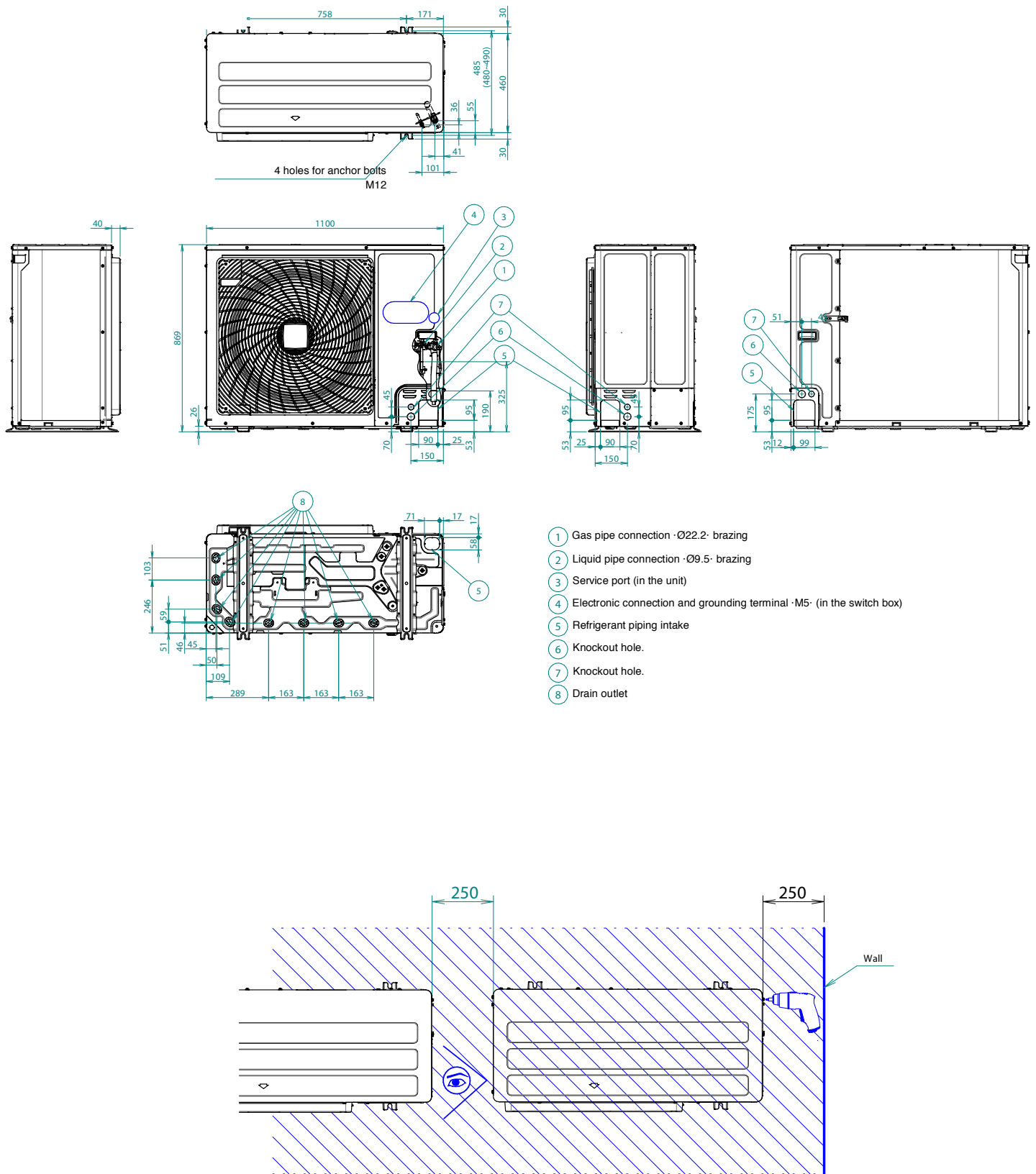

RXYSA-AV1/AY1



* For optimal serviceability, provide ≥ 250 -mm of free space.
 For more installation and service space guidelines, see drawing ·3D069554·.

Single unit () | Single row of units ()



Suction side

In the illustration below, the service space at the suction side is based on 35°C DB and cooling operation. Foresee more space in the following cases:

- When the suction side temperature regularly exceeds this temperature.
- When the heat load of the outdoor units is expected to regularly exceed the maximum operating capacity.

Discharge side

Take refrigerant piping work into account when positioning the units. If your lay out does not match with any of the layouts below, contact your dealer.

Single unit () | Single row of units ()

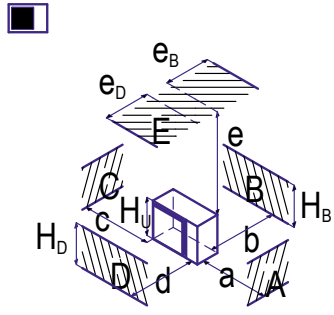
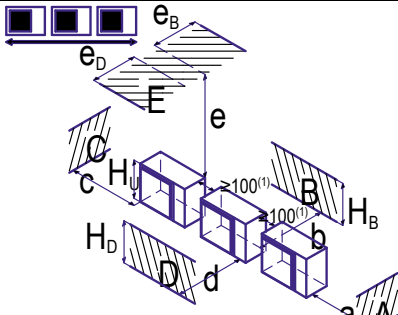
	A-E	Hb Hd Hu	(mm)							
			a	b	c	d	e	e _B	e _D	
	B	-		≥ 100						
	A,B,C	-	≥ 100 ⁽¹⁾	≥ 100	≥ 100					
	B,E	-		≥ 100			≥ 1000		≤ 500	
	A,B,C,E	-	≥ 150 ⁽¹⁾	≥ 150	≥ 150		≥ 1000		≤ 500	
	D	-				≥ 500				
	D,E	-				≥ 500	≥ 1000	≤ 500		
	B,D	Hd>Hu		≥ 100		≥ 500				
		Hd≤Hu		≥ 100		≥ 500				
	B,D,E	Hd>Hu	Hb≤½Hu	≥ 250		≥ 750	≥ 1000	≤ 500		
			½Hu>Hb≤Hu	≥ 250	≥ 1000	≥ 1000	≤ 500			
Hd≤Hu		Hb>Hu	⊘							
		Hd≤½Hu	≥ 100		≥ 1000	≥ 1000	≤ 500			
		½Hu<Hd≤Hu	≥ 200		≥ 1000	≥ 1000	≤ 500			
		Hd>Hu	⊘							
	A,B,C	-	≥ 200 ⁽¹⁾	≥ 300	≥ 1000					
	A,B,C,E	-	≥ 200 ⁽¹⁾	≥ 300	≥ 1000		≥ 1000		≤ 500	
	D	-				≥ 1000				
	D,E	-				≥ 1000	≥ 1000	≤ 500		
	B,D	Hd>Hu		≥ 300		≥ 1000				
		Hd≤Hu	Hd≤½Hu	≥ 250		≥ 1500				
	½Hu<Hd≤Hu		≥ 300	PATTERN	≥ 1500					
	B,D,E	Hd>Hu	Hb≤½Hu	≥ 300		≥ 1000	≥ 1000	≤ 500		
			½Hu<Hb≤Hu	≥ 300	≥ 1250	≥ 1000	≤ 500			
		Hd≤Hu	Hb>Hu	⊘						
Hd≤½Hu			≥ 250		≥ 1500	≥ 1000	≤ 500			
		½Hu<Hd≤Hu	≥ 300		≥ 1500	≥ 1000	≤ 500			
		Hd>Hu	⊘							

(1) For better serviceability, use a distance ≥250 mm

A,B,C,D Obstacles (walls/baffle plates)

E Obstacle (roof)

a,b,c,d,e Minimum service space between the unit and obstacles A, B, C, D and E

e_B Maximum distance between the unit and the edge of obstacle E, in the direction of obstacle B

e_D Maximum distance between the unit and the edge of obstacle E, in the direction of obstacle D

Hu Height of the unit

Hb,Hd Height of obstacles B and D

1 Seal the bottom of the installation frame to prevent discharged air from flowing back to the suction side through the bottom of the unit.

2 Maximum two units can be installed.

⊘ Not allowed

Multiple rows of units ()

Multiple rows of units ()

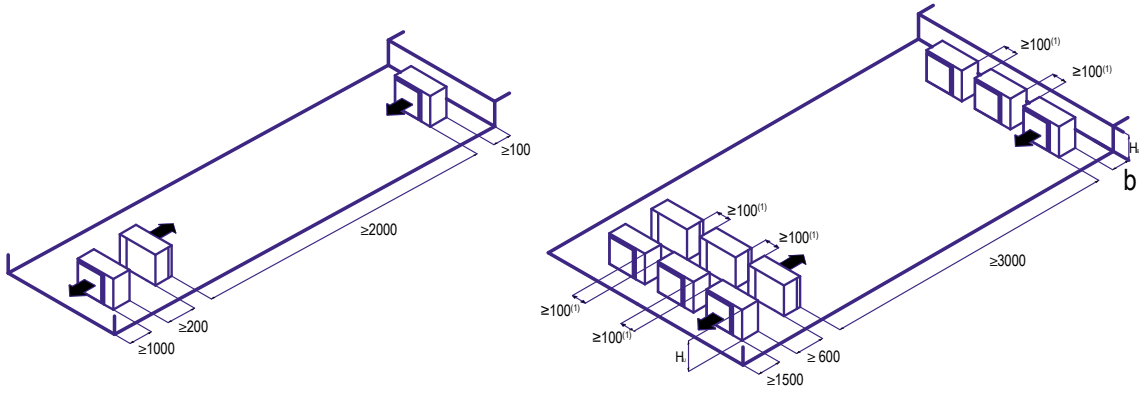

Hb Hu	b (mm)
$Hb \leq \frac{1}{2}Hu$	$b \geq 250$
$\frac{1}{2}Hu < Hb \leq Hu$	$b \geq 300$
$Hb > Hu$	⊘

- (1) For better serviceability, use a distance ≥ 250 mm
- ⊘ Not allowed

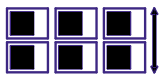
Stacked units (max.2 levels) ()

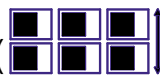
Stacked units (max.2 levels) ()

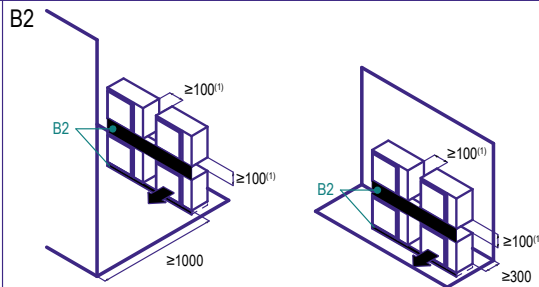
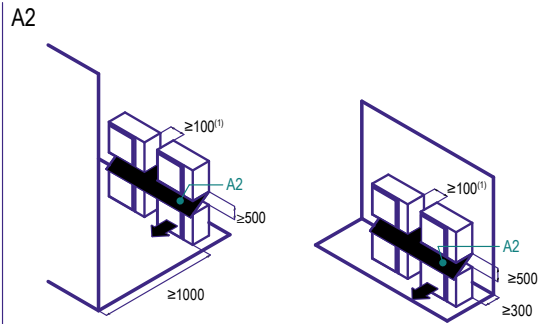
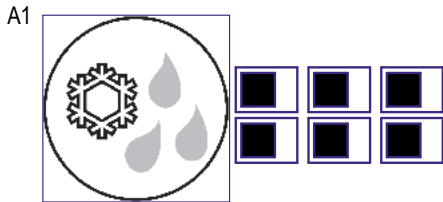

(1) For better serviceability, use a distance ≥ 250 mm

A1=>A2 (A1) If there is danger of drainage dripping and freezing between the upper and lower units...

(A2) Then install a roof between the upper and lower units. Install the upper unit high enough above the lower unit to prevent ice buildup at the upper unit's bottom plate.

B1=>B2 (B1) If there is no danger of drainage dripping and freezing between the upper and lower units...

(B2) Then it is not required to install a roof, but seal the gap between the upper and lower units to prevent discharged air from flowing back to the suction side through the bottom of the unit.

FXFA-A WITH STANDARD PANEL

Notes

1. Location of nameplate
The unit nameplate is located on the control box cover.
The decoration panel nameplate is located on the piping-side panel frame, under the corner cover.
2. When installing optional accessories, refer to their respective documentation.
3. Make sure the distance between the ceiling and the cassette does not exceed 35-mm.
The maximum ceiling opening is 910-mm.
4. When the conditions in the ceiling exceed 30°C ambient temperature and 80% relative humidity, or when fresh air is inducted into the ceiling, additional insulation is required (polyethylene foam, thickness ≥10-mm)
5. When installing a sensor kit, there will be a sensor on this location. For details, see the drawing of the sensor kit.
6. When installing a wireless controller, there will be a receiver on this location. For details, see the drawing of the wireless controller.

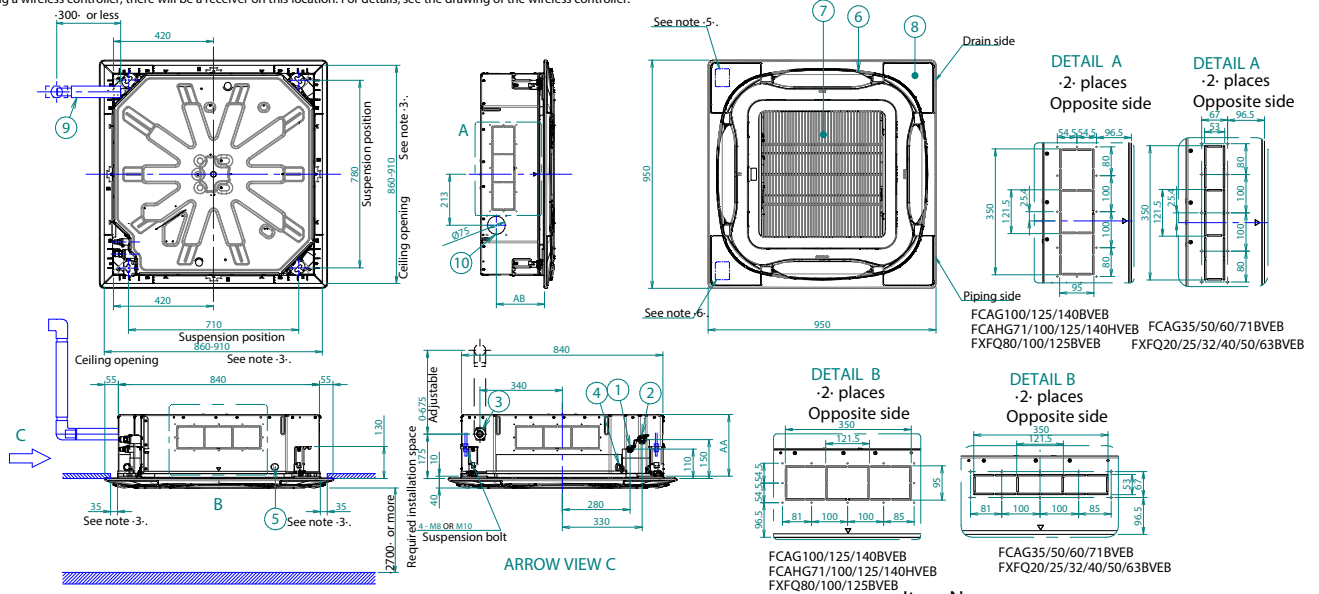

Respect the distances shown on the figure.

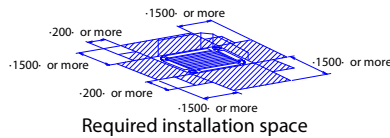
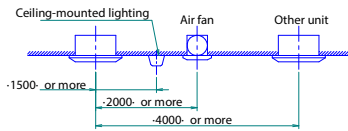

Required installation space

If a discharge outlet is closed up with the "sealing member" option kit, then the required installation space on that (closed up) side is 500-mm instead of 1500-mm.

Item Name

- 1 Liquid pipe connection port
- 2 Gas pipe connection port
- 3 Drain pipe connection
- 4 Power supply wiring intake
- 5 Transmission wiring intake hole
- 6 Air discharge outlet
- 7 Air suction grille
- 8 Corner decoration cover
- 9 Drain hose
- 10 Knockout hole.

FXFA-A WITH AUTO CLEANING PANEL

Notes

1. Location of nameplate
The unit nameplate is located on the control box cover.
The decoration panel nameplate is located on the piping-side panel frame, under the corner cover.
2. When installing optional accessories, refer to their respective documentation.
3. Make sure the distance between the ceiling and the cassette does not exceed 35-mm.
The maximum ceiling opening is 910-mm.
4. When the conditions in the ceiling exceed 30°C ambient temperature and 80% relative humidity, or when fresh air is inducted into the ceiling, additional insulation is required (polyethylene foam, thickness ≥10-mm).
5. When installing a sensor kit, there will be a sensor on this location. For details, see the drawing of the sensor kit.

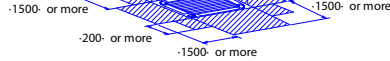
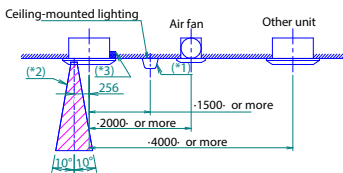
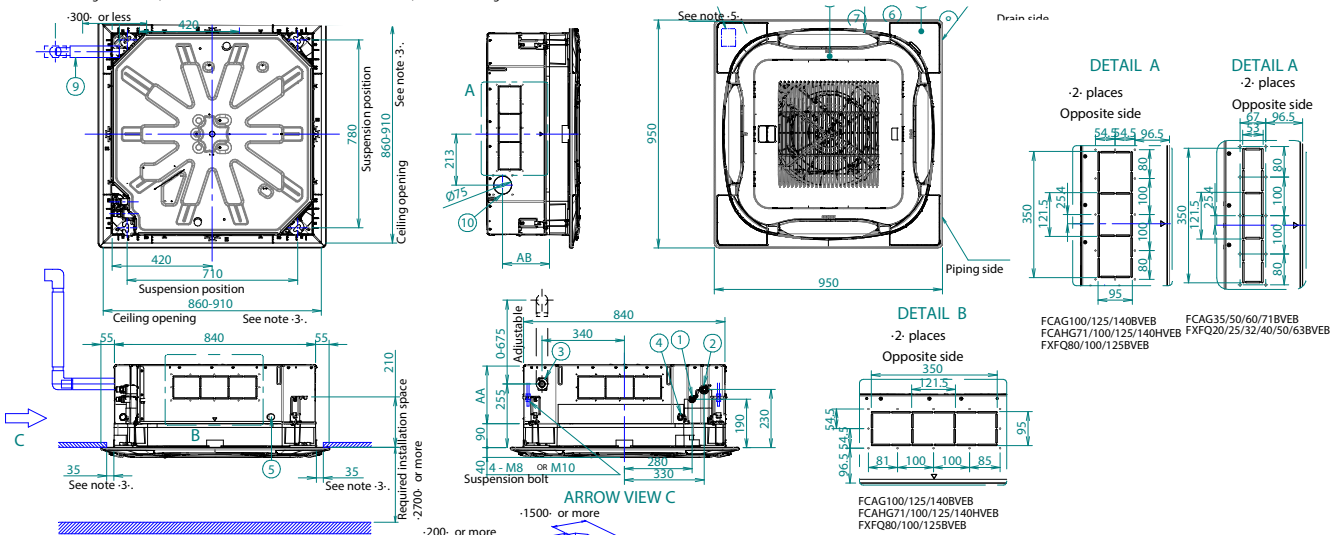

Required installation space

If a discharge outlet is closed up with the "sealing member" option kit, then the required installation space on that (closed up) side is 500-mm instead of 1500-mm.

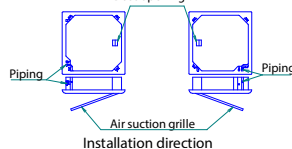

Item Name

- 1 Liquid pipe connection port
- 2 Gas pipe connection port
- 3 Drain pipe connection
- 4 Power supply wiring intake
- 5 Transmission wiring intake hole
- 6 Air discharge outlet
- 7 Air suction grille
- 8 Corner decoration cover
- 9 Drain hose
- 10 Knockout hole.

(*1)Not applicable to recessed lighting.
(*2)Required space for entering with vacuum cleaner tube.
(*3)Make sure the decoration panel discharge outlet is not blocked.

FXFA-A WITH DESIGNER PANEL

Notes

1. Location of nameplate
The unit nameplate is located on the control box cover.
The decoration panel nameplate is located on the piping-side panel frame, under the corner cover.
2. When installing optional accessories, refer to their respective documentation.
3. Make sure the distance between the ceiling and the cassette does not exceed -35-mm.
The maximum ceiling opening is -910-mm.
4. When the conditions in the ceiling exceed 30°C ambient temperature and 80% relative humidity, or when fresh air is inducted into the ceiling, additional insulation is required (polyethylene foam, thickness ≥ 10-mm).
5. When installing a sensor kit, there will be a sensor on this location. For details, see the drawing of the sensor kit.
6. When installing a wireless controller, there will be a receiver on this location. For details, see the drawing of the wireless controller.

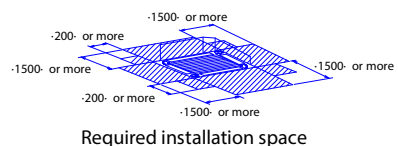
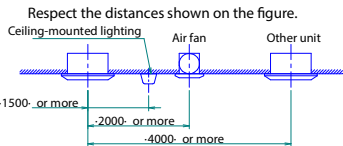
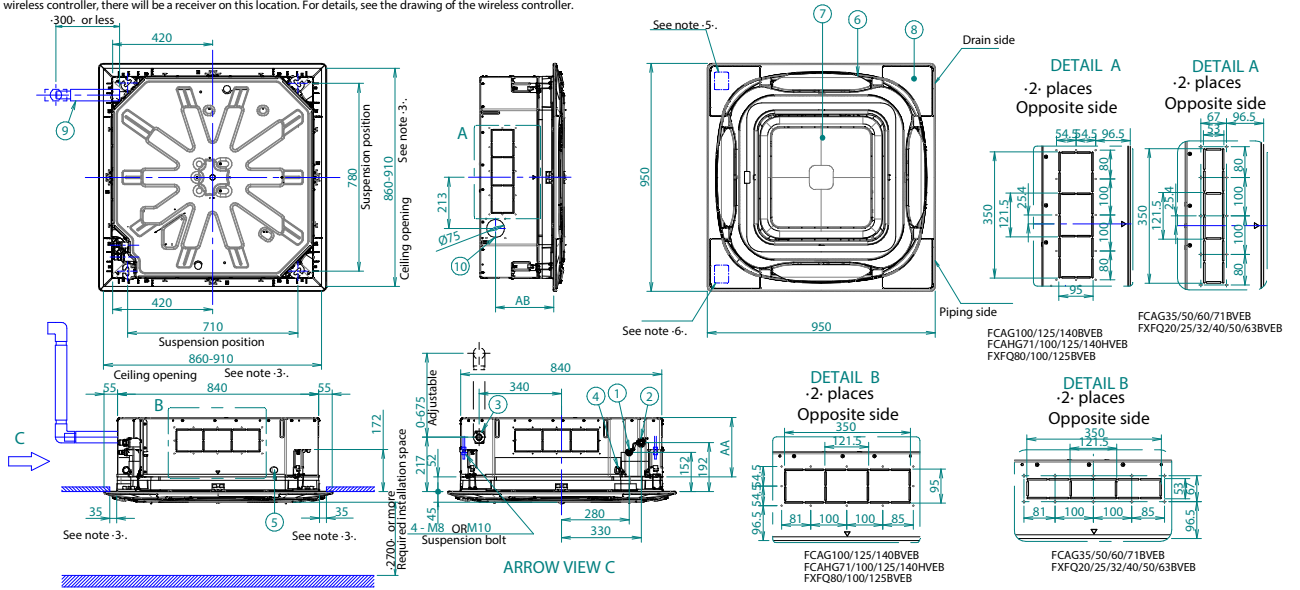

If a discharge outlet is closed up with the "sealing member" option kit, then the required installation space on that (closed up) side is -500-mm instead of -1500-mm.

- Item Name**
- ① Liquid pipe connection port
 - ② Gas pipe connection port
 - ③ Drain pipe connection
 - ④ Power supply wiring intake
 - ⑤ Transmission wiring intake hole
 - ⑥ Air discharge outlet
 - ⑦ Flat grille assembly
 - ⑧ Corner decoration cover
 - ⑨ Drain hose
 - ⑩ Knockout hole.

FXFA-A WITH FRESH AIR INTAKE

AA	AB	Model name
264	306	FCAG35/50/60/71BVEB FXFQ20/25/32/40/50/63BVEB
306	348	FCAG100/125/140BVEB FXFQ80/100BVEB
348	390	FCAHG71/100/125/140HVEB FXFQ125BVEB

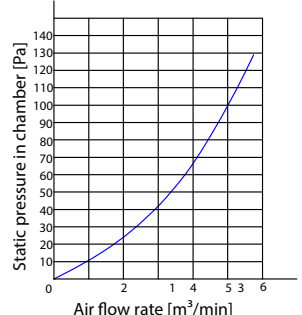
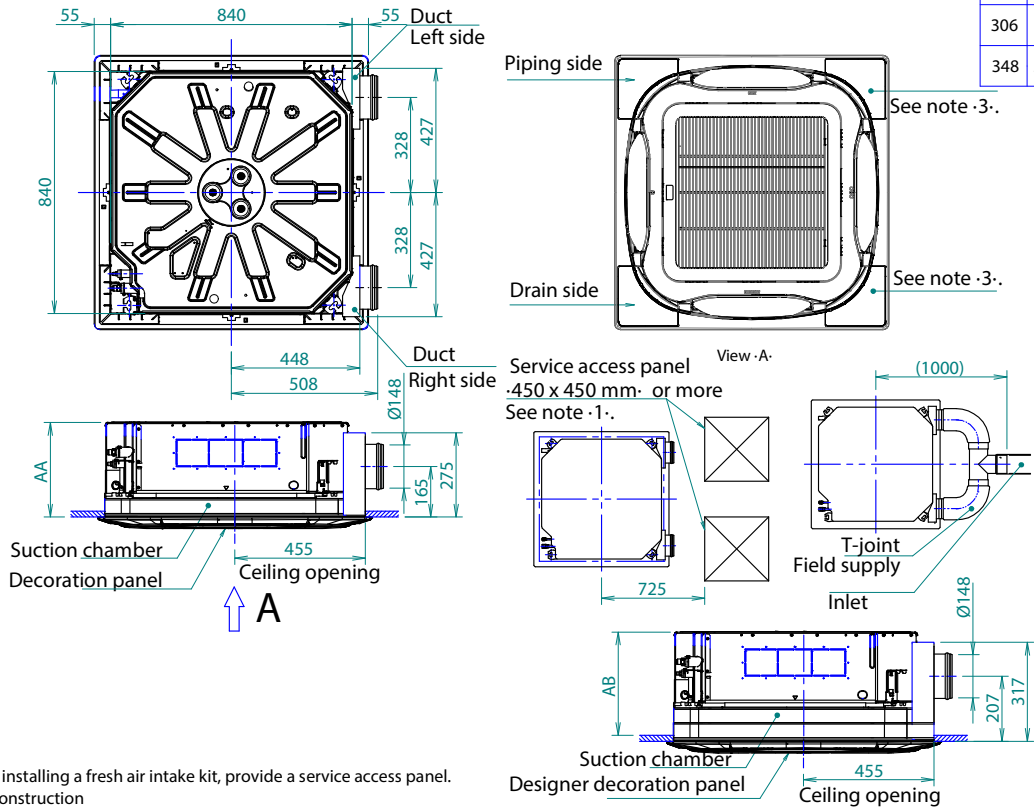

Notes

1. When installing a fresh air intake kit, provide a service access panel.
2. Field construction
3. This corner discharge outlet needs to be closed.
4. When installing a duct fan, use a wiring adapter to link the duct fan to the fan of the indoor unit.
5. The intake air flow rate is recommended to be ≤ 20% of the air flow rate at high fan speed.
If the intake air flow rate is too large, the operating sound may increase, and the detection of the indoor unit suction temperature may be affected.
6. This indicates the distance between the T-joint inlet and the indoor unit inlet when the T-tube is connected.

FXZA-A

BYFQ60C2W1W	Fresh white N9.5
BYFQ60C2W1S	Dalikin Silver

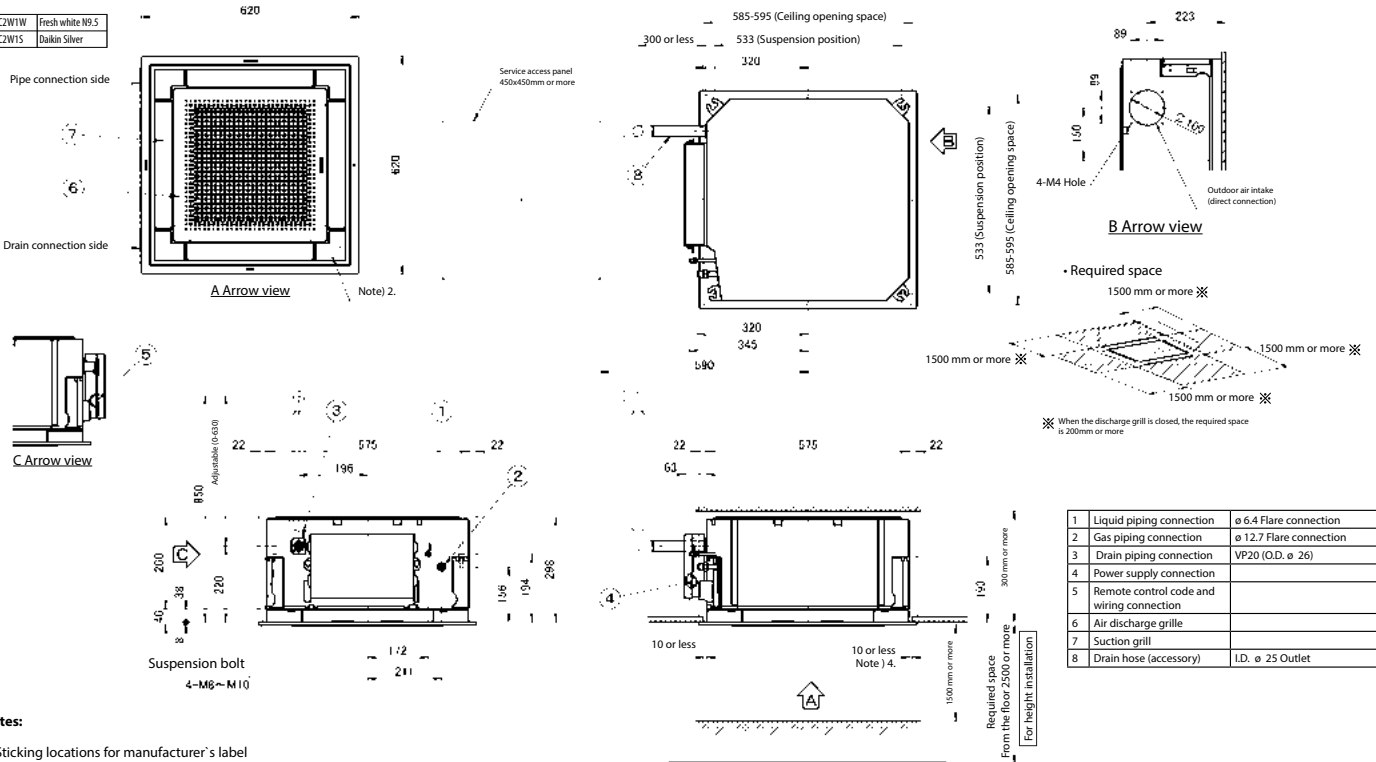

1	Liquid piping connection	φ 6.4 Flare connection
2	Gas piping connection	φ 12.7 Flare connection
3	Drain piping connection	VP20 (O.D. φ 26)
4	Power supply connection	
5	Remote control code and wiring connection	
6	Air discharge grille	
7	Suction grill	
8	Drain hose (accessory)	I.D. φ 25 Outlet

Notes:

- Sticking locations for manufacturer's label
Manufacturer's label for indoor unit: on the bell mouth inside suction grille.
Manufacturer's label for decoration panel: on the inner frame inside suction grille.
- In case of using infrared remote controller, this position will be a signal receiver. Refer to the drawing of infrared remote controller in detail.
- When the temperature and humidity in the ceiling exceed 30°C and RH 80%, or the fresh air is inducted into the ceiling or the unit continues 24 hour operation, an additional insulation (thickness 10mm or more, Glasswool or polyethylene foam) is required.
- Though the installation is acceptable up to maximum of 595mm square ceiling opening, keep the clearance of 10mm or less between the main unit and the ceiling opening so that the panel overlap allowance can be ensured.

FXZA-A

BYFQ60B2W1	White RAL 9010
BYFQ60B3W1	White RAL 9010

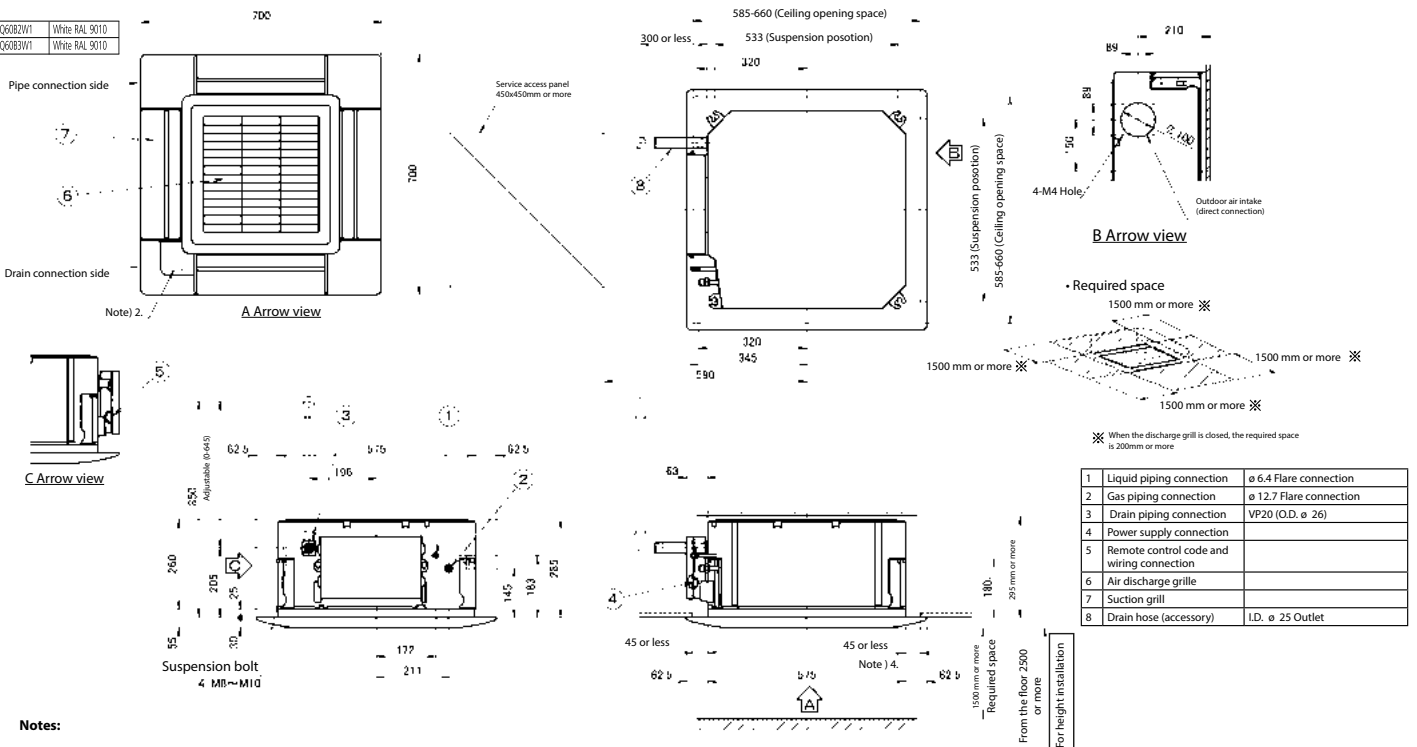

1	Liquid piping connection	φ 6.4 Flare connection
2	Gas piping connection	φ 12.7 Flare connection
3	Drain piping connection	VP20 (O.D. φ 26)
4	Power supply connection	
5	Remote control code and wiring connection	
6	Air discharge grille	
7	Suction grill	
8	Drain hose (accessory)	I.D. φ 25 Outlet

Notes:

- Sticking locations for manufacturer's label
Manufacturer's label for indoor unit: on the bell mouth inside suction grille.
Manufacturer's label for decoration panel: on the inner frame inside suction grille.
- In case of using infrared remote controller, this position will be a signal receiver. Refer to the drawing of infrared remote controller in detail.
- When the temperature and humidity in the ceiling exceed 30°C and RH 80%, or the fresh air is inducted into the ceiling or the unit continues 24 hour operation, an additional insulation (thickness 10mm or more, Glasswool or polyethylene foam) is required.
- Though the installation is acceptable up to maximum of 660mm square ceiling opening, keep the clearance of 45 mm or less between the main unit and the ceiling opening so that the panel overlap allowance can be ensured.

FXDA10-32A

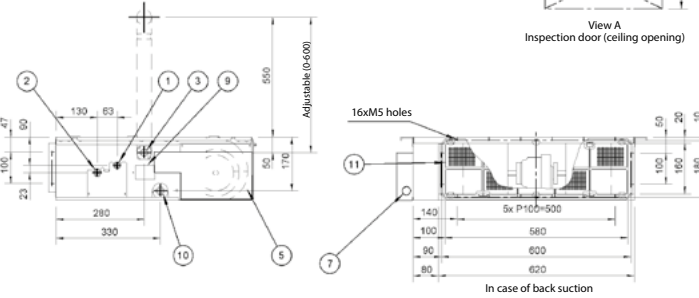
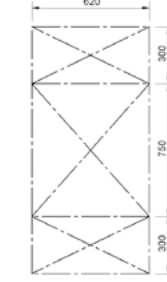
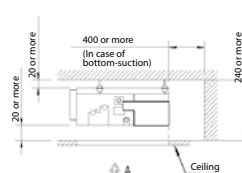
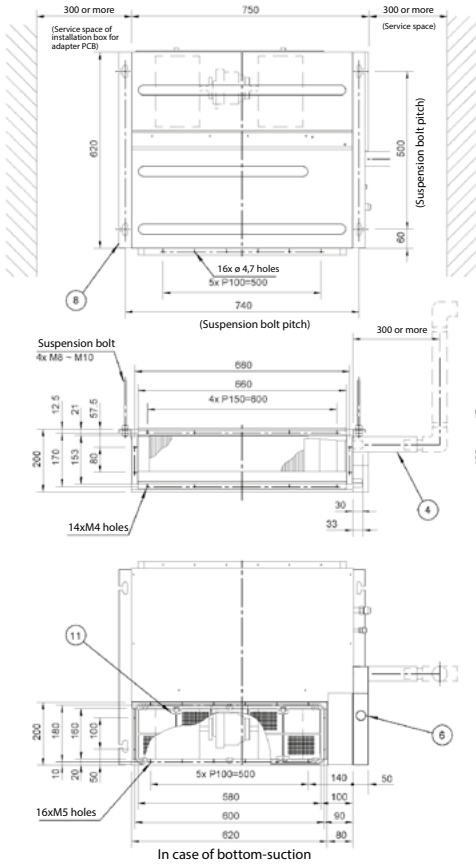

1	Liquid pipe connection	ϕ 6.4 Flare connection
2	Gas pipe connection	ϕ 12.7 Flare connection
3	Drain pipe connection	VP20 (O.D. ϕ 26, I.D. ϕ 20)
4	Drain hose (accessory)	ID ϕ 25 (Outlet)
5	control box	
6	Transmission wiring connection	
7	Power supply connection	
8	Suspension bracket	
9	Inspection cover	
10	Socket for drain	
11	Air filter (accessory)	

Notes:

- In case of back-suction, mount chamber cover to bottom side of the unit.
In case of bottom-suction, mount chamber cover to back side of the unit.
- Locations of unit's name plate: control box cover.
- Mount the air filter at the suction side. (Use an air filter whose dust collecting efficiency is at least 50% in a gravimetric technique). It can not be equipped with air filter (accessory) when connecting duct to suction side.

FXDA40-50A

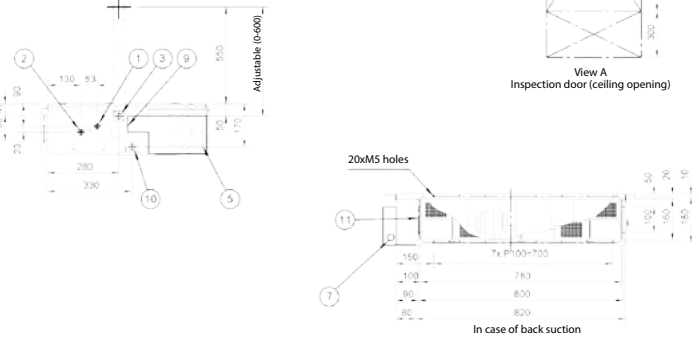
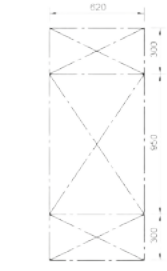
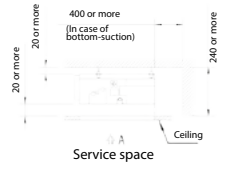
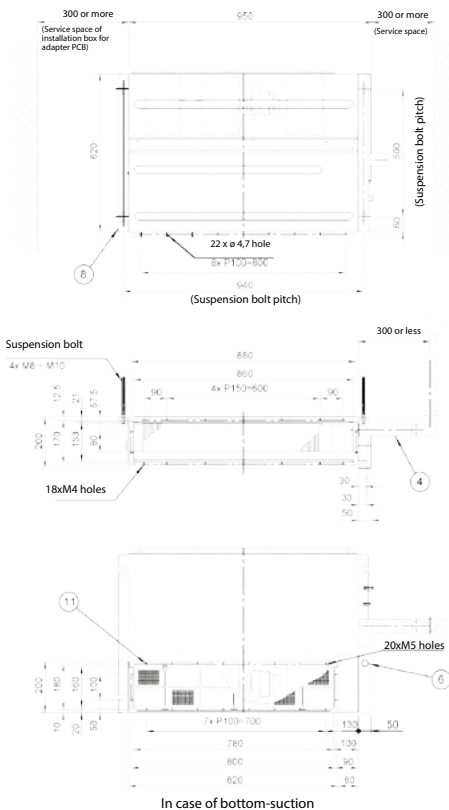

1	Liquid pipe connection	ϕ 6.4 Flare connection
2	Gas pipe connection	ϕ 12.7 Flare connection
3	Drain pipe connection	VP20 (O.D. ϕ 26, I.D. ϕ 20)
4	Drain hose (accessory)	ID ϕ 25 (Outlet)
5	control box	
6	Transmission wiring connection	
7	Power supply connection	
8	Suspension bracket	
9	Inspection cover	
10	Socket for drain	
11	Air filter (accessory)	

Notes:

- In case of back-suction, mount chamber cover to bottom side of the unit.
In case of bottom-suction, mount chamber cover to back side of the unit.
- Locations of unit's name plate: control box cover.
- Mount the air filter at the suction side. (Use an air filter whose dust collecting efficiency is at least 50% in a gravimetric technique). It can not be equipped with air filter (accessory) when connecting duct to suction side.

FXDA63A

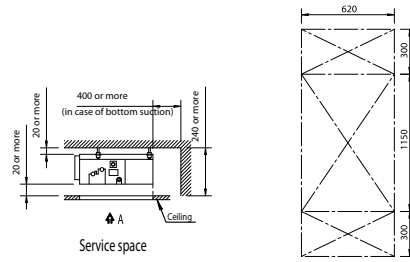
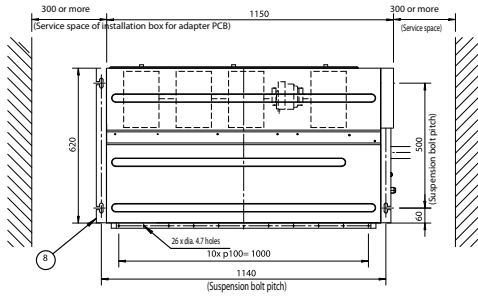

View A
Inspection door (ceiling opening)

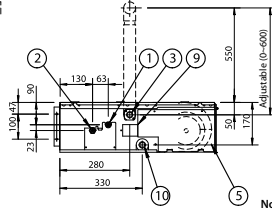
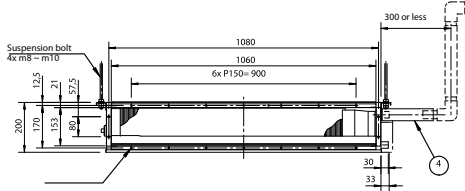

Notes :

- In case of back suction, mount chamber cover to bottom side of the unit.
In case of bottom suction, mount chamber cover to back side of the unit.
- Location of unit name plate: control box cover.
- Mount the air filter at the suction side.
(use an air filter whose dust collecting efficiency is at least 50% in a gravimetric technique).
It can not be equipped with air filter (accessory) when connecting duct to suction side

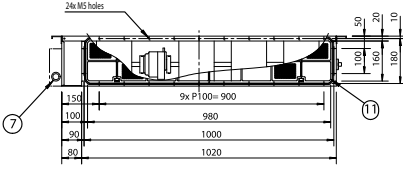

In case of back suction

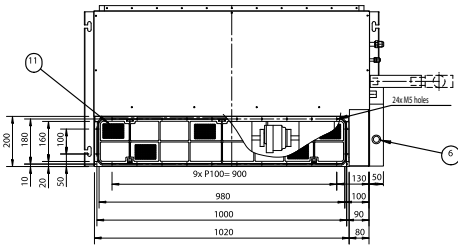

In case of bottom suction

Item	Name	Description
1	Liquid pipe connection	Dia.9.5 flare connection
2	Gas pipe connection	Dia.15.9 flare connection
3	Drain pipe connection	VP20 (OD dia.26, ID dia.20)
4	Drain hose (accessory)	ID dia.25 (outlet)
5	Control box	
6	Transmission wiring connection	
7	Power supply connection	
8	Suspension bracket	
9	Inspection cover	
10	Socket for drain	
11	Air filter (accessory)	



FXSA15-32A

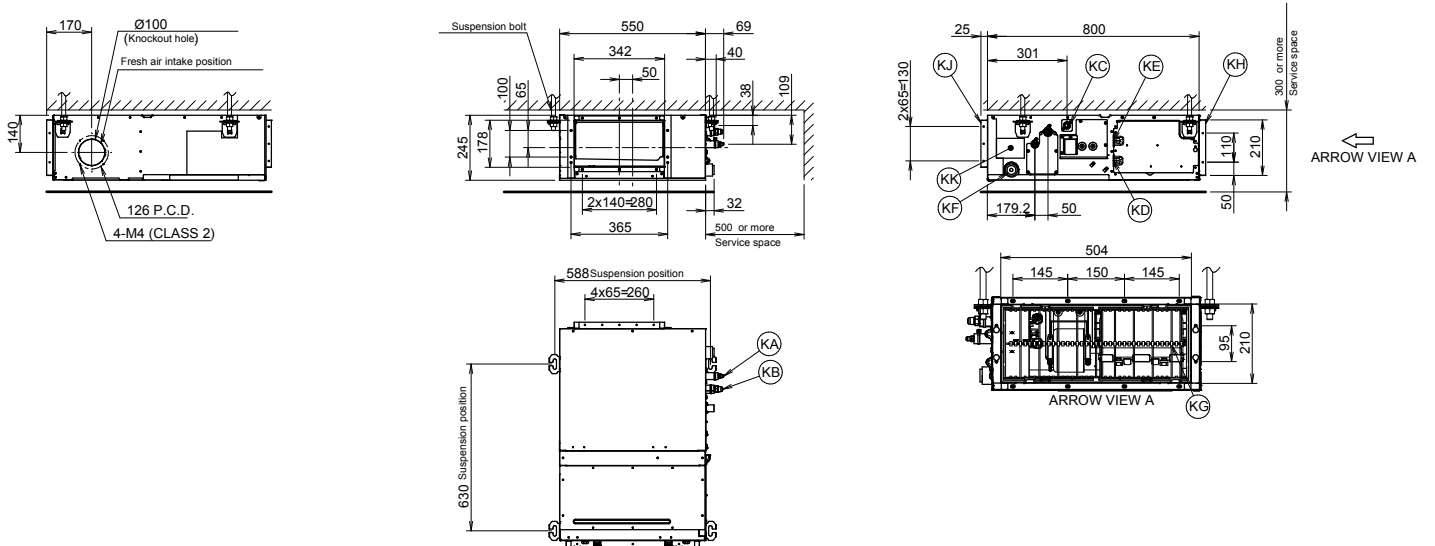

Item	Name	Description
KA	Liquid pipe connection port	Ø6.35 flared connection
KB	Gas pipe connection port	Ø12.70 flared connection
KC	Drain pipe connection	VP20 (OD Ø26, ID Ø20)
KD	Wiring connection	/
KE	Power supply connection	/
KF	Drain outlet	VP20 (OD Ø26, ID Ø20)
KG	Air filter	/
KH	Air suction side	/
KJ	Air discharge side	/
KK	Nameplate	/

Notes
 1. When installing optional accessories, refer to their respective documentation.
 2. The ceiling depth varies according to the documentation of the specific system.

FXSA40-50A

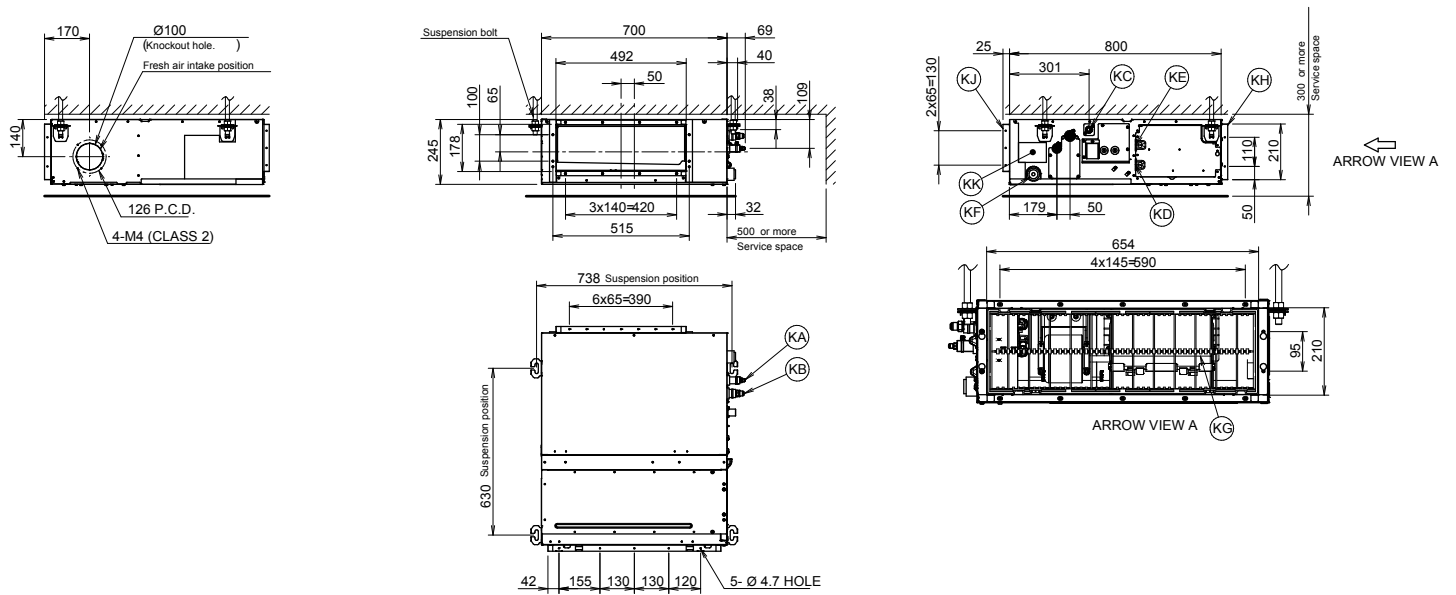

Item	Name	Description
KA	Liquid pipe connection port	Ø6.35 flared connection
KB	Gas pipe connection port	Ø12.70 flared connection
KC	Drain pipe connection	VP20 (OD Ø26, ID Ø20)
KD	Wiring connection	/
KE	Power supply connection	/
KF	Drain outlet	VP20 (OD Ø26, ID Ø20)
KG	Air filter	/
KH	Air suction side	/
KJ	Air discharge side	/
KK	Nameplate	/

Notes
 1. When installing optional accessories, refer to their respective documentation.
 2. The ceiling depth varies according to the documentation of the specific system.

FXSA63-80A

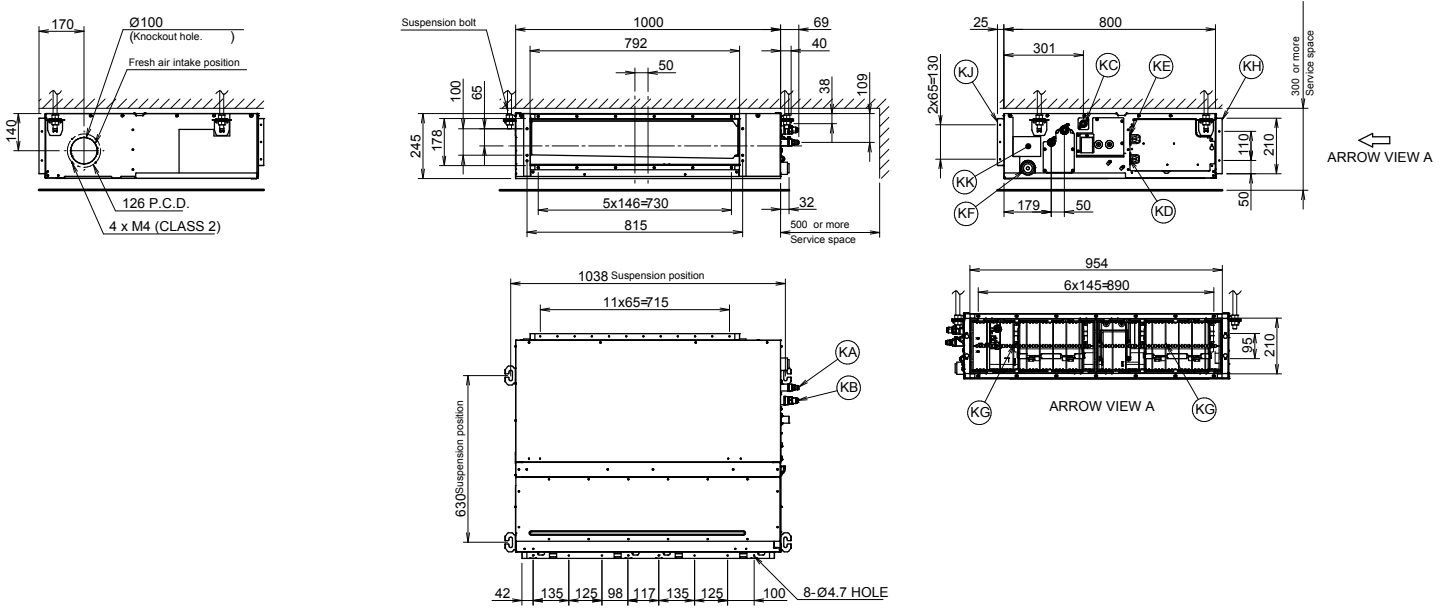

Item	Name	Description
KA	Liquid pipe connection port	Ø9.52 flared connection
KB	Gas pipe connection port	Ø15.90 flared connection
KC	Drain pipe connection	VP20 (OD Ø26, ID Ø20)
KD	Wiring connection	/
KE	Power supply connection	/
KF	Drain outlet	VP20 (OD Ø26, ID Ø20)
KG	Air filter	/
KH	Air suction side	/
KJ	Air discharge side	/
KK	Nameplate	/

- Notes**
1. When installing optional accessories, refer to their respective documentation.
 2. The ceiling depth varies according to the documentation of the specific system.

FXSA100-125A

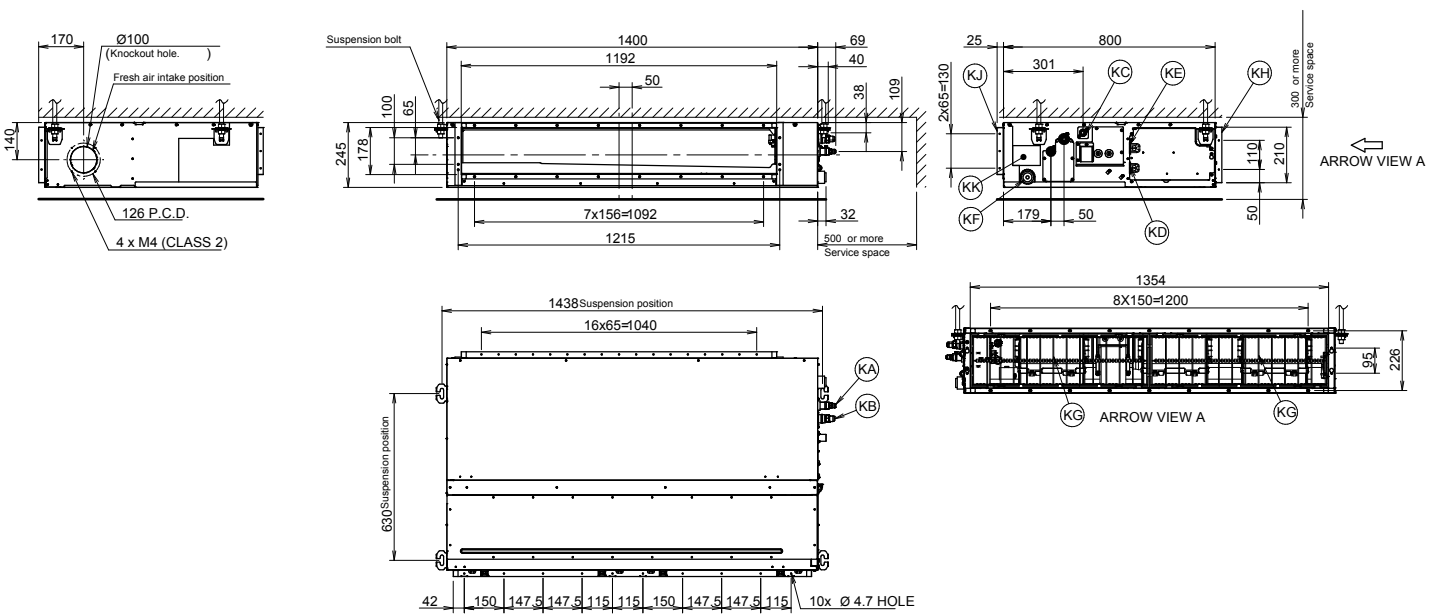

Item	Name	Description
KA	Liquid pipe connection port	Ø9.52 flared connection
KB	Gas pipe connection port	Ø15.90 flared connection
KC	Drain pipe connection	VP20 (OD Ø26, ID Ø20)
KD	Wiring connection	/
KE	Power supply connection	/
KF	Drain outlet	VP20 (OD Ø26, ID Ø20)
KG	Air filter	/
KH	Air suction side	/
KJ	Air discharge side	/
KK	Nameplate	/

- Notes**
1. When installing optional accessories, refer to their respective documentation.
 2. The ceiling depth varies according to the documentation of the specific system.

FXSA140A

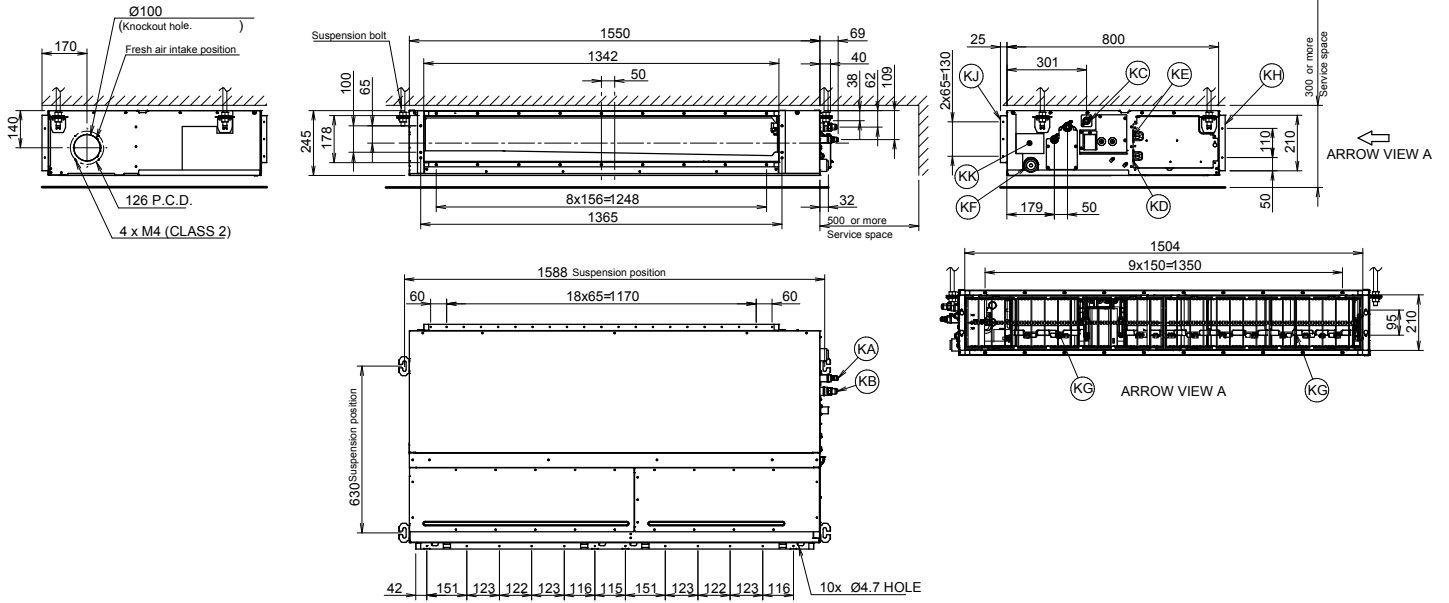

Item	Name	Description
KA	Liquid pipe connection port	Ø9.52 flared connection
KB	Gas pipe connection port	Ø15.90 flared connection
KC	Drain pipe connection	VP20 (OD Ø26, ID Ø20)
KD	Wiring connection	/
KE	Power supply connection	/
KF	Drain outlet	VP20 (OD Ø26, ID Ø20)
KG	Air filter	/
KH	Air suction side	/
KJ	Air discharge side	/
KK	Nameplate	/

Notes
 1. When installing optional accessories, refer to their respective documentation.
 2. The ceiling depth varies according to the documentation of the specific system.



FXAA15-32A

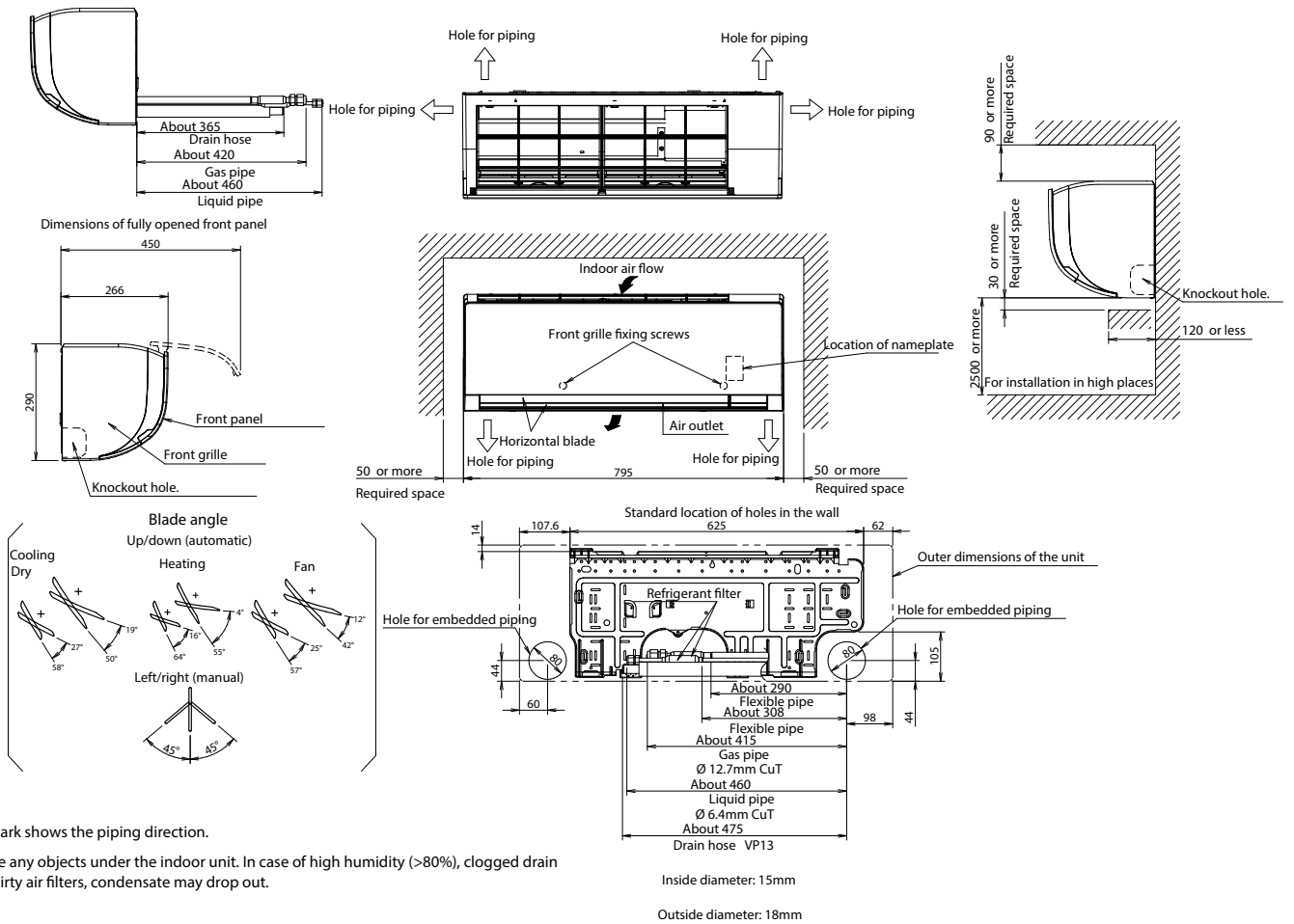

FXAA40-50A

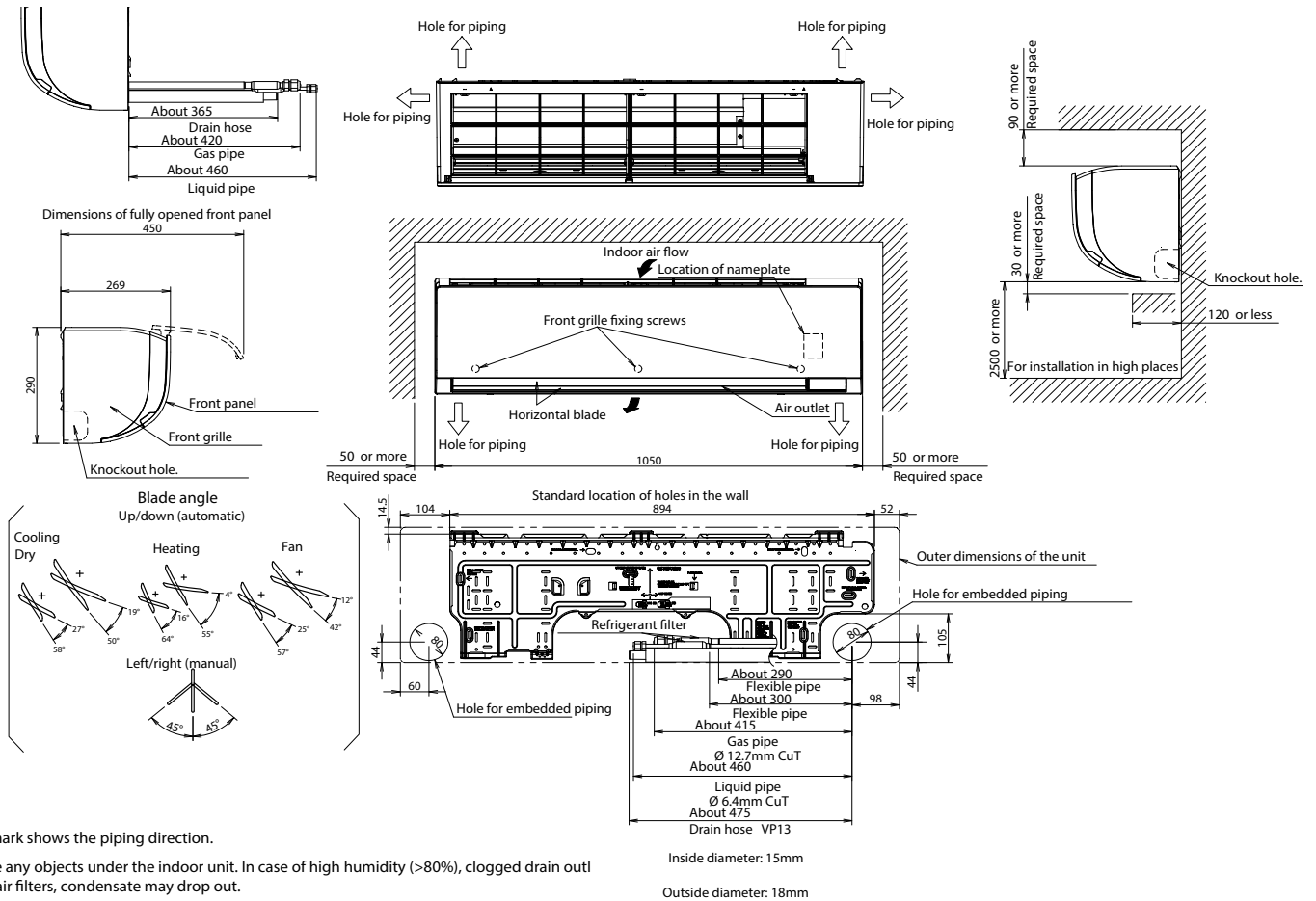

FXAA63A

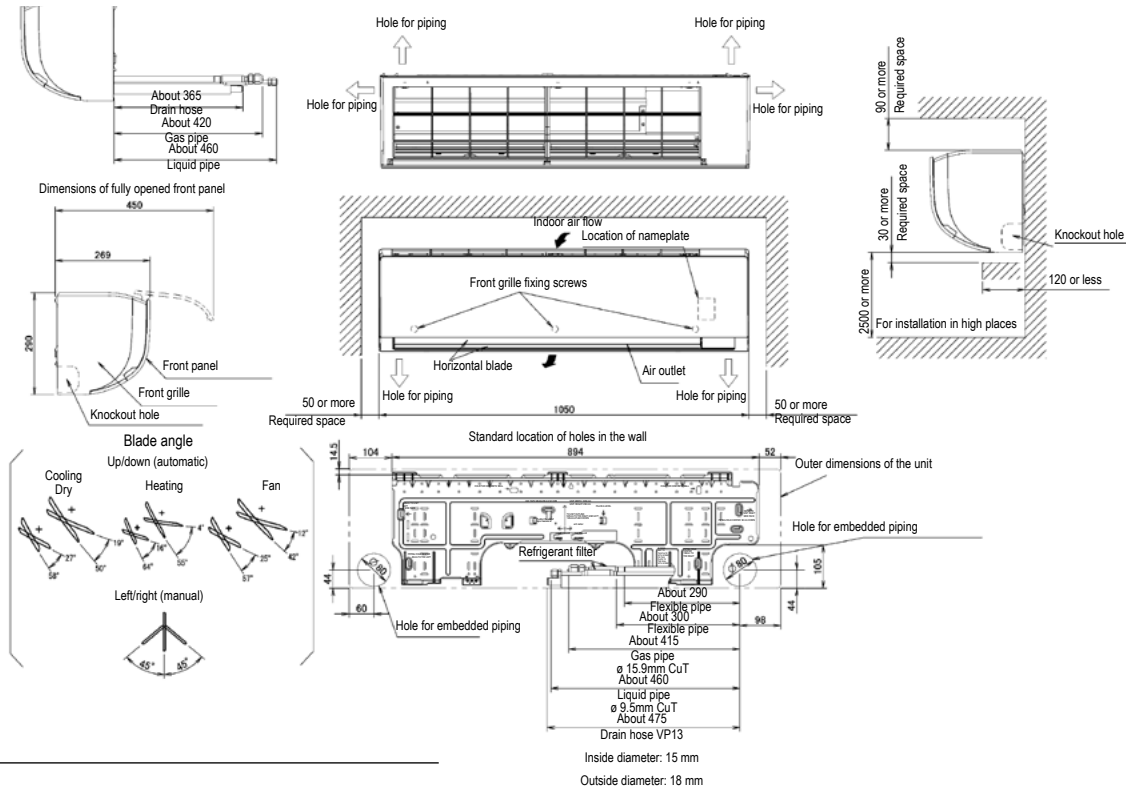

NOTES

1. The mark \Rightarrow shows the piping direction.
2. Do not place any objects under the indoor unit. In case of high humidity (>80%), clogged drain outlets or dirty air filters, condensate may drop out.



Definitely the best VRV
we ever made

Creating a sustainable future together

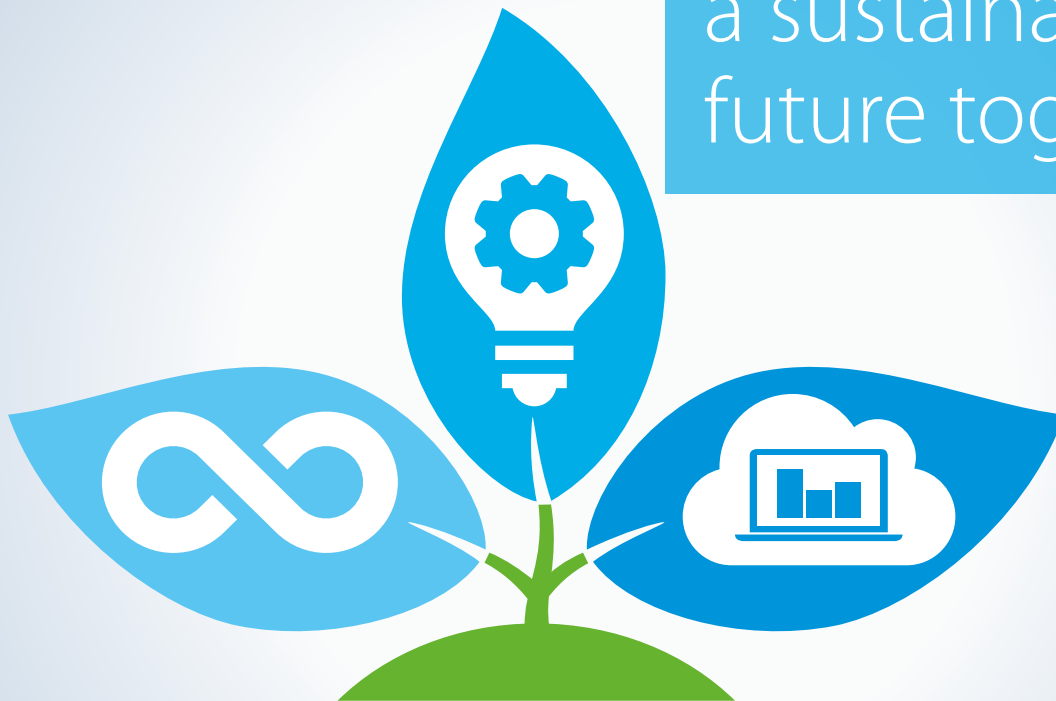

Determined to reduce our environmental footprint, we aim to be CO₂-neutral by 2050. A circular economy, innovation and smart use – these are the stepping stones on our path. **The time to act is now. Join us in creating a sustainable future for HVAC-R.**

Sowing the seeds of climate protection with Daikin



Through a circular economy

- › Embrace Certified Reclaimed Refrigerant Allocation to reuse more refrigerant
- › Increase recovered refrigerant returns
- › Reuse refrigerant for maintenance with our refrigerant recycling machine



Through innovation

- › Equip our VRV 5 range with the lower GWP refrigerant R-32
- › Offer high real-world seasonal efficiencies
- › Deploy unique auto cleaning filters to maximise efficiency 24/7



Through smart use

- › Rigorously follow up on energy consumption via the Daikin Cloud Service
- › Factor in experts' advice to continuously optimise system efficiency
- › Enable predictive maintenance to ensure optimum operation and uptime
- › Prevent energy waste with smart key cards and sensors

www.daikin.eu/building-a-circular-economy

Daikin Europe N.V. Naamloze Vennootschap Zandvoordestraat 300 · 8400 Oostende · Belgium · www.daikin.eu · BE 0412 120 336 · RPR Oostende (Publisher)

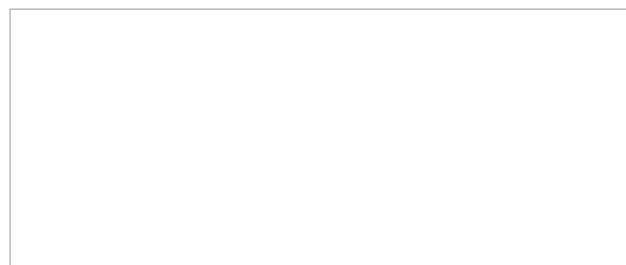

CEPEN20-210C 01/2021



The present publication is drawn up by way of information only and does not constitute an offer binding upon Daikin Europe N.V. Daikin Europe N.V. has compiled the content of this publication to the best of its knowledge. No express or implied warranty is given for the completeness, accuracy, reliability or fitness for particular purpose of its content and the products and services presented therein. Specifications are subject to change without prior notice. Daikin Europe N.V. explicitly rejects any liability for any direct or indirect damage, in the broadest sense, arising from or related to the use and/or interpretation of this publication. All content is copyrighted by Daikin Europe N.V.

Printed on non-chlorinated paper. Prepared by La Movida.