



# WSH-EE WSHH-EE 17-21-31-41-51-61-71-81-91-101-121

WATER COOLED WATER CHILLER FOR INDOOR INSTALLATION

## Installation and Use Manual

M03Q40G6-03

21/11/07



<b>UNIT IDENTIFICATION</b> .....	<b>4</b>
<b>INSTRUCTIONS FOR THE USER</b> .....	<b>5</b>
COMMON CAUSES OF SHUTDOWN .....	7
<b>GENERAL WARNINGS</b> .....	<b>8</b>
<b>RESIDUAL RISKS</b> .....	<b>9</b>
<b>RECEPTION</b> .....	<b>12</b>
INSPECTION UPON RECEPTION.....	12
STORAGE .....	12
HANDLING .....	12
<b>POSITIONING</b> .....	<b>13</b>
GENERAL.....	13
FUNCTIONAL CLEARANCES.....	13
POSITIONING .....	13
<b>WATER CONNECTIONS</b> .....	<b>14</b>
GENERAL.....	14
EXCHANGER USE SIDE .....	14
DIAGRAM OF RECOMMENDED USE SIDE CONNECTION.....	15
USE SCHEMA .....	15
RECOMMENDED SOURCE SIDE CONNECTION SCHEMA .....	15
SYSTEM MEASURES ON SOURCE SIDE .....	16
<b>ELECTRICAL CONNECTION</b> .....	<b>18</b>
GENERAL.....	18
STANDARD UNIT ELECTRICAL DATA .....	18
CONNECTION TO THE MAINS .....	19
SYSTEM COMPOSITION.....	19
FUNCTIONAL CONNECTIONS.....	20
<b>START-UP</b> .....	<b>28</b>
PRELIMINARY CHECKS.....	28
REFRIGERANT SYSTEM .....	28
WATER SYSTEM .....	28
ELECTRICAL SYSTEM.....	28
VERIFY tensions – absorptions.....	29
UNIT EQUIPPED WITH SCROLL COMPRESSORS .....	29
REMOTE INPUT CONFIGURATIONS .....	29
SETTING THE SET-POINT .....	29
EVAPORATOR WATER FLOW RATE .....	29
CONDENSER WATER FLOW RATE .....	29
REFRIGERANT CIRCUIT PARAMETER CHECK.....	29
<b>CONTROL</b> .....	<b>30</b>
OPERING MODES .....	30
SET POINT .....	31
USER KEYPAD .....	33
REMOTE OR SERVICE KEYPAD (OPTIONALS) .....	34
<b>ROUTINE MAINTENANCE</b> .....	<b>38</b>
MAINTENANCE INSPECTIONS.....	38
97/23 CE PED directive .....	39
PUT AT REST.....	39
REFRIGERANT TABLES .....	39
<b>TROUBLESHOOTING</b> .....	<b>42</b>
<b>DECOMMISSIONING OF THE UNIT</b> .....	<b>44</b>
DISCONNECTING THE UNIT .....	44
DISMANTLING AND DISPOSAL .....	44
<b>TECHNICAL DATA</b> .....	<b>45</b>
DIMENSIONS.....	48

## UNIT IDENTIFICATION

### SERIAL NUMBER LABEL

The units are identified by the serial number label shown here.

The label lists the type of unit (series and size), serial number, year of manufacture, number of electrical diagram, main technical data, logo and address of the manufacturer.

The label is placed on the unit, generally near the electrical panel and also on the external panelling.

IT MUST NEVER BE REMOVED.

### SERIAL NUMBER

This provides unique identification of the machine. It makes it possible to trace the specific features of the unit and to identify the components installed in it.

Without this number, it is not possible to identify with certainty the spare parts that are specific to that unit.

When requesting assistance, always provide the type of machine and the serial number.

Write them in the space below so that they are readily available when needed.

Type of unit : \_\_\_\_\_

Serial number : \_\_\_\_\_

Wiring diagram : \_\_\_\_\_

Year of manufacture : \_\_\_\_\_

<div style="display: flex; justify-content: space-around; align-items: center;"> <div style="border: 1px dashed black; padding: 5px; font-weight: bold; font-size: 1.2em;">LOGO</div> <div style="font-size: 2em; font-weight: bold;">CE</div> </div>	
<small>TIPO TYPE/TYP TYPE/TIPO</small>	
<small>NUMERO MATRICOLA SERIAL NUMBER / SERIENNUMMER NUMERO DE SERIE / NUMERO DE SERIE</small>	
<small>ANNO DI FABBRICAZIONE YEAR OF MANUFACTURE / BAUJAHR ANNEE DE FABRICATION/AÑO DE FABRICACIÓN</small>	
<small>REFRIGERANTE REFRIGERANT / KÄLTEMITTEL REFRIGERANT / REFRIGERANTE</small>	<small>GRUPPO (PED) GROUP / GRUPPE GROUPE / GRUPO</small>
<small>CARICA REFRIGERANTE REFRIG. CHARGE / KÄLTEMITTELFÜLLUNG CHARGE REFRIG./CARGA REFRIG.</small>	
	<small>Kg</small>
<small>TENSIONE VOLTAGE / SPANNUNG TENSION / TENSION</small>	
	<small>V/Ph/Hz</small>
<small>F.L.A.</small>	
	<small>A</small>
<small>F.L.I.</small>	
	<small>kW</small>
<small>SCHEMA ELETTRICO WIRING DIAGRAM / SCHALTPLAN SCHEMA ELECTRIQUE/ESQUEMA ELÉCTRICO</small>	
	<small>N°</small>
<small>PRESSIONE MASSIMA ESERCIZIO MAX OPERATING PRESS. / MAX BETRIEBSDRUCK PRESS. DE SERVICE MAX/PRESION DE EJERCICIO MÁX</small>	
	<small>bar</small>
<small>CATEGORIA PED PED CATEGORY / PED KATEGORIE CATEGORIE PED / CATEGORIA PED</small>	
	<small>PS H/L bar</small>
<small>TEMP. LATO BP TEMPERATURE ON LP SIDE / TEMP. ND-SEITE TEMP. COTE BP / TEMP. PARTE BP</small>	
	<small>°C</small>
<small>INDIRIZZO / ADDRESS / ADRESSE / ADRESSE / DIRECCION</small>	

## INSTRUCTIONS FOR THE USER

- **This is a partial sintex of the information provided in the manual; carefully read this manual**
- Carefully read this manual. Keep it with the electrical diagram. Make it available to technicians for servicing.
- Ask the installer for training on start-up, shutdown, changing set points, placing in at-rest status, maintenance, what to do or not to do in the event of a breakdown.
- Provide for scheduled maintenance by specialized technicians so as to ensure long-lasting operation of the unit.
- If you expect the machine to be shut down for long periods of time, disconnect the electrical power supply. In winter, take necessary measures to deal with possible freezing (unit and system pipes) .

### REFRIGERANT CYCLE : PRINCIPLE OF OPERATION

**SUMMER:** the cooling cycle allows the transfer of excess indoor heat to the external environment:

1. The compressor compresses the refrigerant gas, placing it at high pressure and high temperature;
2. in the source side exchanger the refrigerant is cooled and the heat is released in the environment ; depending on the type of system, the disposal occurs using one of the following systems:
  3. horizontal geothermal probes placed in the ground at a depth of about 1.5 m
  4. vertical geothermal probes (from a depth of 30 to 100 m)
  5. groundwater collector/disposal wells;
6. When it cools, the refrigerant becomes liquid;
7. The expansion valve causes a sudden drop in the pressure of the refrigerant, which becomes very cold as its volume increases;
8. in the utility-side exchanger, the refrigerant evaporates and absorbs heat from the water that returns from the equipment (underfloor piping - fan coil), cooling it
9. the refrigerant at gaseous status is sucked up by the compressor and the cycle is repeated

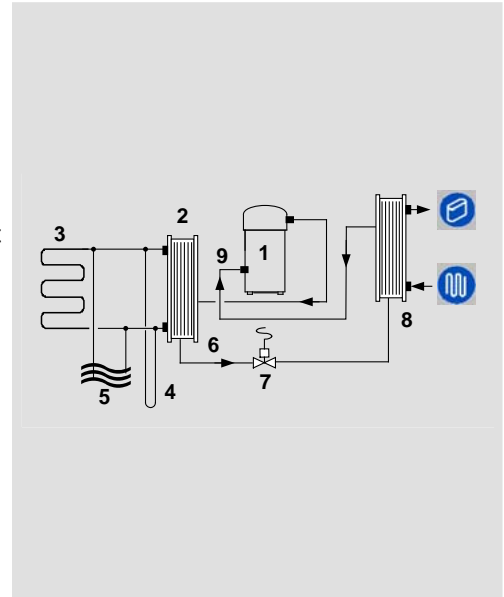

**WINTER only WSHH:** the cooling cycle makes it possible to absorb energy (heat at low temperature) from the external environment and to transfer it to the area to be heated.

1. The compressor compresses the refrigerant gas, placing it at high pressure and high temperature;
2. in the utility-side plate exchanger the water that returns from the equipment (underfloor piping – fan coil – bathroom fixtures) absorbs heat from the refrigerant and heats up;
3. When it cools, the refrigerant becomes liquid;
4. The expansion valve causes a sudden drop in the pressure of the refrigerant, which becomes very cold as its volume increases .
5. in the source-side exchanger the cold refrigerant evaporates and absorbs heat from the external environment through
  6. vertical geothermal probes
  7. horizontal geothermal probes
  8. collector well
9. the refrigerant at gaseous status is sucked up by the compressor and the cycle is repeated

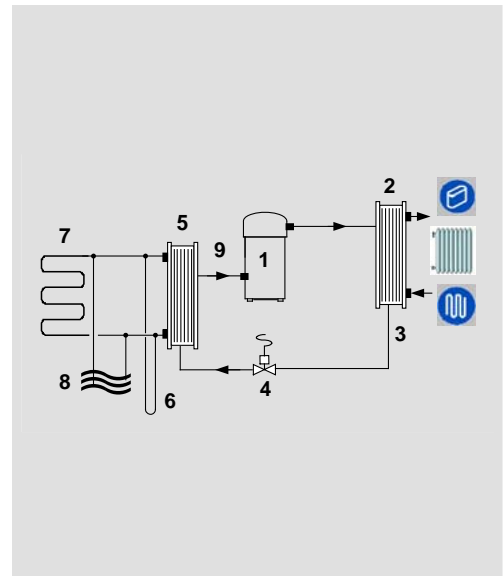

### WATER CIRCUIT





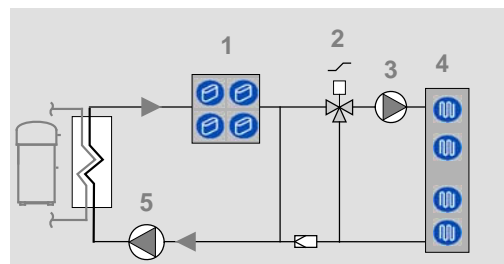

The diagram on the side is indicative and includes optional components; check with the installer about the system configuration used.

1. fan coil;
2. if the room needs to be heated, the 3-way valve diverts the water towards the underfloor piping (all or in part); if instead the underfloor piping is satisfied, it returns the water directly to the unit;
3. the pump keeps the water in circulation in the underfloor piping
4. radiant panels
5. the pump returns the water to the unit



**TO DO FOR:**

Some functions are active only if they are enabled during installation (remote ON-OFF, remote SUMMER WINTER change, remote ECO, sanitary hot water, set point compensation). Check with the installer about the configuration used.

Start the unit	LONG pressing of the ON/OFF button	
Choose the SUMMER mode possible also by external enabling (see ELECTRICAL CONNECTIONS)	“SUN” button Green led on	
Choose the WINTER mode * possible also by external enabling (see ELECTRICAL CONNECTIONS)	“SNOW-FLAKE” button Green led on	
Limit the energetic consumption Control by external enabling (see ELECTRICAL CONNECTIONS)	ECO button	
Choose the optimal comfort level	COMFORT button	
Activate the hot sanitary water production*	Through remote consent outside the unit “SNOW-FLAKE” button on “SUN” led is flashing	
Minimize the consumptions maintaining the system at a safety temperature in WINTER ( MAINTENANCE function)	Put the unit in OFF ( parameter 45 must be = 1) yellow led is flashing	
Minimize the consumptions maintaining the system at a safety temperature in SUMMER ( MAINTENANCE function)*	Put the unit in OFF ( parameter 44 must be = 1) yellow led is flashing	
Identify the cause of the unit shutdown	RED LED lit - flashing: the alarm resets automatically - on continuously: a manual reset is necessary	



**ELECTRICAL CIRCUIT ALARM**

- Inlet probe
- Outlet probe
- Radiant panel water probe
- Coil/flow probe
- External probe
- Pressure 1 probe
- Water reset inlet
- External relative humidity probe
- Phase monitor
- Electric heater output probe



**REFRIGERANT CIRCUIT ALARM**

- HP
- LP
- CCMP/VENT
- HP1 Pre-Alarm
- BP1 Pre-Alarm



**WATER CIRCUIT ALARM**

- Flow pump
- System charged with water
- Antifreeze alarm
- Antifreeze PREAlarm
- Pump alarm
- C1 PREAlarm
- PRad. Cooling limit alarm
- PRad. Water frost alarm
- Coil frost alarm
- Alarm ?T° incongruous
- Electric heater antifreeze alarm
- serial faulty alarm

serial faulty alarm

serial faulty alarm

\* **only WSHH**

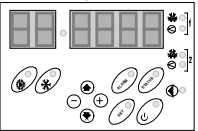
To reset the current alarm <b>ONLY AFTER THE CAUSE ELIMINATION !</b>	TEST + ON/OFF contemporary for some seconds	
Modify the HOT SANITARY water temperature*	Control parameter <b>117</b>	<p>Only by SERVICE keypad</p> 
Modify the water temp. in HEATING*	Control parameter <b>33</b>	
Modify the water temp. in ECO HEATING*	Control parameter <b>30</b>	
Modify the water temp. in COOLING	Control parameter ametro <b>32</b>	
Modify the water temp. in ECO cooling	Control parameter <b>29</b>	
Modify the water temp. in MAINTENANCE heating*	Control parameter parametro <b>43</b>	
Modify the water temp. in MAINTENANCE cooling	Control parameter <b>42</b>	

\* **only WSHH**

### COMMON CAUSES OF SHUTDOWN

1. set point too low (in summer) or too high (in winter)
2. water in system is too hot (in summer, for example with machine left off over the weekend) or too cold (in winter)
3. water filter dirty
4. external permissions (remote ON-OFF etc. )
5. water cut-off valves closed
6. system not pressurized - air needs to be vented
7. system pump off
8. circulator pump not running (after seasonal shutdown)
9. unit exchanger dirty

## GENERAL WARNINGS

### MANUAL PURPOSE

This manual has been designed to enable the unit to be installed, started up and maintained correctly.

### MANUAL INSTRUCTIONS

It is essential to observe these instructions.

The manufacturer declines all liability for any damage that may be caused whether directly or indirectly to persons or things if these instructions are not heeded.

### MANUAL STORE

This manual and the unit's wiring diagram should be carefully stored so that they are readily available to the operator when required.

### EXPERT PERSONAL

The unit must be installed, tested and maintained by expert personal who meet the relevant legal requirements (Italian law No. 46 of 5/3/1990).

### LOCAL SAFETY REGULATION INSTALLATION

The installation must be performed observing the local safety regulations.

### POWER SUPPLY

Make sure the power supply conforms to the data on the unit's rating plate, located inside the door of the main electrical panel.

### PACKAGING

The packaging material (plastic bags, polystyrene foam, nails, etc.) is potentially dangerous and should therefore be kept away from children and recycled in compliance with the local regulations in force.

### MAINTENANCE

Before performing any service operations, cut off the power. Perform the operations in conformity with the local regulations in force.

### PERIODICAL INSPECTIONS

Perform periodical inspections to locate possible loosened or broken parts. If the repairs are not performed, there will be a higher risk for things and peoples to become damaged and injured.

### FAULT – POOR OPERATION

Switch off the unit in the event of faults or poor operation.

### REPAIR

Only have repairs carried out by a service centre authorised by the manufacturer, and insist on the use of original spare parts only.

Failure to comply with the above may compromise the safety of the unit.

### MODIFICATIONS

The manufacturer will not accept any responsibility, and the warranty will lapse, in the event of electric and/or mechanical modifications. Any modification which is not formally authorized, and which does not respect the instructions given in this manual, will cause the warranty to lapse.

### INTENDED USE

The unit must only be used for the specific purpose it was designed :

**L'unità è destinata al raffreddamento/riscaldamento di acqua o acqua glicolata per il condizionamento con i limiti previsti dal bollettino tecnico e dal presente manuale.**

### HEATING = only WSHH

Any use other than that specified does not imply any commitment or constraint by the manufacturer in any way whatsoever.

### ADDITIONAL SAFETY PRECAUTIONS

This unit has been especially designed and manufactured so to prevent any risk to persons and health hazard.

For this reason, design solutions fit to eliminate (where possible) any cause of risk and sensibly reduce the probability of danger have been adopted.

Please refer to the "Residual Risks" section of this manual and strictly observe the behaviour prescriptions listed there in order to prevent any possible risk that hasn't been possible to avoid in the design stage.

### DATA UPDATING

The manufacturer may be able to modify the data without prior notice as a consequence of constant improvements.

## REGULATIONS AND CERTIFICATIONS

### UNI EN ISO 9001 CERTIFICATION

Clivet S.p.A., in order to guarantee customer satisfaction, has chosen the ISO 9001 Quality System as the reference for all its business activities. This is demonstrated by the company's commitment to ongoing improvements in the quality and reliability of its products; its sales, design, purchasing, production and after-sales service activities are the means used to reach such purpose.

### CE MARK



Clivet products bear the CE mark, in compliance with the requirements of the following EC directives, including the latest amendments, and with the corresponding national approximated legislation:

- - 98/37/CE
- - 89/336/CEE as modified by the directives 92/31/CEE and 93/68/CEE
- - 73/23/CEE as modified by the directive 93/68/CEE
- - 97/23/CE

### EUROVENT CERTIFICATION



Clivet is participating in the EUROVENT Certification Programme "Liquid Chilling Packages". Products are listed in the EUROVENT Directory of Certified Products and in the site [www.eurovent-certification.com](http://www.eurovent-certification.com). Eurovent Chillers Certification Programme covers air cooled packaged chillers up to 600 kW and water cooled packaged chillers up to 1500 kW.



## RESIDUAL RISKS

### GENERAL

This section lists some of the more common situations which, being beyond the control of the manufacturer, could be a source of risk to persons or property.

### DANGER AREA

The figure below highlights the area in which only authorised personnel may operate.

- **External danger zone**, identified by a precise area around the unit and its vertical projection on the ground in the case of hanging unit.
- **Internal danger zone**, identified by the area that can be entered only after having intentionally removed the protecting panels or parts of these.

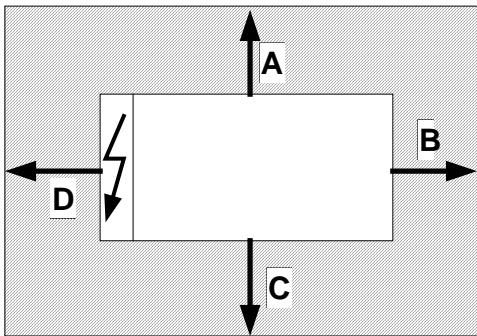

A = 2000mm                      B = 2000mm  
C = 2000mm                      D = 2000mm

### HANDLING

If handling operations are undertaken without adopting all the necessary safety procedures and exercising due care, the unit can fall or topple, causing damage — possibly extremely serious — to persons and/or property, and to the unit itself.

Ensure the unit is handled and manoeuvred as directed on the packing and in the present manual, and in accordance with local regulations.

In the event of refrigerant gas escaping, refer to the “Safety datasheet” for the particular refrigerant.

### INSTALLATION

Incorrect installation of the unit can result in water leaks, accumulation of condensate, escape of refrigerant, electric shocks, fire, as well as irregular operation or damage to the unit itself.

Make certain that the installation is carried out only by a qualified technician, also that the directions contained in this manual are followed and local statutory regulations observed.

In the event of the unit being installed in a site where there is even the slightest risk of inflammable gas escapes and consequently the possibility of such gases accumulating in area around the unit, the risk of explosion and fire cannot be discounted.

Take every care and precaution when selecting the installation site.

Installation on a structure not able to bear the weight and/or afford a secure anchorage of the equipment may cause the unit to fall and/or topple, resulting in damage to persons or property, or to the unit itself. Make certain that every care

and precaution is taken when positioning and securing the unit.

If the unit is easily accessible to children, unauthorized persons or animals, this is a situation that can give rise to accidents and injuries, perhaps serious. Install the unit in a place where access is allowed only to authorized persons, or install barriers or guards preventing unauthorized entry.

### GENERAL RISKS

A smell of burning, smoke or other indications of serious irregularity could signal the onset of situations liable to cause damage to persons or property or to the unit itself. Isolate the unit from the electrical power supply (red-and-yellow) switch.

Contact an authorized service centre so that the source of the problem can be identified and remedied.

Accidental contact with heat exchange coils, compressors, pressure pipelines or other components can result in wounding or burns, or both.

Always wear suitable clothing, including protective gloves, when working in the danger area.

Maintenance or repairs carried out by unskilled operatives can result in harm or damage to persons and property, or to the unit itself. Always contact an authorized service centre.

Failure to close the panels of the unit, or to check that all the fixing screws of the panels are properly tightened, can result in harm or damage to persons or property, or to the unit itself.

Verify periodically that all panels are closed and made properly secure.

In the event of fire, the temperature of the refrigerant can rise to the point that pressure will exceed safety levels and perhaps cause fluid to be projected. It may also happen that parts of the circuit isolated by closed valves will explode.

Do not stand near safety valves, and never leave the valves of the refrigerant circuit closed.

### ELECTRICAL SYSTEM

If the power line connecting the unit to the a.c. supply is incomplete, or if the connection is made with cables of incorrect cross section and/or with insufficiently rated protective devices, this can result in electric shock, toxicity hazard, damage to the unit or fire.

All work on the electrical system should be carried out referring to the wiring diagram and to the directions given in this manual, and the system itself must be dedicated.

Failure to secure the cover enclosing electrical components can lead to the infiltration of dust and water, ultimately causing electric shocks, damage to the unit, or fire.

Always fasten the cover securely to the unit.

If live metal parts of the unit are not connected properly to the earth system, they can cause electric shock or even death by electrocution.

Make absolutely certain that the connection to the earth system is made in accordance with correct practice.

Contact with live parts rendered accessible internally of the unit when the guards are removed can result in electric shock, burns or death by electrocution.

Before exposing these parts, make certain the isolating switch on the power line to the unit is set to the OFF position and padlocked, and post a warning sign.

Contact with parts that could become live when the unit is started up can result in electric shock, burns or death by electrocution.

When there is no need for circuits to be powered up, set the isolating switch on the power line to the OFF position, padlock it and post a warning sign.

#### MOVING PARTS

Contact with the fan rotors can cause injury.

Before removing the protective grilles or the fans themselves, make certain the isolating switch on the power line to the unit is set to the OFF position and padlocked, and post a warning sign.

Before removing the protective grilles or the fans themselves, make certain the isolating switch on the power line to the unit is set to the OFF position and padlocked, and post a warning sign.

#### REFRIGERANT

In the event of safety valves coming into operation and releasing refrigerant gas, persons in the vicinity can be

injured or suffer toxic effects. Always wear suitable clothing and protective goggles when working in potential hazard areas.

In the event of refrigerant gas escaping, refer to the "Safety datasheet" for the particular refrigerant.

If an open flame or heat source is brought into contact with the refrigerant, or the pressurized gas circuit should overheat (e.g. during welding operations), this can cause explosion or fire. Do not position any heat source within the hazard area.

Maintenance or repair operations involving welding must be carried out with the system emptied of refrigerant.

#### WATER SYSTEM

Defects affecting pipelines, connections or valves and other control componentry can result in water being leaked or sprayed from the system, occasioning damage to property or causing short circuits in the unit.

Make certain all hydraulic connections are securely made, following the directions given in the present manual.

### REFRIGERANT SAFETY CHARTS

#### R-410A

REFRIGERANT SAFETY CHARTS		
R-410A		
01	Identification of the product and of the supplier	Chart No FRIG 8 Product R-410A Identification of the supplier. See heading or bottom of page. No of emergency telephone. See heading or bottom of page.
02	Composition / information on ingredients	Substance/ Compound . Compound Elements / Impurities. It contains the following elements Difluorometan (R32) 50 % in weight Pentafluoroetan (R125) 50 % in weight CEE No Non applicable for mixtures. Commercial name /
03	Hazard identification	Hazard identification. Liquefied gas. Vapours are heavier than air and can cause choking by reducing the oxygen available for breathing. A rapid evaporation of the liquid can cause freezing. It can cause cardiac arrhythmia.
04	First aid measures	Inhalation. Do not administer anything to fainted people. Take to open air. Administer oxygen or practice artificial breathing if necessary. Do not administer adrenaline or similar substances. Contact with eyes. Rinse carefully with plenty of water for at least 15 minutes and consult a doctor. Contact with the skin. Rinse immediately with plenty of water. Immediately take off all contaminated cloths. Ingestion. Way of exposure not very probable.
05	Anti-fire measures	Specific hazards. Pressure increase. Dangerous combustible products. Halogen acids, traces of carbonyl halogens. Extinction means. You can use all extinction means available. Special methods. Cool the containers/tanks with sprays of water. Special protection means. In close spaces, use the self-breather.
06	Measures against the accidental leakages of the product.	Personal protections. Evacuate the personnel in safety areas. Foresee adequate ventilation. Use means of personal protection. Protection for the environment. It evaporates. Methods for eliminating the product. It evaporates.
07	Handling and stocking.	Handling and stocking. Assure a sufficient exchange of air and/or a suction system in work areas. Use only in well-ventilated rooms. Do not breathe vapours or aerosols. Carefully close the containers and keep them in a cool, dry and well-ventilated place. Keep in the original containers. Incompatible products. Explosives, inflammable materials, organic peroxides.

08	Check of the exposition / personal protection	<p>Personal protection. Assure adequate ventilation, especially in closed rooms.</p> <p>Control parameters. Difluorometan (R32): Recommended limits of exposition: AEL (8h and 12h TWA) = 1000 ml/m<sup>3</sup></p> <p>Pentafluoroetan (R125): Recommended limits of exposition: AEL (8h and 12h TWA) = 1000 ml/m<sup>3</sup></p> <p>Protection of respiratory tract. For the rescue and for service work in the tanks, use an autonomous breather. Vapours are heavier than the air and can cause choking by reducing the oxygen available for breathing.</p> <p>Protection for the eyes. Total protection glasses.</p> <p>Protection for the hands. Rubber gloves.</p> <p>Hygienic measures. Do not smoke.</p>
09	Chemical -physical properties.	<p>Relative density, gas (air=1) Heavier than air.</p> <p>Solubility in water (mg/l). Not known, but probably very low.</p> <p>Aspect. Colourless liquefied gas.</p> <p>Smell. Simile to ether.</p> <p>Point of ignition. Don't ignite.</p>
10	Stability and reactivity.	<p>Stability and reactivity. No decomposition if used following the instructions.</p> <p>Materials to avoid. Alkaline metals, earth alkaline metals, granulated metal salts, Al, Zn, Be etc. in powder.</p> <p>Dangerous decomposition products. Halogen acids, traces of carbonyl halogens.</p>
11	Toxicological information	<p>Local effects. Concentration substantially above the TLV value (1000 ppm) can cause narcotic effects. Inhalation of products at high concentration decomposition can cause respiratory insufficiency (pulmonary edema).</p> <p>Long-term toxicity. It has shown no carcinogenic, teratogen or mutagenic effects on animal experiments.</p> <p>Specific effects. A rapid evaporation of the liquid can cause freezing. It can cause cardiac arrhythmia.</p>
12	Ecological information	<p>Effects connected to ecotoxicity</p> <p>Pentafluoroetan (R125) Potential of global heating of halocarbidés; HGWP; (R-11 = 1) = 0.84</p> <p>Potential of ozone impoverishment; ODP; (R-11 = 1) = 0</p>
13	Disposal considerations	<p>General considerations. Do not drain where the accumulation can be dangerous</p> <p>Usable as reconditioning.</p> <p>Depressurized containers should be given back to the supplier.</p> <p>Contact the supplier if the use of instructions is necessary.</p>
14	Transport information	<p>Designation for the transport LIQUEFIED GAS N.A.S (DIFLUOROMETAN, PENTAFLUROETAN)</p> <p>UN No 3163</p> <p>Class/Div 2.2</p> <p>ADR /RID Nr 2, 2°A</p> <p>No hazard ADR/RID 20</p> <p>ADR Label. Label 2: not toxic gas not inflammable.</p> <p>CEPIC Groupcard 20g39 - A</p> <p>Other information for the transport. Avoid the transport on vehicles where the loading zone is not separated from the driver compartment.</p> <p>Verify that the driver is informed on the potential risk of the load and that he knows what to do in case of an accident or emergency.</p> <p>Before starting the transport, verify that the load is well fixed and:</p> <p>Verify that the container valve is closed and does not leak</p> <p>Verify that the blind cap of the valve, if supplied, is correctly assembled.</p> <p>Verify that the cap (if supplied) is well assembled and that there is adequate ventilation</p> <p>Verify that the norms in force are respected.</p>
15	Information on the norms in force	<p>The product must be labelled according to the 1999/45/CE normative.</p> <p>Observe the following norms, the relevant updating and the applicable modifications:</p> <p>Circulars no.46/79 and 61/81 of the Work Ministry: risks connected to the use of products containing aromatic amines.</p> <p>Law Decree no. 133/92 : Norms relevant to the draining of dangerous substances in water</p> <p>Law Decree no. 277/91: Protection of workers for noise, lead and amianthus</p> <p>Law 256/74, Ministerial Decree of 28th Jan. 1992, Legislative Decree no 52 of 3rd Feb. 1997, Ministerial Decree of 28<sup>th</sup> Apr. 1997 and following modifications: Classification, packaging and labelling of compounds and dangerous substances</p> <p>Decree of the Republic President no.175/88, following modifications and updating: Activities with risks of serious accidents (Seveso Law)</p> <p>Decree of the Republic President no 203/88: Emissions in the atmosphere</p> <p>Decree of the Republic President no.303/56: Hygiene of work</p> <p>Decree of the Republic President no.547/55: Norms concerning the accident prevention</p> <p>Legislative Decree. No.152 of 11th May 1999: Protection of waters.</p>
16	Other information	<p>Suggested uses. Refrigerant.</p> <p>High concentrations can cause asphyxia.</p> <p>Keep in a dry and well-ventilated place.</p> <p>Do not breathe in the gas.</p> <p>The asphyxia risk is often under-evaluated and must be put into evidence during the operator's training.</p>

Verify that all national and regional regulations are observed.

Before using this product in any new process or experiment, a deep study about the safety and the product compatibility with the materials must be performed.

The above information is based on our present know-how and describes the product considering the safety needs. However, they do not represent a guarantee and a warranty of the qualities in a juridical sense. Everyone is personally responsible for the observation of these norms.

Information present in this document is valid at the time of printing. The company is not responsible for any damages caused by the incorrect use of the product and/or for the use in conditions different from the conditions suggested.

## RECEPTION

### INSPECTION UPON RECEPTION

Check on arrival that the unit has not suffered damage during transit and that it is complete in every part as specified in the order. In the event of visible damage/deficiencies being discovered, make a note immediately on the delivery document with the comment: **CONDITIONAL ACCEPTANCE — CLEAR EVIDENCE OF DEFICIENCIES/DAMAGE DURING TRANSIT**

Inform both the supplier and the carrier of the details by fax and by registered mail with advice of receipt not later than 8 days after taking consignment. Notifications sent after 8 days have elapsed will be ignored.

### STORAGE

Shelter from: direct sunlight, rain, sand and wind

Temperature: maximum 60°C minimum -10°C

Maximum humidity: 90%

The respect of the instructions on the exterior side of the packaging assures the physical and functional integrity of the unit for the final user's advantage.

It is recommended to:

- Handle carefully
- Keep in a dry place
- Avoid putting other objects on top of the unit (respect the limits of levels of superimposition shown in the package)
- Avoid placing the unit with thermoretractable protection under the sun since the pressure of the circuits can assume values which activate the safety valves.

### HANDLING

The operation of handling the unit must be carried out respecting the instructions of the safety norms in force (Legislative Decree 626/94 and following modifications)

Before starting the handling operations:

- Value the critical points during handling (stairs, flights, disconnected routes, doors, etc)
- Verify that the lifting capacity of the means used is adequate to the unit weight
- Consider that the barycentre could be moved with respect to the center of the unit
- Before starting to lift, verify that the unit is at a stable balance

The following examples are indications; the choice of the means and of the handling modes will depend on factors, such as:

- The unit weight
- Type and overall dimensions of the unit
- Place and route for the handling (dirt yard, asphalted square, etc)
- Condition of the place of destination (roof, square, etc)
- Handling distance characteristics (distances, flights, steps, doors)

### LABELS / YELLOW BRACKETS SHOW THE LIFTING POINTS

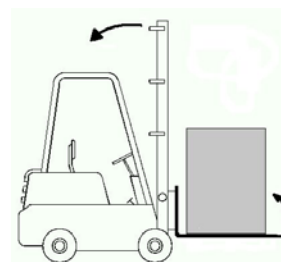
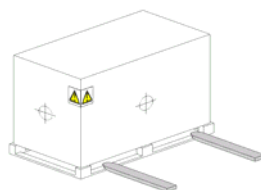
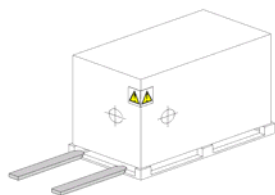

### REMOVING THE PACKING

For removing the packaging, use specific personal protection for the operator (gloves, glasses, etc.).

While removing the packaging, pay attention not to damage the unit.

Check for any visible damage.

Dispose of the packaging by taking it to specialist collection or recycling centres in accordance with local regulations.

## POSITIONING

### GENERAL

For installing air-conditioning systems, it is necessary to consider the following:

- the technical spaces necessary for the machine and system
- the place where the machine will be installed
- the transport of thermal carrier fluids and relevant connections to the unit:
  - water
  - air
  - refrigerant (unit in more sections)
- electrical connections

If these aspects are not evaluated carefully, they can affect the performances and the working life of the unit.

### FUNCTIONAL CLEARANCES

When placing the unit, please respect the functional clearances indicated in DIMENSIONS section.

The functional spaces need to be observed because of the following:

- to guarantee the good operation of the unit
- to allow the performance of all maintenance operations
- to protect the authorized operators and exposed people

If more units are placed close to one another, the functional spaces must be doubled.

### POSITIONING

1. The units are designed for **INDOOR** installations, performed in fixed positions and in areas accessible only to qualified and authorized personnel
2. **SAFETY VALVE** (only if present on the unit) : the installer is responsible for evaluating the opportunity of installing drain tubes, in conformity with the local regulations in force ( EN 378 )
3. Install the unit **raised** from the ground
4. avoid installations in places subject to **flooding**
5. Verify that the fixing/supporting points are level and suitable to support the **weight of the unit** (see the weight and the weights distribution)
6. It is recommended to put the unit on specific **antivibration devices**

Each support point of the unit sustains a different weight. Therefore, each anti-vibration device is sized for a specific support point, and can only be placed there. The anti-vibration devices must therefore be placed in accordance with the instructions provided with them and with the dimensional drawings in which the support points are indicated by W1 , W2 , W3 etc .

On each anti-vibration device (if provided by CLIVET), its identifying code is stamped, for example C6100100

**Flexible joints** are necessary on all the hydraulic/aerualic connections (the joints are not supplied by Clivet)

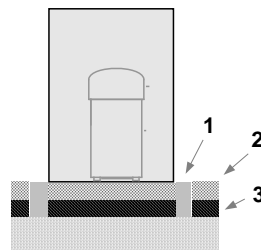

1. elastic joint
2. floating floor
3. soundproofing

Prevent the transmission of vibrations.

# WATER CONNECTIONS

## GENERAL

Piping must be designed with the least possible number of bends and head variations. If the pressure chute of the installation is above the useful prevalence of the pump, the water delivery capacity is reduced as well as, as a consequence, the thermal exchange and the yield.

## INTERCEPTING VALVES

Install on the input and output of the user parts (exchangers, coils, humidifiers, etc) So that it will be possible to carry out all the service operations and possible substitutions without emptying the installation.

## PRESSURE AND TEMPERATURE INDICATOR

Install on the input and output of the user parts (exchangers, coils, humidifiers, etc) So that it will be possible to carry out all the service operations.

## AUTOMATIC OR MANUAL ESCAPE VALVES

Install the highest points of tubes in a way that the air can escape from the circuit.

## BLEEDING COCK

Install them at the lowest points of the circuit, so as to allow emptying.

## LEAKAGE TESTS

Before performing the insulation of the tubes, carry out a leakage test.

## TUBE INSULATION

All tubes of water must be insulated so that to avoid the formation of condensation and thermal dispersions along the tubes themselves. Verify that the insulation is the vapour coil type. The connections for the air escape and for the emptying must be out of the insulating thickness to assure the accessibilità.

## CONNECTIONS SUPPORTS

The weight of the hydraulic connections must be supported in the exterior of the unit so as not to stress the connections of user devices (exchangers, coils, humidifiers, etc) .

## ANTI-VIBRATION DEVICES

In case of units with anti-vibration devices, it is necessary to assemble elastic joints, even on water connections.

## RISK OF FREEZE

If the unit and the relevant water connections are subject to temperatures near 0°C:

- mix the water of the system with glycol
- protect the tubes with heating cables under the tubes insulation
- empty the system by verifying that:
  - no taps are closed so they can not trap the water, even after emptying
  - there are no low points where the water can stagnate even after emptying; blow if necessary

## INSTALLATION EMPTYING

The refilling of the water present in the installation increase the oxidation phenomena and lime deposits.

If necessary empty only the interested system section and anyway empty or refill the installation if necessary .

## EXPANSION TANK

The installation must be kept at the right pressure by both an expansion tank and a combined valve of pressure reduction and discharge; if the components are present on the unit, they must be installed on the installation. The expansion tank must be dimensioned in function of the water in the installation.

# EXCHANGER USE SIDE

## FILTER

It is very important for the water to be free of impurities. If it is not, the efficiency of thermal exchange is diminished. In worst cases, the exchanger can be irreparably damaged. If the filter is not present on the machine, it must be immediately installed upstream from the unit, in a position which can be easily reached for cleaning

## FLOW SWITCH

The flow switch must be present as a component of the system, so as to ensure shutdown of the unit if water is not circulating. It must be installed in a straight tract of the tubes, not near the elbows, which can generate harmful turbulence

## UNFREEZABLE LIQUIDS

If the unit is used when the water temperature is lower than + 4°C, avoid the formation of ice by using unfreezable liquids (ex. Ethilenic Glycol) in the necessary percentage. The use must also be determined for room temperatures near 0°C .

## ANTIFREEZE HEATERS

If the unit is equipped with antifreeze heaters on the exchanger side (standard or optional according to the models), verify that they are electrically fed during periods that the machine is stopped (night, weekends, long stops)

## WASHING THE SYSTEM

Carefully wash the system by using clean water and discharge it before connecting the unit.

## DIAGRAM OF RECOMMENDED USE SIDE CONNECTION

Depending on the type of machine and the selected setup, some components may be integrated into the unit.

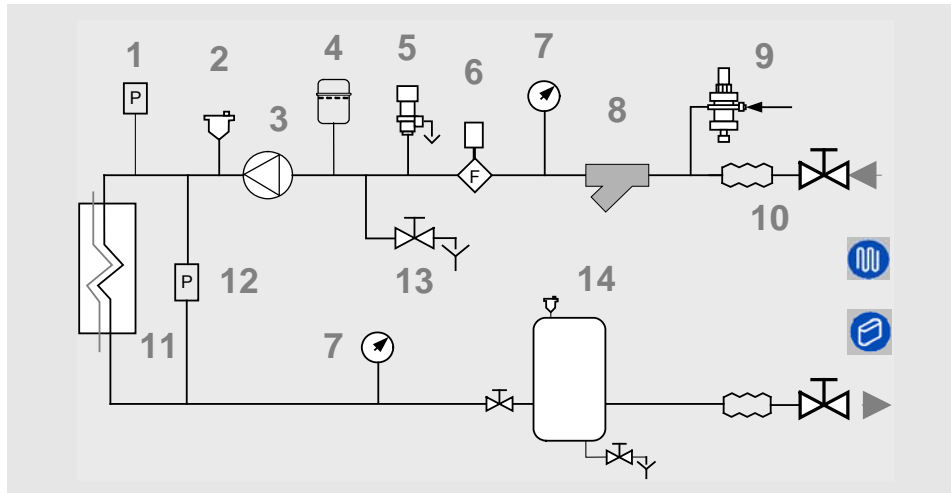

1. Charged system pressure switch
2. vent
3. pump
4. expansion tank
5. safety valve
6. flow switch
7. pressure switch / thermometer
8. filter
9. filling valve
10. antivibration joints
11. user side exchanger
12. Differential pressure switch
13. Discharge cock
14. inertial storage tank

The accumulation tank is necessary in the event of the following:

- the water in the system is very low
- the unit will not be used in a private house (in an industrial process or other)

## USE SCHEMA

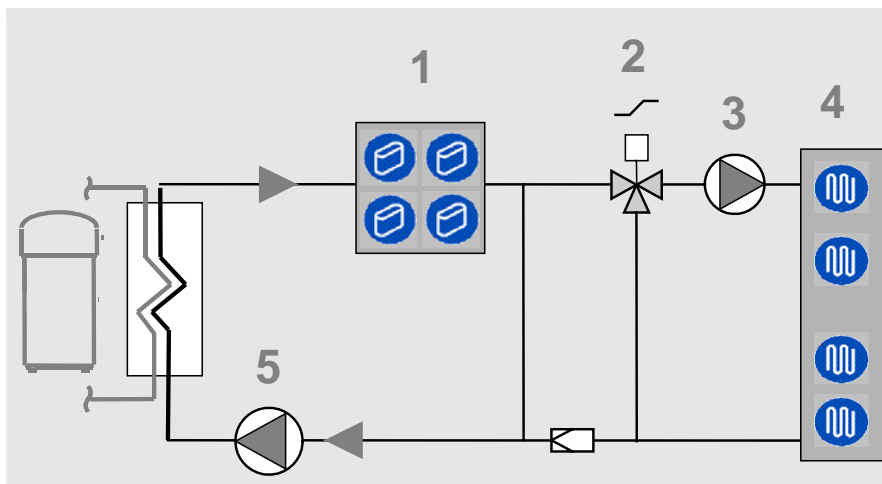

1. fancoil
2. 3-ways radiant panels
3. radiant pump
4. radiants
5. pump

for more details see the ELECTRICAL DATA section

## RECOMMENDED SOURCE SIDE CONNECTION SCHEMA

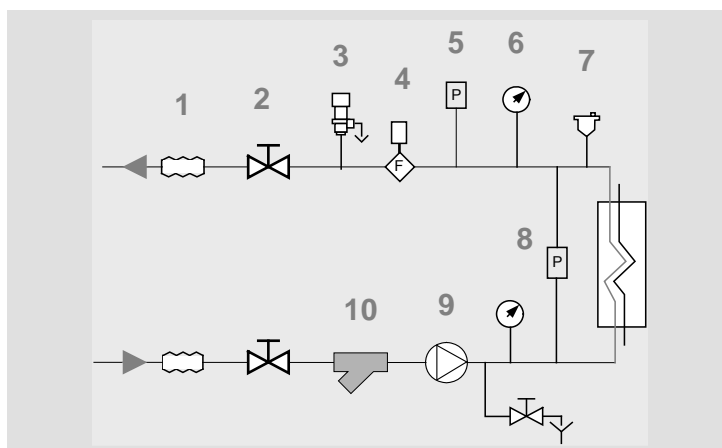

1. Antivibration joints
2. Shut-off valve
3. Safety valve
4. Flow switch
5. System min. pressure manostat
6. Pressure switch / thermometer
7. vent
8. Differential pressure switch
9. Pump
10. Filter

## SYSTEM MEASURES ON SOURCE SIDE

### FILTER

It is very important for the water to be free of impurities. If it is not, the efficiency of thermal exchange is diminished. In worst cases, the exchanger can be irreparably damaged. If the filter is not present on the machine, it must be immediately installed upstream from the unit, in a position which can be easily reached for cleaning

### FLOW SWITCH

The flow switch must be present as a component of the system, so as to ensure shutdown of the unit if water is not circulating. It must be installed in a straight tract of the tubes, not near the elbows, which can generate harmful turbulence

### UNFREEZABLE LIQUIDS

If the unit is used when the water temperature is lower than + 4°C, avoid the formation of ice by using unfreezable liquids (ex. Ethilenic Glycol) in the necessary percentage. The use must also be determined for room temperatures near 0°C. Its use is also required when geothermal probes are used.

### WASHING THE SYSTEM

Carefully wash the system by using clean water and discharge it before connecting the unit.

### CONTROL OF FLOW RATE

This makes it possible to limit water consumption, increase energy efficiency and extend the unit's operating limits. It can be modified by using

1. Modulating motorized valve
2. Cut-off valve
3. Pressure switch valve

#### MODULATING VALVE

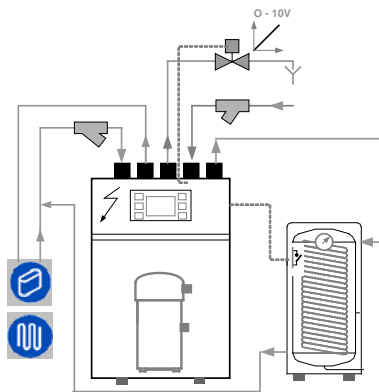

#### MODULATING MOTORIZED VALVE

This valve makes it possible to modulate the water flow rate on the source side according to its temperature, thus extending the operating limits of the unit. The modulating valve is controlled by the unit's electronic control.

#### PRESSOSTATIC VALVE + BYPASS VALVE

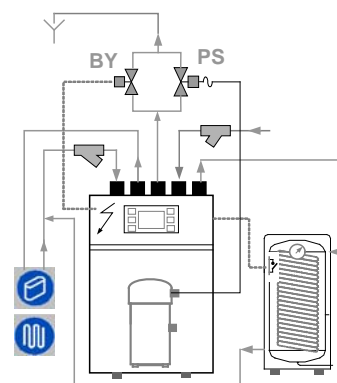

#### PRESSURE SWITCH VALVE PS

Allows modulation of the water flow rate based on its temperature (in summer operation only). It must be connected to the outlet pipe of the compressor with a capillary.

#### VI SHUT-OFF VALVE

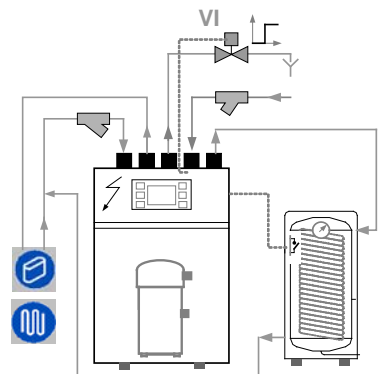

#### CUT-OFF VALVE VI

This allows cut-off of water on the source side whenever the compressor is not running. It is therefore advisable for once-through water systems if there is no modulating valve.



## MANAGEMENT OF SYSTEM ELEMENTS ON UTILITY SIDE

The system can manage the following optionals.

The diagrams are indicative: check the position of the water connections on the dimensional drawing of the unit or on the adhesive labels on the unit itself

### 3-way valve for sanitary hot water\*

The valve is activated by external consent; when activated, the set point of the unit is set to the sanitary hot water set point (see details in the ELECTRICAL CONNECTIONS section)

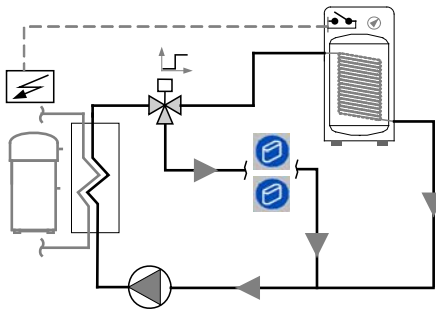

### double temperature - underfloor heating

manages the elements of a mixed system with underfloor piping + fan coil / radiators: circulator, mixer valve, outlet probe (see details in the ELECTRICAL CONNECTIONS section)

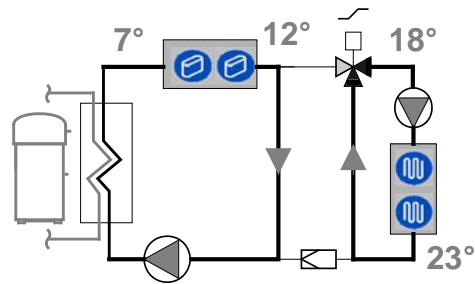

### coupling with boiler\*

Below a certain external temperature, the boiler is activated and the unit disabled. (see details in the ELECTRICAL CONNECTIONS section)

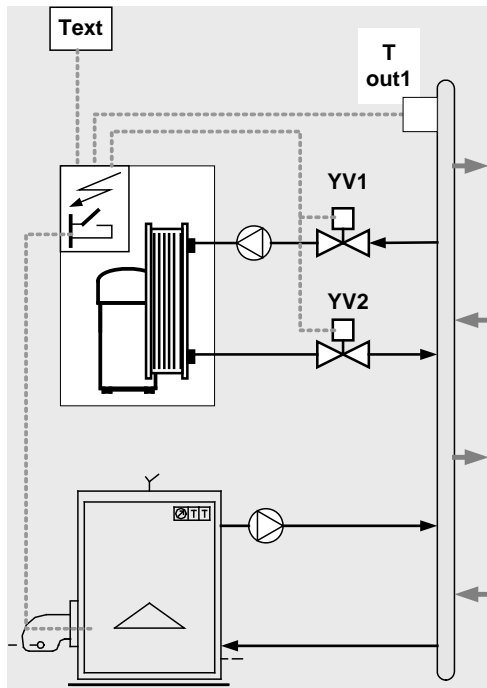

### Additional heating\*

It is possible to control an external element for additional heating with an ON-OFF or modulating control. (see details in the ELECTRICAL CONNECTIONS section)

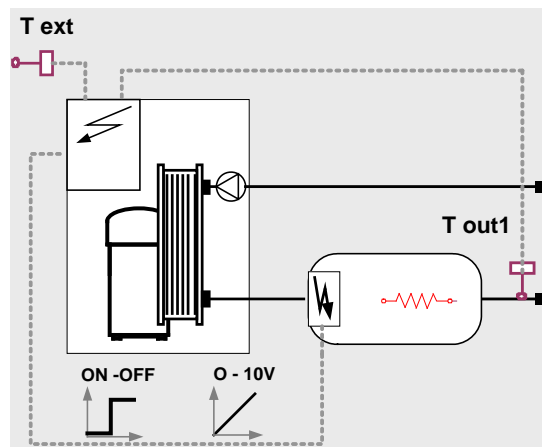

\* **only WSHH**, with reversibility summer/winter on the water circuit performed by the customer.

## ELECTRICAL CONNECTION

### GENERAL

The characteristics of the electrical lines and relevant components must be determined by SPECIALIZED PERSONNEL ABLE TO DESIGN ELECTRICAL INSTALLATIONS; moreover, the lines must be in conformity with professional procedures and the regulations in force.

All electrical operations should be performed by trained PERSONNEL HAVING THE NECESSARY REQUISITES UNDER LAW and being informed about the risks relevant to these activities.

Before performing any operation on the electrical system, make sure that the unit supply line is SELECTED AT START.

The earth connection must be made prior to other electrical connections.

For all electrical type operations, REFER TO THE ELECTRICAL DIAGRAM ATTACHED TO THE UNIT; the number of the diagram is shown on the registration plate positioned on the electrical board or next to it.

The electrical diagram should be carefully kept together with this manual and should be AVAILABLE FOR FUTURE INTERVENTION ON THE UNIT.

#### LINE OF UNIT POWER SUPPLY

The ELECTRICAL DATA OF THE UNIT are shown in the technical chart of this manual and on the unit registration plate. The presence of accessories can vary according to the unit; the electrical data shown in the technical chart

refer to standard units. In the event of differences between the data of the registration plate and the data shown in this manual, as well as in the technical chart, please refer to the DATA SHOWN IN THE REGISTRATION PLATE.

The protection device of the unit power supply line should break off the short circuit power whose value should be determined according to the plant features.

The section of supply cables and protection cable must be seized according to the characteristics of the protections used.

#### SIGNALS / DATA LINES

Do not overpass the maximum power allowed, which varies, according to the type of signal.

Lay the cables far from power cables or cables having a different tension and that are able to emit electromagnetic disturbances.

Do not lay the cable near devices which can generate electromagnetic interferences.

Do not lay the cables parallel to other cables; cable crossings are possible, only if laid at 90°.

Connect the screen to the ground, only if there are no disturbances

Assure the continuity of the screen during the entire extension of the cable.

Observe, if any, the requirements about impendancy, capacity, attenuation

### STANDARD UNIT ELECTRICAL DATA

#### Voltage: 230/1/50

Size		17	21	31	41
<b>F.L.A. FULL LOAD CURRENT AT MAX ADMISSIBLE CONDITIONS</b>					
F.L.A. – Pump	A	0,95			
F.L.A. – Total	A	13,85	14,75	18,48	23,15
<b>F.L.I. FULL LOAD POWER INPUT AT MAX ADMISSIBLE CONDITION</b>					
F.L.I. – Pump		0,2			
F.L.I. – Total	kW	2,97	3,25	4,05	4,99
<b>M.I.C. MAXIMUM INRUSH CURRENT</b>					
M.I.C. - Value	A	58,95	61,95	82,95	98,02

power supply 230/1/50 Hz +/-6%

#### Voltage: 400/3/50+N

Size		17	21	31	41	51	61	71	81	91	101	121
<b>F.L.A. FULL LOAD CURRENT AT MAX ADMISSIBLE CONDITIONS</b>												
F.L.A. – Pump	A	0,95	0,95	0,95	0,95	0,95	2,02	2,02	2,02	2,02	3,81	3,81
F.L.A. – Total	A	5,35	5,75	7,85	8,55	11,25	13,22	16,32	17,52	18,52	24,51	26,61
<b>F.L.I. FULL LOAD POWER INPUT AT MAX ADMISSIBLE CONDITION</b>												
F.L.I. – Pump	kW	0,2	0,2	0,2	0,2	0,2	0,4	0,4	0,4	0,4	0,55	0,55
F.L.I. – Total	kW	2,98	3,29	3,83	4,54	6,3	7,05	8,7	9,5	10,6	12,55	13,95
<b>M.I.C. MAXIMUM INRUSH CURRENT</b>												
M.I.C. - Value	A	27	33	36	49	65	76	103	97	113	120	120

power supply 400/3/50 (+ NEUTRAL) +/- 6%  
Maximum Phase Unbalance: 2%

## CONNECTION TO THE MAINS

1. Make sure that the sectioning device at the beginning of the unit's power line is opened, locked and equipped with a signal.
2. Open the general line disconnecting switch (if present)
3. Verify that the net is in conformity with the data shown in the registration plate placed on the electrical board.
4. Check the dimensional drawing for the input of the electrical lines
5. Take away the closing plate placed on the electric board (ONLY IF PRESENT) and drill a hole through it to pass the cables through)
6. Protect the cables, using the fairlead of an adequate size.
7. Using the layout of the electrical diagram, single out the connecting terminals of the electrical supply cables, of the neutral (if foreseen) and the PE protection cable
8. Connect the cables to the relevant terminal boards
9. Before supplying power to the unit, make sure that all the safety devices that were removed during electrical connections are positioned again.

## SYSTEM COMPOSITION

The system is composed of the following modules; some are optional that could be not installed. Some are supplied in packages separate from the unit: check the shipping document descriptions.

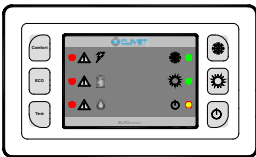

### USER AMBIENT TERMINAL

Permits setting the unit function modes (cooling – heating, ECO) and to display the alarms (ELECTRIC, REFRIGERATOR, WATER). This is standard on certain types of unit

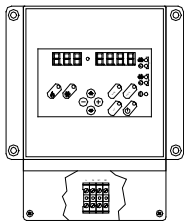

### REMOTE KEYPAD

OPTIONAL

The interface terminal enables to control every machine function, to program the different adjustment parameters and possibly to display the unit statuses and alarms. It remotely repeats all functions available on the machine keyboard

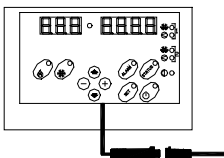

### SERVICE KEYPAD

OPTIONAL

Useful during the maintenance operations; it is fitted with a cable with automotive rapid connector for the utilisation in proximity to the unit. The functionalities are analogous to the remote keypad ones.

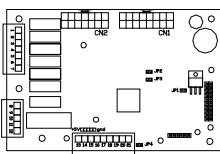

### MAIN ADJUSTMENT MODULE

It controls unit (inlets, outlets, configuration parameters)

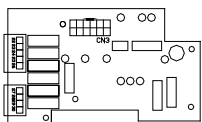

### EXPANSION PLUG-IN MODULE

It is connected to the main module by a coupling comb.

This may be fitted on the unit depending on the unit type and the accessories that are installed.

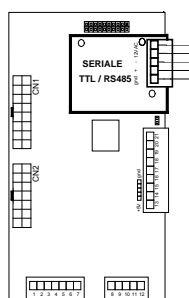

### SERIAL CONVERTER TTL/RS485

OPTIONAL

Plugged-in in the main module on the electric board (see lay in the wiring diagram). It is possible to connect up to 127 units with a single supervision system.

The connection with a PC must use a RS485/232 converter; the serial line RS232 can be max. 10-m long.

CONNECTIONS:

make reference to the electrical panel and to the SIGNALS AND DATA LINES paragraph

## FUNCTIONAL CONNECTIONS

FOR ALL THE CONNECTIONS MAKE REFERENCE TO THE ELECTRICAL PANEL SUPPLIED WITH UNIT

Use voltage-free remote control devices that are suitable to commutate very low loads (12V, 10mA)

Few inputs must be activated by configuration parameters whose access is reserved to authorized assistance centres (in order to avoid unauthorized modifications)

1. remote ON / OFF
2. remote SUMMER / WINTER \*
3. remote SECOND SET POINT (ECO )
4. Machine OPERATION / SHUTDOWN SIGNAL
5. REMOTE KEYPAD
6. ELECTRIC INTEGRATION during heating \*
7. coupling with BOILER \*
8. SANITARY HOT WATER \*
9. UNDERFLOOR HEATING
10. SET POINT COMPENSATION for outside temperature/enthalpy
11. SET POINT COMPENSATION with 4-20 mA signal
12. interface via RS485

### 1. ON / OFF FROM REMOTE CONTROL

Generally the unit is delivered with bridged terminals; if the control is not used, the bridge should not be removed

### 2. CHANGING FROM SUMMER TO WINTER USING THE REMOTE CONTROL \*

This function is activated with the 163 remmode = 1 parameter.

Selection switch open – unit in heating mode, selection switch closed – unit in cooling mode, this way the keyboard or supervisor unit selection is deactivated.

### 3. SECOND SET POINT FROM REMOTE CONTROL (ECO)

Use of a second set point (par 29 cooling, par 30 heating), usually higher in summer and lower in winter (ECO). The commutation can be also performed manually by keypad.

The SANITARY HOT WATER option may entail modifications of the input in question: see the relative section.

### 4. SIGNALIZATION OF MALFUNCTIONING/ UNIT FUNCTIONING

Remote signalisation of the proper function (ex. green light) or signalisation of blocks of the machine (ex. red light).

Maximum voltage at the terminal ends is 24v ac and maximum power is 1A (ac1) .

### 5. REMOTE KEYPAD

Max. Length	100 metres
VOLTAGE	230/1/50
Signal conductor number	2 + shield
Min. length	0.34 mm <sup>2</sup>

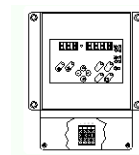

\* **only WSHH**, with reversibility summer/winter on the water circuit performed by the customer.

### ADDITIONAL HEATING ELEMENT \*

Allows to check the presence and correct phase sequence of the electrical power supply.  
It is supplied separately and must be assembled in the unit's electrical panel by the customer.

It is possible to control an external element for additional heating, typically electric heaters.

The control can be:

- ON-OFF ( max 1 A )
- modulating WITH SIGNAL 0-10 V

(in this case a plug-in expansion module is necessary, an optional that must be assembled by the customer (refer to the instructions in the kit) and enabled with the parameter 140=1  
The diagram on the side is indicative: check the position of the water connections on the dimensional drawing of the unit or on the adhesive labels on the unit itself.

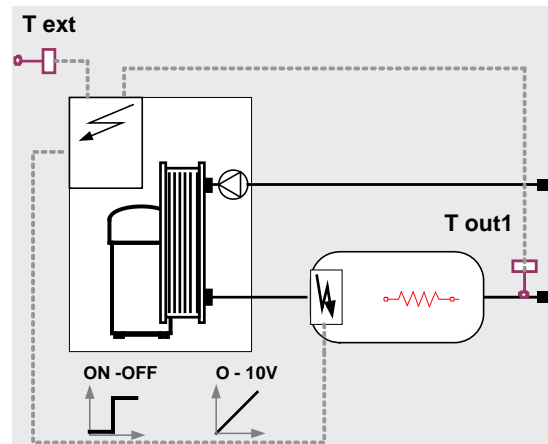

The parameters 178 and 179 can be used to select the behaviour of the heaters:	P 178	P 179
AS AN ADDITIONAL ELEMENT ONLY the heaters are considered as a second power step	1	0
IN REPLACEMENT OF THE COMPRESSOR the heaters operate only when the compressor is disabled due to an external temp. lower than par. 180	1	1
MAIN ADJUSTMENT UNIT IN HEATING MODE in heat pump mode the compressor is disabled	2	1
POWER LIMITATION ACCORDING TO EXTERNAL TEMPERATURE the following behaviour occurs as the external temperature decreases: 1st Zone = Compressor Enabled / Heaters Disabled 2nd Zone = Compressor Enabled / Heaters Enabled 3rd Zone = Compressor Disabled / Heaters Enabled	2	2

It is necessary to declare the presence of the outlet probe **Tout 1** with par. 70 = 1.

This probe becomes the reference for heat adjustment in heating mode; furthermore it manages the antifreeze protection for this part of the system.

par	Description	Meaning	value
70	Tout1En	Enables output probe	
140	PlugInEn	Enables PLUG-IN presence . 1=YES / 0=NO	
177	PotRes	Power provided by the additional heaters	100
178	ModeHeater	Enable compressor operation in heating	0
179	LimPotTextEn	Enable capacity limit for ext. temperature	0
180	LimText	Ext. temperature limit for compressor operation	0
181	IstRes	Differential on LimText value for heaters activation	5

\* only WSHH

## 6. COUPLING WITH BOILER \*

This function allows the unit to be coupled to a boiler with "high temperature" thermostat setting (70 °C for example), i.e., with a working point above the operating limits of the unit.

The coupling to the boiler is managed using:

- the external air temperature probe **Text** that disables the unit and activates the boiler for external temperatures less than the threshold set by parameter 88
- valves **YV1** and **YV2** that disconnect the unit from the system when the water temperature of the system detected by the probe **Tout1** is above the operating limit set by parameter 86

It is not possible to switch to the boiler in case of unit shutdown.

### MAINTENANCE

With the unit coupled to a boiler the maintenance function, if enabled, activates the boiler instead of the heat pump if necessary.

The diagram on the side is indicative: check the position of the water connections on the dimensional drawing of the unit or on the adhesive labels on the unit itself.

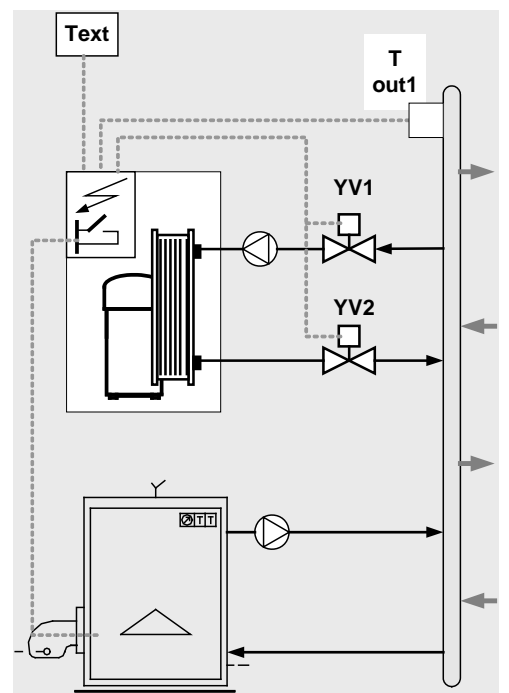

Par	Description	meaning	Default	U. m.
85	CaldaiaEn	Enable Boiler+Heat Pump Function	0	float
86	SogliaMaxImp	Water temperature value above which the heat pump is disabled and the output YV1 / 2 remains energized	55	°C
87	IsteresiSMI	Hysteresis for heat pump activation and YV1 / 2 deactivation	2	°C
88	SogliaExt	External temperature threshold below which the Boiler is enabled	-5	°C
89	IsteresiExt	External temperature hysteresis for heat pump activation	3	°C
70	Tout1En	Enable probe output		

\* only WSHH

## 7. CONTROL OF THE 3-WAY VALVE FOR SANITARY HOT WATER \*

Sanitary hot water can be produced in summer and winter, based on an **external request**, by controlling a dedicated 3-way valve.

When the contact is closed, the valve switches to the sanitary hot water storage and the unit changes its working set point to the sanitary hot water set point (par 117).

The passage from SANITARY HOT WATER mode to COOLING (or vice versa) is timed and occurs only when the temperature of the water has dropped below the safety limit defined by parameter 108.

Similarly, in the passage from SANITARY HOT WATER to HEATING the switching occurs when the temperature of the water has increased beyond the safety limit defined by parameter 109.

This function requires the optional **plug-in expansion module** that must be assembled by the customer (refer to the instructions in the kit ) and enabled with the parameter 140 = 1.

To enable the SANITARY HOT WATER management in summer as well, par. 119 must be = 1

If the SANITARY HOT WATER set point is satisfied but the external request remains active, the **INCONGRUENT THERMOSTAT C36 shutdown is signalled**: the sanitary hot water boiler thermostat must be set to the same value as the sanitary hot water set point of the machine.

If remote control will also be used for the SECOND SET POINT, it is necessary to set par. 50 = 2. In this mode the inputs on the main card will be configured as follows:

- CN1\_10/11 sanitary hot water request
- CN1\_14/16 second set point

Refer to the wiring diagram to identify the corresponding terminals

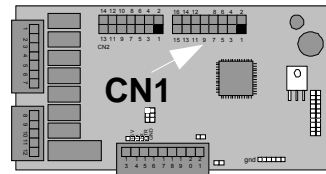
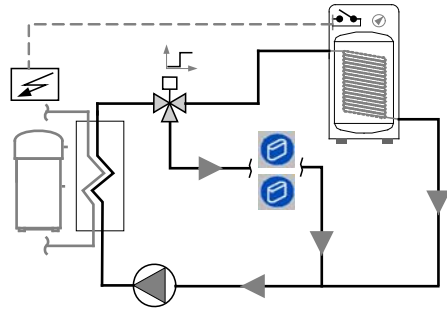

PLUG IN module

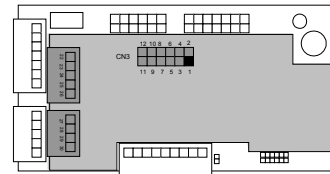

par	Description	Meaning	value
49	Comando2°Set	Mode control 2° set point by parameter	0
50	EnH2OSanitaria	Enabling sanitary water valve management	0
108	TlimiteCool	H2O input value below which the compressor is enabled in cool mode	21
109	TlimiteHeat	H2O input value above which the compressor is enabled in heat mode	25
117	SetH2OSanitaria	Set Point sanitary water	35
119	ModeEnable	Configure operation mode	
140	PlugInEn	Enables the PLUG-IN presence. 1=YES / 0=NO	

With par. 50 = 1 the management becomes the following:

- CN1\_10/11 unconfigured
- CN1\_14/16 second set point / sanitary hot water

MODE	INPUT 2° set point on the main board	VALVE POS.	SET POINT	2° SET POINT
HEATING	ON	to the installation	set heat	2° set point heat *
SANITARY WATER	OFF	<b>to the boiler</b>	<b>SetH2OSanitary</b>	<b>Not manageable</b>
COOLING	ON	to the installation	set cool	second set point cool *

In this mode the 2nd set point (ECO) cannot be enabled by remote consent; it can be enabled from the LED keypad with the ECO key or by setting parameter 49 = 1

\* only WSHH

**SANITARY HOT WATER: COMPENSATION OF THE SET POINT FOR EXTERNAL TEMPERATURE \***

The set point can be compensated according to the external temperature in 2 modes:

1. hot season thermal efficiency curve  
 when the external temperature is high, the sanitary hot water set point is decreased; in this manner the thermal efficiency is increased  
 curve A in the graph  
 the compensation is enabled in the standard configuration
2. compressor operation limit  
 when the external temperature is particularly cold, the sanitary hot water set point is decreased in order to guarantee operation of the compressor even near its operation limits  
 curve B in the graph  
 the compensation must be enabled during start-up

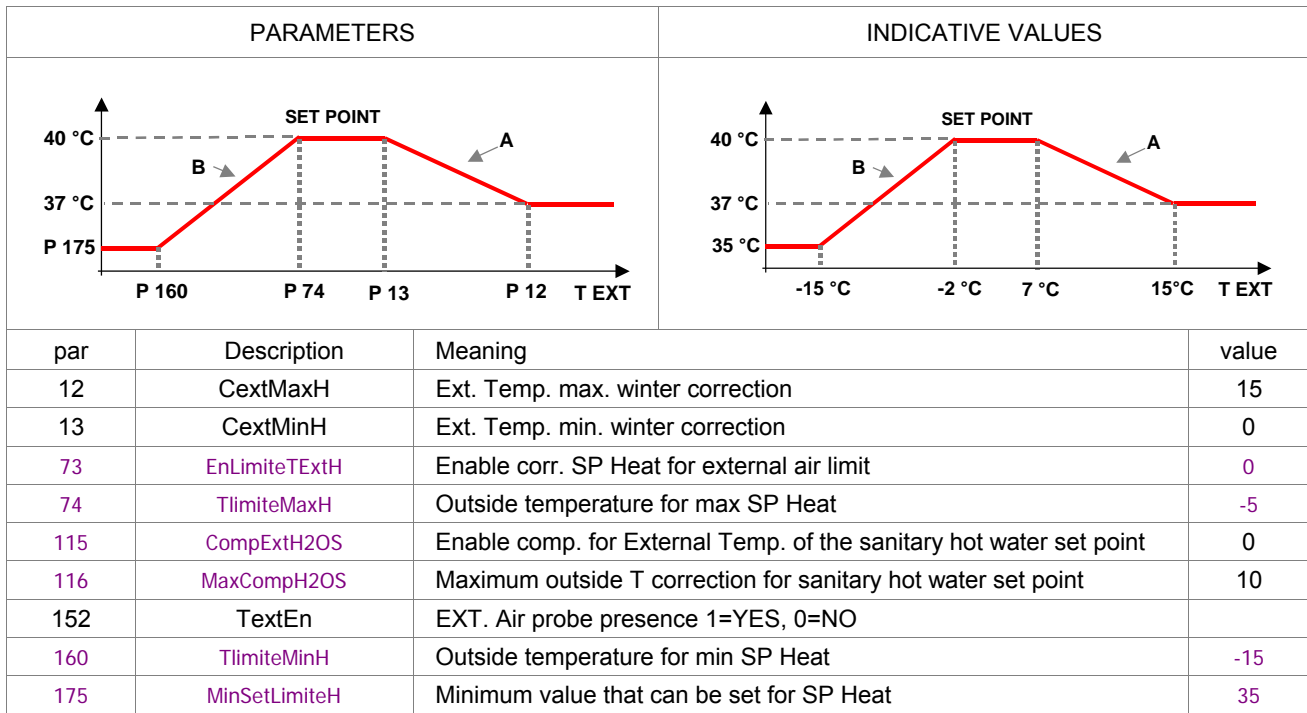

\* only WSHH



### 8. DUAL CONTROLS FOR TEMPERATURE – RADIANT PANELS

It is necessary the expansion **plug-in module** that must be fitted by the client (r refer to the kit instructions) and enabled by parameter 140 = 1.

With the optional kit, the mixed elements can be controlled: fan coils + radiant panels:

- Radiant panel circulator
- Mixing valve (0-10 volt or ON-OFF)
- Delivery probe (NTC type, 10 Kohm at 25°C)
- External control: COOLING/HEATING LIMIT (avoids dew / overheating).

ATTENTION: to prevent dew in summer or superheating in winter, it is very important to fit an external device and interface it with the unit that in case of signalling will force the recycling valve on the radiant panels

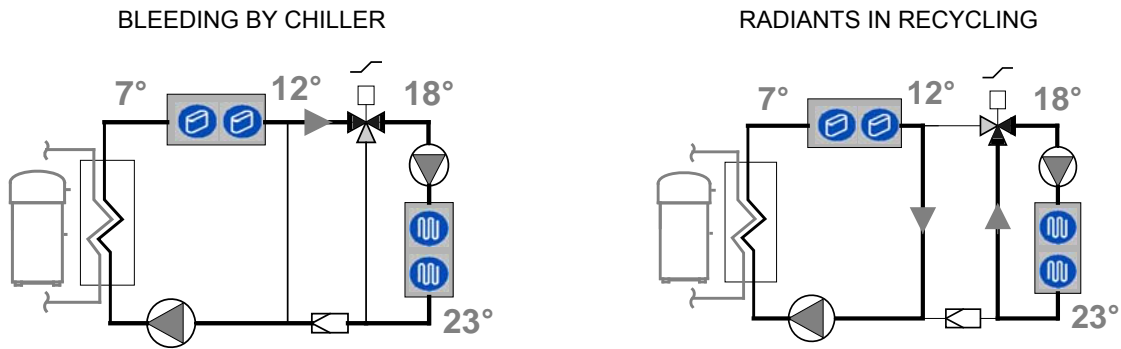

Output status on the optional plug-in module

valv 0-10	10 volt	valv 0-10	0 volt
3-point valve	out 22-23 = <b>ON</b>	3-point valve	out 22-23 = <b>OFF</b>
	out 22-25 = <b>OFF</b>		out 22-25 = <b>ON</b>

The water set point at the radiant panels can be managed in three ways:

1. the valve is managed to maintain the outlet temperature at par 192 value, independently of the unit operating mode (COOLING or HEATING).
2. calculated automatically in function of the external air temperature; two set are calculated (HEAT. / COOL.) that become actives on the basis of the unit operating mode. This configuration is obtained setting par 190=1

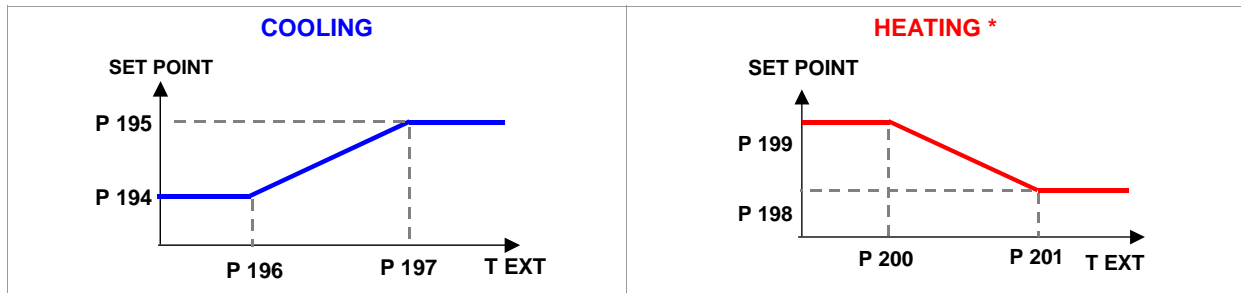

3. the installation maintains the summer set point at a value higher than the critical one, to avoid the dew formation on the floor. The unit can be connected via MODBUS to an external device (for example ELFOCONTROL) that transmits the temperature values and the ambient humidity. This configuration is obtained setting par 191 = 1.

If the unit is at service of an installation only for radiant panels (without mixing valve and fan coil) modify the following pump configuration parameters:

par	Description	Original value	Correct value
183	MaxTempC	12	8
184	MinTempH	12	8
185	IstTempC	4	2
186	IstTempH	4	2

only WSHH

**9. SET POINT COMPENSATION WITH 4-20 mA SIGNAL (WATER RESET)**

It optimizes the energetic efficiency of the unit by automatically changing the set-point according to an external signal of 4-20 ma type.

It requests the **expansion plug-in module** option that must be fitted by the client (refer to the kit instructions) and enabled by parameter 140 = 1.

This function must be enabled with parameter18 (=0 not enabled, =1 only summer, = 2 only winter, = 3 summer and winter)

par	Description	Meaning	value
18	WaterReset	Water Reset enabling 0=No 1=Cool 2=Heat 3=Always	0
19	MaxCWRH	Max. value of the Winter WR correction	10
20	SWRMAXH	Corresponding signal of the winter max. correction	4
21	SWRMinH	Corresponding signal of the winter min. correction	20
22	MaxCWRC	Summer correction max. value	8
23	SWRMaxC	Corresponding signal of the summer MAX. correction	20
24	SWRMinC	Corresponding signal of the summer MIN. correction	4
140	PlugInEn	Enables PLUG-IN presence . 1=YES / 0=NO	

**SET POINT CURVE IN COOLING**

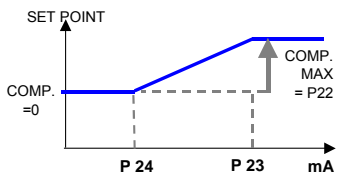

**SET POINT CURVE IN HEATING \***

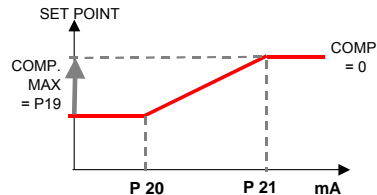

**10. SET POINT COMPENSATION ON THE TEMPERATURE OR EXTERNAL ENTHALPY**

Optimises unit energy efficiency by automatically adjusting the set-point according to enthalpy or the external temperature.

Requires the **external humidity probe** or the **external temperature probe**, which are optional for certain types of units and must be installed by the customer and enabled by parameters 152=1 and 156=1.

par	Description	Meaning	value
9	CompExt	External temp. comp. enabling 0=No 1=Cool 2=Heat 3=Always	0
10	CextMaxC	Ext. Temp. max. summer correction	15
11	CextMinC	Ext. Temp. min. summer correction	30
12	CextMaxH	Ext. Temp. max. winter correction	15
13	CextMinH	Ext. Temp. min. winter correction	0
14	MaxCExtC	Summer correction max. value	8
15	MaxCExtH	Winter correction max. value	10
16	HExtMinC	Ext. enthalpy min. correction	10,5
17	HExtMaxC	Ext. enthalpy max. correction	13,5
152	TextEn	EXT. Air probe presence 1=YES, 0=NO	
156	URProbeExt	Enables external UR% probe. 1=YES, 0=NO	

**SET POINT CURVE IN COOLING**

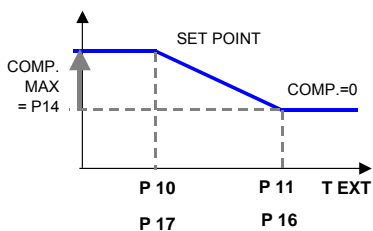

**SET POINT CURVE IN HEATING \***

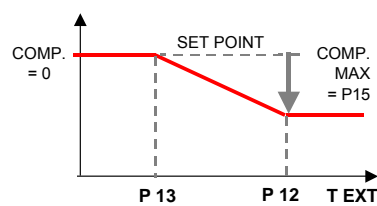

\* only WSHH

## 11. INTERFACCIAMENTO UNITA' VIA RS 485

Below the indications for the serial connection ; refer anyway to the CLIVET "RS 485 NETWORKS – GUIDELINES" document and ask for the COMMUNICATION PROTOCOL about the COMPACT electronics

- The total length of each single serial line, don't have to be over 1000 metres
- The potential difference between the "ground" of two RS485 switches must be less of 7 V
- Couple of conductors twisted and shielded
- Section of conductor  $0.22\text{mm}^2 \dots 0,35\text{mm}^2$
- Nominal capacity between conductors  $< 50 \text{ pF/m}$  nominal impedance  $120 \Omega$
- Recommended cable BELDEN 3105 A

### TYPE OF NETWORK

The serial lines must be connected in bus typology, i.e. nodes to more points are not admitted

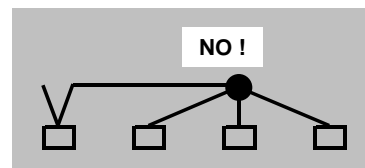
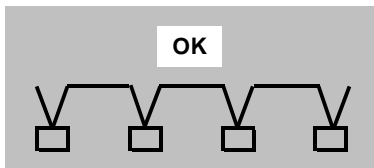

### SHIELD

- It must be connected to a ground without disturbances
- Connected to ground in only one point
- Provide to the shield continuity during all the serial cable extension.

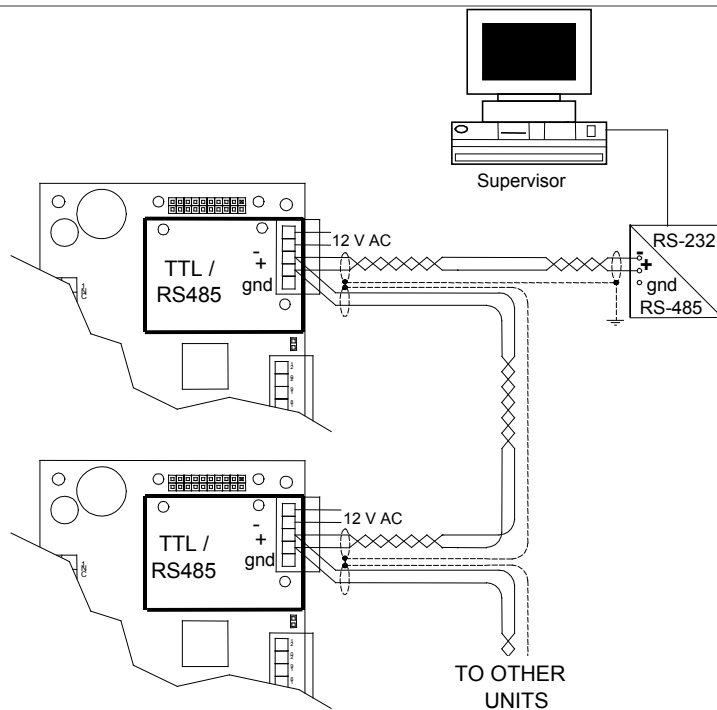
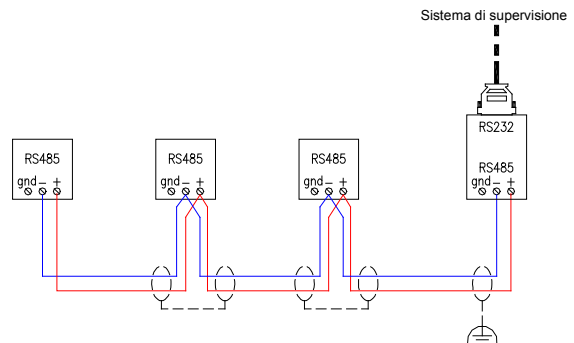

# START-UP

ALL THE EQUIPMENT MUST BE COMMISSIONED BY AUTHORISED SERVICE CENTRES.

THIS SERVICE IS LIMITED TO START-UP OF THE UNIT ONLY AND NOT THE CONNECTIONS OR INSTALLATION OF THE SYSTEM.

ONLY QUALIFIED TECHNICIANS MUST PERFORM THE FOLLOWING OPERATIONS.

## PRELIMINARY CHECKS

Before checking, please verify the following

1. the unit should be installed properly and in conformity with this manual.
2. the electrical power supply line should be sectioned at the beginning.
3. the sectioning device is locked and the proper warning "not to operate" sign is placed on the handle.
4. make sure no tension is present
5. the coils must be clean and free of obstacles
6. the ventilators must be free of leaves, cardboard, fixed obstacles (beams, barriers, etc.), snow, etc
7. the external ventilators must not be blocked

The external ventilators can be subject to a temporary block, especially if the inactivity period before the first start-up was quite long or if external temperature is very low. It is also possible to unblock them manually (ONLY WHEN THE UNIT IS UNPLUGGED – RISK OF INJURES) so that jams or electric overloads are avoided when the unit is restarted.

## REFRIGERANT SYSTEM

Carefully check the refrigerating circuit: the presence of oil stains can mean leakage caused by transportation, movements or other).

Open the cocks of the refrigerator circuit, if there are any.

Using the unit manometers, if present, or service manometers, verify that the refrigerating circuit is in pressure.

Make sure that all the service outlets are closed with proper caps; if caps are not present a leak of refrigerant can be possible.

## WATER SYSTEM

Ensure that the plumbing system has been washed. Drain the wash water before connecting the unit to the system.

Check that the water circuit has been filled and pressurised.

Accertarsi che non siano presenti perdite .

Check that the shut-off valves in the circuit are in the "OPEN" position.

Check that there is no air in the circuit. If required, bleed it using the vent valves in the system.

When using antifreeze solutions, make sure the glycol percentage is suitable for the type of use envisaged.

% weight of ethylene glycol	10 %	20 %	30 %	40 %
Freezing point	- 4 °C	- 9 °C	- 15 °C	- 23 °C
Safety temperature	- 2 °C	- 7 °C	- 13 °C	- 21 °C

Check that the circulator pumps are not blocked. In fact, their motor shaft may seize up, especially after long shutdowns. Unblocking can be accomplished with a screwdriver using the purge hole.

## ELECTRICAL SYSTEM

Check the proper tightening of the screws that fix the conductors to the electrical components in the board (during handling and transportation, the vibrations could have loosened them).

Verify that the unit is connected to the ground plant.

Control that all panels and protection devices of the unit are repositioned and blocked.

Charge the unit by closing the sectioning device, but leave it on OFF.

Make sure that the tension and net frequency values are within the limit of:

230 +/- 6% single phase unit; 400/3/50 +/- 6% three-phase unit

Control the unbalancing of the phases: it must be lower than 2% .

Example:

L1 - L2 = 388 V, L2 - L3 = 379 V, L3 - L1 = 377 V

average of the measured values =  $(388 + 379 + 377) / 3 = 381$

maximum deviation from the average =  $388-381= 7V$

Unbalancing =  $(7/381) \times 100 = 1.83\% = \text{ACCEPTABLE}$

Operating out of the indicated limits causes the loss of the guarantee as well as very serious damages.

### IF THE CRANKCASE HEATERS ARE FITTED

when the unit is started up for the first time and following all prolonged periods of inactivity is OBLIGATORY to connect the oil heaters on the compressor crankcase at least 8 hours before the compressor is to be started.

BEFORE POWERING THE HEATERS, OPEN THE COMPRESSORS COCKS, IF PRESENT.

To supply the heaters is necessary to switch off the isolator switch on the unit.

To make sure that the heaters are working, check the power input with amperometric pliers.

At start-up the compressor crankcase temperature on the lower side must be higher at least of 10°C than the external temperature.

DO NOT START THE COMPRESSOR WITH THE CRANKCASE OIL BELOW OPERATING TEMPERATURE.

## VERIFY TENSIONS – ABSORPTIONS

Check that the temperatures of the fluids are included in the WORKING LIMITS.

If the controls of the previous paragraphs are positive, it is possible to restart the unit.

For information on the control panel, refer to the paragraph CONTROL.

While the unit is working (ATTENTION ELECTRIC RISK: WORK SAFELY) check:

- Power supply tension
- Phase unbalance
- Total absorption of the unit
- Absorption of the single electric loads

## UNIT EQUIPPED WITH SCROLL COMPRESSORS

The GENERAL TECHNICAL DATA table shows the type of compressor on the unit.

The Scroll compressors have only one direction of rotation. In the event that the direction is reversed, the compressor will not be damaged, but its noisiness will increase and pumping will be negatively affected. After a few minutes, the compressor will stop because of the activation of the thermal protection. In this event, cut the power and reverse the 2 phases on the machine power.

Prevent the compressor from working with in reverse rotation: more than 2-3 anomalous starts up can damage it.

Make sure the direction of rotation is correct, measure the condensation and suction pressure. Pressure must clearly differ: at the start, the suction pressure decreases whilst the condensation pressure increases.

The phase optional monitor, which controls the phase sequence, can be installed later.

## REMOTE INPUT CONFIGURATIONS

Check used remote inputs are activated (ON-OFF etc.) as given in the instructions in the ELECTRIC WIRING chapter.

## SETTING THE SET-POINT

Check if it is necessary to modify the set-points shown in the CONTROL chapter

## EVAPORATOR WATER FLOW RATE

Check that the difference between the temperature of exchanger inlet and outlet water corresponds to power according to this formula:

unit cooling power (kW) x 860 = Dt (°C) x flow rate (L/h).

The cooling power is shown in the TABLE ON GENERAL TECHNICAL DATA included in this manual, referred to specific air/water conditions, or in the tables on cooling

PERFORMANCE IN THE TECHNICAL BULLETIN referred to various conditions of use.

Check for water side exchanger pressure drops:

- Determine the water flow rate.
- Measure the difference in pressure between exchanger input and output and compare it with the graph on WATER SIDE EXCHANGER PRESSURE DROPS.

The measurement of pressure will be easier if pressure gauges are installed as indicated in the DIAGRAM OF SUGGESTED WATER CONNECTIONS .

## CONDENSER WATER FLOW RATE

Check that the difference between the temperature of exchanger inlet and outlet water corresponds to power according to this formula:

unit cooling power + power absorbed by compressors (kW) x 860 = Dt (°C) x flow rate (L/h).

The data is shown in the table on GENERAL TECHNICAL DATA included in this manual, referred to specific air/water conditions, or in the tables on COOLING PERFORMANCE in the TECHNICAL BULLETIN referred to various conditions of use.

Check for water side exchanger pressure drops:

- Determine the water flow rate.
- Measure the difference in pressure between exchanger input and output and compare it with the graph on WATER SIDE EXCHANGER PRESSURE DROPS.

The measurement of pressure will be easier if pressure gauges are installed as indicated in the DIAGRAM OF SUGGESTED WATER CONNECTIONS.

## REFRIGERANT CIRCUIT PARAMETER CHECK

Detecting the operational conditions is useful to control the unit along time: the performed records must be kept and be available during maintenance interventions.

When the unit works in stable conditions and according to the operating limits, take note of the following data:

1. compressor discharge temperature (WARNING – BURN DANGERI)
2. condensing pressure
3. liquid temperature
4. dehydrator filter upstream and downstream temperature
5. inlet pressure
6. inlet temperature
7. exchanger input water temperature
8. exchanger output water temperature

# CONTROL

The HEATING mode functions are active only on WSHH unit version .

In WSH units, the relative parameters are VISIBLE but NOT ACTIVE , for example the winter setpoint.

## OPERING MODES

ON – OFF	Unit can be switched on and off by: <ul style="list-style-type: none"> <li>• User keypad</li> <li>• remote or service keypad</li> <li>• remote switch (see ELECTRICAL CONNECTIONS paragraph)</li> <li>• Supervisor</li> </ul>
COOLING	The compressor is activated with outlet temperature higher than set point
	To switch from <b>cooling</b> to <b>heating</b> and vice versa, proceed as follows: <ul style="list-style-type: none"> <li>• Turn the unit OFF</li> <li>• Wait until the plant water temperature (and external air) fall within the operating limits.</li> </ul> They can be switched over from the remote controls (refer to the ELECTRIC WIRING paragraph).
HEATING *	The compressor is activated with outlet temperature lower than set point
ECO	A secondary set-point can be used, with respect to the comfort setting
MAINTENANCE	the plant can be kept within the operating limits even when the unit is OFF or on STANDBY
SANITARY H2O PRODUCTION *	A specific set point is used, higher than the HEATING set ( see ELECTRICAL CONNECTIONS paragraph ).

## CHARACTERISTICS

### THERMOREGULATION

The thermoregulation is based on the OUTLET temperature.

The unit is dimensioned for a determined TOTAL HEAD between input and output water temperature.

Usually the project step is 5°C; if the value is different, it is necessary reset parameters 37 and 38 (accessible to the service centre).

In function of the total head, the installation determines the head quote that every resource (compressor, heating elements) is able to provide: the STEP HEAD.

The control logic insert gradually the resources when the outlet temperature is higher than the set point + the head step.

The resources are activated one at a time and only at the SCAN TIME expiring.

The scan time is not fixed but it changes in function of the margin between the water outlet temperature and the Set point value. Higher is the margin value (both in positive and in negative) shorter will be the space among the scan points.

The scan time value is visualized at status 4; when the status 3 has reached the status 4 value, the compressor operating request is activated.

What above described, refer to the COOLING operating; in HEATING the logic is the same but “overturned” (compressor insertion for outlet temp. < set-point –step head).

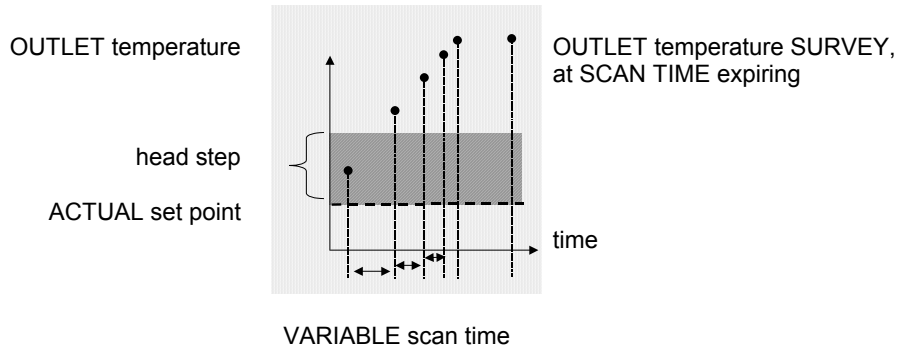

\* only WSHH

## SET-POINT COMPENSATIONS

The compensations are evolved functions to protect the compressors and to adapt, as far as possible, the unit operating to the installation and use characteristics.

The compensations prolong the compressor operating time and limit the start number; to do this they delay the compressor insertion point adding an offset.

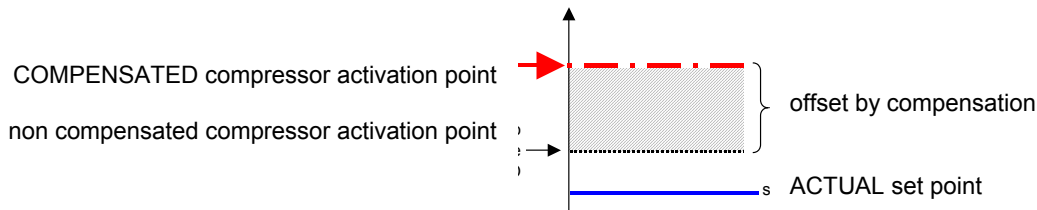

- The compensation on the DURATION is useful when the installation water content is limited.
  - The compensation on the CHARGE is useful if the variable charge is present.
- For the enabling and the configuration is necessary the parameter modification with reserved access to the service centres. In industrial applications where is requested a temperature check is possible to disable the COMPENSATIONS.

## SET-POINT CORRECTIONS

The correction aim is to optimize the unit energetic efficiency.

To do this the corrections modify the set point in a dynamic way in function of determined variables: for example in summer operating with low external temperatures, so with a reduced charge, is possible to obtain the internal comfort also with set point higher than standard, obtaining an higher energetic efficiency.

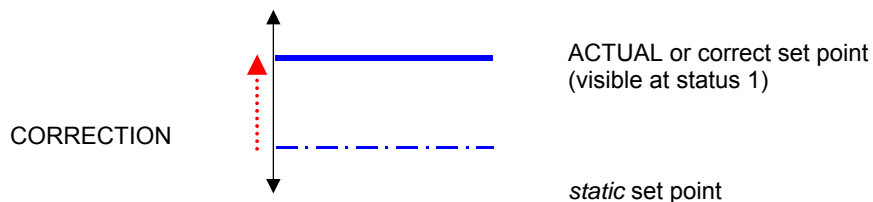

The static set point can so be modified in a dynamic way by two CORRECTIONS based on as many unit external factors:

- correction based on the ext. temp. / enthalpy
- correction based on the Water reset (4-20 mA signal provided by the Client)

The correct set point, to whom have been summed or removed the corrections, is named ACTUAL set-point and it is visible at status n°1.

The STATA menu visualizes the compensation value on the ext. temperature (status 5) and WR (status 6)

For further details see the ELECTRICAL CONNECTIONS section.

## CIRCULATION PUMP

The pump is always activated with the units ON.

The delivery capacity is variable to soften the thermal shock to the compressors when the plant temperature is close to the threshold limits.

Delivery capacity depends on the intake temperature:

- SUMMER: high water temperature reduces delivery
- WINTER: low water temperature reduces delivery

## CIRCULATION PUMP – CONDENSER (RUNNING WATER)

The pump is started BEFORE the compressor start and stopped AFTER the condenser stop.

## SET POINT

### SET POINT

#### SUMMER - WINTER

The thermoregulator manages two set points:

- SUMMER set-point for cooling (parameter 32)
- WINTER set-point for heating (parameter 33)

The control is performed on the OUTLET TEMPERATURE, comparing it with the actual set-point value (visible at status 1).

#### SET-POINT CALCULATION:

- desired medium outlet water temperature = 7°C
- Project temperature differential = 5°C (that is inlet water = 12°C)
- ¼ of the project temperature differential =  $5 / 4 = 1.25$ °C
- set-point to be set =  $7 - 1.25 = 5.7$ °C

## SECONDARY SET POINT – ECO

A secondary set point can be used with different levels to the “normal” set point.

It is normally set to give lower energy consumption with respect to the comfort setting:

- The SECONDARY SUMMER set point is higher than the SUMMER setting.
- The SECONDARY WINTER set point is lower than the WINTER setting.

It can be set according to individual requirements.

- Secondary summer set-point parameter 29
- Secondary winter set-point parameter 30

It can be activated from the keyboard, supervisor unit or the remote control. To change it using the remote control refer to the ELECTRIC WIRING paragraph.

If the 3-way valve option for sanitary water is present, the 2° set point in heating can be activated by service/remote keypad with par 49 =1

par	Description	Meaning	value
49	Comando2°Set	2° set point mode control by parameter	0

## MAINTENANCE

This way, the plant can be kept within the operating limits even when the unit is OFF or on STANDBY, for example during the weekend or the night-time.

Periodically the system activates the circulation pump, measures the water temperature and activates the compressor, if required, to take the water temperature to the set-point level.

- Summer maintenance set-point par 42
- Winter maintenance set-point par 43

This function is activated by parameters 44 (activate summer maintenance level) and 45 = 1 (activate winter maintenance level).

## DUAL CONTROLS FOR TEMPERATURE – RADIANT PANELS

With the optional kit, a mixed plant can be controlled:

- Fan coil (with the set-points seen above)
- Radiant panels (with specific radiant set-points)

The radiant set point can be determined in different ways, for further details see the ELECTRICAL CONNECTIONS section.

## FUNCTIONING WITH ETHYLENE GLYCOL

The units foreseen to function with glycoled water come out from the premise with standard parameters.

After having added glycol ethylene to water, the technician will properly set the plant.

Parameter to modify	% Ethylene glycol			
	10 %	20 %	30 %	40 %
32 Summer set point	1	- 4	- 10	- 18
77 Antifreeze heater set	- 2	- 7	- 13	- 21
80 Antifreeze alarm	- 2	- 7	- 13	- 21
84 Antifreeze pre-alarm threshold	- 1.5	- 6.5	- 12.5	- 20.5



## USER KEYPAD

The keyboard allows visualizing and changing the functioning conditions of the unit.  
The service keyboard is needed to visualize or modify the functioning parameters.

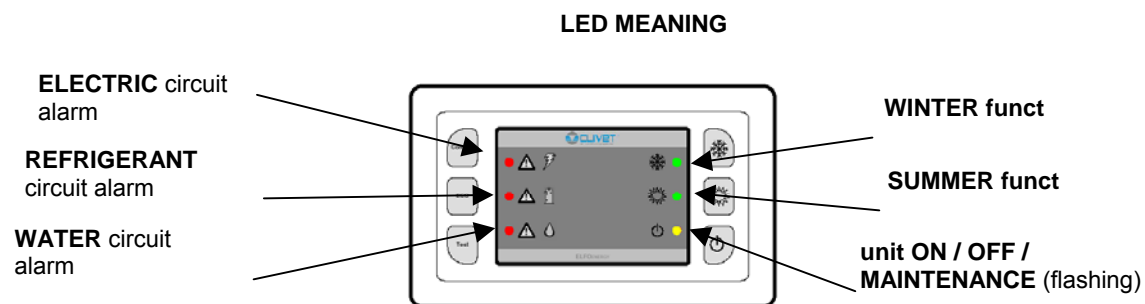
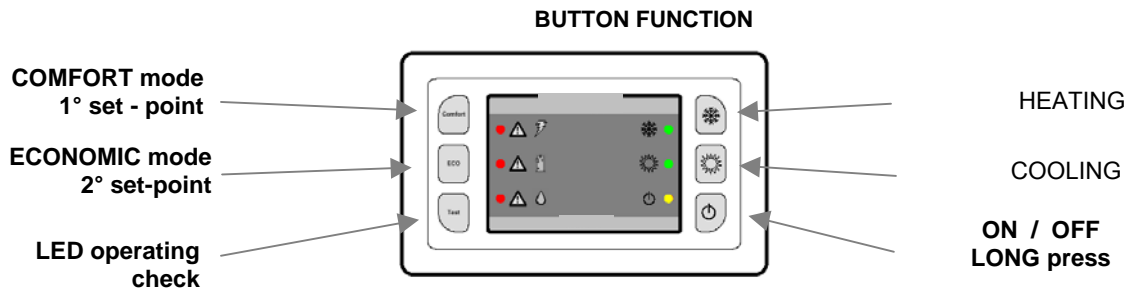

## SANITARY HOT WATER PRODUCTION SIGNAL

For the machine types that manage sanitary hot water production, the status is displayed with the WINTER and SUMMER operation LEDs:

❄ WINTER	☀ SUMMER
ON	FLASHING

## ON - OFF

The ON-OFF control from the keyboard allows activating or deactivating the normal functioning of the unit.

## SETTING THE OPERATING MODE

**COOLING:** to set the SUMMER operating mode, press the ☀ key for a few moments.  
When the mode has been activated, the corresponding green led lights up.

**HEATING:** to activate the WINTER operating mode, press the ❄ key for a few moments.

When the mode has been activated, the corresponding green led lights up.

**MAINTENANCE:** The operating mode leds remain alight even when the machine is in the maintenance status. The maintenance set-points (if activated) control the water temperature when the unit is OFF or on STANDBY. To do this, the circulation pump is periodically activated, which tests the water temperature and activates the compressor if required.

## SELECTING OPERATING TEMPERATURE

**COMFORT:** to select the COMFORT temperature for the current operating mode, press the COMFORT key. The set point is only displayed on the machine.  
When this mode is activated, the led to the left of the key lights up and remains alight.

**ECO:** to select the ECONOMIC temperature for the current operating mode, press the ECO key.  
In the winter this reduces the set point and increases it in the summer.  
When this mode is activated, the green led to the left of the key flashes slowly.

## ALARMS

**FLASHING LED:** there is an anomaly at the AUTOMATIC reset

**FIXED LIGHT LED:** there is an anomaly at the MANUAL reset

**ALARM RESET:** TEST + ON/OFF keys pressed simultaneously for more than 2 seconds.

Alarm type:



### ELECTRICAL CIRCUIT ALARM

Inlet probe  
Outlet probe  
Radiant panel water probe  
Coil/flow probe  
External probe  
Pressure 1 probe  
Water reset inlet  
External relative humidity probe  
Phase monitor  
Electric heater output probe

Allarme serial faulty



### REFRIGERANT CIRCUIT ALARM

HP  
LP  
CCMP/VENT  
HP1 Pre-Alarm  
BP1 Pre-Alarm

Allarme serial faulty



### WATER CIRCUIT ALARM

Flow pump  
System charged with water  
Antifreeze alarm  
Antifreeze PREAlarm  
Pump alarm  
C1 PREAlarm  
PRad. Cooling limit alarm  
PRad. Water frost alarm  
Coil frost alarm  
Alarm ?T° incongruous  
Electric heater antifreeze alarm  
Allarme serial faulty

## FUNCTIONING TEST

The "Test" key allows the verification of the proper functioning of the all six signalisation LEDs. When it is pressed, all leds are ON until the key is released.

## REMOTE OR SERVICE KEYPAD (OPTIONALS)

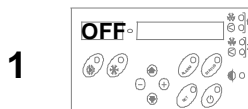
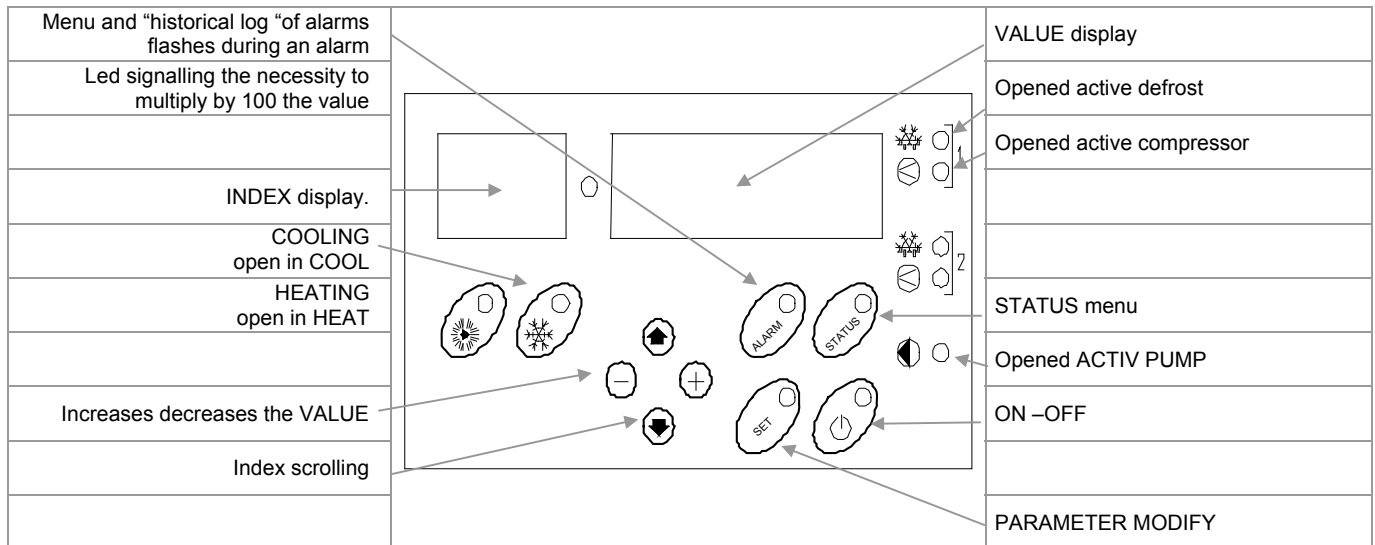

unit in OFF.  
by keypad  
by supervisor

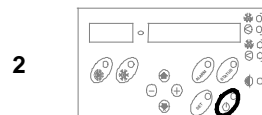

switching: long ON -  
OFF  
pressure



OUTLET temperature  
visualization



Unità in :

- MANTEINTENANCE or
- In TRANSITION mode ( for ex. from heating to cooling or to sanitary H2O)

## ACCESSIBLE PARAMETERS FROM REMOTE OR SERVICE KEYBOARD

num. Par.	Description	Value	UM
29	Summer secondary Set Point	10	°C
30	Winter secondary Set Point	35	°C
32	Summer Set Point	5.7	°C
33	Winter Set Point	41.2	°C
42	Summer Set Point Maintenance	20	°C
43	Winter Set Point Maintenance	30	°C
44	Enables Summer Maintenance	0	num
45	Enables Winter Maintenance	0	num
77	Antifreeze heater set point	4	°C
80	Antifreeze alarm	4	°C
84	Limit of deactivation before reaching the antifreeze steps	4.5	°C
117	Sanitary water set point	35	°C
163	Configures remote inputs: 1 = H/C by keypad or supervisor		
216	Keypad address on Clivet Bus net: 7 =local; 1=remote	0	num

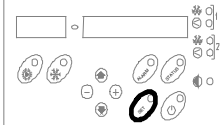
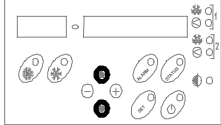
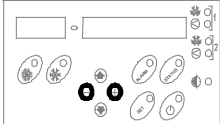
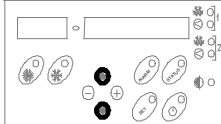
### PARAMETER MODIFICATION



1		Push SET button	2		Select the parameter
3		Modify the value	4		Select another parameter
5		SET to esc			

### VISIBLE STATUS FROM REMOTE KEYBOARD OR SERVICE KEYBOARD

UNIT STATA MENU		
INDICE	DESCRIPTION	VALUE
1	<b>Current Set Point</b>	°C
2	Temperature drop in degrees centigrade given by the compressor including compensations, if any	°C
3	Resource activation timer When this value reaches the value fixed at the next status (TimeScan), the thermal regulator will compare the input temperature with the set point and will activate the resources (compressor and/or heaters)	Seconds
4	Dynamic TimeScan relating to source activation	Seconds
5	Value in degrees of the external air compensation	°C
6	Value in degrees of the water reset signal compensation	°C
7	summation CompCar + CompOn + CompDuty	°C
8	Value in degrees of the duty-cycle compensation	°C
9	Inlet temperature	°C
10	Outlet temperature	°C
11	Water temperature of refreshing panel	°C
12	Coil temperature (if condensing in water becomes condenser antifreeze probe)	°C
13	Condensing pressure	Bar
14	Fan/Coil percentage 1	0-100%
15	Heater output temperature	°C
16	WBAN condensing pressure	Bar
18	Water Reset signal value	4-20 mA

UNIT STATA MENU		
INDICE	DESCRIPTION	VALUE
19	Outdoor temperature	°C
20	Outdoor Humidity	0-100%
21	Machine Clock – (only fed unit hours)	Num
22	Working hours C1	Num
23	Pickups C1	Num
24	Radiant panel valve status	ON-OFF
25	Radiant panel valve status	%
26	Pump percentage	%
27	Integration heater status	ON-OFF
28	Refreshing panel valve (Out-1)	ON-OFF
29	Radiant set Point	°C
30	Keypad software	EJ – t ( ELFO Junior – keypad)
31	Year of certification of the keyboard SW	2007
32	Month of certification of the keyboard SW	04
33	Day of certification of the keyboard SW	03
34	Base Software	EJ – b (ELFO Junior – base)
35	Year of certification of the keyboard SW	2007
36	Month of certification of the keyboard SW	03
37	Day of certification of the keyboard SW	14

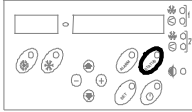
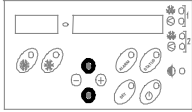
### STATUS DISPLAY

- 1  Press STATUS button
- 2  Select the status
- 3  STATUS to esc

### ALARMS

#### BEFORE RESETTING THE ALARM, IDENTIFY AND ELIMINATE THE CAUSE OF ITS ACTIVATION.

REPEATED RESETS CAN CAUSE IRREVERSIBLE DAMAGES.

The **ALARMS** show a potentially dangerous situation for machine safety.

Before resetting the alarm, discover and remove the cause: repeated resetting could cause irreversible damage. To avoid this, the unit can only be reset **MANUALLY** from the keyboard (only when the cause for the alarm has been removed).

**PRE-ALARMS** and **SIGNALS** warn of a risky situation. These could be acceptable only if they happen occasionally or in transitory situations (for example when the plant is being started up).

They are reset **AUTOMATICALLY**, as soon as the cause has been removed, without any input from the keyboard.

The pre-alarms are signalled by the fixed C code (not flashing) and on the right the control temperature.

The **FAULTS** warn of problems with the probes and transducers, and are reset **AUTOMATICALLY** to allow the unit to continue running, perhaps with fewer functions.

In case of doubt, always contact an authorised service centre.

The presence of an alarm is signalled by the **ALARM CODE** flashing and the time at which the alarm/alarms occurred.

The cumulative block relay activates simultaneously to the alarm code visualization.

Certain alarms, in particular **PRE-ALARMS**, do not activate the relays.

The complete list of alarms is provided below; depending on the machine type and its configuration, some of the codes shown may not be used.

E	00	Serial faulty - comunicazione tastiera / scheda base	Auto.
E	1	Faulty or disconnected water inlet probe	Auto
E	2	Faulty or disconnected water outlet probe	Auto.
E	3	Faulty or disconnected radiating panel water probe (radiating panel option)	Auto.
E	4	Faulty or disconnected coil probe	Auto.
E	5	Electric heater output probe	Auto.
E	6	Faulty or disconnected external probe	Auto.
E	7	Faulty or disconnected pressure transducer	Auto.
E	8	Plug-in pressure probe	
C	9	Water Reset inlet in short circuit or out of range	Auto.
E	10	Faulty or disconnected external RH% probe	Auto.
E	11	High pressure	MANUAL
E	12	Low pressure	Auto.
E	13	Condensing fan and/or compressor thermal switch	MANUAL
E	14	Electric heater antifreeze alarm	MANUAL
E	17	Pump flow	Auto.
E	18	System charged with water	MANUAL
E	19	Phase monitor	Auto.
E	20	Antifreeze alarm	MANUAL
C	21	Antifreeze PREAlarm	Auto.
C	22	High pressure PreAlarm	Auto.
C	24	Pump change	Auto.
E	25	flow alarm C1	Auto.
E	30	Coil frost alarm	MANUAL
E	31	Cooling limit alarm (radiating panel option)	Auto.
E	32	Water frost alarm (radiating panel option)	Auto.
E	33	Incongruent DeltaT alarm	MANUAL
C	34	Low pressure pre-alarm	Auto.
C / E	35	Inlet water temperature over threshold after cooling / sanitary hot water switching and vice versa	Auto
C	36	Incongruent sanitary H2O thermostat	Auto



**1** flashing  
Alarm code  
Alarm unit hours



**2** opened alarm log  
short pressure  
ALARM

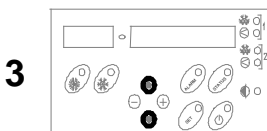

**3** The most recent alarm is  
visualized  
Use the arrow keys to  
visualize other alarms

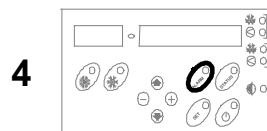

**4** To esc  
Short pressure  
ALARM



**5** To RESET  
LONG pressure  
ALARM

## ROUTINE MAINTENANCE

**BEFORE UNDERTAKING ANY SORT OF MAINTENANCE OR CLEANING, DISCONNECT THE ELECTRICAL POWER SUPPLY TO THE UNIT, AND ENSURE THAT OTHER PEOPLE CANNOT RE-CONNECT IT .**

All equipment is subjected to wear out.

The maintenance makes :

1. keeps the unit efficiency
2. the components last longer
3. keeps their efficiency and limits breakdowns

Therefore, it is fundamental to perform periodical checks: a few controls can be performed by the user (AUTONOMOUS MAINTENANCE) and they are mainly

cleaning activities; otherwise, controls have to be performed by specialized technicians (INSPECTIONS).

The machine should have a log book used to keep track of the performed controls. This will make fixing up breakdowns easier.

Take note of the date, type of control (autonomous maintenance, inspection or fixing up), description of the control, actions taken and so on.

### SERVICES

Parts subject to intervention:

- **WATER CONDENSER**
- **STRUCTURE**

### WATER EXCHANGER

It is very important for the exchanger to be able to provide the maximum thermal exchange. Therefore, it is essential for the inner surfaces to be clean of dirt and incrustations.

Periodically check the difference between the temperature of the outlet water and the condensation temperature. If the difference is greater than 8°C–10°C it is advisable to clean the exchanger.

### STRUCTURE

Check the condition of the parts making up the structure. Paint so as to eliminate or reduce oxidation at the points in the unit where this problem may occur. Check that the

panelling is fastened correctly. Poor fastening may give rise to malfunctions and abnormal noise and vibration.

## MAINTENANCE INSPECTIONS

Foresee inspection assistance carried out by authorized centers or by qualified personnel.

The inspections should be carried out at least:

- - Every year for only the cooling units
- - Every six months for the cooling and warming units

The frequency, however, depends on the use: in the event of frequent use (continuous or very intermittent use, near the operating limits, etc) or critical use (service necessary) it is recommended to plan inspections at close intervals.

The inspections to be performed are as follows:

- verify the power supply tension (when emptied or filled)
- inspect the electrical board (status of solenoid starter contacts, terminal closings, the status of wiring and relevant insulations)
- inspect the absorption of the single electrical loads
- verify the cleaning and the efficiency of the exchangers
- inspect the cleaning of the filters (air/water)

- verify the leakage from the refrigerating circuit
- Verify the protection devices (safety valves, pressure switches, thermostats, etc.), the adjustment systems, the control devices (alarm signalizations, probes, manometers, etc)
- check the operating parameters of the refrigerating circuit (see the following REFRIGERANT TABLES and the START-UP section)

For units equipped with safety valves, follow the Manufacturer's instructions.

Verify periodically the cleaning of the safety valves and that oxidative / corrosive phenomena are not present, in particular for installations near the sea, in industrial areas or in rooms with a corrosive atmosphere.

## 97/23 CE PED DIRECTIVE

97/23 CE PED DIRECTIVE gives instructions for installers, users and maintenance technicians as well. Refer to local actuation norms.

In Italy, refer to the Ministerial Decree of 1<sup>st</sup> December 2004 no. 329 (and following modifications) which defines the performances to be executed; the units of 1<sup>st</sup> category and those defined by the art. 3.3 97/23/EC are not included in this regulation (see the serial number plate on the unit).

Briefly and as an example, see the following :

1. COMPULSORY VERIFICATION OF THE FIRST INSTALLATION only for units assembled on the installer's building site (for ex. Condensing circuit + direct expansion unit)
2. CERTIFICATION OF SETTING IN SERVICE for all the units
3. PERIODICAL VERIFICATIONS to be executed with the frequency indicated by the Manufacturer (see the MAINTENANCE INSPECTIONS paragraph)

## PUT AT REST

If a long period of inactivity is foreseen, for example the winter for the cooling unit, the following is recommended:

- to turn the power off in order to avoid electrical risks or damages by lightning strike
- to avoid the risk of frosts as shown in the HYDRAULIC CONNECTIONS section, and, in particular
  - to empty or add glycole in the plant sections subjected to temperatures below zero
  - to empty or add glycole in the water heating coils, also in summer
  - to power antifreeze heaters if present

If the period of inactivity is particularly long or in the event of extremely low temperatures, the external fans can be blocked temporarily; therefore, it is recommended to switch them on every month in order to avoid seizures or electrical overloads when the unit will be switched on.

The restarting of the unit has to be carried out by qualified personnel, in particular, after the winter break for cooling units or when seasonal switching should be performed.

When restarting, refer to the SWITCHING ON section. Schedule technical assistance in advance to avoid hitches and be able to use the installation when necessary.

## REFRIGERANT TABLES

THIS SECTION IS DEVOTED ONLY TO QUALIFIED TECHNICIANS THAT KNOW THE FOLLOWING:

- THE OPERATIONAL PRINCIPLES OF THE REFRIGERATING CIRCUIT OPERATION
- THE MODES OF DETECTING TEMPERATURE AND PRESSURE
- THE RISKS RELEVANT TO THESE OPERATIONS

The data of the tables allow the testing of the refrigerating circuit operation by the detection of a few objective parameters.

The data are significant if they are detected simultaneously and while the refrigerating circuit is running.

- Liquid temperature
- Inlet pressure
- Inlet temperature
- Condensing pressure

<b>OVERHEATING</b> = inlet temperature – Saturation temperature			
	<b>R22</b>	<b>R407C</b>	<b>R410A</b>
Inlet pressure	3.8 bar	3.8 bar	7.2 bar
Inlet temperature	7.3 °C	7.3 °C	7.3 °C
overheating	$7.3 - (-1.13) = 8.43$ °C	$1.3 - 1.18 = 6.12$ °C for calculation consider the Td (dew point)	$7.3 - 0.8 = 6.5$ °C
<b>SUBCOOLING</b> = condensing temperature (pressure *) – liquid temperature			
	<b>R22</b>	<b>R407C</b>	<b>R410A</b>
Condensing pressure	18.6 bar	18.6 bar	29.6 bar
Liquid temp.	42.9 °C	42.9 °C	45 °C
subcooling	$50.39 - 42.9 = 7.49$ °C	$44.74 - 42.9 = 1.84$ °C for calculation consider the Tb (bubble point)	$49.91 - 45 = 4.91$ °C

\* It is important that the condensation pressure is detected as close as possible to the point where the liquid temperature is detected, in the event that the calculation will be effected by the losses of charge (and, therefore, of temperature) caused by the refrigerating circuit components placed between the two measurement points.

For R410A the glide was not considered, since it is close to 0.

The values in the tables refer to a specific refrigerant supplier; slight differences are possible with other suppliers.

Pg = P gauge = relevant pressure (read on the pressure gauge)  
Ts = saturation pressure

Td = dew point temperature  
Tb = bubble point temperature

Pg	R22	R134a	R407C		R410A
	Ts [°C]	Ts [°C]	Td [°C]	Tb [°C]	Ts [°C]
0.0	-41.09	-26.36	-36.90	-43.90	-51.66
0.2	-37.14	-22.31	-33.11	-40.05	-48.02
0.4	-33.67	-18.76	-29.80	-36.67	-44.83
0.6	-30.57	-15.59	-26.83	-33.65	-41.98
0.8	-27.76	-12.71	-24.15	-30.92	-39.40
1.0	-25.18	-10.08	-21.69	-28.41	-37.03
1.2	-22.79	-7.64	-19.41	-26.09	-34.84
1.4	-20.57	-5.37	-17.29	-23.93	-32.81
1.6	-18.48	-3.24	-15.31	-21.90	-30.90
1.8	-16.52	-1.23	-13.44	-19.99	-29.10
2.0	-14.65	0.67	-11.66	-18.19	-27.39
2.2	-12.89	2.48	-9.98	-16.47	-25.78
2.4	-11.20	4.20	-8.38	-14.83	-24.24
2.6	-9.59	5.84	-6.85	-13.27	-22.76
2.8	-8.04	7.42	-5.38	-11.77	-21.35
3.0	-6.56	8.93	-3.97	-10.33	-20.00
3.2	-5.13	10.39	-2.61	-8.94	-18.69
3.4	-3.75	11.79	-1.31	-7.61	-17.44
3.6	-2.41	13.15	-0.04	-6.31	-16.22
<b>3.8</b>	<b>-1.13</b>	14.46	<b>1.18</b>	-5.06	-15.05
4.0	0.12	15.74	2.36	-3.85	-13.91
4.2	1.34	16.97	3.51	-2.68	-12.81
4.4	2.51	18.17	4.62	-1.54	-11.74
4.6	3.66	19.33	5.71	-0.43	-10.69
4.8	4.77	20.47	6.76	0.65	-9.68
5.0	5.86	21.57	7.79	1.70	-8.69
5.2	6.92	22.65	8.79	2.73	-7.73
5.4	7.96	23.70	9.77	3.73	-6.79
5.6	8.97	24.73	10.72	4.71	-5.87
5.8	9.95	25.73	11.65	5.67	-4.97
6.0	10.92	26.71	12.56	6.60	-4.10
6.2	11.87	27.67	13.46	7.52	-3.24
6.4	12.79	28.62	14.33	8.41	-2.40
6.6	13.70	29.54	15.18	9.29	-1.57
6.8	14.59	30.44	16.02	10.15	-0.77
7.0	15.47	31.33	16.85	11.00	0.02
<b>7.2</b>	<b>16.32</b>	<b>32.20</b>	<b>17.65</b>	<b>11.83</b>	<b>0.80</b>
7.4	17.16	33.05	18.45	12.64	1.56
7.6	17.99	33.89	19.22	13.44	2.31
7.8	18.81	34.72	19.99	14.23	3.05
8.0	19.60	35.53	20.74	15.00	3.77
8.2	20.39	36.32	21.48	15.76	4.48
8.4	21.17	37.11	22.20	16.51	5.18
8.6	21.93	37.88	22.92	17.25	5.87
8.8	22.68	38.64	23.62	17.97	6.55
9.0	23.42	39.39	24.32	18.69	7.22
9.2	24.14	40.13	25.00	19.39	7.88
9.4	24.86	40.85	25.67	20.08	8.53
9.6	25.57	41.57	26.34	20.77	9.16
9.8	26.27	42.27	26.99	21.44	9.79
10.0	26.95	42.97	27.63	22.11	10.42
10.2	27.63	43.66	28.27	22.76	11.03
10.4	28.30	44.33	28.90	23.41	11.63
10.6	28.96	45.00	29.51	24.05	12.23
10.8	29.62	45.66	30.13	24.68	12.82

Pg	R22	R134a	R407C		R410A
	Ts [°C]	Ts [°C]	Td [°C]	Tb [°C]	Ts [°C]
11.0	30.26	46.32	30.73	25.30	13.40
11.2	30.90	46.96	31.32	25.92	13.97
11.4	31.53	47.59	31.91	26.52	14.54
11.6	32.15	48.22	32.49	27.12	15.10
11.8	32.76	48.84	33.07	27.72	15.66
12.0	33.37	49.46	33.63	28.30	16.20
12.2	33.97	50.06	34.19	28.88	16.74
12.4	34.57	50.66	34.75	29.46	17.28
12.6	35.15	51.26	35.30	30.03	17.81
12.8	35.73	51.84	35.84	30.59	18.33
13.0	36.31	52.42	36.37	31.14	18.85
13.2	36.88	53.00	36.90	31.69	19.36
13.4	37.44	53.56	37.43	32.23	19.87
13.6	38.00	54.13	37.95	32.77	20.37
13.8	38.55	54.68	38.46	33.31	20.86
14.0	39.10	55.23	38.97	33.83	21.36
14.2	39.64	55.78	39.47	34.35	21.84
14.4	40.17	56.32	39.97	34.87	22.32
14.6	40.70	56.85	40.46	35.38	22.80
14.8	41.23	57.38	40.95	35.89	23.27
15.0	41.75	57.91	41.43	36.39	23.74
15.2	42.26	58.43	41.91	36.89	24.20
15.4	42.78	58.94	42.39	37.39	24.66
15.6	43.28	59.45	42.86	37.87	25.12
15.8	43.78	59.96	43.32	38.36	25.57
16.0	44.28	60.46	43.78	38.84	26.01
16.2	44.77	60.95	44.24	39.32	26.46
16.4	45.26	61.44	44.69	39.79	26.90
16.6	45.75	61.93	45.14	40.26	27.33
16.8	46.23	62.42	45.59	40.72	27.76
17.0	46.71	62.90	46.03	41.18	28.19
17.2	47.18	63.37	46.47	41.64	28.62
17.4	47.65	63.84	46.90	42.09	29.04
17.6	48.11	64.31	47.33	42.54	29.45
17.8	48.58	64.77	47.76	42.99	29.87
18.0	49.03	65.23	48.18	43.43	30.28
18.2	49.49	65.69	48.60	43.87	30.69
18.4	49.94	66.14	49.02	44.30	31.09
<b>18.6</b>	<b>50.39</b>	66.59	49.43	<b>44.74</b>	31.49
18.8	50.83	67.04	49.84	45.16	31.89
19.0	51.27	67.48	50.25	45.59	32.28
19.2	51.71	67.92	50.65	46.01	32.68
19.4	52.15	68.36	51.05	46.43	33.07
19.6	52.58	68.79	51.45	46.85	33.45
19.8	53.01	69.22	51.85	47.26	33.84
20.0	53.43	69.64	52.24	47.67	34.22
20.2	53.85	70.07	52.63	48.08	34.59
20.4	54.27	70.49	53.01	48.49	34.97
20.6	54.69	70.90	53.39	48.89	35.34
20.8	55.10	71.32	53.77	49.29	35.71
21.0	55.51	71.73	54.15	49.69	36.08
21.2	55.92	72.14	54.53	50.08	36.44
21.4	56.33	72.54	54.90	50.47	36.81
21.6	56.73	72.95	55.27	50.86	37.17
21.8	57.13	73.35	55.64	51.25	37.52



Pg	R22	R134a	R407C		R410A
	Ts [°C]	Ts [°C]	Td [°C]	Tb [°C]	Ts [°C]
22.0	57.53	73.74	56.00	51.63	37.88
22.2	57.92	74.14	56.36	52.01	38.23
22.4	58.31	74.53	56.72	52.39	38.58
22.6	58.70	74.92	57.08	52.77	38.93
22.8	59.09	75.31	57.43	53.14	39.28
23.0	59.48	75.69	57.79	53.51	39.62
23.2	59.86	76.07	58.14	53.88	39.96
23.4	60.24	76.45	58.48	54.25	40.30
23.6	60.62	76.83	58.83	54.62	40.64
23.8	60.99	77.21	59.17	54.98	40.98
24.0	61.36	77.58	59.51	55.34	41.31
24.2	61.74	77.95	59.85	55.70	41.64
24.4	62.10	78.32	60.19	56.05	41.97
24.6	62.47	78.68	60.53	56.41	42.30
24.8	62.84	79.04	60.86	56.76	42.62
25.0	63.20	79.41	61.19	57.11	42.95
25.2	63.56	79.76	61.52	57.46	43.27
25.4	63.92	80.12	61.84	57.81	43.59
25.6	64.27	80.48	62.17	58.15	43.90
25.8	64.63	80.83	62.49	58.49	44.22
26.0	64.98	81.18	62.81	58.83	44.53
26.2	65.33	81.53	63.13	59.17	44.85
26.4	65.68	81.87	63.45	59.51	45.16
26.6	66.03	82.22	63.76	59.85	45.47
26.8	66.37	82.56	64.07	60.18	45.77
27.0	66.71	82.90	64.38	60.51	46.08
27.2	67.05	83.24	64.69	60.84	46.38
27.4	67.39	83.58	65.00	61.17	46.69
27.6	67.73	83.91	65.31	61.50	46.99
27.8	68.07	84.24	65.61	61.82	47.28
28.0	68.40	84.58	65.91	62.14	47.58
28.2	68.73	84.90	66.21	62.46	47.88
28.4	69.06	85.23	66.51	62.78	48.17
28.6	69.39	85.56	66.81	63.10	48.46
28.8	69.72	85.88	67.10	63.42	48.76
29.0	70.04	86.20	67.40	63.73	49.05
29.2	70.37	86.52	67.69	64.05	49.33
29.4	70.69	86.84	67.98	64.36	49.62
<b>29.6</b>	71.01	87.16	68.27	64.67	<b>49.91</b>
29.8	71.33	87.47	68.56	64.98	50.19
30.0	71.64	87.79	68.84	65.29	50.47
30.2	71.96	88.10	69.13	65.59	50.75
30.4	72.27	88.41	69.41	65.90	51.03
30.6	72.59	88.72	69.69	66.20	51.31
30.8	72.90	89.03	69.97	66.50	51.59
31.0	73.21	89.33	70.25	66.80	51.86
31.2	73.52	89.64	70.52	67.10	52.14
31.4	73.82	89.94	70.80	67.40	52.41
31.6	74.13	90.24	71.07	67.69	52.68
31.8	74.43	90.54	71.34	67.99	52.95
32.0	74.73	90.83	71.61	68.28	53.22
32.2	75.03	91.13	71.88	68.57	53.49
32.4	75.33	91.43	72.15	68.87	53.75
32.6	75.63	91.72	72.42	69.15	54.02
32.8	75.93	92.01	72.68	69.44	54.28

Pg	R22	R134a	R407C		R410A
	Ts [°C]	Ts [°C]	Td [°C]	Tb [°C]	Ts [°C]
33.0	76.22	92.30	72.94	69.73	54.54
33.2	76.52	92.59	73.21	70.02	54.80
33.4	76.81	92.88	73.47	70.30	55.06
33.6	77.10	93.16	73.72	70.58	55.32
33.8	77.39	93.45	73.98	70.87	55.58
34.0	77.68	93.73	74.24	71.15	55.84
34.2	77.97	94.01	74.49	71.43	56.09
34.4	78.26	94.29	74.75	71.70	56.34
34.6	78.54	94.57	75.00	71.98	56.60
34.8	78.82	94.85	75.25	72.26	56.85
35.0	79.11	95.12	75.50	72.53	57.10
35.2	79.39	95.40	75.75	72.81	57.35
35.4	79.67	95.67	75.99	73.08	57.60
35.6	79.95	95.94	76.24	73.35	57.85
35.8	80.23	96.21	76.48	73.62	58.09
36.0	80.50	96.48	76.73	73.89	58.34
36.2	80.78	96.75	76.97	74.16	58.58
36.4	81.05	97.01	77.21	74.43	58.82
36.6	81.32	97.28	77.45	74.69	59.07
36.8	81.60	97.54	77.69	74.96	59.31
37.0	81.87	97.80	77.92	75.22	59.55
37.2	82.14	98.06	78.16	75.49	59.78
37.4	82.40	98.32	78.39	75.75	60.02
37.6	82.67	98.58	78.62	76.01	60.26
37.8	82.94	98.84	78.86	76.27	60.50
38.0	83.20	99.09	79.09	76.53	60.73
38.2	83.47	99.34	79.31	76.79	60.96
38.4	83.73	99.60	79.54	77.05	61.20
38.6	83.99	99.85	79.77	77.31	61.43
38.8	84.25	100.09	79.99	77.56	61.66
39.0	84.51	100.34	80.22	77.82	61.89
39.2	84.77	100.59	80.44	78.07	62.12
39.4	85.03	100.83	80.66	78.33	62.35
39.6	85.29	-	80.88	78.58	62.57
39.8	85.54	-	81.10	78.83	62.80
40.0	85.80	-	81.31	79.08	63.02
40.2	86.05	-	81.53	79.33	63.25
40.4	86.30	-	81.74	79.58	63.47
40.6	86.55	-	81.95	79.83	63.69
40.8	86.80	-	82.16	80.08	63.92
41.0	87.05	-	82.37	80.33	64.14
41.2	87.30	-	82.58	80.57	64.36
41.4	87.55	-	82.79	80.82	64.58
41.6	87.80	-	82.99	81.06	64.79
41.8	88.04	-	83.19	81.31	65.01
42.0	88.29	-	83.40	81.55	65.22
42.2	88.53	-	83.60	81.80	65.44
42.4	-	-	-	-	65.65
42.6	-	-	-	-	65.87
42.8	-	-	-	-	66.08
43.0	-	-	-	-	66.29
43.2	-	-	-	-	66.50
43.4	-	-	-	-	66.71
43.6	-	-	-	-	66.92
43.8	-	-	-	-	67.13

# TROUBLESHOOTING

**THE OPERATIONS MUST BE CARRIED OUT BY TECHNICAL QUALIFIED PERSONNEL HAVING THE REQUISITES UNDER LAW REQUISITES AND IN CONFORMITY WITH THE SAFETY REGULATIONS IN FORCE.**

**THE INTERVENTIONS WITHIN THE WARRANTY PERIOD WILL BE CARRIED OUT BY AUTHORIZED SERVICE CENTERS.**

**BEFORE RESETTING AN ALARM, IDENTIFY AND ELIMINATE ITS CAUSE.  
REPEATED RESETS MAY CAUSE SERIOUS DAMAGES.**

In certain machine configurations, some safeties may be placed in series and lead back to a single input on the electronic module.

**Therefore, check on the electrical diagram whether the device to which the alarm corresponds has other devices or safeties connected in series.**

Below is a list of the possible causes of alarms.

## **HIGH PRESSURE** cooling

1. high water temperature (see operating limits)
2. insufficient water flow to the exchanger (high thermal difference between input and output)
3. not CONSTANT flow (for example, if the pumps are turned off, certain areas of the plant are excluded or included, other uses are isolated, etc )
4. Dirt water filter / valves open /air bubbles in the plant
5. dirty exchanger
6. Manostat/transducer: loose electric contacts/terminals, wiring cables interrupted
7. condensation gas in the cooling circuit
8. Too much refrigerant
9. Check the trigger point for the manostat and transducer
10. Check the manostat or transducer pressure control point (deposits of oil, dirt, pin blocked mechanically)

## **FAULTY PROBE**

1. Identify the part on the wiring diagram.
2. Loose electric contacts/terminals, leads broken
3. Check the correct probe ohmic level (using a tester)
4. Change the probe.
5. Check the electronic module configuration (only an authorised service centre can do this)
6. Change the electronic module

## **FAULTY PRESSURE TRANSDUCER**

1. Identify the part on the wiring diagram
2. Loose electric contacts/terminals, leads broken
3. Check the pressure test points are in working order
4. Change the part
5. Check the electronic module configuration (only an authorised service centre can do this)
6. Change the electronic module

## **LOW PRESSURE** cooling

1. low water temperature (see operating limits)
2. insufficient water flow to the exchanger (high thermal difference between input and output)
3. not CONSTANT flow (for example, if the pumps are turned off, certain areas of the plant are excluded or included, other uses are isolated, etc)
4. Dirt water filter / valves open /air bubbles in the plant
5. dirty exchanger
6. Manostat/transducer: loose electric contacts/terminals, wiring cables interrupted
7. refrigerant circuit empty, visible leaks of refrigerant/oil, insufficient charge
8. dryer filter clogged
9. thermostatic device not operating correctly
10. Check the trigger point for the manostat and transducer
11. Check the manostat or transducer pressure control point (deposits of oil, dirt, pin blocked mechanically)

## **COMPRESSOR PROTECTION**

1. Identify the part on the wiring diagram
2. Loose electric contacts/terminals, leads broken
3. electrical windings interrupted
4. Vacuum power voltage below the limits
5. power contactors / contacts defective
6. start-up power voltage lower than the limits
7. electrical absorption high / unbalanced
8. High compressor discharge temperature > thermostatic device needs calibrating, insufficient refrigerant charge

## **PUMP PROTECTION**

1. Identify the part on the wiring diagram
2. pump jammed (probable for circulator pump after lengthy seasonal shutdowns)
3. Loose electric contacts/terminals, leads broken
4. electrical windings of fan interrupted
5. power supply voltage below limits
6. electrical absorption high / unbalanced

### HIGH PRESSURE heating

1. high air temperature (see operating limits)
2. fans do not work, direction of rotation inverted
3. insufficient air flow to coil
4. not CONSTANT flow (for example, if the pumps are turned off, certain areas of the plant are excluded or included, other uses are isolated, etc)
5. dirty air filter
6. condensation gas in the cooling circuit o
7. Too much refrigerant
8. Check the trigger point for the manostat and transducer
9. Manostat/transducer: loose electric contacts/terminals, wiring cables interrupted
10. Check the manostat or transducer pressure control point (deposits of oil, dirt, pin blocked mechanically)

### LOW PRESSURE heating

1. low water temperature (see operating limits)
2. insufficient water flow to the exchanger (high thermal difference between input and output)
3. not CONSTANT flow (for example, if the pumps are turned off, certain areas of the plant are excluded or included, other uses are isolated, etc)
4. Dirt water filter / valves open /air bubbles in the plant
5. dirty exchanger
6. Manostat/transducer: loose electric contacts/terminals, wiring cables interrupted
7. refrigerant circuit empty, visible leaks of refrigerant/oil, insufficient charge
8. dryer filter clogged
9. thermostatic device not operating correctly
10. Check the trigger point for the manostat and transducer
11. Check the manostat or transducer pressure control point (deposits of oil, dirt, pin blocked mechanically)

### CONVERSION TABLE FOR HEATER TEMPERATURE FOR TEMPERATURE PROBES NTC

To check the reliability of the probes in the event of alarm signals, the table below shows the relationship between the temperature and the heater value in Ohms.

Temperature °C	Heater Ω	Temperature °C	Heater Ω	Temperature °C	Heater Ω	Temperature °C	Heater Ω
-20,0	67732	1,0	26094	22,5	11013	43,5	5146
-19,5	66149	1,5	25543	23,0	10805	44,0	5063
-19,0	64604	2,0	25005	23,5	10601	44,5	4981
-18,5	63097	2,5	24480	24,0	10401	45,0	4901
-18,0	61627	3,0	23969	24,5	10206	45,5	4823
-17,5	60193	3,5	23469	25,0	10014	46,0	4747
-17,0	58794	4,0	22982	25,5	9826	46,5	4672
-16,5	57429	4,5	22506	26,0	9643	47,0	4599
-16,0	56098	5,0	22042	26,5	9462	47,5	4527
-15,5	54800	5,5	21589	27,0	9286	48,0	4458
-15,0	53534	6,0	21146	27,5	9113	48,5	4389
-14,5	52300	6,5	20714	28,0	8944	49,0	4322
-14,0	51096	7,0	20292	28,5	8778	49,5	4256
-13,5	49921	7,5	19880	29,0	8615	50,0	4192
-13,0	48777	8,5	19085	29,5	8456	50,5	4128
-12,5	47660	9,0	18701	30,0	8300	51,0	4066
-12,0	46571	9,5	18326	30,5	8147	51,5	4005
-11,5	45510	10,0	17960	31,0	7998	52,0	3944
-11,0	44475	10,5	17602	31,5	7852	52,5	3885
-10,5	43466	11,0	17252	32,0	7708	53,0	3826
-10,0	42482	11,5	16910	32,5	7568	53,5	3767
-9,5	41523	12,0	16576	33,0	7430	54,0	3710
-9,0	40588	12,5	16249	33,5	7296	54,5	3652
-8,5	39676	13,0	15930	34,0	7164	55,0	3595
-8,0	38787	13,5	15617	34,5	7035	55,5	3538
-7,5	37920	14,0	15312	35,0	6909	56,0	3482
-7,0	37075	14,5	15013	35,5	6786	56,5	3425
-6,5	36252	15,0	14720	36,0	6665	57,0	3368
-6,0	35448	15,5	14434	36,5	6547	57,5	3310
-5,5	34665	16,0	14155	37,0	6431	58,0	3252
-5,0	33902	16,5	13881	37,5	6318	58,5	3194
-4,5	33157	17,0	13613	38,0	6208	59,0	3135
-4,0	32431	17,5	13351	38,5	6100	59,5	3075
-3,5	31724	18,0	13094	39,0	5994	60,0	3014
-3,0	31034	18,5	12843	39,5	5891	60,5	2951
-2,5	30361	19,0	12597	40,0	5790	61,0	2888
-2,0	29704	19,5	12356	40,5	5692	61,5	2822
-1,5	29064	20,0	12120	41,0	5596	62,0	2755
-1,0	28440	20,5	11890	41,5	5502	62,5	2686
-0,5	27831	21,0	11663	42,0	5410	63,0	2615
0,0	27238	21,5	11442	42,5	5320	63,5	2542
0,5	26659	22,0	11225	43,0	5232	64,0	2466

## DECOMMISSIONING OF THE UNIT

### DISCONNECTING THE UNIT

The units must be disconnected by authorised personnel, who before proceeding must first read the Residual Risks section in this manual.

Before disconnecting the unit, the following must be recovered, if present:

- the refrigerant (if the circuits cannot be isolated): the refrigerant must be removed using suction devices operating in a closed circuit, so as to ensure that none of the compound is released into the atmosphere.
- the antifreeze in the circuits: when removing this fluid, make sure that it does not leak and that it is not released into the environment. The antifreeze fluid must be stored in special containers.

When recovering the substances present in the unit, all measures must be taken to avoid damaging persons and things and polluting the surrounding area.

Awaiting dismantling and disposal, the unit can also be stored outdoors, as bad weather and rapid changes in temperature will not cause damage to the environment, if electric, cooling and hydraulic circuits of the unit are integral and closed.

### DISMANTLING AND DISPOSAL

**THE UNIT MUST ALWAYS BE SENT TO AUTHORISED CENTRES FOR DISMANTLING AND DISPOSAL.**

When dismantling the unit, the fan, the motor and the coil, if operating, may be recovered by the specialist centres for reuse.

All the materials must be recovered or disposed of in compliance with the corresponding national standards in force.

For further information on the decommissioning of the unit, contact the manufacturer.

# TECHNICAL DATA

## Application: Terminal units

SIZE			17	21	31	41	51	61	71	81	91	101	121	
<b>Cooling</b>														
Cooling capacity	1	kW	5,95	6,42	7,9	10,5	13,4	16,7	20,2	22,1	25,8	30,5	35	
Compressor power input	1	kW	1,51	1,64	1,95	2,4	3,15	3,78	4,82	5,02	5,88	6,56	7,55	
Total power input	2	kW	1,52	1,65	1,96	2,41	3,16	3,79	4,83	5,03	5,89	6,57	7,56	
EER			3,91	3,89	4,03	4,36	4,24	4,41	4,18	4,39	4,38	4,64	4,63	
ESEER			4,29	4,25	4,54	4,84	4,48	4,7	4,59	4,92	4,86	5,13	5,04	
<b>Heating</b>														
Heat output	3	kW	7	7,63	9,28	12	15,6	19,1	23,4	25,1	29,5	34,3	39,3	
Compressor power input	3	kW	1,89	2,06	2,53	3,02	4,12	4,62	5,9	6,39	7,21	8,17	9,22	
Total power input	2	kW	1,9	2,07	2,54	3,03	4,13	4,63	5,91	6,4	7,22	8,18	9,23	
COP			3,68	3,69	3,65	3,96	3,78	4,13	3,96	3,92	4,09	4,19	4,26	
<b>Compressor</b>														
Type of compressors			SCROLL											
No. of Compressors			1											
Std Capacity control steps			1											
Refrigerant charge (C1)		kg	0,8	0,8	0,9	1,1	1,6	1,7	2,4	2,7	3	3,3	3,6	
Refrigerant circuits			1											
<b>Internal exchanger</b>														
Type of internal exchanger	4		PHE											
No. of internal exchangers		Nr	1											
Water flow rate	1	l/s	0,28	0,31	0,38	0,5	0,64	0,8	0,97	1,06	1,23	1,46	1,67	
Useful pump discharge head	1	kPa	56	54,1	53,3	43,4	37,8	59,6	55,1	49,5	43,8	143,5	112,1	
Water content		l	0,6	0,6	0,8	0,8	0,9	1,1	2,2	2,5	2,9	2,9	3,2	
<b>External exchanger</b>														
type of external exchanger	4		PHE											
No. of external exchangers			1											
Water flow rate	1	l/s	0,36	0,39	0,47	0,62	0,79	0,98	1,2	1,3	1,51	1,77	2,03	
pressure drop		kPa	15	17	16	24	28	29	33	29,5	29,7	39,3	42,5	
<b>Connections</b>														
Water fittings	5		1" GAS F											
<b>Hydraulic circuit</b>														
Max water side pressure		kPa	550											
Safety valve calibration		kPa	600											
<b>Expansion vessel</b>														
Expansion vessel capacity		l	1					2						
No. of expansion vessels			1											
<b>Power supply</b>														
Standard power supply			230/1/50					400/3/50+N						
<b>Dimensions</b>														
Length		mm	402	402	402	402	402	573	573	573	573	573	573	
Depth		mm	602	602	602	602	602	604	604	604	604	604	604	
Height		mm	785	785	785	785	785	858	858	858	858	858	858	
<b>Standard unit weights</b>														
Shipping weight		kg	78	79	83	85	99	111	125	140	153	155	160	
Operating weight		kg	80	81	85	88	102	114	128	143	157	159	164	

(1) data referred to the following conditions :

internal exchanger water = 12/7°C

external exchanger water = 30/35°C

(2) The total absorbed power is obtained adding the compressors absorbed power + the power absorbed by the auxiliary circuit.

(3) data referred to the following conditions :

WATER TO INTERNAL EXCHANGER 40/45°C

External exchanger inlet water = 10°C

The water flow in the external exchanger is the same of the cooling operation.

(4) PHE = plates

(5) water connections both source side and utility side

**Applicaton: Unit for radiant panels**

<b>Size</b>		<b>17</b>	<b>21</b>	<b>31</b>	<b>41</b>	<b>51</b>	<b>61</b>	<b>71</b>	<b>81</b>	<b>91</b>	<b>101</b>	<b>121</b>	
<b>Cooling</b>													
Cooling capacity	1 kW	8,34	8,95	10,1	14	18,3	22,5	26,1	30	33,4	41,8	47,5	
Compressor power input	1 kW	1,46	1,48	1,85	2,32	2,97	3,94	4,97	5,09	5,99	6,64	7,95	
Total power input	2 kW	1,47	1,49	1,86	2,33	2,98	3,95	4,98	5,1	6	6,65	7,96	
EER		5,67	6,01	5,43	6,01	6,14	5,7	5,24	5,88	5,57	6,29	5,97	
<b>Heating</b>													
Heat output	3 kW	7,27	7,85	9,59	12,6	16,2	19,9	24,4	26,4	30,9	36,1	41,4	
Compressor power input	3 kW	1,51	1,64	1,95	2,39	3,14	3,76	4,79	5	5,85	6,53	7,53	
Total power input	2 kW	1,52	1,65	1,96	2,4	3,15	3,77	4,8	5,01	5,86	6,54	7,54	
COP		4,78	4,76	4,89	5,25	5,14	5,28	5,08	5,27	5,27	5,52	5,49	
<b>Compressor</b>													
Type of compressors		SCROLL											
No. of Compressors		1											
Std Capacity control steps		1											
Refrigerant charge (C1)	kg	0,8	0,8	0,9	1,1	1,6	1,7	2,4	2,7	3	3,3	3,6	
Refrigerant circuits		1											
<b>Internal exchanger</b>													
Type of internal exchanger	4	PHE											
No. of internal exchangers	Nr	1											
Water flow rate	1 l/s	0,4	0,43	0,48	0,67	0,87	1,08	1,25	1,43	1,6	2	2,27	
Useful pump discharge head	1 kPa	45,5	42,5	45	27,3	17,8	38,6	33,7	22,8	18,6	37,5	15	
Water content	l	0,6	0,6	0,8	0,8	0,9	1,1	2,2	2,5	2,9	2,9	3,2	
<b>Exsternal exchanger</b>													
type of external exchanger	4	PHE											
No. of exsternal exchangers		1											
Water flow rate	l/s	0,47	0,5	0,57	0,78	1,02	1,26	1,48	1,68	1,88	2,31	2,65	
pressure drop	kPa	18	20	18	31	31	36	42	38	38	49	53,4	
<b>Connections</b>													
Water fittings	5	1" GAS F											
<b>Hydraulic circuit</b>													
Max water side pressure	kPa	550											
Safety valve calibration	kPa	600											
<b>Expansion vessel</b>													
Expansion vessel capacity	l	1					2						
No. of expansion vessels		1											
<b>Powee supply</b>													
Standard power supply		230/1/50					400/3/50+N						
<b>Dimensios</b>													
Length	mm	402	402	402	402	402	573	573	573	573	573	573	
Depth	mm	602	602	602	602	602	604	604	604	604	604	604	
Height	mm	785	785	785	785	785	858	858	858	858	858	858	
<b>Standard unit weights</b>													
Shipping weight	kg	78	79	83	85	99	111	125	140	153	155	160	
Operating weight	kg	80	81	85	88	102	114	128	143	157	159	164	

(1) data referred to the following conditions :

external exchanger water = 30/35°C

internal exchanger water = 23/18°C

(2) The total absorbed power is obtained adding the compressors absorbed power + the power absorbed by the auxilliary circuit.

(3) data referred to the following conditions :

WATER TO INTERNAL EXCHANGER 40/45°C

External exchanger inlet water = 10°C

The water flow in the external exchanger is the same of the cooling operation.

(4) PHE = plates

(5) water connections both source side and utility side

**TARATURE PROTEZIONE E CONTROLLI**

		<b>Apri</b>	<b>Chiude</b>	<b>Valore</b>
Pressostato di sicurezza alta pressione	kPa	4200	3300	--
Pressostato di sicurezza bassa pressione	kPa	200	350	--
Protezione antigelo	°C	4	6,5	
Max. n° avviamenti del compressore per ora	Nr	--	--	10
Termostato sicurezza sovratemperature scarico compressore	°C	--	--	120

### OPERATIVE LIMITS (COOLING)

SIZE			17	21	31	41	51	61	71	81	91	101	121
<b>EXTERNAL EXCHANGER</b>													
Min. water inlet temperature	1	°C						15					
Min. water inlet temperature	2	°C						6					
Max water outlet temperature	1	°C						55					
Min. water outlet temperature		°C						28					
Water thermal head (min / max)		°C						5/16					
<b>INTERNAL EXCHANGER</b>													
Max water inlet temperature		°C						24					
Max water outlet temperature		°C						18					
Max water outlet temperature	3	°C						5					
Water thermal head (min / max)		°C						3/8					

### OPERATIVE LIMITS (HEATING)

<b>EXTERNAL EXCHANGER</b>													
Max water outlet temperature		°C						18					
Min. water outlet temperature	3	°C						5					
<b>INTERNAL EXCHANGER</b>													
Max water outlet temperature	4	°C						55					
Water thermal head (min / max)		°C						3/8					

internal exchanger = source side exchanger

(1) standard unit

(2) The limit is referred to the use of a modulating or pressostatic valve, at the external exchanger inlet.

external exchanger = utility side exchanger

(3) antifreeze set-point

(4) External exchanger inlet water = 10°C

### SOUND LEVEL

size	Sound Power Level (dB)								Sound pressure level dB(A)	Sound power level dB(A)
	Octave band (Hz)									
	63	125	250	500	1000	2000	4000	8000		
17	78	69	55	46	47	40	34	29	43	57
21	78	69	56	48	47	38	35	32	43	57
31	79	67	57	51	49	41	41	35	44	57
41	78	70	59	50	47	43	38	34	44	58
51	77	69	61	54	49	41	39	36	45	58
61	78	67	62	55	54	46	43	38	46	60
71	77	72	65	62	53	47	44	38	49	63
81	78	73	66	63	54	48	45	39	50	64
91	81	68	68	65	56	52	49	45	51	65
101	79	75	68	63	56	55	49	44	52	66
121	80	74	70	65	58	55	51	45	53	67

Measures according to ISO 3744 regulations, with respect to the EUROVENT 8/1 certification.

The sound pressure is measured at 1 m from the external surface of the unit in open field conditions.

data referred to the following conditions :  
internal exchanger water = 12/7°C  
external exchanger water = 30/35°C

### PUMP PERFORMANCE 1

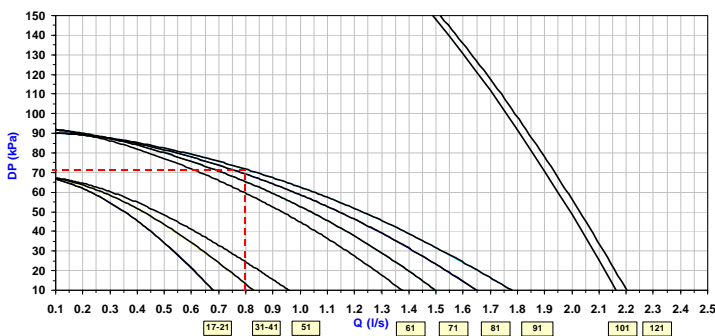

UTILITY SIDE PUMP (STANDARD)

Q[L/S]= WATER-FLOW RATE

DP[KPA]=USEFUL DISCHARGE HEAD

THE HEADS ARE INTENDED AS AVAILABLE AT THE UNIT CONNECTIONS

### PUMP PERFORMANCE 2

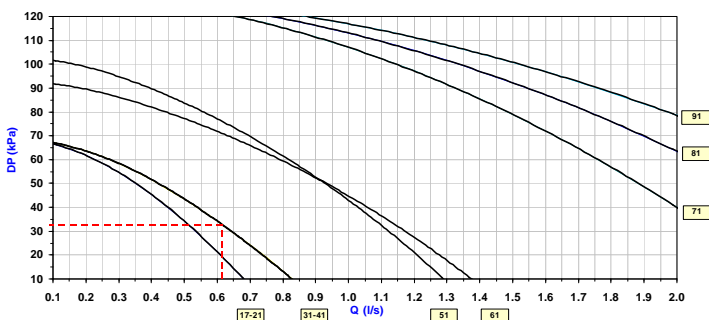

SOURCE SIDE CIRCULATING PUMP (OPTIONAL)

Q [L/S] = WATER FLOW-RATE

DP [KPA] = USEFUL DISCHARGE HEAD

Configuration not available for sizes 101 and 121

# DIMENSIONS

Size 17-51

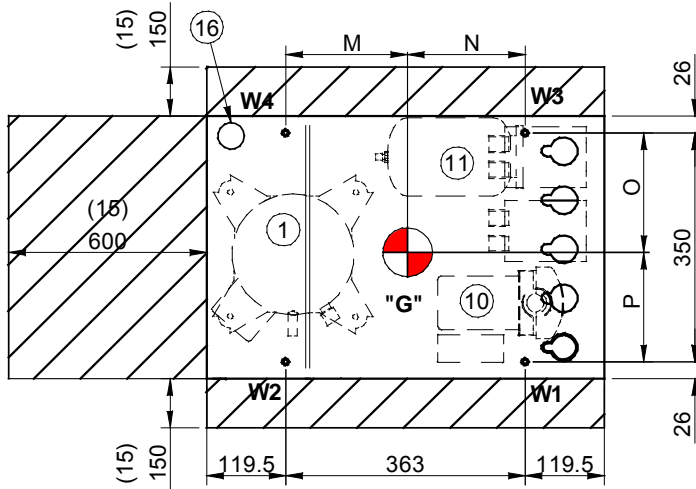
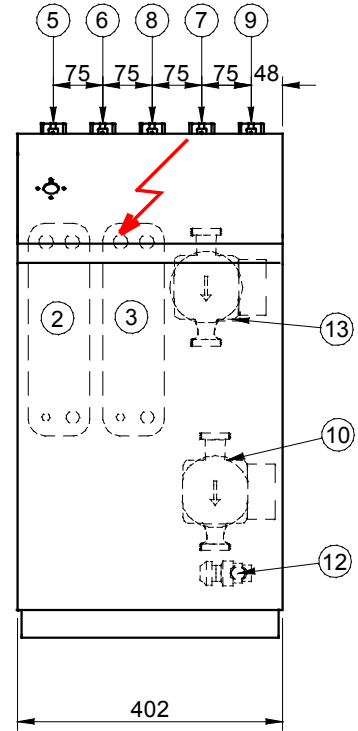
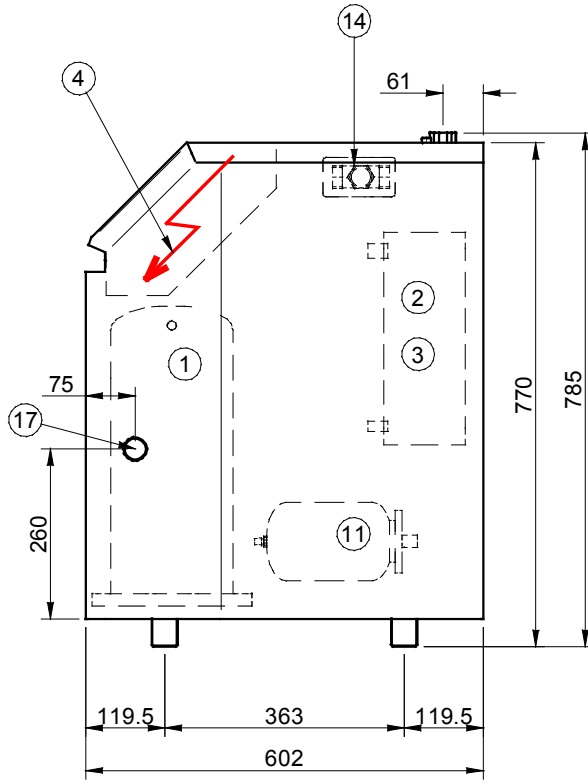

SIZE		17	21	31	41	51
M	mm	180	176	181	193	175
N	mm	186	187	186	170	188
O	mm	170	170	168	168	170
P	mm	180	180	182	182	180
Length	mm	402	402	402	402	402
Depth	mm	602	602	602	602	602
Height	mm	785	785	785	785	785
W1	kg	18	18	20	20	22
W2	kg	20	21	21	22	27
W3	kg	20	19	21	22	24
W4	kg	22	23	23	24	29
Operating weight	kg	80	81	85	88	102
Shipping weight	kg	78	79	83	85	99

- (1) COMPRESSOR
- (2) INTERNAL EXCHANGER = UTILITY SIDE EXCHANGER
- (3) EXTERNAL EXCHANGER = SOURCE SIDE EXCHANGER
- (4) ELECTRICAL PANEL
- (5) INTERNAL EXCHANGER WATER INLET
- (6) INTERNAL EXCHANGER WATER OUTLET
- (7) EXTERNAL EXCHANGER WATER INLET
- (8) EXTERNAL EXCHANGER WATER OUTLET
- (9) SANITARY WATER OUTLET 1" F GAS (OPTIONAL)
- (10) UTILITY SIDE PUMP (STANDARD)
- (11) EXPANSION VESSEL
- (12) WATER SIDE SAFETY VALVE
- (13) SOURCE SIDE PUMP (OPTIONAL)
- (14) 3 WAYS-VALVE (OPTIONAL)
- (15) CLEARANCE ACCESS RECOMMENDED
- (16) POWER INPUT
- (17) 1/2" GAS CHARGE FITTING
- (G) BARYCENTRE



### Size 61-121

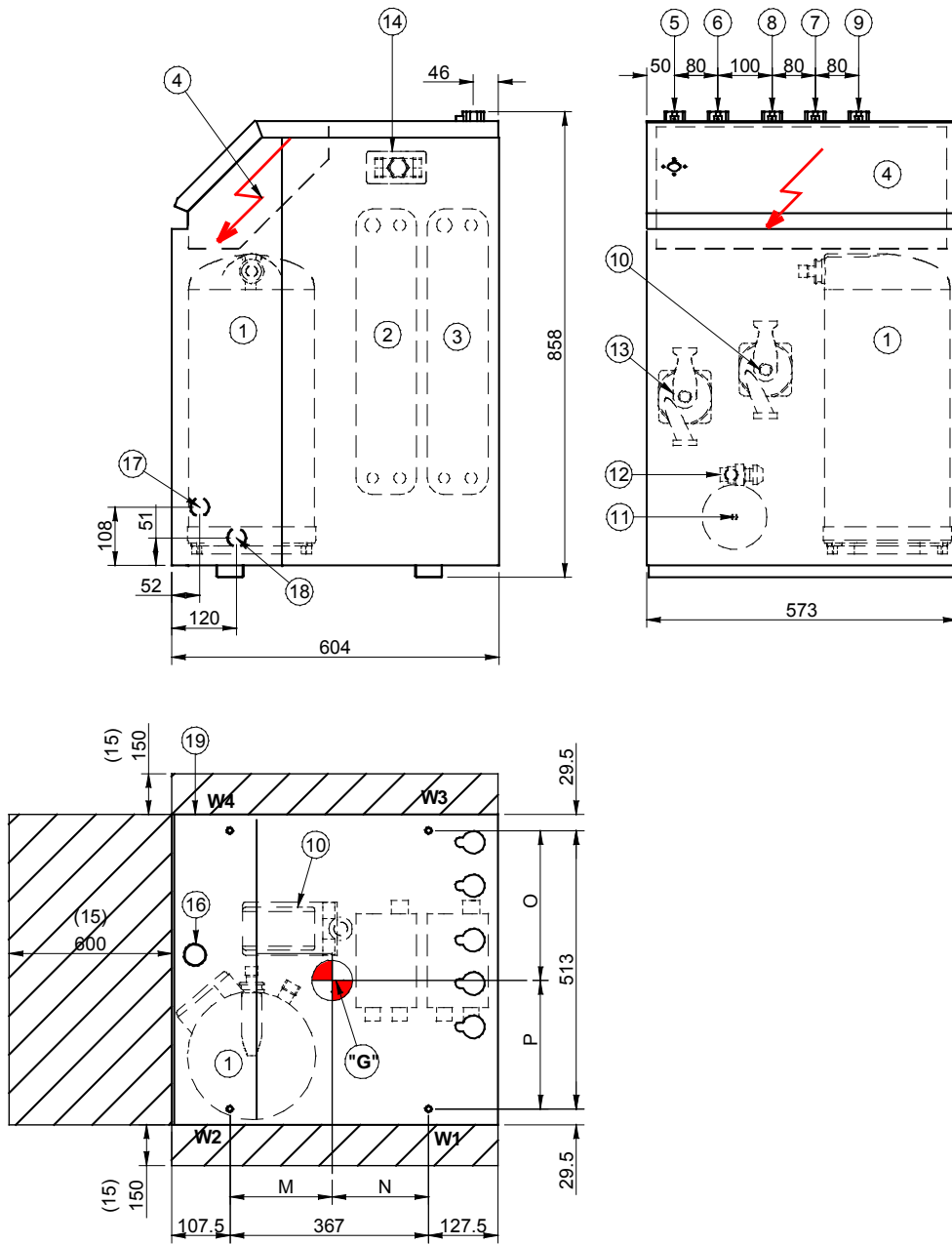

SIZE		61	71	81	91	101	121
M	mm	152	165	173	174	175	182
N	mm	215	202	197	193	192	185
O	mm	285	300	330	333	336	331
P	mm	228	213	186	180	177	182
Length	mm	573	573	573	573	573	573
Depth	mm	604	604	604	604	604	604
Height	mm	858	858	858	858	858	858
W1	kg	19	29	41	46	48	53
W2	kg	45	47	55	59	59	56
W3	kg	15	20	21	23	23	27
W4	kg	35	32	26	29	29	28
Operating weight	kg	114	128	143	157	159	164
Shipping weight	kg	111	125	140	153	155	160

- (1) COMPRESSOR
- (2) INTERNAL EXCHANGER = UTILITY SIDE EXCHANGER
- (3) EXTERNAL EXCHANGER = SOURCE SIDE EXCHANGER
- (4) ELECTRICAL PANEL
- (5) INTERNAL EXCHANGER WATER INLET
- (6) INTERNAL EXCHANGER WATER OUTLET
- (7) EXTERNAL EXCHANGER WATER INLET
- (8) EXTERNAL EXCHANGER WATER OUTLET
- (9) SANITARY WATER OUTLET 1" F GAS (OPTIONAL)
- (10) UTILITY SIDE PUMP (STANDARD)
- (11) EXPANSION VESSEL
- (12) WATER SIDE SAFETY VALVE
- (13) SOURCE SIDE PUMP (OPTIONAL)
- (14) 3 WAYS-VALVE (OPTIONAL)
- (15) CLEARANCE ACCESS RECOMMENDED
- (16) POWER INPUT
- (17-19) 1/2" GAS CHARGE FITTINE (SIZES 61-71-81-91)
- (18-19) 1/2" GAS CHARGE FITTINE (SIZES 101-121)
- (G) BARYCENTRE

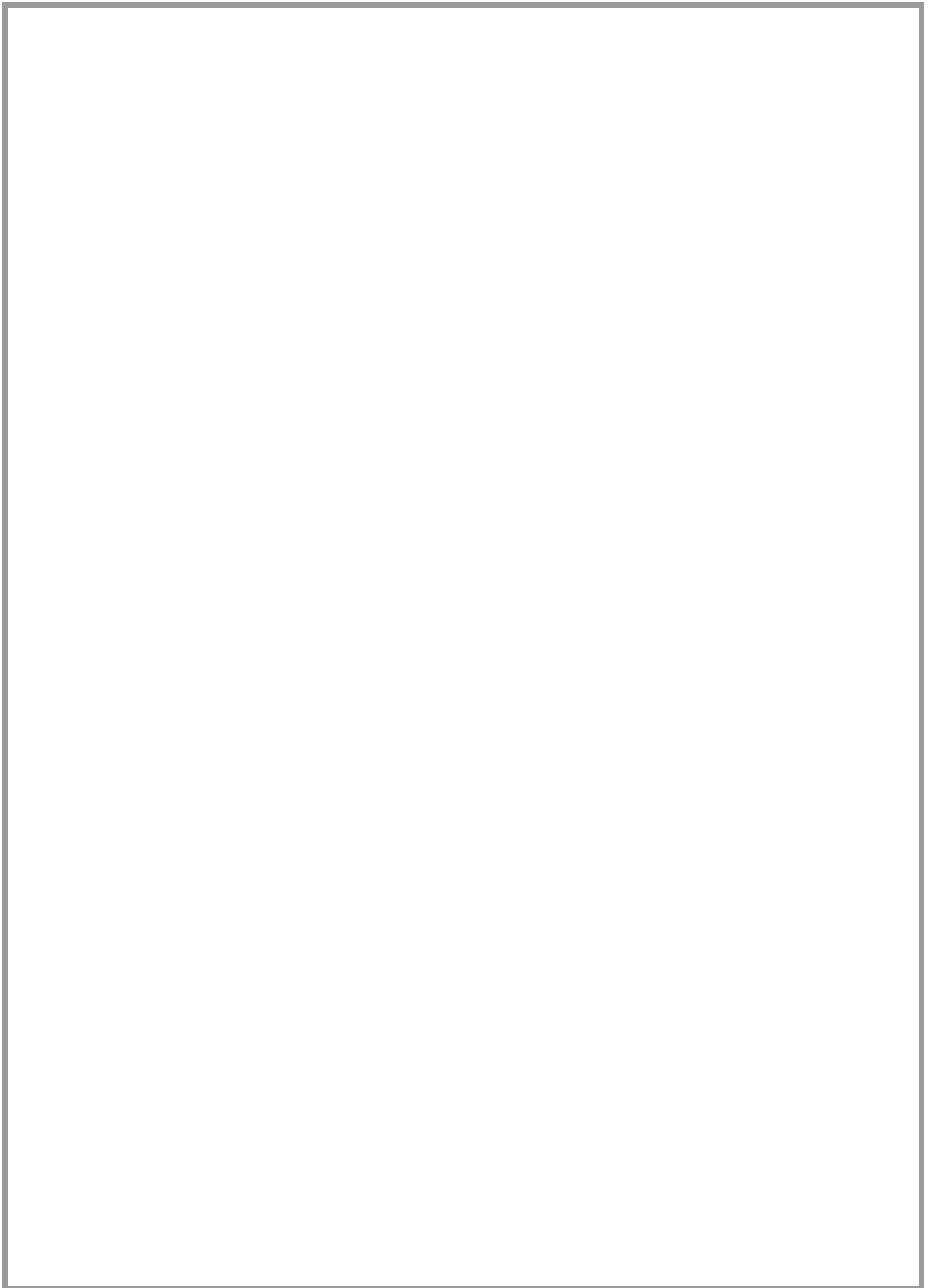



**CLIVET SPA**  
**Feltre (BL) ITALY**  
Tel. + 39 0439 3131  
Fax + 39 0439 313300  
info@clivet.it

**CLIVET ESPAÑA S.A.**  
**Madrid - SPAIN**  
Tel. + 34 91 6658280  
Fax + 34 91 6657806  
info@clivet.es

**CLIVET UK LTD**  
**Fareham (Hampshire) U.K.**  
Tel. + 44 (0) 1489 572238  
Fax + 44 (0) 1489 573033  
info@clivet-uk.co.uk

**CLIVET NEDERLAND B.V.**  
**Amersfoort - Netherlands**  
Tel. + 31 (0) 33 7503420  
Fax + 31 (0) 33 7503424  
info@clivet.nl

**CLIVET SPA**  
**BUREAU DE LIAISON EN FRANCE**  
**Verrierès le Buisson - FRANCE**  
Tel. + 33 (0)1 69 20 25 75  
Fax + 33 (0)1 69 20 60 76  
info.fr@clivet.com

**CLIVET GmbH**  
**Norderstedt - GERMANY**  
Tel. +49 (0) 40 32 59 57-0  
Fax +49 (0) 40 32 59 57-194  
info.de@clivet.com

**CLIVET TFAIR SYSTEMS (P) LTD.**  
**Malur - INDIA**  
Tel. +91 8151 232683/5  
Fax +91-8151-232684  
info@clivettfa.com

The data contained in this bulletin is not binding and may be changed by the manufacturer without prior notice. All reproduction, even partial, is PROHIBITED.

© COPYRIGHT - CLIVET S.P.A. - FELTRE (BL) - ITALIA