

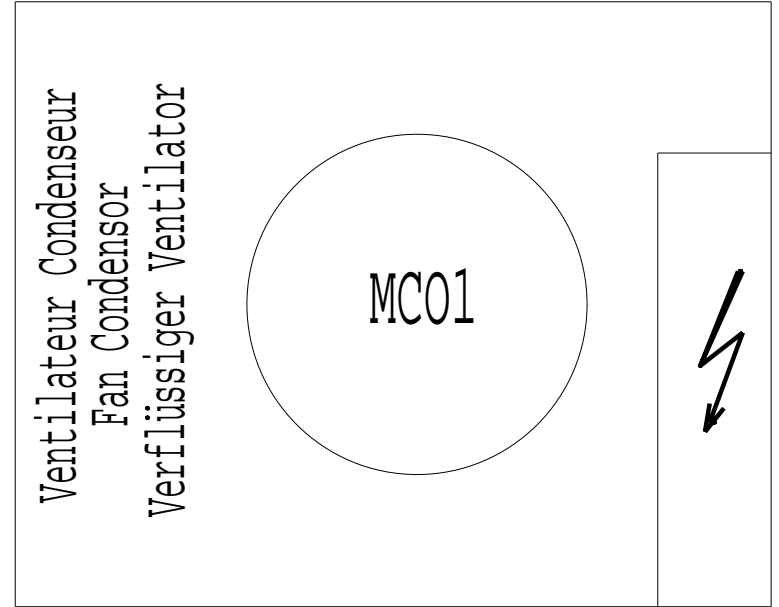

J
I
H
G
F
E
D
C

Pompes / Pumps / Pumpen

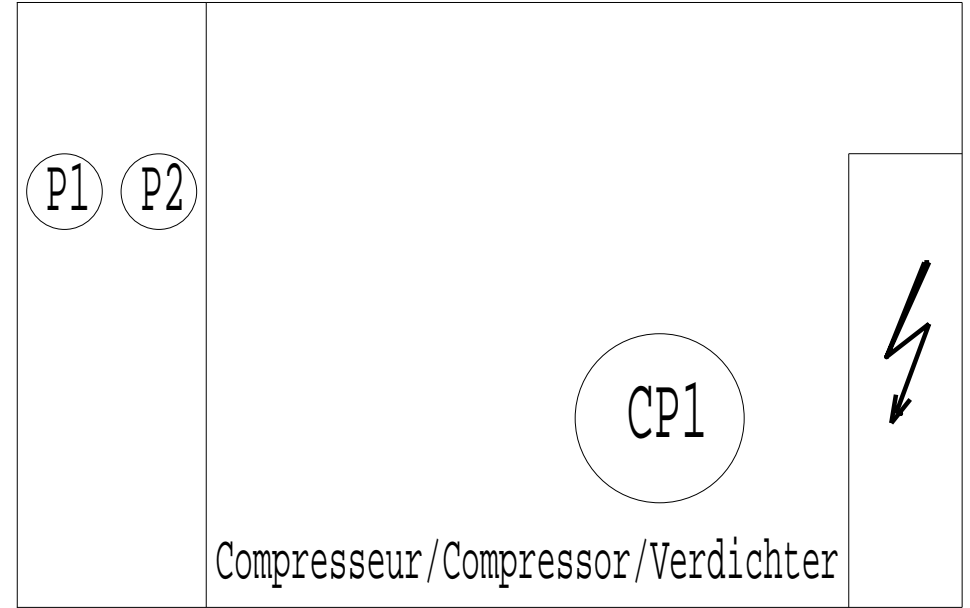

MODIFIE PAR: MODIFIED BY: GEANDERT DURCH: PG		INDICE INDEX KENNZIFFER 37		DATE DATE DATUM 11-07-00				APPAREIL OU UNITE/UNIT/GERAT ODER EINHEIT LDH 100 - 150							
MODIFICATION A RENUMEROTE FILS ET BORNES				LEGENDE/LEGEND/LEGENDE 3950010.36		SPECIFICATION/SPECIFICATION/SPEZIFIZIERUNG 1 COMPRESSEUR 1 CIRCUIT MRS4-2 1 COMPRESSOR 1 CIRCUIT 1 VERDICHTER 1 KREISLAUF									
REMPLACE/TAKE/ERSETZT 3980704		REMPLACE PAR/TAKE BY/ERSETZT DURCH		CLIENT/CLIENT/KUNDE		REFERENCE/REFERENCE/REFERENZ		CREATEUR: CREATOR: HERSTELLER: AB		DATE: DATE: DATUM: 17-07-98					
REFERENCES COMMANDE/ORDER REFERENCES/AUFTRAGSREFERENZ				DEMARRAGE/START/ANLAUF		TENSION/VOLTAGE/SPANNUNG		COMPAGNIE INDUSTRIELLE D'APPLICATIONS THERMIQUES 		FOLIO/FOLIO/SEITE 1 / 6		NUMERO DE SCHEMA/DRAWING NUMBER/PLAN NR 3980769		INDICE/INDEX/KENNZIFFER 37	

J
I
H
G
F
E
D
C
B
A

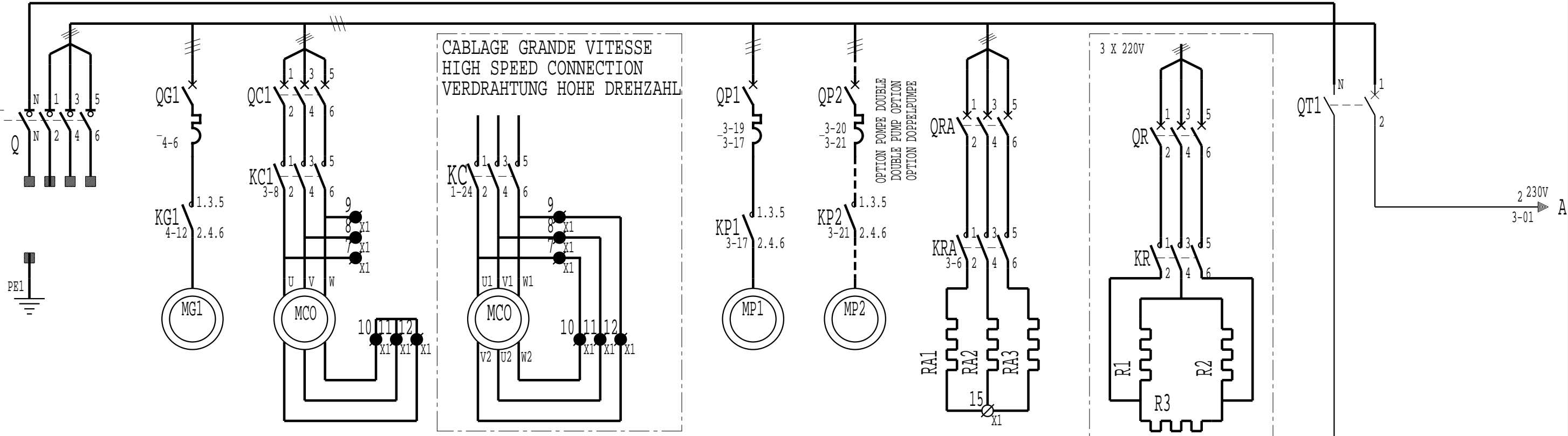

RACCORDEMENTS USINE
FACTORY CONNECTION
WERKSEITIGE VERDRAHTUNG

RACCORDEMENTS CLIENT
CONNECTED BY CUSTOMER
ANSCHLUSS-KUNDE

Terminal	Function
1	CONTACT DE SIGNALISATION DEFAUT / DEFECT INDICATOR CONTACT / STÖRMELDEKONTAKT
2	CONTACT DE SIGNALISATION DEFAUT / DEFECT INDICATOR CONTACT / STÖRMELDEKONTAKT
3	COMMANDE D'AUTOMATICITE / AUTOMATIC CONTROL / EXTERNE FREIGABE
4	COMMANDE D'AUTOMATICITE / AUTOMATIC CONTROL / EXTERNE FREIGABE
5	PROTECTION IPSOTHERMIQUE MOTEURS VENTILATEURS / ISOTHERMIC PROTECTOR OF FANS MOTORS / THERMOSCHUTZ LÜFTERMOTOREN
6	PROTECTION IPSOTHERMIQUE MOTEURS VENTILATEURS / ISOTHERMIC PROTECTOR OF FANS MOTORS / THERMOSCHUTZ LÜFTERMOTOREN
7	OPTION GRANDE VITESSE VENTILATEUR 1 / HIGH SPEED OPTION FAN 1 / OPTION HOHE DREHZAHL VENTILATOR 1
8	OPTION GRANDE VITESSE VENTILATEUR 1 / HIGH SPEED OPTION FAN 1 / OPTION HOHE DREHZAHL VENTILATOR 1
9	OPTION GRANDE VITESSE VENTILATEUR 1 / HIGH SPEED OPTION FAN 1 / OPTION HOHE DREHZAHL VENTILATOR 1
10	PETITE VITESSE VENTILATEUR 1 / LOW SPEED FAN 1 / NIEDRIGE DREHZAHL VENTILATOR 1
11	PETITE VITESSE VENTILATEUR 1 / LOW SPEED FAN 1 / NIEDRIGE DREHZAHL VENTILATOR 1
12	PETITE VITESSE VENTILATEUR 1 / LOW SPEED FAN 1 / NIEDRIGE DREHZAHL VENTILATOR 1
13	COMMANDE POMPES EAU / WATER PUMPS CONTROL / WASSERPUMPENSTEUERUNG
14	COMMANDE POMPES EAU / WATER PUMPS CONTROL / WASSERPUMPENSTEUERUNG
15	RESISTANCE AMBIANCE CAISSON / UNIT AMBIENT HEATER / HEIZUNG

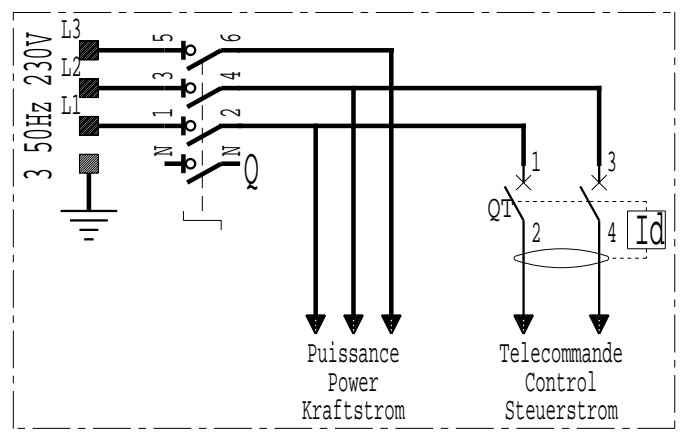

J
I
H
G
F
E
D
C
B
A

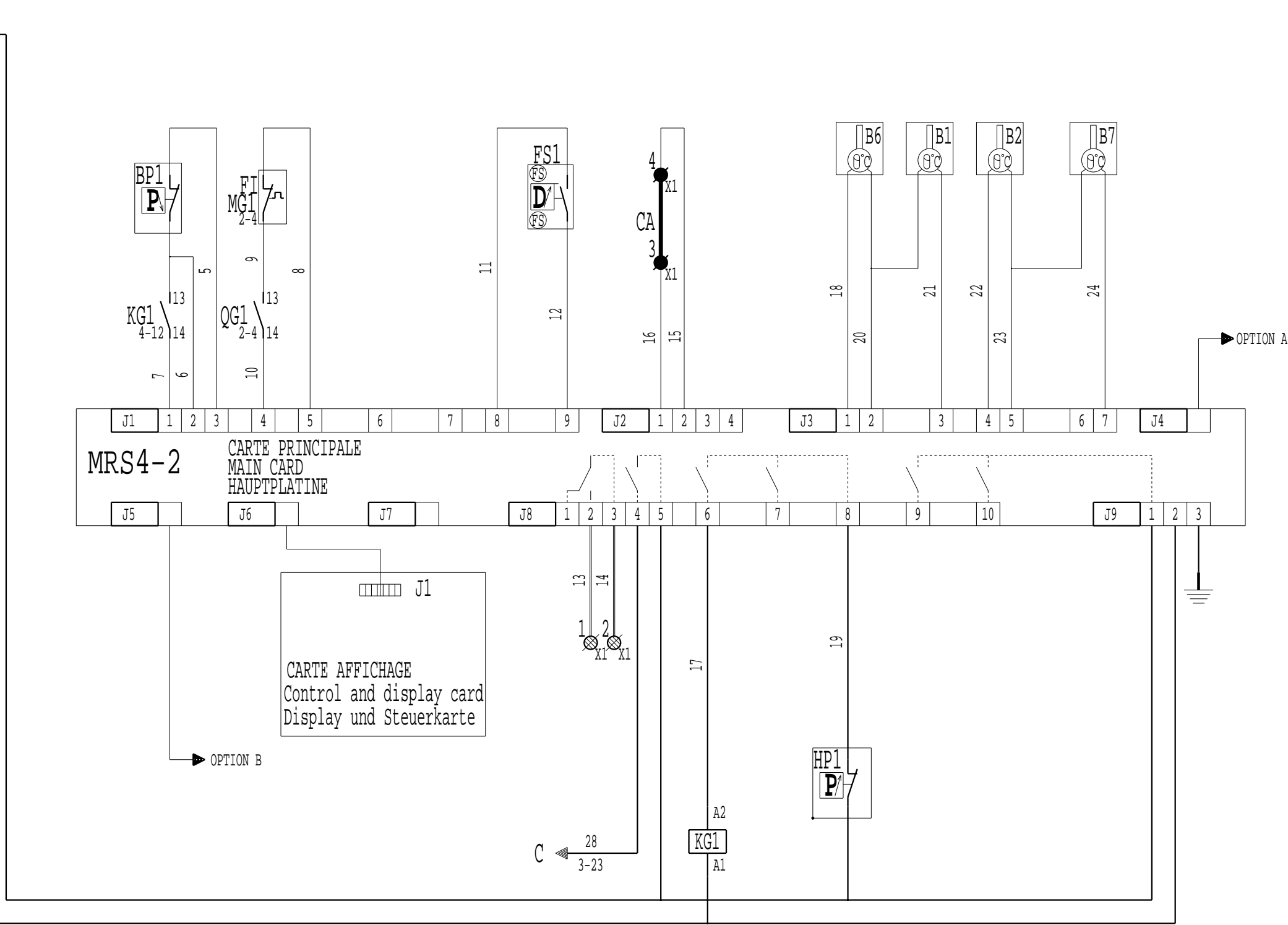

MRS4_2	
B1	Sonde entree eau glatee Inlet chilled water sensor Fühler Kaltwassereintritt
B2	Sonde sortie evaporateur N 1 Evaporator N 1 outlet sensor Austrittsfühler Verdampfer N 1
B3	Sonde temperature freon Refrigerant temperature sensor Fühler Kältemitteltemperatur
B5	Sonde eau chaude Hot water sensor Warmwasserfühler
B6	Sonde air exterieur External air sensor Aussenluftfühler
B7	Sonde de refluxement Discharge sensor Heissgasfühler

OPTION A MRS	
INTERFACE RX-TX	(RS485-4 fils)
INTERFACE RX-TX	(RS485-4 WIRES)
ANSCHLUSS INTERFACE RX-TX	(RS485 - 4 ADERN)

OPTION B MRS	
CAD-RELAYAGE-PC	(RS485-2 fils)
INTERFACE RX-TX	(RS485-2 WIRES)
ANSCHLUSS CAD-RELAIS-PC	(RS485 - 2 ADERN)

	HP - BP			FS
	PENN P77	RANCO 016	MINI	
BP	3 2	4 2	4 2	IT CONTROL 3/D/12 PENN 2/D/13
AUTO	1	1	1	
HP	3 2	2 4	2 4	
MANU	1	1	1	
HP	2 3	4 2	2 4	
AUTO	1	1	1	

O	F
	2-4
	4-5

MRS4-2

DEFAUT GENERAL

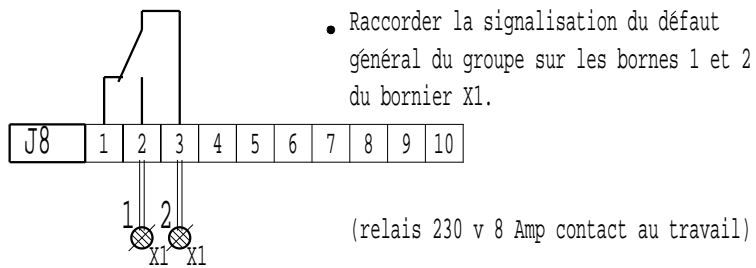

GENERAL FAULT

The fault or not-fault information on the unit can be recover on terminals 1 and 2 connector X1.

(relay 230V 8 Amp.)

SAMMELSTÖRMELDUNG

Die Störungsmeldung wird an den Klemmen 1 und 2 der Anschlusse X1 abgenommen.

(Relais 230V 8 Amp)

COMMANDE D'AUTOMATICITE

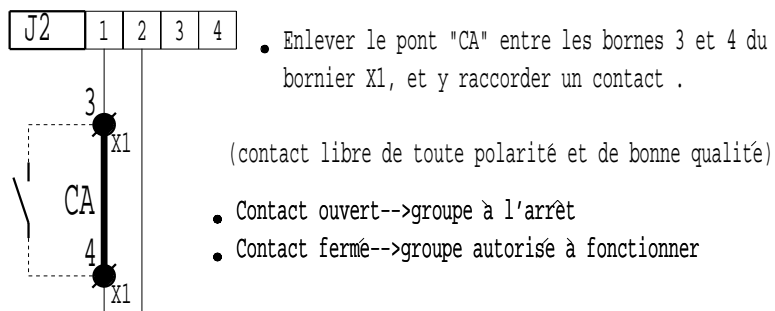

AUTOMATIC CONTROL

The shunt "CA" on terminals 3 and 4 of connector X1, must be lifted and the contact connected.
(contact must be polarity free and of good quality)

Contact open-->unit off-line
Contact closed-->unit on-line

EXTERNE FREIGABE

Die Brücke "CA" an den Klemmen 3 und 4 am Anschluss X1 entfernen und externen Kontakt anschliessen.
(Kontakt unbedingt potentialfrei anschliessen)

Kontakt offen-->Gerät abgeschaltet
Kontakt geschlossen-->Gerät Betriebsbereit

SELECTION CHAUD/FROID

- Configuration P17 valeur 3

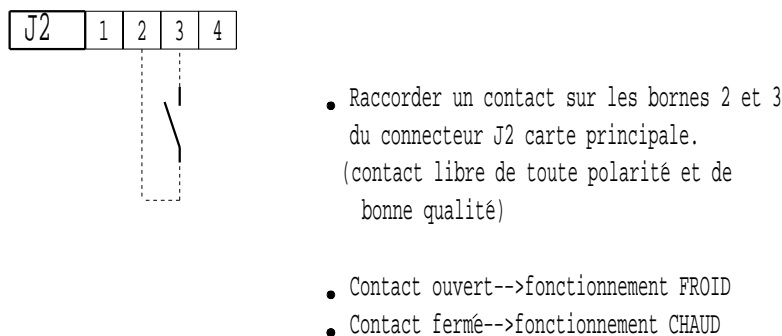

HEATING/COOLING SELECTION

- Configuration P17 value 3

The controle device must be connected to terminals 2 and 3 on connector J2 of main card.
(contact must be polarity free and of good quality)

Contact open-->COOLING operation
Contact closed-->HEATING operation

AUSWAHL HEIZ-O.KÜHLBETRIEB

- Konfiguration P17 Wert 3

Der Kontakt wird an den Klemmen 2 und 3 am Stecker J2 der Hauptplatine angeschlossen
(Kontakt unbedingt potentialfrei anschliessen)

Kontakt offen-->Kühlbetrieb
Kontakt geschlossen-->Heizbetrieb

MRS4-2

SELECTION CONSIGNE 1 ou 2

- Configuration P18 valeur 3

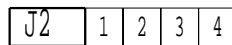

- Raccorder un contact entre les bornes 2 et 4 du connecteur J2 carte principale.
(contact libre de toute polarité et de bonne qualité)
- Contact ouvert-->CONSIGNE 1
- Contact fermé-->CONSIGNE 2

COMMANDE POMPE A EAU

- Raccorder l'alimentation de la pompe entre les bornes 4 et 5 du connecteur J8 de la carte principale.

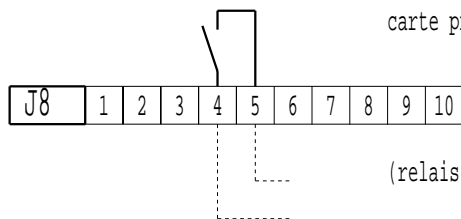

(relais 230V 8 Amp.)

COMMANDE DES ETAGES FORCES

- Configuration P16 valeur 2

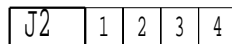

- Raccorder les contacts sur chaque entrée du connecteur J2 pour commander les différents étages
(contact libre de toute polarité et de bonne qualité)
- Suivant le nombre d'étages, il suffit de raccorder des contacts à fermeture.

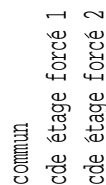

PRECAUTIONS DE RACCORDEMENT

POUR LES PRECAUTIONS A PRENDRE POUR LE RACCORDEMENT DES ENTREES VOIR LE MANUEL D'UTILISATION MRS4-2 PARAGRAPHE : "ASSERVISSEMENT ET COMMANDES EXTERNES"

SETTING 1 OR 2 SELECTION

- Configuration P18 value 3

- The controle must be connected to terminals 2 and 4 connector J2 main card.
(contact must be polarity free and of good quality)
- Contact open-->SETTING 1 operation
- Contact closed-->SETTING 2 operation

WATER POMP CONTROL

- The pump control must be connected to terminals 4 and 5 on connector J8 of main card.

(relay 230V 8 Amp.)

FORCED STAGES CONTROL

- Configuration P16 value 2

- The control of the various stages is made by an external control connected to the connector J2 of the main card.
(contact must be polarity free and of good quality)
- According to the number of stages, connection of NO (normally open) contacts is sufficient.

CAUTION

TO TAKE PRECAUTION FOR CLIENT'S CONNECTION OF INPUTS SEE THE OPERATING AND MAINTENANCE INSTRUCTIONS OF MICROCIAT MRS4-2 PARAGRAPH : "SERVO CONTROL AND EXTERNAL CONTROLS"

AUSWAHL SOLLWERT 1 ODER 2

- Konfiguration P18 Wert 3

- Der Kontakt wird an den Klemmen 2 und 4 am Stecker J2 der Hauptplatine angeschlossen.
(Kontakt unbedingt potentialfrei anschliessen)
- Kontakt offen-->Sollwert 1
- Kontakt geschlossen-->Sollwert 2

PUMPENSTEUERUNG

- Der Kontakt wird an den Klemmen 4 und 5 am Stecker J8 der Hauptplatine angeschlossen.

(Relais 230V 8 Amp)

EXTERNERBETRIEB DER STUFEN

- Konfiguration P16 Wert 2

- Die Regelung der verschiedenen Stufen wird mit einem externen Kontakt am Stecker J2 der Hauptplatine hergestellt.
(Kontakt unbedingt potentialfrei anschliessen)
- Die Zuverdrahtende Kontaktanzahl ist von der Stufenanzahl abhängig.

ACHTUNG

Um Anschlussfehler zu vermeiden, unbedingt die Betriebs- und Wartungsanleitung MRS4-2 Abschnitt Regelung und externe Regelung beachten.

J
I
H
G
F
E
D
C

Pompes / Pumps / Pumpen

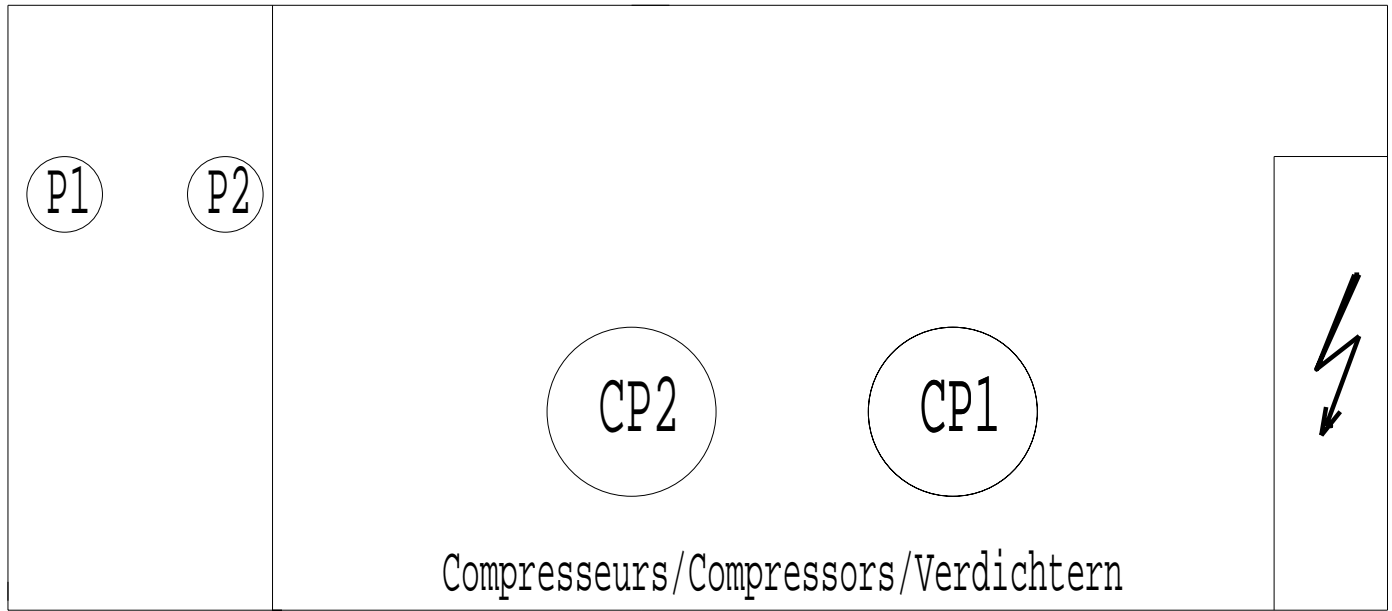

Ventilateurs Condenseur
Fans Condensor
Verflüssiger Ventilatoren



MODIFIE PAR: MODIFIED BY: GEANDERT DURCH: PG		INDICE INDEX KENNZIFFER 38		DATE DATE DATUM 11-07-00				APPAREIL OU UNITE/UNIT/GERAT ODER EINHEIT LDH 200 A 300							
MODIFICATION A RENUMEROTE FILS ET BORNES				LEGENDE/LEGEND/LEGENDE 3950010.36		SPECIFICATION/SPECIFICATION/SPEZIFIZIERUNG 2 COMPRESSEURS 1 CIRCUIT MRS4-2 2 COMPRESSORS 1 CIRCUIT 2 VERDICHTERN 1 KREISLAUF									
REMPLACE/TAKE/ERSETZT 3980705		REMPLACE PAR/TAKE BY/ERSETZT DURCH		CLIENT/CLIENT/KUNDE		REFERENCE/REFERENCE/REFERENZ		CREATEUR: CREATOR: HERSTELLER: AB		DATE: DATE: DATUM: 20-07-98					
REFERENCES COMMANDE/ORDER REFERENCES/AUFTRAGSREFERENZ				DEMARRAGE/START/ANLAUF		TENSION/VOLTAGE/SPANNUNG		COMPAGNIE INDUSTRIELLE D'APPLICATIONS THERMIQUES CIAT		FOLIO/FOLIO/SEITE 1 / 7		NUMERO DE SCHEMA/DRAWING NUMBER/PLAN NR 3980771		INDICE/INDEX/KENNZIFFER 38	

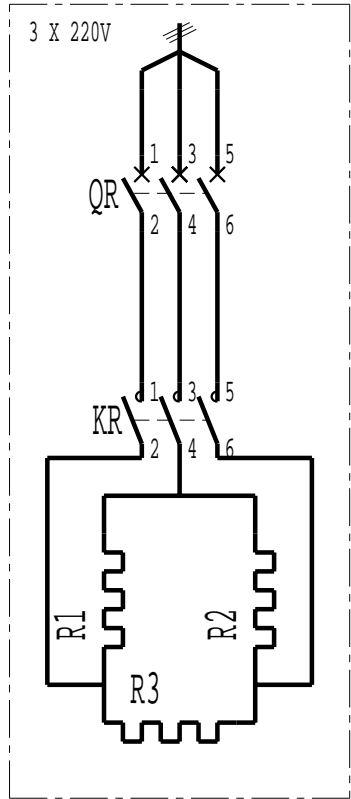
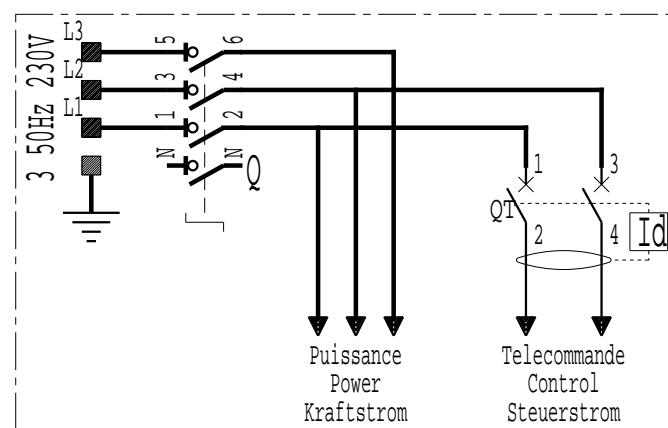
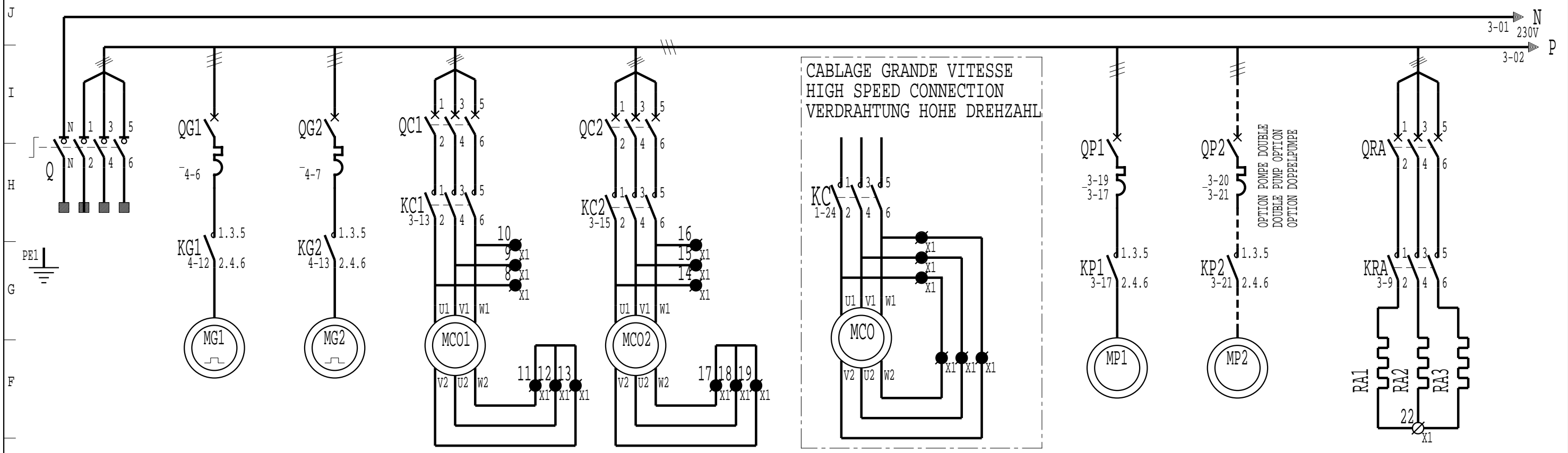

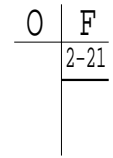
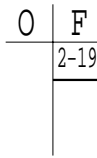
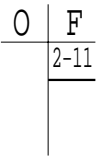
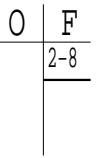
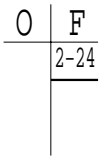
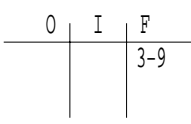
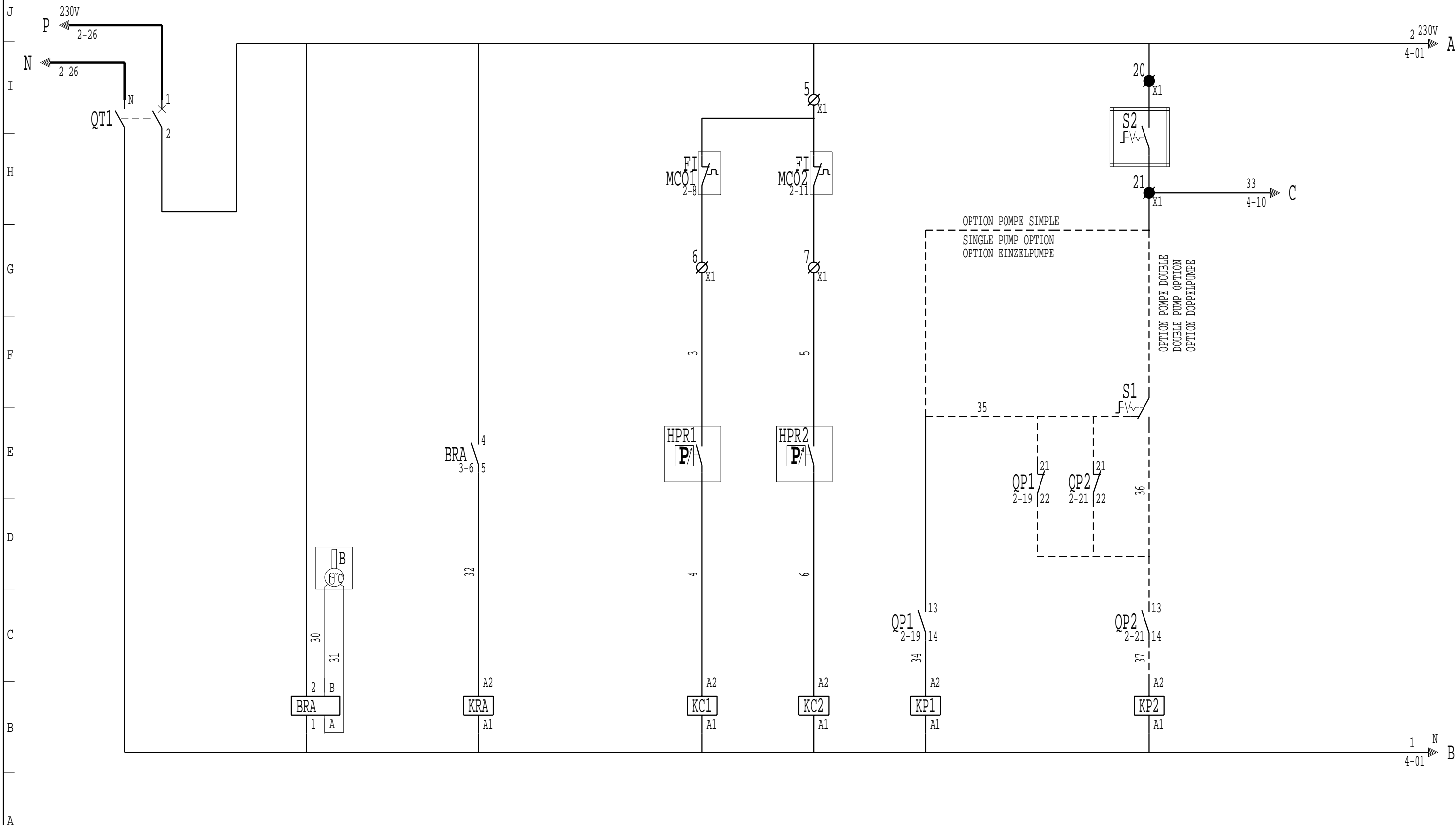

J
I
H
G
F
E
D
C
B
A

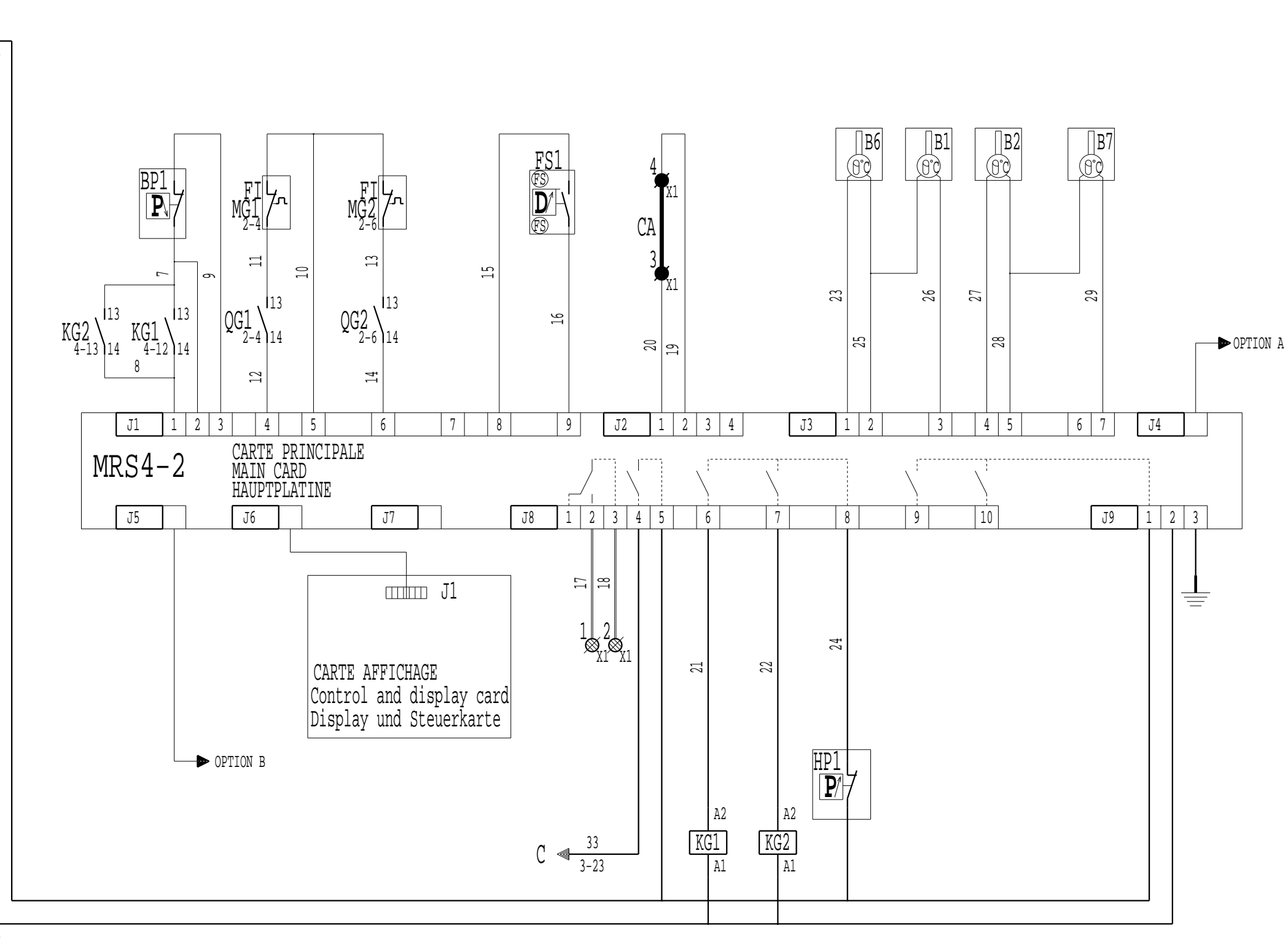

MRS4_2	
B1	Sonde entree eau glacee Inlet chilled water sensor Fühler Kaltwassereintritt
B2	Sonde sortie evapourateur N 1 Evaporator N 1 outlet sensor Austrittsfühler Verdampfer N 1
B3	Sonde temperature freon Refrigerant temperature sensor Fühler Kältemitteltemperatur
B5	Sonde eau chaude Hot water sensor Warmwasserfühler
B6	Sonde air exterieur External air sensor Aussenluftfühler
B7	Sonde de refoulement Discharge sensor Heissgasfühler

OPTION A MRS	
INTERFACE RX-TX (RS485-4 fils)	
INTERFACE RX-TX (RS485-4 WIRES)	
ANSCHLUSS INTERFACE RX-TX (RS485 - 4 ADERN)	

OPTION B MRS	
CAD-RELAYAGE-PC (RS485-2 fils)	
INTERFACE RX-TX (RS485-2 WIRES)	
ANSCHLUSS CAD-RELAIS-PC (RS485 - 2 ADERN)	

CARTE AFFICHAGE
Control and display card
Display und Steuerkarte

O	F	O	F
	2-4		2-6
	4-4		4-3

	HP - BP		
	PENN P77	RANCO 016	MINI
BP	3 2	4 2	4 2
AUTO	1	1	1
HP	3 2	2 4	2 4
MANU	1	1	1
HP	2 3	4 2	2 4
AUTO	1	1	1

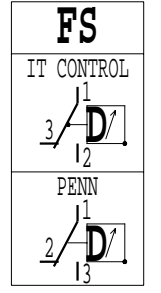

J
I
H
G
F
E
D
C
B
A

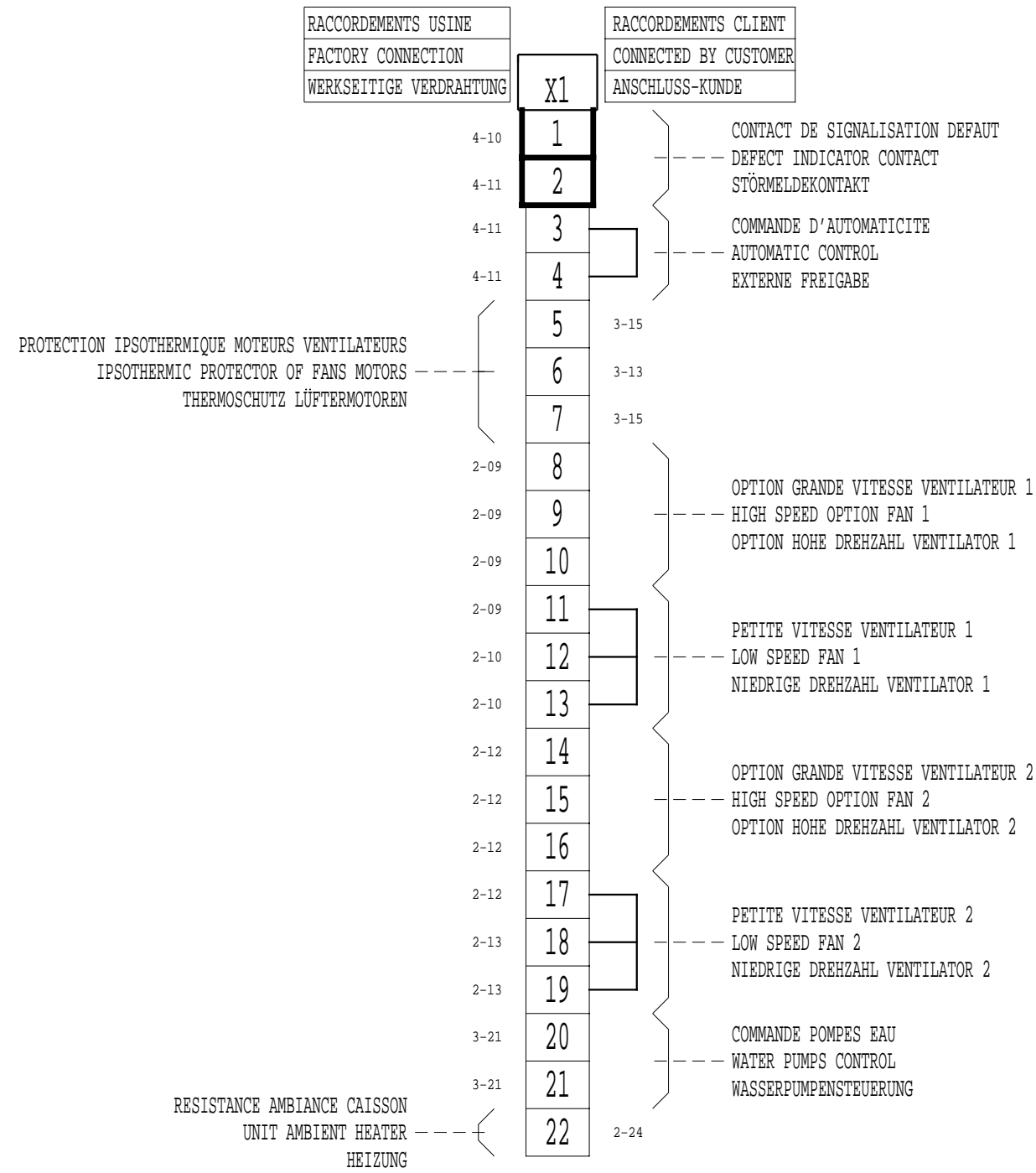

MRS4-2

DEFAUT GENERAL

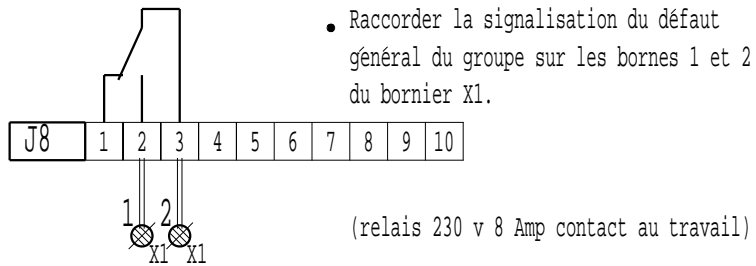

GENERAL FAULT

• The fault or not-fault information on the unit can be recover on terminals 1 and 2 connector X1.

(relay 230V 8 Amp.)

SAMMELSTÖRMELDUNG

• Die Störungsmeldung wird an den Klemmen 1 und 2 der Anschlusse X1 abgenommen.

(Relais 230V 8 Amp)

COMMANDE D'AUTOMATICITE

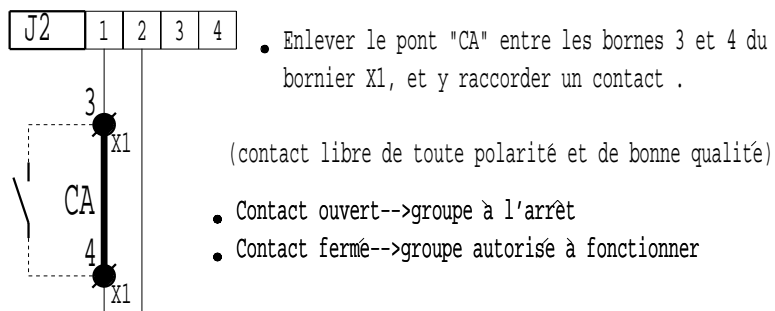

AUTOMATIC CONTROL

• The shunt "CA" on terminals 3 and 4 of connector X1, must be lifted and the contact connected.
(contact must be polarity free and of good quality)

- Contact open-->unit off-line
- Contact closed-->unit on-line

EXTERNE FREIGABE

• Die Brücke "CA" an den Klemmen 3 und 4 am Anschluss X1 entfernen und externen Kontakt anschliessen.
(Kontakt unbedingt potentialfrei anschliessen)

- Kontakt offen-->Gerät abgeschaltet
- Kontakt geschlossen-->Gerät Betriebsbereit

SELECTION CHAUD/FROID

- Configuration P17 valeur 3

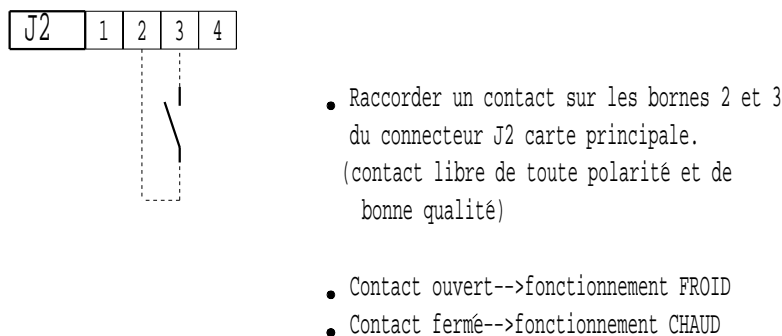

HEATING/COOLING SELECTION

- Configuration P17 value 3

• The controle device must be connected to terminals 2 and 3 on connector J2 of main card.
(contact must be polarity free and of good quality)

- Contact open-->COOLING operation
- Contact closed-->HEATING operation

AUSWAHL HEIZ-O.KÜHLBETRIEB

- Konfiguration P17 Wert 3

• Der Kontakt wird an den Klemmen 2 und 3 am Stecker J2 der Hauptplatine angeschlossen
(Kontakt unbedingt potentialfrei anschliessen)

- Kontakt offen-->Kühlbetrieb
- Kontakt geschlossen-->Heizbetrieb

MRS4-2

SELECTION CONSIGNE 1 ou 2

- Configuration P18 valeur 3

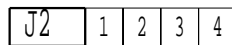

- Raccorder un contact entre les bornes 2 et 4 du connecteur J2 carte principale.
(contact libre de toute polarité et de bonne qualité)
- Contact ouvert-->CONSIGNE 1
- Contact fermé-->CONSIGNE 2

COMMANDE POMPE A EAU

- Raccorder l'alimentation de la pompe entre les bornes 4 et 5 du connecteur J8 de la carte principale.

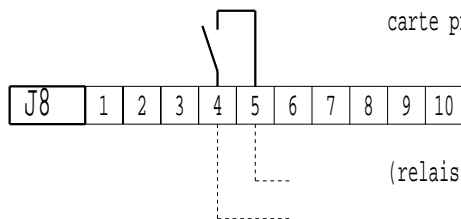

(relais 230V 8 Amp.)

COMMANDE DES ETAGES FORCES

- Configuration P16 valeur 2

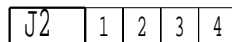

- Raccorder les contacts sur chaque entrée du connecteur J2 pour commander les différents étages
(contact libre de toute polarité et de bonne qualité)
- Suivant le nombre d'étages, il suffit de raccorder des contacts à fermeture.

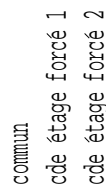

PRECAUTIONS DE RACCORDEMENT

POUR LES PRECAUTIONS A PRENDRE POUR LE RACCORDEMENT DES ENTREES
VOIR LE MANUEL D'UTILISATION MRS4-2 PARAGRAPHE :
"ASSERVISSEMENT ET COMMANDES EXTERNES"

SETTING 1 OR 2 SELECTION

- Configuration P18 value 3

- The controle must be connected to terminals 2 and 4 connector J2 main card.
(contact must be polarity free and of good quality)
- Contact open-->SETTING 1 operation
- Contact closed-->SETTING 2 operation

WATER POMP CONTROL

- The pump control must be connected to terminals 4 and 5 on connector J8 of main card.

(relay 230V 8 Amp.)

FORCED STAGES CONTROL

- Configuration P16 value 2

- The control of the various stages is made by an external control connected to the connector J2 of the main card.
(contact must be polarity free and of good quality)
- According to the number of stages, connection of NO (normally open) contacts is sufficient.

CAUTION

TO TAKE PRECAUTION FOR CLIENT'S CONNECTION OF INPUTS
SEE THE OPERATING AND MAINTENANCE INSTRUCTIONS OF
MICROCIAT MRS4-2 PARAGRAPH :
"SERVO CONTROL AND EXTERNAL CONTROLS"

AUSWAHL SOLLWERT 1 ODER 2

- Konfiguration P18 Wert 3

- Der Kontakt wird an den Klemmen 2 und 4 am Stecker J2 der Hauptplatine angeschlossen.
(Kontakt unbedingt potentialfrei anschliessen)
- Kontakt offen-->Sollwert 1
- Kontakt geschlossen-->Sollwert 2

PUMPENSTEUERUNG

- Der Kontakt wird an den Klemmen 4 und 5 am Stecker J8 der Hauptplatine angeschlossen.

(Relais 230V 8 Amp)

EXTERNERBETRIEB DER STUFEN

- Konfiguration P16 Wert 2

- Die Regelung der verschiedenen Stufen wird mit einem externen Kontakt am Stecker J2 der Hauptplatine hergestellt.
(Kontakt unbedingt potentialfrei anschliessen)
- Die Zuverdrahtende Kontaktanzahl ist von der Stufenanzahl abhängig.

ACHTUNG

Um Anschlussfehler zu vermeiden, unbedingt die Betriebs- und Wartungsanleitung MRS4-2 Abschnitt Regelung und externe Regelung beachten.

J
I
H
G
F
E
D
C

Pompes / Pumps / Pumpen

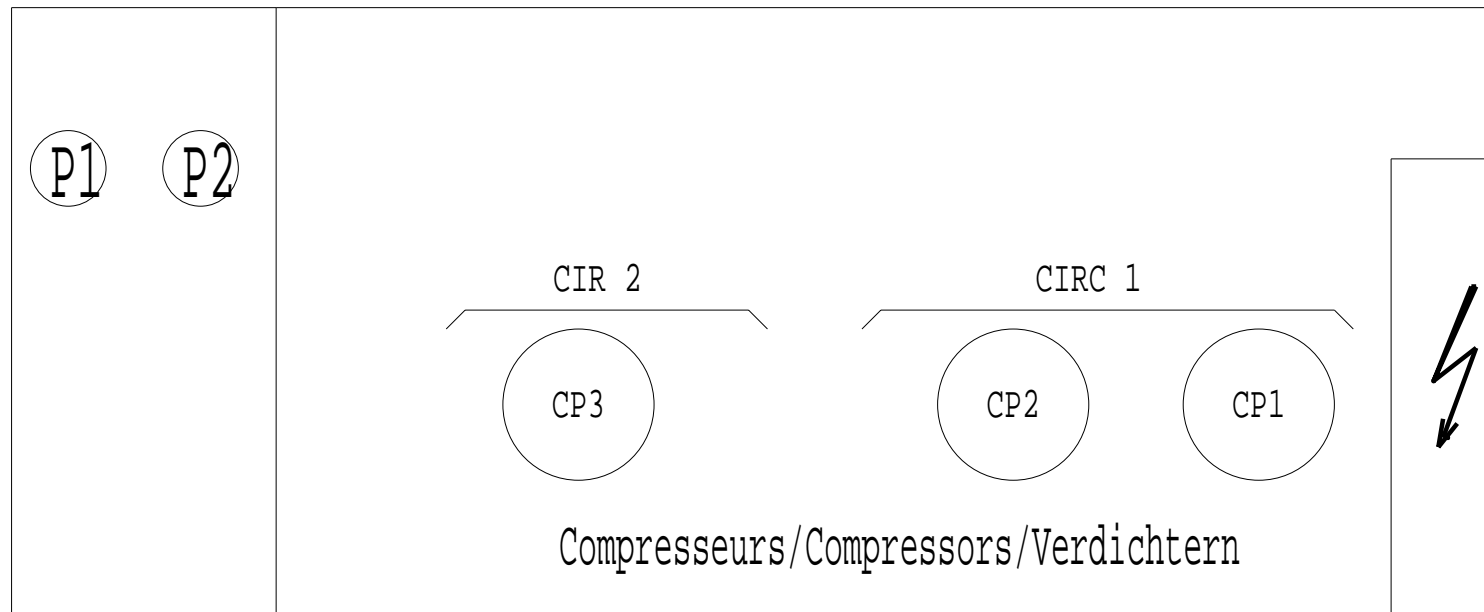

Compresseurs / Compressors / Verdichtern

Ventilateurs Condenseur
Fans Condensor
Verflüssiger Ventilatoren



MODIFIE PAR: MODIFIED BY: GEANDERT DURCH: PG		INDICE INDEX KENNZIFFER 34		DATE DATE DATUM 05-07-00					APPAREIL OU UNITE/UNIT/GERAT ODER EINHEIT LDH 350 A 450						
MODIFICATION A RAJOUTE 1 BORNE ET REVU NUMEROTATION FILS ET BORNES				LEGENDE/LEGEND/LEGENDE 3950010.36					SPECIFICATION/SPECIFICATION/SPEZIFIZIERUNG 3 COMPRESSEURS - 2 CIRCUITS 3 COMPRESSORS 2 CIRCUITS 3 VERDICHTERN 2 KREISLAUFE MRS1-4						
REMPLACE/TAKE/ERSETZT		REMPLACE PAR/TAKE BY/ERSETZT DURCH		CLIENT/CLIENT/KUNDE			REFERENCE/REFERENCE/REFERENZ			CREATEUR: CREATOR: HERSTELLER: JP		DATE: DATE: DATUM: 13-04-99			
REFERENCES COMMANDE/ORDER REFERENCES/AUFTRAGSREFERENZ				DEMARRAGE/START/ANLAUF		TENSION/VOLTAGE/SPANNUNG		COMPAGNIE INDUSTRIELLE D'APPLICATIONS THERMIQUES CIAT		FOLIO/FOLIO/SEITE 1 / 7		NUMERO DE SCHEMA/DRAWING NUMBER/PLAN NR 3980896		INDICE/INDEX/KENNZIFFER 34	

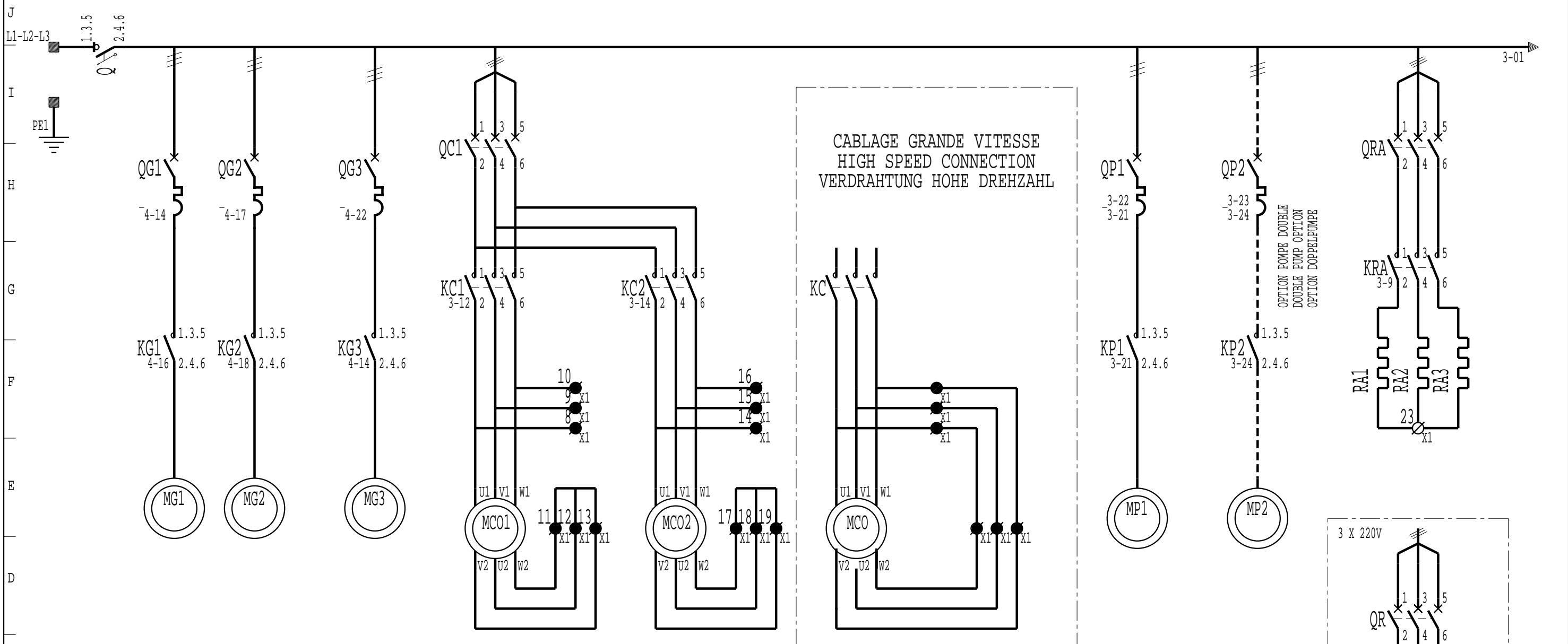

Puissance en CV
des compresseurs
Compressors nominal
output HP
Verdichterleistung in PS

LDH	CP1	CP2	CP3
350	10	10	15
400	15	15	10
450	15	15	15

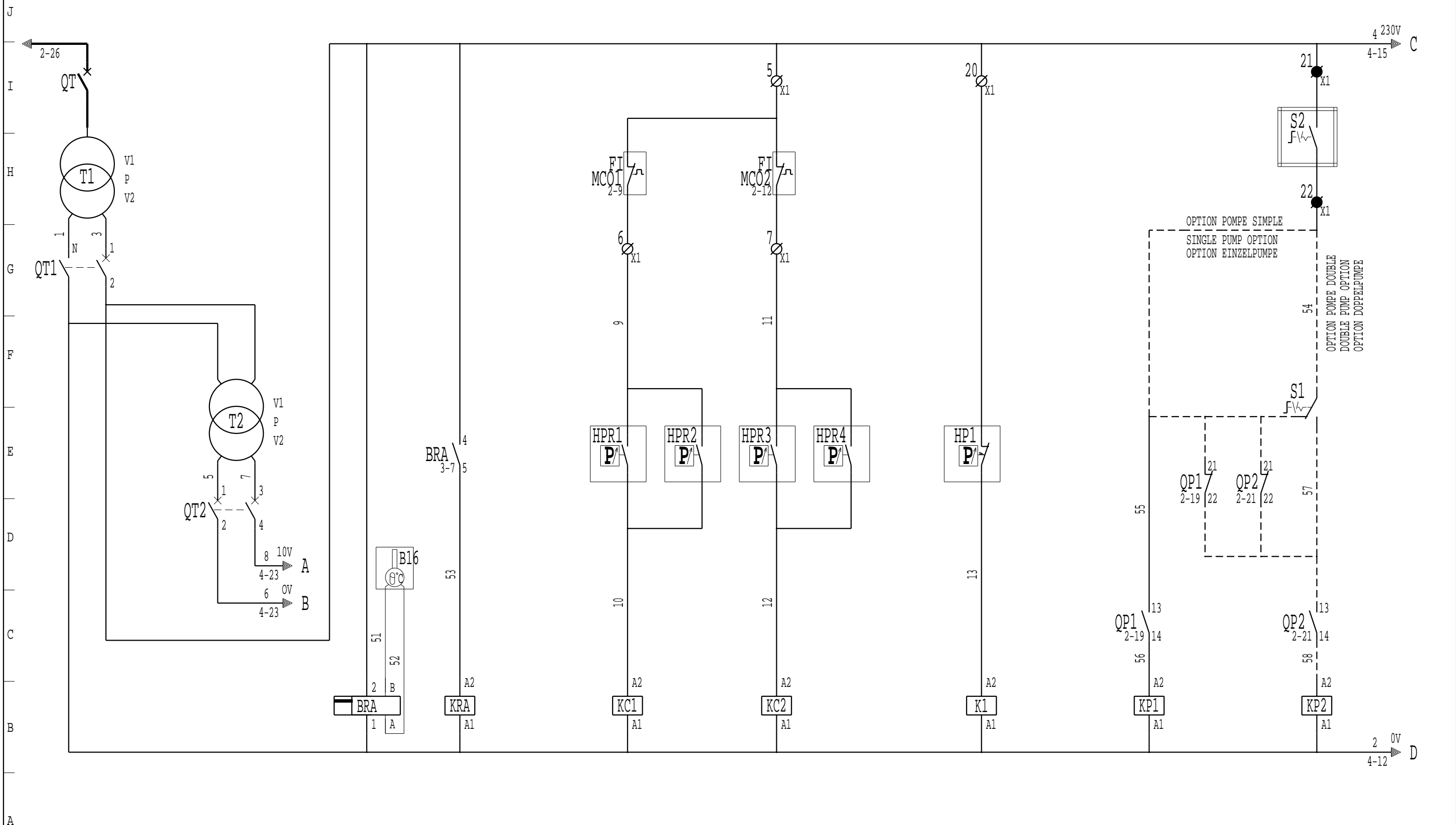

0	I	F	0	F	0	F	0	F	Fermeture	0	F	0	F
		3-9		2-24		2-9		2-12	4-10		2-19		2-21
									4-16				
									4-18				

J
I
H
G
F
E
D
C
B
A

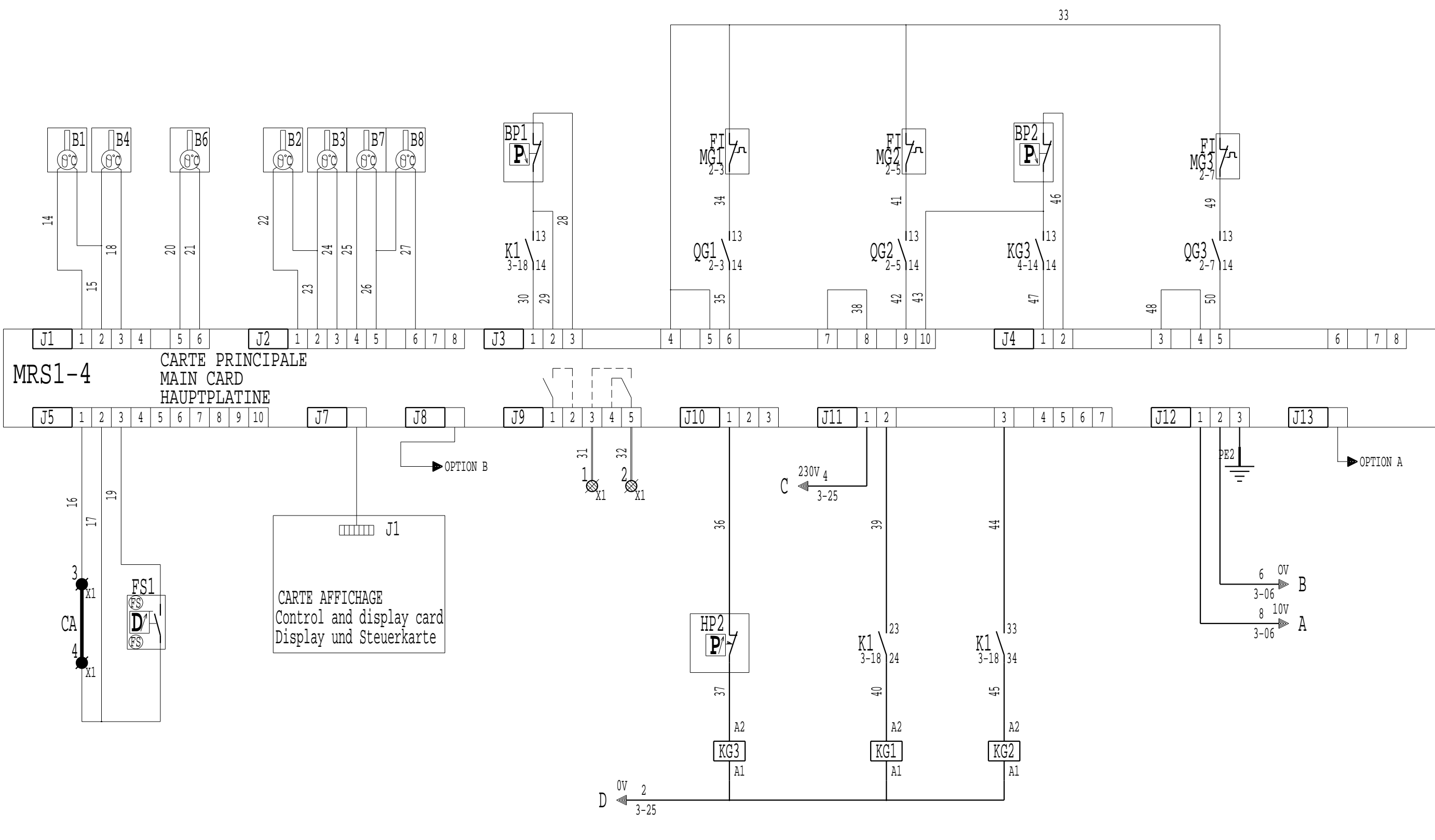

MRS1-4
CARTE PRINCIPALE
MAIN CARD
HAUPTPLATINE

CARTE AFFICHAGE
Control and display card
Display und Steuerkarte

O	F	O	F	O	F
	2-7		2-3		2-5
	4-19				

J
I
H
G
F
E
D
C
B
A

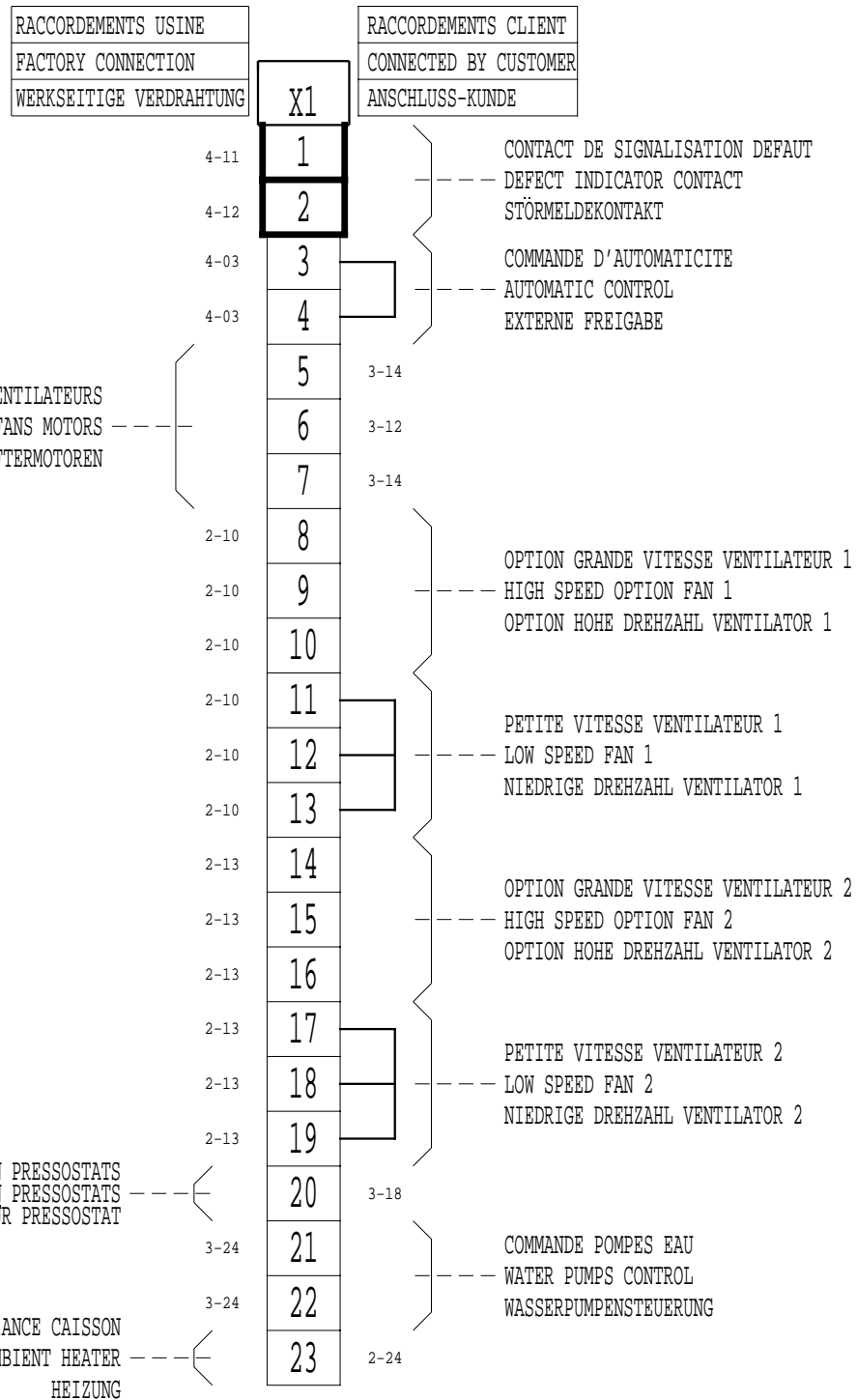

MRS1-4 / H	
B1	Sonde entree eau glatee Inlet chilled water sensor Fühler Kaltwassereintritt
B2	Sonde sortie evaporateur N 1 Evaporator N 1 outlet sensor Austrittsfühler Verdampfer N 1
B3	Sonde sortie evaporateur N 2 Evaporator N 2 outlet sensor Austrittsfühler Verdampfer N 2
B4	Sonde sortie eau glatee (collecteur) Collector chilled water outlet sensor Fühler Kaltwasseraustritt (Sammler)
B5	Sonde eau chaude Hot water sensor Warmwasserfühler
B6	Sonde air exterieur External air sensor Aussenluftfühler
B7	Sonde refoulement circuit 1 Circuit N 1 discharge sensor Heissgasfühler Kreislauf 1
B8	Sonde refoulement circuit 2 Circuit N 2 discharge sensor Heissgasfühler Kreislauf 2
B16	Sonde ballon tampon Buffer tank sensor Fühler Pufferspeicher

OPTION A MRS
INTERFACE RX-TX (RS485-4 fils)
INTERFACE RX-TX (RS485-4 WIRES)
ANSCHLUSS INTERFACE RX-TX (RS485 - 4 ADERN)

OPTION B MRS
CAD-RELAYAGE-PC (RS485-2 fils)
INTERFACE RX-TX (RS485-2 WIRES)
ANSCHLUSS CAD-RELAIS-PC (RS485 - 2 ADERN)

FS IT CONTROL PENN	HP - BP					
	PENN P77		RANCO 016		MINI	
BP	3	2	4	2	4	2
AUTO	1		1			1
HP	3	2	2	4	2	4
MANU	1		1			1
HP	2	3	4	2	2	4
AUTO	1		1			1

MRS1-4

DEFAUT GENERAL

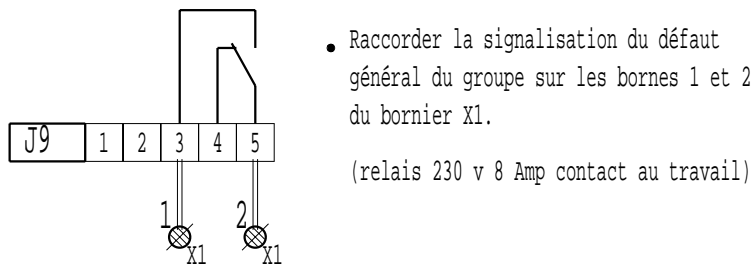

- Raccorder la signalisation du défaut général du groupe sur les bornes 1 et 2 du bornier X1.
- (relais 230 v 8 Amp contact au travail)

COMMANDE D'AUTOMATICITE

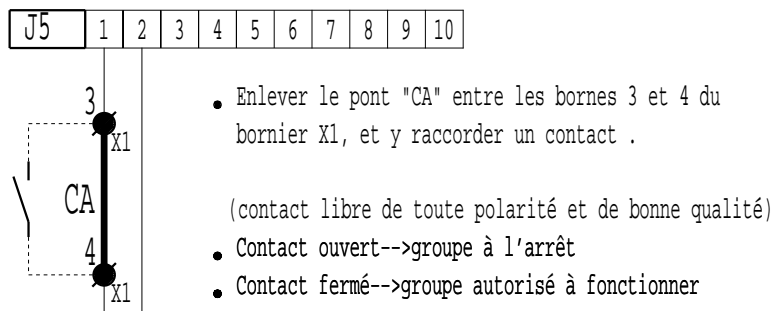

- Enlever le pont "CA" entre les bornes 3 et 4 du bornier X1, et y raccorder un contact .
- (contact libre de toute polarité et de bonne qualité)
- Contact ouvert-->groupe à l'arrêt
 - Contact fermé-->groupe autorisé à fonctionner

FONCTIONNEMENT EN PUISSANCE MAXI

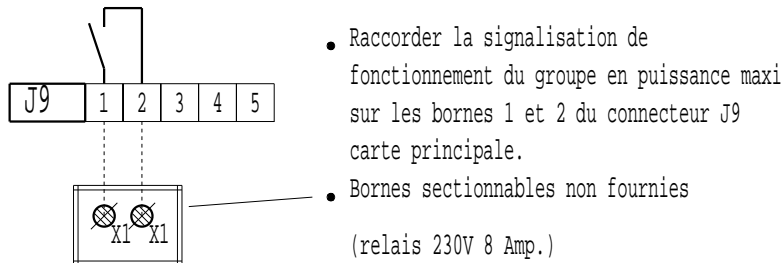

- Raccorder la signalisation de fonctionnement du groupe en puissance maxi sur les bornes 1 et 2 du connecteur J9 carte principale.
 - Bornes sectionnables non fournies
- (relais 230V 8 Amp.)

SELECTION CHAUD/FROID

- Configuration P17 valeur 3

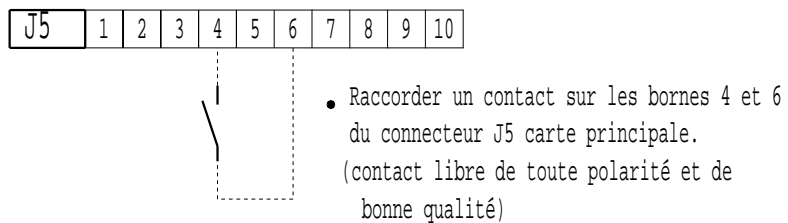

- Raccorder un contact sur les bornes 4 et 6 du connecteur J5 carte principale.
- (contact libre de toute polarité et de bonne qualité)
- Contact ouvert-->fonctionnement FROID
 - Contact fermé-->fonctionnement CHAUD

GENERAL FAULT

- The fault or not-fault information on the unit can be recover on terminals 1 and 2 connector X1.
- (relay 230V 8 Amp.)

AUTOMATIC CONTROL

- The shunt "CA" on terminals 3 and 4 of connector X1, must be lifted and the contact connected.
- (contact must be polarity free and of good quality)
- Contact open-->unit off-line
 - Contact closed-->unit on-line

MAXIMUM OUTPUT OPERATION

- The controle device must be connected to terminals 1 and 2 on connector J9 of main card.
 - Isolating terminals not supplied
- (relay 230V 8 Amp.)

HEATING/COOLING SELECTION

- Configuration P17 value 3

- The controle device must be connected to terminals 4 and 6 on connector J5 of main card.
- (contact must be polarity free and of good quality)
- Contact open-->COOLING operation
 - Contact closed-->HEATING operation

SAMMELSTÖRMELDUNG

- Die Störungsmeldung wird an den Klemmen 1 und 2 der Anschlüsse X1 abgenommen.
- (Relais 230V 8 Amp)

EXTERNE FREIGABE

- Die Brücke "CA" an den Klemmen 3 und 4 am Anschluss X1 entfernen und externen Kontakt anschliessen.
- (Kontakt unbedingt potentialfrei anschliessen)
- Kontakt offen-->Gerät abgeschaltet
 - Kontakt geschlossen-->Gerät Betriebsbereit

MAXIMALE LEISTUNG

- Der Kontakt wird an den Klemmen 1 und 2 am Stecker J9 der Hauptplatine angeschlossen.
 - Anschlussklemmen nicht mitgeliefert
- (Relais 230V 8 Amp)

AUSWAHL HEIZ-O.KÜHLBETRIEB

- Konfiguration P17 Wert 3

- Der Kontakt wird an den Klemmen 4 und 6 am Stecker J5 der Hauptplatine angeschlossen.
- (Kontakt unbedingt potentialfrei anschliessen)
- Kontakt offen-->Kühlbetrieb
 - Kontakt geschlossen-->Heizbetrieb

MRS1-4

SELECTION CONSIGNE 1 ou 2

- Configuration P18 valeur 3

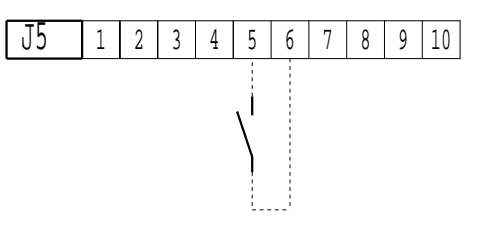

- Raccorder un contact entre les bornes 5 et 6 du connecteur J5 carte principale.
(contact libre de toute polarité et de bonne qualité)
- Contact ouvert-->CONSIGNE 1
- Contact fermé-->CONSIGNE 2

FONCTION DE DELESTAGE

- Configuration P16 valeurs 0 ou 1

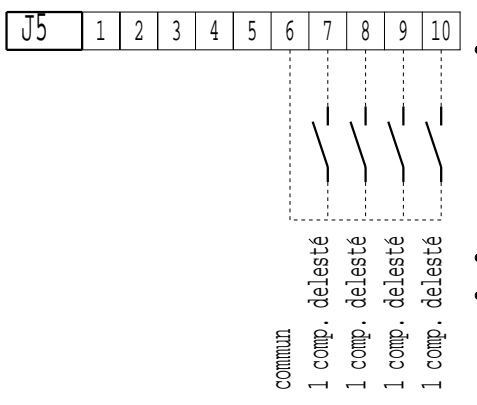

- Raccorder les contacts sur chaque entrée pour délester les différents compresseurs.
(contact libre de toute polarité et de bonne qualité)
- Contact ouvert-->fonctionnement normal
- Contact fermé-->fonctionnement avec délestage

COMMANDE DES ETAGES FORCES

- Configuration P16 valeurs 2 ou 3

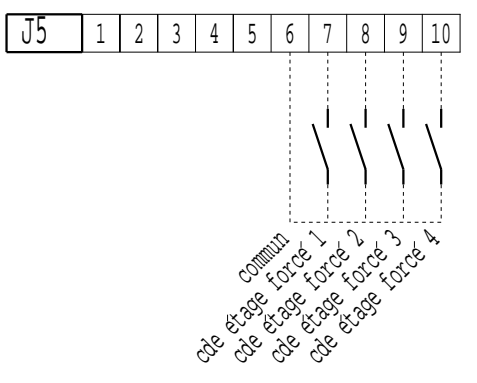

- Raccorder les contacts sur chaque entrée pour commander les différents étages
(contact libre de toute polarité et de bonne qualité)
- Suivant le nombre d'étages, il suffit de raccorder des contacts à fermeture.

PRECAUTIONS DE RACCORDEMENT

POUR LES PRECAUTIONS A PRENDRE POUR LE RACCORDEMENT DES ENTREES
VOIR LE MANUEL D'UTILISATION MRS1-4 PARAGRAPHE :
"ASSERVISSEMENT ET COMMANDES EXTERNES"

SETTING 1 OR 2 SELECTION

- Configuration P18 value 3

- The control must be connected to terminals 5 and 6 connector J5 on the main card.
(contact must be polarity free and of good quality)
- Contact open-->SETTING 1 operation
- Contact closed-->SETTING 2 operation

LOAD SHEDDING

- Configuration P16 values 0 or 1

- When a certain number of compressors must be shedded, connect an external control on connector J5 on the main card.
(contact must be polarity free and of good quality)
- Contact open-->normal running
- Contact closed-->shedding

FORCED STAGES CONTROL

- Configuration P16 values 2 or 3

- The control of the various stages is made by an external control connected to the connector J5 of the main card.
(contact must be polarity free and of good quality)
- According to the number of stages, connection of NO (normally open) contacts is sufficient.

CAUTION

TO TAKE PRECAUTION FOR CLIENT'S CONNECTION OF INPUTS
SEE THE OPERATING AND MAINTENANCE INSTRUCTIONS OF
MICROCIAT MRS1-4 PARAGRAPH :
"SERVO CONTROL AND EXTERNAL CONTROLS"

AUSWAHL SOLLWERT 1 ODER 2

- Konfiguration P18 Wert 3

- Der Kontakt wird an den Klemmen 5 und 6 am Stecker J5 der Hauptplatine angeschlossen.
(Kontakt unbedingt potentialfrei anschliessen)
- Kontakt offen-->Sollwert 1
- Kontakt geschlossen-->Sollwert 2

EXTERNE STUFENABSCHALTUNG

- Konfiguration P16 Werte 0 oder 1

- Die Kontakte werden an den Klemmen 6 bis 10 am Stecker J5 der Hauptplatine angeschlossen
(Kontakt unbedingt potentialfrei anschliessen)
- Kontakt offen-->Normalbetrieb
- Kontakt geschlossen-->Entlastungsbetrieb

EXTERNERBETRIEB DER STUFEN

- Konfiguration P16 Werte 2 oder 3

- Die Kontakte werden an den Klemmen 6 bis 10 am Stecker J5 der Hauptplatine angeschlossen
(Kontakt unbedingt potentialfrei anschliessen)
- Die Zuverdrahtende Kontaktanzahl ist von der Stufenanzahl abhängig.

ACHTUNG

Um Anschlussfehler zu vermeiden, unbedingt die Betriebs-und Wartungsanleitung MRS 1-4 Abschnitt Regelung und externe Regelung beachten.

J
I
H
G
F
E
D
C

Pompes / Pumps / Pumpen

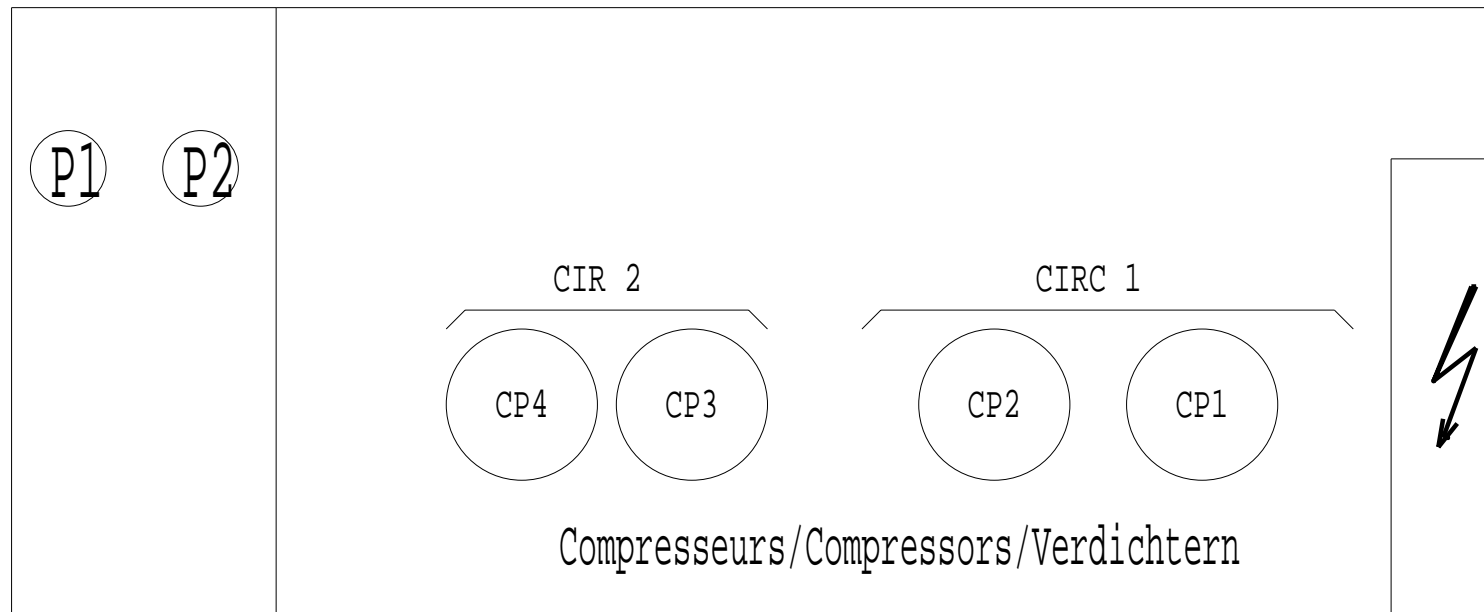

Ventilateurs Condenseur
Fans Condensor
Verflüssiger Ventilatoren

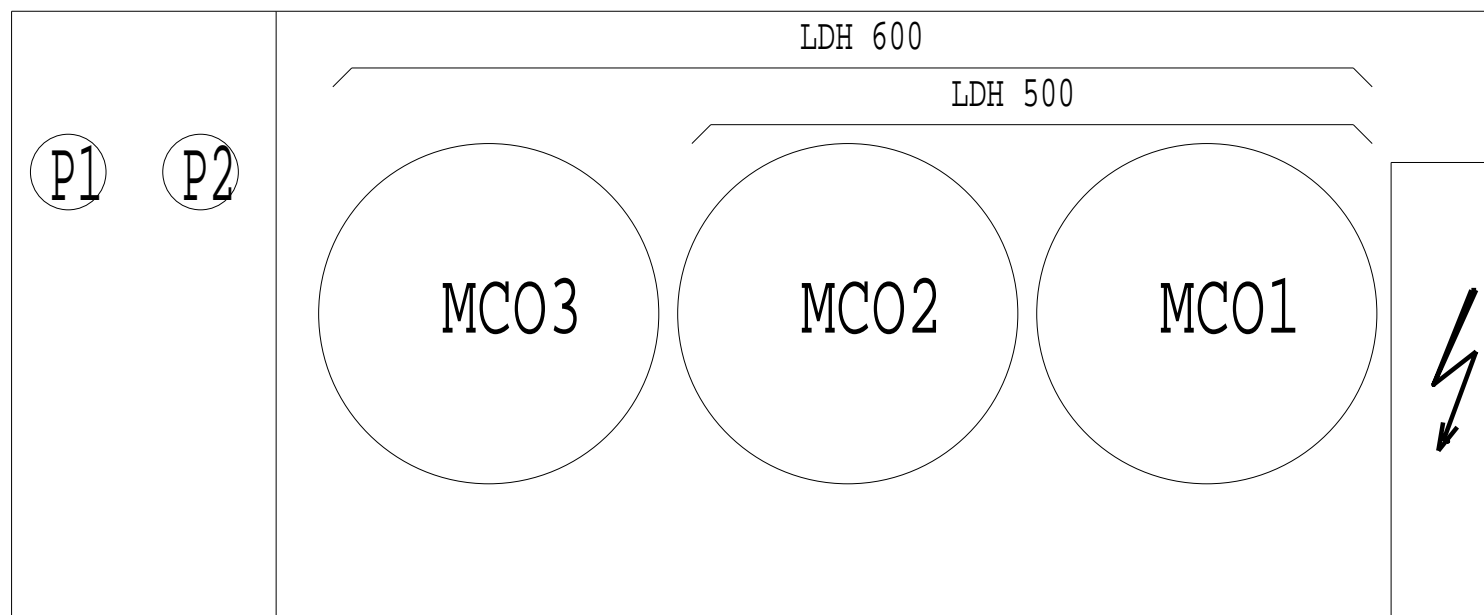

MODIFIE PAR: MODIFIED BY: GEANDERT DURCH:		INDICE INDEX KENNZIFFER		DATE DATE DATUM		APPAREIL OU UNITE/UNIT/GERAT ODER EINHEIT	
PG		33		06-07-00		LDH 500-600	
MODIFICATION A RAJOUTE 1 BORNE ET RENUMEROTE FILS ET BORNES				LEGENDE/LEGEND/LEGENDE 3950010.36		SPECIFICATION/SPECIFICATION/SPEZIFIZIERUNG 4 COMPRESSEURS 2 CIRCUITS 4 COMPRESSORS 2 CIRCUITS 4 VERDICHTERN 2 KREISLAUFE MRS1-4	
REPLACE/TAKE/ERSETZT		REPLACE PAR/TAKE BY/ERSETZT DURCH		CLIENT/CLIENT/KUNDE		REFERENCE/REFERENCE/REFERENZ	
						CREATEUR: CREATOR: HERSTELLER:	
						DATE: DATE: DATUM:	
						JP 14-04-99	
REFERENCES COMMANDE/ORDER REFERENCES/AUFTRAGSREFERENZ				DEMARRAGE/START/ANLAUF		TENSION/VOLTAGE/SPANNUNG	
						COMPAGNIE INDUSTRIELLE D'APPLICATIONS THERMIQUES	
							
						FOLIO/FOLIO/SEITE 1 / 7	
						NUMERO DE SCHEMA/DRAWING NUMBER/PLAN NR 3980899	
						INDICE/INDEX/KENNZIFFER 33	

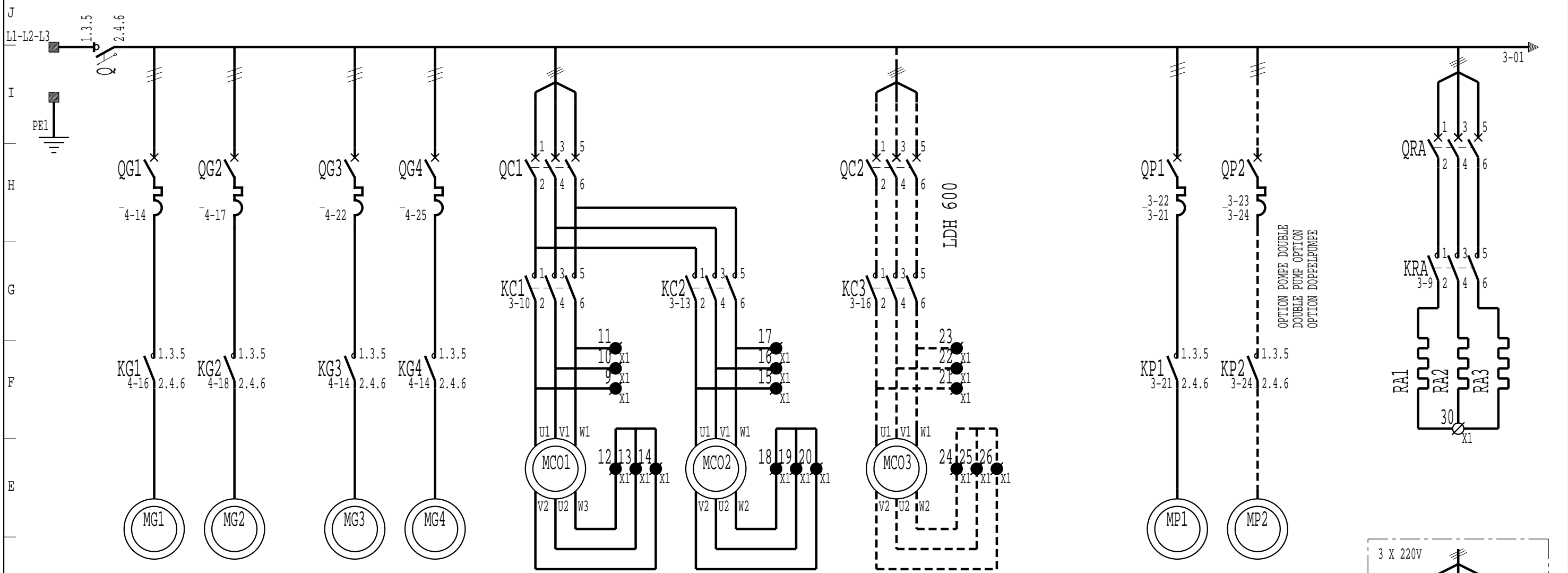

Puissance en CV
des compresseurs
Compressors nominal
output HP
Verdichterleistung in PS

LDH	CP1	CP2	CP3	CP4
500	15	15	10	10
600	15	15	15	15

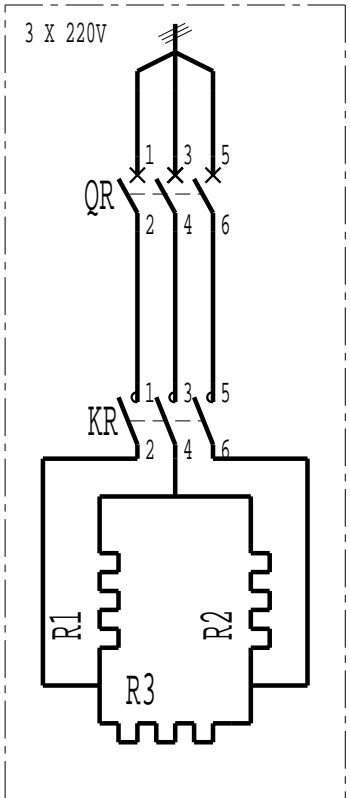
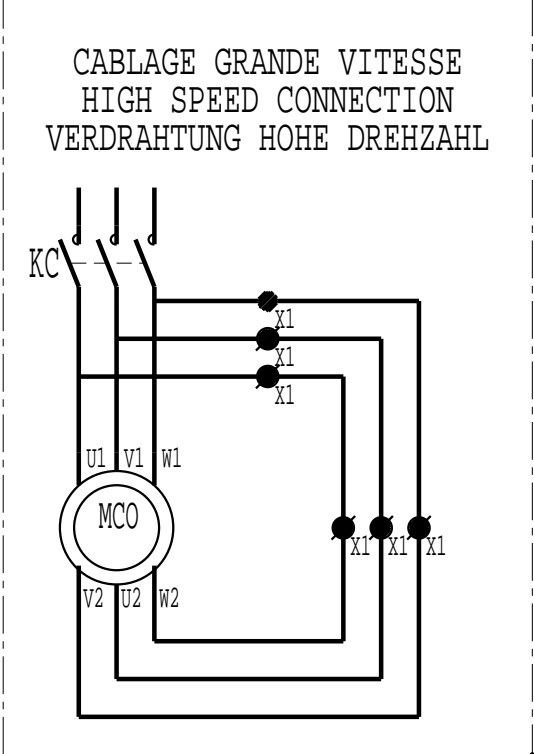

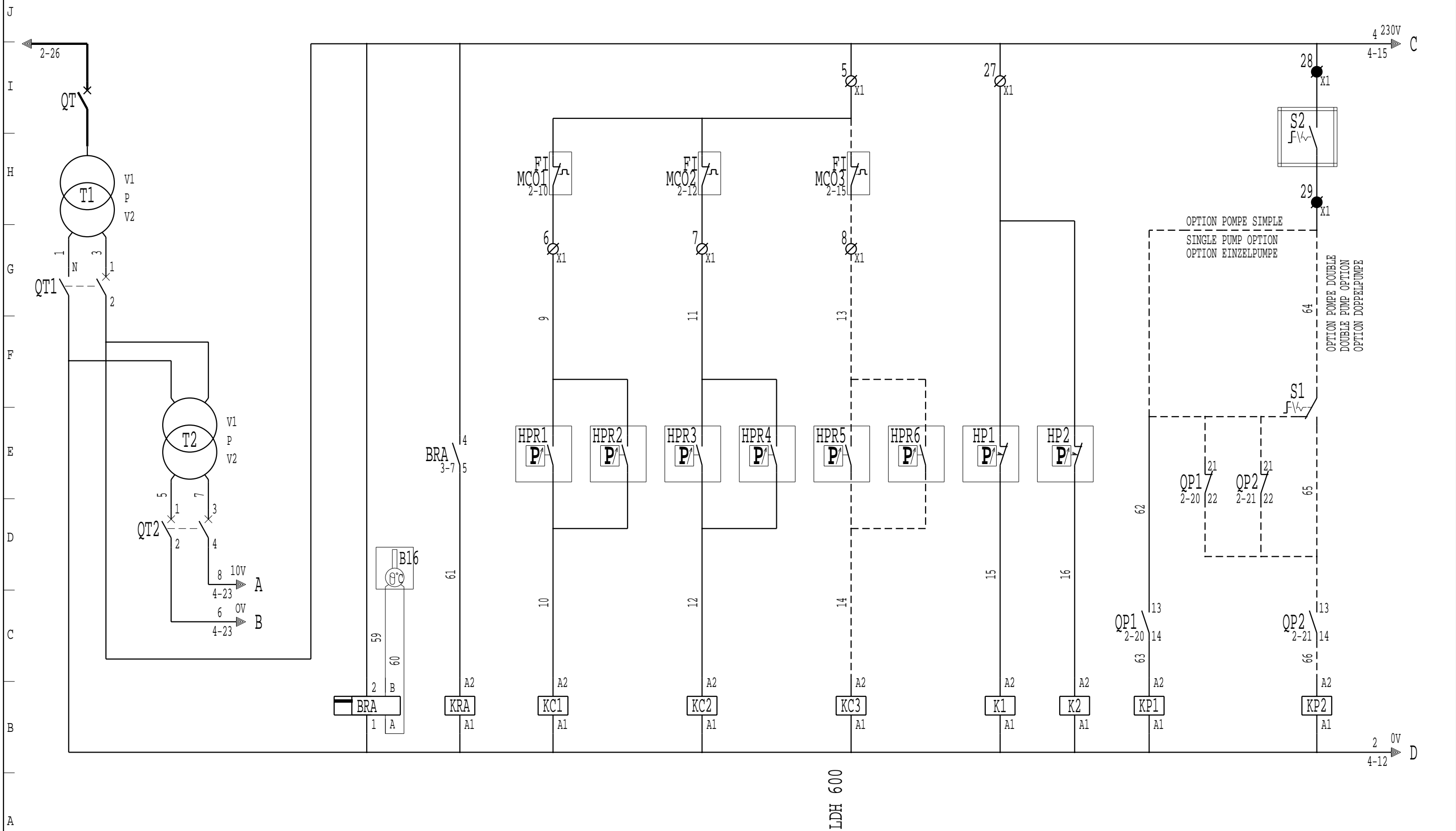

LDH 600

0	I	F	0	F	0	F	0	F	0	F	Fermeture	Fermeture	0	F	0	F
		3-9		2-25		2-10		2-12		2-15	4-10	4-14		2-20		2-21
											4-16	4-14				
											4-18	4-19				

J
I
H
G
F
E
D
C
B
A

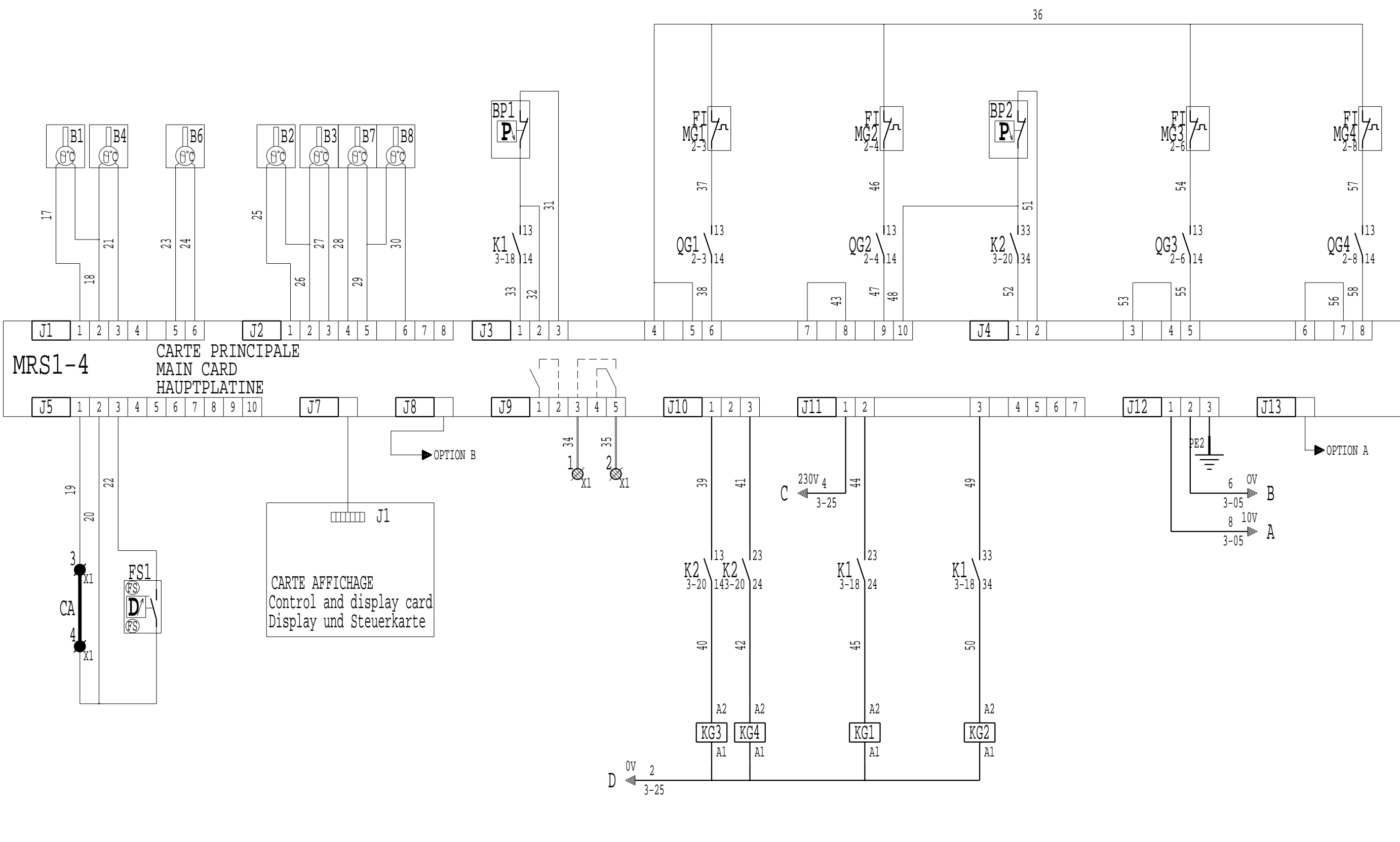

O	FO	F	O	F	O	F
	2-6	2-8		2-3		2-4

J
I
H
G
F
E
D
C
B
A

RACCORDEMENTS USINE FACTORY CONNECTION WERKSEITIGE VERDRÄHTUNG	X1	RACCORDEMENTS CLIENT CONNECTED BY CUSTOMER ANSCHLUSS-KUNDE
--	----	--

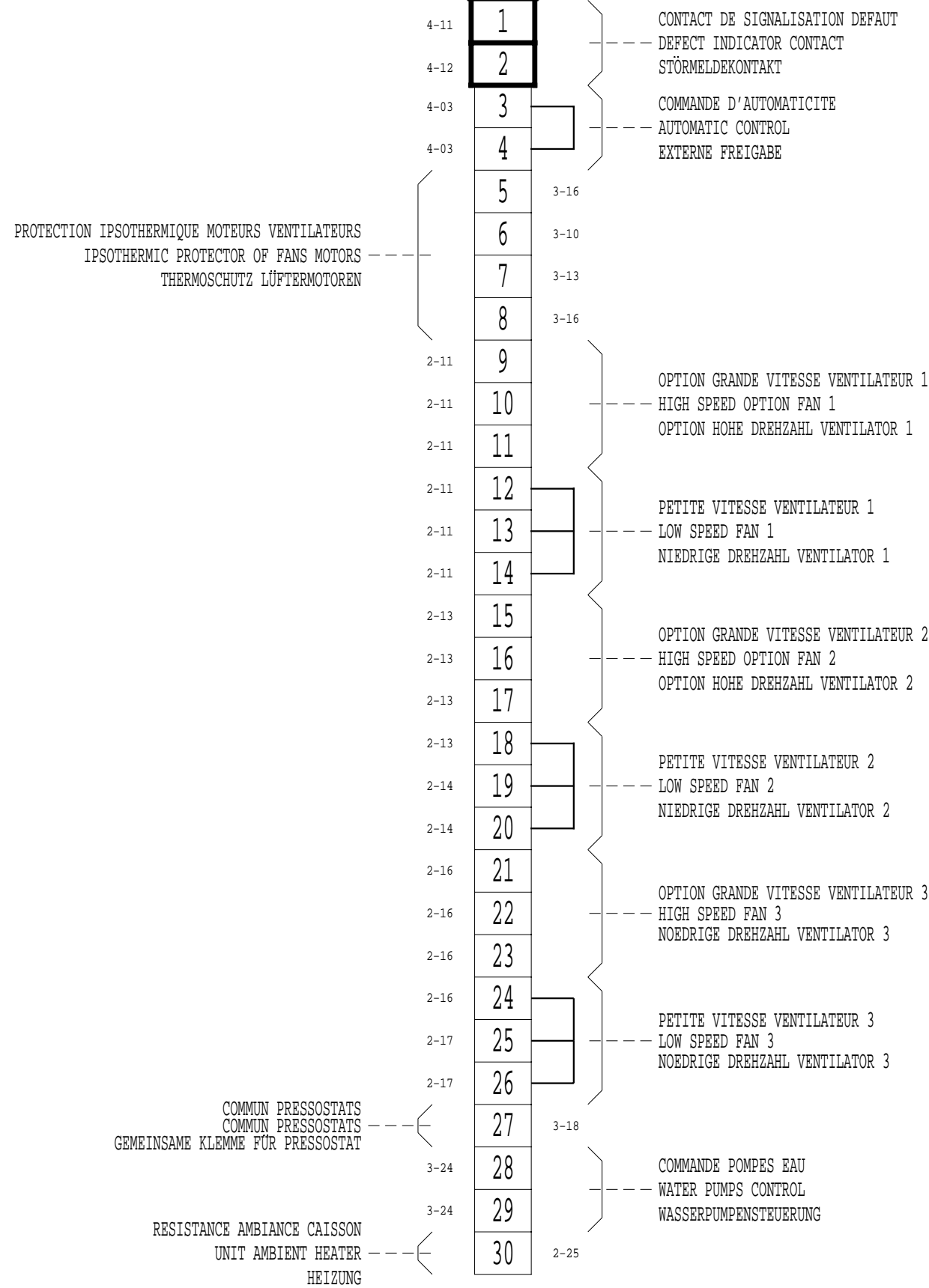

MRS1-4 / H	
B1	Sonde entree eau glatee Inlet chilled water sensor Fühler Kaltwassereintritt
B2	Sonde sortie evapourateur N 1 Evaporator N 1 outlet sensor Austrittsfühler Verdampfer N 1
B3	Sonde sortie evapourateur N 2 Evaporator N 2 outlet sensor Austrittsfühler Verdampfer N 2
B4	Sonde sortie eau glatee (collecteur) Collector chilled water outlet sensor Fühler Kaltwasseraustritt (Sammler)
B5	Sonde eau chaude Hot water sensor Warmwasserfühler
B6	Sonde air exterieur External air sensor Aussenluftfühler
B7	Sonde refoulement circuit 1 Circuit N 1 discharge sensor Heissgasfühler Kreislauf 1
B8	Sonde refoulement circuit 2 Circuit N 2 discharge sensor Heissgasfühler Kreislauf 2
B16	Sonde ballon tampon Buffer tank sensor Fühler Pufferspeicher

OPTION A MRS
INTERFACE RX-TX (RS485-4 fils)
INTERFACE RX-TX (RS485-4 WIRES)
ANSCHLUSS INTERFACE RX-TX (RS485 - 4 ADERN)

OPTION B MRS
CAD-RELAYAGE-PC (RS485-2 fils)
INTERFACE RX-TX (RS485-2 WIRES)
ANSCHLUSS CAD-RELAIS-PC (RS485 - 2 ADERN)

FS IT CONTROL	HP - BP					
	PENN P77		RANCO 016		MINI	
BP	3	2	4	2	4	2
AUTO	1		1			1
HP	3	2	2	4	2	4
MANU	1		1			1
HP	2	3	4	2	2	4
AUTO	1		1			1

MRS1-4

DEFAUT GENERAL

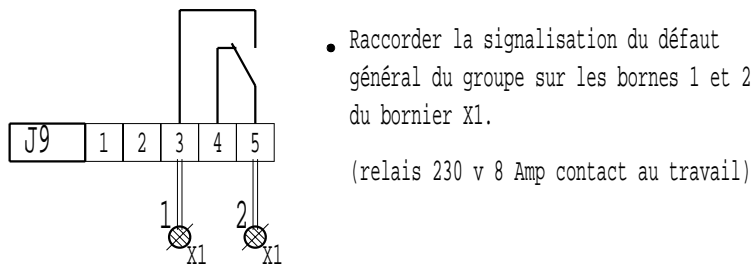

COMMANDE D'AUTOMATICITE

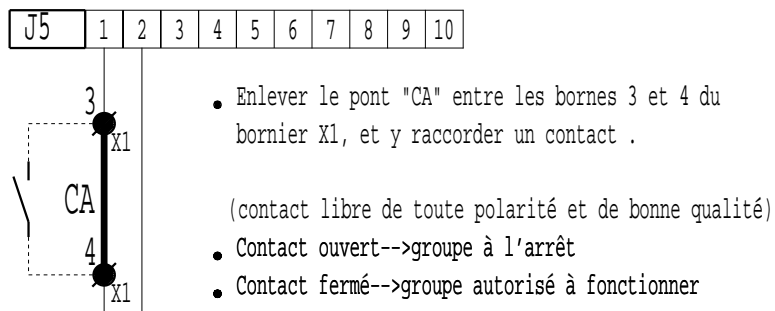

FONCTIONNEMENT EN PUISSANCE MAXI

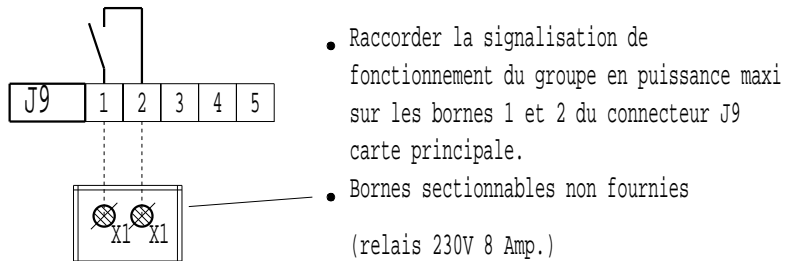

SELECTION CHAUD/FROID

- Configuration P17 valeur 3

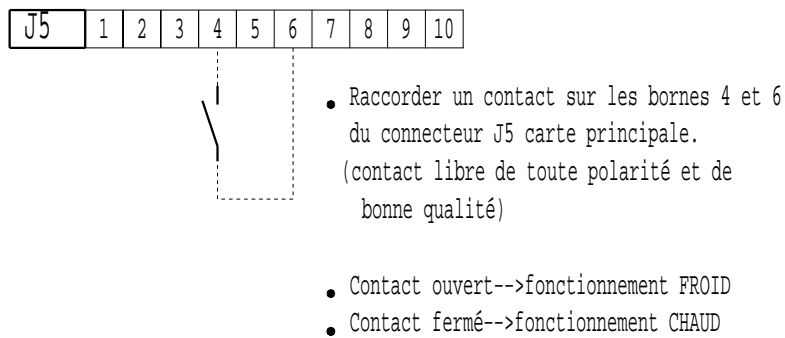

GENERAL FAULT

- The fault or not-fault information on the unit can be recover on terminals 1 and 2 connector X1.
(relay 230V 8 Amp.)

AUTOMATIC CONTROL

- The shunt "CA" on terminals 3 and 4 of connector X1, must be lifted and the contact connected.
(contact must be polarity free and of good quality)
- Contact open-->unit off-line
- Contact closed-->unit on-line

MAXIMUM OUTPUT OPERATION

- The controle device must be connected to terminals 1 and 2 on connector J9 of main card.
(relay 230V 8 Amp.)
- Isolating terminals not supplied

HEATING/COOLING SELECTION

- Configuration P17 value 3

- The controle device must be connected to terminals 4 and 6 on connector J5 of main card.
(contact must be polarity free and of good quality)
- Contact open-->COOLING operation
- Contact closed-->HEATING operation

SAMMELSTÖRMELDUNG

- Die Störungsmeldung wird an den Klemmen 1 und 2 der Anschlüsse X1 abgenommen.
(Relais 230V 8 Amp)

EXTERNE FREIGABE

- Die Brücke "CA" an den Klemmen 3 und 4 am Anschluss X1 entfernen und externen Kontakt anschliessen.
(Kontakt unbedingt potentialfrei anschliessen)
- Kontakt offen-->Gerät abgeschaltet
- Kontakt geschlossen-->Gerät Betriebsbereit

MAXIMALE LEISTUNG

- Der Kontakt wird an den Klemmen 1 und 2 am Stecker J9 der Hauptplatine angeschlossen.
(Relais 230V 8 Amp)
- Anschlussklemmen nicht mitgeliefert

AUSWAHL HEIZ-O.KÜHLBETRIEB

- Konfiguration P17 Wert 3

- Der Kontakt wird an den Klemmen 4 und 6 am Stecker J5 der Hauptplatine angeschlossen.
(Kontakt unbedingt potentialfrei anschliessen)
- Kontakt offen-->Kühlbetrieb
- Kontakt geschlossen-->Heizbetrieb

MRS1-4

SELECTION CONSIGNE 1 ou 2

- Configuration P18 valeur 3

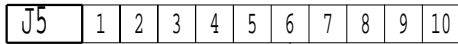

- Raccorder un contact entre les bornes 5 et 6 du connecteur J5 carte principale.
(contact libre de toute polarité et de bonne qualité)
- Contact ouvert-->CONSIGNE 1
- Contact fermé-->CONSIGNE 2

FONCTION DE DELESTAGE

- Configuration P16 valeurs 0 ou 1

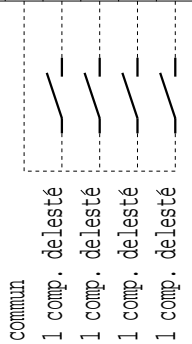
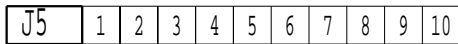

- Raccorder les contacts sur chaque entrée pour délester les différents compresseurs.
(contact libre de toute polarité et de bonne qualité)
- Contact ouvert-->fonctionnement normal
- Contact fermé-->fonctionnement avec délestage

COMMANDE DES ETAGES FORCES

- Configuration P16 valeurs 2 ou 3

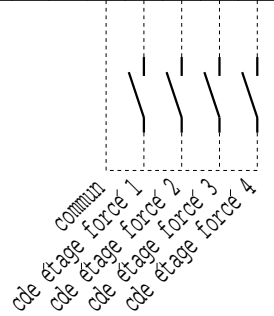
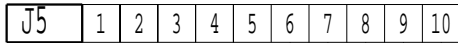

- Raccorder les contacts sur chaque entrée pour commander les différents étages
(contact libre de toute polarité et de bonne qualité)
- Suivant le nombre d'étages, il suffit de raccorder des contacts à fermeture.

PRECAUTIONS DE RACCORDEMENT

POUR LES PRECAUTIONS A PRENDRE POUR LE RACCORDEMENT DES ENTREES
VOIR LE MANUEL D'UTILISATION MRS1-4 PARAGRAPHE :
"ASSERVISSEMENT ET COMMANDES EXTERNES"

SETTING 1 OR 2 SELECTION

- Configuration P18 value 3

- The control must be connected to terminals 5 and 6 connector J5 on the main card.
(contact must be polarity free and of good quality)
- Contact open-->SETTING 1 operation
- Contact closed-->SETTING 2 operation

LOAD SHEDDING

- Configuration P16 values 0 or 1

- When a certain number of compressors must be shedded, connect an external control on connector J5 on the main card.
(contact must be polarity free and of good quality)
- Contact open-->normal running
- Contact closed-->shedding

FORCED STAGES CONTROL

- Configuration P16 values 2 or 3

- The control of the various stages is made by an external control connected to the connector J5 of the main card.
(contact must be polarity free and of good quality)
- According to the number of stages, connection of NO (normally open) contacts is sufficient.

CAUTION

TO TAKE PRECAUTION FOR CLIENT'S CONNECTION OF INPUTS
SEE THE OPERATING AND MAINTENANCE INSTRUCTIONS OF
MICROCIAT MRS1-4 PARAGRAPH :
"SERVO CONTROL AND EXTERNAL CONTROLS"

AUSWAHL SOLLWERT 1 ODER 2

- Konfiguration P18 Wert 3

- Der Kontakt wird an den Klemmen 5 und 6 am Stecker J5 der Hauptplatine angeschlossen.
(Kontakt unbedingt potentialfrei anschliessen)
- Kontakt offen-->Sollwert 1
- Kontakt geschlossen-->Sollwert 2

EXTERNE STUFENABSCHALTUNG

- Konfiguration P16 Werte 0 oder 1

- Die Kontakte werden an den Klemmen 6 bis 10 am Stecker J5 der Hauptplatine angeschlossen
(Kontakt unbedingt potentialfrei anschliessen)
- Kontakt offen-->Normalbetrieb
- Kontakt geschlossen-->Entlastungsbetrieb

EXTERNERBETRIEB DER STUFEN

- Konfiguration P16 Werte 2 oder 3

- Die Kontakte werden am den Klemmen 6 bis 10 am Stecker J5 der Hauptplatine angeschlossen
(Kontakt unbedingt potentialfrei anschliessen)
- Die Zuverdratende Kontaktanzahl ist von der Stufenanzahl abhängig.

ACHTUNG

Um Anschlussfehler zu vermeiden, unbedingt die Betriebs- und Wartungsanleitung MRS 1-4 Abschnitt Regelung und externe Regelung beachten.

J
I
H
G
F
E
D
C

Pompes / Pumps / Pumpen

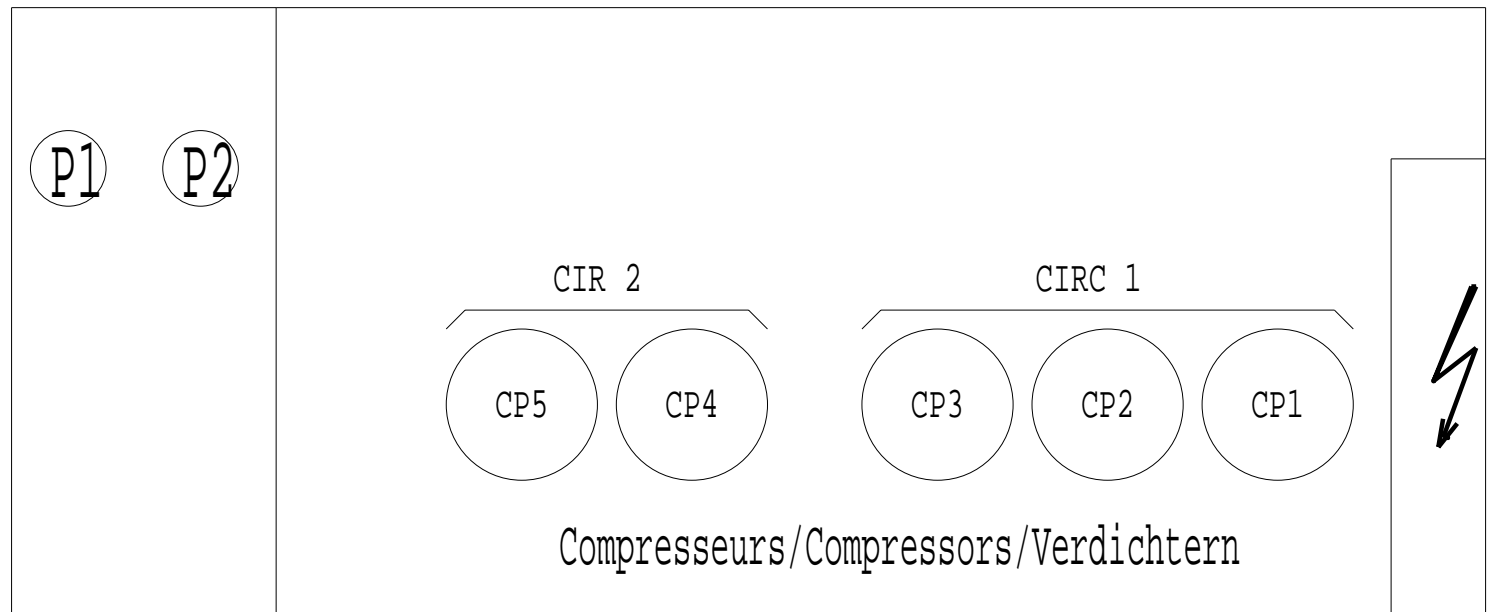

Ventilateurs Condenseur
Fans Condensor
Verflüssiger Ventilatoren



MODIFIE PAR: MODIFIED BY: GEANDERT DURCH: PG		INDICE INDEX KENNZIFFER 34		DATE DATE DATUM 06-07-00		FILS NUMEROTES EN OPTION NUMBERING OF WIRING IN OPTION OPTION KABEL NUMMERIERUNG			APPAREIL OU UNITE/UNIT/GERAT ODER EINHEIT LDH 750						
MODIFICATION A AJOUTE 1 BORNE ET RENUMEROTE FILS ET BORNES				LEGENDE/LEGEND/LEGENDE 3950010.36					SPECIFICATION/SPECIFICATION/SPEZIFIZIERUNG 5 COMPRESSEURS 2 CIRCUITS MRS1-4A 5 COMPRESSORS 2 CIRCUITS 5 VERDICHTERN 2 KREISLAUFE						
REMPLACE/TAKE/ERSETZT		REMPLACE PAR/TAKE BY/ERSETZT DURCH		CLIENT/CLIENT/KUNDE			REFERENCE/REFERENCE/REFERENZ			CREATEUR: CREATOR: HERSTELLER: JP		DATE: DATE: DATUM: 16-02-99			
REFERENCES COMMANDE/ORDER REFERENCES/AUFTRAGSREFERENZ				DEMARRAGE/START/ANLAUF		TENSION/VOLTAGE/SPANNUNG		COMPAGNIE INDUSTRIELLE D'APPLICATIONS THERMIQUES CIAT		FOLIO/FOLIO/SEITE 1 / 7		NUMERO DE SCHEMA/DRAWING NUMBER/PLAN NR 3980866		INDICE/INDEX/KENNZIFFER 34	

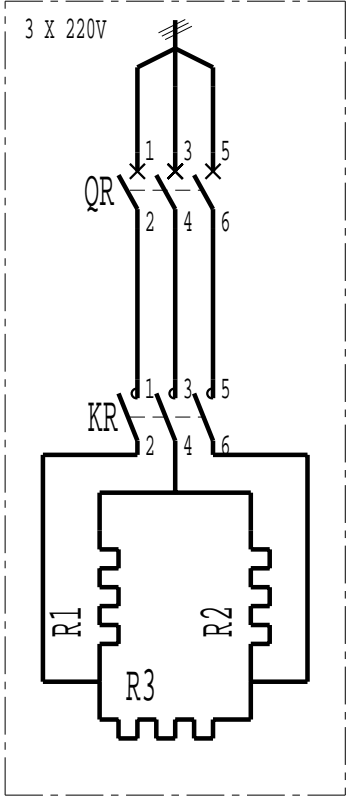
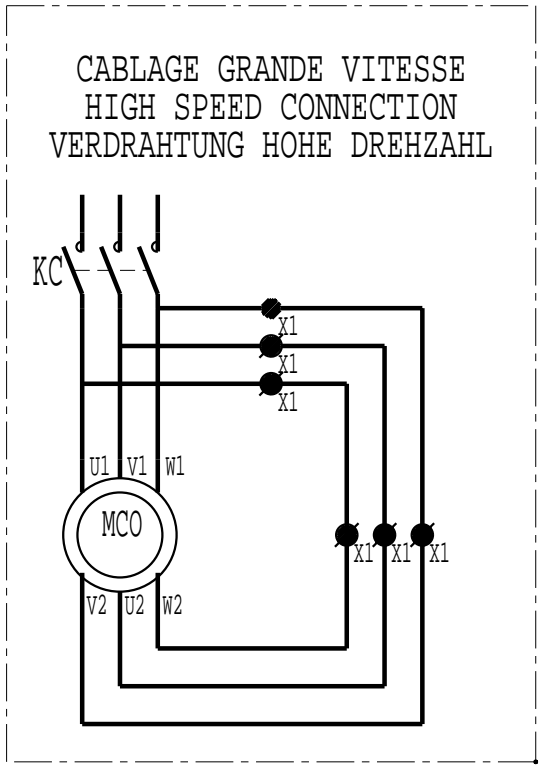
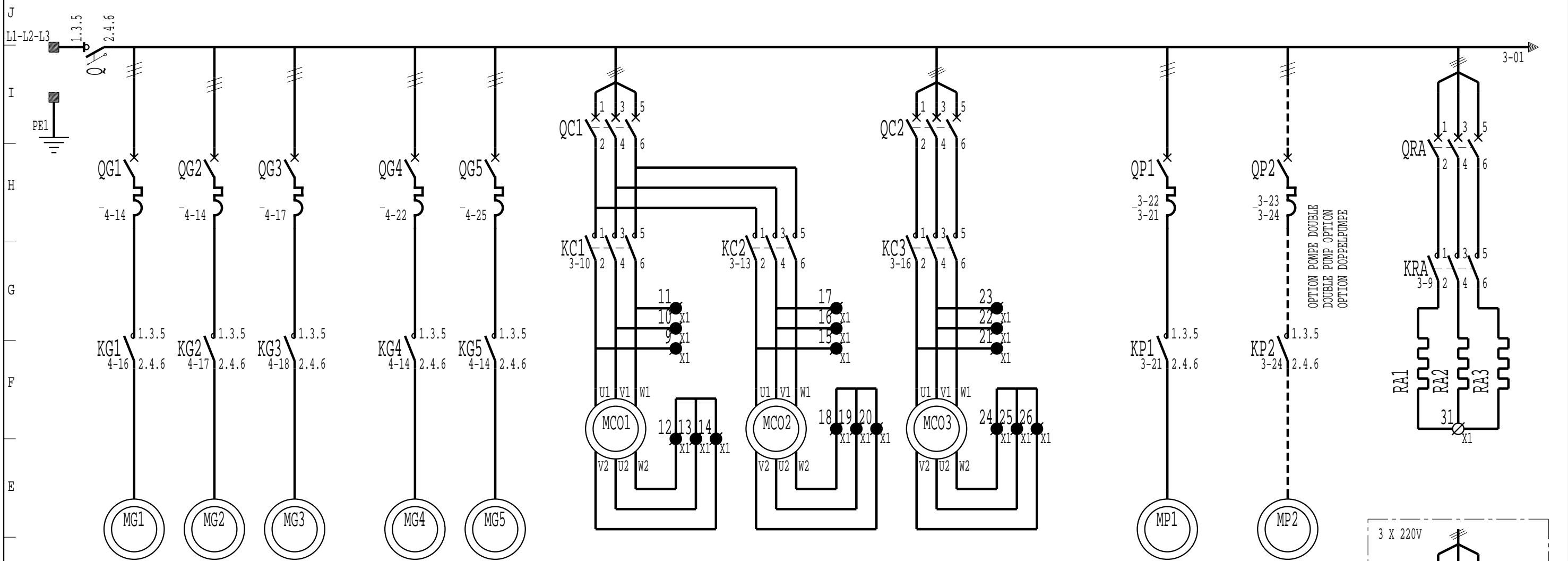

	Puissance en CV des compresseurs Compressors nominal output HP Verdichterleistung in PS					
	LDH	CP1	CP2	CP3	CP4	CP5
	750	15	15	15	15	15

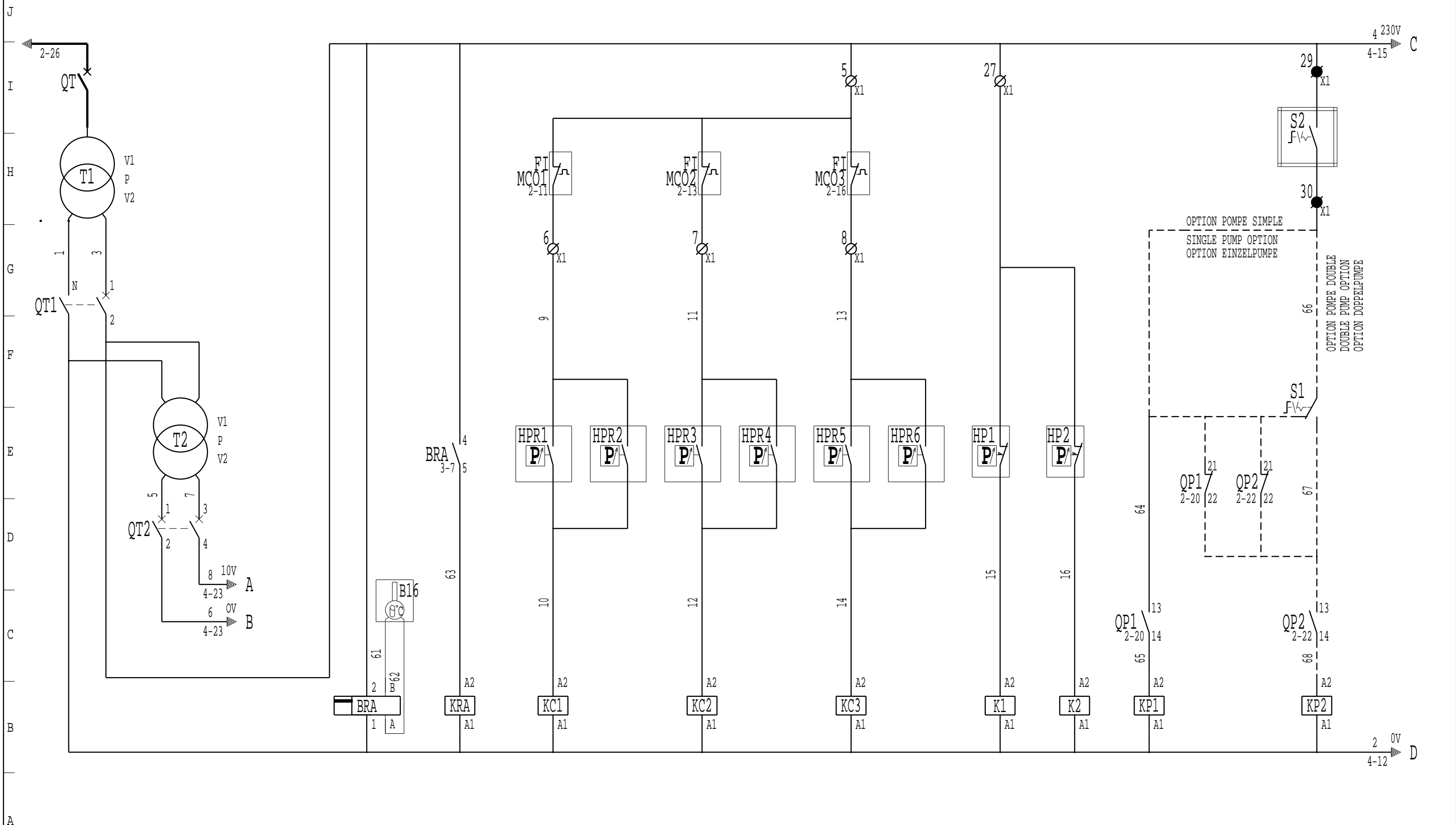

0	I	F	0	F	0	F	0	F	0	F	Fermeture	Fermeture	0	F	0	F
		3-9		2-25		2-11		2-13		2-16	4-10	4-14		2-20		2-22
											4-16	4-14				
											4-18	4-19				

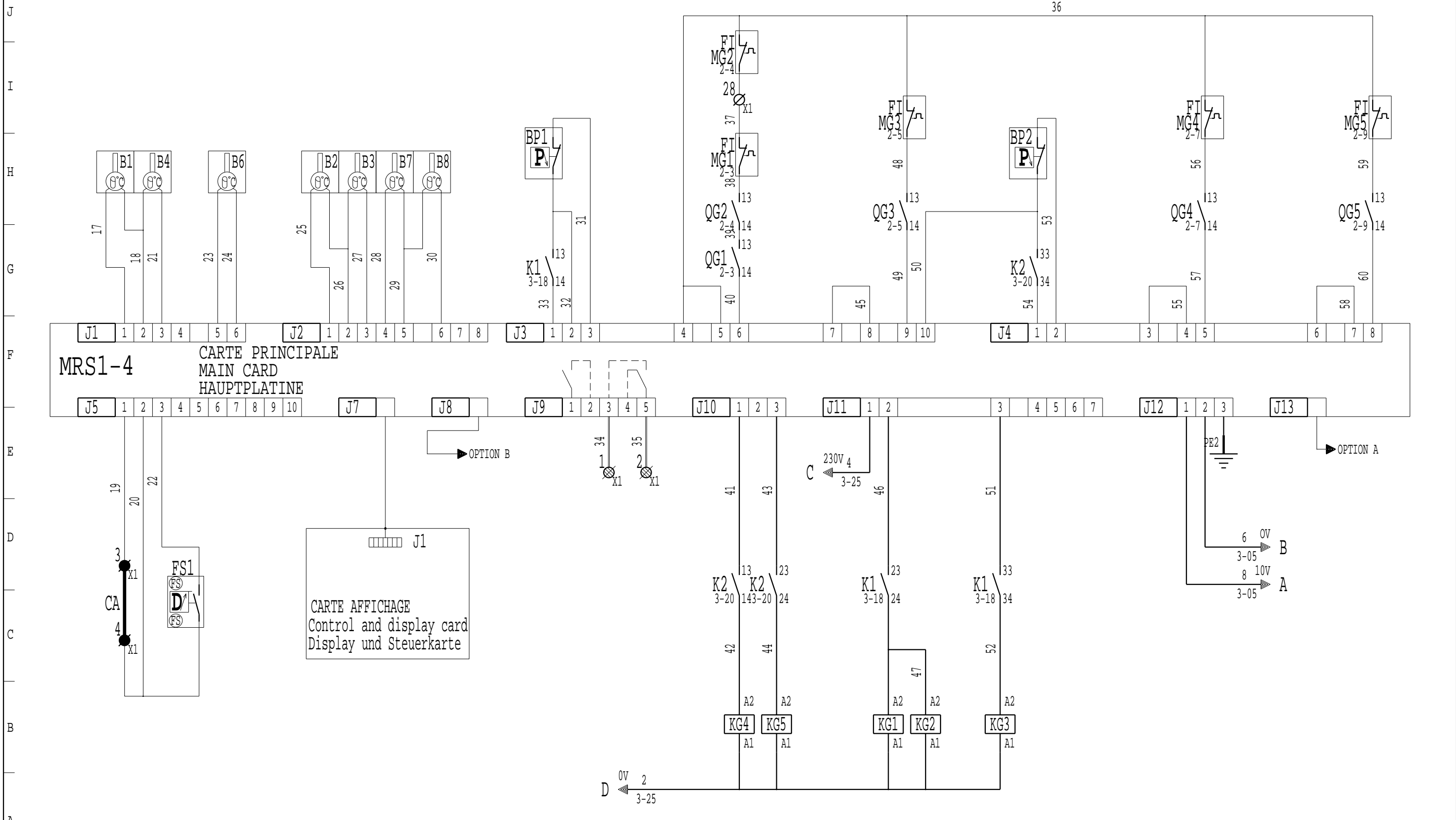

O	FO	F	O	FO	F	O	F
	2-7	2-9		2-3	2-4		2-5

J
I
H
G
F
E
D
C
B
A

RACCORDEMENTS USINE		RACCORDEMENTS CLIENT
FACTORY CONNECTION		CONNECTED BY CUSTOMER
WERKSEITIGE VERDRÄHTUNG	X1	ANSCHLUSS-KUNDE

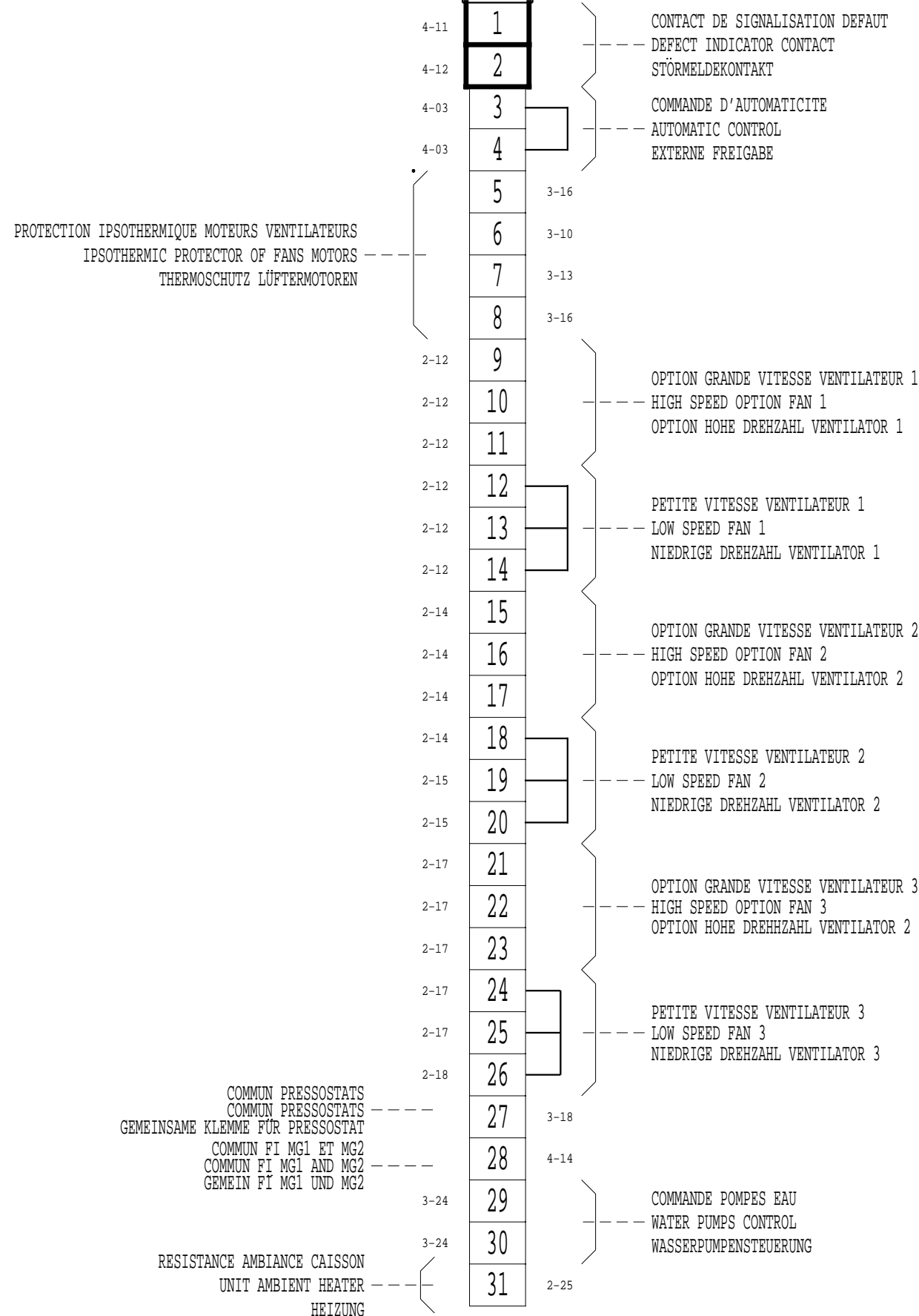

MRS1-4 / H	
B1	Sonde entree eau glatee Inlet chilled water sensor Fühler Kaltwassereintritt
B2	Sonde sortie evaporateur N 1 Evaporator N 1 outlet sensor Austrittsfühler Verdampfer N 1
B3	Sonde sortie evaporateur N 2 Evaporator N 2 outlet sensor Austrittsfühler Verdampfer N 2
B4	Sonde sortie eau glatee (collecteur) Collector chilled water outlet sensor Fühler Kaltwasseraustritt (Sammler)
B5	Sonde eau chaude Hot water sensor Warmwasserfühler
B6	Sonde air exterieur External air sensor Aussenluftfühler
B7	Sonde refoulement circuit 1 Circuit N 1 discharge sensor Heissgasfühler Kreislauf 1
B8	Sonde refoulement circuit 2 Circuit N 2 discharge sensor Heissgasfühler Kreislauf 2
B16	Sonde ballon tampon Buffer tank sensor Fühler Pufferspeicher

OPTION A MRS
INTERFACE RX-TX (RS485-4 fils)
INTERFACE RX-TX (RS485-4 WIRES)
ANSCHLUSS INTERFACE RX-TX (RS485 - 4 ADERN)

OPTION B MRS
CAD-RELAYAGE-PC (RS485-2 fils)
INTERFACE RX-TX (RS485-2 WIRES)
ANSCHLUSS CAD-RELAIS-PC (RS485 - 2 ADERN)

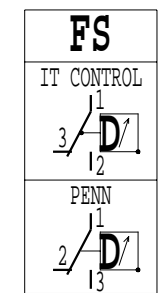

HP - BP	HP - BP		
	PENN P77	RANCO 016	MINI
BP	3 2	4 2	4 2
AUTO	1	1	1
HP	3 2	2 4	2 4
MANU	1	1	1
HP	2 3	4 2	2 4
AUTO	1	1	1

MRS1-4

DEFAUT GENERAL

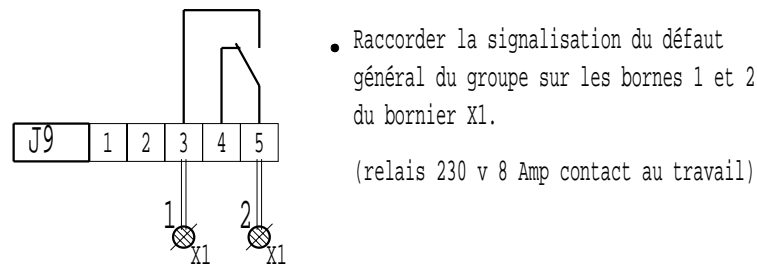

- Raccorder la signalisation du défaut général du groupe sur les bornes 1 et 2 du bornier X1.
- (relais 230 v 8 Amp contact au travail)

COMMANDE D'AUTOMATICITE

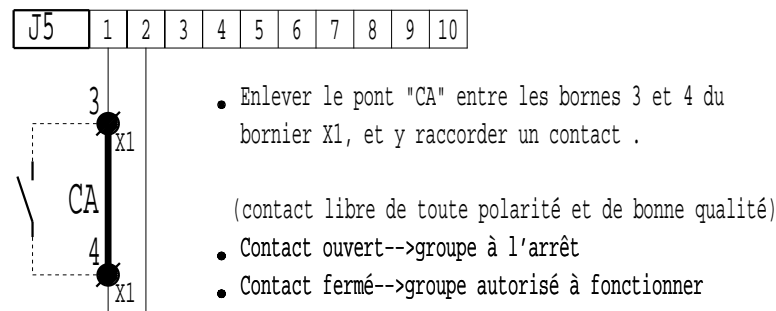

- Enlever le pont "CA" entre les bornes 3 et 4 du bornier X1, et y raccorder un contact .
- (contact libre de toute polarité et de bonne qualité)
- Contact ouvert-->groupe à l'arrêt
 - Contact fermé-->groupe autorisé à fonctionner

FONCTIONNEMENT EN PUISSANCE MAXI

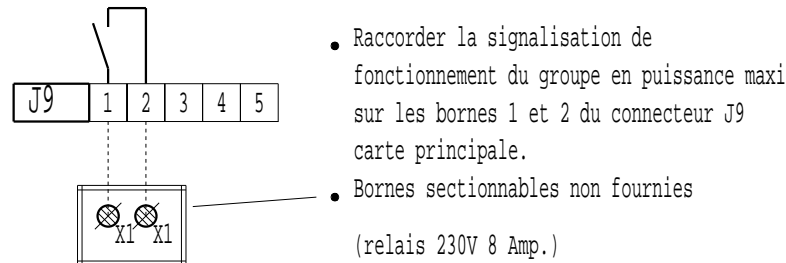

- Raccorder la signalisation de fonctionnement du groupe en puissance maxi sur les bornes 1 et 2 du connecteur J9 carte principale.
 - Bornes sectionnables non fournies
- (relais 230V 8 Amp.)

SELECTION CHAUD/FROID

- Configuration P17 valeur 3

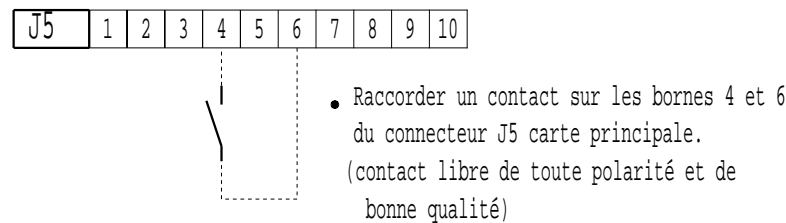

- Raccorder un contact sur les bornes 4 et 6 du connecteur J5 carte principale.
- (contact libre de toute polarité et de bonne qualité)
- Contact ouvert-->fonctionnement FROID
 - Contact fermé-->fonctionnement CHAUD

GENERAL FAULT

- The fault or not-fault information on the unit can be recover on terminals 1 and 2 connector X1.
- (relay 230V 8 Amp.)

AUTOMATIC CONTROL

- The shunt "CA" on terminals 3 and 4 of connector X1, must be lifted and the contact connected.
- (contact must be polarity free and of good quality)
- Contact open-->unit off-line
 - Contact closed-->unit on-line

MAXIMUM OUTPUT OPERATION

- The controle device must be connected to terminals 1 and 2 on connector J9 of main card.
 - Isolating terminals not supplied
- (relay 230V 8 Amp.)

HEATING/COOLING SELECTION

- Configuration P17 value 3

- The controle device must be connected to terminals 4 and 6 on connector J5 of main card.
- (contact must be polarity free and of good quality)
- Contact open-->COOLING operation
 - Contact closed-->HEATING operation

SAMMELSTÖRMELDUNG

- Die Störungsmeldung wird an den Klemmen 1 und 2 der Anschlüsse X1 abgenommen.
- (Relais 230V 8 Amp)

EXTERNE FREIGABE

- Die Brücke "CA" an den Klemmen 3 und 4 am Anschluss X1 entfernen und externen Kontakt anschliessen.
- (Kontakt unbedingt potentialfrei anschliessen)
- Kontakt offen-->Gerät abgeschaltet
 - Kontakt geschlossen-->Gerät Betriebsbereit

MAXIMALE LEISTUNG

- Der Kontakt wird an den Klemmen 1 und 2 am Stecker J9 der Hauptplatine angeschlossen.
 - Anschlussklemmen nicht mitgeliefert
- (Relais 230V 8 Amp)

AUSWAHL HEIZ-O.KÜHLBETRIEB

- Konfiguration P17 Wert 3

- Der Kontakt wird an den Klemmen 4 und 6 am Stecker J5 der Hauptplatine angeschlossen.
- (Kontakt unbedingt potentialfrei anschliessen)
- Kontakt offen-->Kühlbetrieb
 - Kontakt geschlossen-->Heizbetrieb

MRS1-4

SELECTION CONSIGNE 1 ou 2

- Configuration P18 valeur 3

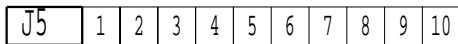

- Raccorder un contact entre les bornes 5 et 6 du connecteur J5 carte principale.
(contact libre de toute polarité et de bonne qualité)
- Contact ouvert-->CONSIGNE 1
- Contact fermé-->CONSIGNE 2

FONCTION DE DELESTAGE

- Configuration P16 valeurs 0 ou 1

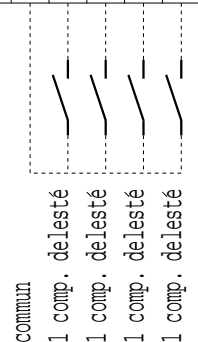
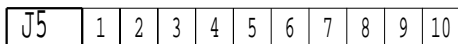

- Raccorder les contacts sur chaque entrée pour délester les différents compresseurs.
(contact libre de toute polarité et de bonne qualité)
- Contact ouvert-->fonctionnement normal
- Contact fermé-->fonctionnement avec délestage

COMMANDE DES ETAGES FORCES

- Configuration P16 valeurs 2 ou 3

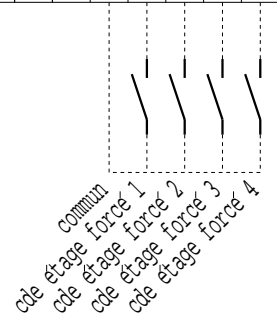
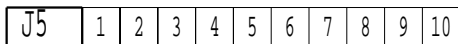

- Raccorder les contacts sur chaque entrée pour commander les différents étages
(contact libre de toute polarité et de bonne qualité)
- Suivant le nombre d'étages, il suffit de raccorder des contacts à fermeture.

PRECAUTIONS DE RACCORDEMENT

POUR LES PRECAUTIONS A PRENDRE POUR LE RACCORDEMENT DES ENTREES
VOIR LE MANUEL D'UTILISATION MRS1-4 PARAGRAPHE :
"ASSERVISSEMENT ET COMMANDES EXTERNES"

SETTING 1 OR 2 SELECTION

- Configuration P18 value 3

- The control must be connected to terminals 5 and 6 connector J5 on the main card.
(contact must be polarity free and of good quality)
- Contact open-->SETTING 1 operation
- Contact closed-->SETTING 2 operation

LOAD SHEDDING

- Configuration P16 values 0 or 1

- When a certain number of compressors must be shedded, connect an external control on connector J5 on the main card.
(contact must be polarity free and of good quality)
- Contact open-->normal running
- Contact closed-->shedding

FORCED STAGES CONTROL

- Configuration P16 values 2 or 3

- The control of the various stages is made by an external control connected to the connector J5 of the main card.
(contact must be polarity free and of good quality)
- According to the number of stages, connection of NO (normally open) contacts is sufficient.

CAUTION

TO TAKE PRECAUTION FOR CLIENT'S CONNECTION OF INPUTS
SEE THE OPERATING AND MAINTENANCE INSTRUCTIONS OF
MICROCIAT MRS1-4 PARAGRAPH :
"SERVO CONTROL AND EXTERNAL CONTROLS"

AUSWAHL SOLLWERT 1 ODER 2

- Konfiguration P18 Wert 3

- Der Kontakt wird an den Klemmen 5 und 6 am Stecker J5 der Hauptplatine angeschlossen.
(Kontakt unbedingt potentialfrei anschliessen)
- Kontakt offen-->Sollwert 1
- Kontakt geschlossen-->Sollwert 2

EXTERNE STUFENABSCHALTUNG

- Konfiguration P16 Werte 0 oder 1

- Die Kontakte werden an den Klemmen 6 bis 10 am Stecker J5 der Hauptplatine angeschlossen
(Kontakt unbedingt potentialfrei anschliessen)
- Kontakt offen-->Normalbetrieb
- Kontakt geschlossen-->Entlastungsbetrieb

EXTERNERBETRIEB DER STUFEN

- Konfiguration P16 Werte 2 oder 3

- Die Kontakte werden am den Klemmen 6 bis 10 am Stecker J5 der Hauptplatine angeschlossen
(Kontakt unbedingt potentialfrei anschliessen)
- Die Zuverdrahtende Kontaktanzahl ist von der Stufenanzahl abhängig.

ACHTUNG

Um Anschlussfehler zu vermeiden, unbedingt die Betriebs- und Wartungsanleitung MRS 1-4 Abschnitt Regelung und externe Regelung beachten.