

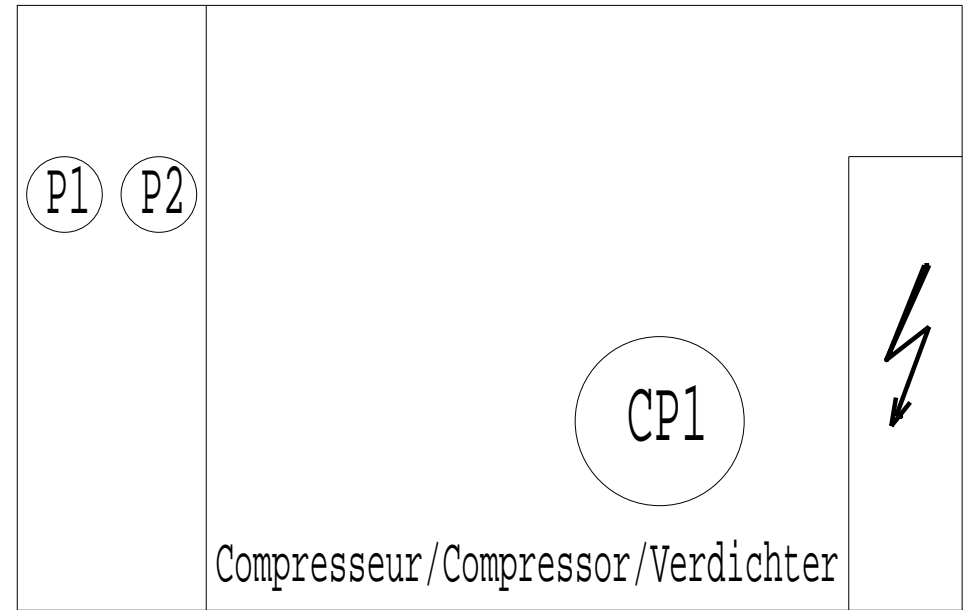

J
I
H
G
F
E
D
C

Pompes / Pumps / Pumpes



MODIFIE PAR: MODIFIED BY: GEANDERT DURCH: PG		INDICE INDEX KENNZIFFER 35		DATE DATE DATUM 11-07-00				APPAREIL OU UNITE/UNIT/GERAT ODER EINHEIT ILDH 100 - 150							
MODIFICATION A RENUMEROTE FILS ET BORNES				LEGENDE/LEGEND/LEGENDE 3950010.36		SPECIFICATION/SPECIFICATION/SPEZIFIZIERUNG 1 COMPRESSEUR 1 CIRCUIT MRS4-2 1 COMPRESSOR 1 CIRCUIT 1 VERDICHTER 1 KREISLAUF									
REMPLACE/TAKE/ERSETZT 3980631		REMPLACE PAR/TAKE BY/ERSETZT DURCH		CLIENT/CLIENT/KUNDE		REFERENCE/REFERENCE/REFERENZ		CREATEUR: CREATOR: HERSTELLER: AB		DATE: DATE: DATUM: 21-07-98					
REFERENCES COMMANDE/ORDER REFERENCES/AUFTRAGSREFERENZ				DEMARRAGE/START/ANLAUF		TENSION/VOLTAGE/SPANNUNG		COMPAGNIE INDUSTRIELLE D'APPLICATIONS THERMIQUES 		FOLIO/FOLIO/SEITE 1 / 6		NUMERO DE SCHEMA/DRAWING NUMBER/PLAN NR 3980774		INDICE/INDEX/KENNZIFFER 35	

J
I
H
G
F
E
D
C
B
A

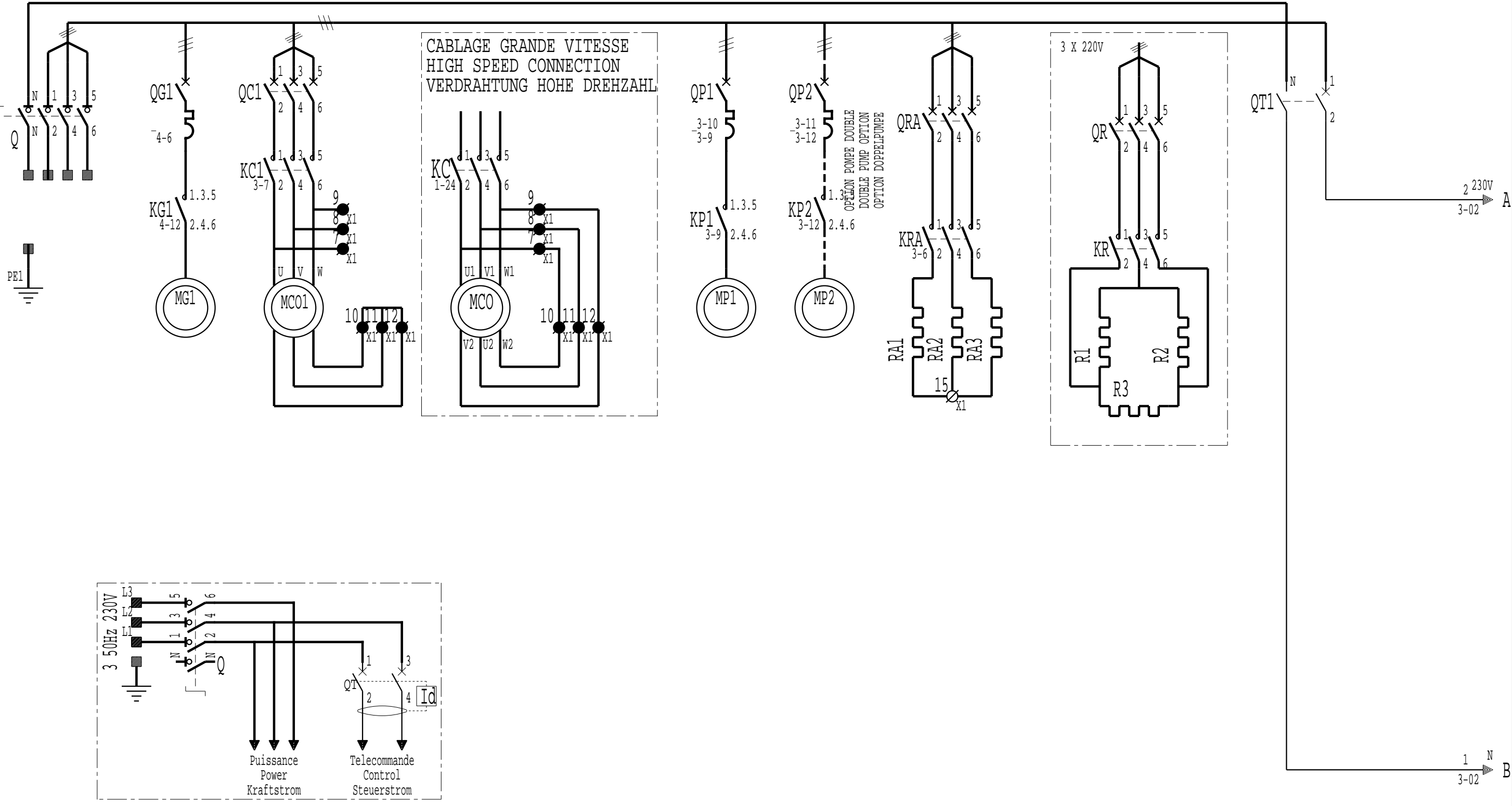

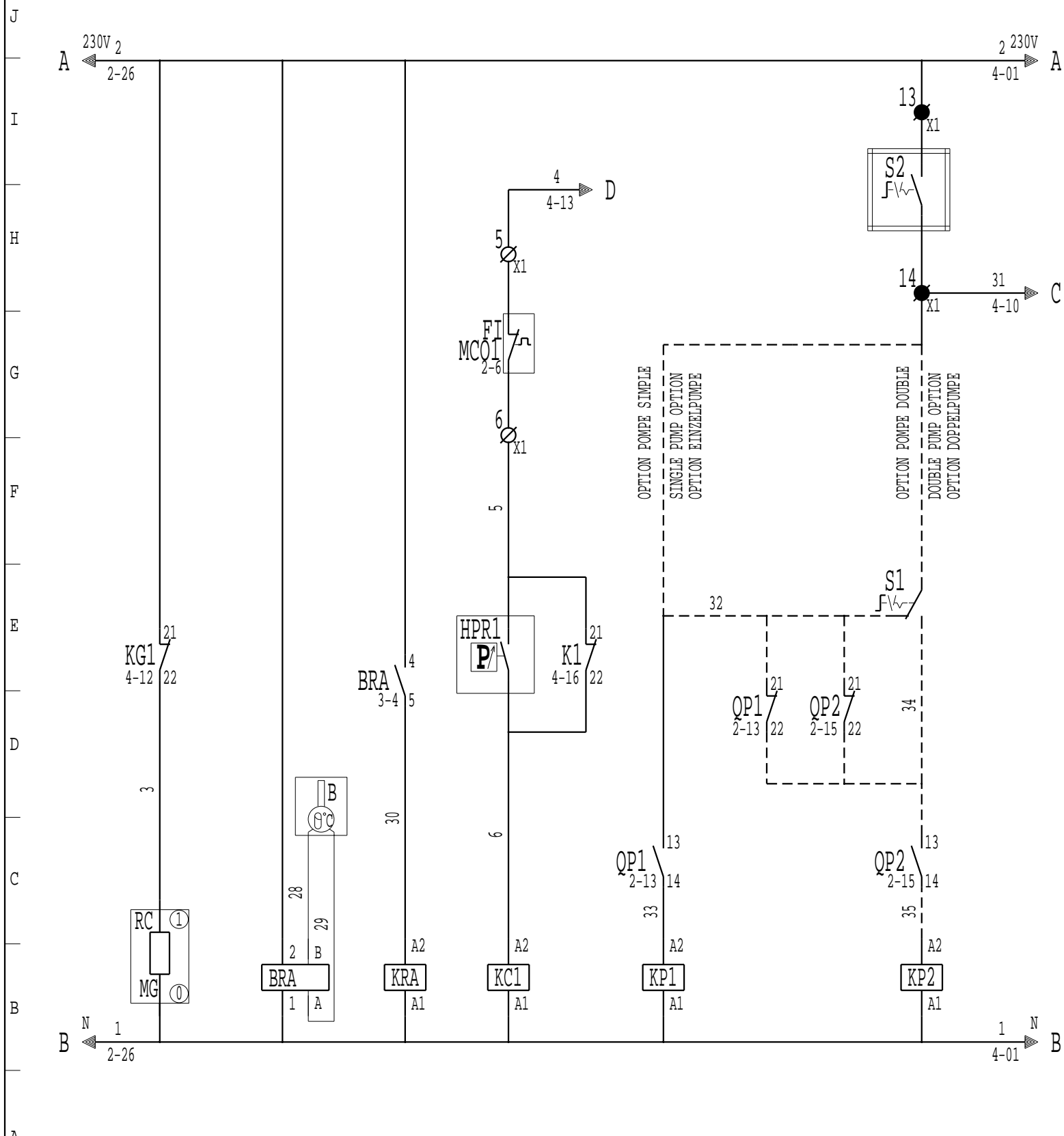

RACCORDEMENTS USINE FACTORY CONNECTION WERKSEITIGE VERDRÄHTUNG	X1	RACCORDEMENTS CLIENT CONNECTED BY CUSTOMER ANSCHLUSS-KUNDE
4-10	1	CONTACT DE SIGNALISATION DEFAUT
4-11	2	DEFECT INDICATOR CONTACT STÖRMELDEKONTAKT
4-11	3	COMMANDE D'AUTOMATICITE AUTOMATIC CONTROL
4-11	4	EXTERNE FREIGABE
3-07	5	PROTECTION IPSOTHERMIQUE MOTEURS VENTILATEURS IPSOTHERMIC PROTECTOR OF FANS MOTORS THERMOSCHUTZ LÜFTERMOTOREN
3-07	6	
2-07	7	OPTION GRANDE VITESSE VENTILATEUR 1 HIGH SPEED OPTION FAN 1
2-07	8	OPTION HOHE DREHZAHL VENTILATOR 1
2-07	9	
2-07	10	PETITE VITESSE VENTILATEUR 1 LOW SPEED FAN 1
2-07	11	NIEDRIGE DREHZAHL VENTILATOR 1
2-08	12	
3-12	13	COMMANDE POMPES EAU WATER PUMPS CONTROL
3-12	14	WASSERPUMPENSTEUERUNG
2-17	15	RESISTANCE AMBIANCE CAISSON UNIT AMBIENT HEATER HEIZUNG

O	I	F	O	F	O	F	O	F	O	F
		3-6		2-17		2-6		2-13		2-15

J
A
I
H
G
F
E
D
C
B
A

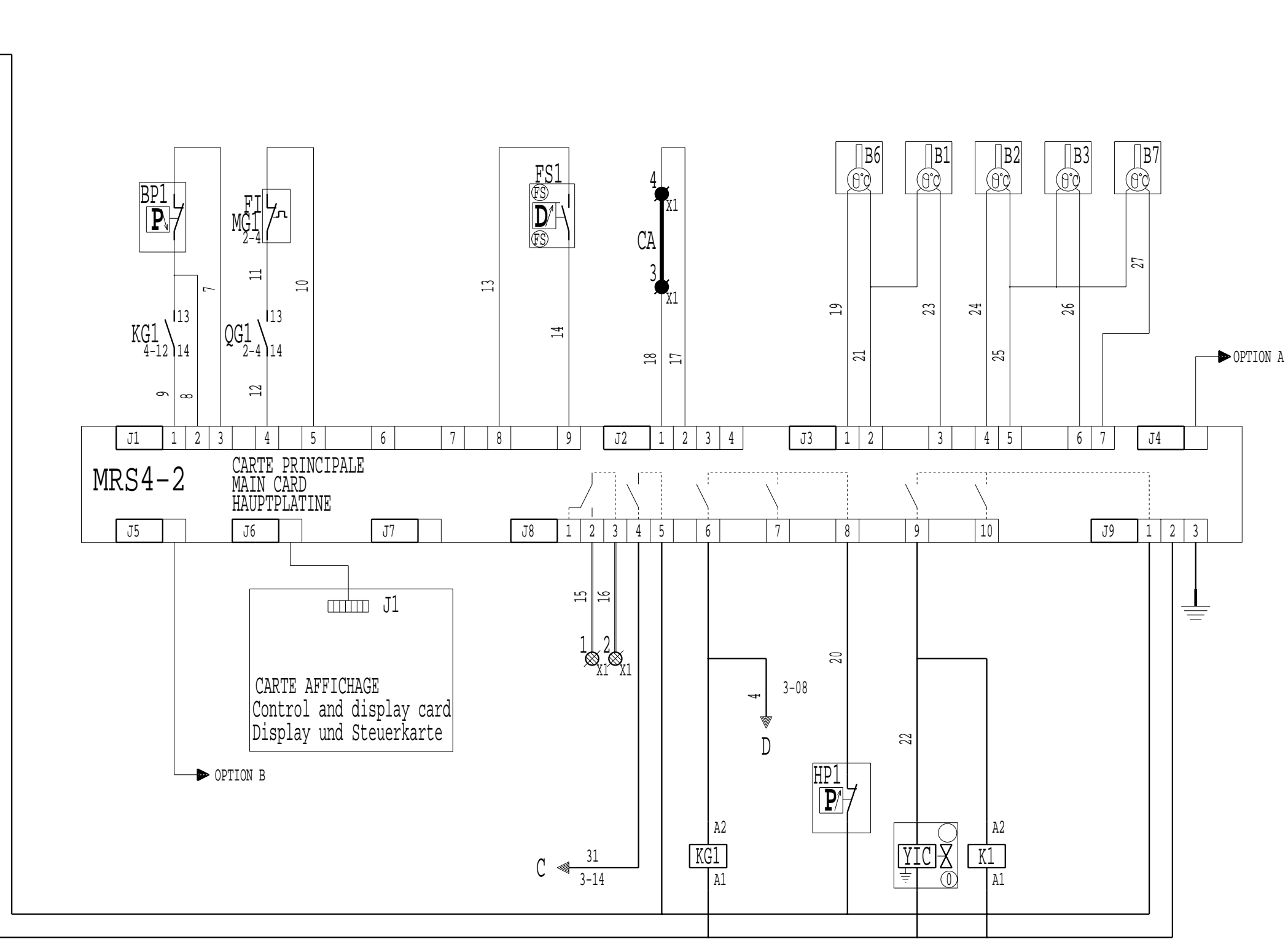

MRS4_2	
B1	Sonde entree eau glatee Inlet chilled water sensor Fühler Kaltwassereintritt
B2	Sonde sortie evaporateur N 1 Evaporator N 1 outlet sensor Austrittsfühler Verdampfer N 1
B3	Sonde temperature freon Refrigerant temperature sensor Fühler Kältemitteltemperatur
B5	Sonde eau chaude Hot water sensor Warmwasserfühler
B6	Sonde air exterieur External air sensor Aussenluftfühler
B7	Sonde de refluxement Discharge sensor Heissgasfühler

OPTION A MRS	
INTERFACE RX-TX (RS485-4 fils)	
INTERFACE RX-TX (RS485-4 WIRES)	
ANSCHLUSS INTERFACE RX-TX (RS485 - 4 ADERN)	

OPTION B MRS	
CAD-RELAYAGE-PC (RS485-2 fils)	
INTERFACE RX-TX (RS485-2 WIRES)	
ANSCHLUSS CAD-RELAIS-PC (RS485 - 2 ADERN)	

	HP - BP			FS
	PENN P77	RANCO 016	MINI	
BP	3 2	4 2	4 2	IT CONTROL 3/D/12 PENN 2/D/13
AUTO	1	1	1	
HP	3 2	2 4	2 4	
MANU	1	1	1	
HP	2 3	4 2	2 4	
AUTO	1	1	1	

O	F
3-3	2-4
	4-4

O	F
3-8	

MRS4-2

DEFAUT GENERAL

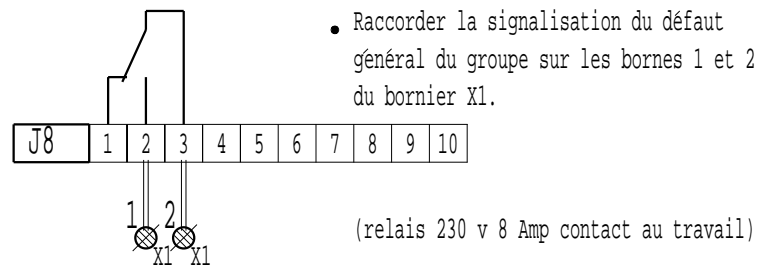

GENERAL FAULT

• The fault or not-fault information on the unit can be recover on terminals 1 and 2 connector X1.

(relay 230V 8 Amp.)

SAMMELSTÖRMELDUNG

• Die Störungsmeldung wird an den Klemmen 1 und 2 der Anschlusse X1 abgenommen.

(Relais 230V 8 Amp)

COMMANDE D'AUTOMATICITE

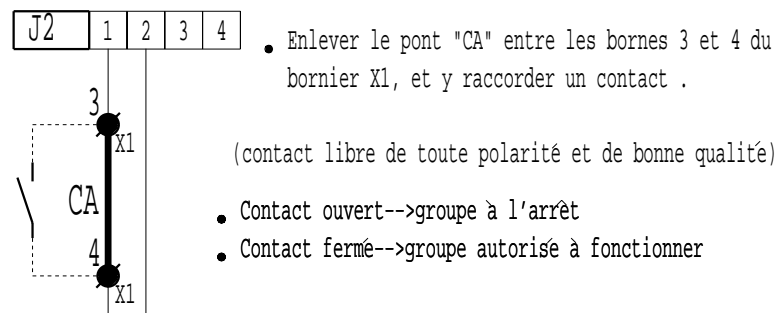

AUTOMATIC CONTROL

• The shunt "CA" on terminals 3 and 4 of connector X1, must be lifted and the contact connected.

(contact must be polarity free and of good quality)

- Contact open-->unit off-line
- Contact closed-->unit on-line

EXTERNE FREIGABE

• Die Brücke "CA" an den Klemmen 3 und 4 am Anschluss X1 entfernen und externen Kontakt anschliessen.

(Kontakt unbedingt potentialfrei anschliessen)

- Kontakt offen-->Gerät abgeschaltet
- Kontakt geschlossen-->Gerät Betriebsbereit

SELECTION CHAUD/FROID

- Configuration P17 valeur 3

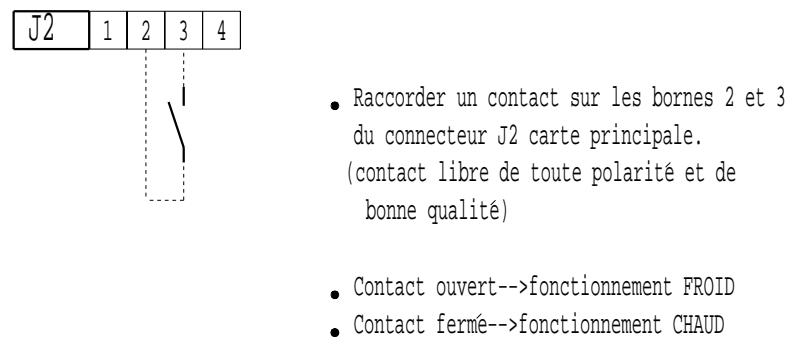

HEATING/COOLING SELECTION

- Configuration P17 value 3

• The controle device must be connected to terminals 2 and 3 on connector J2 of main card. (contact must be polarity free and of good quality)

- Contact open-->COOLING operation
- Contact closed-->HEATING operation

AUSWAHL HEIZ-O.KÜHLBETRIEB

- Konfiguration P17 Wert 3

• Der Kontakt wird an den Klemmen 2 und 3 am Stecker J2 der Hauptplatine angeschlossen (Kontakt unbedingt potentialfrei anschliessen)

- Kontakt offen-->Kühlbetrieb
- Kontakt geschlossen-->Heizbetrieb

MRS4-2

SELECTION CONSIGNE 1 ou 2

- Configuration P18 valeur 3

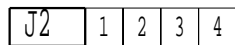

- Raccorder un contact entre les bornes 2 et 4 du connecteur J2 carte principale.
(contact libre de toute polarité et de bonne qualité)
- Contact ouvert-->CONSIGNE 1
- Contact fermé-->CONSIGNE 2

COMMANDE POMPE A EAU

- Raccorder l'alimentation de la pompe entre les bornes 4 et 5 du connecteur J8 de la carte principale.

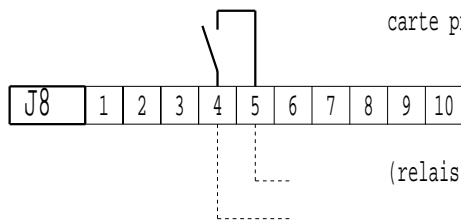

(relais 230V 8 Amp.)

COMMANDE DES ETAGES FORCES

- Configuration P16 valeur 2

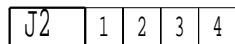

- Raccorder les contacts sur chaque entrée du connecteur J2 pour commander les différents étages
(contact libre de toute polarité et de bonne qualité)
- Suivant le nombre d'étages, il suffit de raccorder des contacts à fermeture.

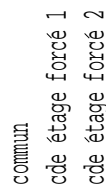

PRECAUTIONS DE RACCORDEMENT

POUR LES PRECAUTIONS A PRENDRE POUR LE RACCORDEMENT DES ENTREES
VOIR LE MANUEL D'UTILISATION MRS4-2 PARAGRAPHE :
"ASSERVISSEMENT ET COMMANDES EXTERNES"

SETTING 1 OR 2 SELECTION

- Configuration P18 value 3

- The controle must be connected to terminals 2 and 4 connector J2 main card.
(contact must be polarity free and of good quality)
- Contact open-->SETTING 1 operation
- Contact closed-->SETTING 2 operation

WATER POMP CONTROL

- The pump control must be connected to terminals 4 and 5 on connector J8 of main card.

(relay 230V 8 Amp.)

FORCED STAGES CONTROL

- Configuration P16 value 2

- The control of the various stages is made by an external control connected to the connector J2 of the main card.
(contact must be polarity free and of good quality)
- According to the number of stages, connection of NO (normally open) contacts is sufficient.

CAUTION

TO TAKE PRECAUTION FOR CLIENT'S CONNECTION OF INPUTS
SEE THE OPERATING AND MAINTENANCE INSTRUCTIONS OF
MICROCIAT MRS4-2 PARAGRAPH :
"SERVO CONTROL AND EXTERNAL CONTROLS"

AUSWAHL SOLLWERT 1 ODER 2

- Konfiguration P18 Wert 3

- Der Kontakt wird an den Klemmen 2 und 4 am Stecker J2 der Hauptplatine angeschlossen.
(Kontakt unbedingt potentialfrei anschliessen)
- Kontakt offen-->Sollwert 1
- Kontakt geschlossen-->Sollwert 2

PUMPENSTEUERUNG

- Der Kontakt wird an den Klemmen 4 und 5 am Stecker J8 der Hauptplatine angeschlossen.

(Relais 230V 8 Amp)

EXTERNERBETRIEB DER STUFEN

- Konfiguration P16 Wert 2

- Die Regelung der verschiedenen Stufen wird mit einem externen Kontakt am Stecker J2 der Hauptplatine hergestellt.
(Kontakt unbedingt potentialfrei anschliessen)
- Die Zuverdrahtende Kontaktanzahl ist von der Stufenanzahl abhängig.

ACHTUNG

Um Anschlussfehler zu vermeiden, unbedingt die Betriebs- und Wartungsanleitung MRS4-2 Abschnitt Regelung und externe Regelung beachten.

J
I
H
G
F
E
D
C

Pompes / Pumps / Pumpes

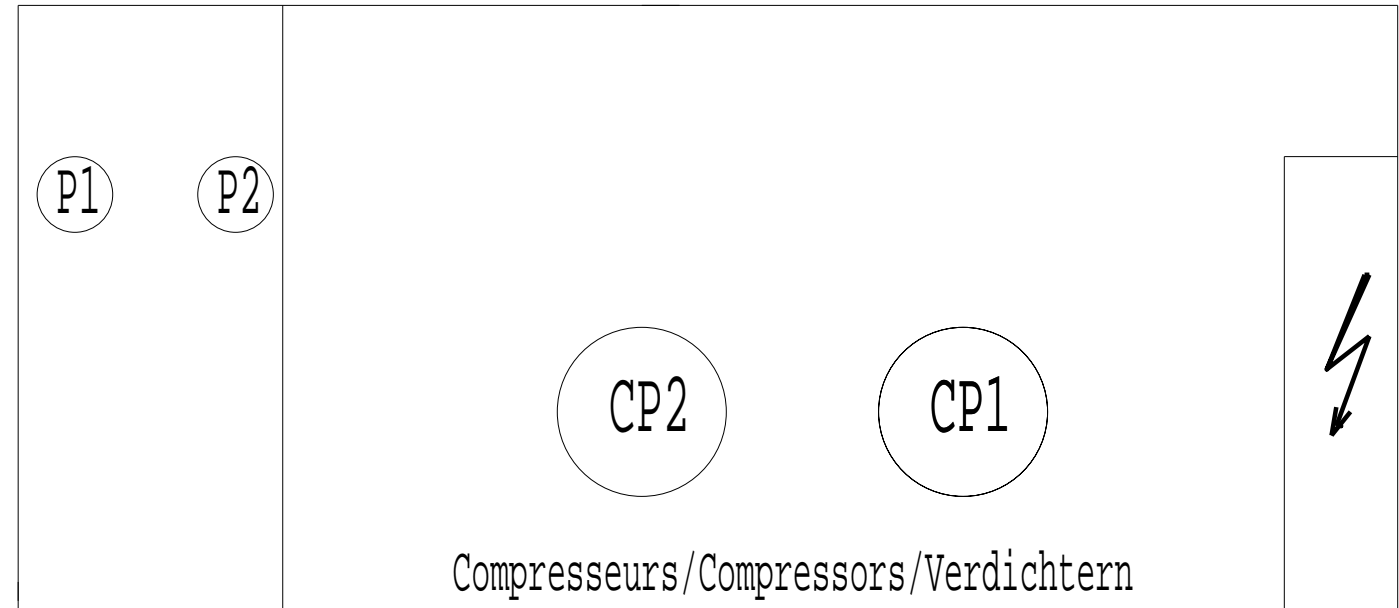

Ventilateur Condenseur
Fan Condensor
Verflüssiger Ventilatoren



MODIFIE PAR: MODIFIED BY: GEANDERT DURCH: PG		INDICE INDEX KENNZIFFER 36		DATE DATE DATUM 12-07-00					APPAREIL OU UNITE/UNIT/GERAT ODER EINHEIT ILDH 200 A 300						
MODIFICATION A RENUMEROTE FILS ET BORNES				LEGENDE/LEGEND/LEGENDE 3950010.36					SPECIFICATION/SPECIFICATION/SPEZIFIZIERUNG 2 COMPRESSEURS 1 CIRCUIT 2 COMPRESSORS 1 CIRCUIT 2 VERDICHTERN 1 KREISLAUF MRS4-2						
REMPLACE/TAKE/ERSETZT 3980529		REMPLACE PAR/TAKE BY/ERSETZT DURCH		CLIENT/CLIENT/KUNDE			REFERENCE/REFERENCE/REFERENZ			CREATEUR: CREATOR: HERSTELLER: AB		DATE: DATE: DATUM: 21-07-98			
REFERENCES COMMANDE/ORDER REFERENCES/AUFTRAGSREFERENZ				DEMARRAGE/START/ANLAUF		TENSION/VOLTAGE/SPANNUNG		COMPAGNIE INDUSTRIELLE D'APPLICATIONS THERMIQUES 		FOLIO/FOLIO/SEITE 1 / 6		NUMERO DE SCHEMA/DRAWING NUMBER/PLAN NR 3980775		INDICE/INDEX/KENNZIFFER 36	

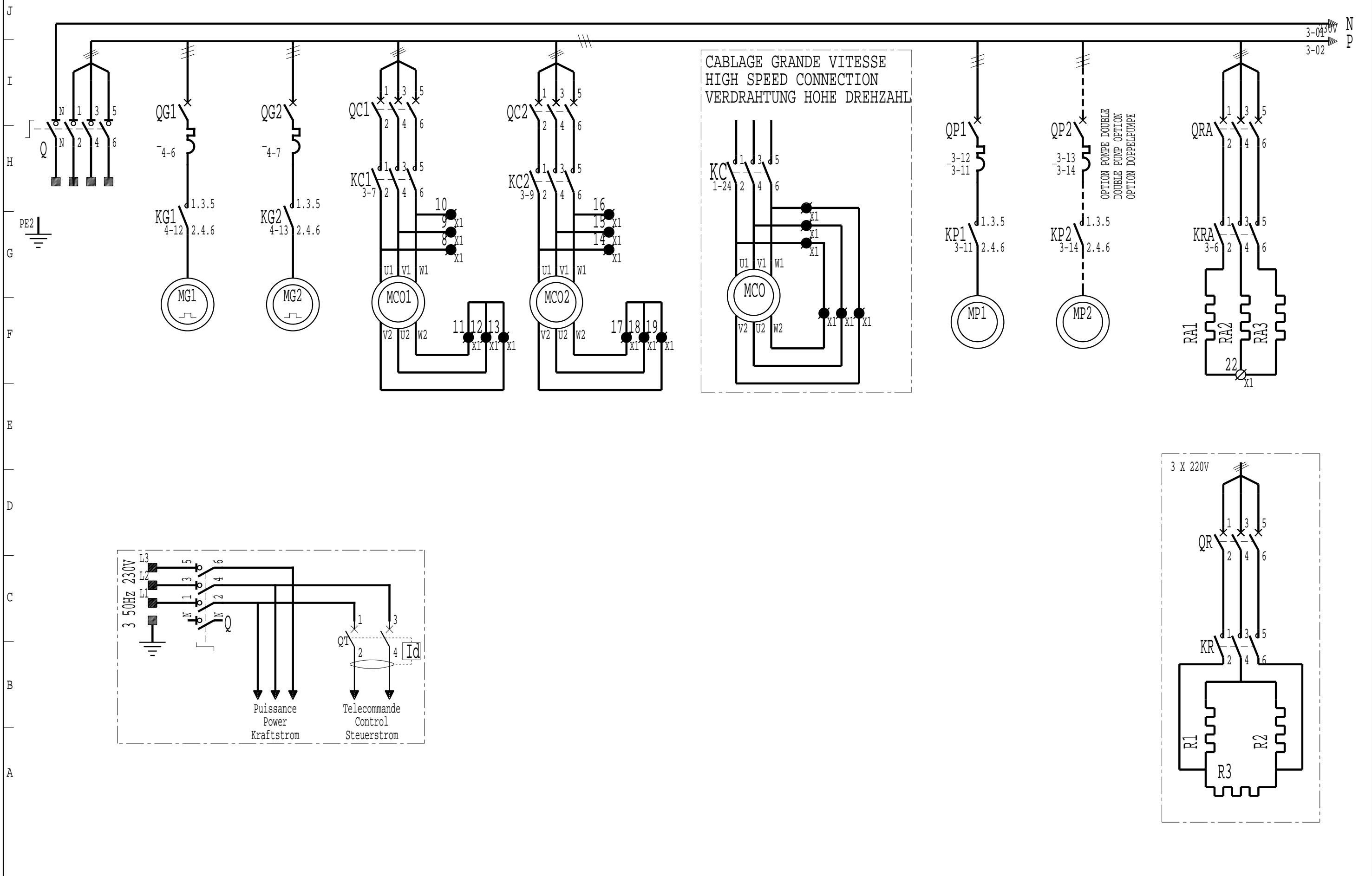

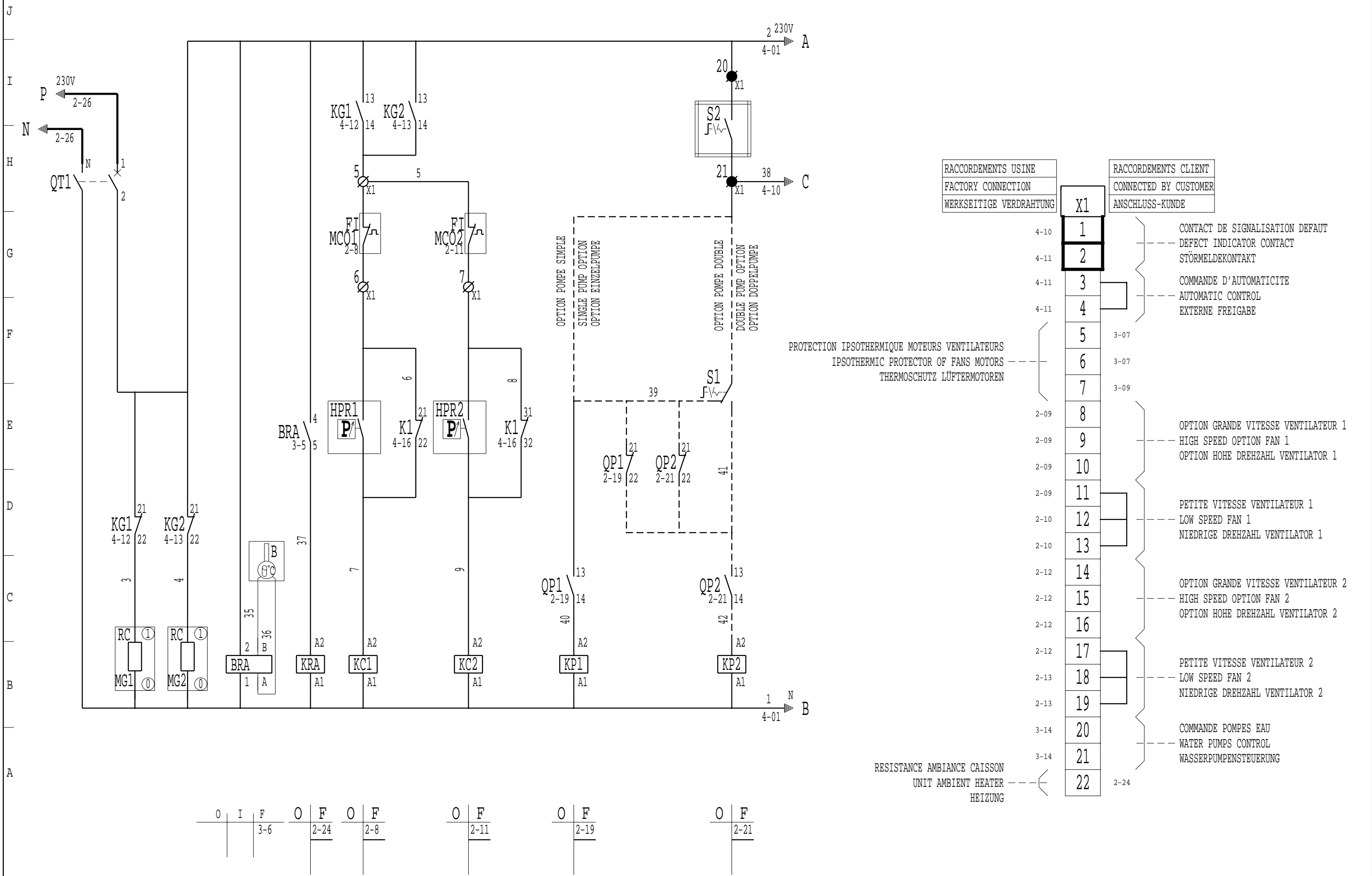

RACCORDEMENTS USINE FACTORY CONNECTION WERKSEITIGE VERDRÄHTUNG	X1	RACCORDEMENTS CLIENT CONNECTED BY CUSTOMER ANSCHLUSS-KUNDE
4-10	1	CONTACT DE SIGNALISATION DEFAULT
4-11	2	DEFECT INDICATOR CONTACT STÖRMELDEKONTAKT
4-11	3	COMMANDE D'AUTOMATICITE
4-11	4	AUTOMATIC CONTROL EXTERNE FREIGABE
3-07	5	
3-07	6	PROTECTION IPSOTHERMIQUE MOTEURS VENTILATEURS IPISOTHERMIC PROTECTOR OF FANS MOTORS THERMOSCHUTZ LÜFTERMOTOREN
3-09	7	
2-09	8	OPTION GRANDE VITESSE VENTILATEUR 1
2-09	9	HIGH SPEED OPTION FAN 1 OPTION HOHE DREHZAHN VENTILATOR 1
2-09	10	
2-10	11	PETITE VITESSE VENTILATEUR 1
2-10	12	LOW SPEED FAN 1 NIEDRIGE DREHZAHN VENTILATOR 1
2-10	13	
2-12	14	OPTION GRANDE VITESSE VENTILATEUR 2
2-12	15	HIGH SPEED OPTION FAN 2 OPTION HOHE DREHZAHN VENTILATOR 2
2-12	16	
2-12	17	PETITE VITESSE VENTILATEUR 2
2-13	18	LOW SPEED FAN 2 NIEDRIGE DREHZAHN VENTILATOR 2
2-13	19	
3-14	20	COMMANDE POMPES EAU
3-14	21	WATER PUMPS CONTROL WASSERPUMPENSTEUERUNG
2-24	22	RESISTANCE AMBIANCE CAISSON UNIT AMBIENT HEATER HEIZUNG

0	I	F	0	F	0	F	0	F	0	F
		3-6		2-24		2-8		2-11		2-19

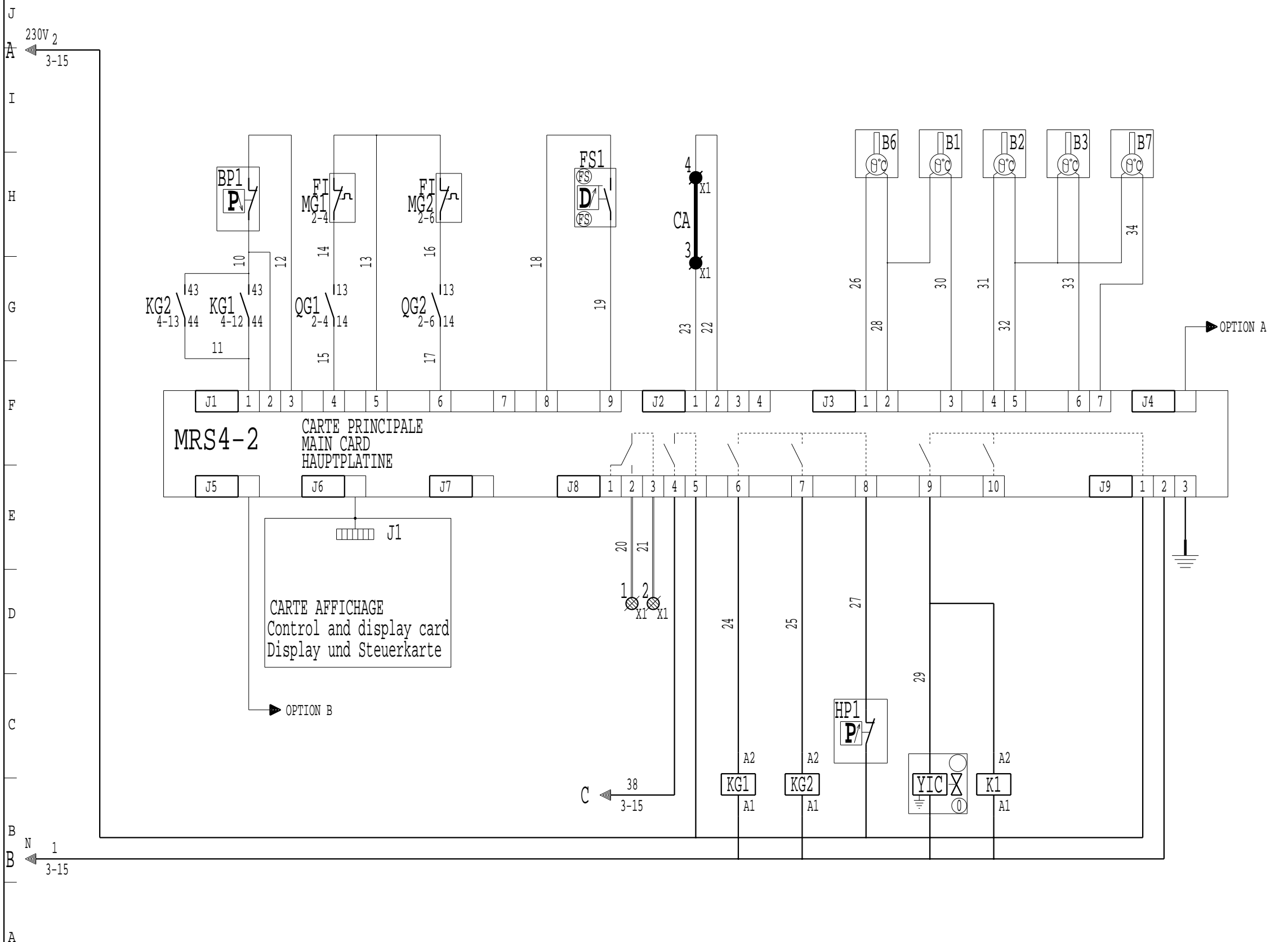

MRS4_2	
B1	Sonde entree eau glace Inlet chilled water sensor Fühler Kaltwassereintritt
B2	Sonde sortie evaporateur N 1 Evaporator N 1 outlet sensor Austrittsfühler Verdampfer N 1
B3	Sonde temperature freon Refrigerant temperature sensor Fühler Kältemitteltemperatur
B5	Sonde eau chaude Hot water sensor Warmwasserfühler
B6	Sonde air exterieur External air sensor Aussenluftfühler
B7	Sonde de refolement Discharge sensor Heissgasfühler

OPTION A MRS	
INTERFACE RX-TX (RS485-4 fils)	
INTERFACE RX-TX (RS485-4 WIRES)	
ANSCHLUSS INTERFACE RX-TX (RS485 - 4 ADERN)	

OPTION B MRS	
CAD-RELAYAGE-PC (RS485-2 fils)	
INTERFACE RX-TX (RS485-2 WIRES)	
ANSCHLUSS CAD-RELAIS-PC (RS485 - 2 ADERN)	

	HP - BP		
	PENN P77	RANCO 016	MINI
BP	3 2	4 2	4 2
AUTO	1	1	1
HP	3 2	2 4	2 4
MANU	1	1	1
HP	2 3	4 2	2 4
AUTO	1	1	1

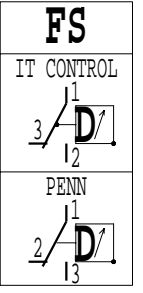

O	F	O	F	O	F
3-3	2-4	3-4	2-6	3-8	
	3-7		3-8	3-10	
	4-4		4-3		

MRS4-2

DEFAUT GENERAL

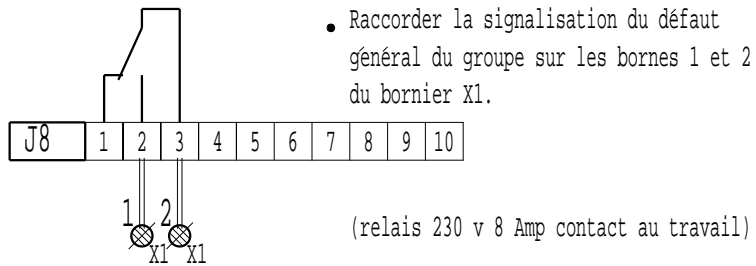

GENERAL FAULT

• The fault or not-fault information on the unit can be recover on terminals 1 and 2 connector X1.

(relay 230V 8 Amp.)

SAMMELSTÖRMELDUNG

• Die Störungsmeldung wird an den Klemmen 1 und 2 der Anschlusse X1 abgenommen.

(Relais 230V 8 Amp)

COMMANDE D'AUTOMATICITE

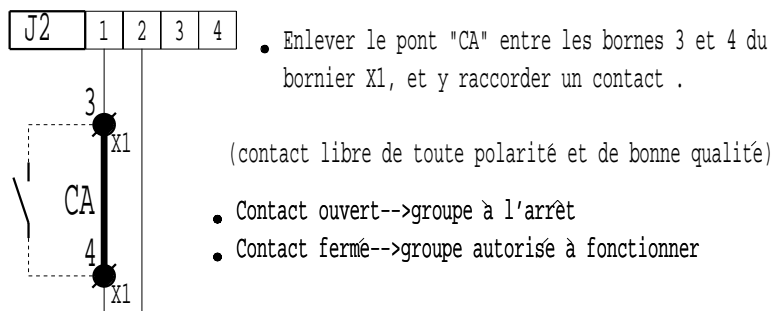

AUTOMATIC CONTROL

• The shunt "CA" on terminals 3 and 4 of connector X1, must be lifted and the contact connected.

(contact must be polarity free and of good quality)

- Contact open-->unit off-line
- Contact closed-->unit on-line

EXTERNE FREIGABE

• Die Brücke "CA" an den Klemmen 3 und 4 am Anschluss X1 entfernen und externen Kontakt anschliessen.

(Kontakt unbedingt potentialfrei anschliessen)

- Kontakt offen-->Gerät abgeschaltet
- Kontakt geschlossen-->Gerät Betriebsbereit

SELECTION CHAUD/FROID

- Configuration P17 valeur 3

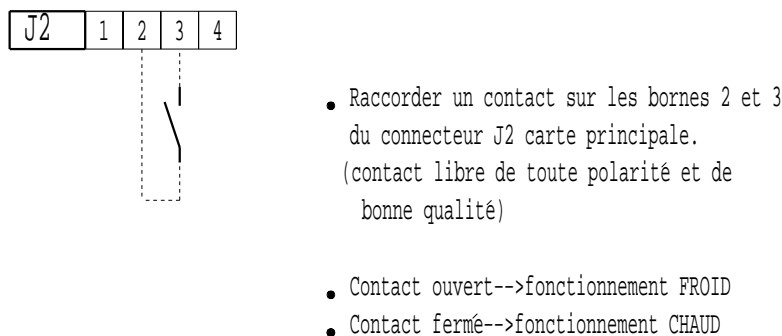

HEATING/COOLING SELECTION

- Configuration P17 value 3

• The controle device must be connected to terminals 2 and 3 on connector J2 of main card. (contact must be polarity free and of good quality)

- Contact open-->COOLING operation
- Contact closed-->HEATING operation

AUSWAHL HEIZ-O.KÜHLBETRIEB

- Konfiguration P17 Wert 3

• Der Kontakt wird an den Klemmen 2 und 3 am Stecker J2 der Hauptplatine angeschlossen (Kontakt unbedingt potentialfrei anschliessen)

- Kontakt offen-->Kühlbetrieb
- Kontakt geschlossen-->Heizbetrieb

MRS4-2

SELECTION CONSIGNE 1 ou 2

- Configuration P18 valeur 3

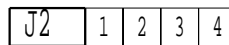

- Raccorder un contact entre les bornes 2 et 4 du connecteur J2 carte principale.
(contact libre de toute polarité et de bonne qualité)
- Contact ouvert-->CONSIGNE 1
- Contact fermé-->CONSIGNE 2

COMMANDE POMPE A EAU

- Raccorder l'alimentation de la pompe entre les bornes 4 et 5 du connecteur J8 de la carte principale.

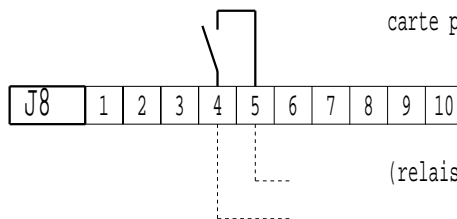

(relais 230V 8 Amp.)

COMMANDE DES ETAGES FORCES

- Configuration P16 valeur 2

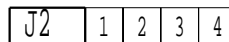

- Raccorder les contacts sur chaque entrée du connecteur J2 pour commander les différents étages
(contact libre de toute polarité et de bonne qualité)
- Suivant le nombre d'étages, il suffit de raccorder des contacts à fermeture.

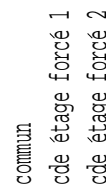

PRECAUTIONS DE RACCORDEMENT

POUR LES PRECAUTIONS A PRENDRE POUR LE RACCORDEMENT DES ENTREES
VOIR LE MANUEL D'UTILISATION MRS4-2 PARAGRAPHE :
"ASSERVISSEMENT ET COMMANDES EXTERNES"

SETTING 1 OR 2 SELECTION

- Configuration P18 value 3

- The controle must be connected to terminals 2 and 4 connector J2 main card.
(contact must be polarity free and of good quality)
- Contact open-->SETTING 1 operation
- Contact closed-->SETTING 2 operation

WATER POMP CONTROL

- The pump control must be connected to terminals 4 and 5 on connector J8 of main card.

(relay 230V 8 Amp.)

FORCED STAGES CONTROL

- Configuration P16 value 2

- The control of the various stages is made by an external control connected to the connector J2 of the main card.
(contact must be polarity free and of good quality)
- According to the number of stages, connection of NO (normally open) contacts is sufficient.

CAUTION

TO TAKE PRECAUTION FOR CLIENT'S CONNECTION OF INPUTS
SEE THE OPERATING AND MAINTENANCE INSTRUCTIONS OF
MICROCIAT MRS4-2 PARAGRAPHE :
"SERVO CONTROL AND EXTERNAL CONTROLS"

AUSWAHL SOLLWERT 1 ODER 2

- Konfiguration P18 Wert 3

- Der Kontakt wird an den Klemmen 2 und 4 am Stecker J2 der Hauptplatine angeschlossen.
(Kontakt unbedingt potentialfrei anschliessen)
- Kontakt offen-->Sollwert 1
- Kontakt geschlossen-->Sollwert 2

PUMPENSTEUERUNG

- Der Kontakt wird an den Klemmen 4 und 5 am Stecker J8 der Hauptplatine angeschlossen.

(Relais 230V 8 Amp)

EXTERNERBETRIEB DER STUFEN

- Konfiguration P16 Wert 2

- Die Regelung der verschiedenen Stufen wird mit einem externen Kontakt am Stecker J2 der Hauptplatine hergestellt.
(Kontakt unbedingt potentialfrei anschliessen)
- Die Zuverdrahtende Kontaktanzahl ist von der Stufenanzahl abhängig.

ACHTUNG

Um Anschlussfehler zu vermeiden, unbedingt die Betriebs- und Wartungsanleitung MRS4-2 Abschnitt Regelung und externe Regelung beachten.

J
I
H
G
F
E
D
C

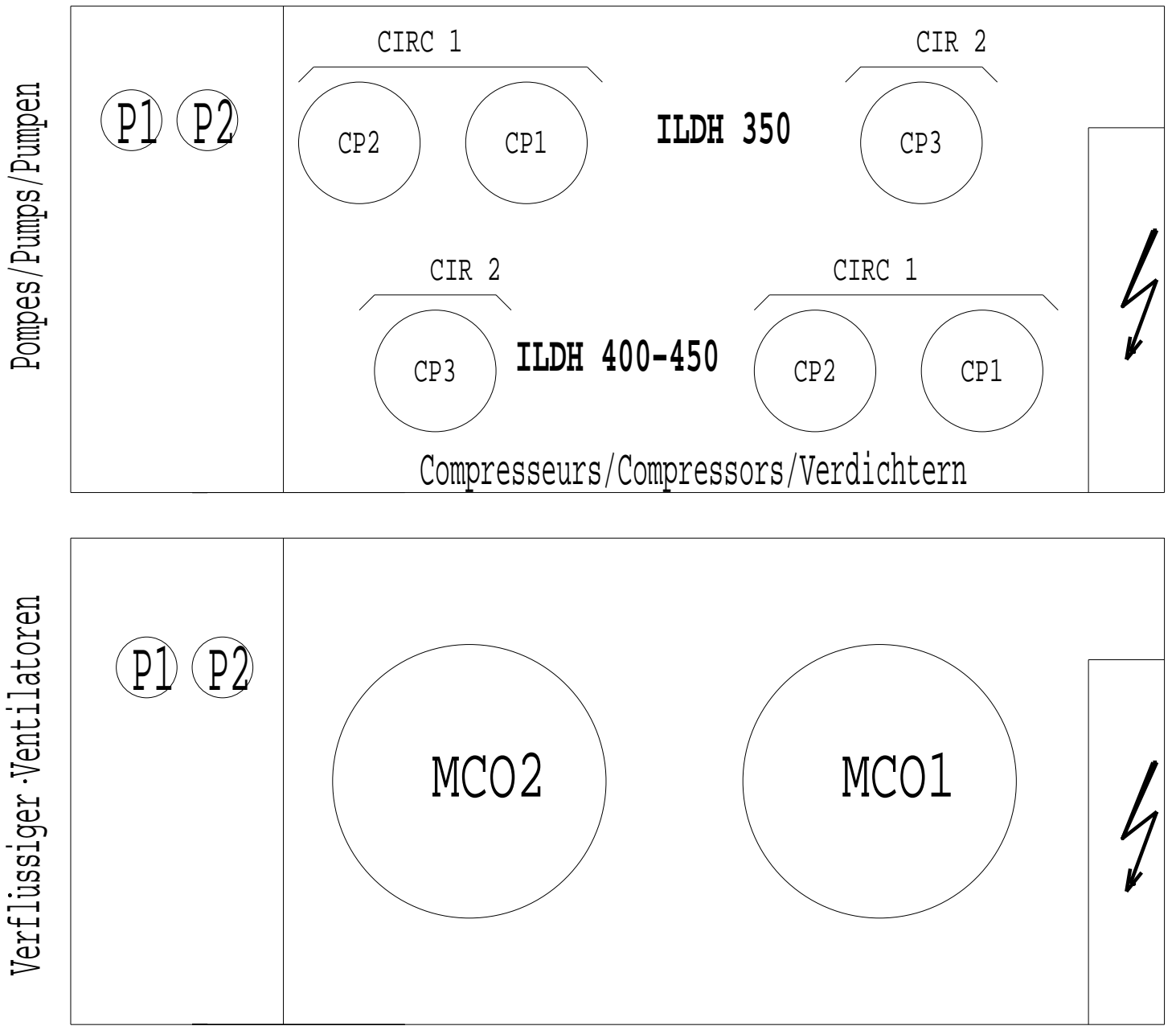

MODIFIE PAR: MODIFIED BY: GEANDERT DURCH:		INDICE INDEX KENNZIFFER		DATE DATE DATUM		APPAREIL OU UNITE/UNIT/GERAT ODER EINHEIT ILDH 350 A 450	
PG		33		07-07-00		SPECIFICATION/SPECIFICATION/SPEZIFIZIERUNG 3 COMPRESSEURS 2 CIRCUITS MRS3 3 COMPRESSORS 2 CIRCUITS 3 VERDICHTERN 2 KREISLAUFE	
MODIFICATION A RAJOUTE 1 BORNE ET RENUMEROTE FILS ET BORNES			LEGENDE/LEGEND/LEGENDE 3950010.36				
REMPLACE/TAKE/ERSETZT		REMPLACE PAR/TAKE BY/ERSETZT DURCH		CLIENT/CLIENT/KUNDE		REFERENCE/REFERENCE/REFERENZ	
						CREATEUR: CREATOR: HERSTELLER:	
						PG	
						DATE: DATE: DATUM:	
						17-05-99	
REFERENCES COMMANDE/ORDER REFERENCES/AUFTRAGSREFERENZ				DEMARRAGE/START/ANLAUF		TENSION/VOLTAGE/SPANNUNG	
						COMPAGNIE INDUSTRIELLE D'APPLICATIONS THERMIQUES	
						FOLIO/FOLIO/SEITE 1 / 7	
						NUMERO DE SCHEMA/DRAWING NUMBER/PLAN NR 3980918	
						INDICE/INDEX/KENNZIFFER 33	

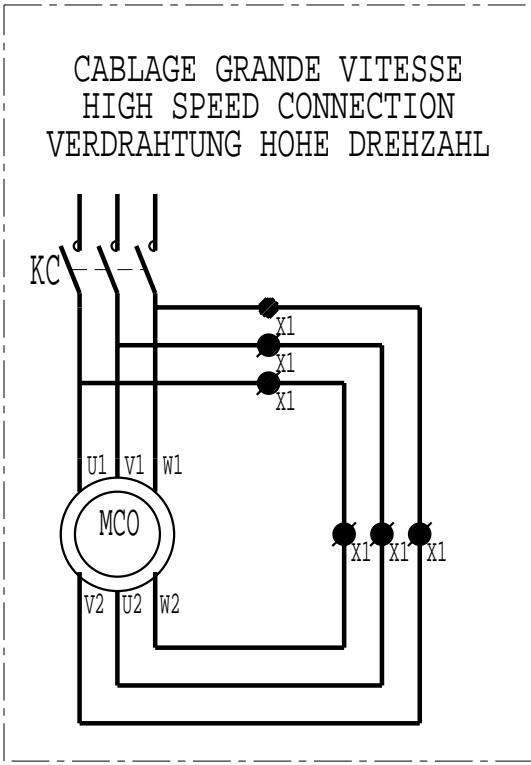
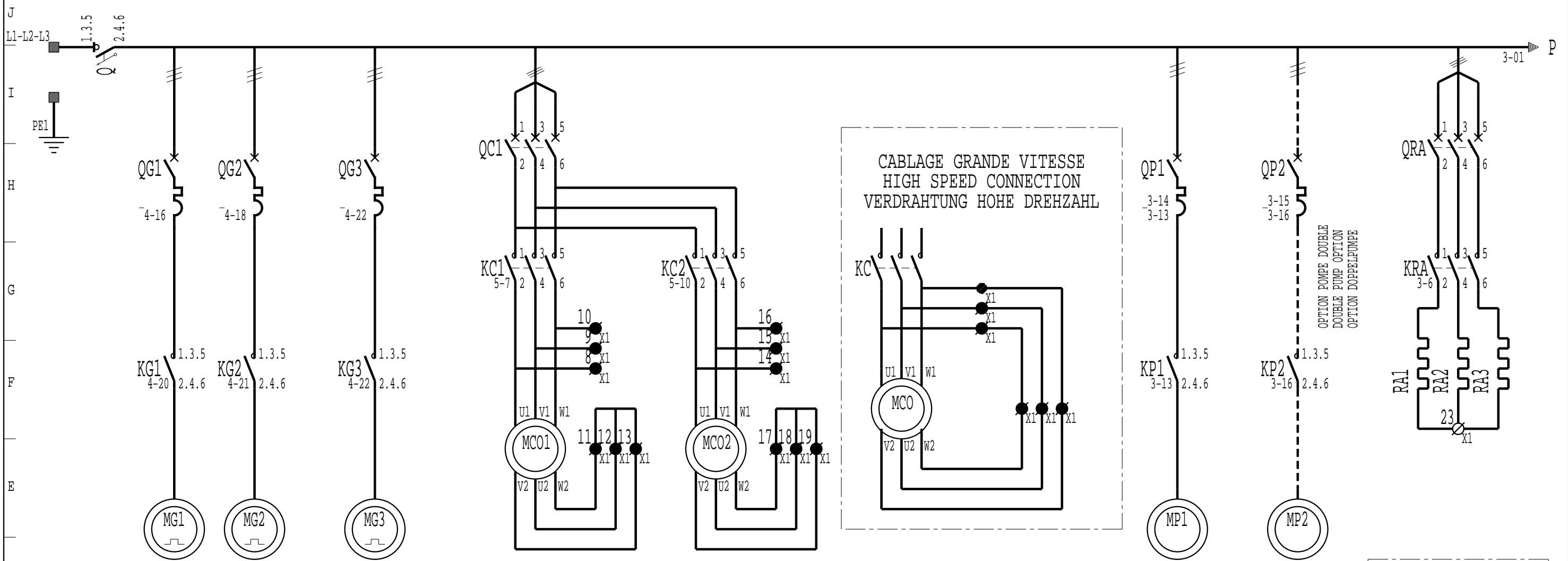

	Puissance en CV des compresseurs Compressors nominal output Hp Verdichterleistung in PS		
ILDH	CP1	CP2	CP3
350	10	10	15
400	15	15	10
450	15	15	15

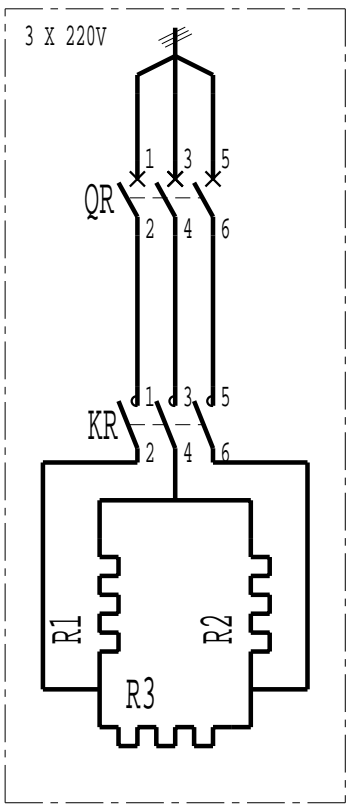

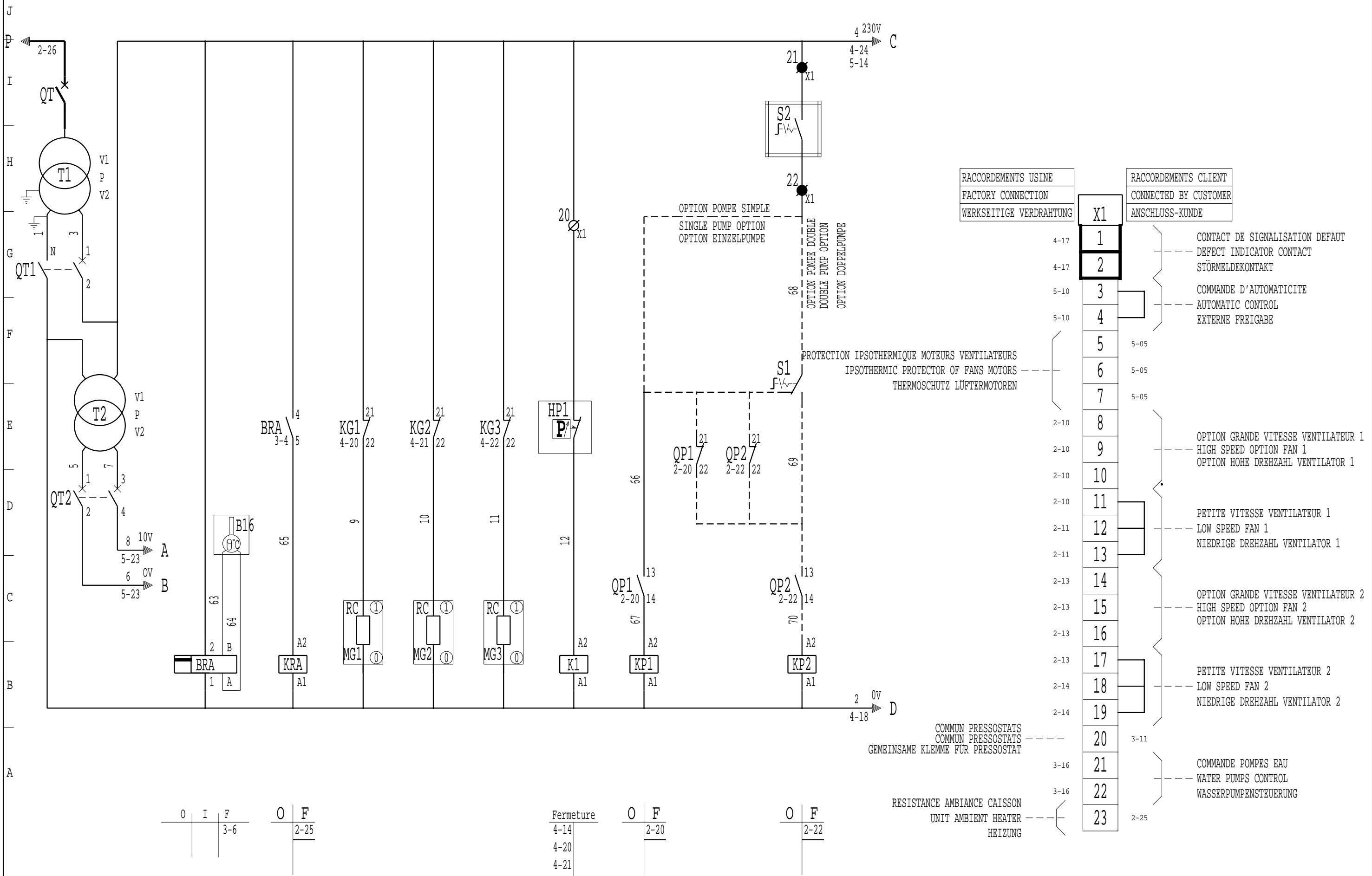

RACCORDEMENTS USINE
FACTORY CONNECTION
WERKSEITIGE VERDRAHTUNG

RACCORDEMENTS CLIENT
CONNECTED BY CUSTOMER
ANSCHLUSS-KUNDE

Terminal	Client Connection	Description
1	1	CONTACT DE SIGNALISATION DEFAULT
2	2	DEFECT INDICATOR CONTACT
3	3	STÖRMELDEKONTAKT
4	4	COMMANDE D'AUTOMATICITE
5	5	AUTOMATIC CONTROL
6	6	EXTERNE FREIGABE
7	7	
8	8	
9	9	OPTION GRANDE VITESSE VENTILATEUR 1
10	10	HIGH SPEED OPTION FAN 1
11	11	OPTION HOHE DREHZAHL VENTILATOR 1
12	12	
13	13	PETITE VITESSE VENTILATEUR 1
14	14	LOW SPEED FAN 1
15	15	NIEDRIGE DREHZAHL VENTILATOR 1
16	16	
17	17	OPTION GRANDE VITESSE VENTILATEUR 2
18	18	HIGH SPEED OPTION FAN 2
19	19	OPTION HOHE DREHZAHL VENTILATOR 2
20	20	
21	21	COMMANDE POMPES EAU
22	22	WATER PUMPS CONTROL
23	23	WASSERPUMPENSTEUERUNG

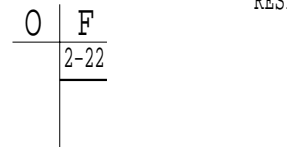
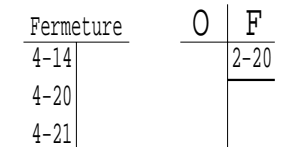
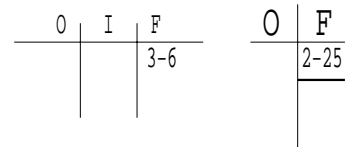

J
I
H
G
F
E
D
C
B
A

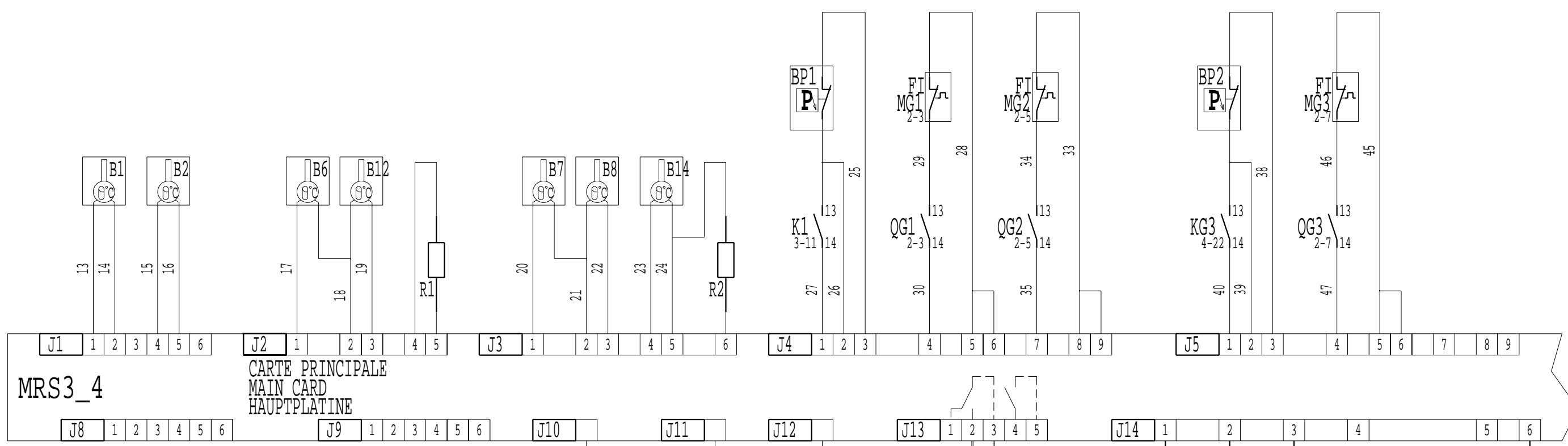

MRS3_4

CARTE PRINCIPALE
MAIN CARD
HAUPTPLATINE

MRS3_4	
B1	Sonde entree eau glatee Inlet chilled water sensor Fühler Kaltwassereintritt
B2	Sonde sortie evaporateur N 1 Evaporator N 1 outlet sensor Austrittsfühler Verdampfer N1
B6	Sonde air exterieur External air sensor Aussenluftfühler
B7	Sonde refolement circuit 1 Circuit N 1 discharge sensor Heissgasfühler Kreislauf 1
B8	Sonde refolement circuit 2 Circuit N 2 discharge sensor Heissgasfühler Kreislauf 2
B12	Sonde N 1 degivrage circuit 1 Circuit 1 defrosting sensor N 1 Fühler N 1 Abtaung Kreislauf 1
B13	Sonde N 2 degivrage circuit 1 Circuit 1 defrosting sensor N 2 Fühler N 2 Abtaung Kreislauf 1
B14	Sonde N 1 degivrage circuit 2 Circuit 2 defrosting sensor N 1 Fühler N 1 Abtaung Kreislauf 2
B15	Sonde N 2 degivrage circuit 2 Circuit 2 defrosting sensor N 2 Fühler N 2 Abtaung Kreislauf 2

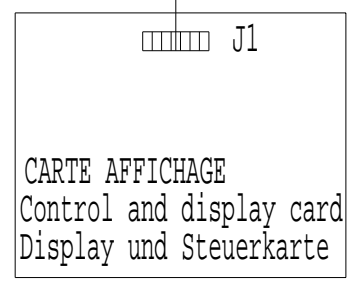

	HP - BP		
	PENN P77	RANCO 016	MINI
BP	3 2	4 2	4 2
AUTO	1	1	1
HP	3 2	2 4	2 4
MANU	1	1	1
HP	2 3	4 2	2 4
AUTO	1	1	1

OPTION A MRS

INTERFACE RX-TX
(RS485-4 fils)

INTERFACE RX-TX
(RS485-4 WIRES)

ANSCHLUSS INTERFACE RX-TX
(RS485 - 4 ADERN)

OPTION B MRS

CAD-RELAYAGE-PC
(RS485-2 fils)

INTERFACE RX-TX
(RS485-2 WIRES)

ANSCHLUSS CAD-RELAIS-PC
(RS485 - 2 ADERN)

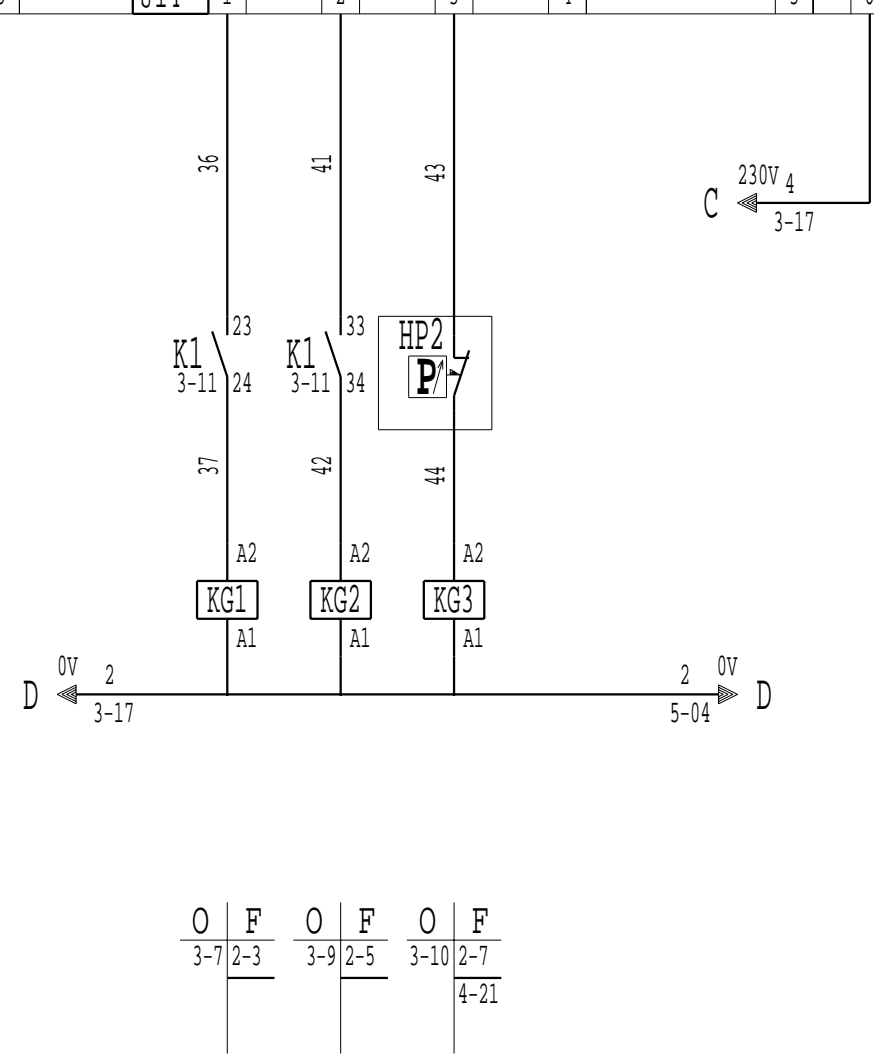

J
I
H
G
F
E
D
C
B
A

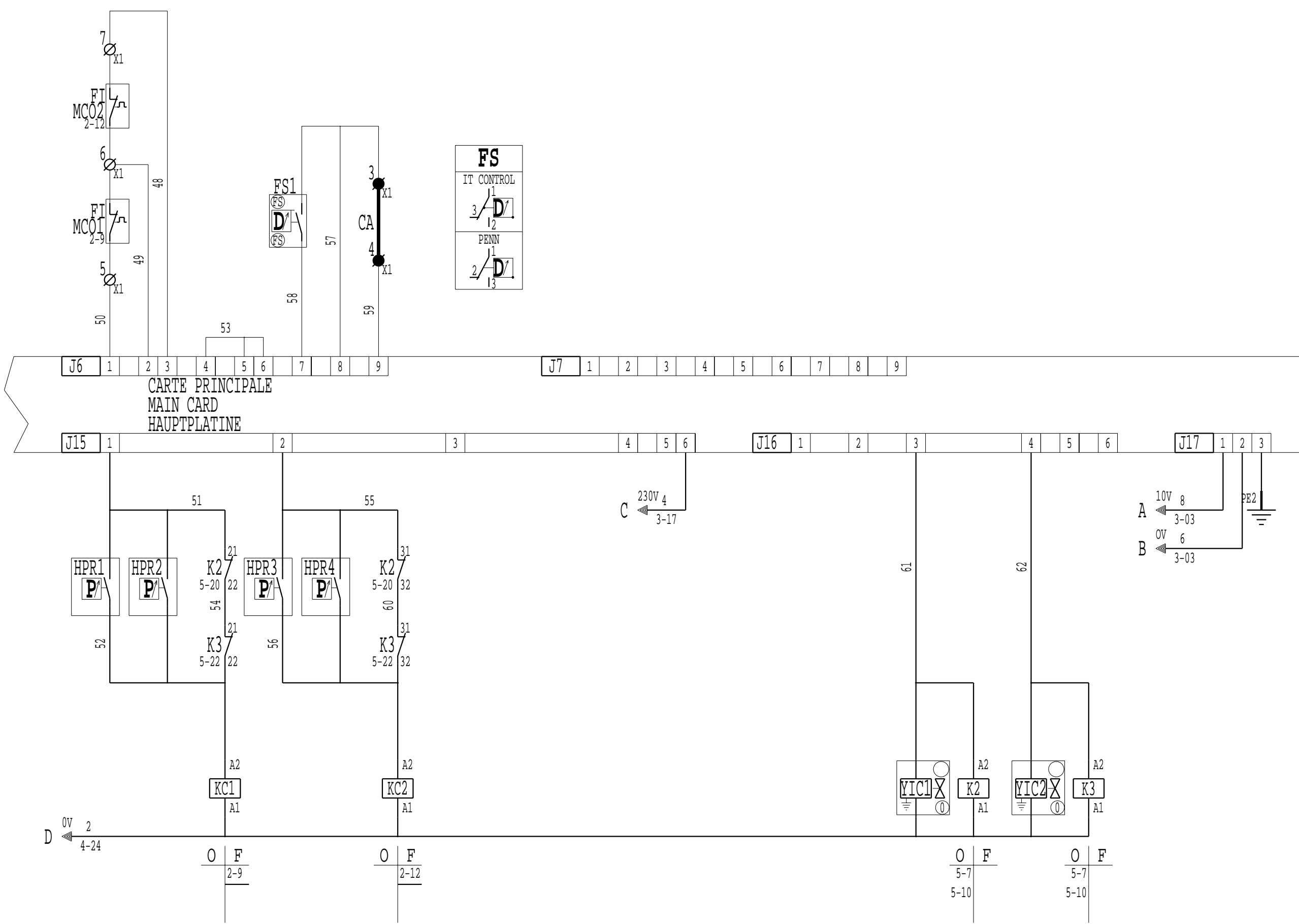

J
I
H
G
F
E
D
C
B
A

DEFAUT GENERAL

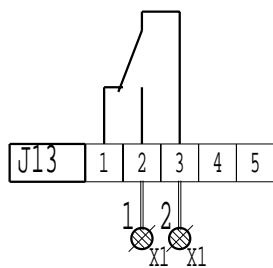

- Raccorder la signalisation du défaut général du groupe sur les bornes 1 et 2 du bornier X1.

(relais 230 v 8 Amp contact au travail)

COMMANDE D'AUTOMATICITE

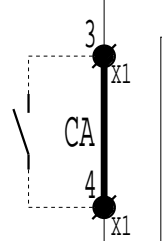
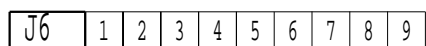

- Enlever le pont "CA" entre les bornes 3 et 4 du bornier X1, et y raccorder un contact .
(contact libre de toute polarité et de bonne qualité)
- Contact ouvert-->groupe à l'arrêt
- Contact fermé-->groupe autorisé à fonctionner

FONCTIONNEMENT EN PUISSANCE MAXI

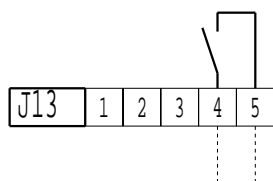

- Raccorder la signalisation de fonctionnement du groupe en puissance maxi sur les bornes 4 et 5 du connecteur J13 carte principale.
(relais 230V 8 Amp.)

COMMANDE CHAUFFAGE ADDITIONNEL

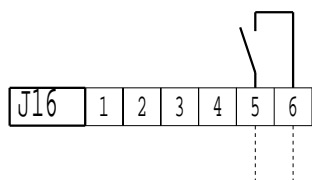

- Raccorder la commande de chauffage sur les bornes 5 et 6 du connecteur J16 carte principale.
(relais 230V 8 Amp.)

SELECTION CHAUD/FROID

- Configuration P17 valeur 3

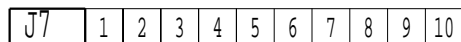

- Raccorder un contact sur les bornes 1 et 2 du connecteur J7 carte principale.
(contact libre de toute polarité et de bonne qualité)
- Contact ouvert-->fonctionnement FROID
- Contact fermé-->fonctionnement CHAUD

GENERAL FAULT

- The fault or not-fault information on the unit can be recover on terminals 1 and 2 connector X1.

(relay 230V 8 Amp.)

AUTOMATIC CONTROL

- The shunt "CA" on terminals 3 and 4 of connector X1, must be lifted and the contact connected.
(contact must be polarity free and of good quality)
- Contact open-->unit off-line
- Contact closed-->unit on-line

MAXIMUM OUTPUT OPERATION

- The controle device must be connected to terminals 4 and 5 on connector J13 of main card.

(relay 230V 8 Amp.)

ADDITIONNAL HEATING CONTROL

- The controle must be connected to terminals 5 and 6 on connector J16 of main card.

(relay 230V 8 Amp.)

HEATING/COOLING SELECTION

- Configuration P17 value 3

- The controle device must be connected to terminals 1 and 2 on connector J7 of main card.
(contact must be polarity free and of good quality)
- Contact open-->COOLING operation
- Contact closed-->HEATING operation

MRS3

SAMMELSTÖRMELDUNG

- Die Störungsmeldung wird an den Klemmen 1 und 2 der anschlusse X1 abgenommen.

(Relais 230V 8 Amp)

EXTERNE FREIGABE

- Die Brücke "CA" an den Klemmen 3 und 4 am Anschluss X1 entfernen und externen Kontakt anschliessen.
(Kontakt unbedingt potentialfrei anschliessen)
- Kontakt offen-->Gerät abgeschaltet
- Kontakt geschlossen-->Gerät Betriebsbereit

MAXIMALE LEISTUNG

- Der Kontakt wird an den Klemmen 4 und 5 am Stecker J13 der Hauptplatine angeschlossen.

(Relais 230V 8 Amp)

ZUSATZHEIZUNG

- Der Kontakt wird an den Klemmen 5 und 6 am Stecker J16 der Hauptplatine angeschlossen.

(Relais 230V 8 Amp)

AUSWAHL HEIZ-O.KUHLBETRIEB

- Konfiguration P17 Wert 3

- Der Kontakt wird an den Klemmen 1 und 2 am Stecker J7 der Hauptplatine angeschlossen.
(Kontakt unbedingt potentialfrei anschliessen)
- Kontakt offen-->Kühlbetrieb
- Kontakt geschlossen-->Heizbetrieb

MRS3

SELECTION CONSIGNE 1 ou 2

- Configuration P18 valeur 3

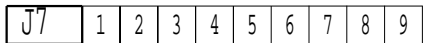

- Raccorder un contact entre les bornes 2 et 3 du connecteur J7 carte principale. (contact libre de toute polarité et de bonne qualité)
- Contact ouvert-->CONSIGNE 1
- Contact fermé-->CONSIGNE 2

FONCTION DE DELESTAGE

- Configuration P37 valeur 1

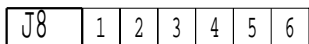

- Raccorder un contact entre les bornes 1 et 2 du connecteur J8 carte principale. (contact libre de toute polarité et de bonne qualité)
- Contact ouvert-->fonctionnement normal
- Contact fermé-->fonctionnement avec délestage

COMMANDE DES ETAGES FORCES

- Configuration P16 valeur 2

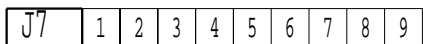

- Raccorder les contacts sur chaque entrée pour commander les différents étages (contact libre de toute polarité et de bonne qualité)
- Suivant le nombre d'étages, il suffit de raccorder des contacts à fermeture.

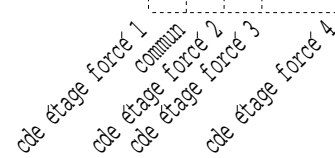

COMMANDE DE POMPE

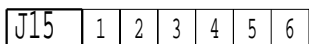

- Raccorder l'alimentation de la pompe entre la borne 5 du connecteur J15 carte principale et la borne 6 du bornier X1

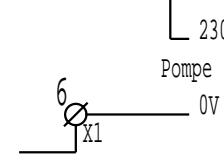

PRECAUTIONS DE RACCORDEMENT

POUR LES PRECAUTIONS A PRENDRE POUR LE RACCORDEMENT DES ENTRES VOIR LE MANUEL D'UTILISATION MRS3-4 PARAGRAPHE : "ASSERVISSEMENT ET COMMANDES EXTERNES"

SETTING 1 OR 2 SELECTION

- Configuration P18 value 3

- The controle must be connected to terminals 2 and 3 connector J7 main card. (contact must be polarity free and of good quality)
- Contact open-->SETTING 1 operation
- Contact closed-->SETTING 2 operation

LOAD SHEDDING

- Configuration P37 value 1

- The controle must be connected to terminals 1 and 2 connector J8 main card. (contact must be polarity free and of good quality)
- Contact open-->normal running
- Contact closed-->shedding

FORCED STAGES CONTROL

- Configuration P16 value 2

- The control of the various stages is made by an external control connected to the connector J7 of the main card. (contact must be polarity free and of good quality)
- According to the number of stages, connection of NO (normally open) contacts is sufficient.

PUMP CONTROL

- The pump control must be connected between terminal 5 on connector J15 of main card and terminal 6 of connector X1

CAUTION

TO TAKE PRECAUTION FOR CLIENT'S CONNECTIONS OF INPUTS SEE THE OPERATING AND MAINTENANCE INSTRUCTIONS OF MICROCIAT MRS3-4 PARAGRAPHE : "SERVO CONTROL AND EXTERNAL CONTROLS"

AUSWAHL SOLLWERT 1 ODER 2

- Konfiguration P18 wert 3

- Der Kontakt wird an den Klemmen 2 und 3 am Stecker J7 der Hauptplatine angeschlossen. (Kontakt unbedingt potentialfrei anschliessen)
- Kontakt offen-->Sollwert 1
- Kontakt geschlossen-->Sollwert 2

ENTLASTUNG

- Konfiguration P37 wert 1

- Der Kontakt wird an den Klemmen 1 und 2 am Stecker J8 der Hauptplatine angeschlossen. (Kontakt unbedingt potentialfrei anschliessen)
- Kontakt offen-->Normalbetrieb
- Kontakt geschlossen-->Entlastungsbetrieb

EXTERNERBETRIEB DER STUFEN

- Konfiguration P16 Wert 2

- Die Regelung der verschiedenen Stufen wird mit einem externen Kontakt am Stecker J7 der Hauptplatine hergestellt. (Kontakt unbedingt potentialfrei anschliessen)
- Die Zuverdrahtende Kontaktanzahl ist von der Stufenanzahl abhängig.

PUMPENSTEUERUNG

- Der Kontakt wird an den Klemmen 5 am Stecker J15 der Hauptplatine und den Klemmen 6 der Stecker X1 angeschlossen.

ACHTUNG

Um kundenseitige Anschlussfehler zu vermeiden, die Betriebs- und Wartungsanleitung MRS 3-4 Abschnitt Regelung und externe Regelung beachten.

J
I
H
G
F
E
D
C

Pompes / Pumps / Pumpen

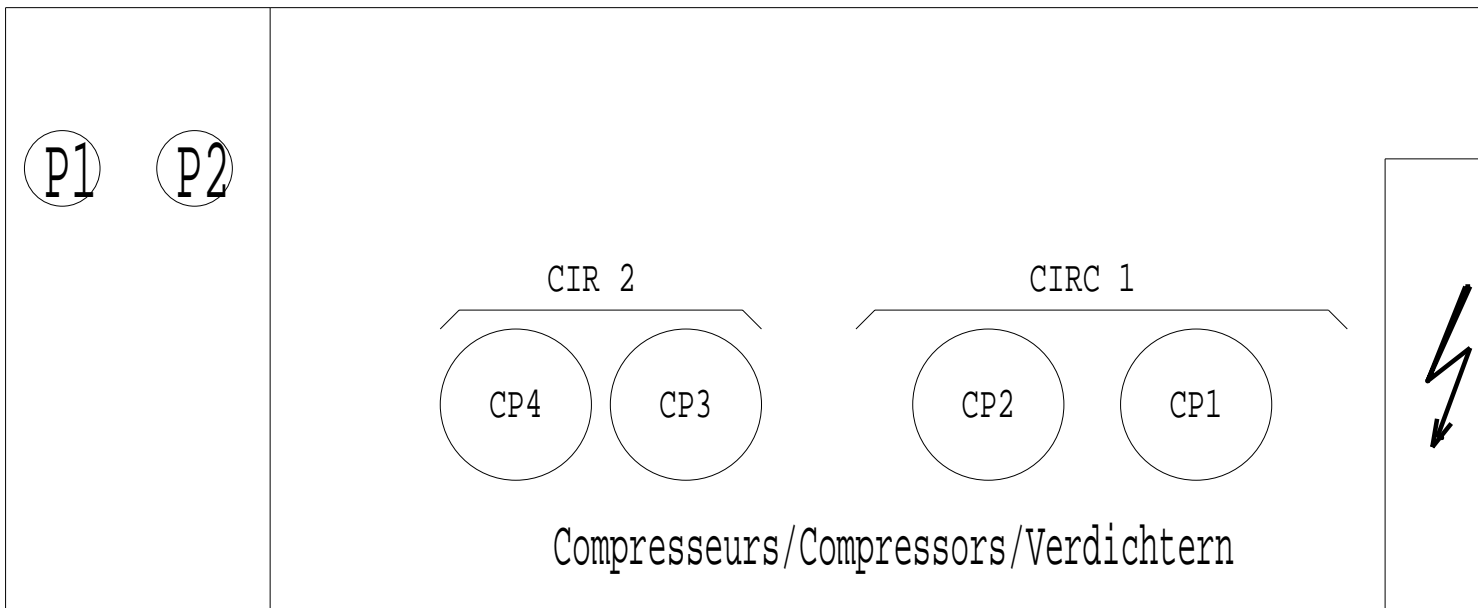

Ventilateurs Condenseur
Fans Condensor
Verflüssiger Ventilatoren

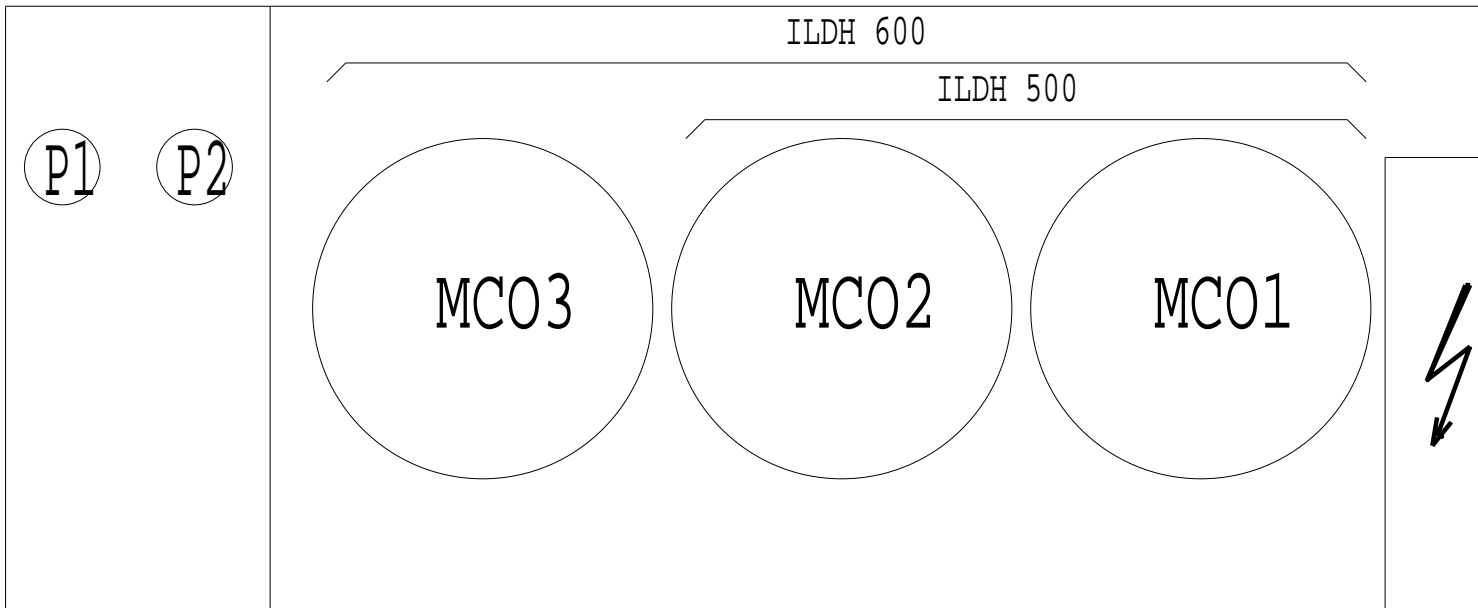

MODIFIE PAR: MODIFIED BY: GEANDERT DURCH:		INDICE INDEX KENNZIFFER		DATE DATE DATUM		APPAREIL OU UNITE/UNIT/GERAT ODER EINHEIT	
PG		33		10-07-00		ILDH 500 600	
MODIFICATION A RAJOUTE 1 BORNE ET RENUMEROTE FILS ET BORNES				LEGENDE/LEGEND/LEGENDE 3950010.36		SPECIFICATION/SPECIFICATION/SPEZIFIZIERUNG 4 COMPRESSEURS 2 CIRCUITS MRS3 4 COMPRESSORS 2 CIRCUITS 4 VERDICHTERN 2 KREISLAUFE	
REPLACE/TAKE/ERSETZT		REPLACE PAR/TAKE BY/ERSETZT DURCH		CLIENT/CLIENT/KUNDE		REFERENCE/REFERENCE/REFERENZ	
						CREATEUR: CREATOR: PG HERSTELLER:	
						DATE: DATE: 12-05-99 DATUM:	
REFERENCES COMMANDE/ORDER REFERENCES/AUFTRAGSREFERENZ				DEMARRAGE/START/ANLAUF		TENSION/VOLTAGE/SPANNUNG	
						COMPAGNIE INDUSTRIELLE D'APPLICATIONS THERMIQUES	
							
						FOLIO/FOLIO/SEITE 1 / 7	
						NUMERO DE SCHEMA/DRAWING NUMBER/PLAN NR 3980917	
						INDICE/INDEX/KENNZIFFER 33	

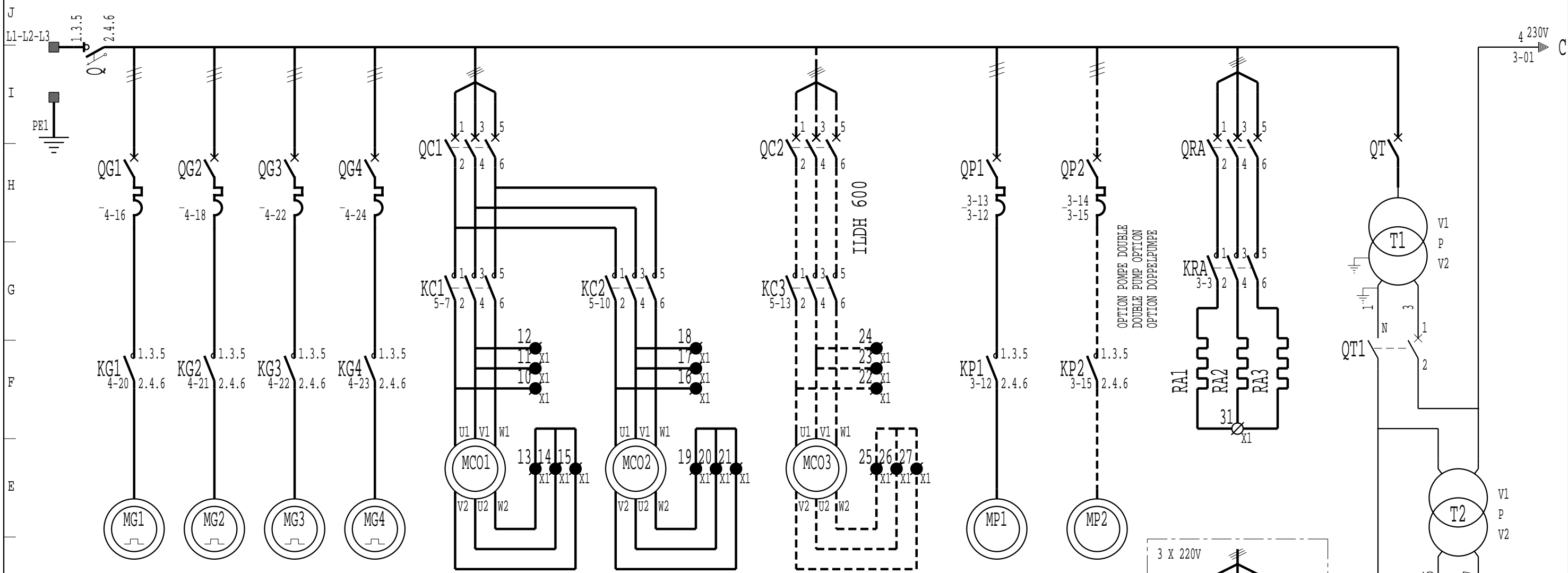

Puissance en CV
des compresseurs
Compressors nominal
output HP
Verdichterleistung in PS

ILDH	CP1	CP2	CP3	CP4
500	15	15	10	10
600	15	15	15	15

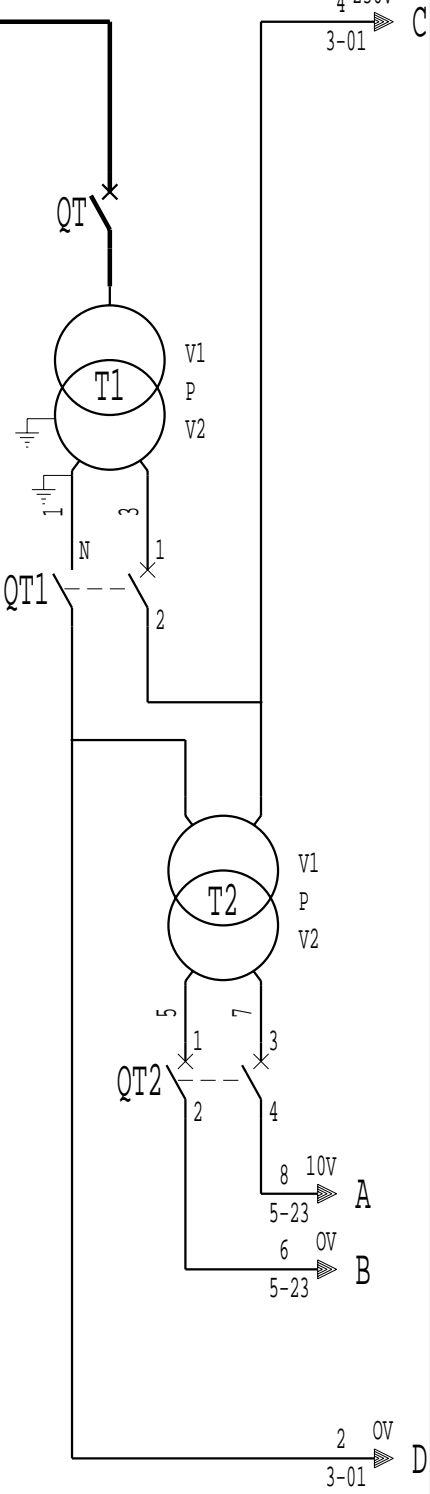
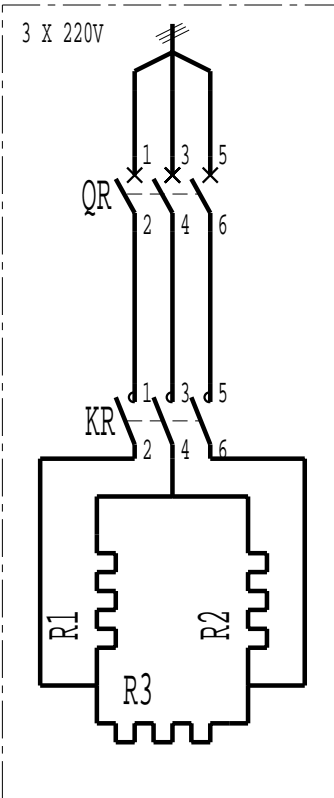
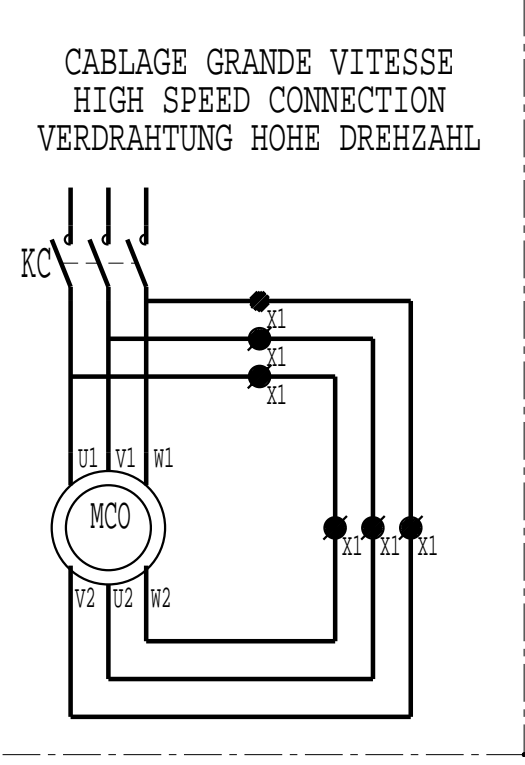

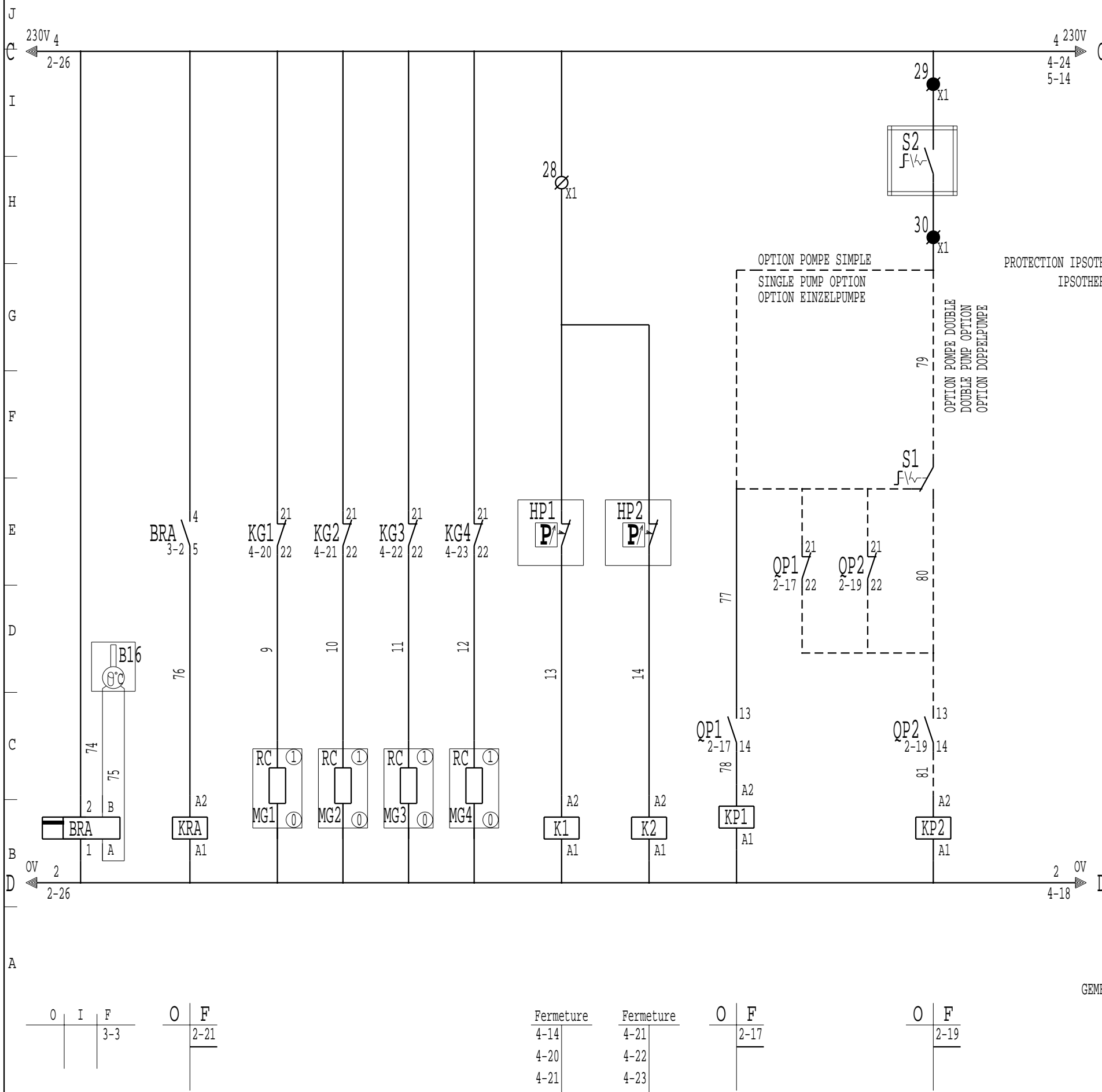

RACCORDEMENTS USINE
FACTORY CONNECTION
WERKSEITIGE VERDRÄHTUNG

RACCORDEMENTS CLIENT
CONNECTED BY CUSTOMER
ANSCHLUSS-KUNDE

4-17	1	}	CONTACT DE SIGNALISATION DEFAULT
4-17	2		DEFECT INDICATOR CONTACT
5-10	3	}	COMMANDE D'AUTOMATICITE
5-10	4		AUTOMATIC CONTROL
	5	}	EXTERNE FREIGABE
5-05	6		
5-05	7	}	PROTECTION IPSOTHERMIQUE MOTEURS VENTILATEURS
5-05	8		IPSOTHERMIC PROTECTOR OF FANS MOTORS
5-07	9	}	THERMOSCHUTZ LÜFTERMOTOREN
5-07	10		
2-09	11	}	OPTION GRANDE VITESSE VENTILATEUR 1
2-09	12		HIGH SPEED OPTION FAN 1
2-09	13	}	OPTION HOHE DREHZAHL VENTILATOR 1
2-09	14		
2-10	15	}	PETITE VITESSE VENTILATEUR 1
2-10	16		LOW SPEED FAN 1
2-12	17	}	NIEDRIGE DREHZAHL VENTILATOR 1
2-12	18		
2-12	19	}	OPTION GRANDE VITESSE VENTILATEUR 2
2-12	20		HIGH SPEED OPTION FAN 2
2-12	21	}	OPTION HOHE DREHZAHL VENTILATOR 2
2-12	22		
2-13	23	}	PETITE VITESSE VENTILATEUR 2
2-13	24		LOW SPEED FAN 2
2-15	25	}	NIEDRIGE DREHZAHL VENTILATOR 2
2-15	26		
2-15	27	}	OPTION GRANDE VITESSE VENTILATEUR 3
2-15	28		HIGH SPEED OPTION FAN 3
2-15	29	}	OPTION HOHE DREHZAHL VENTILATOR 3
2-15	30		
2-16	31	}	PETITE VITESSE VENTILATEUR 3
2-16	32		LOW SPEED FAN 3
3-09	33	}	NIEDRIGE DREHZAHL VENTILATOR 3
3-09	34		
3-15	35	}	COMMUN PRESSOSTATS
3-15	36		COMMON PRESSOSTATS
3-15	37	}	GEMEINSAME KLEMME FÜR PRESSOSTAT
3-15	38		
3-15	39	}	COMMANDE POMPES EAU
3-15	40		WATER PUMPS CONTROL
3-15	41	}	WASSERPUMPENSTEUERUNG
3-15	42		
2-21	43	}	RESISTANCE AMBIANCE CAISSON
2-21	44		UNIT AMBIENT HEATER
2-21	45	}	HEIZUNG
2-21	46		

J
I
H
G
F
E
D
C
B
A

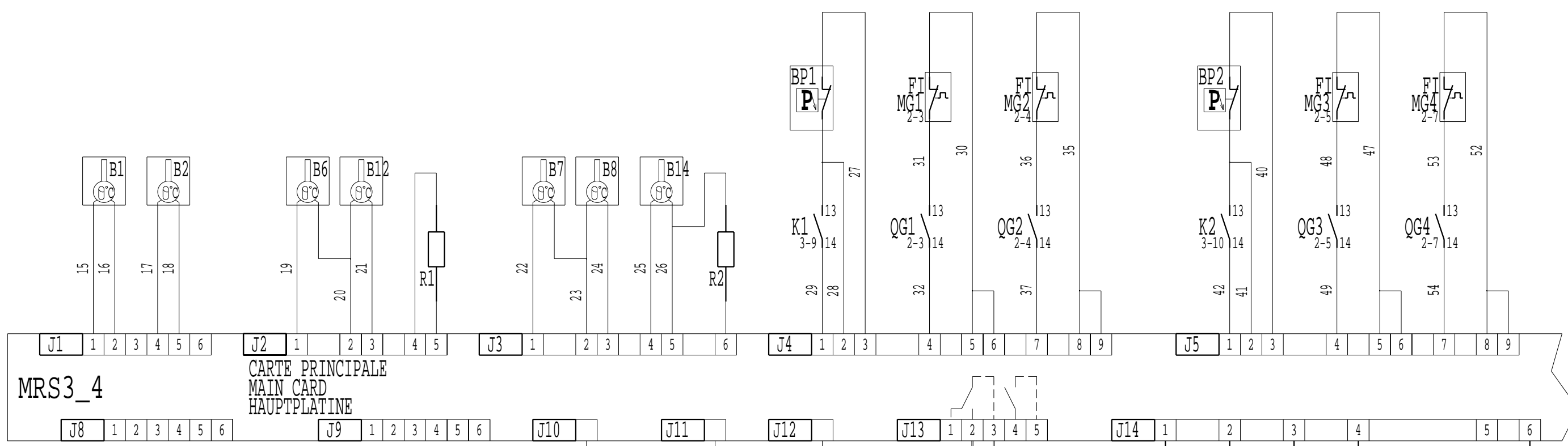

MRS3_4

CARTE PRINCIPALE
MAIN CARD
HAUPTPLATINE

MRS3_4	
B1	Sonde entree eau glatee Inlet chilled water sensor Fühler Kaltwassereintritt
B2	Sonde sortie evaporateur N 1 Evaporator N 1 outlet sensor Austrittsfühler Verdampfer N1
B6	Sonde air exterieur External air sensor Aussenluftfühler
B7	Sonde refolement circuit 1 Circuit N 1 discharge sensor Heissgasfühler Kreislauf 1
B8	Sonde refolement circuit 2 Circuit N 2 discharge sensor Heissgasfühler Kreislauf 2
B12	Sonde N 1 degivrage circuit 1 Circuit 1 defrosting sensor N 1 Fühler N 1 Abtaung Kreislauf 1
B13	Sonde N 2 degivrage circuit 1 Circuit 1 defrosting sensor N 2 Fühler N 2 Abtaung Kreislauf 1
B14	Sonde N 1 degivrage circuit 2 Circuit 2 defrosting sensor N 1 Fühler N 1 Abtaung Kreislauf 2
B15	Sonde N 2 degivrage circuit 2 Circuit 2 defrosting sensor N 2 Fühler N 2 Abtaung Kreislauf 2



CARTE AFFICHAGE
Control and display card
Display und Steuerkarte

	HP - BP		
	PENN P77	RANCO 016	MINI
BP	3 2	4 2	4 2
AUTO	1	1	1
HP	3 2	2 4	2 4
MANU	1	1	1
HP	2 3	4 2	2 4
AUTO	1	1	1

OPTION A MRS

INTERFACE RX-TX
(RS485-4 fils)

INTERFACE RX-TX
(RS485-4 WIRES)

ANSCHLUSS INTERFACE RX-TX
(RS485 - 4 ADERN)

OPTION B MRS

CAD-RELAYAGE-PC
(RS485-2 fils)

INTERFACE RX-TX
(RS485-2 WIRES)

ANSCHLUSS CAD-RELAIS-PC
(RS485 - 2 ADERN)

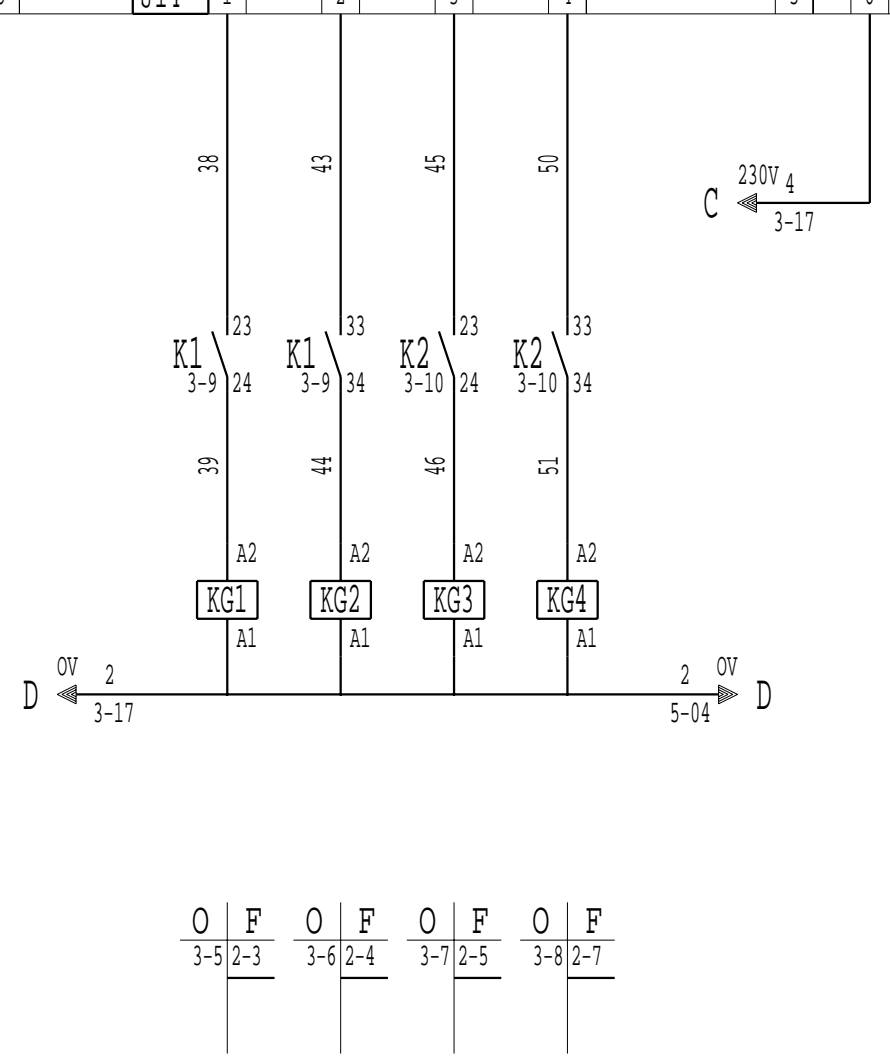

J
I
H
G
F
E
D
C
B
A

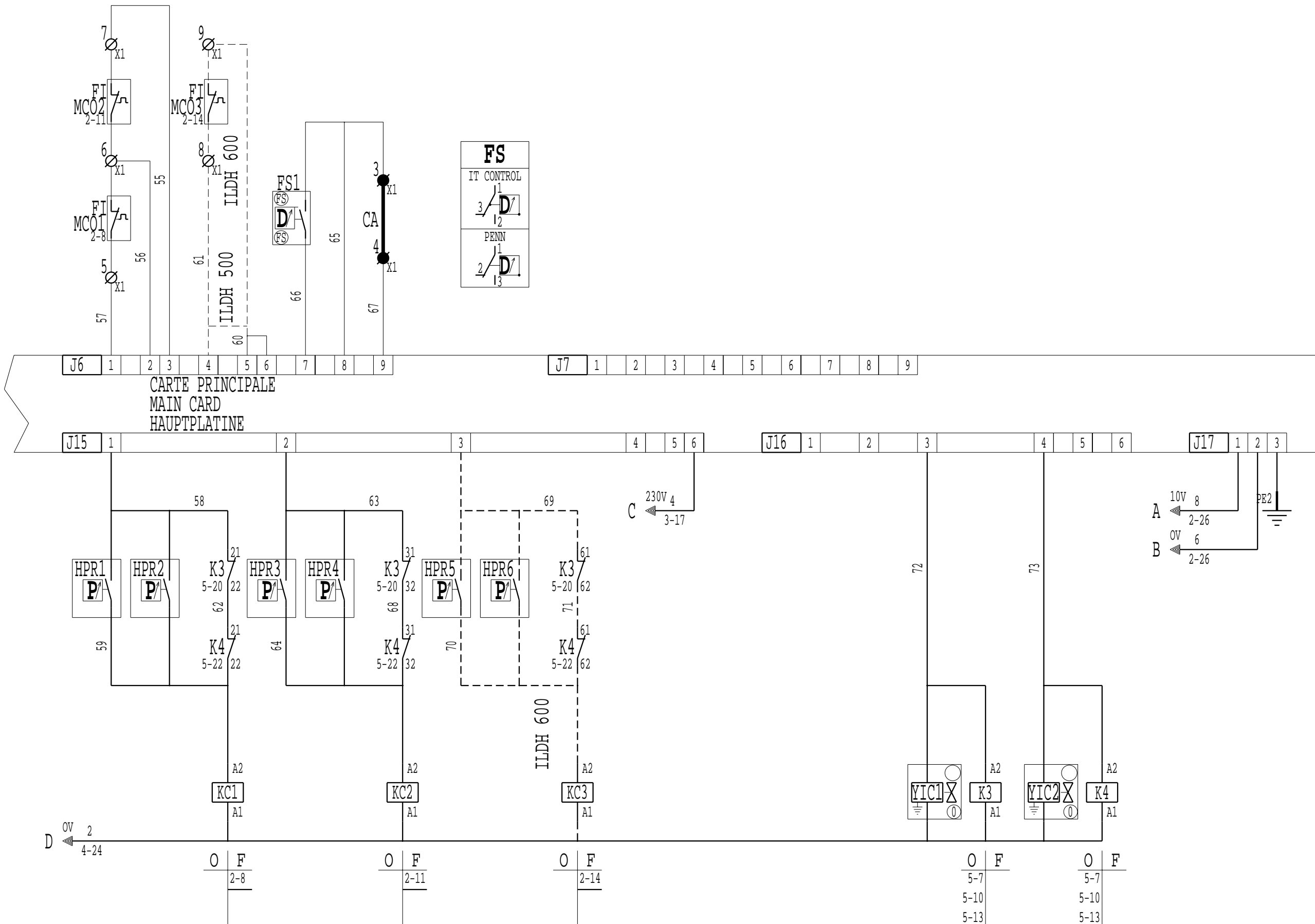

J
I
H
G
F
E
D
C
B
A

DEFAUT GENERAL

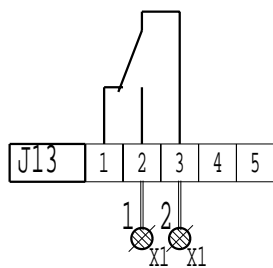

- Raccorder la signalisation du défaut général du groupe sur les bornes 1 et 2 du bornier X1.

(relais 230 v 8 Amp contact au travail)

COMMANDE D'AUTOMATICITE

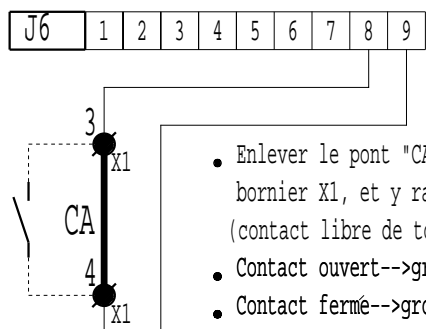

- Enlever le pont "CA" entre les bornes 3 et 4 du bornier X1, et y raccorder un contact . (contact libre de toute polarité et de bonne qualité)
- Contact ouvert-->groupe à l'arrêt
- Contact fermé-->groupe autorisé à fonctionner

FONCTIONNEMENT EN PUISSANCE MAXI

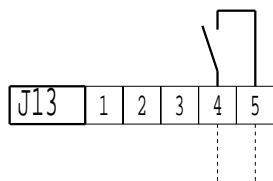

- Raccorder la signalisation de fonctionnement du groupe en puissance maxi sur les bornes 4 et 5 du connecteur J13 carte principale. (relais 230V 8 Amp.)

COMMANDE CHAUFFAGE ADDITIONNEL

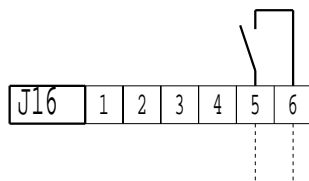

- Raccorder la commande de chauffage sur les bornes 5 et 6 du connecteur J16 carte principale. (relais 230V 8 Amp.)

SELECTION CHAUD/FROID

- Configuration P17 valeur 3

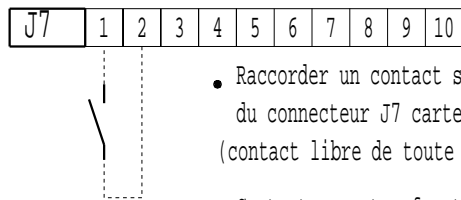

- Raccorder un contact sur les bornes 1 et 2 du connecteur J7 carte principale. (contact libre de toute polarité et de bonne qualité)
- Contact ouvert-->fonctionnement FROID
- Contact fermé-->fonctionnement CHAUD

GENERAL FAULT

- The fault or not-fault information on the unit can be recover on terminals 1 and 2 connector X1.

(relay 230V 8 Amp.)

AUTOMATIC CONTROL

- The shunt "CA" on terminals 3 and 4 of connector X1, must be lifted and the contact connected. (contact must be polarity free and of good quality)
- Contact open-->unit off-line
- Contact closed-->unit on-line

MAXIMUM OUTPUT OPERATION

- The controle device must be connected to terminals 4 and 5 on connector J13 of main card.

(relay 230V 8 Amp.)

ADDITIONNAL HEATING CONTROL

- The controle must be connected to terminals 5 and 6 on connector J16 of main card.

(relay 230V 8 Amp.)

HEATING/COOLING SELECTION

- Configuration P17 value 3

- The controle device must be connected to terminals 1 and 2 on connector J7 of main card. (contact must be polarity free and of good quality)
- Contact open-->COOLING operation
- Contact closed-->HEATING operation

MRS3

SAMMELSTÖRMELDUNG

- Die Störungsmeldung wird an den Klemmen 1 und 2 der anschlusse X1 abgenommen.

(Relais 230V 8 Amp)

EXTERNE FREIGABE

- Die Brücke "CA" an den Klemmen 3 und 4 am Anschluss X1 entfernen und externen Kontakt anschliessen. (Kontakt unbedingt potentialfrei anschliessen)
- Kontakt offen-->Gerät abgeschaltet
- Kontakt geschlossen-->Gerät Betriebsbereit

MAXIMALE LEISTUNG

- Der Kontakt wird an den Klemmen 4 und 5 am Stecker J13 der Hauptplatine angeschlossen.

(Relais 230V 8 Amp)

ZUSATZHEIZUNG

- Der Kontakt wird an den Klemmen 5 und 6 am Stecker J16 der Hauptplatine angeschlossen.

(Relais 230V 8 Amp)

AUSWAHL HEIZ-O.KUHLBETRIEB

- Konfiguration P17 Wert 3

- Der Kontakt wird an den Klemmen 1 und 2 am Stecker J7 der Hauptplatine angeschlossen. (Kontakt unbedingt potentialfrei anschliessen)
- Kontakt offen-->Kühlbetrieb
- Kontakt geschlossen-->Heizbetrieb

MRS3

SELECTION CONSIGNE 1 ou 2

- Configuration P18 valeur 3

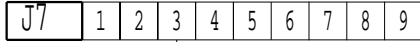

- Raccorder un contact entre les bornes 2 et 3 du connecteur J7 carte principale. (contact libre de toute polarité et de bonne qualité)
- Contact ouvert-->CONSIGNE 1
- Contact fermé-->CONSIGNE 2

FONCTION DE DELESTAGE

- Configuration P37 valeur 1

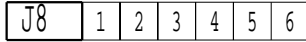

- Raccorder un contact entre les bornes 1 et 2 du connecteur J8 carte principale. (contact libre de toute polarité et de bonne qualité)
- Contact ouvert-->fonctionnement normal
- Contact fermé-->fonctionnement avec délestage

COMMANDE DES ETAGES FORCES

- Configuration P16 valeur 2

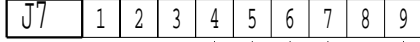

- Raccorder les contacts sur chaque entrée pour commander les différents étages (contact libre de toute polarité et de bonne qualité)
- Suivant le nombre d'étages, il suffit de raccorder des contacts à fermeture.

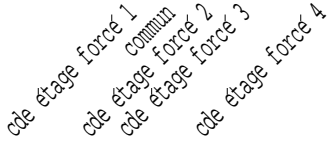

COMMANDE DE POMPE

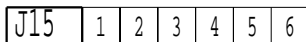

- Raccorder l'alimentation de la pompe entre la borne 5 du connecteur J15 carte principale et la borne 6 du bornier X1

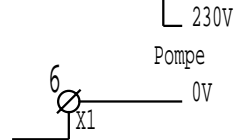

PRECAUTIONS DE RACCORDEMENT

POUR LES PRECAUTIONS A PRENDRE POUR LE RACCORDEMENT DES ENTRES VOIR LE MANUEL D'UTILISATION MRS3-4 PARAGRAPHE : "ASSERVISSEMENT ET COMMANDES EXTERNES"

SETTING 1 OR 2 SELECTION

- Configuration P18 value 3

- The controle must be connected to terminals 2 and 3 connector J7 main card. (contact must be polarity free and of good quality)
- Contact open-->SETTING 1 operation
- Contact closed-->SETTING 2 operation

LOAD SHEDDING

- Configuration P37 value 1

- The controle must be connected to terminals 1 and 2 connector J8 main card. (contact must be polarity free and of good quality)
- Contact open-->normal running
- Contact closed-->shedding

FORCED STAGES CONTROL

- Configuration P16 value 2

- The control of the various stages is made by an external control connected to the connector J7 of the main card. (contact must be polarity free and of good quality)
- According to the number of stages, connection of NO (normally open) contacts is sufficient.

PUMP CONTROL

- The pump control must be connected between terminal 5 on connector J15 of main card and terminal 6 of connector X1

CAUTION

TO TAKE PRECAUTION FOR CLIENT'S CONNECTIONS OF INPUTS SEE THE OPERATING AND MAINTENANCE INSTRUCTIONS OF MICROCIAT MRS3-4 PARAGRAPHE : "SERVO CONTROL AND EXTERNAL CONTROLS"

AUSWAHL SOLLWERT 1 ODER 2

- Konfiguration P18 wert 3

- Der Kontakt wird an den Klemmen 2 und 3 am Stecker J7 der Hauptplatine angeschlossen. (Kontakt unbedingt potentialfrei anschliessen)
- Kontakt offen-->Sollwert 1
- Kontakt geschlossen-->Sollwert 2

ENTLASTUNG

- Konfiguration P37 wert 1

- Der Kontakt wird an den Klemmen 1 und 2 am Stecker J8 der Hauptplatine angeschlossen. (Kontakt unbedingt potentialfrei anschliessen)
- Kontakt offen-->Normalbetrieb
- Kontakt geschlossen-->Entlastungsbetrieb

EXTERNERBETRIEB DER STUFEN

- Konfiguration P16 Wert 2

- Die Regelung der verschiedenen Stufen wird mit einem externen Kontakt am Stecker J7 der Hauptplatine hergestellt. (Kontakt unbedingt potentialfrei anschliessen)
- Die Zuverdrahtende Kontaktanzahl ist von der Stufenanzahl abhängig.

PUMPENSTEUERUNG

- Der Kontakt wird an den Klemmen 5 am Stecker J15 der Hauptplatine und den Klemmen 6 der Stecker X1 angeschlossen.

ACHTUNG

Um kundenseitige Anschlussfehler zu vermeiden, die Betriebs-und Wartungsanleitung MRS 3-4 Abschnitt Regelung und externe Regelung beachten.