

J  
I  
H  
G  
F  
E  
D  
C

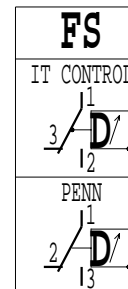
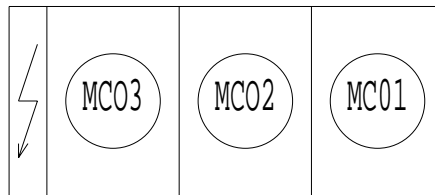

PRS 1	
B1	Sonde refolement circuit 1 Discharge sensor circuit 1 Heissgasfühler Kreislauf 1
B2	Sonde aspiration circuit 1 Suction sensor circuit 1 Sauggasfühler Kreislauf 1
B3	Sonde huile circuit 1 Oil sensor circuit 1 Öltemp. Fühler Kreislauf 1
B4	Sonde refolement circuit 2 Discharge sensor circuit 2 Heissgasfühler Kreislauf 2
B5	Sonde entree eau evapourateur Inlet water sensor evaporator Fühler Wassereintritt Verdampfer
B6	Sonde sortie eau evapourateur Outlet water sensor evaporator Fühler Wasseraustritt Verdampfer
B7	Sonde sortie eau condenseur Outlet water sensor condensor Fühler Wasseraustritt Verflüssiger
B8	Sonde air exterieur External air sensor Aussenluftfühler
B9	Sonde entree eau condenseur Inlet water sensor condenser Fühler Wassereintritt Verflüssiger
B10	Sonde aspiration circuit 2 Suction sensor circuit 2 Sauggasfühler Kreislauf 2
B11	Sonde huile circuit 2 Oil sensor circuit 2 Öltemp. Fühler Kreislauf 2

**DISPOSITION DES VANNES MAGNETIQUES  
ARRANGEMENT OF SOLENOIDE VALVES  
POSITION DER MAGNETVENTILE**

COMPRESSEUR HSKC 64 } YR1 OU YR3 = CR2  
 COMPRESSOR HSKC 64 } YR2 OU YR4 = CR1  
 VERDICHTER HSKC 64 }

COMPRESSEUR HSKC 74 } YR1 OU YR3 = CR1  
 COMPRESSOR HSKC 74 } YR2 OU YR4 = CR2  
 VERDICHTER HSKC 74 }

VANNES ELECTRIQUES  
SOLENOIDE VALVES  
MAGNETVENTILE

**DETAIL COMPRESSEUR  
COMPRESSOR DETAIL  
DETAIL VERDICHTER**

(VUE DE DESSUS)  
(TOP VIEW)  
(DRAUFSICHT)

[P]	BBP-BHP-BH	
	DANFOSS	HUBA
0 V (-)	2	3
5 V (+)	1	1
S ↗	3	2

[ ]	HP - BP		
	PENN P77	RANCO 016	MINI
BP	3 2	4 2	4 2
AUTO	1	1	1
HP	3 2	2 4	2 4
MANU	1	1	1
HP	2 3	4 2	2 4
AUTO	1	1	1

MODIFIE PAR: MODIFIED BY: GEANDERT DURCH: <b>AC</b>	INDICE INDEX KENNZIFFER <b>36</b>	DATE DATE DATUM <b>30-10-00</b>	FILS NUMEROTES EN OPTION NUMBERING OF WIRING IN OPTION OPTION KABEL NUMMERIERUNG	APPAREIL OU UNITE/UNIT/GERAT ODER EINHEIT <b>LN 700 - 800</b>
MODIFICATION <b>A INTERVERTIE LA POSITION DES MOTO-VENTILATEURS MC01 ET MC03</b>		LEGENDE/LEGEND/LEGENDE <b>3950010.36</b>	SPECIFICATION/SPECIFICATION/SPEZIFIZIERUNG <b>1 COMPRESSEUR - 1 CIRCUIT PRS1 - 3 VENT. 1 COMPRESSOR 1 CIRCUIT 1 VERDICHTER 1 KREISLAUF</b>	
REPLACE/TAKE/ERSETZT	REPLACE PAR/TAKE BY/ERSETZT DURCH	CLIENT/CLIENT/KUNDE	REFERENCE/REFERENCE/REFERENZ	CREATEUR: CREATOR: HERSTELLER: <b>JP</b>
REFERENCES COMMANDE/ORDER REFERENCES/AUFTRAGSREFERENZ		DEMARRAGE/START/ANLAUF	TENSION/VOLTAGE/SPANNUNG	DATE: DATE: DATUM: <b>21-04-97</b>
COMPAGNIE INDUSTRIELLE D'APPLICATIONS THERMIQUES <b>CIAT</b>			FOLIO/FOLIO/SEITE <b>1 / 7</b>	NUMERO DE SCHEMA/DRAWING NUMBER/PLAN NR <b>3980488</b>
				INDICE/INDEX/KENNZIFFER <b>36</b>

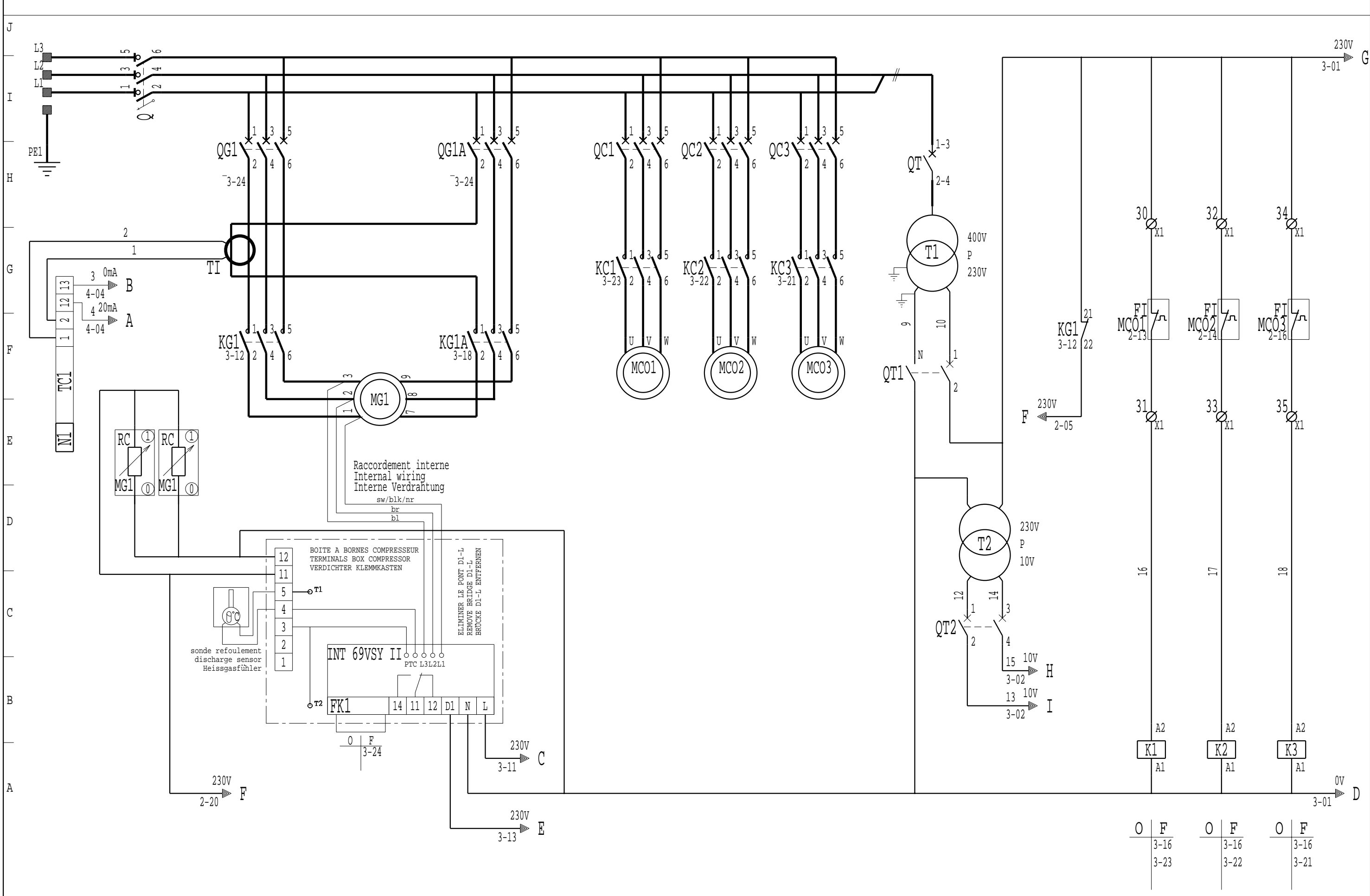

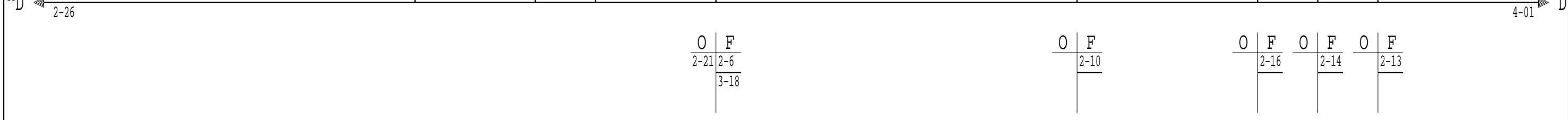
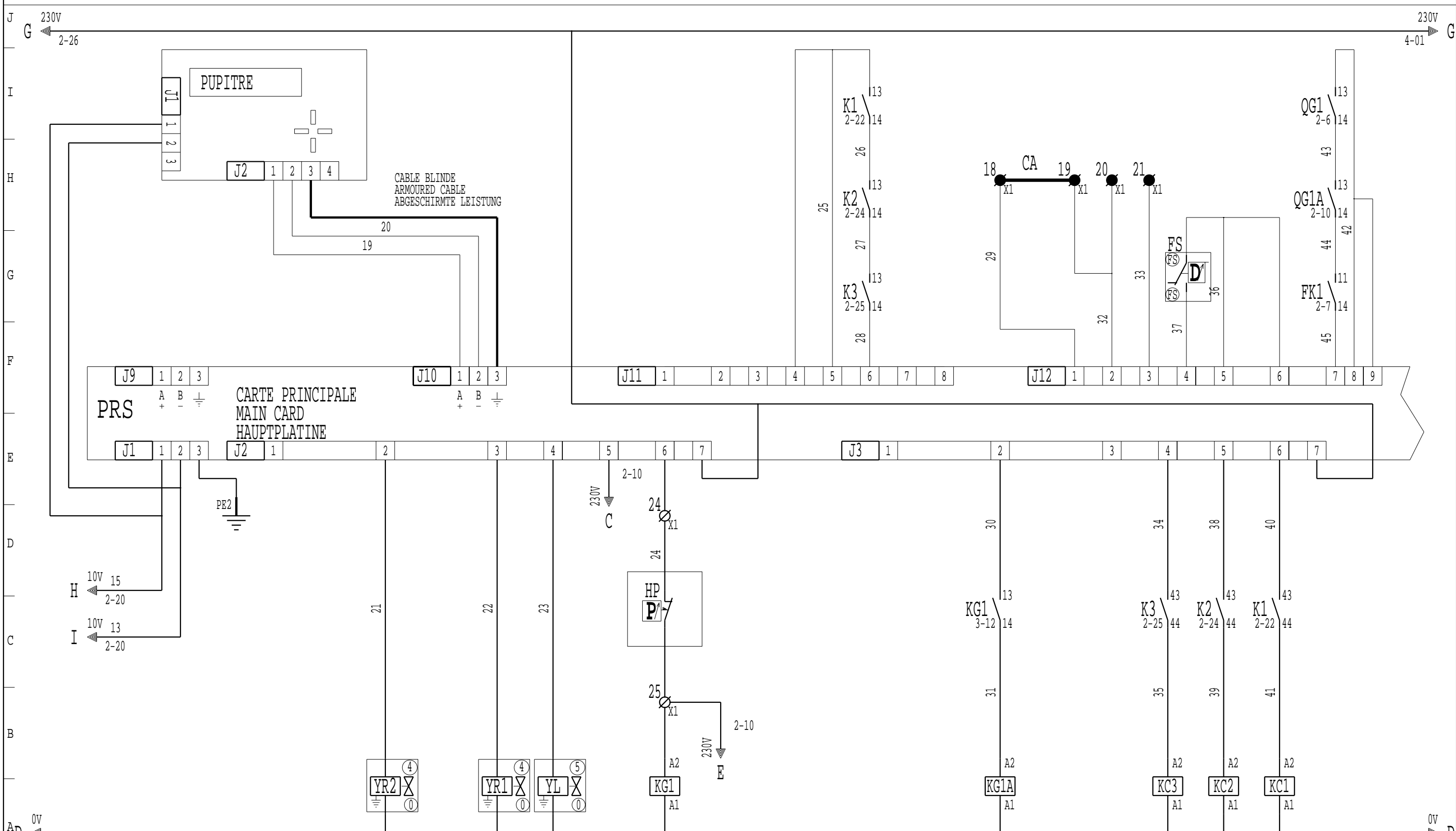

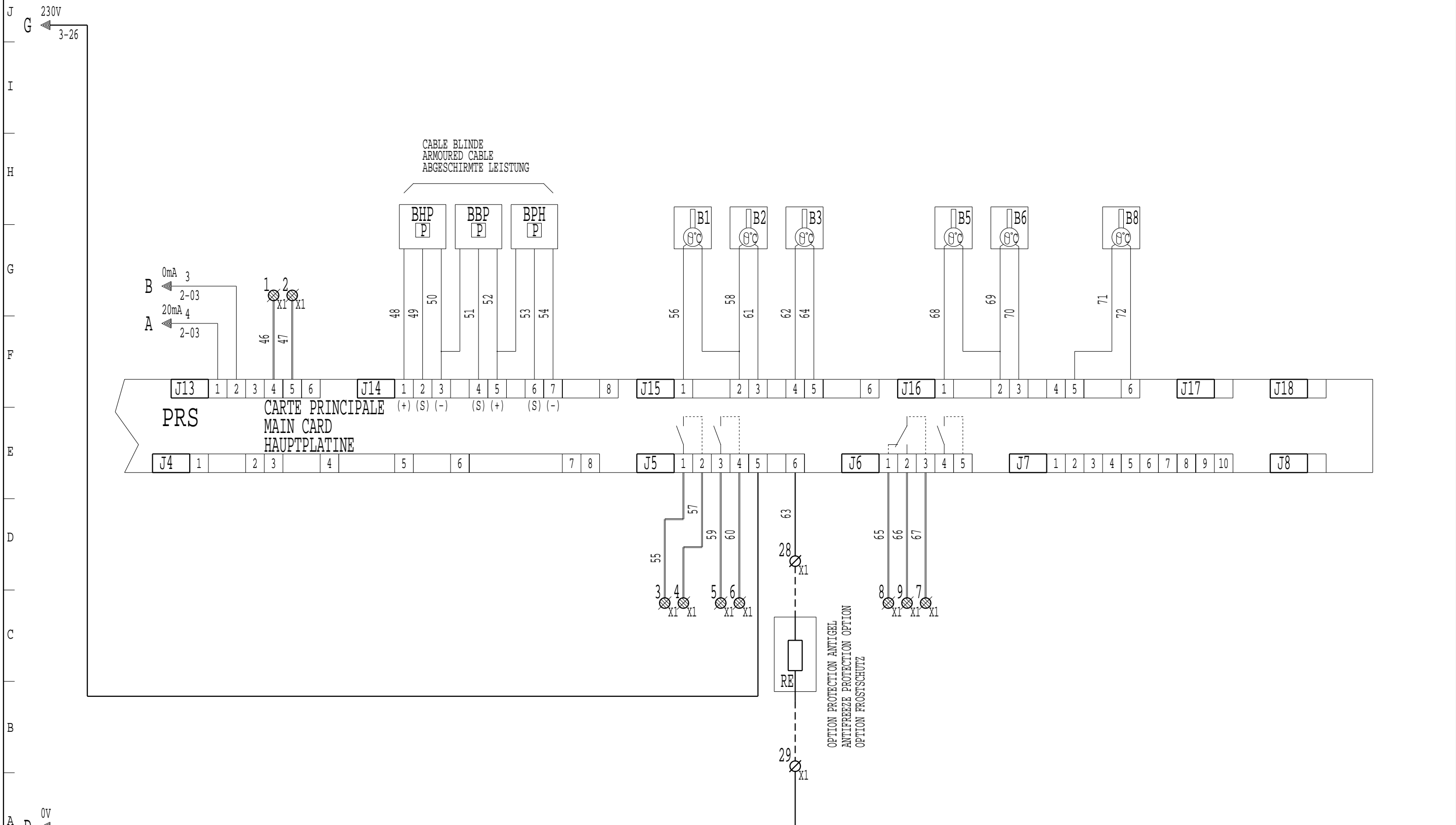

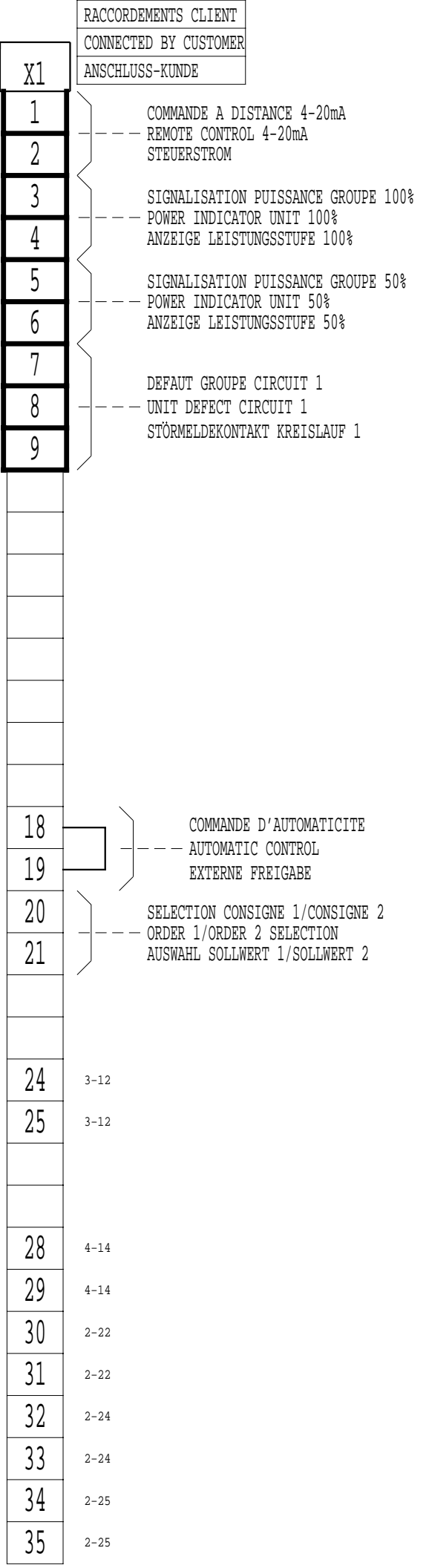

REFERENCES COMMANDE / ORDER REFERENCES / AUFTRAGSREFERENZ

DEMARRAGE / START / ANLAUF

TENSION / VOLTAGE / SPANNUNG

COMPAGNIE INDUSTRIELLE  
D'APPLICATIONS THERMIQUES



FOLIO / FOLIO / SETTE  
5 / 7

NUMERO DE SCHEMA / DRAWING NUMBER / PLAN NR  
3980488

INDICE / INDEX / KENNZEICHEN  
36

A B C D E F G H I J

J  
I  
H  
G  
F  
E  
D  
C  
B  
A

### VARIATION DE CONSIGNE A DISTANCE

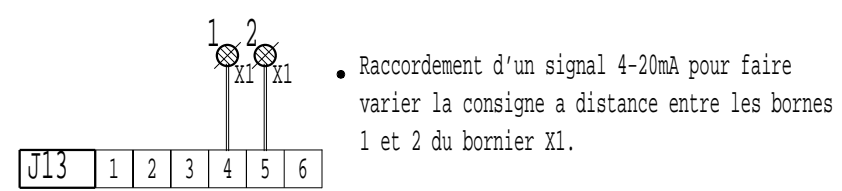

### SIGNALISATION PUISSANCE GROUPE

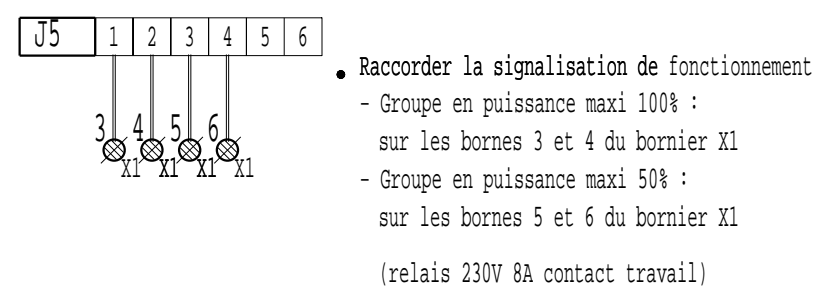

### DEFAULT GROUPE CIRCUIT 1

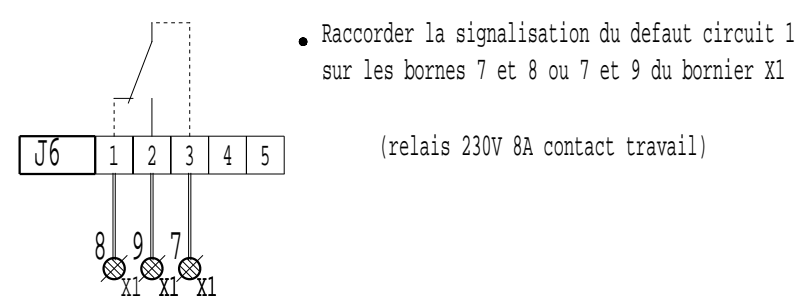

### DEFAULT GROUPE CIRCUIT 2

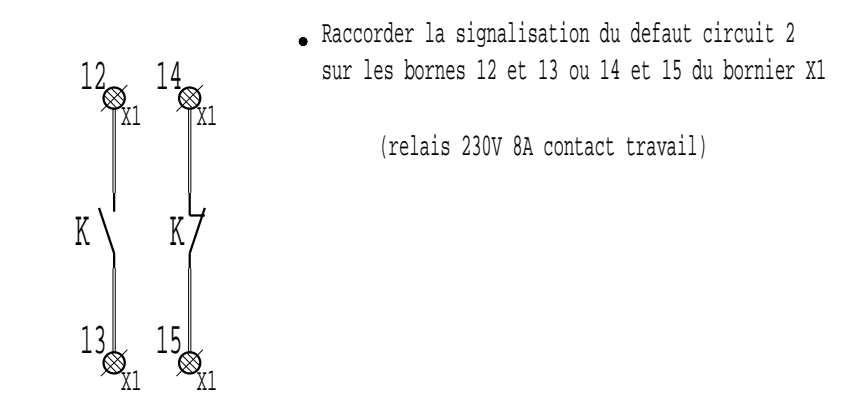

### REMOTE SETTING

• A 4-20mA signal, must be connected between terminals 1 and 2 on connector X1 for the modification of the set point .

### POWER INDICATOR UNIT

• The controle device must be connected to :  
 - terminals 3 and 4 on connector X1 for the power indicator unit 100%  
 - terminals 5 and 6 on connector X1 for the power indicator unit 50%  
 (relay 230V 8A)

### UNIT DEFECT CIRCUIT 1

• The fault or not-fault information on the unit can be recover on terminals 7 and 8 or 7 and 9 connector X1  
 (relay 230V 8A)

### UNIT DEFECT CIRCUIT 2

• The fault or not-fault information on the unit can be recover on terminals 12 and 13 or 14 and 15 connector X1  
 (relay 230V 8A)

## PRS

### STEUERSTROM (Sollwert)

• Der Modul 4-20mA Signal wird an den klemmen 1 und 2 Anschlüsse X1 angeschlossen

### ANZEIGE LEISTUNGSSTUFE

• Anzeige Leistungsstufe 100%  
 - Der Kontakt wird an den Klemmen 3 und 4 der Anschlüsse X1 angeschlossen  
 Anzeige Leistungsstufe 50%  
 - Der Kontakt wird an den Klemmen 5 und 6 der Anschlüsse X1 angeschlossen  
 (Relais 230V 8A)

### STÖRMELDEKONTAKT KREISLAUF 1

• Die Störungsmeldung wird an den Klemmen 7 und 8 oder 7 und 9 der Anschlüsse X1 angeschlossen  
 (Relais 230V 8A)

### STÖRMELDEKONTAKT KREISLAUF 2

• Die Störungsmeldung wird an den Klemmen 12 und 13 oder 14 und 15 der Anschlüsse X1 angeschlossen  
 (Relais 230V 8A)

**PRS**

J  
I  
H  
G  
F  
E  
D  
C  
B  
A

**COMMANDE DE POMPE**

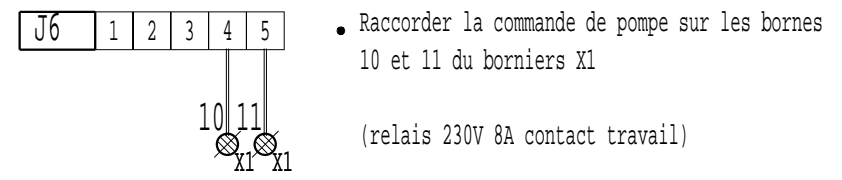

**PUMP CONTROL**

• The pump control must be connected between terminals 10 and 11 on connector X1  
(relay 230V 8A)

**PUMPENSTEUERUNG**

• Der Kontakt wird an den Klemmen 10 und 11 der Anschlüsse X1 angeschlossen  
(Relais 230V 8A)

**COMMANDE D'AUTOMATICITE**

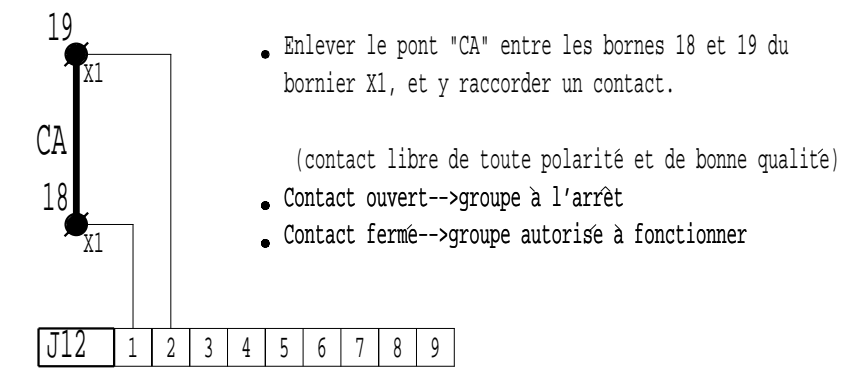

**AUTOMATIC CONTROL**

• The shunt "CA" on terminals 18 and 19 of connector X1, must be lifted and the contact connected.  
(contact must be polarity free and of good quality)  
• Contact open-->unit off-line  
• Contact closed-->unit on-line

**EXTERNE FREIGABE**

• Die Brücke "CA" an den Klemmen 18 und 19 am Anschluss X1 entfernen und externen Kontakt anschliessen.  
(Kontakt unbedingt potentialfrei anschliessen)  
• Kontakt offen-->Gerät abgeschaltet  
• Kontakt geschlossen-->Gerät in Betrieb

**SELECTION CONSIGNE 1 OU 2**

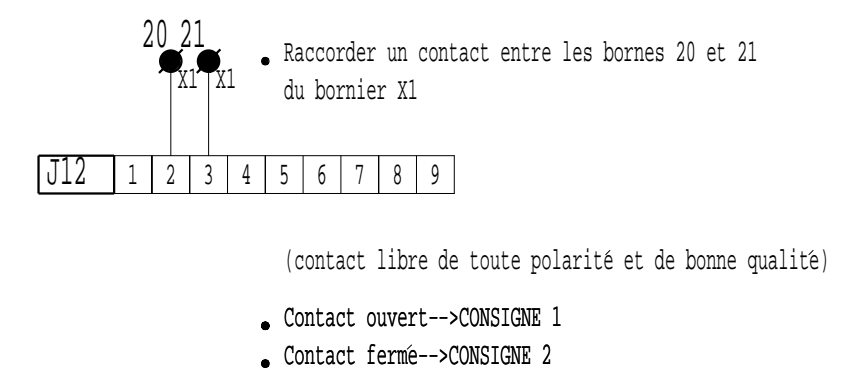

**SETTING 1 OR 2 SELECTION**

• The controle must be connected to terminals 20 and 21 connector X1  
(contact must be polarity free and of good quality)  
• Contact open-->SETTING 1 operation  
• Contact closed-->SETTING 2 operation

**AUSWAHL SOLLWERT 1 ODER 2**

• Der Kontakt wird an den Klemmen 20 und 21 der Anschlüsse X1 angeschlossen  
(Kontakt unbedingt potentialfrei anschliessen)  
• Kontakt offen-->Sollwert 1  
• Kontakt geschlossen-->Sollwert 2

J  
I  
H  
G  
F  
E  
D  
C

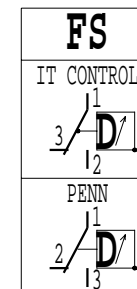
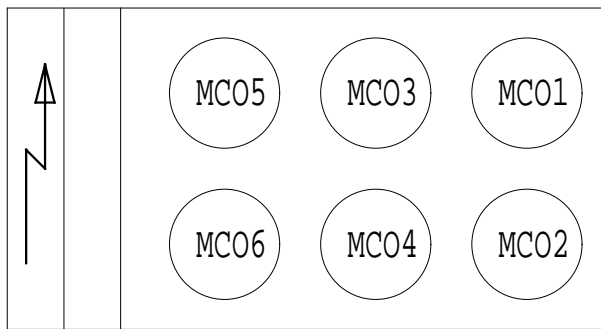

PRS 1	
B1	Sonde refoulement circuit 1 Discharge sensor circuit 1 Heissgasfühler Kreislauf 1
B2	Sonde aspiration circuit 1 Suction sensor circuit 1 Sauggasfühler Kreislauf 1
B3	Sonde huile circuit 1 Oil sensor circuit 1 Öltemp. Fühler Kreislauf 1
B4	Sonde refoulement circuit 2 Discharge sensor circuit 2 Heissgasfühler Kreislauf 2
B5	Sonde entree eau evapourateur Inlet water sensor evaporator Fühler Wassereintritt Verdampfer
B6	Sonde sortie eau evapourateur Outlet water sensor evaporator Fühler Wasseraustritt Verdampfer
B7	Sonde sortie eau condenseur Outlet water sensor condensor Fühler Wasseraustritt Verflüssiger
B8	Sonde air exterieur External air sensor Aussenluftfühler
B9	Sonde entree eau condenseur Inlet water sensor condenser Fühler Wassereintritt Verflüssiger
B10	Sonde aspiration circuit 2 Suction sensor circuit 2 Sauggasfühler Kreislauf 2
B11	Sonde huile circuit 2 Oil sensor circuit 2 Öltemp. Fühler Kreislauf 2

**DISPOSITION DES VANNES MAGNETIQUES  
ARRANGEMENT OF SOLENOID VALVES  
POSITION DER MAGNETVENTILE**

COMPRESSEUR HSKC 64 } YR1 OU YR3 = CR2  
 COMPRESSOR HSKC 64 } YR2 OU YR4 = CR1  
 VERDICHTER HSKC 64 }

COMPRESSEUR HSKC 74 } YR1 OU YR3 = CR1  
 COMPRESSOR HSKC 74 } YR2 OU YR4 = CR2  
 VERDICHTER HSKC 74 }

VANNES ELECTRIQUES  
SOLENOID VALVES  
MAGNETVENTILE

**DETAIL COMPRESSEUR  
COMPRESSOR DETAIL  
DETAIL VERDICHTER** (VUE DE DESSUS)  
(TOP VIEW)  
(DRAUFSICHT)

P	BBP-BHP-BH	
	DANFOSS	HUBA
0 V (-)	2	3
5 V (+)	1	1
S ↗	3	2

HP - BP	HP - BP		
	PENN P77	RANCO 016	MINI
BP	3 2	4 2	4 2
AUTO	1	1	1
HP	3 2	2 4	2 4
MANU	1	1	1
HP	2 3	4 2	2 4
AUTO	1	1	1

MODIFIE PAR: MODIFIED BY: GEANDERT DURCH: FG	INDICE INDEX KENNZIFFER 35	DATE DATE DATUM 30-08-99	FILS NUMEROTES EN OPTION NUMBERING OF WIRING IN OPTION OPTION KABEL NUMMERIERUNG	APPAREIL OU UNITE/UNIT/GERAT ODER EINHEIT <b>LN 900</b>
MODIFICATION A MISE A JOUR BIB		LEGENDE/LEGEND/LEGENDE 3950010.36	SPECIFICATION/SPECIFICATION/SPEZIFIZIERUNG 1 COMPRESSEUR - 1 CIRCUIT 1 COMPRESSOR 1 CIRCUIT 1 VERDICHTER 1 KREISLAUF PRS1-6 VENT.-FILS NUMEROTES	
REPLACE/TAKE/ERSETZT	REPLACE PAR/TAKE BY/ERSERTZT DURCH	CLIENT/CLIENT/KUNDE	REFERENCE/REFERENCE/REFERENZ	CREATEUR: CREATOR: HERSTELLER: JP
REFERENCES COMMANDE/ORDER REFERENCES/AUFTRAGSREFERENZ		DEMARRAGE/START/ANLAUF	TENSION/VOLTAGE/SPANNUNG	DATE: DATE: DATUM: 21-04-97
COMPAGNIE INDUSTRIELLE D'APPLICATIONS THERMIQUES			<b>CIAT</b>	FOLIO/FOLIO/SEITE 1 / 7
			NUMERO DE SCHEMA/DRAWING NUMBER/PLAN NR <b>3980486</b>	INDICE/INDEX/KENNZIFFER <b>35</b>



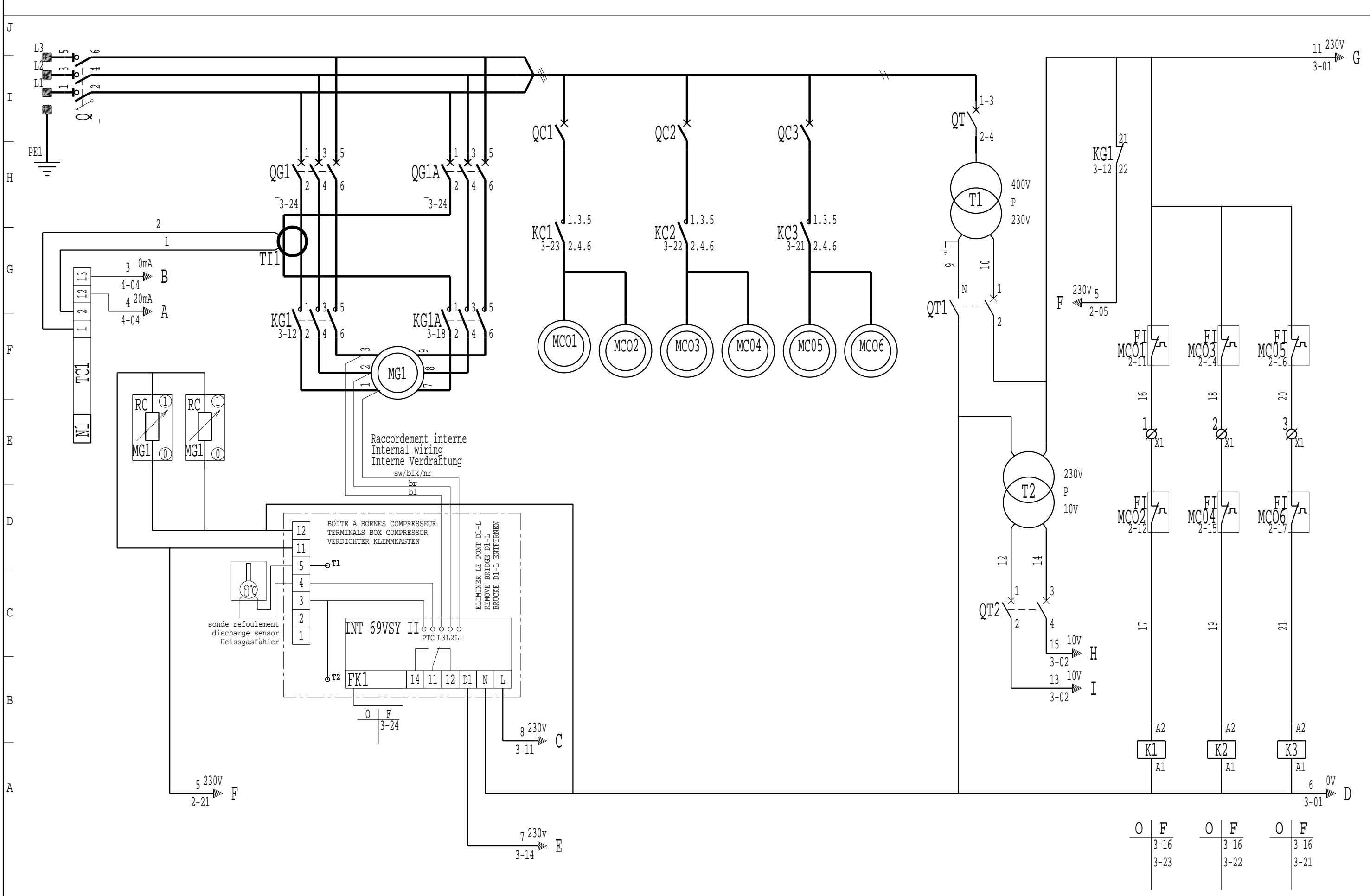

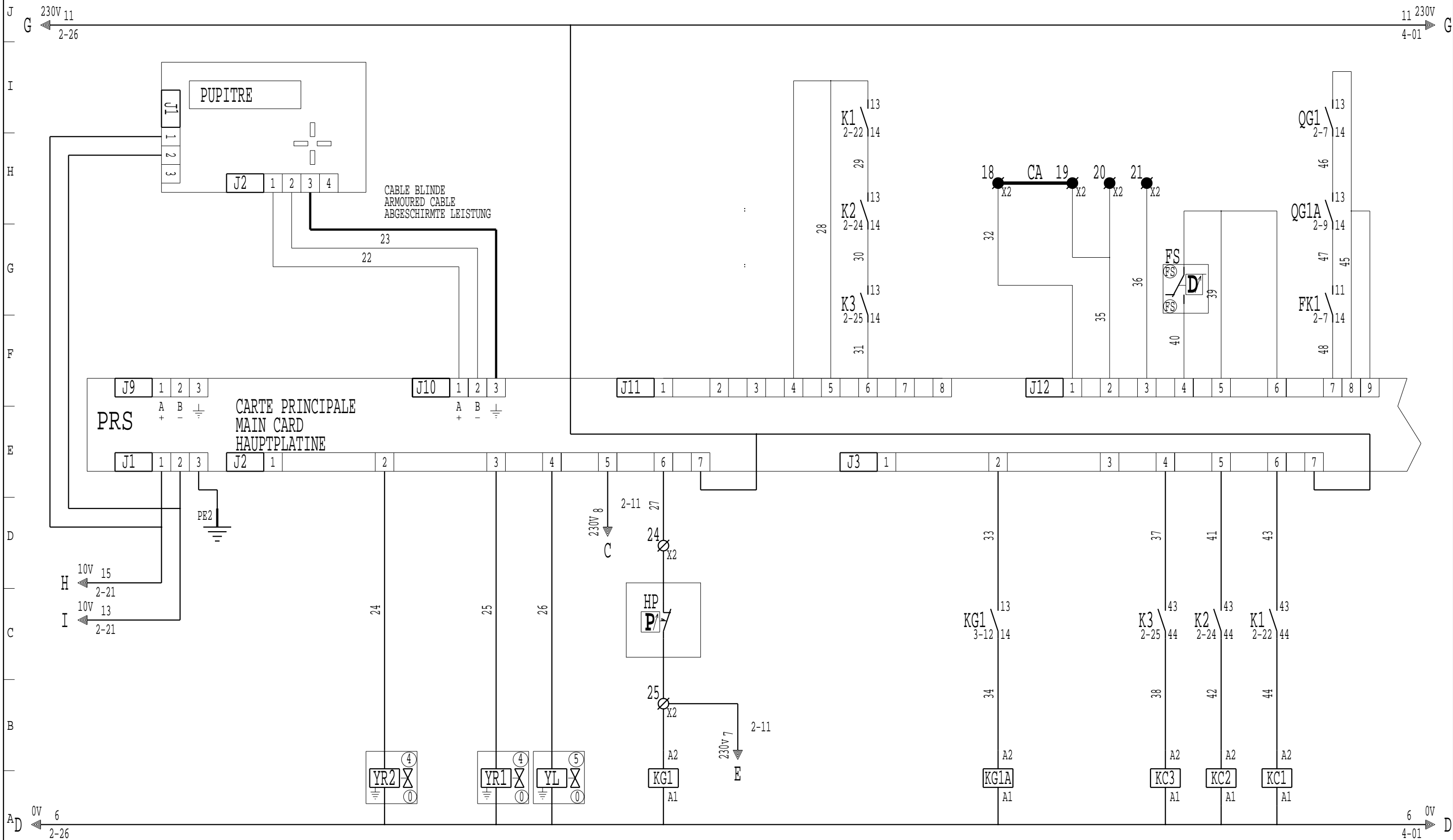

2-22	2-7	3-18	2-9	2-16	2-14	2-11
------	-----	------	-----	------	------	------

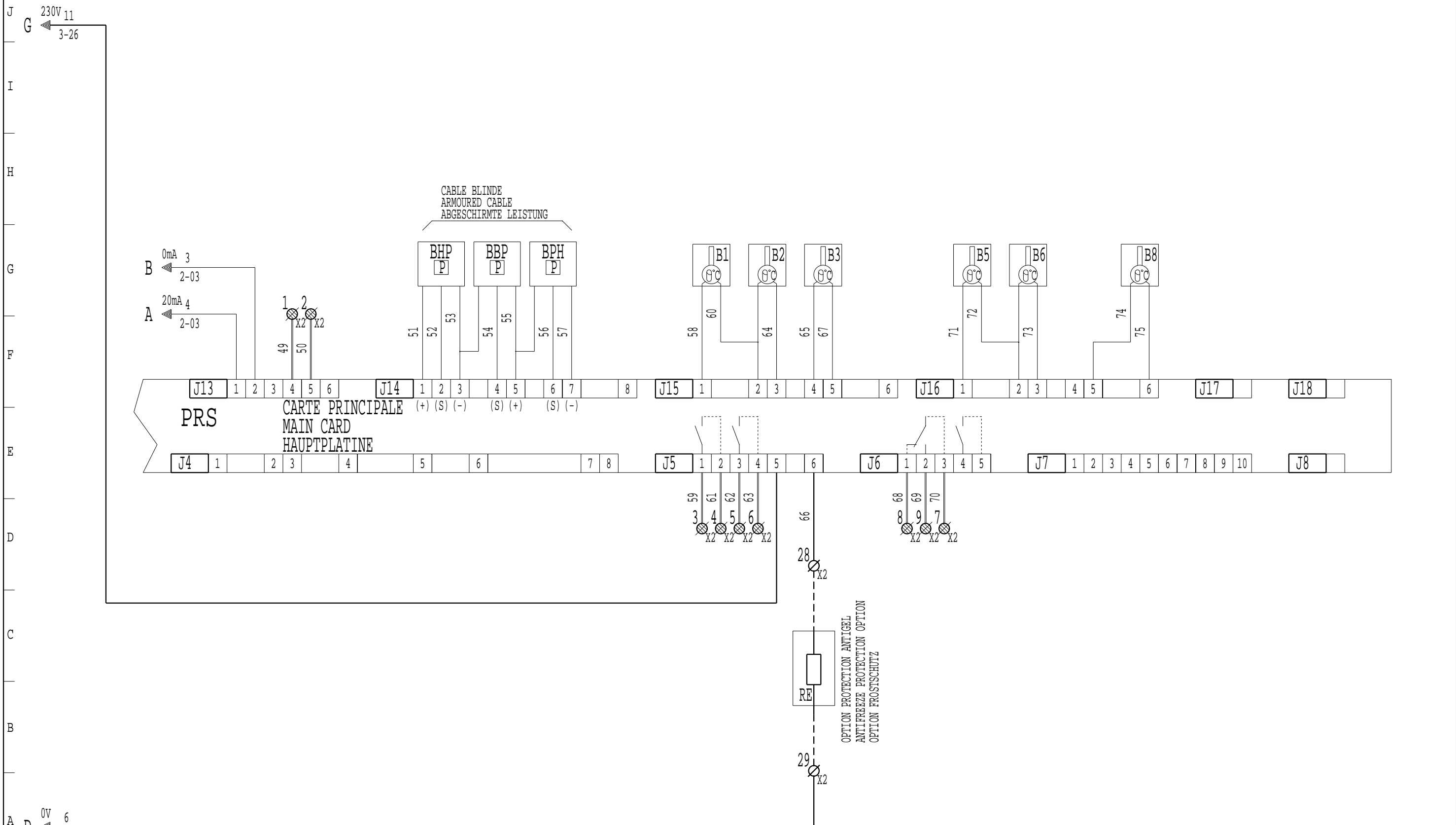

01 02 03 04 05 06 07 08 09 10 11 12 13 14 15 16 17 18 19 20 21 22 23 24 25 26

RACCORDEMENTS USINE  
FACTORY CONNECTION  
WERKSEITIGE VERDRÄHTUNG

RACCORDEMENTS CLIENT  
CONNECTED BY CUSTOMER  
ANSCHLUSS-KUNDE

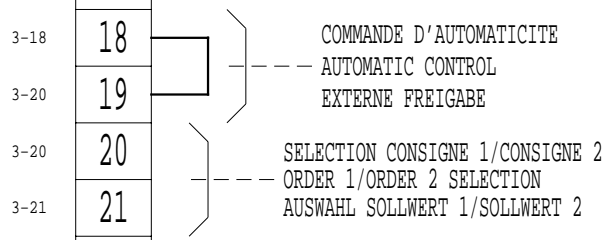
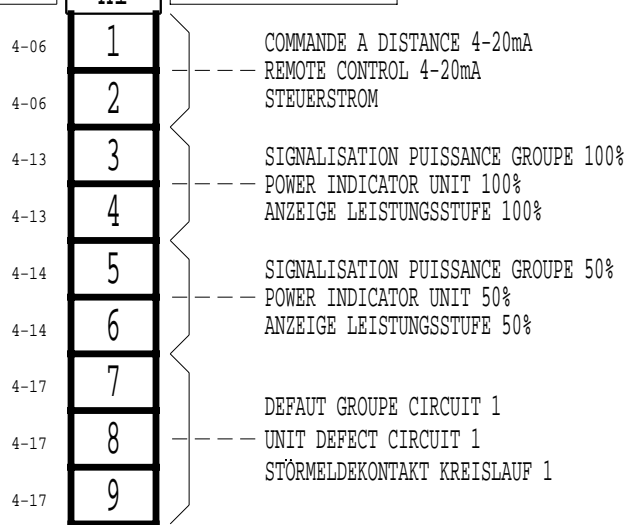

PRESSOSTAT HP MANUEL CIRCUIT 1  
HP MANUAL PRESSOSTAT CIRCUIT 1  
MANUELLER HD PRESSOSTAT KREISLAUF 1

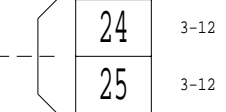

PROTECTION ANTIGEL  
ANTIFREEZE PROTECTION  
FROSTSCHUTZ

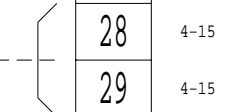

RACCORDEMENTS USINE  
FACTORY CONNECTION  
WERKSEITIGE VERDRÄHTUNG

RACCORDEMENTS CLIENT  
CONNECTED BY CUSTOMER  
ANSCHLUSS-KUNDE

PROTECTION IPSOTHERMIQUE MOTEURS VENTILATEURS  
IPSOTHERMIC PROTECTOR OF FANS MOTORS  
THERMOSCHUTZ LÜFTERMOTOREN

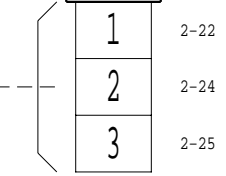

J  
VARIATION DE CONSIGNE A DISTANCE

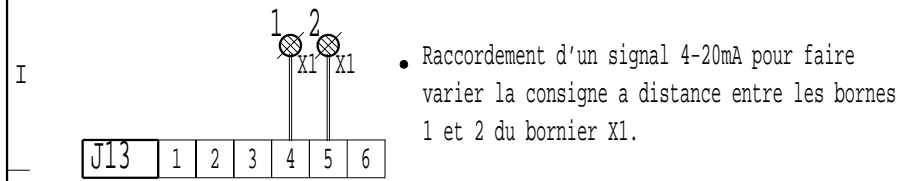

H  
SIGNALISATION PUISSANCE GROUPE

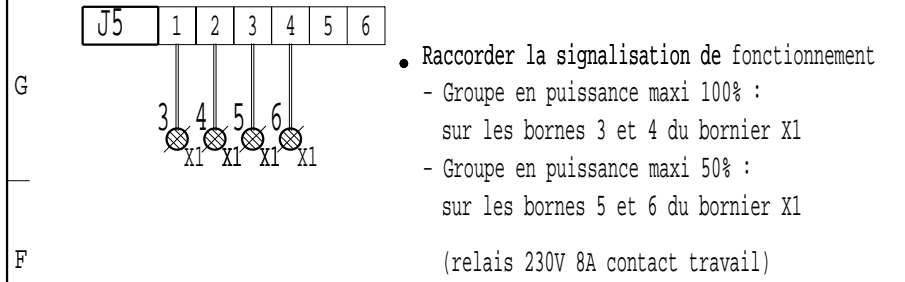

F  
DEFAULT GROUPE CIRCUIT 1

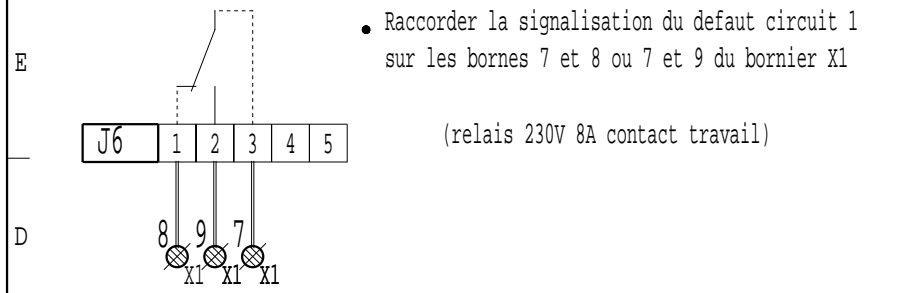

D  
DEFAULT GROUPE CIRCUIT 2

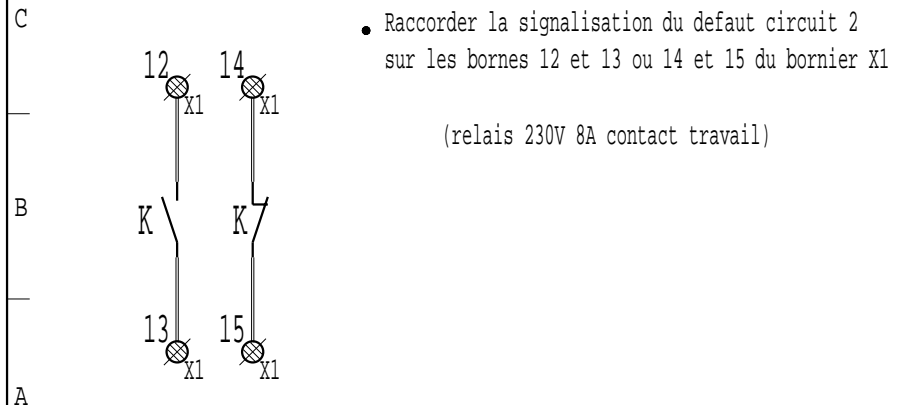

B  
A

REMOTE SETTING

• A 4-20mA signal, must be connected between terminals 1 and 2 on connector X1 for the modification of the set point .

POWER INDICATOR UNIT

• The controle device must be connected to :  
 - terminals 3 and 4 on connector X1 for the power indicator unit 100%  
 - terminals 5 and 6 on connector X1 for the power indicator unit 50%  
 (relay 230V 8A)

UNIT DEFECT CIRCUIT 1

• The fault or not-fault information on the unit can be recover on terminals 7 and 8 or 7 and 9 connector X1  
 (relay 230V 8A)

UNIT DEFECT CIRCUIT 2

• The fault or not-fault information on the unit can be recover on terminals 12 and 13 or 14 and 15 connector X1  
 (relay 230V 8A)

**PRS**

STEUERSTROM (Sollwert)

• Der Modul 4-20mA Signal wird an den klemmen 1 und 2 Anschlüsse X1 angeschlossen

ANZEIGE LEISTUNGSSTUFE

• Anzeige Leistungsstufe 100%  
 - Der Kontakt wird an den Klemmen 3 und 4 der Anschlüsse X1 angeschlossen  
 Anzeige Leistungsstufe 50%  
 - Der Kontakt wird an den Klemmen 5 und 6 der Anschlüsse X1 angeschlossen  
 (Relais 230V 8A)

STÖRMELDEKONTAKT KREISLAUF 1

• Die Störungsmeldung wird an den Klemmen 7 und 8 oder 7 und 9 der Anschlüsse X1 angeschlossen  
 (Relais 230V 8A)

STÖRMELDEKONTAKT KREISLAUF 2

• Die Störungsmeldung wird an den Klemmen 12 und 13 oder 14 und 15 der Anschlüsse X1 angeschlossen  
 (Relais 230V 8A)

**PRS**

J  
I  
H  
G  
F  
E  
D  
C  
B  
A

**COMMANDE DE POMPE**

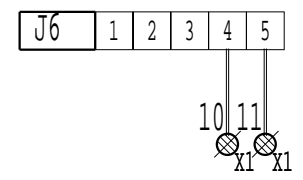

- Raccorder la commande de pompe sur les bornes 10 et 11 du borniers X1 (relais 230V 8A contact travail)

**PUMP CONTROL**

- The pump control must be connected between terminals 10 and 11 on connector X1 (relay 230V 8A)

**PUMPENSTEUERUNG**

- Der Kontakt wird an den Klemmen 10 und 11 der Anschlüsse X1 angeschlossen (Relais 230V 8A)

**COMMANDE D'AUTOMATICITE**

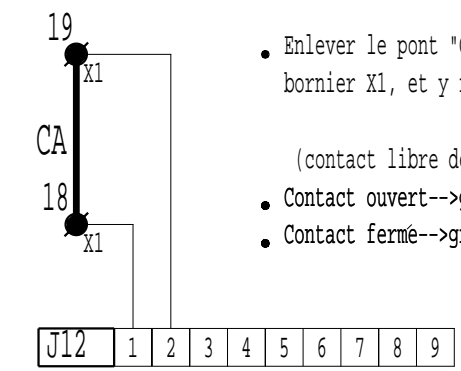

- Enlever le pont "CA" entre les bornes 18 et 19 du bornier X1, et y raccorder un contact. (contact libre de toute polarité et de bonne qualité)
- Contact ouvert-->groupe à l'arrêt
- Contact fermé-->groupe autorisé à fonctionner

**AUTOMATIC CONTROL**

- The shunt "CA" on terminals 18 and 19 of connector X1, must be lifted and the contact connected. (contact must be polarity free and of good quality)
- Contact open-->unit off-line
- Contact closed-->unit on-line

**EXTERNE FREIGABE**

- Die Brücke "CA" an den Klemmen 18 und 19 am Anschluss X1 entfernen und externen Kontakt anschliessen. (Kontakt unbedingt potentialfrei anschliessen)
- Kontakt offen-->Gerät abgeschaltet
- Kontakt geschlossen-->Gerät in Betrieb

**SELECTION CONSIGNE 1 OU 2**

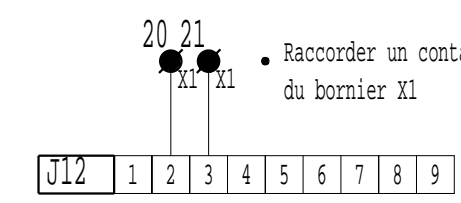

- Raccorder un contact entre les bornes 20 et 21 du bornier X1 (contact libre de toute polarité et de bonne qualité)
- Contact ouvert-->CONSIGNE 1
- Contact fermé-->CONSIGNE 2

**SETTING 1 OR 2 SELECTION**

- The controle must be connected to terminals 20 and 21 connector X1 (contact must be polarity free and of good quality)
- Contact open-->SETTING 1 operation
- Contact closed-->SETTING 2 operation

**AUSWAHL SOLLWERT 1 ODER 2**

- Der Kontakt wird an den Klemmen 20 und 21 der Anschlüsse X1 angeschlossen (Kontakt unbedingt potentialfrei anschliessen)
- Kontakt offen-->Sollwert 1
- Kontakt geschlossen-->Sollwert 2

J  
I  
H  
G  
F  
E  
D  
C

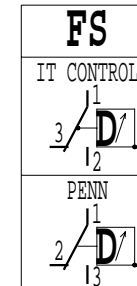

PRS 1	
B1	Sonde refolement circuit 1 Discharge sensor circuit 1 Heissgasfühler Kreislauf 1
B2	Sonde aspiration circuit 1 Suction sensor circuit 1 Sauggasfühler Kreislauf 1
B3	Sonde huile circuit 1 Oil sensor circuit 1 Öltemp. Fühler Kreislauf 1
B4	Sonde refolement circuit 2 Discharge sensor circuit 2 Heissgasfühler Kreislauf 2
B5	Sonde entree eau evapourateur Inlet water sensor evaporator Fühler Wassereintritt Verdampfer
B6	Sonde sortie eau evapourateur Outlet water sensor evaporator Fühler Wasseraustritt Verdampfer
B7	Sonde sortie eau condenseur Outlet water sensor condensor Fühler Wasseraustritt Verflüssiger
B8	Sonde air exterieur External air sensor Aussenluftfühler
B9	Sonde entree eau condenseur Inlet water sensor condenser Fühler Wassereintritt Verflüssiger
B10	Sonde aspiration circuit 2 Suction sensor circuit 2 Sauggasfühler Kreislauf 2
B11	Sonde huile circuit 2 Oil sensor circuit 2 Öltemp. Fühler Kreislauf 2

**DISPOSITION DES VANNES MAGNETIQUES**  
**ARRANGEMENT OF SOLENOIDE VALVES**  
**POSITION DER MAGNETVENTILE**

COMPRESSEUR HSKC 64 } YR1 OU YR3 = CR2  
 COMPRESSOR HSKC 64 } YR2 OU YR4 = CR1  
 VERDICHTER HSKC 64 }

COMPRESSEUR HSKC 74 } YR1 OU YR3 = CR1  
 COMPRESSOR HSKC 74 } YR2 OU YR4 = CR2  
 VERDICHTER HSKC 74 }

VANNES ELECTRIQUES  
SOLENOIDE VALVES  
MAGNETVENTILE

**DETAIL COMPRESSEUR**  
**COMPRESSOR DETAIL**  
**DETAIL VERDICHTER**

(VUE DE DESSUS)  
(TOP VIEW)  
(DRAUFSICHT)

P	BBP-BHP-BH	
	DANFOSS	HUBA
0 V (-)	2	3
5 V (+)	1	1
S ↗	3	2

HP - BP	HP - BP		
	PENN P77	RANCO 016	MINI
BP	3 2	4 2	4 2
AUTO	1	1	1
HP	3 2	2 4	2 4
MANU	1	1	1
HP	2 3	4 2	2 4
AUTO	1	1	1

MODIFIE PAR: MODIFIED BY: GEANDERT DURCH: FG	INDICE INDEX KENNZIFFER 37	DATE DATE DATUM 30-08-99	FILS NUMEROTES EN OPTION NUMBERING OF WIRING IN OPTION OPTION KABEL NUMMERIERUNG	APPAREIL OU UNITE/UNIT/GERAT ODER EINHEIT LN 1000 A 1800
MODIFICATION A RACCORDEMENT DE K9 SUR BORNIER		LEGENDE/LEGEND/LEGENDE 3950010.36	SPECIFICATION/SPECIFICATION/SPEZIFIZIERUNG 2 COMPRESSEURS - 2 CIRCUITS PRS1-6-8 VENT. 2 COMPRESSORS 2 CIRCUITS 2 VERDICHTERN 2 KREISLAUFE	
REPLACE/TAKE/ERSETZT	REPLACE PAR/TAKE BY/ERSERTZT DURCH	CLIENT/CLIENT/KUNDE	REFERENCE/REFERENCE/REFERENZ	CREATEUR: CREATOR: HERSTELLER: HD
REFERENCES COMMANDE/ORDER REFERENCES/AUFTRAGSREFERENZ		DEMARRAGE/START/ANLAUF	TENSION/VOLTAGE/SPANNUNG	DATE: DATE: DATUM: 21-04-97
COMPAGNIE INDUSTRIELLE D'APPLICATIONS THERMIQUES			CIAT	FOLIO/FOLIO/SEITE 1 / 9
				NUMERO DE SCHEMA/DRAWING NUMBER/PLAN NR 3980487
				INDICE/INDEX/KENNZIFFER 37

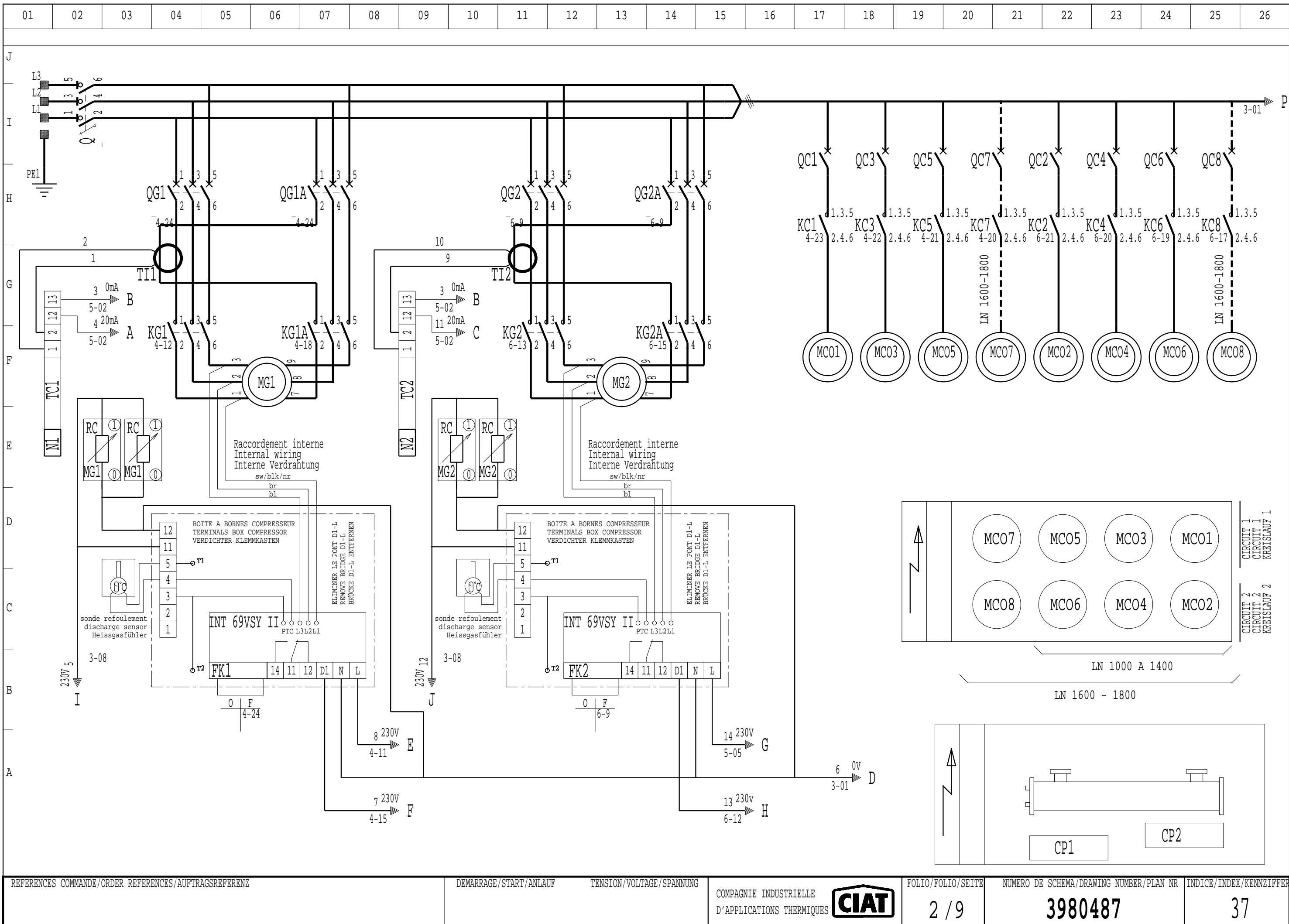



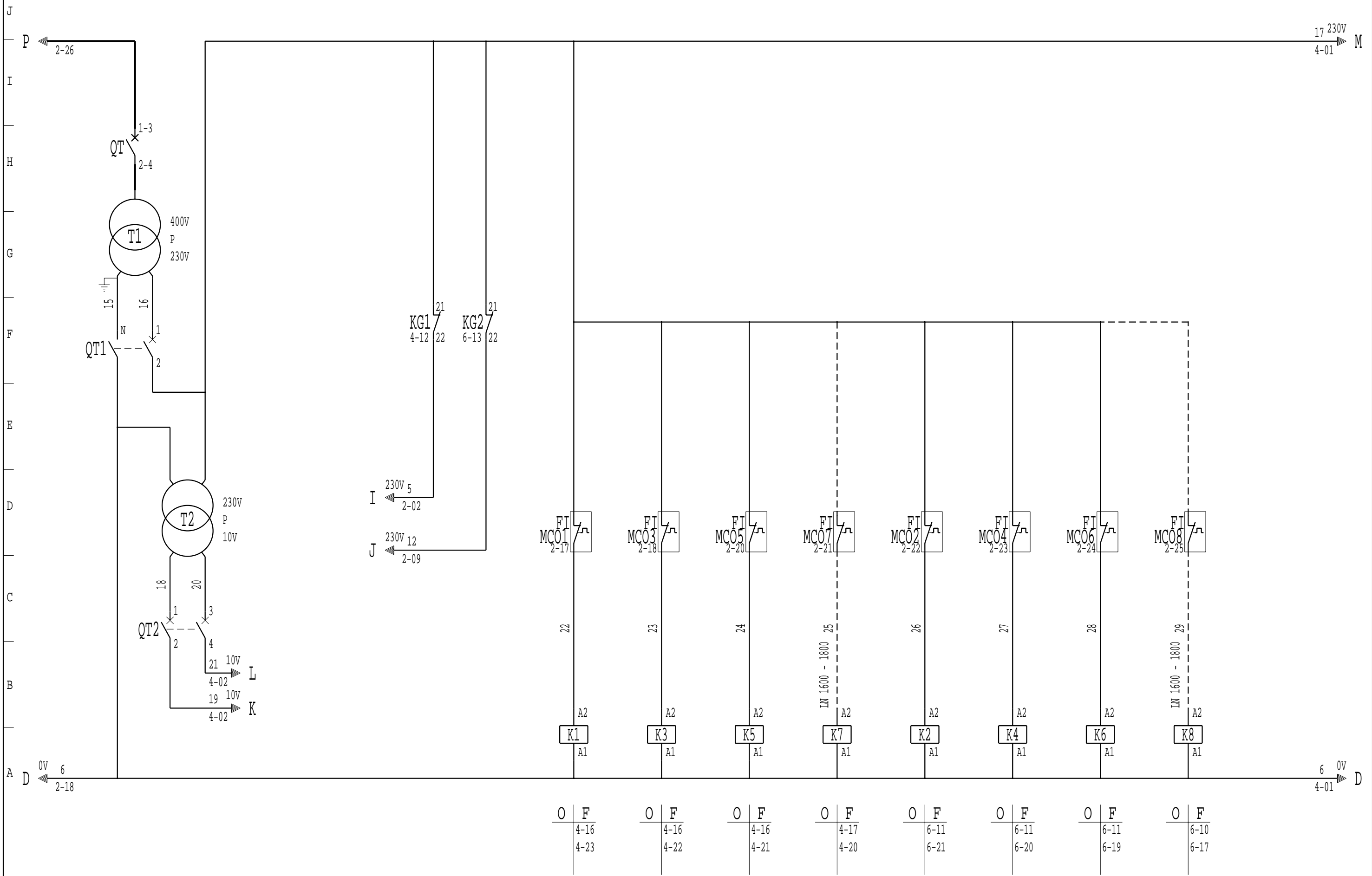

J M 230V 17 3-26 17 230V 5-01 M

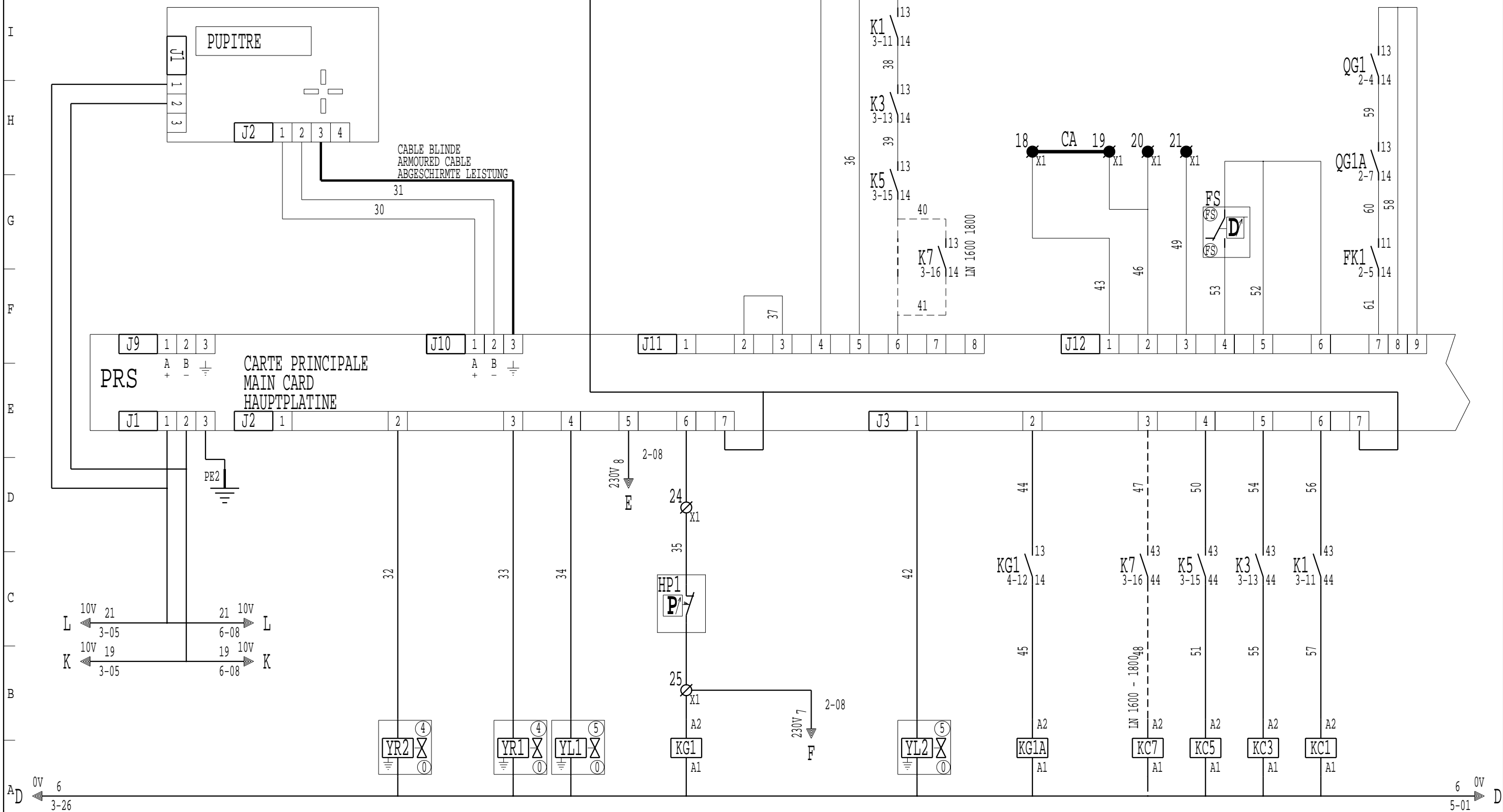

O	F	O	F	O	F	O	F	O	F	O	F
3-9	2-4	2-7	2-21	2-20	2-18	2-17					
	4-18										

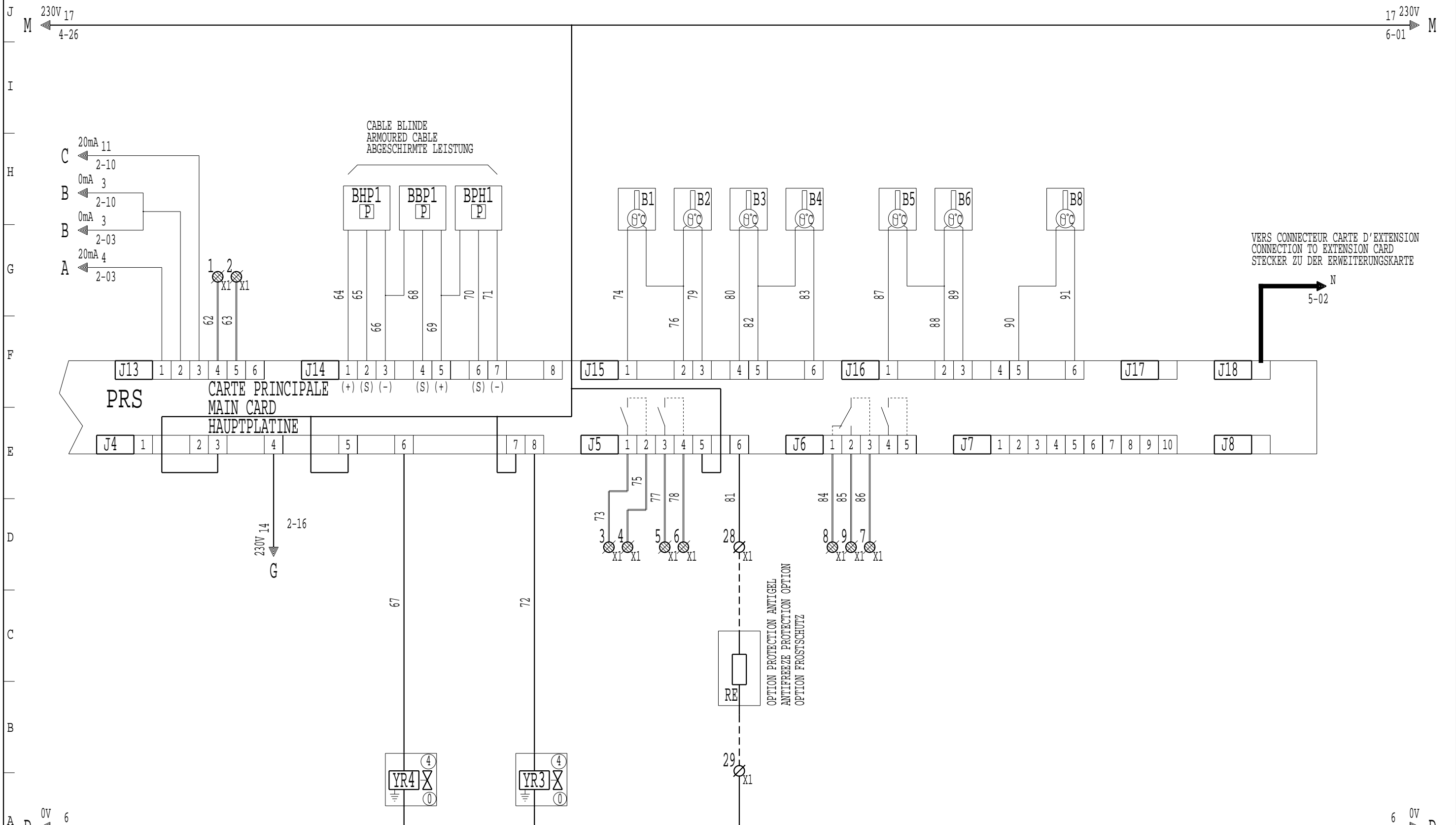

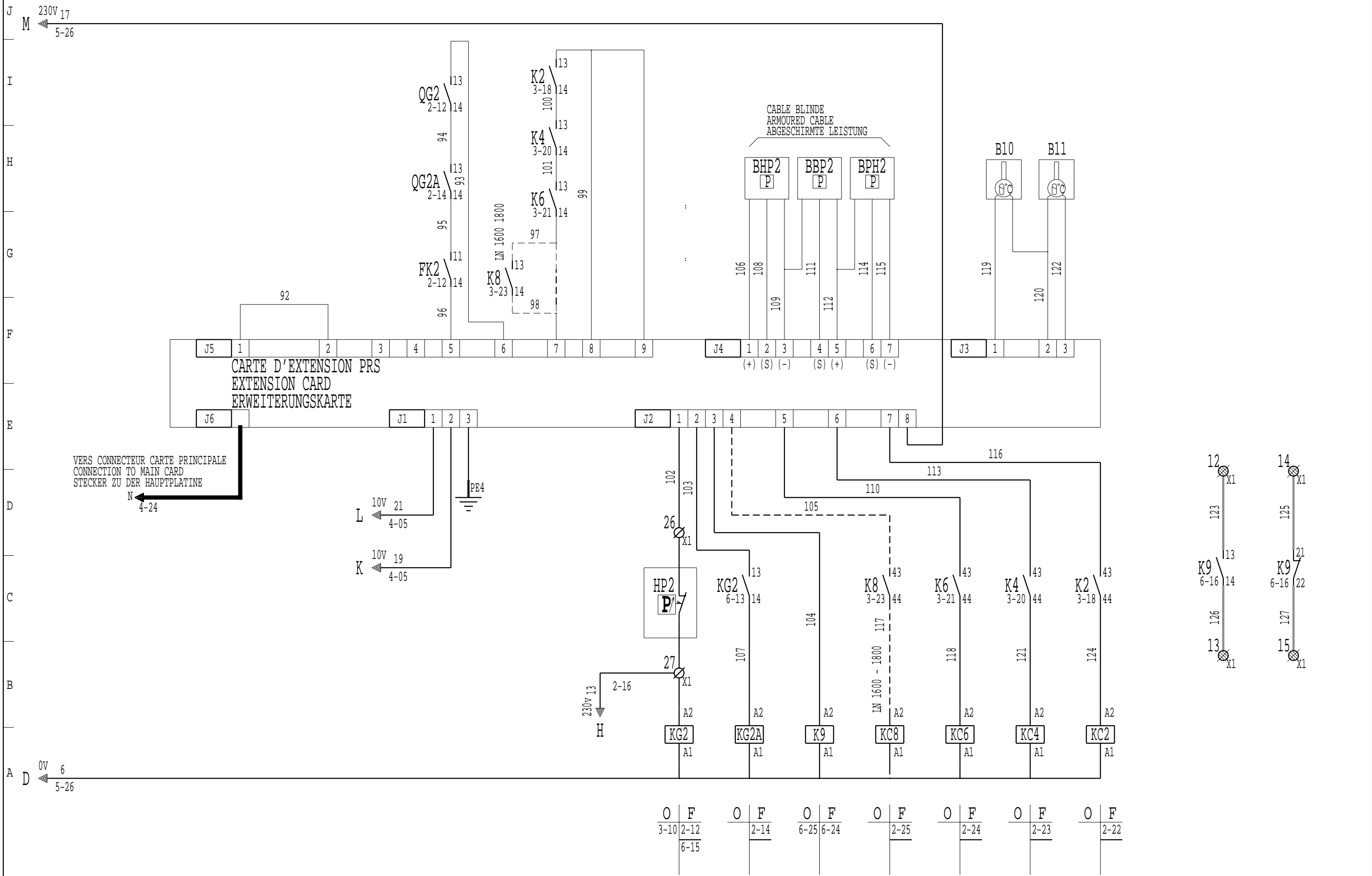

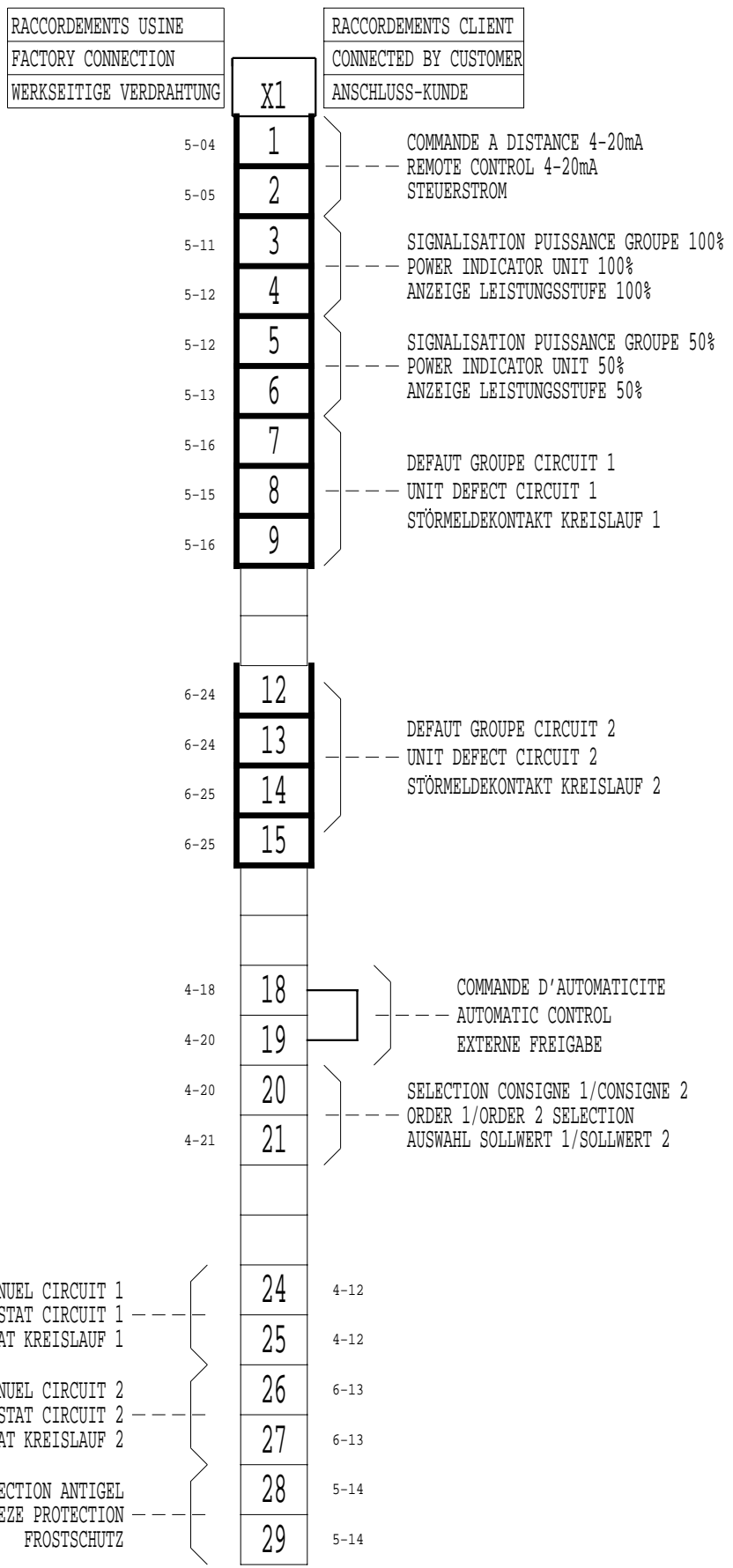

J  
I  
H  
G  
F  
E  
D  
C  
B  
A

### VARIATION DE CONSIGNE A DISTANCE

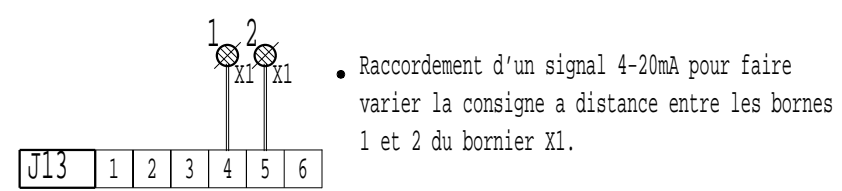

### SIGNALISATION PUISSANCE GROUPE

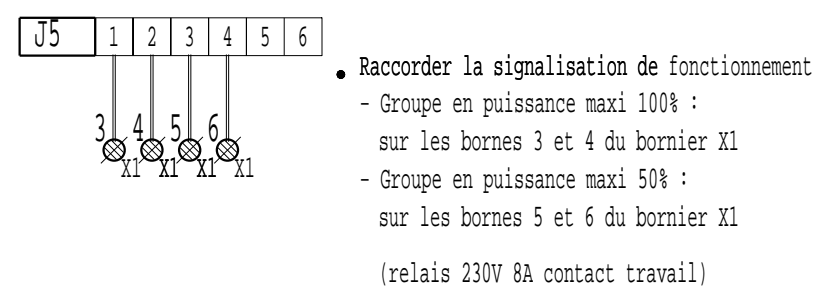

### DEFAULT GROUPE CIRCUIT 1

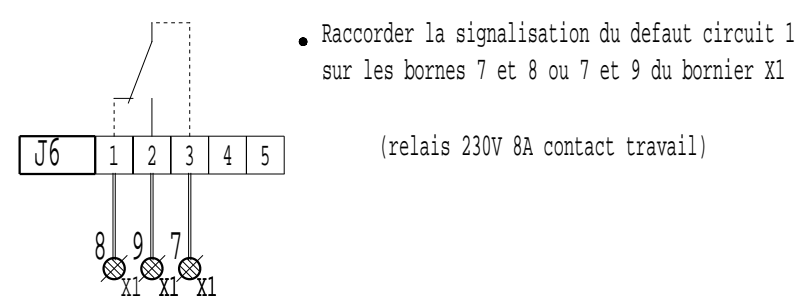

### DEFAULT GROUPE CIRCUIT 2

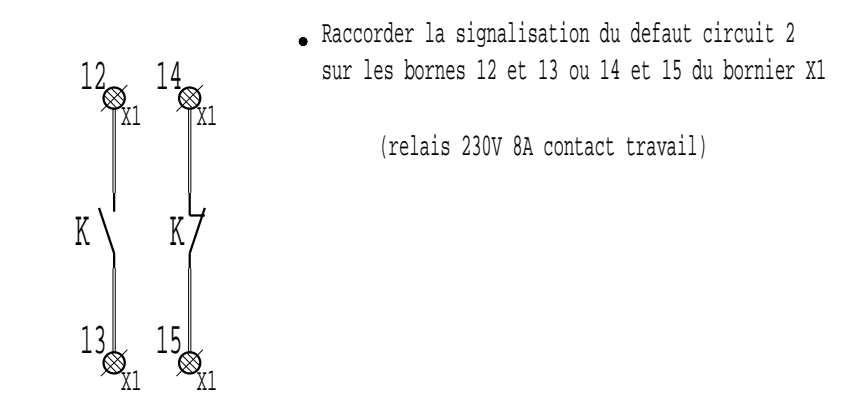

### REMOTE SETTING

• A 4-20mA signal, must be connected between terminals 1 and 2 on connector X1 for the modification of the set point .

### POWER INDICATOR UNIT

• The controle device must be connected to :  
 - terminals 3 and 4 on connector X1 for the power indicator unit 100%  
 - terminals 5 and 6 on connector X1 for the power indicator unit 50%  
 (relay 230V 8A)

### UNIT DEFECT CIRCUIT 1

• The fault or not-fault information on the unit can be recover on terminals 7 and 8 or 7 and 9 connector X1  
 (relay 230V 8A)

### UNIT DEFECT CIRCUIT 2

• The fault or not-fault information on the unit can be recover on terminals 12 and 13 or 14 and 15 connector X1  
 (relay 230V 8A)

## PRS

### STEUERSTROM (Sollwert)

• Der Modul 4-20mA Signal wird an den klemmen 1 und 2 Anschlüsse X1 angeschlossen

### ANZEIGE LEISTUNGSSTUFE

• Anzeige Leistungsstufe 100%  
 - Der Kontakt wird an den Klemmen 3 und 4 der Anschlüsse X1 angeschlossen  
 Anzeige Leistungsstufe 50%  
 - Der Kontakt wird an den Klemmen 5 und 6 der Anschlüsse X1 angeschlossen  
 (Relais 230V 8A)

### STÖRMELDEKONTAKT KREISLAUF 1

• Die Störungsmeldung wird an den Klemmen 7 und 8 oder 7 und 9 der Anschlüsse X1 angeschlossen  
 (Relais 230V 8A)

### STÖRMELDEKONTAKT KREISLAUF 2

• Die Störungsmeldung wird an den Klemmen 12 und 13 oder 14 und 15 der Anschlüsse X1 angeschlossen  
 (Relais 230V 8A)

**PRS**

J  
I  
H  
G  
F  
E  
D  
C  
B  
A

**COMMANDE DE POMPE**

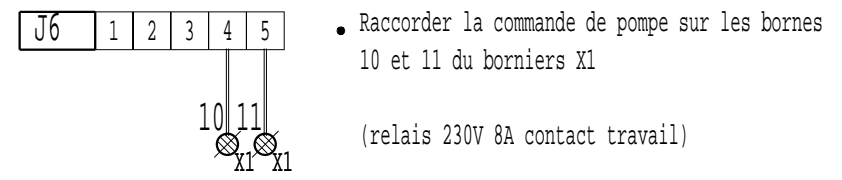

**PUMP CONTROL**

The pump control must be connected between terminals 10 and 11 on connector X1  
(relay 230V 8A)

**PUMPENSTEUERUNG**

Der Kontakt wird an den Klemmen 10 und 11 der Anschlüsse X1 angeschlossen  
(Relais 230V 8A)

**COMMANDE D'AUTOMATICITE**

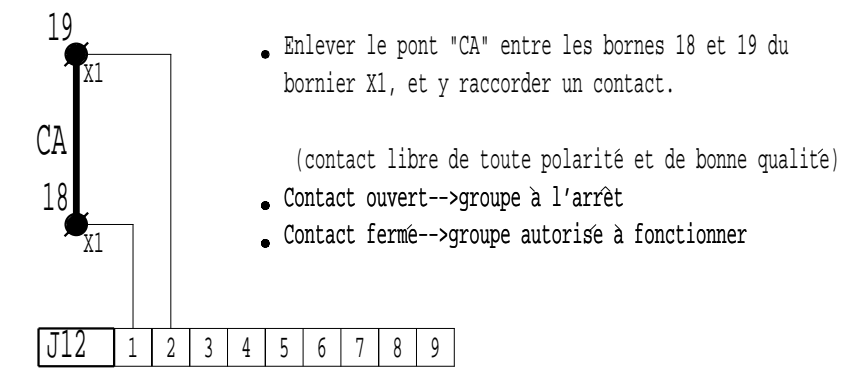

**AUTOMATIC CONTROL**

The shunt "CA" on terminals 18 and 19 of connector X1, must be lifted and the contact connected.  
(contact must be polarity free and of good quality)  
Contact open-->unit off-line  
Contact closed-->unit on-line

**EXTERNE FREIGABE**

Die Brücke "CA" an den Klemmen 18 und 19 am Anschluss X1 entfernen und externen Kontakt anschliessen.  
(Kontakt unbedingt potentialfrei anschliessen)  
Kontakt offen-->Gerät abgeschaltet  
Kontakt geschlossen-->Gerät in Betrieb

**SELECTION CONSIGNE 1 OU 2**

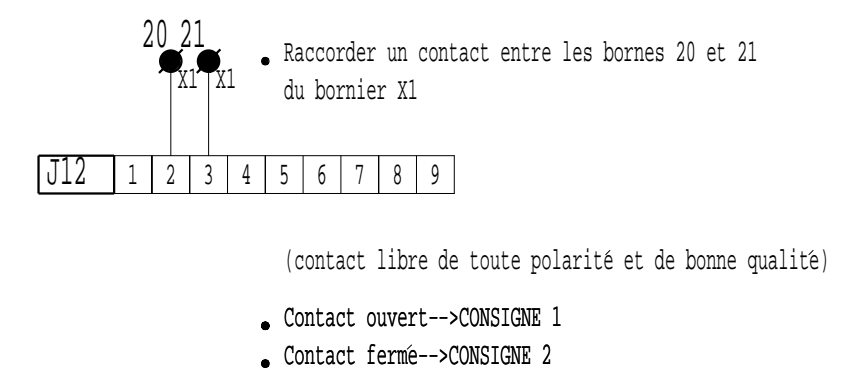

**SETTING 1 OR 2 SELECTION**

The controle must be connected to terminals 20 and 21 connector X1  
(contact must be polarity free and of good quality)  
Contact open-->SETTING 1 operation  
Contact closed-->SETTING 2 operation

**AUSWAHL SOLLWERT 1 ODER 2**

Der Kontakt wird an den Klemmen 20 und 21 der Anschlüsse X1 angeschlossen  
(Kontakt unbedingt potentialfrei anschliessen)  
Kontakt offen-->Sollwert 1  
Kontakt geschlossen-->Sollwert 2