

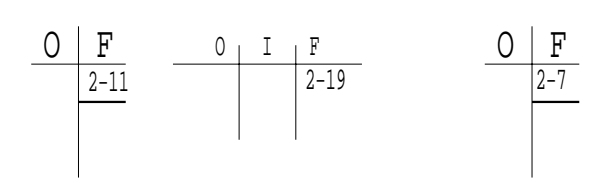

01	02	03	04	05	06	07	08	09	10	11	12	13	14	15	16	17	18	19	20	21	22	23	24	25	26
J																									
I																									
H																									
G																									
F																									
E																									
D																									
C																									
MODIFIE PAR: MODIFIED BY: GEANDERT DURCH:		INDICE INDEX KENNZIFFER	DATE DATE DATUM	FILS NUMEROTES EN OPTION NUMBERING OF WIRING IN OPTION OPTION KABEL NUMMERIERUNG										APPAREIL OU UNITE/UNIT/GERAT ODER EINHEIT											
SAG		36	23-12-99											LJA 100 A 300											
MODIFICATION				LEGENDE/LEGEND/LEGENDE										SPECIFICATION/SPECIFICATION/SPEZIFIZIERUNG											
A CDE RESISTANCE ANTIGEL				3950010.36										1 ET 2 COMPRESSEURS 1 CIRCUIT MRS4-2 1 AND 2 COMPRESSORS 1 CIRCUIT 1 UND 2 VERDICHTERN 1 KREISLAUF											
REPLACE/TAKE/ERSETZT		REPLACE PAR/TAKE BY/ERSETZT DURCH		CLIENT/CLIENT/KUNDE					REFERENCE/REFERENCE/REFERENZ					CREATEUR: CREATOR: HERSTELLER:		DATE: DATE: DATUM:									
														MA		18-02-97									
REFERENCES COMMANDE/ORDER REFERENCES/AUFTRAGSREFERENZ				DEMARRAGE/START/ANLAUF				TENSION/VOLTAGE/SPANNUNG				COMPAGNIE INDUSTRIELLE D'APPLICATIONS THERMIQUES				FOLIO/FOLIO/SEITE		NUMERO DE SCHEMA/DRAWING NUMBER/PLAN NR		INDICE/INDEX/KENNZIFFER					
														1 / 6		3980403		36							

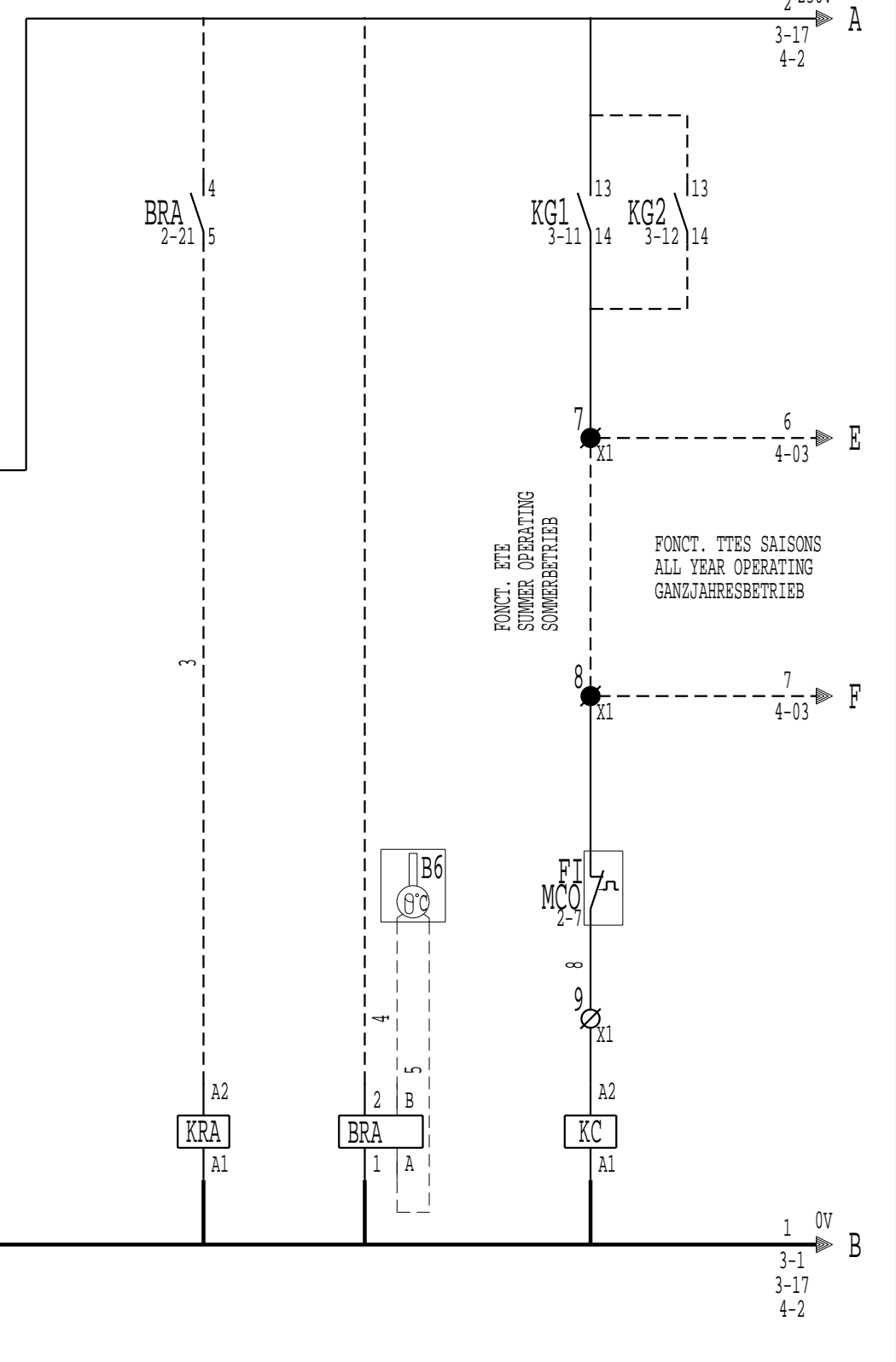

J
I
H
G
F
E
D
C
B
A

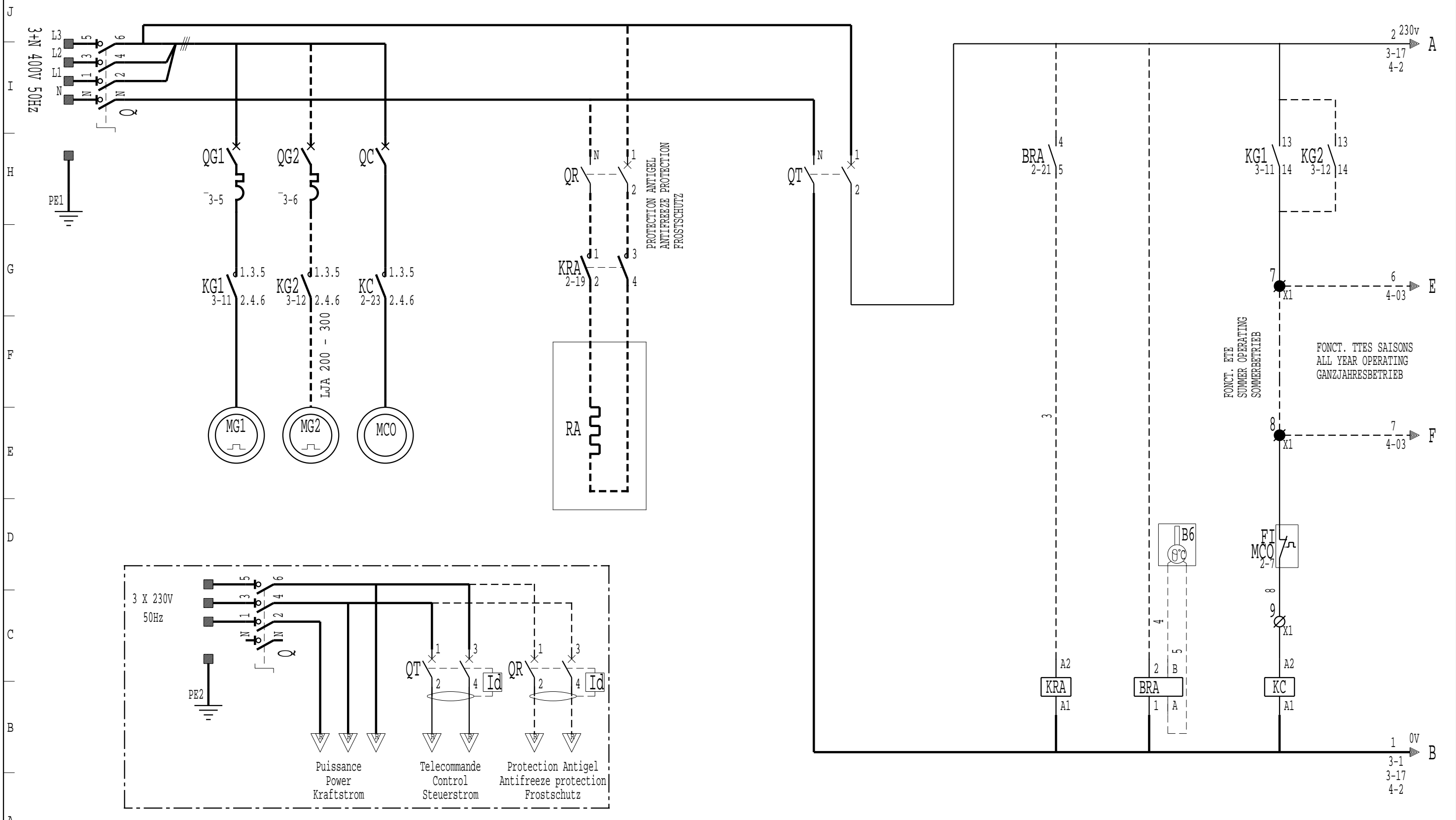
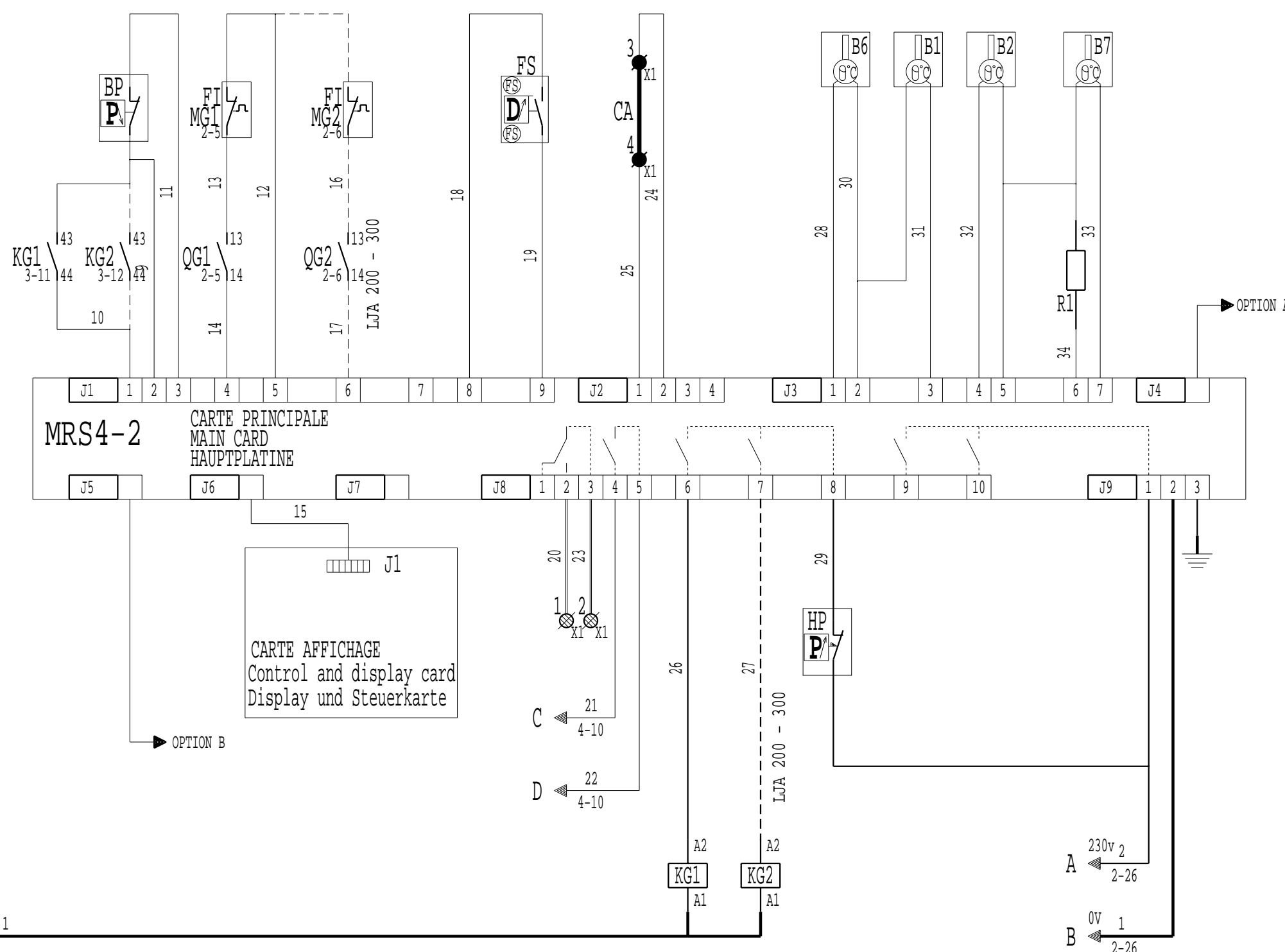

MRS4_2	
B1	Sonde entree eau glacee Inlet chilled water sensor Fühler Kaltwassereintritt
B2	Sonde sortie evaporateur N 1 Evaporator N 1 outlet sensor Austrittsfühler Verdampfer N 1
B3	Sonde temperature freon Refrigerant temperature sensor Fühler Kältemitteltemperatur
B5	Sonde eau chaude Hot water sensor Warmwasserfühler
B6	Sonde air exterieur External air sensor Aussenluftfühler
B7	Sonde de refluxement Discharge sensor Heissgasfühler

OPTION A MRS	
INTERFACE RX-TX (RS485-4 fils)	
INTERFACE RX-TX (RS485-4 WIRES)	
ANSCHLUSS INTERFACE RX-TX (RS485 - 4 ADERN)	

OPTION B MRS	
CAD-RELAYAGE-PC (RS485-2 fils)	
INTERFACE RX-TX (RS485-2 WIRES)	
ANSCHLUSS CAD-RELAIS-PC (RS485 - 2 ADERN)	

	HP - BP			FS
	PENN P77	RANCO 016	MINI	
BP	3 2	4 2	4 2	IT CONTROL 1 3/A/D
AUTO	1	1	1	
HP	3 2	2 4	2 4	PENN 1 2/A/D
MANU	1	1	1	
HP	2 3	4 2	2 4	1 13
AUTO	1	1	1	

O	F	O	F
2-5		2-6	
2-23		2-24	
3-2		3-3	

J
I
H
G
F
E
D
C
B
A

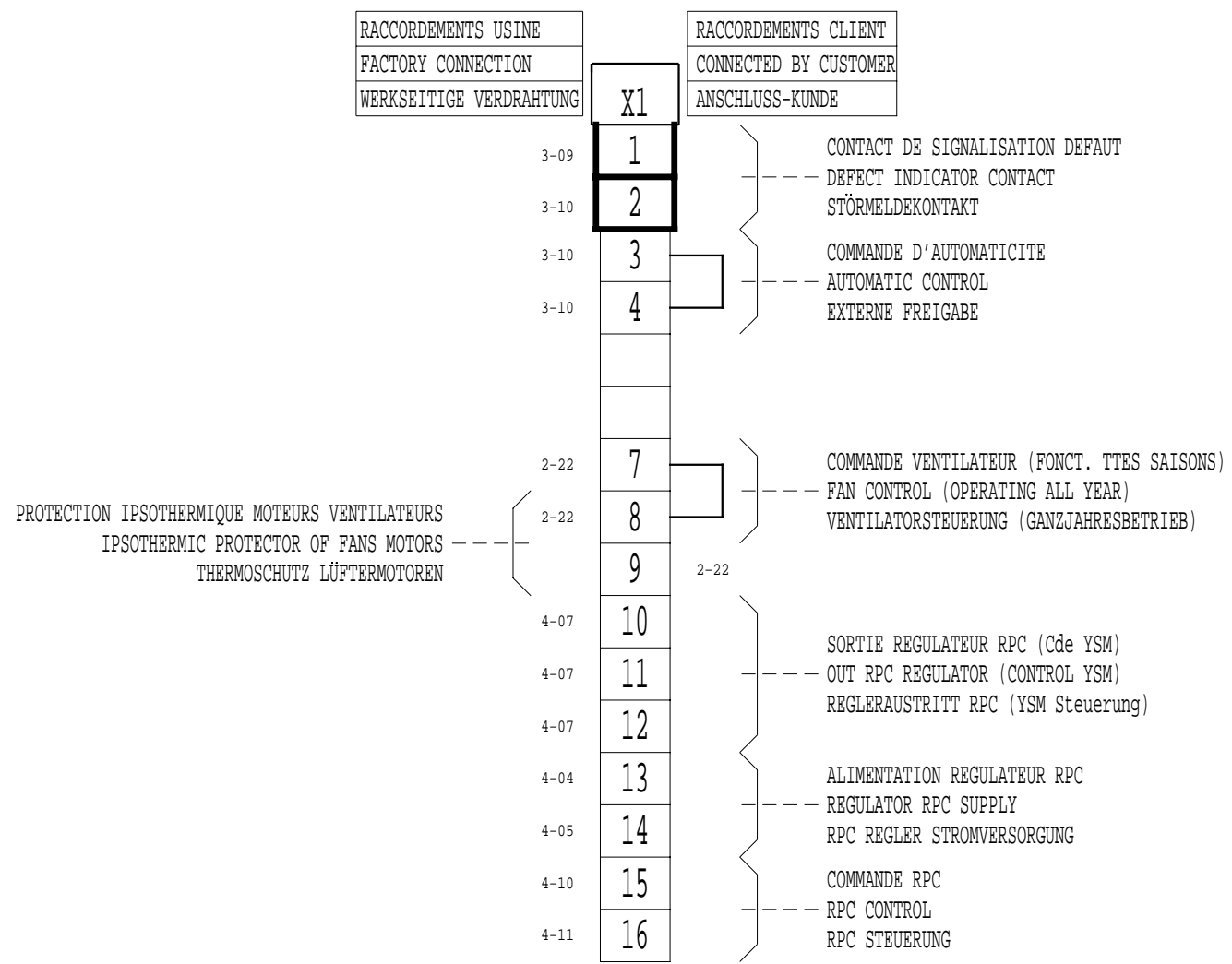
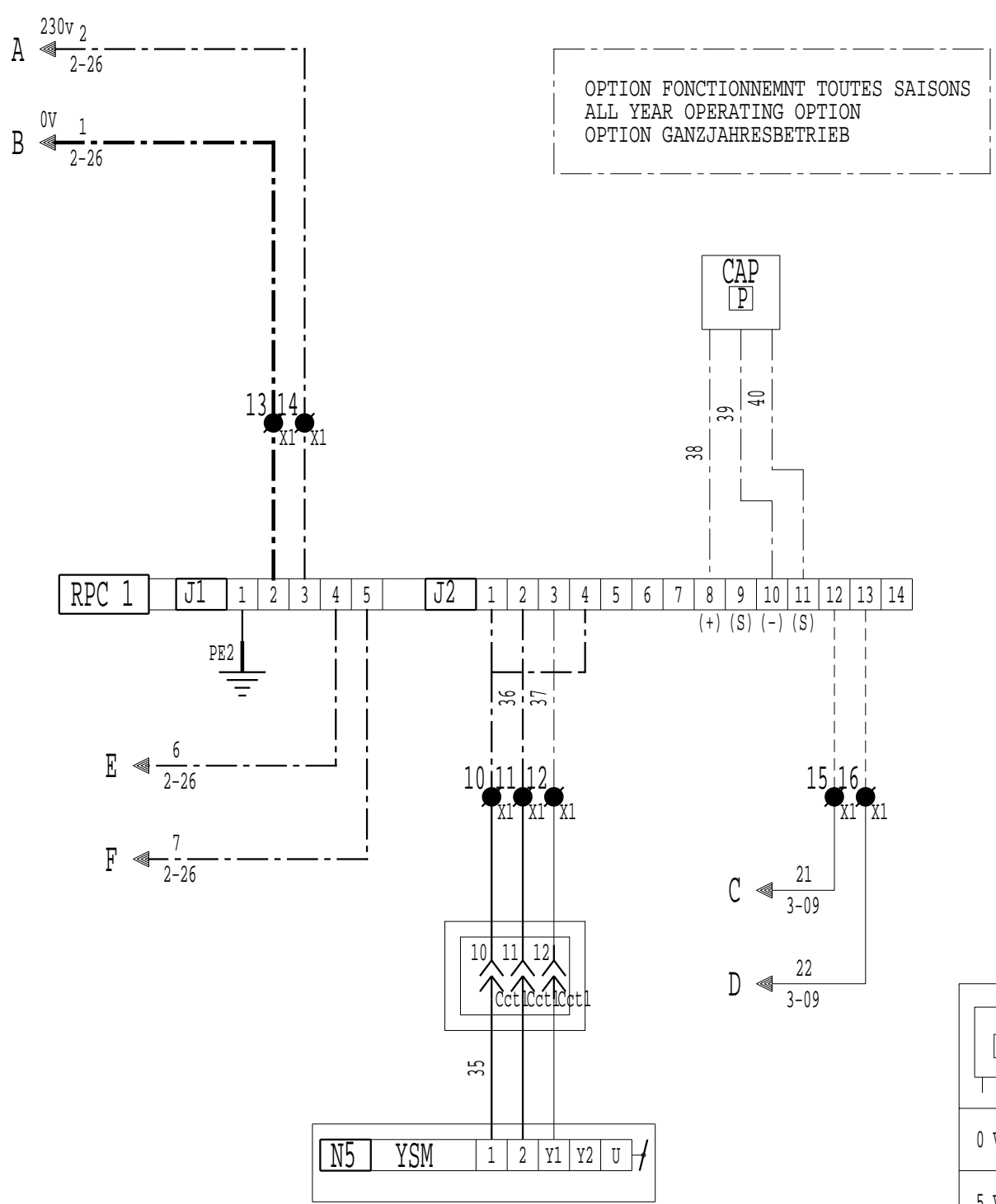

[P]	BBP-BHP-BH	
	DANFOSS	HUBA
0 V (-)	2	3
5 V (+)	1	1
S ↗	3	2

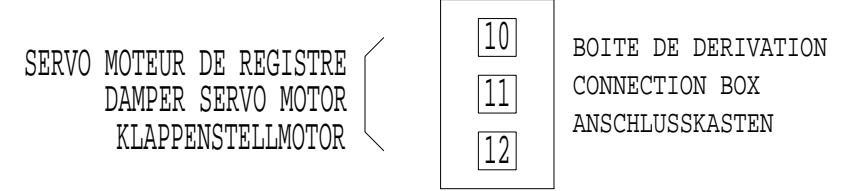

MRS4-2

DEFAUT GENERAL

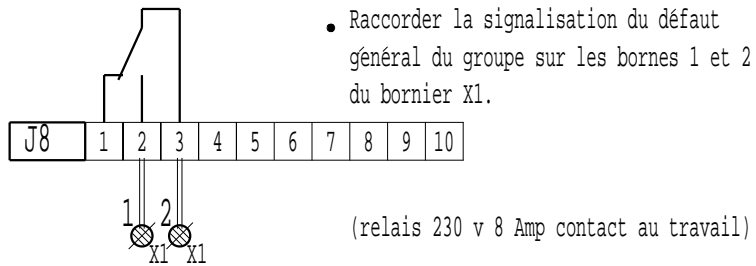

GENERAL FAULT

The fault or not-fault information on the unit can be recover on terminals 1 and 2 connector X1.

(relay 230V 8 Amp.)

SAMMELSTÖRMELDUNG

Die Störungsmeldung wird an den Klemmen 1 und 2 der Anschlusse X1 abgenommen.

(Relais 230V 8 Amp)

COMMANDE D'AUTOMATICITE

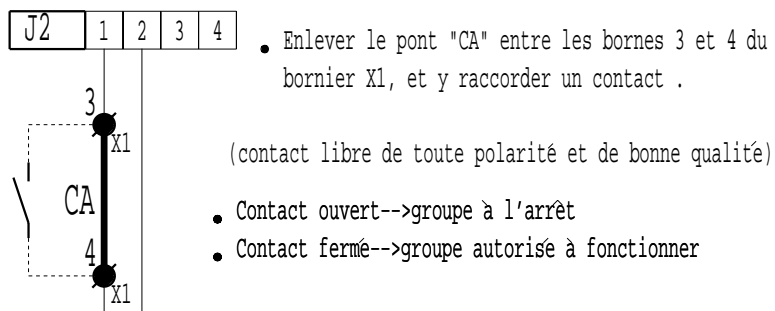

AUTOMATIC CONTROL

The shunt "CA" on terminals 3 and 4 of connector X1, must be lifted and the contact connected.
(contact must be polarity free and of good quality)

Contact open-->unit off-line
Contact closed-->unit on-line

EXTERNE FREIGABE

Die Brücke "CA" an den Klemmen 3 und 4 am Anschluss X1 entfernen und externen Kontakt anschliessen.
(Kontakt unbedingt potentialfrei anschliessen)

Kontakt offen-->Gerät abgeschaltet
Kontakt geschlossen-->Gerät Betriebsbereit

SELECTION CHAUD/FROID

- Configuration P17 valeur 3

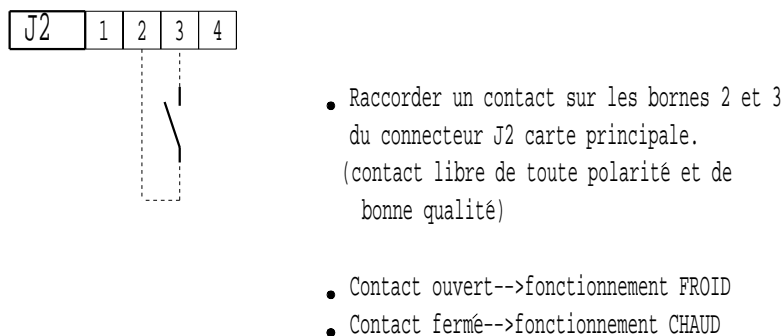

HEATING/COOLING SELECTION

- Configuration P17 value 3

The controle device must be connected to terminals 2 and 3 on connector J2 of main card.
(contact must be polarity free and of good quality)

Contact open-->COOLING operation
Contact closed-->HEATING operation

AUSWAHL HEIZ-O.KÜHLBETRIEB

- Konfiguration P17 Wert 3

Der Kontakt wird an den Klemmen 2 und 3 am Stecker J2 der Hauptplatine angeschlossen
(Kontakt unbedingt potentialfrei anschliessen)

Kontakt offen-->Kühlbetrieb
Kontakt geschlossen-->Heizbetrieb

MRS4-2

SELECTION CONSIGNE 1 ou 2

- Configuration P18 valeur 3

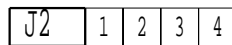

- Raccorder un contact entre les bornes 2 et 4 du connecteur J2 carte principale.
(contact libre de toute polarité et de bonne qualité)
- Contact ouvert-->CONSIGNE 1
- Contact fermé-->CONSIGNE 2

COMMANDE POMPE A EAU

- Raccorder l'alimentation de la pompe entre les bornes 4 et 5 du connecteur J8 de la carte principale.

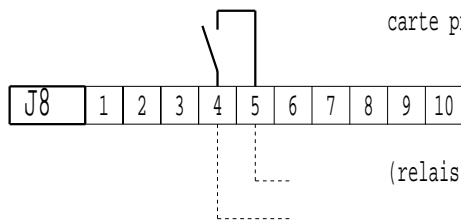

(relais 230V 8 Amp.)

COMMANDE DES ETAGES FORCES

- Configuration P16 valeur 2

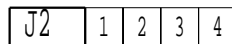

- Raccorder les contacts sur chaque entrée du connecteur J2 pour commander les différents étages
(contact libre de toute polarité et de bonne qualité)
- Suivant le nombre d'étages, il suffit de raccorder des contacts à fermeture.

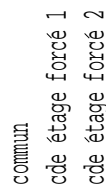

PRECAUTIONS DE RACCORDEMENT

POUR LES PRECAUTIONS A PRENDRE POUR LE RACCORDEMENT DES ENTREES
VOIR LE MANUEL D'UTILISATION MRS4-2 PARAGRAPHE :
"ASSERVISSEMENT ET COMMANDES EXTERNES"

SETTING 1 OR 2 SELECTION

- Configuration P18 value 3

- The controle must be connected to terminals 2 and 4 connector J2 main card.
(contact must be polarity free and of good quality)
- Contact open-->SETTING 1 operation
- Contact closed-->SETTING 2 operation

WATER POMP CONTROL

- The pump control must be connected to terminals 4 and 5 on connector J8 of main card.

(relay 230V 8 Amp.)

FORCED STAGES CONTROL

- Configuration P16 value 2

- The control of the various stages is made by an external control connected to the connector J2 of the main card.
(contact must be polarity free and of good quality)
- According to the number of stages, connection of NO (normally open) contacts is sufficient.

CAUTION

TO TAKE PRECAUTION FOR CLIENT'S CONNECTION OF INPUTS
SEE THE OPERATING AND MAINTENANCE INSTRUCTIONS OF
MICROCIAT MRS4-2 PARAGRAPH :
"SERVO CONTROL AND EXTERNAL CONTROLS"

AUSWAHL SOLLWERT 1 ODER 2

- Konfiguration P18 Wert 3

- Der Kontakt wird an den Klemmen 2 und 4 am Stecker J2 der Hauptplatine angeschlossen.
(Kontakt unbedingt potentialfrei anschliessen)
- Kontakt offen-->Sollwert 1
- Kontakt geschlossen-->Sollwert 2

PUMPENSTEUERUNG

- Der Kontakt wird an den Klemmen 4 und 5 am Stecker J8 der Hauptplatine angeschlossen.

(Relais 230V 8 Amp)

EXTERNERBETRIEB DER STUFEN

- Konfiguration P16 Wert 2

- Die Regelung der verschiedenen Stufen wird mit einem externen Kontakt am Stecker J2 der Hauptplatine hergestellt.
(Kontakt unbedingt potentialfrei anschliessen)
- Die Zuverdrahtende Kontaktanzahl ist von der Stufenanzahl abhängig.

ACHTUNG

Um Anschlussfehler zu vermeiden, unbedingt die Betriebs- und Wartungsanleitung MRS4-2 Abschnitt Regelung und externe Regelung beachten.

01	02	03	04	05	06	07	08	09	10	11	12	13	14	15	16	17	18	19	20	21	22	23	24	25	26
----	----	----	----	----	----	----	----	----	----	----	----	----	----	----	----	----	----	----	----	----	----	----	----	----	----

J																									
I																									
H																									
G																									
F																									
E																									
D																									
C																									

ZONE RESERVEE

MODIFIE PAR: MODIFIED BY: GEANDERT DURCH: BH		INDICE INDEX KENNZIFFER 01		DATE DATE DATUM 25-10-99		FILS NUMEROTES EN OPTION NUMBERING OF WIRING IN OPTION OPTION KABEL NUMMERIERUNG				APPAREIL OU UNITE/UNIT/GERAT ODER EINHEIT LJA 100 A 300													
MODIFICATION MAJ CARTE MRS4-2 ET AJOUT SONDE B7						LEGENDE/LEGEND/LEGENDE 3950010.36				SPECIFICATION/SPECIFICATION/SPEZIFIZIERUNG 2 COMPRESSEURS 1 CIRCUIT 2 COMPRESSORS 1 CIRCUIT 2 VERDICHTERN 1 KREISLAUF DEMARRAGE ETOILE-TRIANGLE GMV													
REMPLACE/TAKE/ERSETZT			REMPLACE PAR/TAKE BY/ERSERTZT DURCH			CLIENT/CLIENT/KUNDE				REFERENCE/REFERENCE/REFERENZ				CREATEUR: CREATOR: HERSTELLER: JMB		DATE: DATE: DATUM: 15-09-99							
REFERENCES COMMANDE/ORDER REFERENCES/AUFTRAGSREFERENZ						DEMARRAGE/START/ANLAUF				TENSION/VOLTAGE/SPANNUNG				COMPAGNIE INDUSTRIELLE D'APPLICATIONS THERMIQUES 		FOLIO/FOLIO/SEITE 1 / 6		NUMERO DE SCHEMA/DRAWING NUMBER/PLAN NR 3980961				INDICE/INDEX/KENNZIFFER 01	

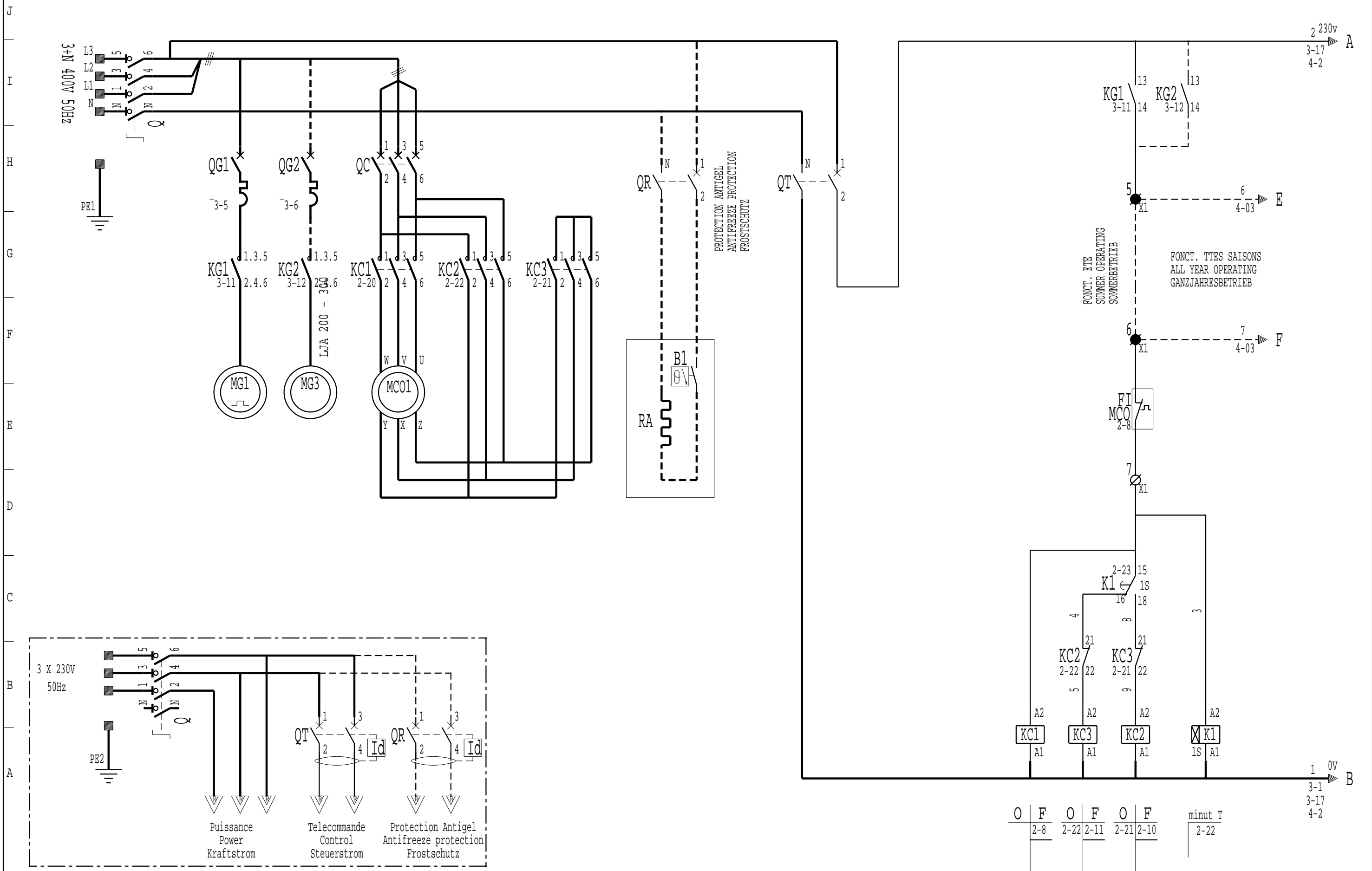

J
I
H
G
F
E
D
C
B
A

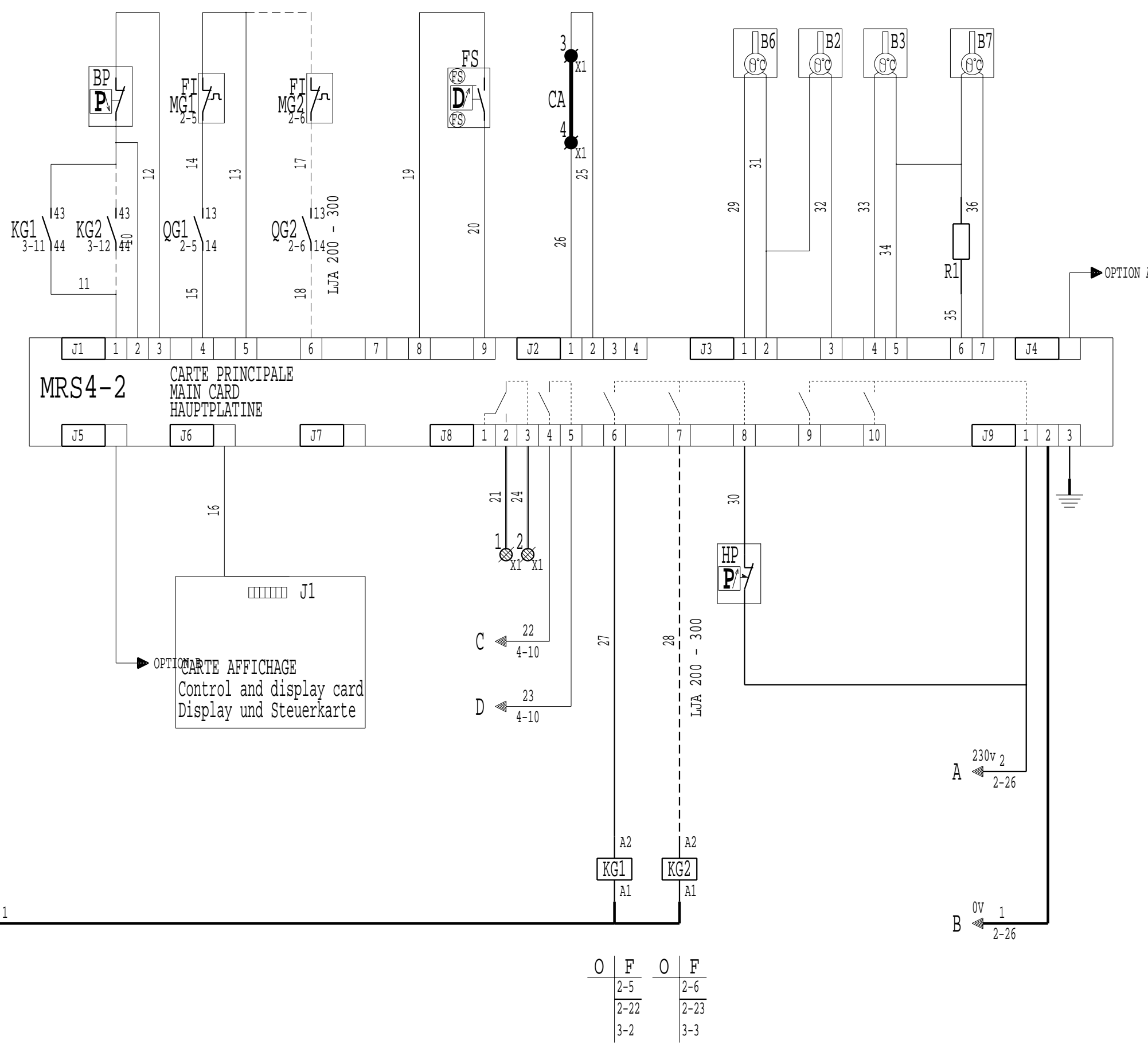

MRS4_2	
B1	Sonde entree eau glatee Inlet chilled water sensor Fühler Kaltwassereintritt
B2	Sonde sortie evaporateur N 1 Evaporator N 1 outlet sensor Austrittsfühler Verdampfer N 1
B3	Sonde temperature freon Refrigerant temperature sensor Fühler Kältemitteltemperatur
B5	Sonde eau chaude Hot water sensor Warmwasserfühler
B6	Sonde air exterieur External air sensor Aussenluftfühler
B7	Sonde de refolement Discharge sensor Heissgasfühler

OPTION A MRS	
INTERFACE RX-TX (RS485-4 fils)	
INTERFACE RX-TX (RS485-4 WIRES)	
ANSCHLUSS INTERFACE RX-TX (RS485 - 4 ADERN)	

OPTION B MRS	
CAD-RELAYAGE-PC (RS485-2 fils)	
INTERFACE RX-TX (RS485-2 WIRES)	
ANSCHLUSS CAD-RELAIS-PC (RS485 - 2 ADERN)	

	HP - BP			FS
	PENN P77	RANCO 016	MINI	
BP	3 2	4 2	4 2	IT CONTROL 1 3/A/D
AUTO	1	1	1	
HP	3 2	2 4	2 4	PENN 1 2/A/D
MANU	1	1	1	
HP	2 3	4 2	2 4	1 3
AUTO	1	1	1	

O	F	O	F
2-5	2-6	2-22	2-23
3-2	3-3		

J
I
H
G
F
E
D
C
B
A

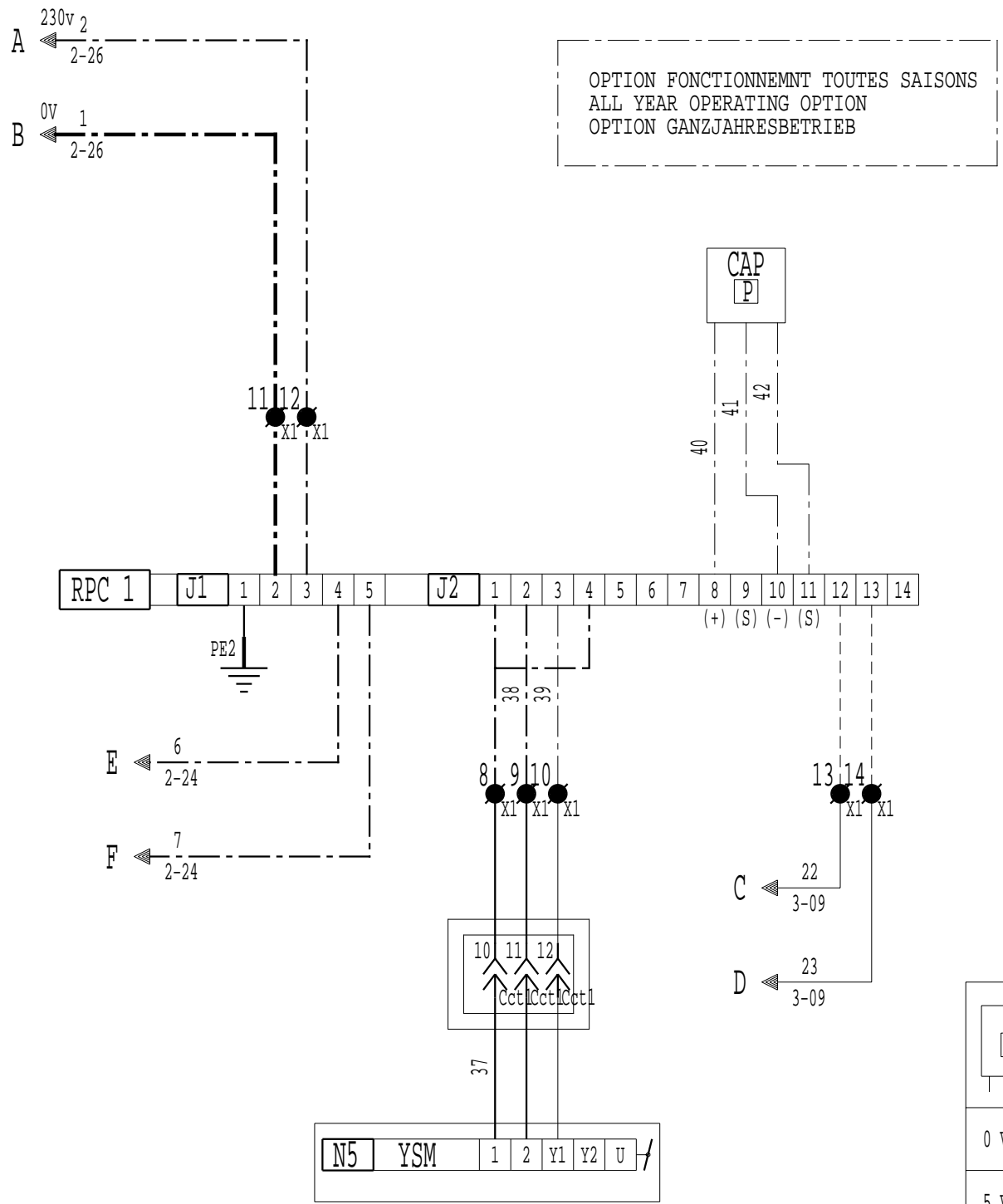

PROTECTION IPSOTHERMIQUE MOTEURS VENTILATEURS
IPISOTHERMIC PROTECTOR OF FANS MOTORS
THERMOSCHUTZ LÜFTERMOTOREN

RACCORDEMENTS USINE
FACTORY CONNECTION
WERKSEITIGE VERDRAHTUNG

RACCORDEMENTS CLIENT
CONNECTED BY CUSTOMER
ANSCHLUSS-KUNDE

RACCORDEMENTS USINE FACTORY CONNECTION WERKSEITIGE VERDRAHTUNG	X1	RACCORDEMENTS CLIENT CONNECTED BY CUSTOMER ANSCHLUSS-KUNDE
3-09	1	CONTACT DE SIGNALISATION DEFAULT DEFECT INDICATOR CONTACT STÖRMELDEKONTAKT
3-10	2	COMMANDE D'AUTOMATICITE AUTOMATIC CONTROL EXTERNE FREIGABE
3-10	3	COMMANDE VENTILATEUR (FONCT. TTES SAISONS) FAN CONTROL (OPERATING ALL YEAR) VENTILATORSTEUERUNG (GANZJAHRESBETRIEB)
3-10	4	
2-22	5	
2-22	6	
2-22	7	
4-07	8	
4-07	9	SORTIE REGULATEUR RPC (Cde YSM) OUT RPC REGULATOR (CONTROL YSM) REGLERAUSTRITT RPC (YSM Steuerung)
4-07	10	
4-04	11	ALIMENTATION REGULATEUR RPC REGULATOR RPC SUPPLY RPC REGLER STROMVERSORGUNG
4-05	12	
4-10	13	COMMANDE RPC RPC CONTROL RPC STEUERUNG
4-11	14	

[P]	BBP-BHP-BH	
	DANFOSS	HUBA
0 V (-)	2	3
5 V (+)	1	1
S ↗	3	2

SERVO MOTEUR DE REGISTRE
DAMPER SERVO MOTOR
KLAPPENSTELLMOTOR

10	BOITE DE DERIVATION CONNECTION BOX ANSCHLUSSKASTEN
11	
12	

MRS4-2

DEFAUT GENERAL

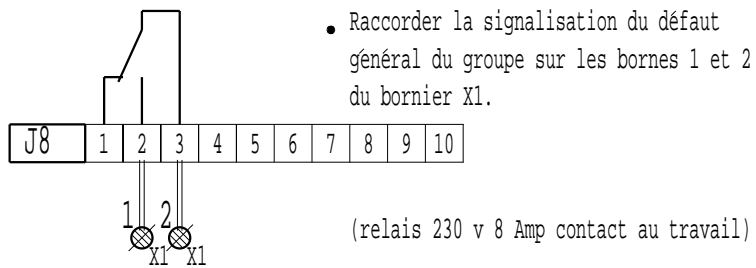

GENERAL FAULT

• The fault or not-fault information on the unit can be recover on terminals 1 and 2 connector X1.

(relay 230V 8 Amp.)

SAMMELSTÖRMELDUNG

• Die Störungsmeldung wird an den Klemmen 1 und 2 der Anschlusse X1 abgenommen.

(Relais 230V 8 Amp)

COMMANDE D'AUTOMATICITE

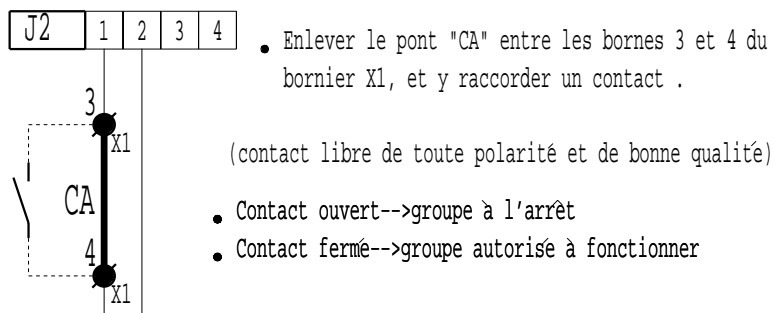

AUTOMATIC CONTROL

• The shunt "CA" on terminals 3 and 4 of connector X1, must be lifted and the contact connected.

(contact must be polarity free and of good quality)

- Contact open-->unit off-line
- Contact closed-->unit on-line

EXTERNE FREIGABE

• Die Brücke "CA" an den Klemmen 3 und 4 am Anschluss X1 entfernen und externen Kontakt anschliessen.

(Kontakt unbedingt potentialfrei anschliessen)

- Kontakt offen-->Gerät abgeschaltet
- Kontakt geschlossen-->Gerät Betriebsbereit

SELECTION CHAUD/FROID

- Configuration P17 valeur 3

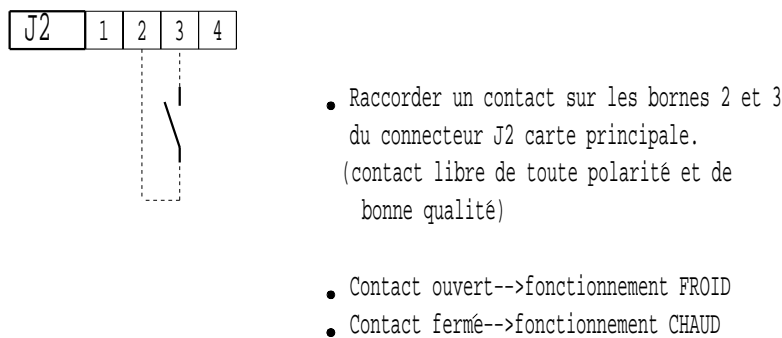

HEATING/COOLING SELECTION

- Configuration P17 value 3

• The controle device must be connected to terminals 2 and 3 on connector J2 of main card. (contact must be polarity free and of good quality)

- Contact open-->COOLING operation
- Contact closed-->HEATING operation

AUSWAHL HEIZ-O.KÜHLBETRIEB

- Konfiguration P17 Wert 3

• Der Kontakt wird an den Klemmen 2 und 3 am Stecker J2 der Hauptplatine angeschlossen (Kontakt unbedingt potentialfrei anschliessen)

- Kontakt offen-->Kühlbetrieb
- Kontakt geschlossen-->Heizbetrieb

MRS4-2

SELECTION CONSIGNE 1 ou 2

- Configuration P18 valeur 3

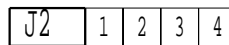

- Raccorder un contact entre les bornes 2 et 4 du connecteur J2 carte principale.
(contact libre de toute polarité et de bonne qualité)
- Contact ouvert-->CONSIGNE 1
- Contact fermé-->CONSIGNE 2

COMMANDE POMPE A EAU

- Raccorder l'alimentation de la pompe entre les bornes 4 et 5 du connecteur J8 de la carte principale.

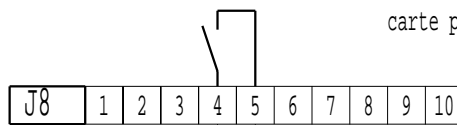

(relais 230V 8 Amp.)

COMMANDE DES ETAGES FORCES

- Configuration P16 valeur 2

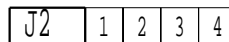

- Raccorder les contacts sur chaque entrée du connecteur J2 pour commander les différents étages
(contact libre de toute polarité et de bonne qualité)
- Suivant le nombre d'étages, il suffit de raccorder des contacts à fermeture.

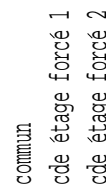

PRECAUTIONS DE RACCORDEMENT

POUR LES PRECAUTIONS A PRENDRE POUR LE RACCORDEMENT DES ENTREES
VOIR LE MANUEL D'UTILISATION MRS4-2 PARAGRAPHE :
"ASSERVISSEMENT ET COMMANDES EXTERNES"

SETTING 1 OR 2 SELECTION

- Configuration P18 value 3

- The controle must be connected to terminals 2 and 4 connector J2 main card.
(contact must be polarity free and of good quality)
- Contact open-->SETTING 1 operation
- Contact closed-->SETTING 2 operation

WATER POMP CONTROL

- The pump control must be connected to terminals 4 and 5 on connector J8 of main card.

(relay 230V 8 Amp.)

FORCED STAGES CONTROL

- Configuration P16 value 2

- The control of the various stages is made by an external control connected to the connector J2 of the main card.
(contact must be polarity free and of good quality)
- According to the number of stages, connection of NO (normally open) contacts is sufficient.

CAUTION

TO TAKE PRECAUTION FOR CLIENT'S CONNECTION OF INPUTS
SEE THE OPERATING AND MAINTENANCE INSTRUCTIONS OF
MICROCIAT MRS4-2 PARAGRAPH :
"SERVO CONTROL AND EXTERNAL CONTROLS"

AUSWAHL SOLLWERT 1 ODER 2

- Konfiguration P18 Wert 3

- Der Kontakt wird an den Klemmen 2 und 4 am Stecker J2 der Hauptplatine angeschlossen.
(Kontakt unbedingt potentialfrei anschliessen)
- Kontakt offen-->Sollwert 1
- Kontakt geschlossen-->Sollwert 2

PUMPENSTEUERUNG

- Der Kontakt wird an den Klemmen 4 und 5 am Stecker J8 der Hauptplatine angeschlossen.

(Relais 230V 8 Amp)

EXTERNERBETRIEB DER STUFEN

- Konfiguration P16 Wert 2

- Die Regelung der verschiedenen Stufen wird mit einem externen Kontakt am Stecker J2 der Hauptplatine hergestellt.
(Kontakt unbedingt potentialfrei anschliessen)
- Die Zuverdrahtende Kontaktanzahl ist von der Stufenanzahl abhängig.

ACHTUNG

Um Anschlussfehler zu vermeiden, unbedingt die Betriebs- und Wartungsanleitung MRS4-2 Abschnitt Regelung und externe Regelung beachten.

01	02	03	04	05	06	07	08	09	10	11	12	13	14	15	16	17	18	19	20	21	22	23	24	25	26		
J																											
I																											
H																											
G																											
F																											
E																											
D																											
C																											
MODIFIE PAR: MODIFIED BY: GEANDERT DURCH: SAG		INDICE INDEX KENNZIFFER 37		DATE DATE DATUM 21-12-99		FILS NUMEROTES NUMBERING OF WIRING KABEL NUMMERIERUNG						APPAREIL OU UNITE/UNIT/GERAT ODER EINHEIT LJAH 100 A 300															
MODIFICATION A CDE RESISTANCE ANTIGEL						LEGENDE/LEGEND/LEGENDE 3950010.36						SPECIFICATION/SPECIFICATION/SPEZIFIZIERUNG 1 ET 2 COMPRESSEURS 1 CIRCUIT MRS4-2 1 AND 2 COMPRESSORS 1 CIRCUIT 1 UND 2 VERDICHTERN 1 KREISLAUF															
REPLACE/TAKE/ERSETZT				REPLACE PAR/TAKE BY/ERSETZT DURCH				CLIENT/CLIENT/KUNDE				REFERENCE/REFERENCE/REFERENZ				CREATEUR: CREATOR: HERSTELLER: MA		DATE: DATE: DATUM: 12-02-97									
REFERENCES COMMANDE/ORDER REFERENCES/AUFTRAGSREFERENZ								DEMARRAGE/START/ANLAUF				TENSION/VOLTAGE/SPANNUNG				COMPAGNIE INDUSTRIELLE D'APPLICATIONS THERMIQUES				FOLIO/FOLIO/SEITE 1 / 7		NUMERO DE SCHEMA/DRAWING NUMBER/PLAN NR 3980396				INDICE/INDEX/KENNZIFFER 37	

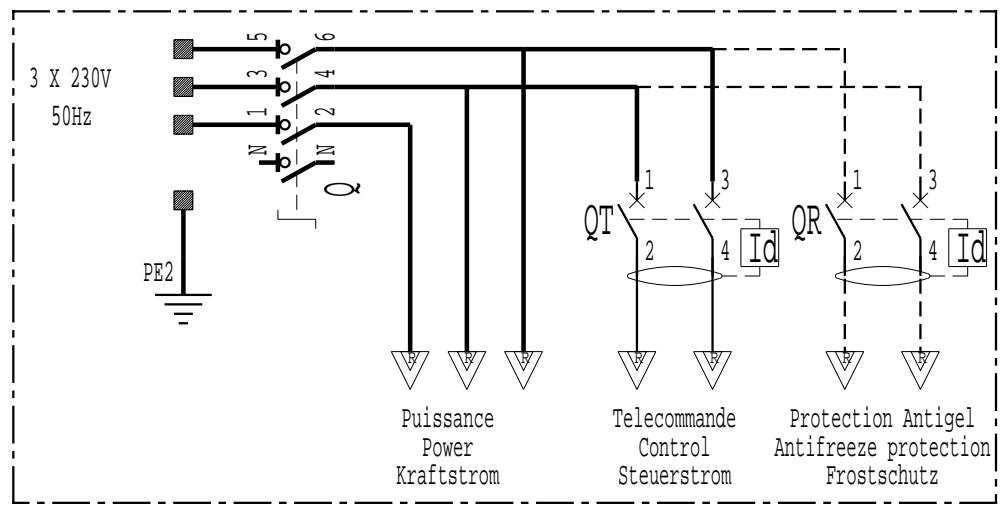
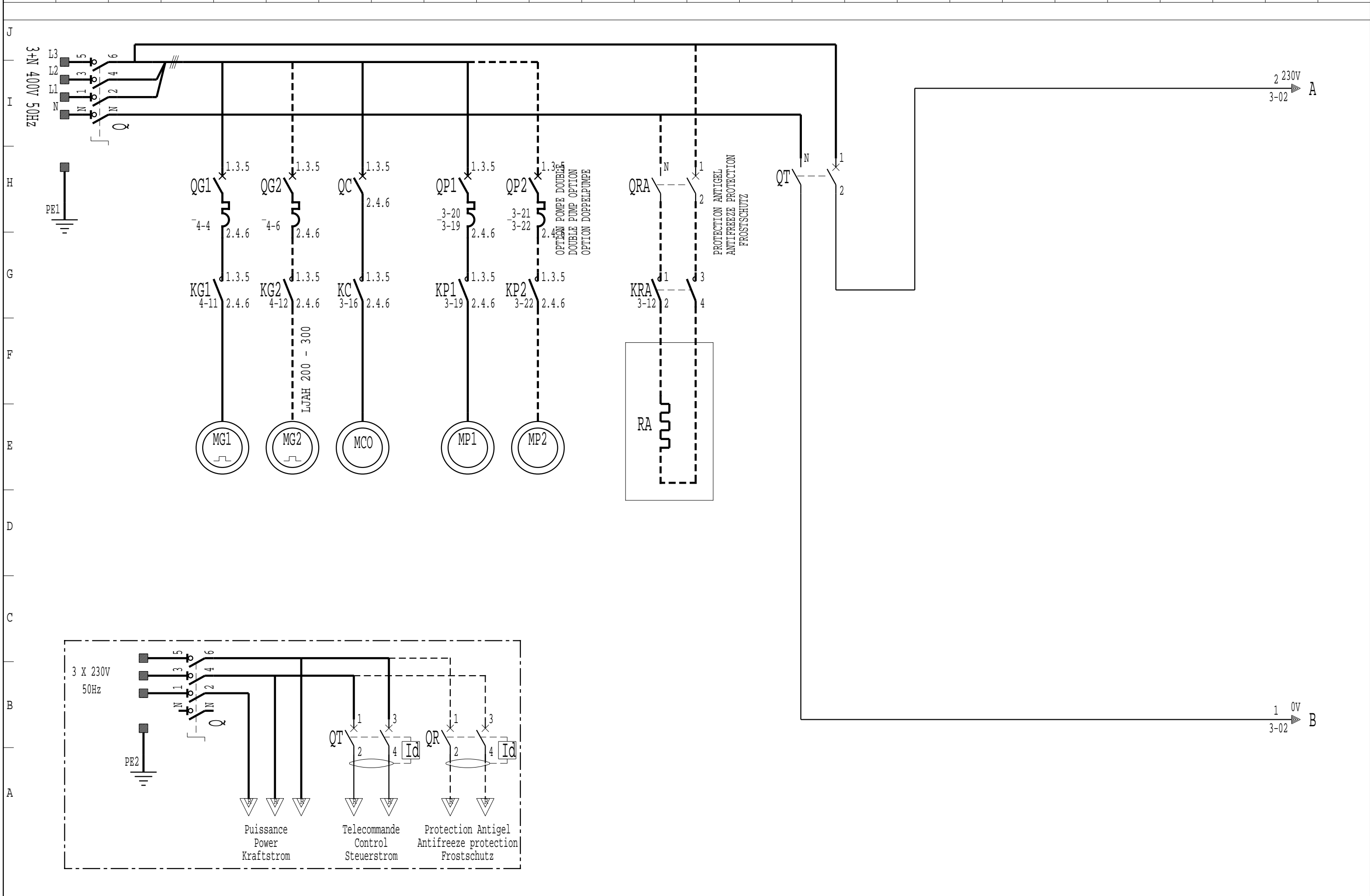

2 230V
3-02 A

1 0V
3-02 B

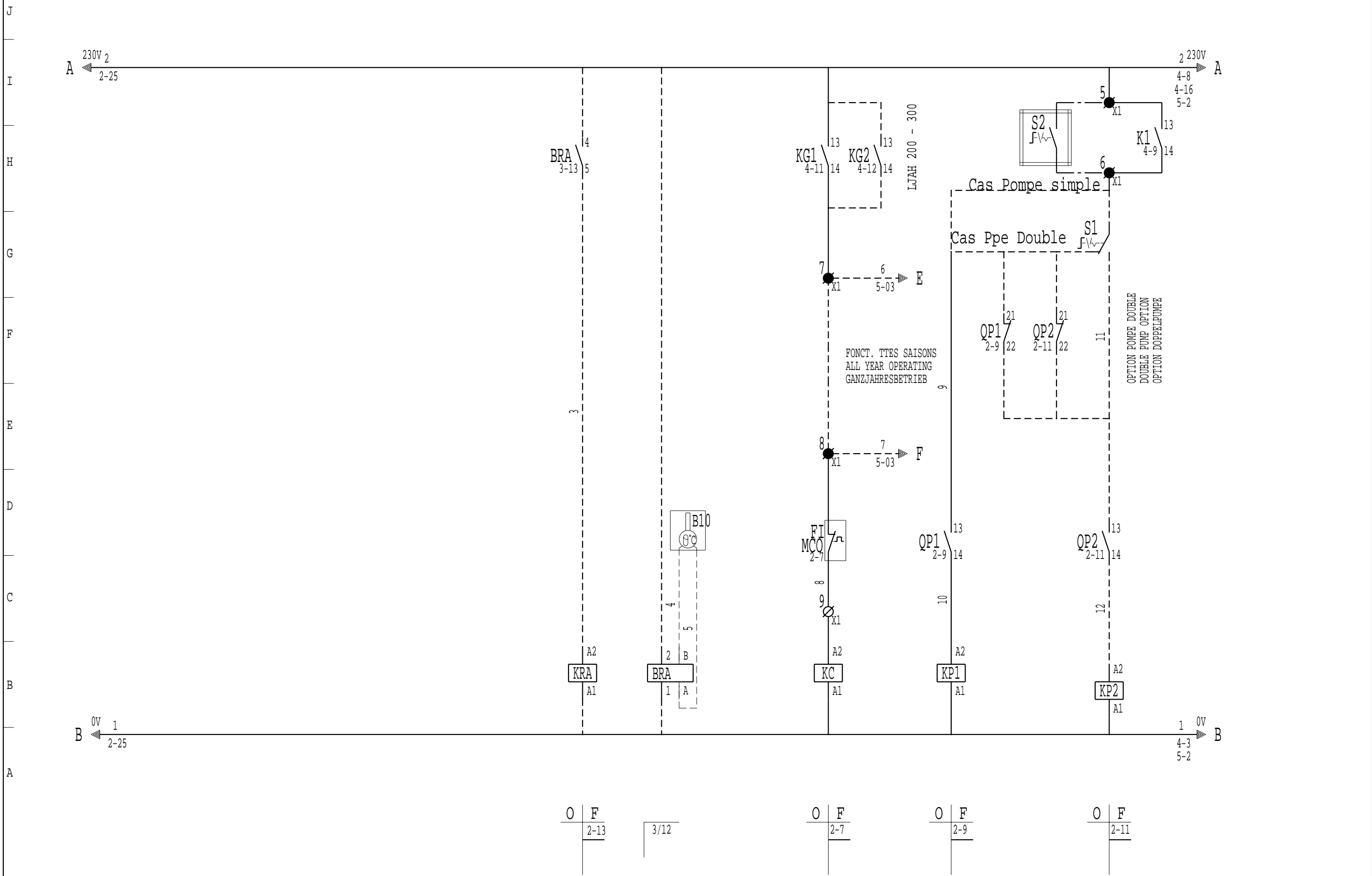

J
I
H
G
F
E
D
C
B
A

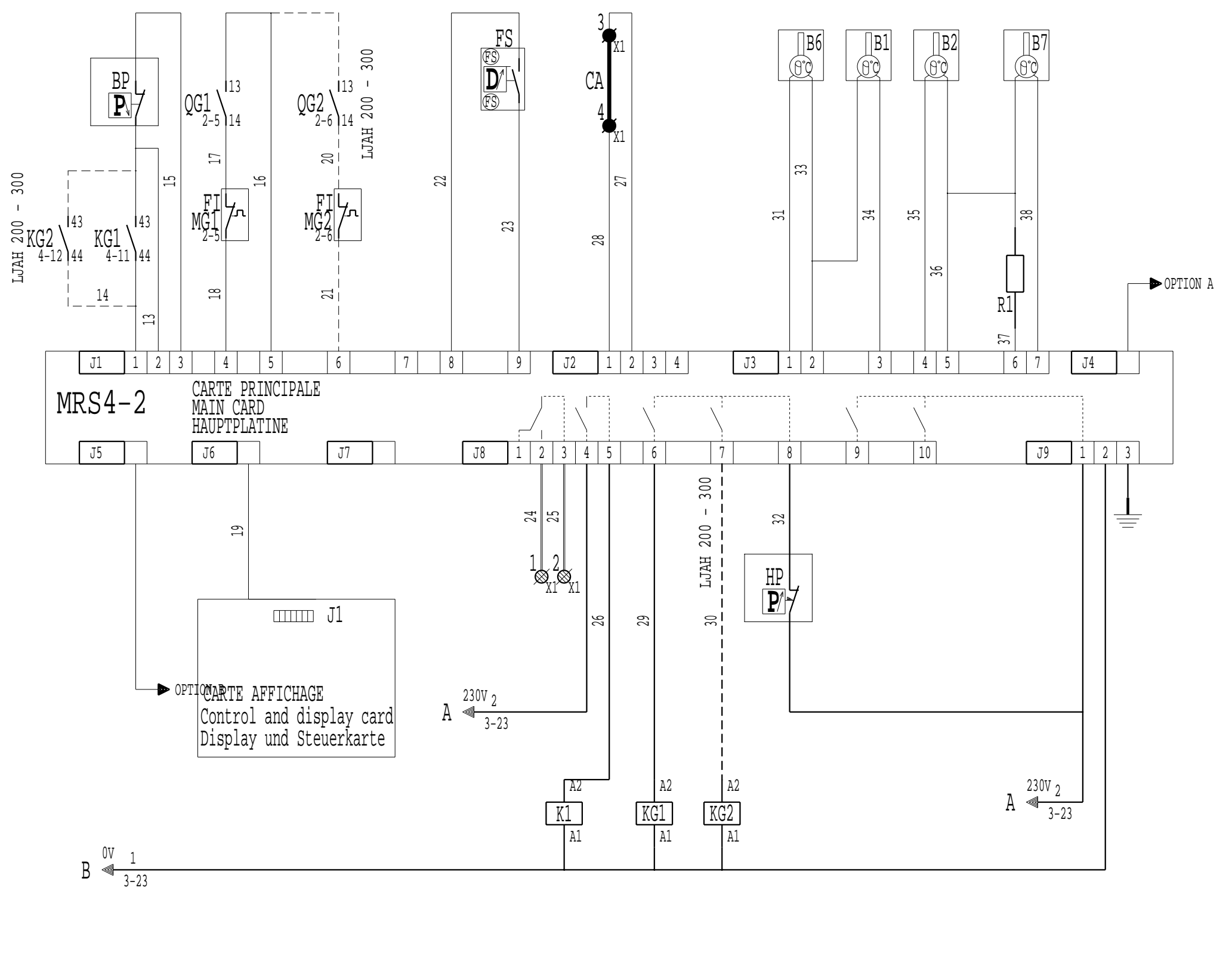

MRS4_2	
B1	Sonde entree eau glatee Inlet chilled water sensor Fühler Kaltwassereintritt
B2	Sonde sortie evaporateur N 1 Evaporator N 1 outlet sensor Austrittsfühler Verdampfer N 1
B3	Sonde temperature freon Refrigerant temperature sensor Fühler Kältemitteltemperatur
B5	Sonde eau chaude Hot water sensor Warmwasserfühler
B6	Sonde air exterieur External air sensor Aussenluftfühler
B7	Sonde de refolement Discharge sensor Heissgasfühler

OPTION A MRS	
INTERFACE RX-TX (RS485-4 fils)	
INTERFACE RX-TX (RS485-4 WIRES)	
ANSCHLUSS INTERFACE RX-TX (RS485 - 4 ADERN)	

OPTION B MRS	
CAD-RELAYAGE-PC (RS485-2 fils)	
INTERFACE RX-TX (RS485-2 WIRES)	
ANSCHLUSS CAD-RELAIS-PC (RS485 - 2 ADERN)	

	HP - BP			FS
	PENN P77	RANCO 016	MINI	
BP	3 2	4 2	4 2	IT CONTROL 1 3/D 2
AUTO	1	1	1	
HP	3 2	2 4	2 4	PENN 1 2/D 3
MANU	1	1	1	
HP	2 3	4 2	2 4	
AUTO	1	1	1	

Fermeture	O	F	O	F
3-23		2-5		2-6
5-10		3-16		3-17
		4-3		4-2

J
I
H
G
F
E
D
C
B
A

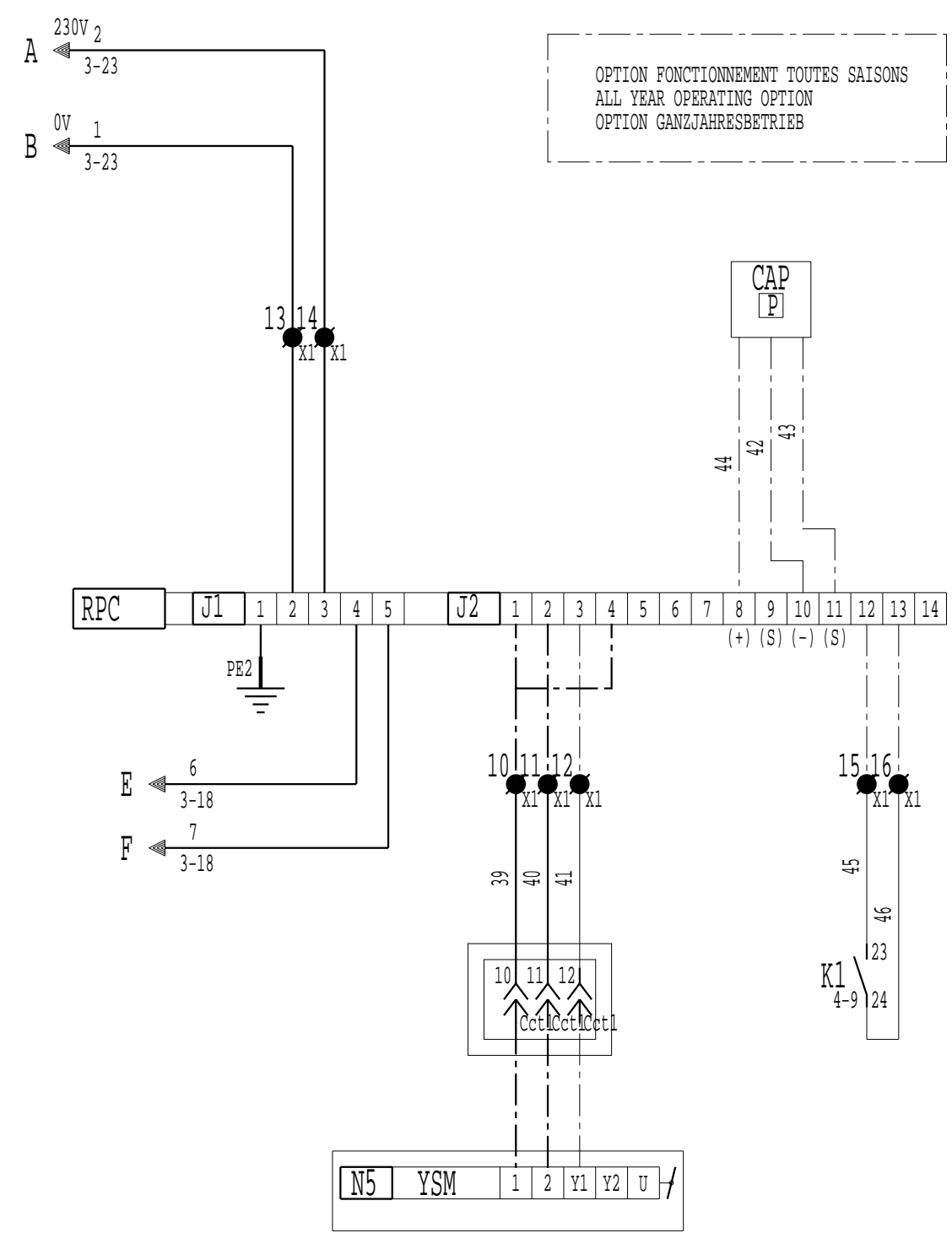

OPTION FONCTIONNEMENT TOUTES SAISONS
ALL YEAR OPERATING OPTION
OPTION GANZJAHRESBETRIEB

PROTECTION IPSOTHERMIQUE MOTEURS VENTILATEURS
IPSOTHERMIC PROTECTOR OF FANS MOTORS
THERMOSCHUTZ LÜFTERMOTOREN

RACCORDEMENTS USINE
FACTORY CONNECTION
WERKSEITIGE VERDRÄHTUNG

RACCORDEMENTS CLIENT
CONNECTED BY CUSTOMER
ANSCHLUSS-KUNDE

- | | | |
|------|----|---|
| 3-09 | 1 | CONTACT DE SIGNALISATION DEFAUT |
| 3-09 | 2 | DEFECT INDICATOR CONTACT
STÖRMELDEKONTAKT |
| 3-10 | 3 | COMMANDE D'AUTOMATICITE |
| 3-10 | 4 | AUTOMATIC CONTROL
EXTERNE FREIGABE |
| 2-24 | 5 | COMMANDE POMPES EAU |
| 2-24 | 6 | WATER PUMPS CONTROL
WASSERPUMPENSTEUERUNG |
| 2-18 | 7 | COMMANDE VENTILATEUR (FONCT. TTES SAISONS) |
| 2-18 | 8 | FAN CONTROL (OPERATING ALL YEAR)
VENTILATORSTEUERUNG (GANZJAHRESBETRIEB) |
| 2-18 | 9 | |
| 4-07 | 10 | SORTIE REGULATEUR RPC (Cde YSM) |
| 4-07 | 11 | OUT RPC REGULATOR (CONTROL YSM)
REGLERAUSTRITT RPC (YSM Steuerung) |
| 4-07 | 12 | |
| 4-04 | 13 | ALIMENTATION REGULATEUR RPC |
| 4-05 | 14 | REGULATOR RPC SUPPLY
RPC REGLER STROMVERSORGUNG |
| 4-10 | 15 | COMMANDE RPC |
| 4-11 | 16 | RPC CONTROL
RPC STEUERUNG |

[P]	BBP-BHP-BH	
	DANFOSS	HUBA
0 V (-)	2	3
5 V (+)	1	1
S ↗	3	2

SERVO MOTEUR DE REGISTRE
DAMPER SERVO MOTOR
KLAPPENSTELLMOTOR

- | | |
|----|---------------------|
| 10 | BOITE DE DERIVATION |
| 11 | CONNECTION BOX |
| 12 | ANSCHLUSSKASTEN |

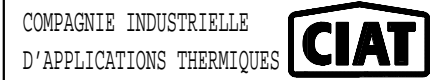

MRS4-2

DEFAUT GENERAL

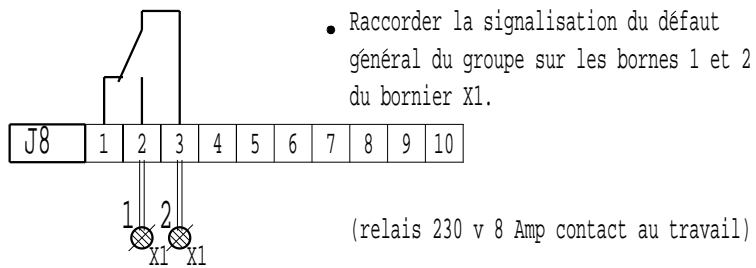

GENERAL FAULT

• The fault or not-fault information on the unit can be recover on terminals 1 and 2 connector X1.

(relay 230V 8 Amp.)

SAMMELSTÖRMELDUNG

• Die Störungsmeldung wird an den Klemmen 1 und 2 der Anschlusse X1 abgenommen.

(Relais 230V 8 Amp)

COMMANDE D'AUTOMATICITE

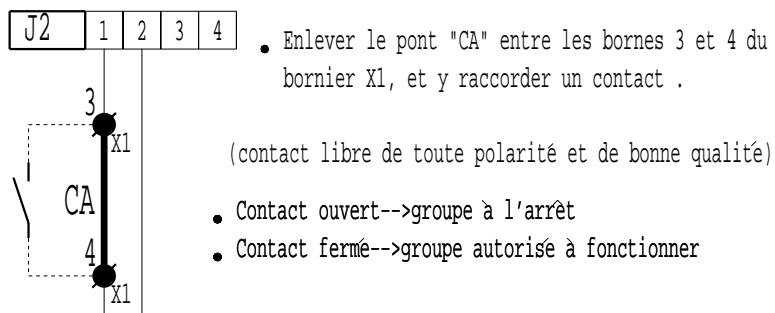

AUTOMATIC CONTROL

• The shunt "CA" on terminals 3 and 4 of connector X1, must be lifted and the contact connected.
(contact must be polarity free and of good quality)

• Contact open-->unit off-line
• Contact closed-->unit on-line

EXTERNE FREIGABE

• Die Brücke "CA" an den Klemmen 3 und 4 am Anschluss X1 entfernen und externen Kontakt anschliessen.
(Kontakt unbedingt potentialfrei anschliessen)

• Kontakt offen-->Gerät abgeschaltet
• Kontakt geschlossen-->Gerät Betriebsbereit

SELECTION CHAUD/FROID

- Configuration P17 valeur 3

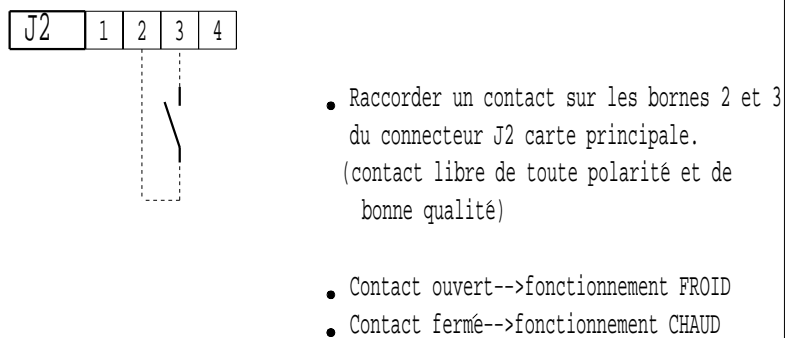

HEATING/COOLING SELECTION

- Configuration P17 value 3

• The controle device must be connected to terminals 2 and 3 on connector J2 of main card.
(contact must be polarity free and of good quality)

• Contact open-->COOLING operation
• Contact closed-->HEATING operation

AUSWAHL HEIZ-O.KÜHLBETRIEB

- Konfiguration P17 Wert 3

• Der Kontakt wird an den Klemmen 2 und 3 am Stecker J2 der Hauptplatine angeschlossen
(Kontakt unbedingt potentialfrei anschliessen)

• Kontakt offen-->Kühlbetrieb
• Kontakt geschlossen-->Heizbetrieb

MRS4-2

SELECTION CONSIGNE 1 ou 2

- Configuration P18 valeur 3

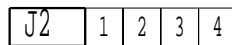

- Raccorder un contact entre les bornes 2 et 4 du connecteur J2 carte principale.
(contact libre de toute polarité et de bonne qualité)
- Contact ouvert-->CONSIGNE 1
- Contact fermé-->CONSIGNE 2

COMMANDE POMPE A EAU

- Raccorder l'alimentation de la pompe entre les bornes 4 et 5 du connecteur J8 de la carte principale.

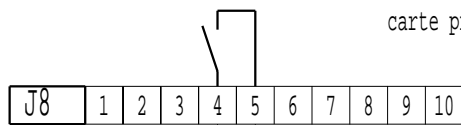

(relais 230V 8 Amp.)

COMMANDE DES ETAGES FORCES

- Configuration P16 valeur 2

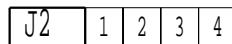

- Raccorder les contacts sur chaque entrée du connecteur J2 pour commander les différents étages
(contact libre de toute polarité et de bonne qualité)
- Suivant le nombre d'étages, il suffit de raccorder des contacts à fermeture.

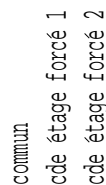

PRECAUTIONS DE RACCORDEMENT

POUR LES PRECAUTIONS A PRENDRE POUR LE RACCORDEMENT DES ENTrees
VOIR LE MANUEL D'UTILISATION MRS4-2 PARAGRAPHE :
"ASSERVISSEMENT ET COMMANDES EXTERNES"

SETTING 1 OR 2 SELECTION

- Configuration P18 value 3

- The controle must be connected to terminals 2 and 4 connector J2 main card.
(contact must be polarity free and of good quality)
- Contact open-->SETTING 1 operation
- Contact closed-->SETTING 2 operation

WATER POMP CONTROL

- The pump control must be connected to terminals 4 and 5 on connector J8 of main card.

(relay 230V 8 Amp.)

FORCED STAGES CONTROL

- Configuration P16 value 2

- The control of the various stages is made by an external control connected to the connector J2 of the main card.
(contact must be polarity free and of good quality)
- According to the number of stages, connection of NO (normally open) contacts is sufficient.

CAUTION

TO TAKE PRECAUTION FOR CLIENT'S CONNECTION OF INPUTS
SEE THE OPERATING AND MAINTENANCE INSTRUCTIONS OF
MICROCIAT MRS4-2 PARAGRAPHE :
"SERVO CONTROL AND EXTERNAL CONTROLS"

AUSWAHL SOLLWERT 1 ODER 2

- Konfiguration P18 Wert 3

- Der Kontakt wird an den Klemmen 2 und 4 am Stecker J2 der Hauptplatine angeschlossen.
(Kontakt unbedingt potentialfrei anschliessen)
- Kontakt offen-->Sollwert 1
- Kontakt geschlossen-->Sollwert 2

PUMPENSTEUERUNG

- Der Kontakt wird an den Klemmen 4 und 5 am Stecker J8 der Hauptplatine angeschlossen.

(Relais 230V 8 Amp)

EXTERNERBETRIEB DER STUFEN

- Konfiguration P16 Wert 2

- Die Regelung der verschiedenen Stufen wird mit einem externen Kontakt am Stecker J2 der Hauptplatine hergestellt.
(Kontakt unbedingt potentialfrei anschliessen)
- Die Zuverdrahtende Kontaktanzahl ist von der Stufenanzahl abhängig.

ACHTUNG

Um Anschlussfehler zu vermeiden, unbedingt die Betriebs- und Wartungsanleitung MRS4-2 Abschnitt Regelung und externe Regelung beachten.

01	02	03	04	05	06	07	08	09	10	11	12	13	14	15	16	17	18	19	20	21	22	23	24	25	26
J																									
I																									
H																									
G																									
F																									
E																									
D																									
C																									
MODIFIE PAR: MODIFIED BY: GEANDERT DURCH: SAG		INDICE INDEX KENNZIFFER 31	DATE DATE DATUM 22-12-99	FILS NUMEROTES EN OPTION NUMBERING OF WIRING IN OPTION OPTION KABEL NUMMERIERUNG		APPAREIL OU UNITE/UNIT/GERAT ODER EINHEIT LJA 350 A 450																			
MODIFICATION A CDE RESISTANCE ANTIGEL			LEGENDE/LEGEND/LEGENDE 3950010.36		SPECIFICATION/SPECIFICATION/SPEZIFIZIERUNG 3 COMPRESSEURS 2 CIRCUITS MRS1-4 3 COMPRESSORS 2 CIRCUITS 3 VERDICHTERN 2 KREISLAUFE																				
REPLACE/TAKE/ERSETZT		REPLACE PAR/TAKE BY/ERSETZT DURCH		CLIENT/CLIENT/KUNDE		REFERENCE/REFERENCE/REFERENZ		CREATEUR: CREATOR: HERSTELLER:	JMB	DATE: DATE: DATUM:	10-07-98														
REFERENCES COMMANDE/ORDER REFERENCES/AUFTRAGSREFERENZ				DEMARRAGE/START/ANLAUF		TENSION/VOLTAGE/SPANNUNG		COMPAGNIE INDUSTRIELLE D'APPLICATIONS THERMIQUES			FOLIO/FOLIO/SEITE 1 / 6	NUMERO DE SCHEMA/DRAWING NUMBER/PLAN NR 3980758		INDICE/INDEX/KENNZIFFER 31											

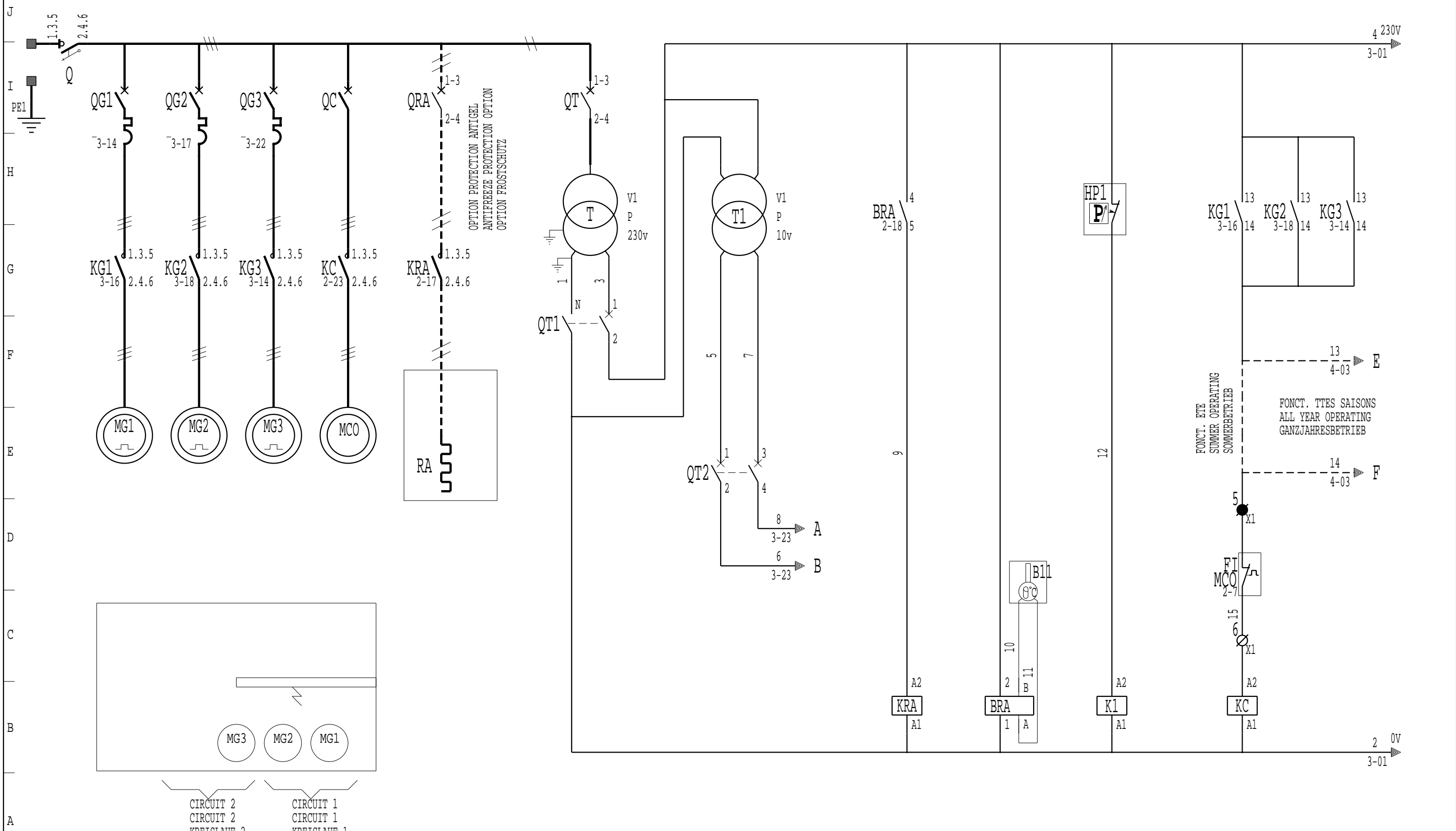

O | F
 2-8 | 2/17
 Fermeture
 3-10
 3-16
 3-18
 O | F
 2-7

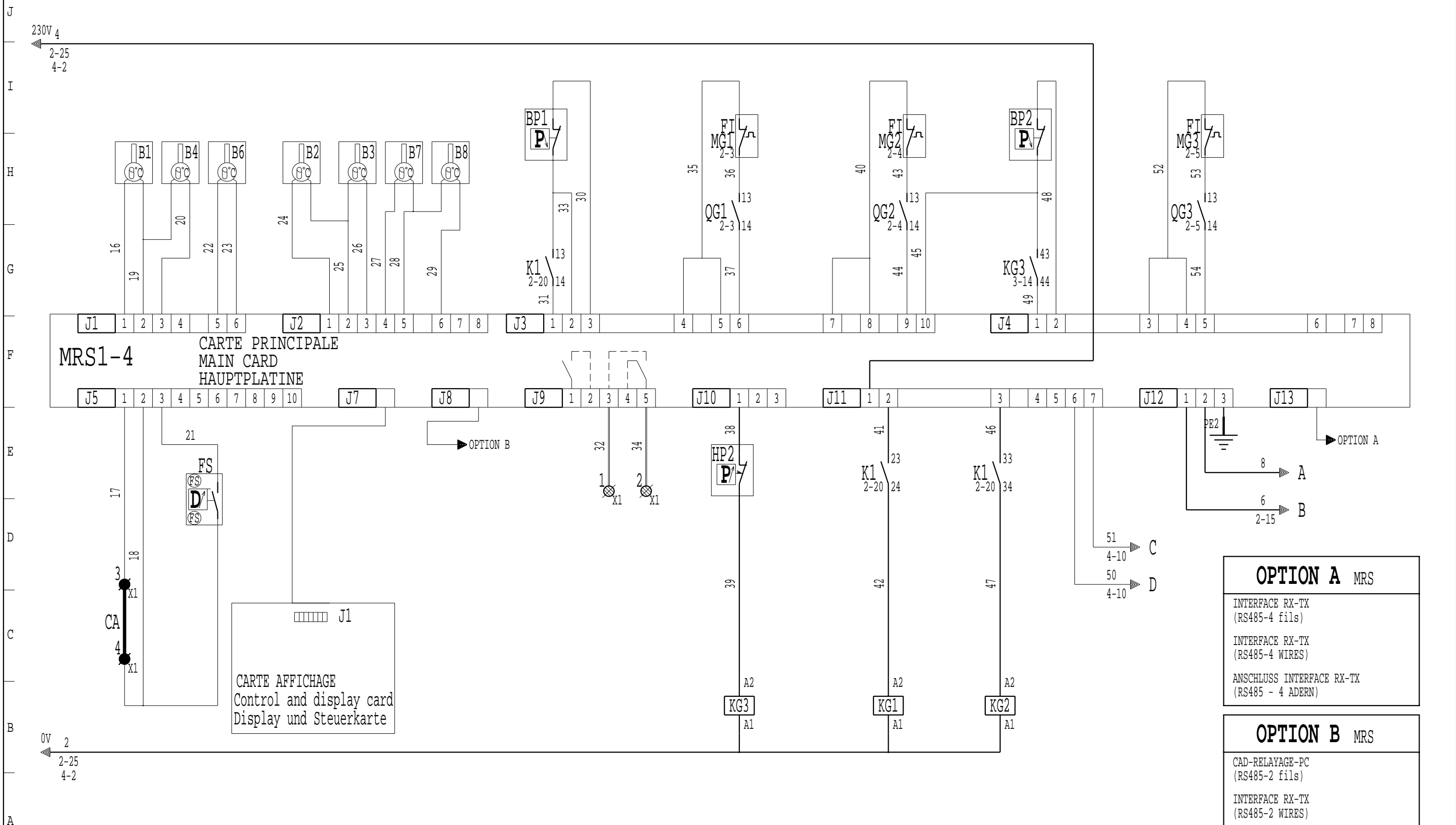

OPTION A MRS

INTERFACE RX-TX
(RS485-4 fils)

INTERFACE RX-TX
(RS485-4 WIRES)

ANSCHLUSS INTERFACE RX-TX
(RS485 - 4 ADERN)

OPTION B MRS

CAD-RELAYAGE-PC
(RS485-2 fils)

INTERFACE RX-TX
(RS485-2 WIRES)

ANSCHLUSS CAD-RELAIS-PC
(RS485 - 2 ADERN)

O	F	O	F	O	F
	2-5		2-3		2-4
	2-25		2-23		2-24
	3-19				

J
I
H
G
F
E
D
C
B
A

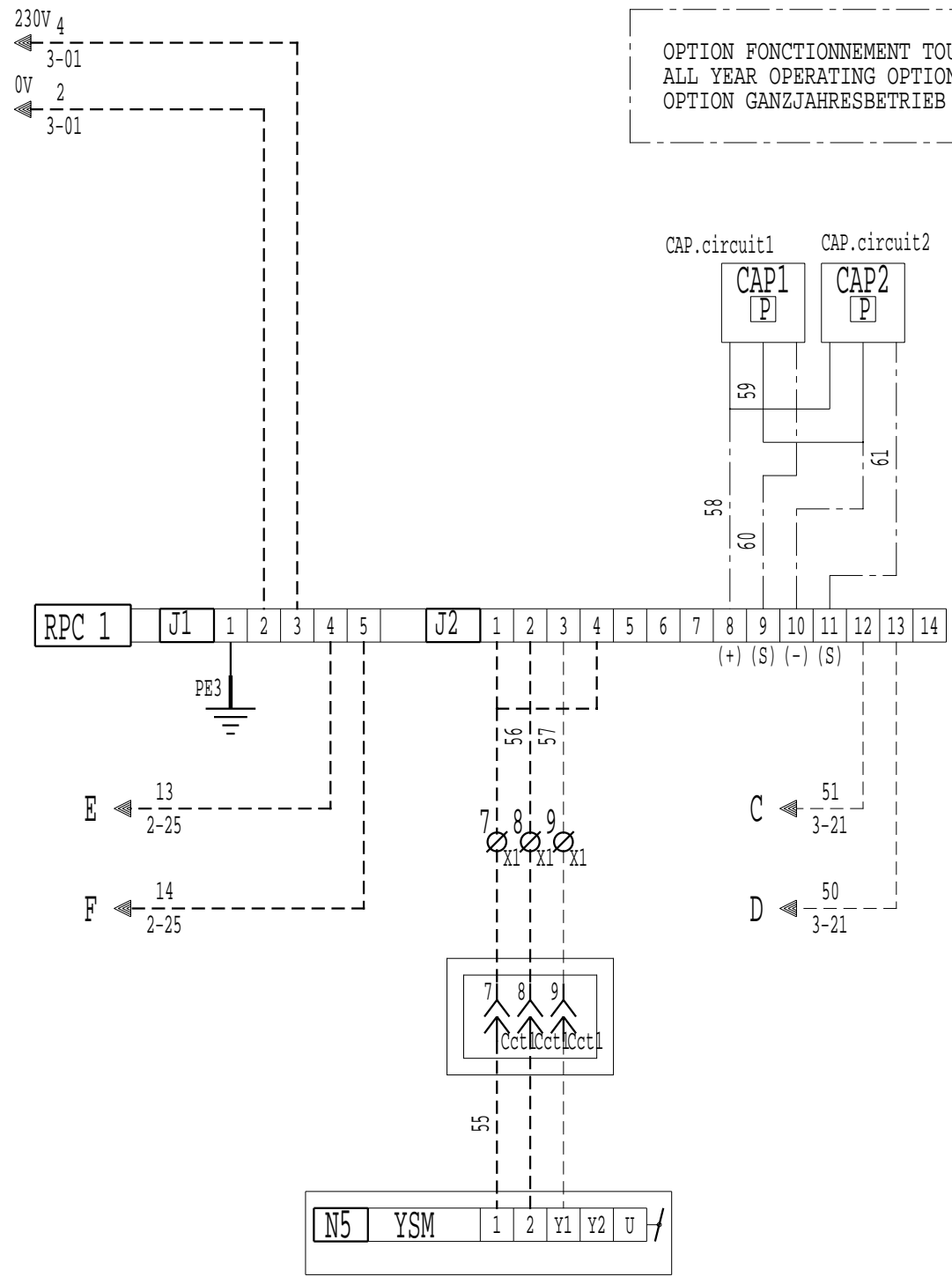

OPTION FONCTIONNEMENT TOUTES SAISONS
ALL YEAR OPERATING OPTION
OPTION GANZJAHRESBETRIEB

RACCORDEMENTS USINE
FACTORY CONNECTION
WERKSEITIGE VERDRÄHTUNG

RACCORDEMENTS CLIENT
CONNECTED BY CUSTOMER
ANSCHLUSS-KUNDE

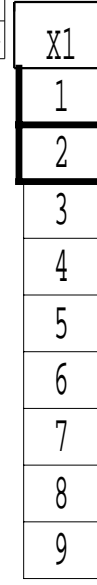

CONTACT DE SIGNALISATION DEFAULT
DEFECT INDICATOR CONTACT
STÖRMELDEKONTAKT
COMMANDE D'AUTOMATICITE
AUTOMATIC CONTROL
EXTERNE FREIGABE

PROTECTION IPSOTHERMIQUE MOTEURS VENTILATEURS
IPSOTHERMIC PROTECTOR OF FANS MOTORS
THERMOSCHUTZ LÜFTERMOTOREN

SORTIE REGULATEUR RPC (Cde YSM)
OUT RPC REGULATOR (CONTROL YSM)
REGLERAUSTRITT RPC (YSM Steuerung)

SERVO MOTEUR DE REGISTRE
DAMPER SERVO MOTOR
KLAPPENSTELLMOTOR

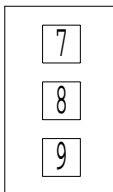

BOITE DE DERIVATION
CONNECTION BOX
ANSCHLUSSKASTEN

MRS1_4	
B1	Sonde entree eau glatee Inlet chilled water sensor Fühler Kaltwassereintritt
B2	Sonde sortie evaporateur N 1 Evaporator N 1 outlet sensor Austrittsfühler Verdampfer N 1
B3	Sonde sortie evaporateur N 2 Evaporator N 2 outlet sensor Austrittsfühler Verdampfer N 2
B4	Sonde sortie eau glatee (collecteur) Collector chilled water outlet sensor Fühler Kaltwasseraustritt (Sammler)
B5	Sonde eau chaude Hot water sensor Warmwasserfühler
B6	Sonde air exterieur External air sensor Aussenluftfühler
B7	Sonde refoulement circuit 1 Circuit N 1 discharge sensor Heissgasfühler Kreislauf 1
B8	Sonde refoulement circuit 2 Circuit N 2 discharge sensor Heissgasfühler Kreislauf 2

P	BBP-BHP-BH	
	DANFOSS	HUBA
0 V (-)	2	3
5 V (+)	1	1
S ↗	3	2

	HP - BP			FS
	PENN P77	RANCO 016	MINI	
BP	3 2	4 2	4 2	IT CONTROL 1 3/D 2
AUTO	1	1	1	
HP	3 2	2 4	2 4	PENN 1 2/D 3
MANU	1	1	1	
HP	2 3	4 2	2 4	
AUTO	1	1	1	

MRS1-4

DEFAUT GENERAL

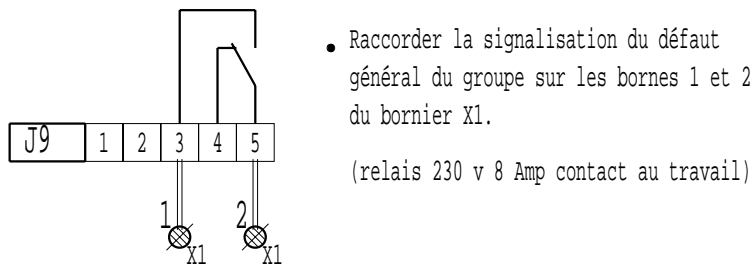

COMMANDE D'AUTOMATICITE

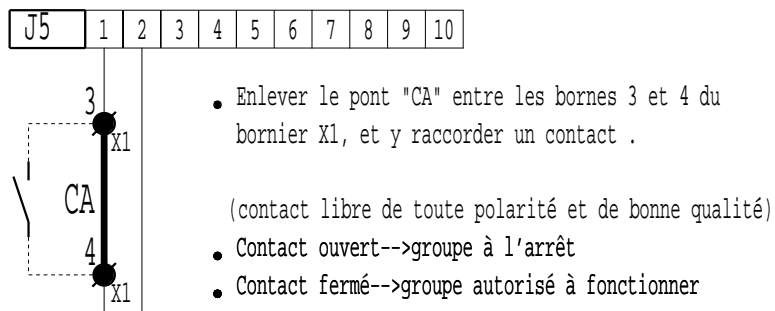

FONCTIONNEMENT EN PUISSANCE MAXI

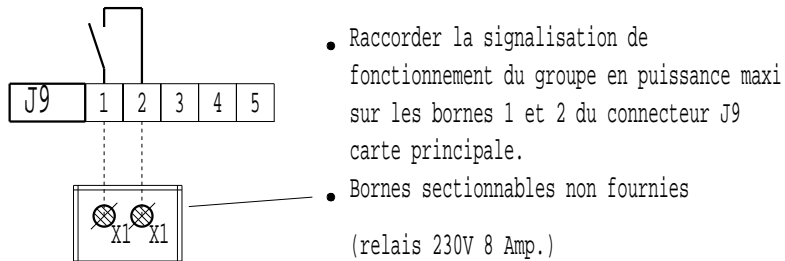

SELECTION CHAUD/FROID

- Configuration P17 valeur 3

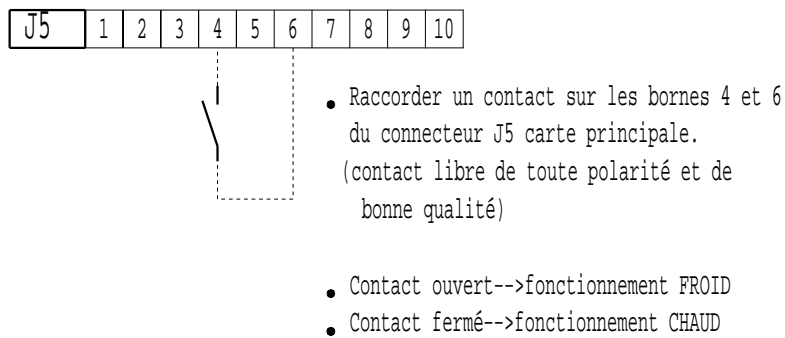

GENERAL FAULT

- The fault or not-fault information on the unit can be recover on terminals 1 and 2 connector X1.
(relay 230V 8 Amp.)

AUTOMATIC CONTROL

- The shunt "CA" on terminals 3 and 4 of connector X1, must be lifted and the contact connected.
(contact must be polarity free and of good quality)
- Contact open-->unit off-line
- Contact closed-->unit on-line

MAXIMUM OUTPUT OPERATION

- The controle device must be connected to terminals 1 and 2 on connector J9 of main card.
(relay 230V 8 Amp.)
- Isolating terminals not supplied

HEATING/COOLING SELECTION

- Configuration P17 value 3

- The controle device must be connected to terminals 4 and 6 on connector J5 of main card.
(contact must be polarity free and of good quality)
- Contact open-->COOLING operation
- Contact closed-->HEATING operation

SAMMELSTÖRMELDUNG

- Die Störungsmeldung wird an den Klemmen 1 und 2 der Anschlüsse X1 abgenommen.
(Relais 230V 8 Amp)

EXTERNE FREIGABE

- Die Brücke "CA" an den Klemmen 3 und 4 am Anschluss X1 entfernen und externen Kontakt anschliessen.
(Kontakt unbedingt potentialfrei anschliessen)
- Kontakt offen-->Gerät abgeschaltet
- Kontakt geschlossen-->Gerät Betriebsbereit

MAXIMALE LEISTUNG

- Der Kontakt wird an den Klemmen 1 und 2 am Stecker J9 der Hauptplatine angeschlossen.
(Relais 230V 8 Amp)
- Anschlussklemmen nicht mitgeliefert

AUSWAHL HEIZ-O.KÜHLBETRIEB

- Konfiguration P17 Wert 3

- Der Kontakt wird an den Klemmen 4 und 6 am Stecker J5 der Hauptplatine angeschlossen.
(Kontakt unbedingt potentialfrei anschliessen)
- Kontakt offen-->Kühlbetrieb
- Kontakt geschlossen-->Heizbetrieb

MRS1-4

SELECTION CONSIGNE 1 ou 2

- Configuration P18 valeur 3

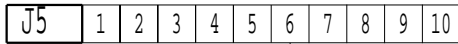

- Raccorder un contact entre les bornes 5 et 6 du connecteur J5 carte principale.
(contact libre de toute polarité et de bonne qualité)
- Contact ouvert-->CONSIGNE 1
- Contact fermé-->CONSIGNE 2

FONCTION DE DELESTAGE

- Configuration P16 valeurs 0 ou 1

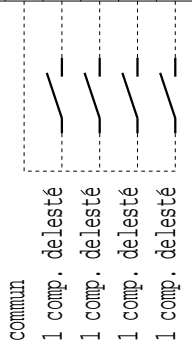
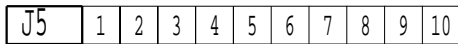

- Raccorder les contacts sur chaque entrée pour délester les différents compresseurs.
(contact libre de toute polarité et de bonne qualité)
- Contact ouvert-->fonctionnement normal
- Contact fermé-->fonctionnement avec délestage

COMMANDE DES ETAGES FORCES

- Configuration P16 valeurs 2 ou 3

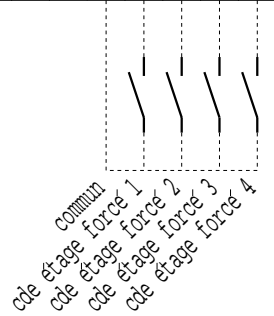
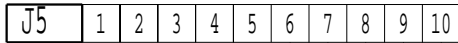

- Raccorder les contacts sur chaque entrée pour commander les différents étages
(contact libre de toute polarité et de bonne qualité)
- Suivant le nombre d'étages, il suffit de raccorder des contacts à fermeture.

PRECAUTIONS DE RACCORDEMENT

POUR LES PRECAUTIONS A PRENDRE POUR LE RACCORDEMENT DES ENTREES
VOIR LE MANUEL D'UTILISATION MRS1-4 PARAGRAPHE :
"ASSERVISSEMENT ET COMMANDES EXTERNES"

SETTING 1 OR 2 SELECTION

- Configuration P18 value 3

- The control must be connected to terminals 5 and 6 connector J5 on the main card.
(contact must be polarity free and of good quality)
- Contact open-->SETTING 1 operation
- Contact closed-->SETTING 2 operation

LOAD SHEDDING

- Configuration P16 values 0 or 1

- When a certain number of compressors must be shedded, connect an external control on connector J5 on the main card.
(contact must be polarity free and of good quality)
- Contact open-->normal running
- Contact closed-->shedding

FORCED STAGES CONTROL

- Configuration P16 values 2 or 3

- The control of the various stages is made by an external control connected to the connector J5 of the main card.
(contact must be polarity free and of good quality)
- According to the number of stages, connection of NO (normally open) contacts is sufficient.

CAUTION

TO TAKE PRECAUTION FOR CLIENT'S CONNECTION OF INPUTS
SEE THE OPERATING AND MAINTENANCE INSTRUCTIONS OF
MICROCIAT MRS1-4 PARAGRAPH :
"SERVO CONTROL AND EXTERNAL CONTROLS"

AUSWAHL SOLLWERT 1 ODER 2

- Konfiguration P18 Wert 3

- Der Kontakt wird an den Klemmen 5 und 6 am Stecker J5 der Hauptplatine angeschlossen.
(Kontakt unbedingt potentialfrei anschliessen)
- Kontakt offen-->Sollwert 1
- Kontakt geschlossen-->Sollwert 2

EXTERNE STUFENABSCHALTUNG

- Konfiguration P16 Werte 0 oder 1

- Die Kontakte werden an den Klemmen 6 bis 10 am Stecker J5 der Hauptplatine angeschlossen
(Kontakt unbedingt potentialfrei anschliessen)
- Kontakt offen-->Normalbetrieb
- Kontakt geschlossen-->Entlastungsbetrieb

EXTERNERBETRIEB DER STUFEN

- Konfiguration P16 Werte 2 oder 3

- Die Kontakte werden am den Klemmen 6 bis 10 am Stecker J5 der Hauptplatine angeschlossen
(Kontakt unbedingt potentialfrei anschliessen)
- Die Zuverdrahtende Kontaktanzahl ist von der Stufenanzahl abhängig.

ACHTUNG

Um Anschlussfehler zu vermeiden, unbedingt die Betriebs- und Wartungsanleitung MRS 1-4 Abschnitt Regelung und externe Regelung beachten.

01	02	03	04	05	06	07	08	09	10	11	12	13	14	15	16	17	18	19	20	21	22	23	24	25	26
----	----	----	----	----	----	----	----	----	----	----	----	----	----	----	----	----	----	----	----	----	----	----	----	----	----

J
I
H
G
F
E
D
C

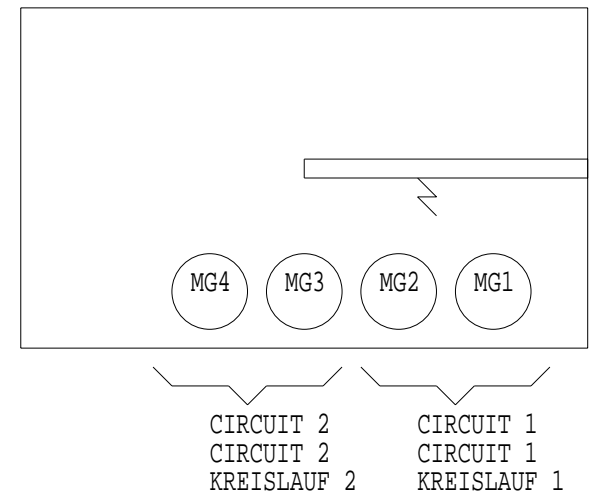

MODIFIE PAR: MODIFIED BY: GEANDERT DURCH:		INDICE INDEX KENNZIFFER	DATE DATE DATUM	FILS NUMEROTES EN OPTION NUMBERING OF WIRING IN OPTION OPTION KABEL NUMMERIERUNG		APPAREIL OU UNITE/UNIT/GERAT ODER EINHEIT LJA 500-600				
MODIFICATION A CREATION		LEGENDE/LEGEND/LEGENDE 3950010.36		SPECIFICATION/SPECIFICATION/SPEZIFIZIERUNG 4 COMPRESSEURS 2 CIRCUITS 4 COMPRESSORS 2 CIRCUITS 4 VERDICHTERN 2 KREISLAUFE DEMARRAGE ETOILE-TRANGLE GMV						
REPLACE/TAKE/ERSETZT		REPLACE PAR/TAKE BY/ERSERTZT DURCH		CLIENT/CLIENT/KUNDE		REFERENCE/REFERENCE/REFERENZ	CREATEUR: CREATOR: HERSTELLER: JMB	DATE: DATE: DATUM: 15-09-99		
REFERENCES COMMANDE/ORDER REFERENCES/AUFTRAGSREFERENZ				DEMARRAGE/START/ANLAUF	TENSION/VOLTAGE/SPANNUNG	COMPAGNIE INDUSTRIELLE D'APPLICATIONS THERMIQUES		FOLIO/FOLIO/SEITE 1 / 6	NUMERO DE SCHEMA/DRAWING NUMBER/PLAN NR 3980962	INDICE/INDEX/KENNZIFFER 00

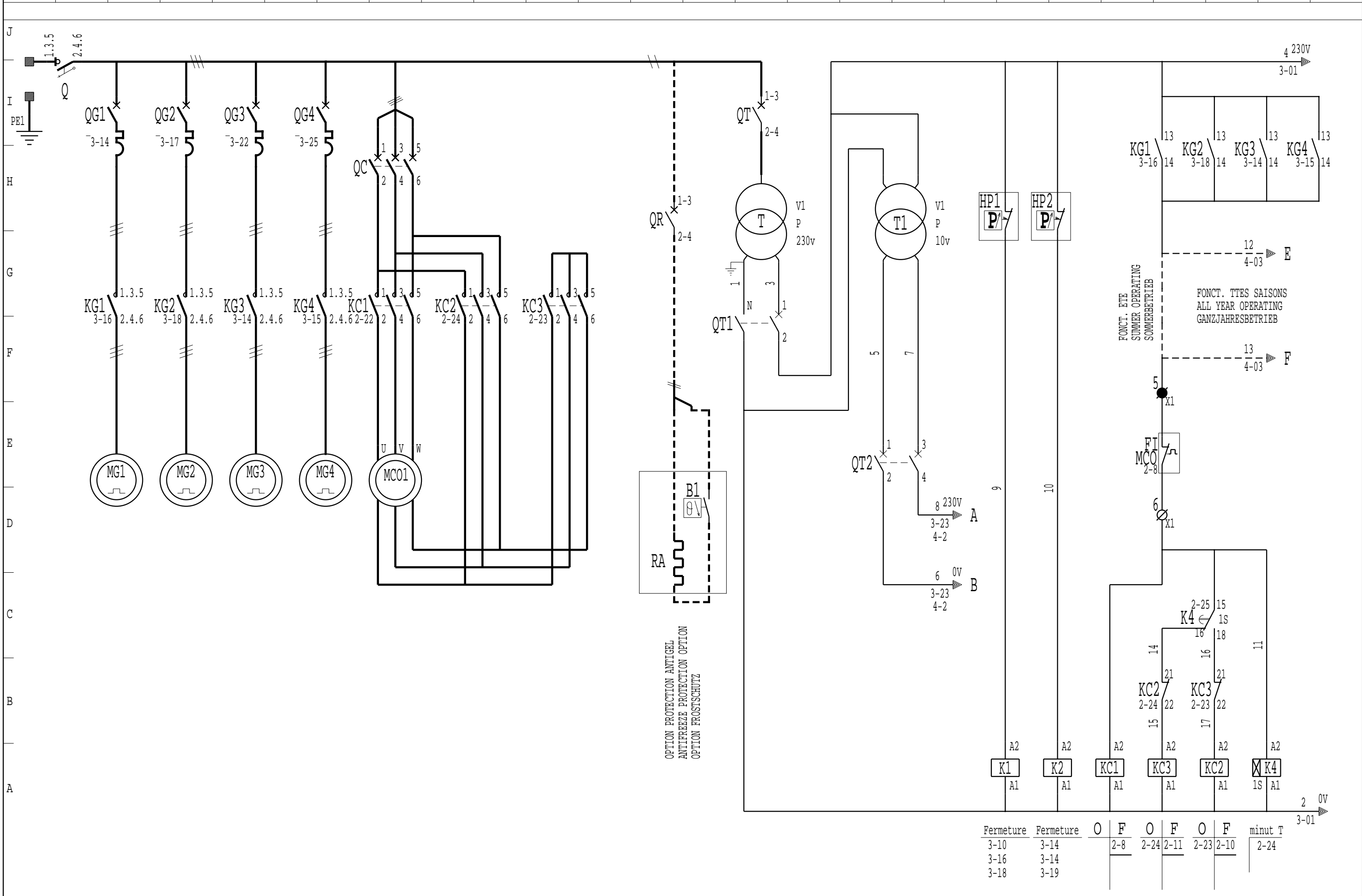

OPTION PROTECTION ANTIGEL
 ANTI-FREZE PROTECTION OPTION
 OPTION FROSTSCHUTZ

Fermeture	Fermeture	O	F	O	F	O	F	minut T
3-10	3-14		2-8	2-24	2-11	2-23	2-10	2-24
3-16	3-14							
3-18	3-19							

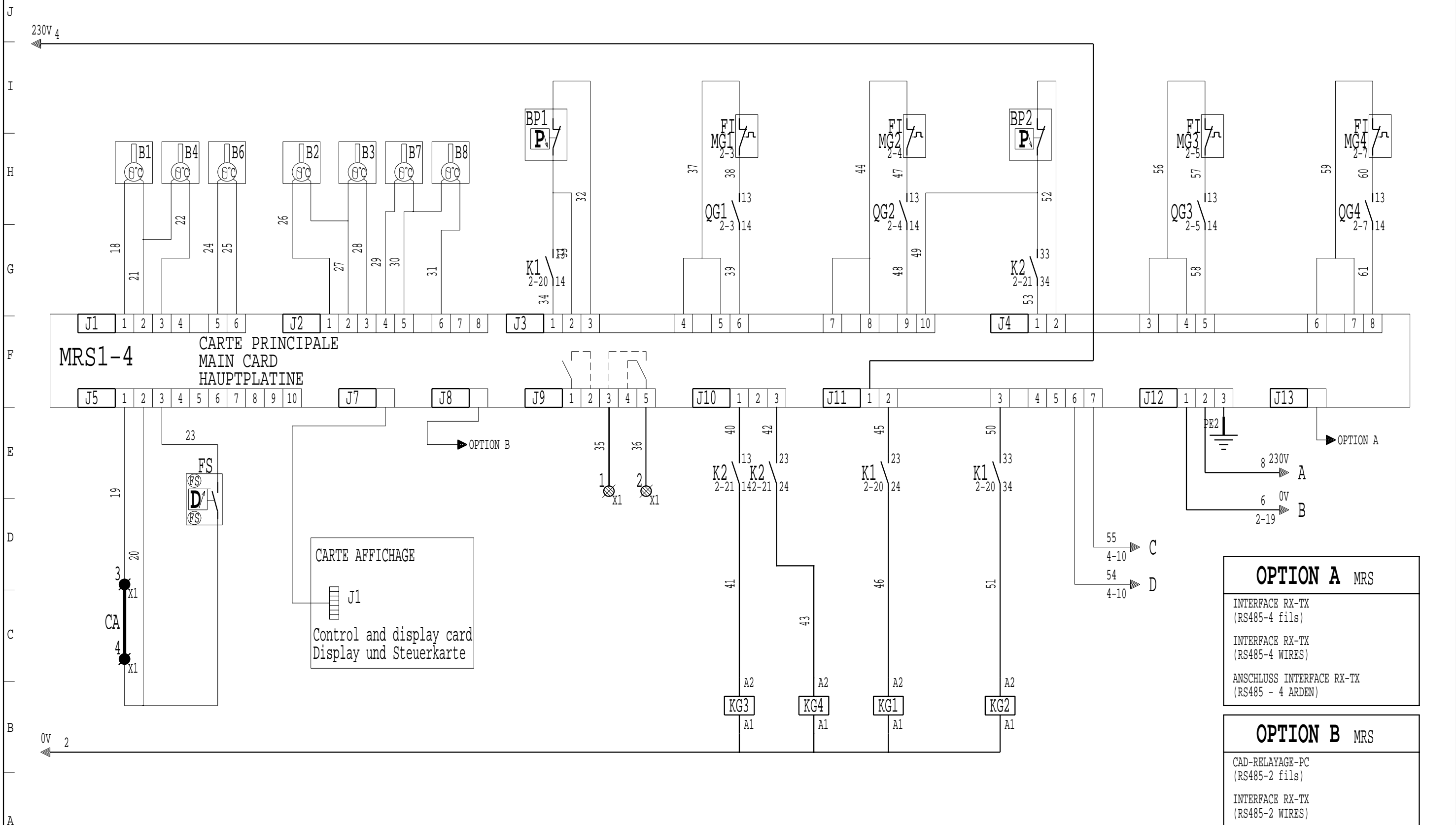

OPTION A MRS

INTERFACE RX-TX
(RS485-4 fils)

INTERFACE RX-TX
(RS485-4 WIRES)

ANSCHLUSS INTERFACE RX-TX
(RS485 - 4 ARDEN)

OPTION B MRS

CAD-RELAYAGE-PC
(RS485-2 fils)

INTERFACE RX-TX
(RS485-2 WIRES)

ANSCHLUSS CAD-RELAIS-PC
(RS485 - 2 ARDEN)

O	F	O	F	O	F	O	F
	2-5		2-7		2-3		2-4
	2-25		2-26		2-23		2-24

J
I
H
G
F
E
D
C
B
A

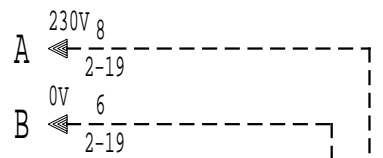

OPTION FONCTIONNEMENT TOUTES SAISONS
ALL YEAR OPERATING OPTION
OPTION GANZJAHRESBETRIEB

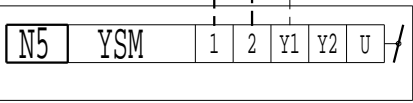
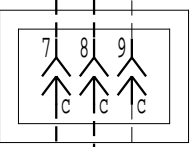
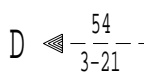
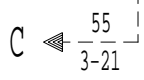
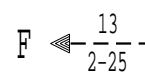
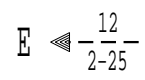
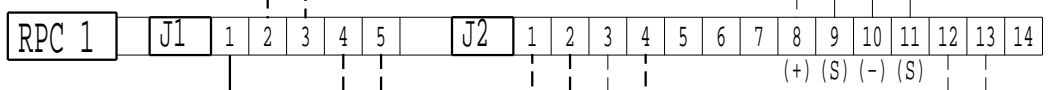
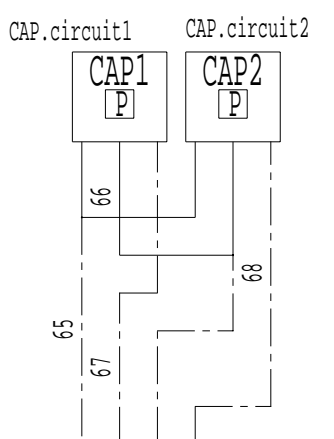

RACCORDEMENTS USINE
FACTORY CONNECTION
WERKSEITIGE VERDRÄHTUNG

RACCORDEMENTS CLIENT
CONNECTED BY CUSTOMER
ANSCHLUSS-KUNDE

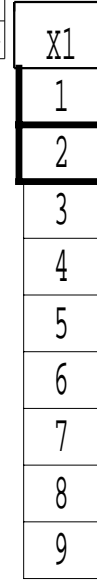

- 3-11 1 CONTACT DE SIGNALISATION DEFAULT
- 3-12 2 DEFECT INDICATOR CONTACT
- 3-03 3 STÖRMELDEKONTAKT
- 3-03 4 COMMANDE D'AUTOMATICITE
- 3-03 4 AUTOMATIC CONTROL
- 2-23 5 EXTERNE FREIGABE
- 2-23 6
- 4-07 7
- 4-07 8
- 4-07 9

PROTECTION IPSOTHERMIQUE MOTEURS VENTILATEURS
IPSOTHERMIC PROTECTOR OF FANS MOTORS
THERMOSCHUTZ LÜFTERMOTOREN

SORTIE REGULATEUR RPC (Cde YSM)
OUT RPC REGULATOR (CONTROL YSM)
REGLERAUSTRITT RPC (YSM Steuerung)

SERVO MOTEUR DE REGISTRE
DAMPER SERVO MOTOR
KLAPPENSTELLMOTOR

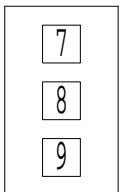

BOITE DE DERIVATION
CONNECTION BOX
ANSCHLUSSKASTEN

MRS1_4	
B1	Sonde entree eau glatee Inlet chilled water sensor Fühler Kaltwassereintritt
B2	Sonde sortie evaporateur N 1 Evaporator N 1 outlet sensor Austrittsfühler Verdampfer N 1
B3	Sonde sortie evaporateur N 2 Evaporator N 2 outlet sensor Austrittsfühler Verdampfer N 2
B4	Sonde sortie eau glatee (collecteur) Collector chilled water outlet sensor Fühler Kaltwasseraustritt (Sammler)
B5	Sonde eau chaude Hot water sensor Warmwasserfühler
B6	Sonde air exterieur External air sensor Aussenluftfühler
B7	Sonde refoulement circuit 1 Circuit N 1 discharge sensor Heissgasfühler Kreislauf 1
B8	Sonde refoulement circuit 2 Circuit N 2 discharge sensor Heissgasfühler Kreislauf 2

P	BBP-BHP-BH	
	DANFOSS	HUBA
0 V (-)	2	3
5 V (+)	1	1
S ↗	3	2

	HP - BP			FS
	PENN P77	RANCO 016	MINI	
BP	3 2	4 2	4 2	IT CONTROL 1 3/D 2
AUTO	1	1	1	
HP	3 2	2 4	2 4	PENN 1 2/D 3
MANU	1	1	1	
HP	2 3	4 2	2 4	
AUTO	1	1	1	

MRS1-4

DEFAUT GENERAL

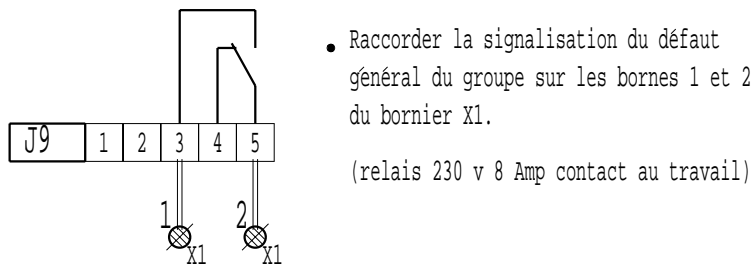

COMMANDE D'AUTOMATICITE

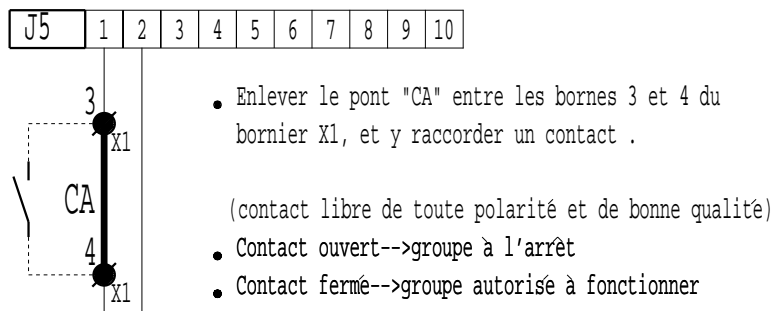

FONCTIONNEMENT EN PUISSANCE MAXI

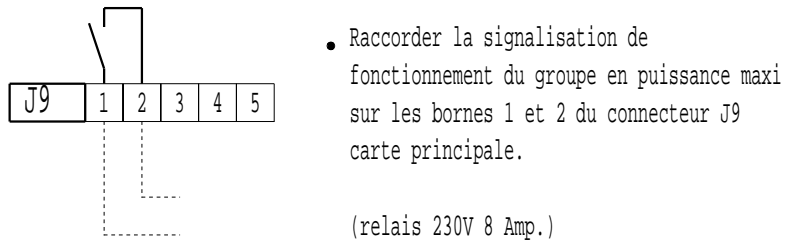

SELECTION CHAUD/FROID

- Configuration P17 valeur 3

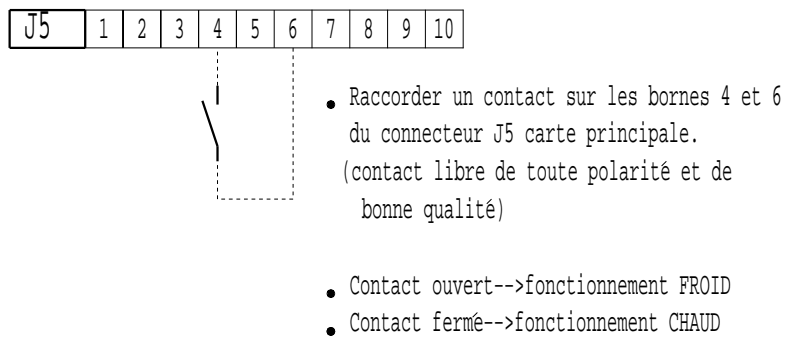

GENERAL FAULT

- The fault or not-fault information on the unit can be recover on terminals 1 and 2 connector X1.
(relay 230V 8 Amp.)

AUTOMATIC CONTROL

- The shunt "CA" on terminals 3 and 4 of connector X1, must be lifted and the contact connected.
(contact must be polarity free and of good quality)
- Contact open-->unit off-line
- Contact closed-->unit on-line

MAXIMUM OUTPUT OPERATION

- The controle device must be connected to terminals 1 and 2 on connector J9 of main card.
(relay 230V 8 Amp.)

HEATING/COOLING SELECTION

- Configuration P17 value 3

- The controle device must be connected to terminals 4 and 6 on connector J5 of main card.
(contact must be polarity free and of good quality)
- Contact open-->COOLING operation
- Contact closed-->HEATING operation

SAMMELSTORMELDUNG

- Die Störungsmeldung wird an den Klemmen 1 und 2 der Anschlüsse X1 abgenommen.
(Relais 230V 8 Amp)

EXTERNE FREIGABE

- Die Brücke "CA" an den Klemmen 3 und 4 am Anschluss X1 entfernen und externen Kontakt anschliessen.
(Kontakt unbedingt potentialfrei anschliessen)
- Kontakt offen-->Gerät abgeschaltet
- Kontakt geschlossen-->Gerät Betriebsbereit

MAXIMALE LEISTUNG

- Der Kontakt wird an den Klemmen 1 und 2 am Stecker J9 der Hauptplatine angeschlossen.
(Relais 230V 8 Amp)

AUSWAHL HEIZ-O.KÜHLBETRIEB

- Konfiguration P17 Wert 3

- Der Kontakt wird an den Klemmen 4 und 6 am Stecker J5 der Hauptplatine angeschlossen.
(Kontakt unbedingt potentialfrei anschliessen)
- Kontakt offen-->Kühlbetrieb
- Kontakt geschlossen-->Heizbetrieb

MRS1-4

SELECTION CONSIGNE 1 ou 2

- Configuration P18 valeur 3

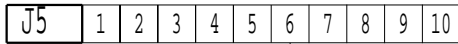

- Raccorder un contact entre les bornes 5 et 6 du connecteur J5 carte principale.
(contact libre de toute polarité et de bonne qualité)
- Contact ouvert-->CONSIGNE 1
- Contact fermé-->CONSIGNE 2

FONCTION DE DELESTAGE

- Configuration P16 valeurs 0 ou 1

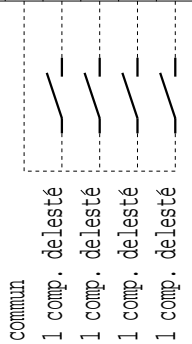
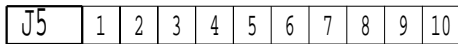

- Raccorder les contacts sur chaque entrée pour délester les différents compresseurs.
(contact libre de toute polarité et de bonne qualité)
- Contact ouvert-->fonctionnement normal
- Contact fermé-->fonctionnement avec délestage

COMMANDE DES ETAGES FORCES

- Configuration P16 valeurs 2 ou 3

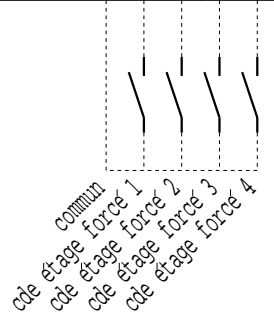
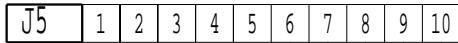

- Raccorder les contacts sur chaque entrée pour commander les différents étages
(contact libre de toute polarité et de bonne qualité)
- Suivant le nombre d'étages, il suffit de raccorder des contacts à fermeture.

PRECAUTIONS DE RACCORDEMENT

POUR LES PRECAUTIONS A PRENDRE POUR LE RACCORDEMENT DES ENTREES
VOIR LE MANUEL D'UTILISATION MRS1-4 PARAGRAPHE :
"ASSERVISSEMENT ET COMMANDES EXTERNES"

SETTING 1 OR 2 SELECTION

- Configuration P18 value 3

- The control must be connected to terminals 5 and 6 connector J5 on the main card.
(contact must be polarity free and of good quality)

- Contact open-->SETTING 1 operation
- Contact closed-->SETTING 2 operation

LOAD SHEDDING

- Configuration P16 values 0 or 1

- When a certain number of compressors must be shedded, connect an external control on connector J5 on the main card.
(contact must be polarity free and of good quality)

- Contact open-->normal running
- Contact closed-->shedding

FORCED STAGES CONTROL

- Configuration P16 values 2 or 3

- The control of the various stages is made by an external control connected to the connector J5 of the main card.
(contact must be polarity free and of good quality)

- According to the number of stages, connection of NO (normally open) contacts is sufficient.

CAUTION

TO TAKE PRECAUTION FOR CLIENT'S CONNECTION OF INPUTS
SEE THE OPERATING AND MAINTENANCE INSTRUCTIONS OF
MICROCIAT MRS1-4 PARAGRAPH :
"SERVO CONTROL AND EXTERNAL CONTROLS"

AUSWAHL SOLLWERT 1 ODER 2

- Konfiguration P18 Wert 3

- Der Kontakt wird an den Klemmen 5 und 6 am Stecker J5 der Hauptplatine angeschlossen.
(Kontakt unbedingt potentialfrei anschliessen)

- Kontakt offen-->Sollwert 1
- Kontakt geschlossen-->Sollwert 2

EXTERNE STUFENABSCHALTUNG

- Konfiguration P16 Werte 0 oder 1

- Die Kontakte werden an den Klemmen 6 bis 10 am Stecker J5 der Hauptplatine angeschlossen
(Kontakt unbedingt potentialfrei anschliessen)

- Kontakt offen-->Normalbetrieb
- Kontakt geschlossen-->Entlastungsbetrieb

EXTERNERBETRIEB DER STUFEN

- Konfiguration P16 Werte 2 oder 3

- Die Kontakte werden am den Klemmen 6 bis 10 am Stecker J5 der Hauptplatine angeschlossen
(Kontakt unbedingt potentialfrei anschliessen)

- Die Zuverdrahtende Kontaktanzahl ist von der Stufenanzahl abhängig.

ACHTUNG

Um Anschlussfehler zu vermeiden, unbedingt die Betriebs- und Wartungsanleitung MRS 1-4 Abschnitt Regelung und externe Regelung beachten.

01	02	03	04	05	06	07	08	09	10	11	12	13	14	15	16	17	18	19	20	21	22	23	24	25	26		
J																											
I																											
H																											
G																											
F																											
E																											
D																											
C																											
MODIFIE PAR: MODIFIED BY: GEANDERT DURCH: SAG		INDICE INDEX KENNZIFFER 34		DATE DATE DATUM 22-12-99		FILS NUMEROTES EN OPTION NUMBERING OF WIRING IN OPTION OPTION KABEL NUMMERIERUNG						APPAREIL OU UNITE/UNIT/GERAT ODER EINHEIT LJA 500 - 600															
MODIFICATION A CDE RESISTANCE ANTIGEL						LEGENDE/LEGEND/LEGENDE 3950010.36						SPECIFICATION/SPECIFICATION/SPEZIFIZIERUNG 4 COMPRESSEURS 2 CIRCUITS MRS1-4 4 COMPRESSORS 2 CIRCUITS 4 VERDICHTERN 2 KREISLAUFE															
REPLACE/TAKE/ERSETZT				REPLACE PAR/TAKE BY/ERSETZT DURCH				CLIENT/CLIENT/KUNDE				REFERENCE/REFERENCE/REFERENZ				CREATEUR: CREATOR: HERSTELLER: MA		DATE: DATE: DATUM: 13-02-97									
REFERENCES COMMANDE/ORDER REFERENCES/AUFTRAGSREFERENZ								DEMARRAGE/START/ANLAUF				TENSION/VOLTAGE/SPANNUNG				COMPAGNIE INDUSTRIELLE D'APPLICATIONS THERMIQUES				FOLIO/FOLIO/SEITE 1 / 6		NUMERO DE SCHEMA/DRAWING NUMBER/PLAN NR 3980398				INDICE/INDEX/KENNZIFFER 34	

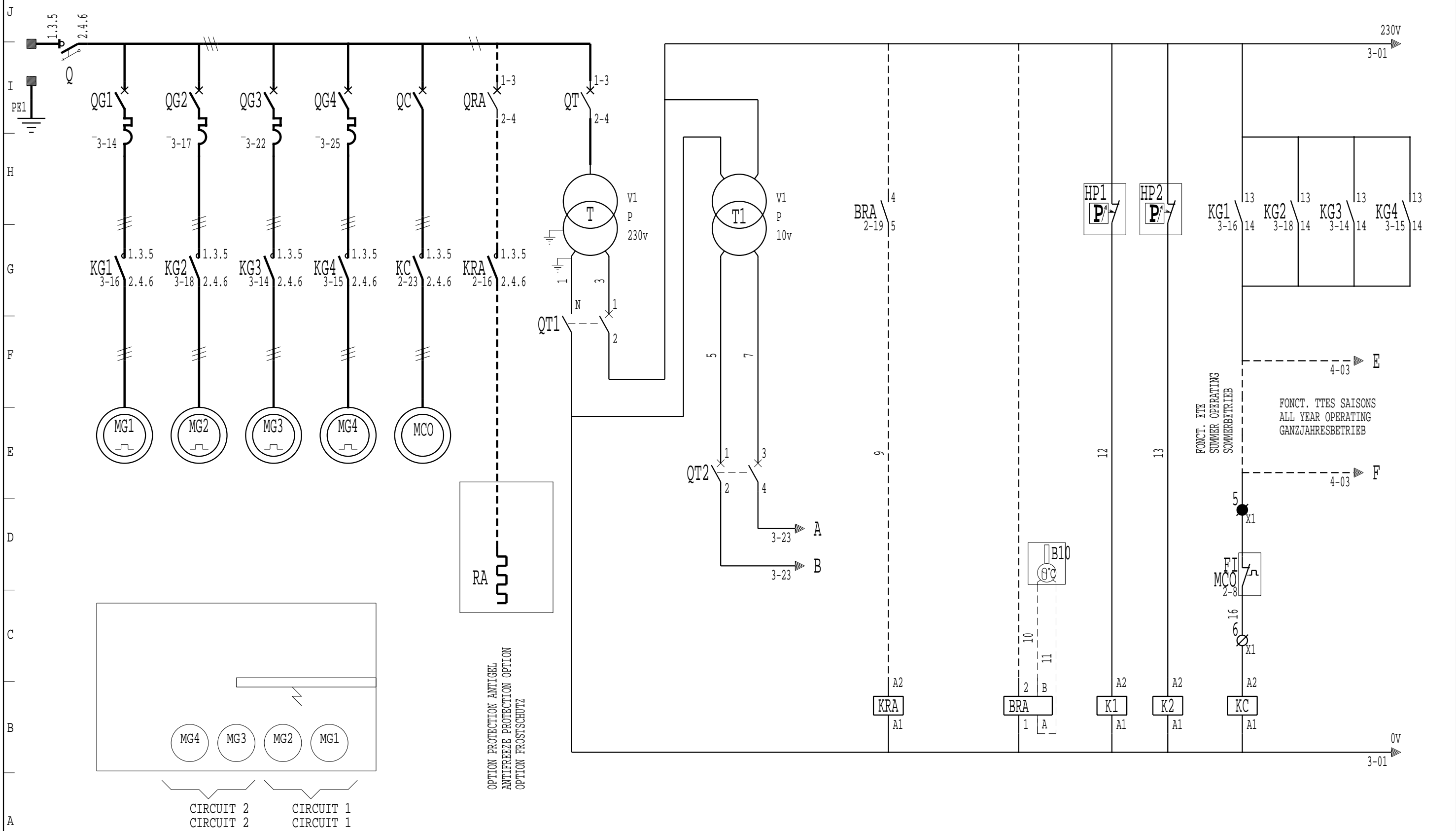

O	F	O	I	F	Fermeture	Fermeture	O	F
	2-9			2-16	3-10	3-14		2-8
					3-16	3-14		
					3-18	3-19		

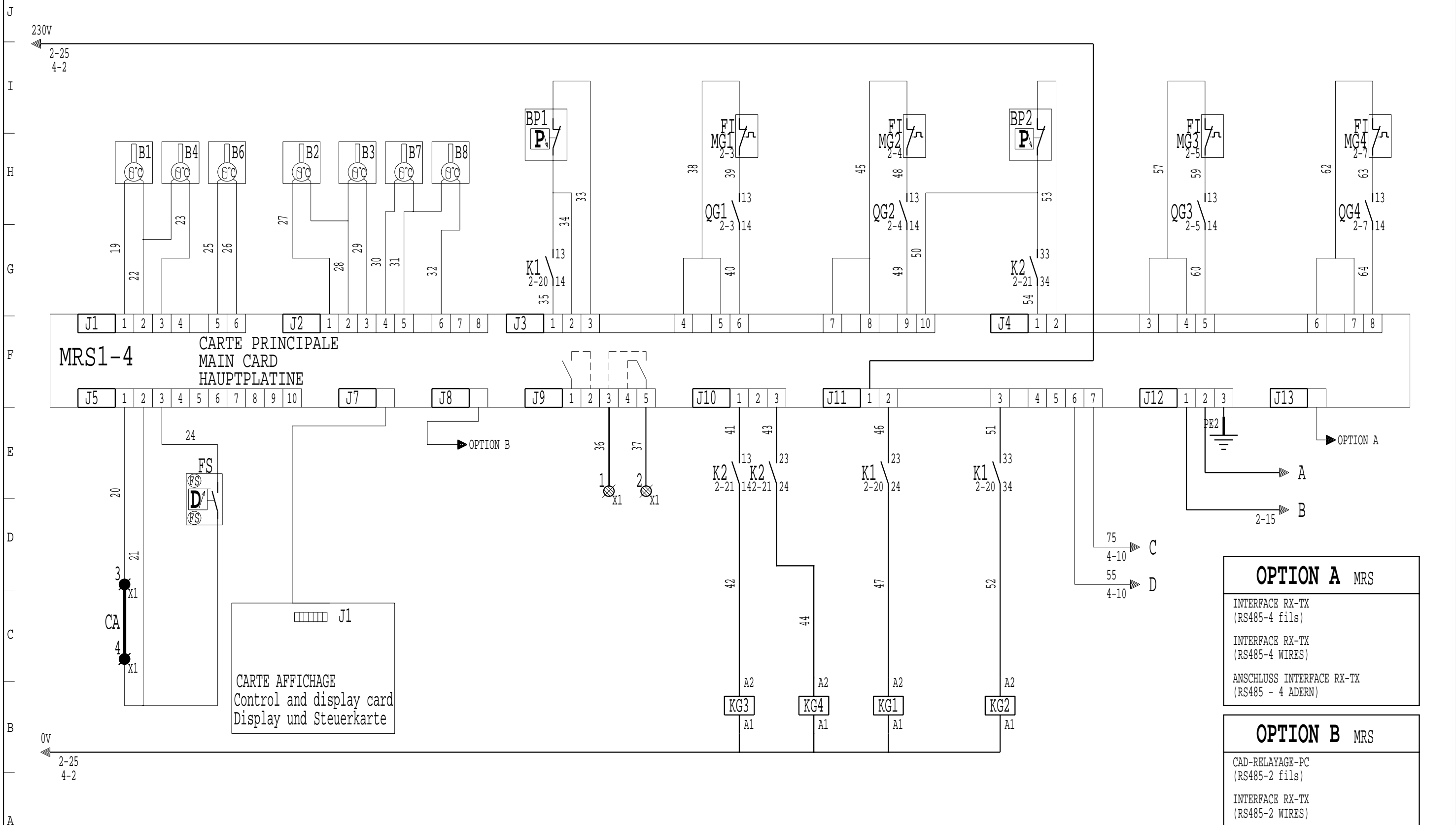

OPTION A MRS

INTERFACE RX-TX
(RS485-4 fils)

INTERFACE RX-TX
(RS485-4 WIRES)

ANSCHLUSS INTERFACE RX-TX
(RS485 - 4 ADERN)

OPTION B MRS

CAD-RELAYAGE-PC
(RS485-2 fils)

INTERFACE RX-TX
(RS485-2 WIRES)

ANSCHLUSS CAD-RELAIS-PC
(RS485 - 2 ADERN)

O	F	O	F	O	F	O	F
2-5	2-7	2-3	2-4	2-25	2-26	2-23	2-24
2-25	2-26	2-23	2-24				

J
I
H
G
F
E
D
C
B
A

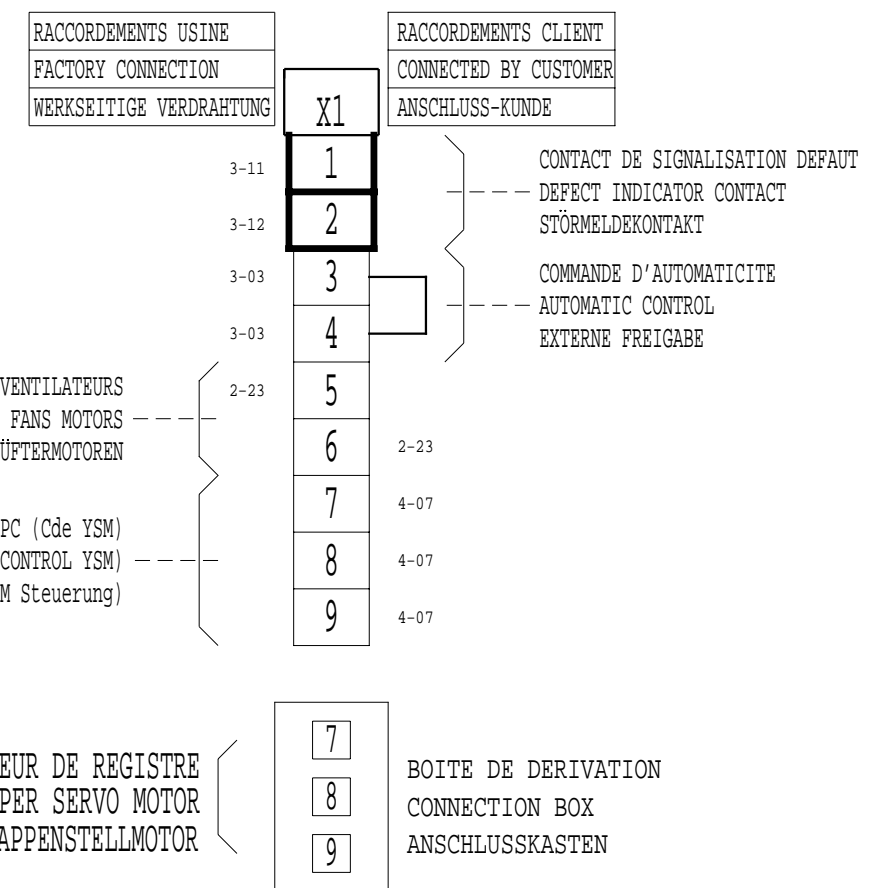
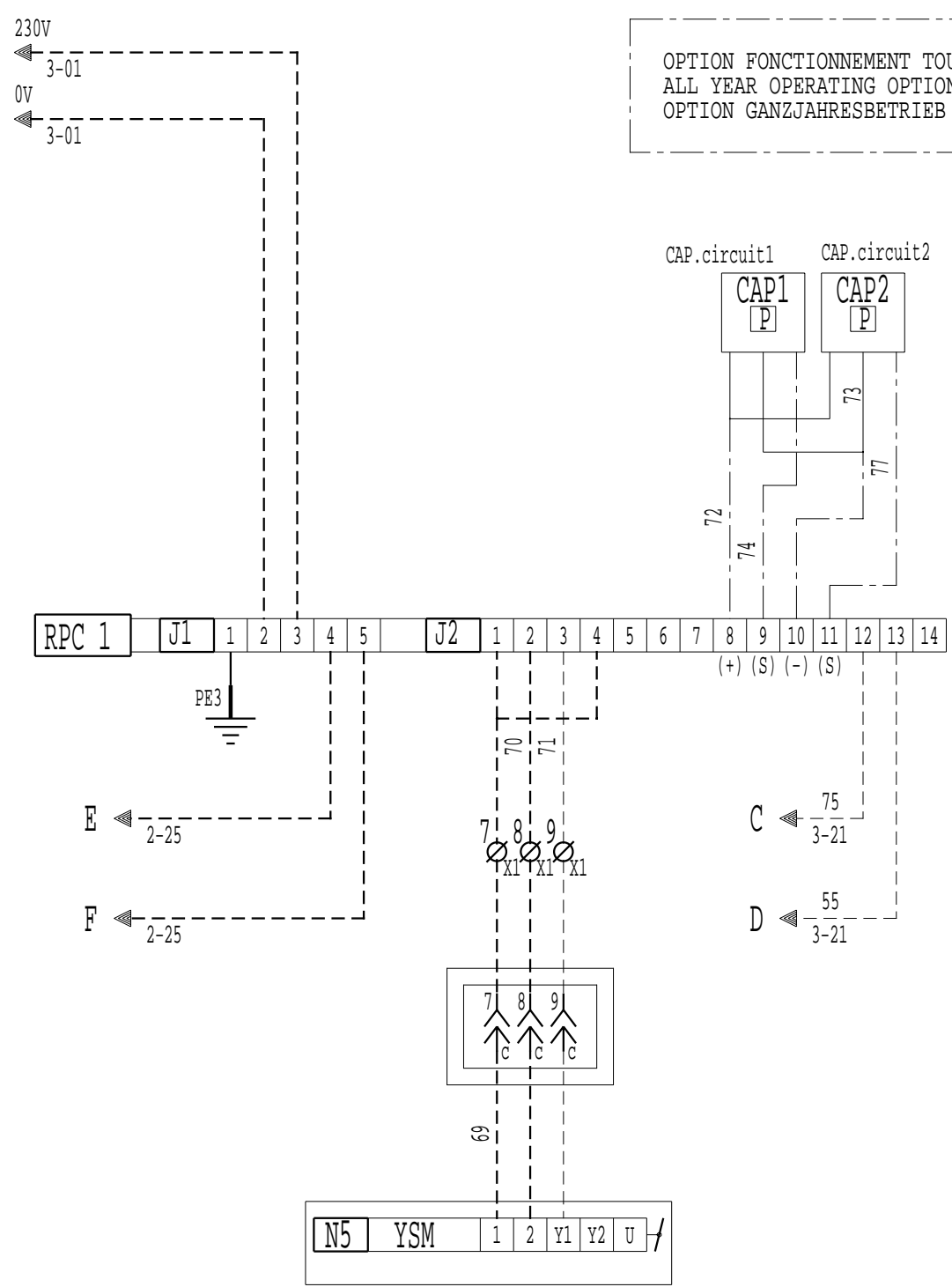

MRS1_4	
B1	Sonde entree eau glatee Inlet chilled water sensor Fühler Kaltwassereintritt
B2	Sonde sortie evaporateur N 1 Evaporator N 1 outlet sensor Austrittsfühler Verdampfer N 1
B3	Sonde sortie evaporateur N 2 Evaporator N 2 outlet sensor Austrittsfühler Verdampfer N 2
B4	Sonde sortie eau glatee (collecteur) Collector chilled water outlet sensor Fühler Kaltwasseraustritt (Sammler)
B5	Sonde eau chaude Hot water sensor Warmwasserfühler
B6	Sonde air exterieur External air sensor Aussenluftfühler
B7	Sonde refoulement circuit 1 Circuit N 1 discharge sensor Heissgasfühler Kreislauf 1
B8	Sonde refoulement circuit 2 Circuit N 2 discharge sensor Heissgasfühler Kreislauf 2

P	BBP-BHP-BH	
	DANFOSS	HUBA
0 V (-)	2	3
5 V (+)	1	1
S ↗	3	2

	HP - BP			FS
	PENN P77	RANCO 016	MINI	
BP	3 2	4 2	4 2	IT CONTROL 1 3/D 2
AUTO	1	1	1	
HP	3 2	2 4	2 4	PENN 1 2/D 3
MANU	1	1	1	
HP	2 3	4 2	2 4	
AUTO	1	1	1	

MRS1-4

DEFAUT GENERAL

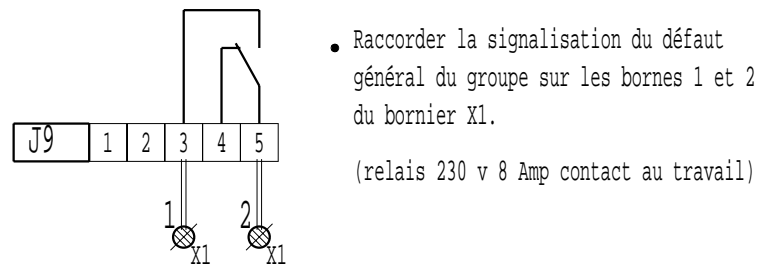

COMMANDE D'AUTOMATICITE

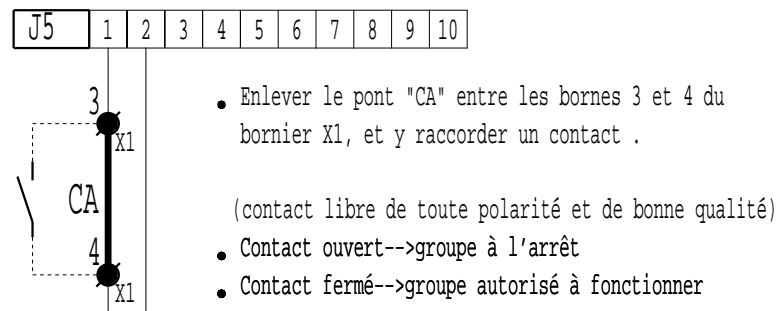

FONCTIONNEMENT EN PUISSANCE MAXI

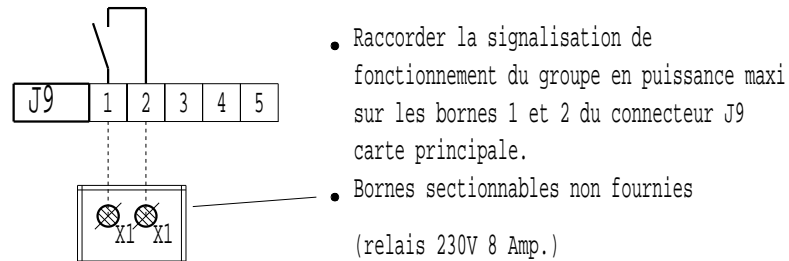

SELECTION CHAUD/FROID

- Configuration P17 valeur 3

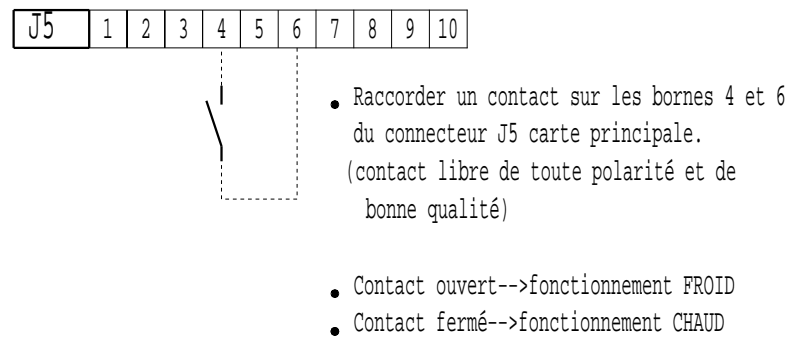

GENERAL FAULT

- The fault or not-fault information on the unit can be recover on terminals 1 and 2 connector X1.
(relay 230V 8 Amp.)

AUTOMATIC CONTROL

- The shunt "CA" on terminals 3 and 4 of connector X1, must be lifted and the contact connected.
(contact must be polarity free and of good quality)
- Contact open-->unit off-line
- Contact closed-->unit on-line

MAXIMUM OUTPUT OPERATION

- The controle device must be connected to terminals 1 and 2 on connector J9 of main card.
Isolating terminals not supplied
(relay 230V 8 Amp.)

HEATING/COOLING SELECTION

- Configuration P17 value 3

- The controle device must be connected to terminals 4 and 6 on connector J5 of main card.
(contact must be polarity free and of good quality)
- Contact open-->COOLING operation
- Contact closed-->HEATING operation

SAMMELSTÖRMELDUNG

- Die Störungsmeldung wird an den Klemmen 1 und 2 der Anschlüsse X1 abgenommen.
(Relais 230V 8 Amp)

EXTERNE FREIGABE

- Die Brücke "CA" an den Klemmen 3 und 4 am Anschluss X1 entfernen und externen Kontakt anschliessen.
(Kontakt unbedingt potentialfrei anschliessen)
- Kontakt offen-->Gerät abgeschaltet
- Kontakt geschlossen-->Gerät Betriebsbereit

MAXIMALE LEISTUNG

- Der Kontakt wird an den Klemmen 1 und 2 am Stecker J9 der Hauptplatine angeschlossen.
Anschlussklemmen nicht mitgeliefert
(Relais 230V 8 Amp)

AUSWAHL HEIZ-O.KÜHLBETRIEB

- Konfiguration P17 Wert 3

- Der Kontakt wird an den Klemmen 4 und 6 am Stecker J5 der Hauptplatine angeschlossen.
(Kontakt unbedingt potentialfrei anschliessen)
- Kontakt offen-->Kühlbetrieb
- Kontakt geschlossen-->Heizbetrieb

MRS1-4

SELECTION CONSIGNE 1 ou 2

- Configuration P18 valeur 3

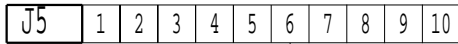

- Raccorder un contact entre les bornes 5 et 6 du connecteur J5 carte principale.
(contact libre de toute polarité et de bonne qualité)
- Contact ouvert-->CONSIGNE 1
- Contact fermé-->CONSIGNE 2

FONCTION DE DELESTAGE

- Configuration P16 valeurs 0 ou 1

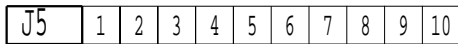

- Raccorder les contacts sur chaque entrée pour délester les différents compresseurs.
(contact libre de toute polarité et de bonne qualité)
- Contact ouvert-->fonctionnement normal
- Contact fermé-->fonctionnement avec délestage

COMMANDE DES ETAGES FORCES

- Configuration P16 valeurs 2 ou 3

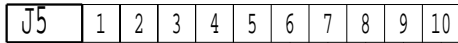

- Raccorder les contacts sur chaque entrée pour commander les différents étages
(contact libre de toute polarité et de bonne qualité)
- Suivant le nombre d'étages, il suffit de raccorder des contacts à fermeture.

PRECAUTIONS DE RACCORDEMENT

POUR LES PRECAUTIONS A PRENDRE POUR LE RACCORDEMENT DES ENTREES
VOIR LE MANUEL D'UTILISATION MRS1-4 PARAGRAPHE :
"ASSERVISSEMENT ET COMMANDES EXTERNES"

SETTING 1 OR 2 SELECTION

- Configuration P18 value 3

- The control must be connected to terminals 5 and 6 connector J5 on the main card.
(contact must be polarity free and of good quality)
- Contact open-->SETTING 1 operation
- Contact closed-->SETTING 2 operation

LOAD SHEDDING

- Configuration P16 values 0 or 1

- When a certain number of compressors must be shedded, connect an external control on connector J5 on the main card.
(contact must be polarity free and of good quality)
- Contact open-->normal running
- Contact closed-->shedding

FORCED STAGES CONTROL

- Configuration P16 values 2 or 3

- The control of the various stages is made by an external control connected to the connector J5 of the main card.
(contact must be polarity free and of good quality)
- According to the number of stages, connection of NO (normally open) contacts is sufficient.

CAUTION

TO TAKE PRECAUTION FOR CLIENT'S CONNECTION OF INPUTS
SEE THE OPERATING AND MAINTENANCE INSTRUCTIONS OF
MICROCIAT MRS1-4 PARAGRAPH :
"SERVO CONTROL AND EXTERNAL CONTROLS"

AUSWAHL SOLLWERT 1 ODER 2

- Konfiguration P18 Wert 3

- Der Kontakt wird an den Klemmen 5 und 6 am Stecker J5 der Hauptplatine angeschlossen.
(Kontakt unbedingt potentialfrei anschliessen)
- Kontakt offen-->Sollwert 1
- Kontakt geschlossen-->Sollwert 2

EXTERNE STUFENABSCHALTUNG

- Konfiguration P16 Werte 0 oder 1

- Die Kontakte werden an den Klemmen 6 bis 10 am Stecker J5 der Hauptplatine angeschlossen
(Kontakt unbedingt potentialfrei anschliessen)
- Kontakt offen-->Normalbetrieb
- Kontakt geschlossen-->Entlastungsbetrieb

EXTERNERBETRIEB DER STUFEN

- Konfiguration P16 Werte 2 oder 3

- Die Kontakte werden am den Klemmen 6 bis 10 am Stecker J5 der Hauptplatine angeschlossen
(Kontakt unbedingt potentialfrei anschliessen)
- Die Zuverdratende Kontaktanzahl ist von der Stufenanzahl abhängig.

ACHTUNG

Um Anschlussfehler zu vermeiden, unbedingt die Betriebs- und Wartungsanleitung MRS 1-4 Abschnitt Regelung und externe Regelung beachten.