



# CWP-CO/CWP-RC/CWP-HP

## 02 ÷ 35



English

Français



8  
↓  
136 kW

**Water cooled water chillers : cooling only, condenserless and heat pump versions**



9  
↓  
164 kW

**Refroidisseurs de liquide à condensation par eau : versions froid seul, sans condenseur et pompe à chaleur**



**IOM CWP-N.1GBF**

Date : May / Mai 2006

Supersedes / Annule et remplace : IMW 910.2M/12.01



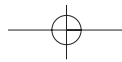

## Table of contents

### Table of contents

<b>1 FOREWORD</b>		<b>6 CONTROL SYSTEM</b>	
1.1 Introduction	2	6.1 CWP Control system µchiller	16
1.2 Warranty	2	6.2 High Pressure Control	18
1.3 Emergency stop/Normal stop	2	6.3 Low Pressure Control	18
1.4 An introduction to this manual	2	6.4 Heat Exchanger Heater Thermostat	18
<b>2 SAFETY</b>		6.5 Pressostatic Valve Kit (Optional)	18
2.1 Foreword	3	<b>7 GENERAL DESCRIPTION</b>	
2.2 Definitions	3	7.1 Introduction	19
2.3 Access to the unit	4	7.2 General Specifications	19
2.4 General precautions	4	7.3 Compressors	19
2.5 Precautions against residual risks	4	7.4 Refrigeration circuits	19
2.6 Precautions during maintenance operations	5	7.5 Evaporator	19
2.7 Safety labels	6	7.6 Condenser (except for CWP-RC)	19
2.8 Safety regulations	7	7.7 Switchboard	19
<b>3 TRANSPORT, LIFTING AND POSITIONING</b>		<b>8 TECHNICAL DATA</b>	
3.1 Inspection	10	8.1 Pressure drops	23
3.2 Unit Handling	10	8.2 Technical data	24
3.3 Anchoring	10	8.3 Electrical data	29
3.4 Storage	10	8.4 Overall dimensions	30
<b>4 INSTALLATION</b>		8.5 Service spaces	33
4.1 Positioning of the unit	11	<b>9 MAINTENANCE</b>	
4.2 Vibration Isolators	11	9.1 General requirements	34
4.3 External hydraulic circuit	11	9.2 Planned maintenance	34
4.4 Hydraulic connection of the condenser	12	9.3 Refrigerant charge	35
4.5 Hydraulic connection	13	9.4 Compressor	35
4.6 Power supply	13	9.5 Condenser	35
4.7 Electrical connections	13	9.6 Dehydrating filter	35
<b>5 START-UP</b>		9.7 Sight glass	35
5.1 Preliminary check	14	9.8 Thermostatic expansion valve	36
5.2 Start-up	14	9.9 Evaporator	36
5.3 Checking the operation	15	<b>10 TROUBLESHOOTING</b>	37
5.4 Delivery to the customer	15	<b>11 SPARE PARTS</b>	
		11.1 Spare part list	39
		11.2 Oil for compressors	39
		11.3 Wiring diagrams	39
		<b>12 DISMANTLING, DEMOLITION AND SCRAPPING</b>	
		12.1 Generalities	40

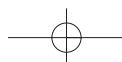

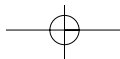

## Foreword

### 1 FOREWORD

#### 1.1 Introduction

Itelco-Clima units, manufactured to state-of-the-art design and implementation standards, ensure top performance, reliability and fitness to any type of air-conditioning systems.

These units are designed for cooling water (and for water heating in heat pump models) and are unfit for any purposes other than those specified in this manual.

This manual includes all the information required for a proper installation of the units, as well as the relevant operating and maintenance instructions.

It is therefore recommended to read this manual carefully before installation or any operation on the machine. The chiller installation and maintenance must be carried out by skilled personnel only (where possible, by one of Itelco-Clima's Authorised Service Centers).

The manufacturer may not be held liable for any damage to people or property caused by improper installation, start-up and/or improper use of the unit and/or failure to implement the procedures and instructions included in this manual.

#### 1.2 Warranty

These units are delivered complete, tested and ready for being operated. Any form of warranty will become null and void in the event that the appliance is modified without Itelco-Clima's preliminary written authorisation.

This warranty shall apply providing that the installation instructions have been complied with (either issued by Itelco-Clima, or deriving from the current practice), and the Form 1 ("Start-up") has been filled-in and mailed to Itelco-Clima (attn. After-Sales Service).

In order for this warranty to be valid, the following conditions shall be met:

- The machine must be operated only from Authorised After-Sales Service.
- Maintenance must be performed only by skilled personnel - from one of Itelco-Clima's Authorised After-Sales Centers.
- Use only original Itelco-Clima spare parts.
- Carry out all the planned maintenance provided for by this manual in a timely and proper way.

Failure to comply with any of these conditions will automatically void the warranty.

#### 1.3 Emergency stop / Normal stop

The emergency stop of the unit can be enabled using the master switch on the control panel (move down the lever).

For a normal stop, press the relevant push-buttons.

To restart the appliance, follow the procedure detailed in this manual.

#### 1.4 An introduction to the manual

For safety reasons, it is imperative to follow the instructions given in this manual. In case of any damage caused by non-compliance with these instructions, the warranty will immediately become null and void.

Conventions used throughout the manual:



The Danger sign recalls your attention to a certain procedure or practice which, if not followed, may result in serious damage to people and property.



The Warning sign precedes those procedures that, if not followed, may result in serious damage to the appliance.



The Notes contain important observations.



The Useful Tips provide valuable information that optimises the efficiency of the appliance.

This manual and its contents, as well as the documentation which accompanies the unit, are and remain the property of Constructor, which reserves any and all rights thereon. This manual may not be copied, in whole or in part, without Constructor's written authorization.

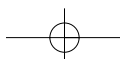

## Safety

## 2 SAFETY

### 2.1 Foreword

These units must be installed in conformity with the provisions of Machinery Directive 98/37/EC, Low Voltage Directive 73/23/EC, Pressure Vessels Directive 97/23/EC, Electromagnetic Interference Directive 89/336/EC, as well as with other regulations applicable in the country of installation. If these provisions are not complied with, the unit must not be operated.



**The unit must be grounded, and no installation and/or maintenance operations may be carried out before deenergising the electrical panel of the unit.**

Failure to respect the safety measures mentioned above may result in electrocution hazard and fire in the presence of any short-circuits.



**Inside the heat exchangers, the compressors and the refrigeration lines, this unit contains liquid and gaseous refrigerant under pressure. The release of this refrigerant may be dangerous and cause injuries.**



**The units are not designed to be operated with natural refrigerants, such as hydrocarbons. Itelco-Clima may not be held liable for any problems deriving from the replacement of original refrigerant or the introduction of hydrocarbons.**

Itelco-Clima units are designed and manufactured according to the requirements of European Standard PED 97/23/EC (pressure vessels).

- The used refrigerants are included in group II (non-hazardous fluids).
- The maximum working pressure values are mentioned on the unit's data plate.
- Suitable safety devices (pressure switches and safety valves) have been provided, to prevent any anomalous overpressure inside the plant.
- The vents of the safety valves are positioned and oriented in such a way as to reduce the risk of contact with the operator, in the event that the valve is operated. Anyway, the installer will convey the discharge of the valves far from the unit.



**It is the User's responsibility to ensure that the unit is fit for the conditions of intended use and that both installation and maintenance are carried out by experienced personnel, capable of respecting all the recommendations provided by this manual. It is important that the unit is adequately supported, as detailed in this manual. Non-compliance with these recommendations may create hazardous situations for the personnel.**



**The unit must rest on a base which meets the characteristics specified in this manual; a base with inadequate characteristics is likely to become a source of serious injury to the personnel.**



The unit has not been design to withstand loads and/or stress that may be transmitted by adjacent units, piping and/or structures. Each external load or stress transmitted to the unit may break or cause breakdowns in the unit's structure, as well as serious dangers to people. In these cases, any form of warranty will automatically become null and void.



The packaging material must not be disposed of in the surrounding environment or burnt.

### 2.2 Definitions

**OWNER:** means the legal representative of the company, body or individual who owns the plant where Itelco-Clima unit has been installed; he/she has the responsibility of making sure that all the safety regulations specified in this manual are complied with, along with the national laws in force.

**INSTALLER:** means the legal representative of the company who has been given by the owner the job of positioning and performing the hydraulic, electric and other connections of Itelco-Clima unit to the plant: he/she is responsible for handling and properly installing the appliance, as specified in this manual and according to the national regulations in force.

**OPERATOR:** means a person authorised by the owner to do on Itelco-Clima unit all the regulation and control operations expressly described in this manual, that must be strictly complied with, without exceeding the scope of the tasks entrusted to him.

## Safety

**ENGINEER:** means a person authorised directly by Itelco-Clima or, in all EC countries, excluding Italy, under his full responsibility, by the distributor of Itelco-Clima product, to perform any routine and extraordinary maintenance operations, as well as any regulation, control, servicing operations and the replacement of pieces, as may be necessary during the life of the unit.

### 2.3 Access to the unit

The unit must be placed in an area which can be accessed also by OPERATORS and ENGINEERS; otherwise the unit must be surrounded by a fence at not less than 2 meters from the external surface of the machine.

OPERATORS and ENGINEERS must enter the fenced area only after wearing suitable clothing (safety shoes, gloves, helmet etc.). The INSTALLER personnel or any other visitor must always be accompanied by an OPERATOR.

For no reason shall any unauthorised personnel be left alone in contact with the unit.

### 2.4 General precautions

The OPERATOR must simply use the controls of the unit; he must not open any panel, other than the one providing access to the control module.

The INSTALLER must simply work on the connections between plant and machine; he must not open any panels of the machine and he must not enable any control.

When you approach or work on the unit, follow the precautions listed below:

- do not wear loose clothing or jewellery or any other accessory that may be caught in moving parts
- wear suitable personal protective equipment (gloves, goggles etc.) when you have to work in the presence of free flames (welding operations) or with compressed air
- if the unit is placed in a closed room, wear ear protection devices
- cut off connecting pipes, drain them in order to balance the pressure to the atmospheric value before disconnecting them, disassemble connections, filters, joints or other line items
- do not use your hands to check for any pressure drops
- use tools in a good state of repair; be sure to have understood the instructions before using them
- be sure to have removed all tools, electrical cables and any other objects before closing and starting the unit again

### 2.5 Precautions against residual risks

#### Prevention of residual risks caused by the control system

- be sure to have perfectly understood the operating instructions before carrying out any operation on the control panel
- when you have to work on the control panel, keep always the operating instructions within reach
- start the unit only after you have checked its perfect connection to the plant
- promptly inform the ENGINEER about any alarm involving the unit
- do not reset manual restoration alarms unless you have identified and removed their cause

#### Prevention of residual mechanical risks

- install the unit according to the instructions provided in this manual
- carry out all the periodical maintenance operations prescribed by this manual
- wear a protective helmet before accessing the interior of the unit
- before opening any panelling of the machine, make sure that it is secured to it by hinges
- do not remove the guards from moving elements while the unit is running
- check the correct position of the moving elements' guards before restarting the unit

#### Prevention of residual electrical risks

- connect the unit to the mains according to the instructions provided in this manual
- periodically carry out all the maintenance operations specified by this manual
- disconnect the unit from the mains by the external disconnecting switch before opening the electrical board
- check the proper grounding of the unit before start-up
- check all the electrical connections, the connecting cables, and in particular the insulation; replace worn or damaged cables
- periodically check the board's internal wiring
- do not use cables having an inadequate section or flying connections, even for limited periods of time or in an emergency

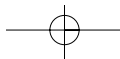

## Safety

### Prevention of other residual risks

- make sure that the connections to the unit conform to the instructions provided in this manual and on the unit's panelling
- if you have to disassemble a piece, make sure that it has been properly mounted again before restarting the unit
- do not touch the delivery pipes from the compressor, the compressor and any other piping or component inside the machine before wearing protective gloves
- keep a fire extinguisher for electrical appliances near the machine
- on the units installed indoors, connect the safety valve of the refrigeration circuit to a piping network that can channel any overflowing refrigerant outside
- remove and leak of fluid inside and outside the unit
- collect the waste liquids and dry any oil spillage
- periodically clean the compressor compartment, to remove any fouling
- do not store flammable liquids near the unit
- do not disperse the refrigerant and the lubricating oil into the environment
- weld only empty pipes; do not approach flames or other sources of heat to refrigerant pipes
- do not bend/hit pipes containing fluids under pressure

### 2.6 Precautions during maintenance operations

Maintenance operations can be carried out by authorised technicians only.

Before performing any maintenance operations:

- disconnect the unit from the mains with the external disconnecting switch
- place a warning sign "do not turn on - maintenance in progress" on the external disconnecting switch
- make sure that on-off remote controls are inhibited
- wear suitable personal protective equipment (helmet, safety gloves, goggles and shoes etc.)

To carry out any measurements or checks which require the activation of the machine:

- work with the electrical board open only for the necessary time
- close the electrical board as soon as the measurement or check has been completed

The following precautions must be always adopted:

- do not scatter the fluids of the refrigeration circuit in the surrounding environment
- when replacing an eprom or electronic cards, use always suitable devices (extractor, antistatic bracelet, etc.)
- to replace a compressor, the evaporator, the condensing coils or any other weighty element, make sure that the lifting equipment is consistent with the weight to be lifted
- contact Itelco-Clima for any modifications to the refrigeration, hydraulic or wiring diagram of the unit, as well as to its control logics
- contact Itelco-Clima if it is necessary to perform very difficult disassembly and assembly operations
- use only original spare parts purchased directly from Itelco-Clima or the official retailers of the companies on the recommended spare parts list
- contact Itelco-Clima if it is necessary to handle the unit one year after its positioning on site or if you wish to dismantle it.

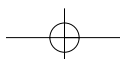



## Safety

### 2.7 Safety labels

The labels below will be affixed to each unit in the indicated point:

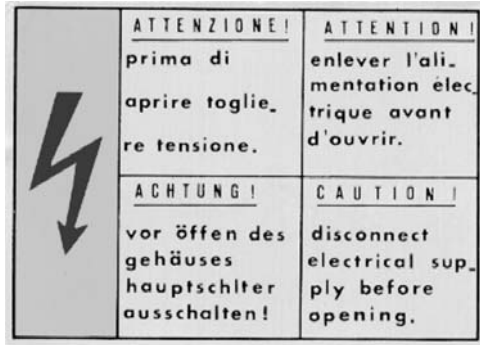

**Electrical warning  
Adjacent to the master switch**

**EIN - INLET  
ENTRÉE - ENTRATA  
AUS - OUTLET  
SORTIE - USCITA  
Fitting identification -  
Adjacent to fittings**

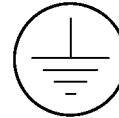

**Grounding connection - On the electrical board, adjacent to the connection**

**COD.PRODOTTO NEUTRO**   
PRODUCT CODE

**MODELLO**   
MODEL

**CE**

**OdL**

**MATRICOLA**   
SERIAL NUMBER

**ANNO DI COSTRUZIONE**

**CARICA REFR.** CIRCUITO 1 2 3 4  
REFRIGERANT CHARGE  Kg

**ALTA PRESSIONE** (max) bar   
HIGH PRESSURE

**BASSA PRESSIONE** (max) bar   
LOW PRESSURE

**ALIM. POTENZA** V/PH/Hz

**CORRENTE DI SPUNTO** (max) A   
LRA

**CORRENTE A PIENO CARICO** (max) A

**POTENZA ASSORBITA** (max) Kw   
POWER INPUT

**PRESS. ESERC.ACQUA** (max) bar   
WATER OPERATION PRESSURE

**MASSA** (max) Kg   
MASS

ITELCO CLIMA S.r.l Via XXV Aprile 29 20030 BARLASSINA MI(ITALIA)  
MADE IN ITALY

**Identification of the unit -  
Outside, on the right-hand front column**

CERTIFICATO DI COLLAUDO PRODUZIONE ITELCO-CLIMA  
ITELCO-CLIMA PRODUCTION TEST CERTIFICATE

UNITA' ARIA-ARIA/ARIA-ACQUA - SEMICENTRALI- CHILLER AIR/AIR AIR/WATER

des. anal. prod. qual. cert.  
1. coll. teste  
n. serie. tipo prod.  
serial number product test  
anno di costruzione  
construct of year

PROGR. COLL. NUMBER CHECK	DESCRIZIONE DEI TEST DESCRIPTION OF QUALITY CHECK	TIMERO OPERAT. INSP. CODE
01	VERIFICA ASSEMBLAGGIO VERIFY ASSEMBLY COMPLETE	
02	VERIFICA VISIVA CABLAGGIO COLLEG. ELETTRICI E CONNESSIONE VERIFY WIRING CONNECTIONS	
03	VUOTO E CARICA REF. VACUUM AND CHARGE TEST	
04	VERIFICA CON CERCAFUGHE TENUTA CIRCUITO FRIGORIFERO REFRIGERANT LEAK TEST	
05	PROVE FUNZIONALI CON RILIEVI TEMPERATURE/PRESSIONI-RUMORE FUNCTION AND RUN TEST NOISE TEST	
06	VERIFICA INTERVENTI SICUREZZE PRESSIONE E TEMPERATURA CHECK OPERATION AND SAFETY DEVICES	
07	VERIFICA TENUTA CIRCUITO IDR. E FUNZIONAMENTO POMPA (SU PACK) HYDRAULIC CIRCUIT TEST (PUMP CHECK ONLY FOR PACK UNIT)	
08	VERIFICA MONTAGGIO ACCESSORI (SE PREVISTI) E DOCUMENTAZIONE CHECK ACCESSORIES/DOCUMENTATION	
09	CONTROLLO ESTETICO FINALE E PULIZIA INTERNA VISUAL CHECK FOR DIRT AND DAMAGE	

**Final Test Certificate -  
Inside the external door**

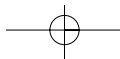

## Safety

### 2.8 Safety regulations

Refrigerant data	Safety data: R407C
Toxicity	Low
Contact with skin	If sprayed, the refrigerant is likely to cause frost burns. If absorbed by the skin, the danger is very limited; it may cause a slight irritation, and the liquid is degreasing. Unfreeze the affected skin with water. Remove the contaminated clothes with great care - in the presence of frost burns, the clothes may stick to the skin. Wash with plenty of warm water the affected skin. In the presence of symptoms such as irritation or blisters, obtain medical attention.
Contact with eyes	Vapours do not cause harmful effects. The spraying of refrigerant may cause frost burns. Wash immediately with a proper solution or with tap water for at least 10 minutes, and then obtain medical attention.
Ingestion	Very unlikely - should something happen, it will cause frost burns. Do not induce vomiting. Only if the patient is conscious, wash out mouth with water and give some 250 ml of water to drink. Then, obtain medical attention.
Inhalation	R407C: remarkable concentrations in the air may have an anaesthetic effect, up to fainting. The exposure to considerable amounts may cause irregular heartbeat, up to the sudden death of the patient. Very high concentrations may result in the risk of asphyxia, due to the reduction in the oxygen percentage in the atmosphere. Remove the patient to fresh air and keep warm and at rest. If necessary, give oxygen. In case of breathing difficulties or arrest, proceed with artificial respiration. In case of cardiac arrest, proceed with cardiac massage. Then, obtain medical attention.
Recommendations	Semiotics or support therapy is recommended. Cardiac sensitisation has been observed that, in the presence of circulating catecholamines such as adrenalin, may cause cardiac arrhythmia and accordingly, in case of exposure to high concentrations, cardiac arrest.
Prolonged exposure	R407C: a study on the effects of exposure to 50,000 ppm during the whole life of rats has identified the development of benign testicle tumour. This situation should therefore be negligible for personnel exposed to concentrations equal to or lower than professional levels.
Professional levels	R407C: Recommended threshold: 1000 ppm v/v - 8 hours TWA.
Stability	R407C: Not specified
Conditions to avoid	Do not use in the presence of flames, burning surfaces and excess humidity.
Hazardous reactions	May react with sodium, potassium, barium and other alkaline metals. Incompatible substances: magnesium and alloys with magnesium concentrations > 2%.
Hazardous decomposition products	R407C: Halogen acids produced by thermal decomposition and hydrolysis.

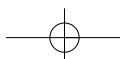



## Safety

---

General precautions	Do not inhale concentrated vapours. Their concentration in the atmosphere should not exceed the minimum preset values and should be maintained below the professional threshold. Being more weighty than the air, the vapour concentrates on the bottom, in narrow areas. Therefore, the exhaust system must work at low level.
Respiratory system protection	If you are in doubt about the concentration in the atmosphere, it is recommended to wear a respirator approved by an accident-prevention Authority, of the independent or oxygen type.
Storage	Cylinders must be stored in a dry and fresh place, free from any fire hazard, far from direct sunlight or other sources of heat, radiators etc. Keep a temperature below 45°C.
Protective clothing	Wear overalls, protective gloves and goggles or a mask.
Accidental release measures	It is important to wear protective clothing and a respirator. Stop the source of the leak, if you can do this without danger. Negligible leaks can be left evaporating under the sun, providing that the room is well ventilated. Considerable leaks: ventilate the room. Reduce the leak with sand, earth or other absorbing substances. Make sure that the liquid does is not channelled into gutters, sewers or pits where the vapours are likely to create a stuffy atmosphere.
Disposal	The best method is recovery and recycling. If this method is not practicable, dispose according to an approved procedure, that shall ensure the absorption and neutralization of acids and toxic agents.
Fire fighting information	R407C: Not flammable in the atmosphere.
Cylinders	The cylinders, if exposed to fire, shall be cooled by water jets; otherwise, if heated, they may explode.
Protective fire fighting equipment	In case of fire, wear an independent respirator and protective clothing.

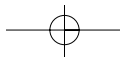

## Safety

<b>Refrigerant oil data</b>	<b>Safety data: Polyolester oil (POE)</b>
Classification	Not harmful
Contact with skin	May cause slight irritation. Does not require first aid measures. It is recommended to follow usual personal hygiene measures, including washing the exposed skin with soap and water several times a day. It is also recommended to wash your overalls at least once a week.
Contact with eyes	Wash thoroughly with a suitable solution or tap water.
Ingestion	Seek medical advice immediately.
Inhalation	Seek medical advice immediately.
Conditions to avoid	Strong oxidising substances, caustic or acid solutions, excess heat. May corrode some types of paint or rubber.
Protection of the respiratory system	Use in well ventilated rooms.
Protective clothing	Always wear protective goggles or a mask. Wearing protective gloves is not mandatory, but is recommended in case of prolonged exposure to refrigerant oil.
Accidental release measures	It is important to wear protective clothing and, especially, goggles. Stop the source of the leak. Reduce the leak with absorbing substances (sand, sawdust or any other absorbing material available on the market).
Disposal	The refrigerant oil and its waste will be disposed of in an approved incinerator, in conformity with the provisions and the local regulations applicable to oil waste.
Fire fighting information	In the presence of hot liquid or flames, use dry powder, carbon dioxide or foam. If the leak is not burning, use a water jet to remove any vapours and to protect the personnel responsible for stopping the leak.
Cylinders	The cylinders exposed to a fire will be cooled with water jets in case of fire.
Fire fighting protective equipment	In case of fire, wear an independent respirator.

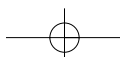

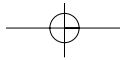

## Transport, Lifting and Positioning

### 3 TRANSPORT, LIFTING AND POSITIONING

Refrigerators are supplied assembled. The equipment are full of refrigerant and oil, in the quantity required for a proper operation.

#### 3.1 Inspection

When the unit is delivered, it is recommended to check it carefully and to identify any damage occurred during transportation. The goods are shipped ex-factory, at the buyer's risk. Check that the delivery includes all the components listed in the order.

In case of damage, note it down on the carrier's delivery note and issue a claim according to the instructions provided in the delivery note.

In the presence of any serious damage, that does not affect the surface only, it is recommended to inform Itelco-Clima immediately.

Please note that Itelco-Clima may not be held liable for any damage to the equipment during transportation, even though the carrier has been appointed by the factory.

#### 3.2 Unit Handling



Sharp edges and coil surfaces are a potential hazard. Avoid contact with them.

Be careful to avoid rough handling of the unit. Do not push or pull the unit anything other than the base. Block the pushing vehicle away from the unit to prevent damage to the sheet metal cabinet and end frame (see picture 1).

Blocking required across  
(full width)

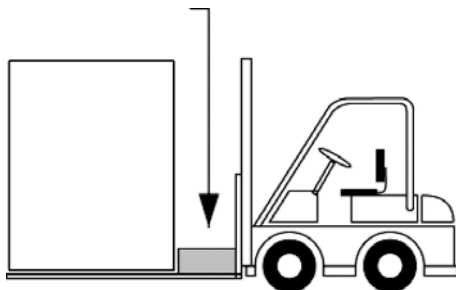

Picture 1

#### 3.3 Anchoring

It is not essential to secure the unit to the foundations, unless in areas where there is a serious risk of earthquake, or if the appliance is installed on the top of a steel frame.

#### 3.4 Storage

When the unit is to be stored before installation, adopt a few precautions to prevent any damage or risk of corrosion or wear:

- plug or seal every single opening, such as water fittings
- do not store the appliance in a room where the temperature exceeds 50°C for the units using R407C and, if possible, do not expose to direct sunlight
- it is recommended to store the unit in a roof where traffic is minimized, to prevent the risk of accidental damage
- the unit must not be washed with a steam jet
- take away and leave to the site manager all the keys providing access to the control board

Finally, it is recommended to carry out visual inspections at regular intervals.

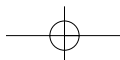



## Installation



The capacity of the expansion vessel must allow for an expansion of at least 2% of the volume of the fluid in the circuit (evaporator, piping, user circuit and standby tank, if any). The expansion vessel needs not be isolated, because no water can circulate inside it.

- A flow meter, to disable the appliance when the water is not circulating.



The flow meter shall be connected (terminals 7-8).

### To install the flow meter, conform to the manufacturer's instructions.

As a general rule, the flow meter must be mounted on a horizontal pipe, and its distance from the curves must be 10 times the diameter of the pipe, far from valves or other components that may hinder the water flow upstream of or downstream from the flow meter.

- The air exhaust valves must be mounted in the highest point of the piping.
- The stop valves must be mounted on the water inlet/outlet piping of the evaporator and the heat recovery condenser.
- The drain points (provided with plugs, cocks etc.) must be positioned in the lowest point of the piping.

Furthermore:

- Provide the evaporator with a by-pass circuit equipped with valve, to wash the plant.
- Insulate the piping, to prevent the risk of heat loss.
- Install a filter on the suction side of the evaporator or the heat recovery condenser.



Before filling the circuit, it is important to check that it is free from any foreign matter, sand, gravels, rust, welding deposits, waste and other materials that may damage the evaporator.

When cleaning the lines, it is recommended to create a circuit by-pass. It is important to mount a filtering medium (30 mesh) upstream of the chiller.



If necessary, the water required to fill the circuit must be treated to obtain the requested PH.

## 4.4 Hydraulic connection of the condenser



The external hydraulic circuit must ensure the water flow to the condenser under any working or adjustment conditions.

The cooling of the units is generally ensured by connecting the condenser to a cooling tower, though the units can be cooled also with well water.

In the presence of a water-cooled condenser, it is necessary to check the flow rate and/or the temperature of the cooling fluid that flows through the condenser, so as to maintain the refrigerant pressure at values that can ensure a satisfactory operation.

When a cooling tower is used, the simplest regulation methods consist of checking the operation or the speed of the fan or the air volume, by means of a damper, once the pilot thermostat has been installed in the basin of the tower.

Alternatively, or if no water from a cooling tower is used, you can adopt a recirculation system provided with a 3-way valve.

This circuit shall consist of:

- A circulation pump that can ensure the necessary capacity and discharge head.
- A flow meter to turn off the appliance when no water is circulating.



The flow meter must be connected in series, as shown in the wiring diagram of the control panel.

### To install the flow meter, follow the manufacturer's instructions.

As a general rule, the flow meter shall be mounted on a horizontal pipe, at a distance from the curves equal to 10 times the diameter of the pipe and far from valves or other components that are likely to hinder the water flow upstream of or downstream from the flow meter.

- The bleed valves must be mounted on the highest point of the piping.
- The stop valves must be mounted on the piping of the water entering/leaving the condenser.
- The discharge points (provided with plugs, cocks etc.) must be arranged in the lowest point of the piping.

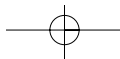

## Installation

Furthermore:

- Provide the condenser with a by-pass circuit, equipped with a shutoff valve.
- Insulate piping, to prevent the risk of heat loss.
- Install a filter on the suction side of the condenser.

To install the flow meter, follow the diagram illustrated in paragraph 4.3.

### 4.5 Hydraulic connection

The water inlet/outlet fittings shall conform to the instructions provided by the plates affixed near the connection points.

### 4.6 Power supply



Before carrying out any operations on the electrical system, make sure that the unit is deenergised.



It is important that the appliance is grounded.



The company in charge of the installation shall conform to the standards applicable to outdoor electrical connections.

**Itelco-Clima may not be held liable for any damage and/or injury caused by failure to comply with these precautions.**

The unit conforms to EN 60204-1.

The following connections shall be provided:

- A 3-phase and grounding connection for the power supply circuit.
- The electrical distribution system shall meet the power absorbed by the appliance.
- The disconnecting and magnetothermal switches must be sized to control the starting current of the unit.
- The power supply lines and the insulation devices must be designed in such a way that every line independent.
- It is recommended to install differential switches, to prevent any damage caused by phase drops.

- The compressors are supplied through contactors controlled from the control panel.
- Each motor is provided with a thermal protection and a magnetic protection.
- The power supply cables must be inserted into dedicated openings on the front of the unit, and they will enter the electrical board through holes drilled on the bottom of the board.

### 4.7 Electrical connections

**The unit must be installed on site according to the Machinery Directive (98/37/EC), the Low Voltage Directive (73/23/EC), the Electromagnetic Interference Directive (89/336/EC) and the usual procedures and standards applicable in the place of installation. The unit must not be operated if its installation has not been carried out according to the instructions provided in this manual.**

**The power supply lines must consist of insulated copper conductors, dimensioned for the maximum absorbed current.**

Connection to terminals must be performed according to the wiring diagram which accompanies the unit.



Before connecting the power supply lines, check that the available voltage value does not exceed the range specified in the Electric Data (Chapter 8).

For 3-phase systems, check also that the unbalance between the phases does not exceed 2%. To perform this check, measure the differences between the voltage of each phase couple and their mean value during operation. The maximum % value of these differences (unbalance) must not exceed 2% of the mean voltage.

If the unbalance is unacceptable, contact the Energy Distributor to solve this problem.



Supplying the unit through a line whose unbalance exceeds the permissible value will automatically void the warranty.

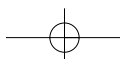

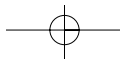

## Start-up

### 5 START-UP



The first start-up of the unit, with a cooling capacity equal to or greater than 17 kW, shall be performed by an Authorised After-Sales Service Centre. Failure to meet this requirement will immediately void the warranty.



The operations carried out by Itelco-Clima personnel are limited to the start-up of the unit, and do not include any other operation on the plant, such as, for example, electrical and hydraulic connections etc. All the other operations before start-up, including oil pre-heating for at least 12 hours, must be performed by the Installer..

#### 5.1 Preliminary check

The checks listed below shall be performed before starting the unit and before the arrival of the personnel authorised by Itelco-Clima.

- Check the section of power supply and grounding cables; make sure that terminals are tightened and check the correct operation of contactors, with the master switch open.
- Check that any voltage and phase variation in the power supply does not exceed the prefixed thresholds.
- Connect the contacts of the flow meter and the thermal relay of the pump and of the other devices (if any), to terminals 7-8 and 9-10, respectively.
- Check that the components of the external water circuit (pump, user equipment, filters, power supply tank and reservoir, if any) have been installed properly, and according to the manufacturer's instructions.
- Check the filling of the hydraulic circuits, and make sure that the fluid circulation is correct, without any trace of leaks and air bubbles. If you use ethylene glycol as antifreeze, check that its percentage is correct.
- Check that the direction of rotation of the pumps is correct, and that fluids have been circulating for at least 12 hours for both pumps. Then, clean the filters on the suction side of the pumps.
- Adjust the liquid distribution network in such a way that the flow rate is within the specified range.

- Check that the water quality is up to the specifications.
- Check that oil heaters, if any, have been turned on at least 12 hours before.

#### 5.2 Start-up

Start-up sequence:

- Turn on the master switch (at least 12 hours before).
- Check that the oil in the compressor has reached the requested temperature (the minimum temperature outside the pan must be approx. 40°C) and that the auxiliary control circuit is energised.
- Check the operation of all the external equipment, and make sure that the control devices of the plant are properly calibrated.
- Start the pump and check that the water flow is correct.
- Set the desired fluid temperature on the control board.
- Start the appliance (see Chapter 6).
- Check the correct direction of rotation of compressors. Scroll compressors cannot compress the refrigerant when they rotate in the opposite direction. To make sure that they are rotating in the correct direction, simply check that, just after the start-up of the compressor, the pressure drops on the LP side and rises on the HP side. Furthermore, if a scroll compressor rotate in the opposite direction, there is a considerable rise in the sound level of the unit, as well as in a dramatic reduction of current absorption compared to normal values. In case of wrong rotation, the scroll compressor can be definitely damaged.
- After about 15 minutes of operation check that there are no bubbles, through the sight glass on the liquid line.



The presence of bubbles may indicate that a part of the refrigerant charge has been released in one or more points. It is important to remove these leaks before proceeding.

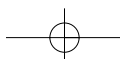



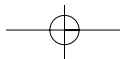

## Start-up

---

- Repeat the start-up procedure after removing the leaks.
- Check the oil level in the compressor's sight glass.

### 5.3 Checking the operation

Check the following:

- The temperature of the water entering the evaporator.
- The temperature of the water leaving the evaporator.
- The level of the water flow rate in the evaporator, if possible.
- The current absorption upon the start of the compressor and in case of stabilised operation.

Check that the condensing and evaporation temperatures, during operation at high and low pressure detected by the pressure gauges of the refrigerant, are within the following range:

(On the units not provided with HP/LP pressure gauges for the refrigerant, connect a pressure gauge to the Schrader valves on the refrigeration circuit).

<b>HP side</b>	Approx 7 to 11°C above the inlet water temperature of condenser
<b>LP side</b>	Approx 3.5 to 5°C below the temperature of the leaving chilled water

### 5.4 Delivery to the customer

- Train the user according to the instructions provided in Section 6.

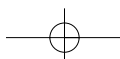

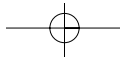

## Control System

### 6 CONTROL SYSTEM

#### 6.1 CWP Control system *μchiller*

##### 6.1.1 Temperature controller

The controller mounted on COOLING ONLY units is shop calibrated to control the unit according to the temperature of the chilled water returning from the system. Therefore, its probe is installed in the point where the water enters the refrigerant/water exchanger, so that it can detect the system load. The only regulation required for the controller is the calibration of the set point, which can be carried out in the 10 to 18 °C range (the shop calibration is 12 °C). Regarding the units in HEAT PUMP solution, the controller can be calibrated from 25 °C to 45 °C for heating (the shop calibration is 40 °C); the requirements specified for the units in cooling only solution shall apply also to cooling.

In order to set the cooling set point to a value lower than the shop setting, it is essential that you add some antifreeze to the circulating water and re-calibrate accordingly all the safety components of the equipment.

**NOTE:** To set the entering water temperature set point to values below 10 °C, consult our Technical Department to become acquainted with all the precautions that should be adopted for a perfect operation of the equipment

##### 6.1.2 Antifreeze function

The antifreeze protection (managed by the controller) is activated on all models when the leaving water temperature drops to a value below 4 °C, and causes the safety stop of the unit. This safety device is a complement to the differential safety pressure switch.

#### Interfacing panel of the control system controller

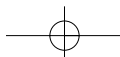
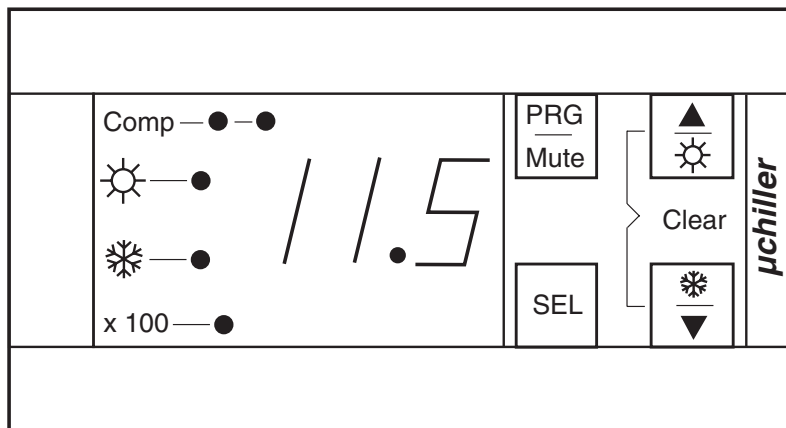

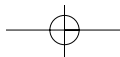

## Control System

### 6.1.3 Summary of the key functions

The meaning of each key, in the different modes, is summed up in the table below.

Key	State of the machine	Pressing the key
SEL	Normal (i.e. the display shows the temperature of probe B1)	after 5" DIRECT parameters
	Codes list	displays the value
	Value display	displays the codes list
PRG	Normal	after 5" password for USER parameters
	Codes list	stores parameters in eeprom and goes back to the display of the temperature (probe B1)
	Value display	stores parameters in eeprom and goes back to the display of the temperature (probe B1)
	Buzzer ON	turns off the buzzer
▲	Normal	after 5" enters/quits the Summer mode
	Codes list	scans the parameters' codes
	Value display	increases the value
▼	Normal	after 5" enters/quits the Winter mode
	Codes list	scans the parameters' codes
	Value display	decreases the value
PRG+SEL	Normal	after 5" password of FACTORY parameters
SEL+▲	Normal	after 5" forces a manual defrosting cycle (if allowed by the temperature/pressure conditions)
▲ + ▼	Normal	after 5" manual reactivation of the alarms,
	Hour meter display	immediate resetting of the hour meter
PRG	Upon the switching on	writes default parameters
PRG+▲	Upon the switching on	copies key on machine eeprom
PRG+▼	Upon the switching on	copies machine eeprom on key

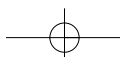

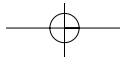

## Control System

---

### 6.2 High Pressure Control

The high pressure control is a pressure activated switch that opens on a rise in pressure. When the switch opens, the safety relay de-energizes the compressor circuit preventing the unit operation until the high pressure control is reset.

The high pressure switch requires manual reset and is factory adjusted to trip out at 28 bar.

### 6.3 Low Pressure Control

The low pressure control is a pressure switch activated by evaporator pressure. The switch opens when the pressure decreases abnormally.

### 6.4 Heat Exchanger Heater Thermostat

The evaporator heater thermostat provides freeze protection down to  $-18\text{ }^{\circ}\text{C}$  ambient temperature during unit shut down periods.

It closes at  $+4\text{ }^{\circ}\text{C}$ , activating afterwards the evaporator heating cable.

On heat pump units, both evaporator and condenser are equipped with electric heater cable and thermostat to protect against freezing.

### 6.5 Pressostatic Valve Kit (Optional)

This item is available only for cooling only units. The pressostatic valve, controlled by condensing pressure, regulates the water flow to maintain the condensing temperature at the desired value (the condensing temperature of  $+40\text{ }^{\circ}\text{C}$  is recommended).

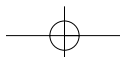

## General Description

### 7 GENERAL DESCRIPTION

#### 7.1 Introduction

The new range of chillers with water condenser, of the series CWP, includes 13 different capacities, fit for medium-sized residential, commercial and industrial applications.

All these 13 options are available in three models:

- **CWP: "cold only"**, requires a cooling tower or a dry cooler for heat dissipation purposes
- **CWP-RC: motoevaporating unit**, needs a remote condenser for heat dissipation purposes
- **CWP-HP: heat pump**, the hot water's outlet temperature can reach 51°C (in heating mode), useful for sanitary water.

#### 7.2 General Specifications

These units are provided with cabinets made of oven-painted galvanised sheet panels. These panels are soundproof, thanks to deadening sleeve (optional), to ensure absolutely noiseless operation.

All units are factory-assembled and receive the necessary charge of refrigerant and oil (except for CWP-RCs, which are shipped with a nitrogen charge) for compressors, so that they can be promptly installed. Every single unit is tested by making the water circulate through the heat exchangers, in order to check the performance of the refrigeration circuit.

#### 7.3 Compressors

All compressors are of Scroll hermetic type, and the motor is cooled by the sucked gas; they are provided with an oil heater (except from 02 to 09 models). The 02 to 21 models have a compressor, while the 25 to 30 models are equipped with two compressors.

All compressors are mounted on rubber shock absorbers, so as to minimise the sound level and the vibration transmission.

#### 7.4 Refrigeration circuits

The refrigeration circuit is provided with a thermostatic expansion valve, dehydrating cartridge filter, sight glass with a colour-change humidity indicator, HP and LP pressure switches, solenoid valve (CWP-RC only).

The CWP-HP and CWP-RC feature also a 4-way valve, a non-return valve and a liquid receiver.

#### 7.5 Evaporator

The direct-expansion evaporator consists of a welded stainless steel plate-type heat exchanger.

The evaporator's standard accessories include a closed-cell polyurethane sleeve, around which a resistor is wrapped, to protect it against frost.

#### 7.6 Condenser (except for CWP-RC)

The water-cooled condenser consists of a welded stainless steel plate-type heat exchanger.

The CWP-HP models feature a wired, insulated resistor which provides protection against frost.

#### 7.7 Switchboard

All the electrical devices required to operate the unit are housed inside a separate compartment, which can be accessed from the front side of the appliance, via a panel secured by lock screws.

The switchboard, manufactured to CE standards, includes the master disconnecter with external handle locked in the opening position, contactors and thermal protections, fuses for the control circuit, chilled water thermostat, electronic controller, HP and LP pressure switch, antifreezing thermostat, timer (to prevent frequent starts), ON/OFF switch and terminal board.

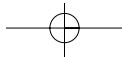

## General Description

### CWP refrigeration circuit (O2 to O5)

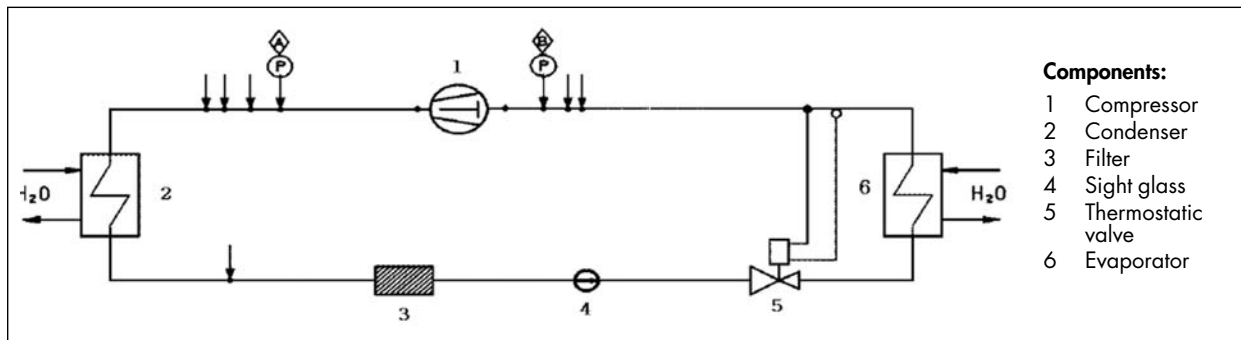

- Components:**
- 1 Compressor
  - 2 Condenser
  - 3 Filter
  - 4 Sight glass
  - 5 Thermostatic valve
  - 6 Evaporator

### CWP-RC refrigeration circuit (O2 to O5)

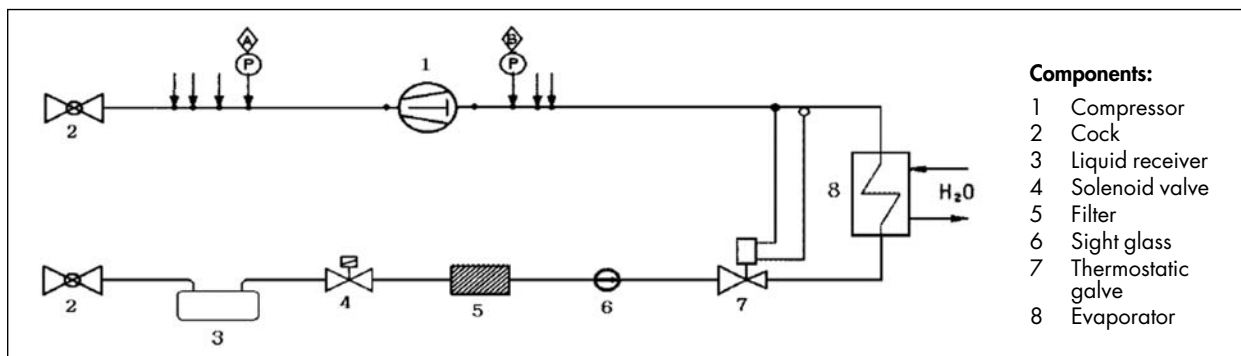

- Components:**
- 1 Compressor
  - 2 Cock
  - 3 Liquid receiver
  - 4 Solenoid valve
  - 5 Filter
  - 6 Sight glass
  - 7 Thermostatic valve
  - 8 Evaporator

### CWP-HP refrigeration circuit (O2 to O5)

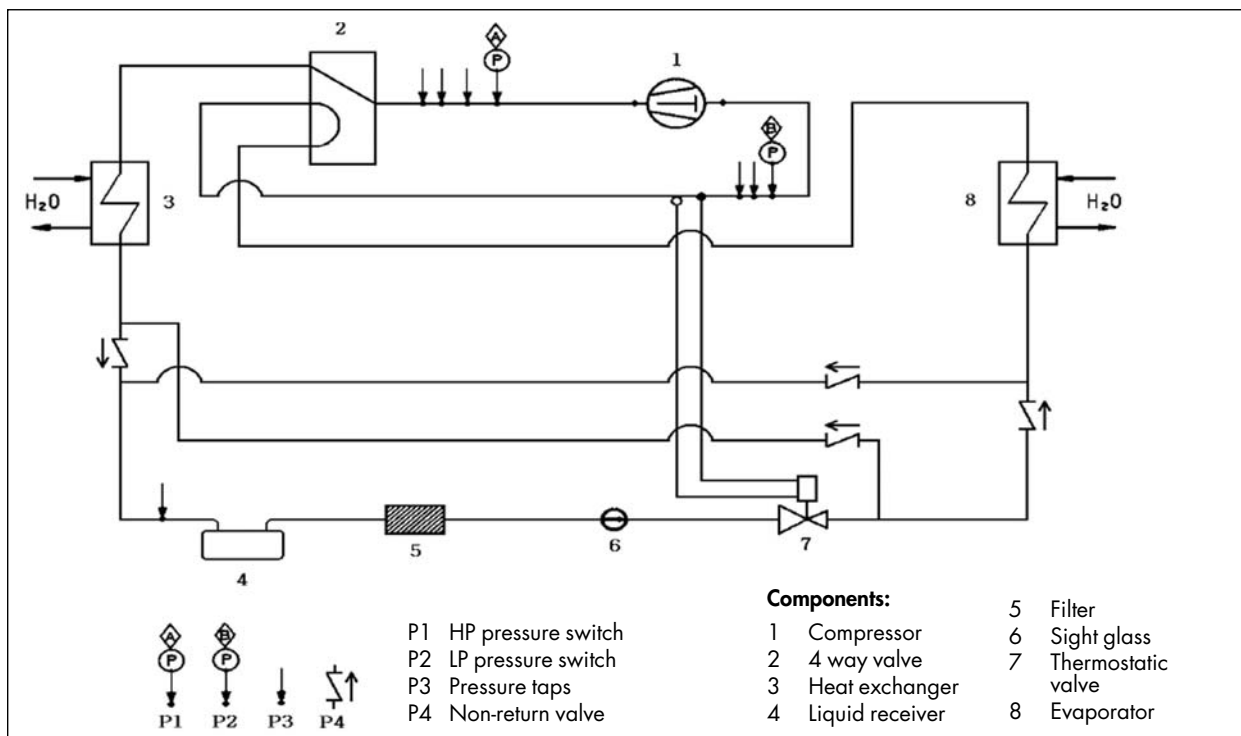

- |  |   |   |
|--|---|---|
|  | <p>P1 HP pressure switch<br/>P2 LP pressure switch<br/>P3 Pressure taps<br/>P4 Non-return valve</p> | <p><b>Components:</b></p> <ul style="list-style-type: none"> <li>1 Compressor</li> <li>2 4 way valve</li> <li>3 Heat exchanger</li> <li>4 Liquid receiver</li> <li>5 Filter</li> <li>6 Sight glass</li> <li>7 Thermostatic valve</li> <li>8 Evaporator</li> </ul> |
|--|---|---|

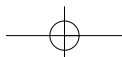

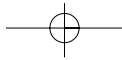

## General Description

### CWP refrigeration circuit (06 to 21)

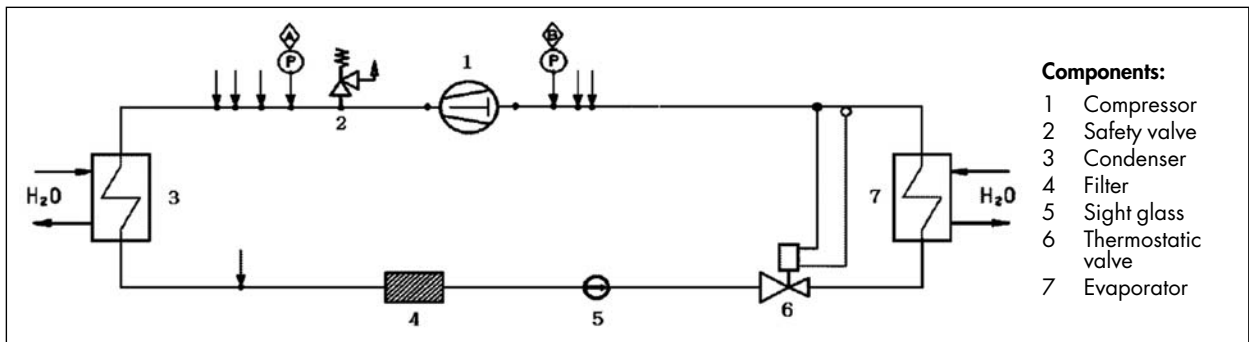

### CWP-RC refrigeration circuit (06 to 21)

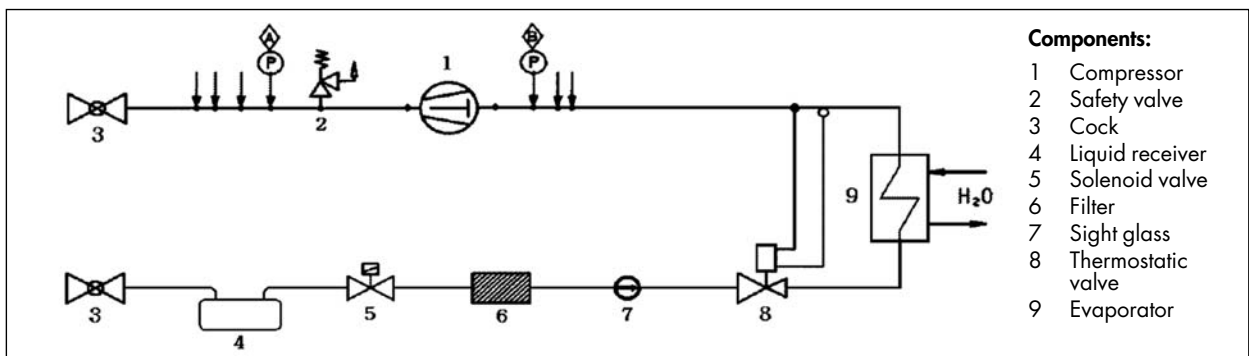

### CWP-HP refrigeration circuit (06 to 21)

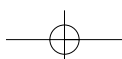
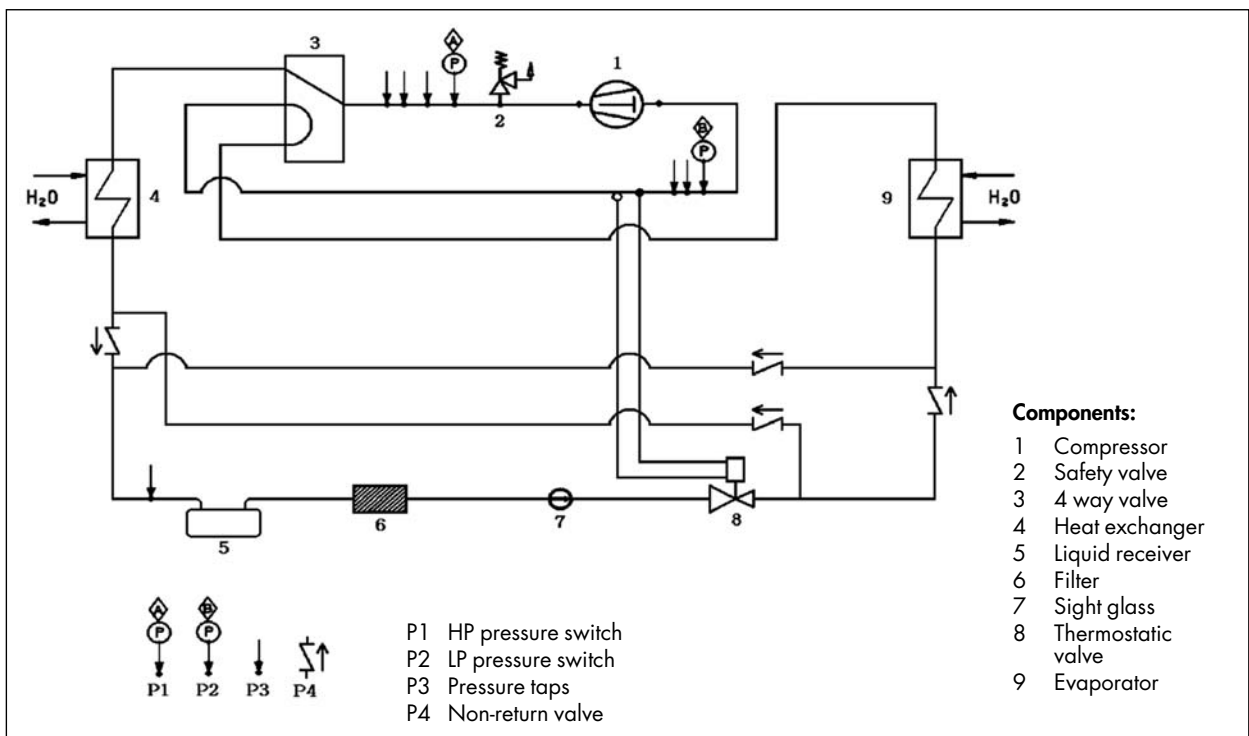



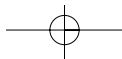

## General Description

### CWP refrigeration circuit (25 to 35)

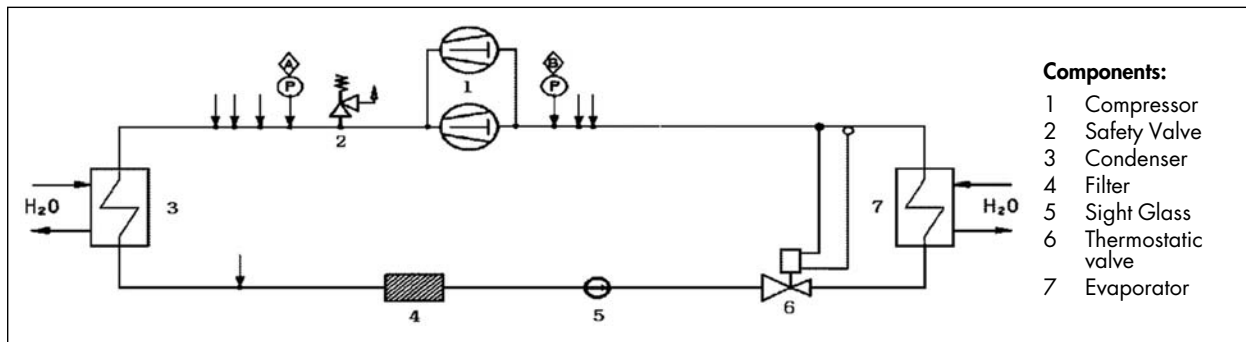

### CWP-RC refrigeration circuit (25 to 35)

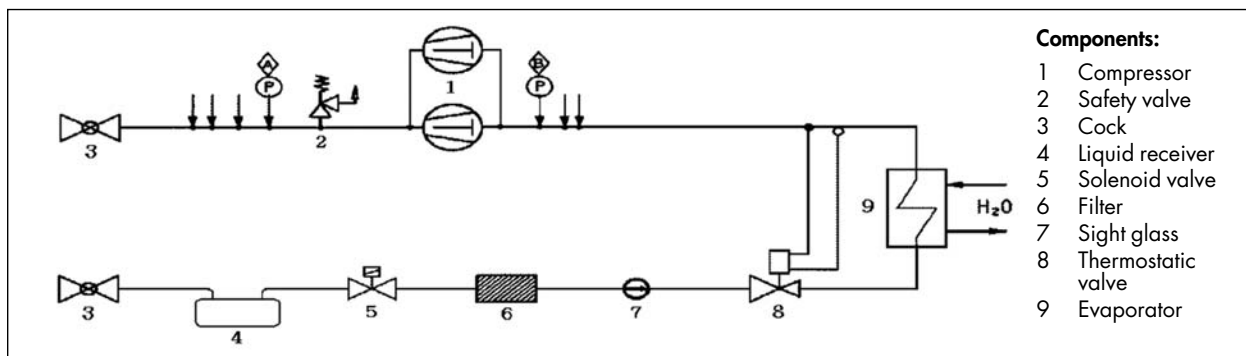

### CWP-HP refrigeration circuit (25 to 35)

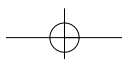
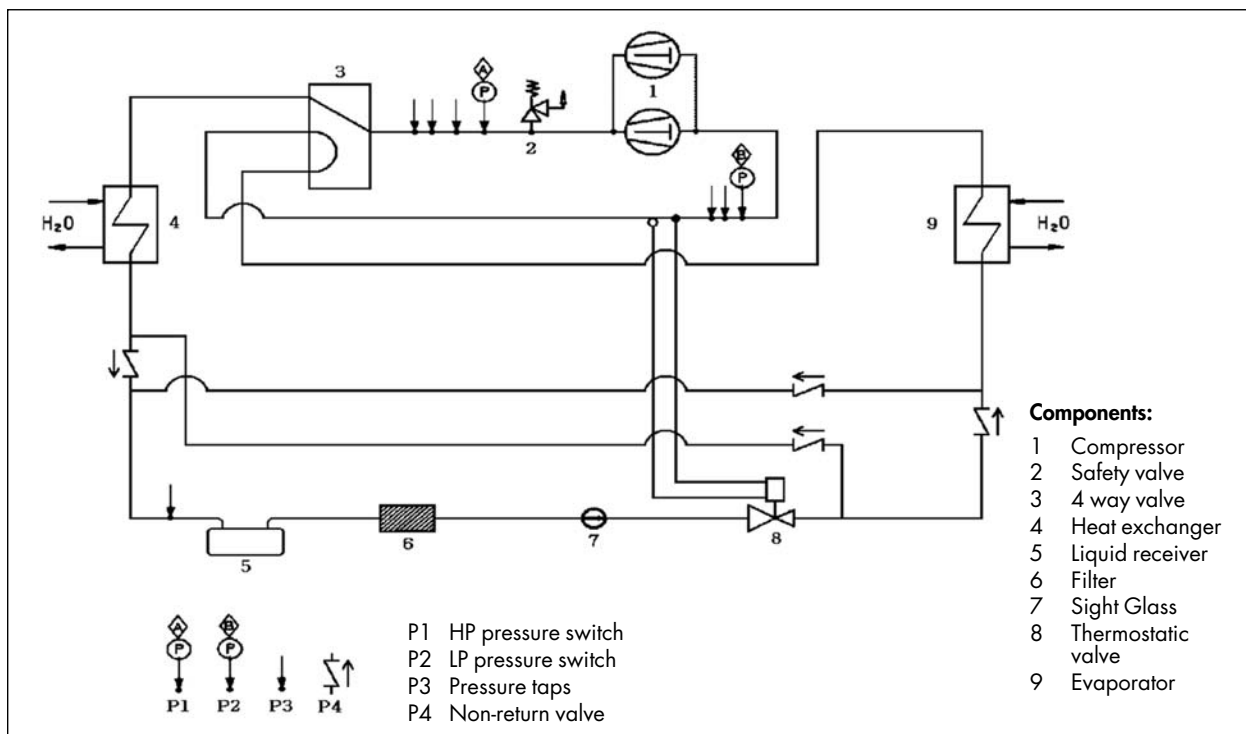

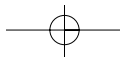

## Technical data

### 8 TECHNICAL DATA

#### 8.1 Pressure drops

PRESSURE DROPS IN THE EVAPORATOR								
CWP/CWP-HP/CWP-RC		02	03	04	05	06	07	09
K	$10^4 \text{ kPa}/(\text{m}^3/\text{s})^2$	13246.5	4657.0	4657.0	2480.0	2472.2	1477.7	1484.9
Min. water flow rate	l/s	0.3	0.3	0.5	0.6	0.7	1.0	1.2
Nominal water flow rate	l/s	0.4	0.4	0.6	0.8	0.9	1.3	1.6
Max. water flow rate	l/s	0.6	0.7	1.1	1.3	1.6	2.2	2.7
Min. pressure drops	kPa	9.6	4.6	9.6	7.7	11.2	13.5	19.6
Nominal pressure drops	kPa	18.9	9.0	18.8	15.0	21.9	26.4	38.5
Max. pressure drops	kPa	52.4	25.0	52.2	41.8	60.8	73.5	106.9

PRESSURE DROPS IN THE EVAPORATOR								
CWP/CWP-HP/CWP-RC		15	18	21	25	30	35	
K	$10^4 \text{ kPa}/(\text{m}^3/\text{s})^2$	1055.5	517.1	416.5	244.9	161.7	107.1	
Min. water flow rate	l/s	1.4	1.9	2.3	3.0	3.8	4.6	
Nominal water flow rate	l/s	1.9	2.7	3.2	4.2	5.3	6.5	
Max. water flow rate	l/s	3.2	4.4	5.4	7.0	8.9	10.8	
Min. pressure drops	kPa	20.4	19	22	22	24	23	
Nominal pressure drops	kPa	39.9	37	43	43	46	45	
Max. pressure drops	kPa	110.9	102	121	119	128	126	

PRESSURE DROPS IN THE CONDENSER								
CWP/CWP-HP		02	03	04	05	06	07	09
K	$10^4 \text{ kPa}/(\text{m}^3/\text{s})^2$	13246.5	13246.5	4657.0	4657.0	2472.2	2472.2	1484.9
Min. water flow rate	l/s	0.3	0.4	0.6	0.7	0.8	1.2	1.4
Nominal water flow rate	l/s	0.5	0.6	0.8	1.0	1.2	1.7	2.0
Max. water flow rate	l/s	0.8	0.9	1.3	1.6	2.0	2.8	3.4
Min. pressure drops	kPa	14.1	20.7	15.1	22.2	17.7	35.6	31.2
Nominal pressure drops	kPa	27.7	40.5	29.5	43.4	34.7	69.8	61.1
Max. pressure drops	kPa	76.9	112.6	82.1	120.6	96.3	193.8	169.8

PRESSURE DROPS IN THE CONDENSER								
CWP/CWP-HP		15	18	21	25	30	35	
K	$10^4 \text{ kPa}/(\text{m}^3/\text{s})^2$	1055.5	517.1	416.5	244.9	161.7	107.1	
Min. water flow rate	l/s	1.8	2.4	2.9	3.8	4.8	5.9	
Nominal water flow rate	l/s	2.5	3.3	4.1	5.3	6.7	8.2	
Max. water flow rate	l/s	4.1	5.6	6.8	8.8	11.2	13.7	
Min. pressure drops	kPa	32.7	29.4	35.5	35.0	37.0	36.9	
Nominal pressure drops	kPa	64.2	57.7	69.6	68.7	72.6	72.4	
Max. pressure drops	kPa	178.2	160.2	193.2	190.8	201.5	201.1	

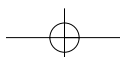

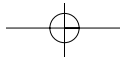

## Technical data

### 8.2 Technical data

CWP		02	03	04	05	06	07	09
Power supply	V/ph/Hz	400/3/50						
Number of circuits		1	1	1	1	1	1	1
Number of steps		1	1	1	1	1	1	1

#### Refrigerant

Type (1)		R407C						
Charge (2)	kg	1.4	1.6	1.7	2	2.7	2.8	3

#### Compressor

Type		Scroll	Scroll	Scroll	Scroll	Scroll	Scroll	Scroll
Number		1	1	1	1	1	1	1
Start-up type		Direct	Direct	Direct	Direct	Direct	Direct	Direct

#### Evaporator

Type		Plate type						
Number		1	1	1	1	1	1	1
Minimum water content	l	0.7	1.1	1.1	1.7	1.7	2.2	2.2

#### Condenser

Type		Plate type						
Number		1	1	1	1	1	1	1
Minimum water content	l	0.7	1.1	1.1	1.7	1.7	2.2	2.2

#### Evaporator Hydraulic connections

Type		Gas threaded female type						
Inlet diameter	inch	1" 1/4	1" 1/4	1" 1/4	1" 1/4	1" 1/4	1" 1/4	1" 1/4
Outlet diameter	inch	1" 1/4	1" 1/4	1" 1/4	1" 1/4	1" 1/4	1" 1/4	1" 1/4

#### Condenser Hydraulic connections

Type		Gas threaded female type						
Inlet diameter	inch	1" 1/4	1" 1/4	1" 1/4	1" 1/4	1" 1/4	1" 1/4	1" 1/4
Outlet diameter	inch	1" 1/4	1" 1/4	1" 1/4	1" 1/4	1" 1/4	1" 1/4	1" 1/4

#### Weights

Shipping weights	kg	115	119	125	138	185	197	201
Operating weights	kg	116	120	127	140	188	200	205

#### Dimensions

Length	mm	800	800	800	800	900	900	900
Height	mm	910	910	910	910	910	910	910
Width	mm	600	600	600	600	700	700	700

(1) With R22, on demand, for extra-European countries.

(2) Indicative value. Always refer to the value specified on the unit's label.

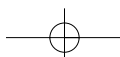

## Technical data

<b>CWP</b>		<b>15</b>	<b>18</b>	<b>21</b>	<b>25</b>	<b>30</b>	<b>35</b>
Power supply	V/ph/Hz	400/3/50					
Number of circuits		1	1	1	1	1	1
Number of steps		1	1	1	2	2	2
<b>Refrigerant</b>							
Type (1)		R407C					
Charge (2)	kg	4.3	12	5	8.5	9	11.2
<b>Compressors</b>							
Type		Scroll	Scroll	Scroll	Scroll	Scroll	Scroll
Number		1	1	1	2	2	2
Start-up type		Direct	Direct	Direct	Direct	Direct	Direct
<b>Evaporator</b>							
Type		Plate type					
Number		1	1	1	1	1	1
Minimum water content	l	2.8	4.4	5.3	6.9	8.6	10.9
<b>Condenser</b>							
Type		Plate type					
Number		1	1	1	1	1	1
Minimum water content	l	2.8	4.4	5.3	6.9	8.6	10.9
<b>Evaporator Hydraulic connections</b>							
Type		Gas threaded female type					
Inlet diameter	inch	1" 1/2	1" 1/4	1" 1/4	2"	2"	2"
Outlet diameter	inch	1" 1/2	1" 1/4	1" 1/4	2"	2"	2"
<b>Condenser Hydraulic connections</b>							
Type		Gas threaded female type					
Inlet diameter	inch	1" 1/2	1" 1/4	1" 1/4	2"	2"	2"
Outlet diameter	inch	1" 1/2	1" 1/4	1" 1/4	2"	2"	2"
<b>Weights</b>							
Shipping weights	kg	270	295	306	508	541	574
Operating weights	kg	274	290	300	500	530	560
<b>Dimensions</b>							
Length	mm	1100	1100	1100	1700	1700	1700
Height	mm	1100	1100	1100	1200	1200	1200
Width	mm	850	850	850	984	984	984

(1) With R22, on demand, for extra-European countries.

(2) Indicative value. Always refer to the value specified on the unit's label.

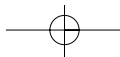

## Technical data

<b>CWP-HP</b>		<b>02</b>	<b>03</b>	<b>04</b>	<b>05</b>	<b>06</b>	<b>07</b>	<b>09</b>
Power supply	V/ph/Hz	400/3/50						
Number of circuits		1	1	1	1	1	1	1
Number of steps		1	1	1	1	1	1	1

### Refrigerant

Type (1)		R407C						
Charge (2)	kg	4.4	4.4	4.4	4.5	5.5	5.5	5.6

### Compressor

Type		Scroll	Scroll	Scroll	Scroll	Scroll	Scroll	Scroll
Number		1	1	1	1	1	1	1
Start-up type		Direct	Direct	Direct	Direct	Direct	Direct	Direct

### Evaporator

Type		Plate type						
Number		1	1	1	1	1	1	1
Minimum water content	l	0.7	1.1	1.1	1.7	1.7	2.2	2.2

### Condenser

Type		Plate type						
Number		1	1	1	1	1	1	1
Minimum water content	l	0.7	1.1	1.1	1.7	1.7	2.2	2.2

### Evaporator Hydraulic connections

Type		Gas threaded female type						
Inlet diameter	inch	1" 1/4	1" 1/4	1" 1/4	1" 1/4	1" 1/4	1" 1/4	1" 1/4
Outlet diameter	inch	1" 1/4	1" 1/4	1" 1/4	1" 1/4	1" 1/4	1" 1/4	1" 1/4

### Condenser Hydraulic connections

Type		Gas threaded female type						
Inlet diameter	inch	1" 1/4	1" 1/4	1" 1/4	1" 1/4	1" 1/4	1" 1/4	1" 1/4
Outlet diameter	inch	1" 1/4	1" 1/4	1" 1/4	1" 1/4	1" 1/4	1" 1/4	1" 1/4

### Weights

Shipping weights	kg	127	130	137	151	204	216	222
Operating weights	kg	128	132	139	154	207	220	226

### Dimensions

Length	mm	800	800	800	800	900	900	900
Height	mm	910	910	910	910	910	910	910
Width	mm	600	600	600	600	700	700	700

(1) With R22, on demand, for extra-European countries.

(2) Indicative value. Always refer to the value specified on the unit's label.

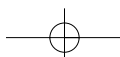

## Technical data

<b>CWP-HP</b>		<b>15</b>	<b>18</b>	<b>21</b>	<b>25</b>	<b>30</b>	<b>35</b>
Power supply	V/ph/Hz	400/3/50					
Number of circuits		1	1	1	1	1	1
Number of steps		1	1	1	2	2	2
<b>Refrigerant</b>							
Type (1)		R407C					
Charge (2)	kg	8.5	9.36	15	16	17	19
<b>Compressors</b>							
Type		Scroll	Scroll	Scroll	Scroll	Scroll	Scroll
Number		1	1	1	2	2	2
Start-up type		Direct	Direct	Direct	Direct	Direct	Direct
<b>Evaporator</b>							
Type		Plate type					
Number		1	1	1	1	1	1
Minimum water content	l	2.8	4.4	5.3	6.9	8.6	10.9
<b>Condenser</b>							
Type		Plate type					
Number		1	1	1	1	1	1
Minimum water content	l	2.8	4.4	5.3	6.9	8.6	10.9
<b>Evaporator Hydraulic connections</b>							
Type		Gas threaded female type					
Inlet diameter	inch	1" 1/2	1" 1/4	1" 1/4	2"	2"	2"
Outlet diameter	inch	1" 1/2	1" 1/4	1" 1/4	2"	2"	2"
<b>Condenser Hydraulic connections</b>							
Type		Gas threaded female type					
Inlet diameter	inch	1" 1/2	1" 1/4	1" 1/4	2"	2"	2"
Outlet diameter	inch	1" 1/2	1" 1/4	1" 1/4	2"	2"	2"
<b>Weights</b>							
Shipping weights	kg	298	324	337	538	571	604
Operating weights	kg	302	319	331	530	560	590
<b>Dimensions</b>							
Length	mm	1100	1100	1100	1700	1700	1700
Height	mm	1100	1100	1100	1200	1200	1200
Width	mm	850	850	850	984	984	984

(1) With R22, on demand, for extra-European countries.

(2) Indicative value. Always refer to the value specified on the unit's label.

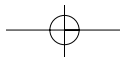

## Technical data

CWP-RC		02	03	04	05	06	07	09
Power supply	V/ph/Hz	400/3/50						
Number of circuits		1	1	1	1	1	1	1
Number of steps		1	1	1	1	1	1	1

### Compressor

Type		Scroll	Scroll	Scroll	Scroll	Scroll	Scroll	Scroll
Number		1	1	1	1	1	1	1
Start-up type		Direct	Direct	Direct	Direct	Direct	Direct	Direct

### Evaporator

Type		Plate type						
Number		1	1	1	1	1	1	1
Minimum water content	l	0.7	1.1	1.1	1.7	1.7	2.2	2.2

### Evaporator Hydraulic connections

Type		Gas threaded female type						
Inlet diameter	inch	1" 1/4	1" 1/4	1" 1/4	1" 1/4	1" 1/4	1" 1/4	1" 1/4
Outlet diameter	inch	1" 1/4	1" 1/4	1" 1/4	1" 1/4	1" 1/4	1" 1/4	1" 1/4

### Weights

Shipping weights	kg	114	119	131	179	188	193	261
------------------	----	-----	-----	-----	-----	-----	-----	-----

### Dimensions

Length	mm	800	800	800	800	900	900	900
Height	mm	910	910	910	910	910	910	910
Width	mm	600	600	600	600	700	700	700

CWP-RC		15	18	21	25	30	35	
Power supply	V/ph/Hz	400/3/50						
Number of circuits		1	1	1	1	1	1	
Number of steps		1	1	1	2	2	2	

### Compressors

Type		Scroll	Scroll	Scroll	Scroll	Scroll	Scroll
Number		1	1	1	2	2	2
Start-up type		Direct	Direct	Direct	Direct	Direct	Direct

### Evaporator

Type		Plate type						
Number		1	1	1	1	1	1	
Minimum water content	l	2.8	4.4	5.3	6.9	8.6	10.9	

### Evaporator Hydraulic connections

Type		Gas threaded female type						
Inlet diameter	inch	1" 1/2	1" 1/2	1" 1/2	2"	2"	2"	
Outlet diameter	inch	1" 1/2	1" 1/2	1" 1/2	2"	2"	2"	

### Weights

Shipping weights	kg	275	279	290	471	497	520
------------------	----	-----	-----	-----	-----	-----	-----

### Dimensions

Length	mm	1100	1100	1100	1700	1700	1700
Height	mm	1100	1100	1100	1200	1200	1200
Width	mm	850	850	850	984	984	984

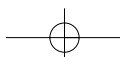



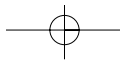

## Technical data

---

### 8.3 Electrical data

CWP/CWP-HP/CWP RC		02	03	04	05	06	07	09
Nominal voltage	V(%) / ph/Hz	400 ± 10% / 3 / 50						
Max power input	kW	2.3	2.7	6.4	7.4	8.9	12.2	15.1
Max. current (FLA)	A	17.3	6.5	12.0	13.0	15.1	20.7	26.0
Max. start-up current (LRA)	A	76	46	66	74	99	127	168

CWP/CWP-HP/CWP RC		15	18	21	25	30	35
Nominal voltage	V(%) / ph/Hz	400 ± 10% / 3 / 50					
Max power input	kW	16.4	24.2	28.1	32.9	44.5	56.2
Max. current (FLA)	A	27.8	41.0	48.0	55.6	75.3	95.0
Max. start-up current (LRA)	A	198	225	272	226	300	320

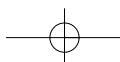

## Technical data

### 8.4 Overall dimensions

#### CWP / CWP-HP / CWP-RC (02 to 15)

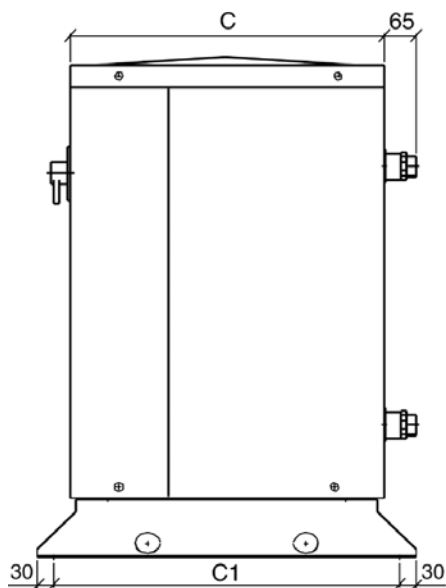

Side view

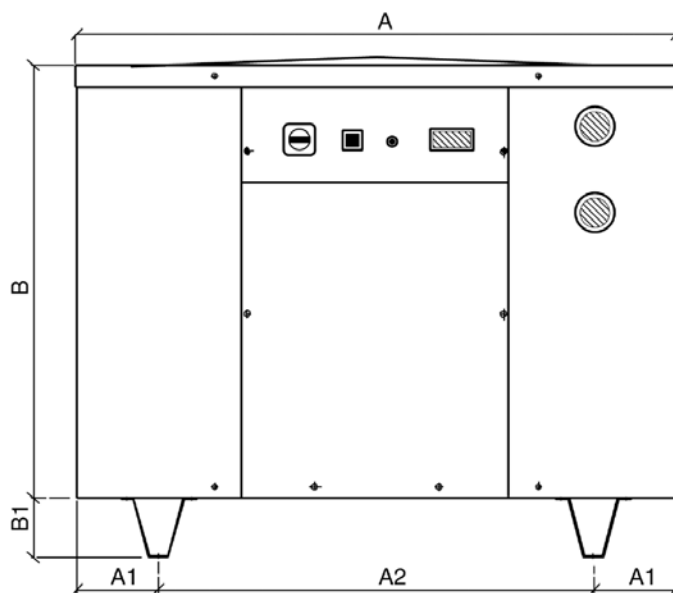

Front view

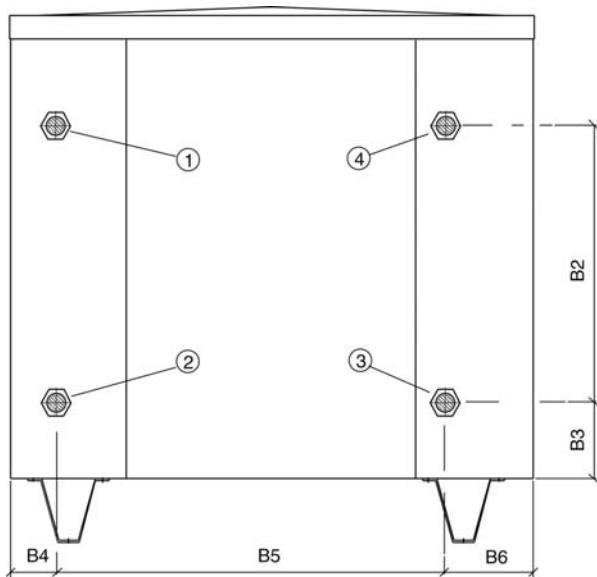

Rear view

- ① **Evaporator inlet:**  
1" 1/4 female (sizes 02 to 09)  
1" 1/2 female (sizes 15)
- ② **Evaporator outlet:**  
1" 1/4 female (sizes 02 to 09)  
1" 1/2 female (sizes 15)
- ③ **Condenser inlet:**  
1" 1/4 female (sizes 02 to 09)  
1" 1/2 female (sizes 15)
- ④ **Condenser outlet:**  
1" 1/4 female (sizes 02 to 09)  
1" 1/2 female (sizes 15)
- ① **Water return from installation**
- ② **Water leaving to installation**
- ③ **External source water outlet**
- ④ **External source water inlet**

Unit size	A	A1	A2	B	B1	B2	B3	B4	B5	B6	C	C1
02 to 05	800	75	650	900	110	478	135	80	567	153	480	540
06 to 09	900	100	700	900	110	478	135	80	667	153	580	640
15	1100	150	800	1000	110	518	145	100	800	200	730	790

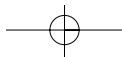

## Technical data

### CWP / CWP-HP / CWP-RC (18 - 21)

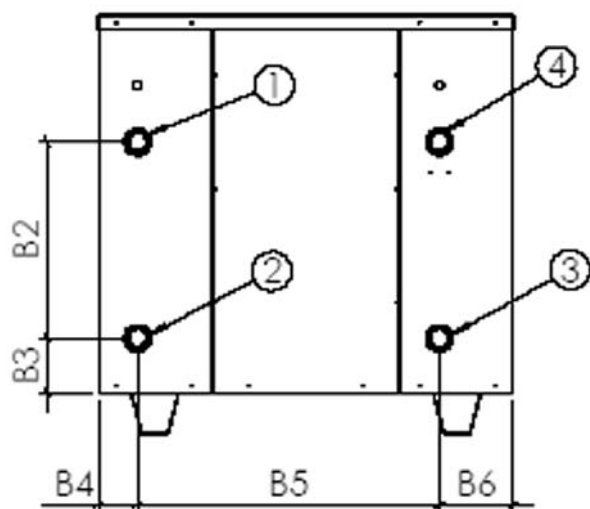

Rear view

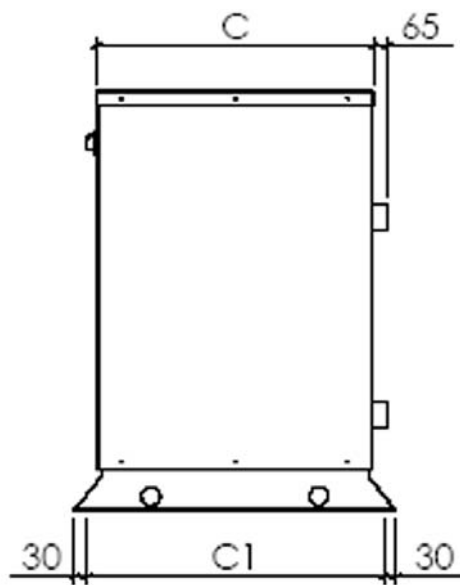

Side view

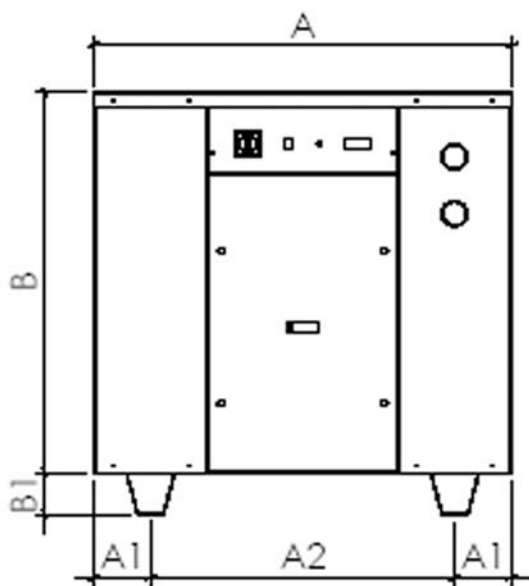

Front view

#### For CWP / CWP-HP

- ① Evaporator inlet: 1"1/4 female
- ② Evaporator outlet: 1"1/4 female
- ③ Condenser inlet: 1"1/4 female
- ④ Condenser outlet: 1"1/4 female

#### For CWP-RC

- ① Evaporator inlet: 1"1/4 female
- ② Evaporator outlet: 1"1/4 female
- ③ Discharge line: 1"1/8
- ④ Liquid line: 7/8"

Unit Size	A	A1	A2	B	B1	B2	B3	B4	B5	B6	C	C1
18-21	1100	150	800	1000	110	518	145	100	800	200	730	790

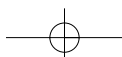

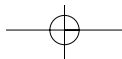

## Technical data

### CWP / CWP-HP / CWP-RC (25 to 35)

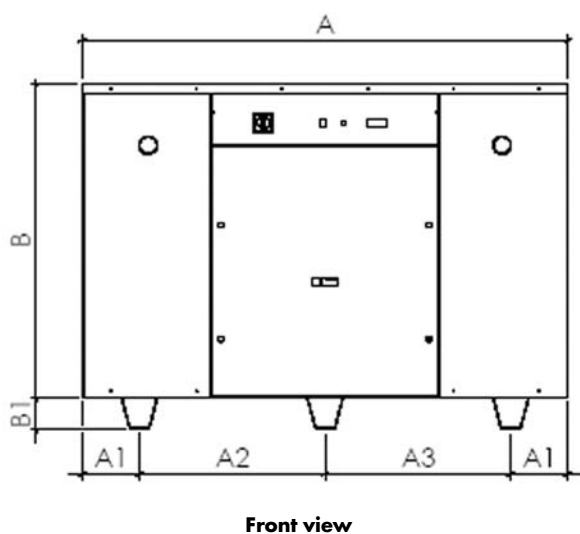
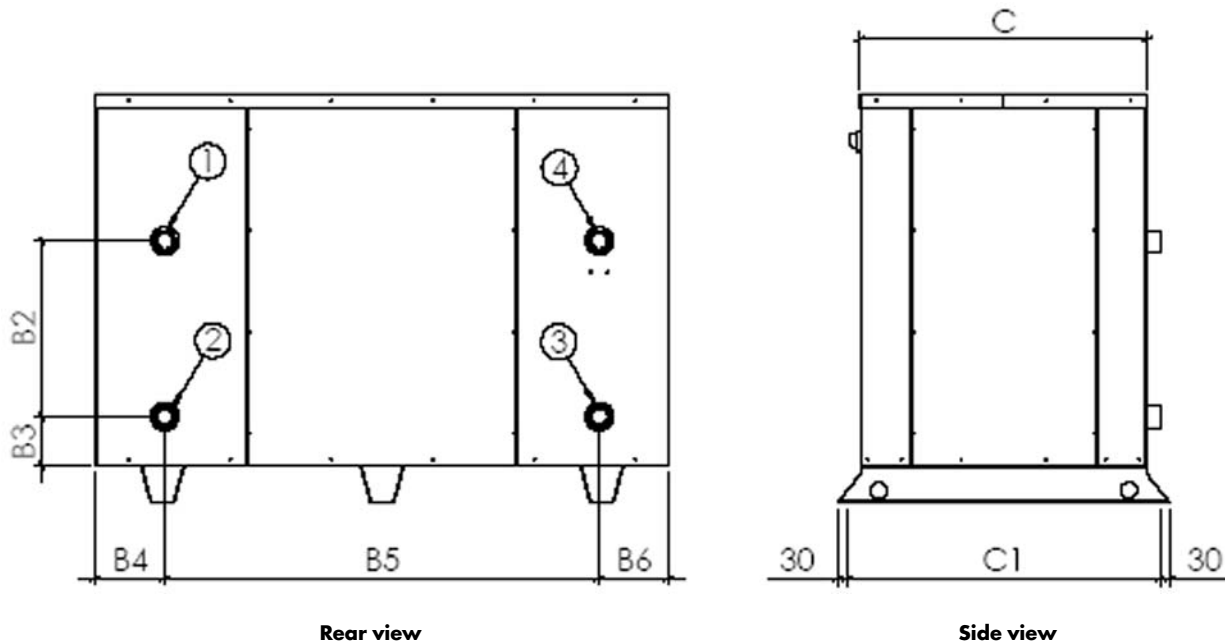

#### For CWP / CWP-HP

- ① Evaporator inlet: 2" female
- ② Evaporator outlet: 2" female
- ③ Condenser inlet: 2" female
- ④ Condenser outlet: 2" female

#### For CWP-RC

- ① Evaporator inlet: 2" female
- ② Evaporator outlet: 2" female
- ③ Discharge line: 1"5/8
- ④ Liquid line: 1"1/8

Unit Size	A	A1	A2	A3	B	B1	B2	B3	B4	B5	B6	C	C1
25 to 35	1700	200	650	650	1100	110	518	145	206	1288	206	850	924

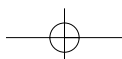

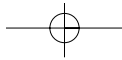

## Technical data

---

### 8.5 Service Spaces

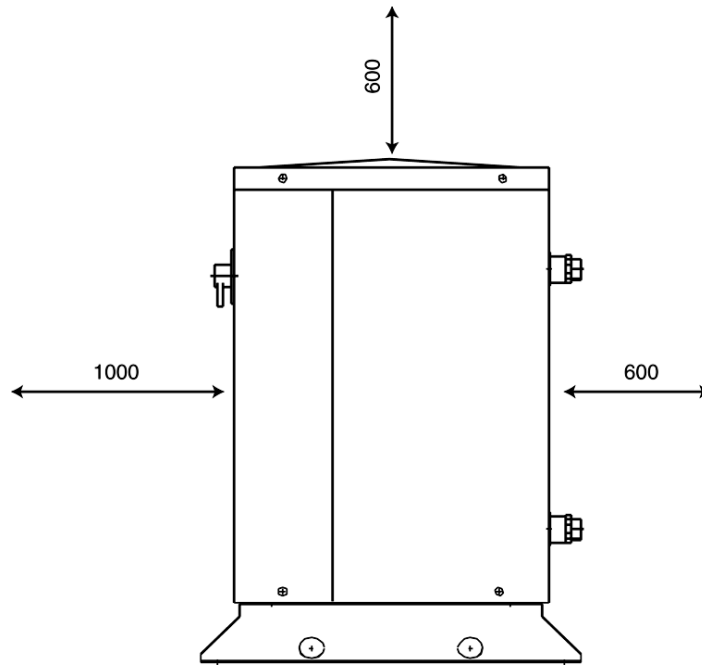

Side view

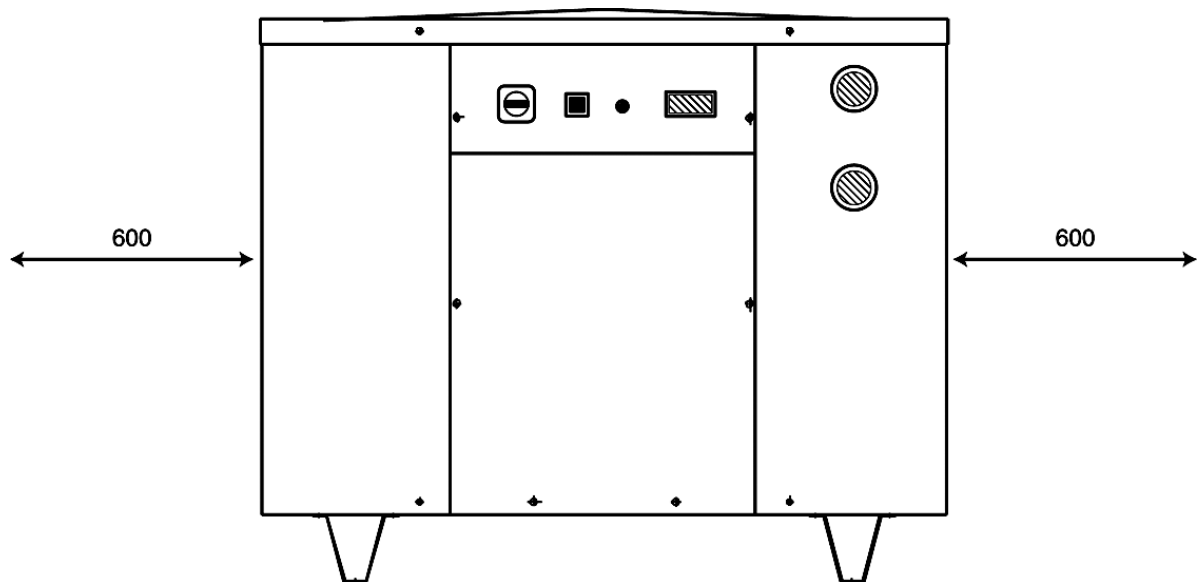

Front view

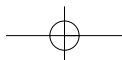

# Maintenance

## 9 MAINTENANCE

Carefully read the "Safety" section of this manual before carrying out any maintenance operations.



**Do not discharge the refrigerant into the atmosphere while the refrigeration circuits are being drained. Use appropriate recovery equipment. When the recovered refrigerant cannot be re-used, return it to the manufacturer.**



**Do not throw away the waste oil of the compressor, because it contains refrigerant in solution. The waste oil must be returned to the manufacturer.**

Unless otherwise specified, the operations described below may be carried out only by a trained maintenance operator.

### 9.1 General requirements

Itelco-Clima units have been designed for continuous operation, providing that they are subjected to regular maintenance, within the limits specified in this manual. Each unit must be serviced according to the programme by the User/Customer, and must be inspected at regular intervals by the personnel of one of Itelco-Clima's authorised Service Centers.

It is the responsibility of the User to meet these maintenance requirements and/or to enter into an agreement with one of Itelco-Clima's Service Centers, so as to properly safeguard the operation of the appliance.

During the warranty period, in case of damage or failures caused by improper maintenance, Itelco-Clima will not refund the costs incurred to repair the appliance in its original state.

The provisions of this section apply only to standard units; according to the order requirements, other documentation may be added, concerning any modifications or supplementary accessories.

### 9.2 Planned maintenance

Maintenance inspections must be carried out according to the program below, by a qualified person. As a general rule, units cannot be repaired directly by the user, who shall not try to service or repair any failures or anomalies identified during daily inspections. If you are in doubt, please contact Itelco-Clima Service Centre.

### Scheduled Maintenance

Operations	Daily	Weekly	Monthly	Beginning of season	End of season
Check the temperature of the leaving fluid	●				
Check the pressure drops in the heat exchanger		●			
Check for electric absorption		●			
Check suction pressure and temperature		●			
Check delivery pressure and temperature		●			
Check the oil level in the compressor		●			
Check that there are no gas bubbles in the liquid line		●			
Check that the fins of the external coil are clean (if any)			●		
Check the operation of the oil heaters			●		
Check the remote control switches			●		
Check the operation of the LP pressure switch				●	
Check the operation of the HP pressure switch				●	
Check the insulation of the heat exchanger				●	
Check that terminals are tightened				●	
Check that the terminals screws are tightened				●	
Clean the exterior of the unit with water and soap				●	
Check the density of the antifreeze (if any)				●	●
Check the operation of the flow switches				●	
Check the operation of the solenoid valve				●	●

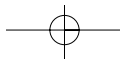

## Maintenance

### 9.3 Refrigerant charge



Do not inject refrigerant liquid into the LP side of the circuit. Be very careful, and charge the circuit properly. If the charge is insufficient, the efficiency of the unit will be lower than expected. In the worst of cases the LP pressure switch may be activated, resulting in the halting of the unit.

In the presence of an excess charge, the condensing pressure will rise (in the worst of cases, the HP pressure switch may be activated, resulting in the stop of the equipment), and the consumption will increase as well.



It is strictly forbidden to use the compressor as a vacuum pump to drain the plant.

Fill the refrigeration circuit after it has been drained for maintenance purposes (leaks, replacement of the compressor etc.). The amount of the charge is indicated on the plate affixed to the unit.

Before refilling, it is important to drain and dehydrate the circuit, thus obtaining a minimum abs. pressure value of 50 Pa.

Inject the refrigerant fluid before removing the vacuum, then fill the circuit up to 90% of the total gas requirement (in liquid form). The appliance must be filled through the filling valve on the liquid line.

It is recommended to connect the refrigerant cylinder to the filling valve on the liquid line, and to arrange it in such a way as to inject only liquid refrigerant.

Then start the compressor and let the gas flow from the cylinder, up until the liquid flow, which can be observed through the sight glass, is limpid.

### 9.4 Compressor

Compressors are delivered with the necessary charge of lubricating oil. During normal operation, this charge is sufficient for the whole life of the unit, providing that the efficiency of the refrigeration circuit is satisfactory and if it has not been overhauled.

If the compressor needs to be replaced (following a mechanical failure or if burnt), contact one of Itelco-Clima's Service Centers.



Compressors use polyester oil. During maintenance operations on the compressor, or if you have to open the refrigerant circuit in any point, remember that this type of oil is highly hygroscopic, and accordingly it is important that it is not left exposed to the weather for prolonged periods, as this would require the replacement of the oil. In a few cases, the polyester oil may be present also in R22 units (a refrigerant that can be used also in extra UE countries).

### 9.5 Condenser

Check the condenser water side for cleanliness at regular intervals. This may be accomplished by checking water side pressure drop (refer to Section 9). Soiling of the condenser results in increased condensing pressure, which reduces efficiency and increases current consumption and may cause the high pressure switch to activate.

It is advisable to supply the condensers with antialgae and anti-line treated water

If soiled, the heat exchanger must be chemically cleaned by Authorised service personnel.

For other types of service (special maintenance, heat exchanger replacement, etc.), contact an Authorised Service Centre).

### 9.6 Dehydrating filter

The refrigeration circuits are provided with dehydrating filters.

The filter clogging is marked by the presence of air bubbles in the sight glass, or by the difference between the temperatures measured downstream from and upstream of the filter. If, once the cartridge has been cleaned, there are still some air bubbles, the appliance has lost a part of the refrigerant charge in one or more points, that must be identified and serviced.

### 9.7 Sight glass

The sight glass is used for inspecting the refrigerant flow and the humidity % of the refrigerant. The presence of bubbles indicates that the dehydrating filter is clogged or the charge insufficient.

A colour indicator is positioned inside the sight glass.

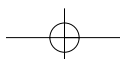



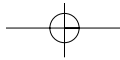

## Maintenance

---

If you compare the colour of the indicator to the scale on the ring of the sight glass, you can calculate the percentage of humidity of the refrigerant. If it is excessive, replace the filter's cartridge, operate the appliance for 1 day and then check the humidity % again. When the humidity % is within the pre-determined range, no other operations are required. If the humidity % is still too high, replace the dehydrating filter again, start the unit and operate it for another day.

In this case, the heat exchanger must be subjected to chemical cleaning, an operation that shall be carried out by authorised engineers.

For other maintenance operations (extraordinary overhauling, replacement of the heat exchanger etc.), contact an authorised Service Centre.

### 9.8 Thermostatic expansion valve

The circuit of the unit is equipped with a thermostatic expansion valve, with external equalizer. The valve is shop-calibrated for an overheating of 5°C.

Procedure to check for overheating:

- Measure the suction pressure with the pressure gauges on the board of the unit or using a pressure gauge connected to the service valve on the suction side.
- From the pressure gauge's temperature scale, measure the saturated suction temperature (T<sub>sa</sub>) which corresponds to the pressure value.
- Using a contact pressure gauge affixed to the outlet fitting of the gas of the evaporator, measure the actual temperature (T<sub>se</sub>).

Overheating calculation (S):

$$S = T_{se} - T_{sa}$$

Overheating is regulated through the thermostatic expansion valve.

Make the adjusting screw follow a complete turn, and operate the appliance for five minutes. Check again and, if necessary, repeat the regulation.

If the expansion valve cannot be regulated, it is probably broken, and shall be replaced. The replacement must be carried out by a Service Centre.

### 9.9 Evaporator

Check at regular intervals that the water side of the heat exchanger is perfectly clean. To do this, measure the pressure drop, water side (see Section 8) or measure the temperature of the liquid leaving and entering the heat exchanger, and compare it to the evaporation temperature.

To obtain an effective heat exchange, the difference between the temperature of the leaving water and the saturated evaporating temperature must be in the 3.5-5°C to R407C. A greater difference would indicate a low efficiency of the heat exchanger (i.e. the heat exchanger is dirty).

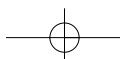

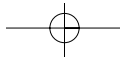

## Troubleshooting

### 10 TROUBLESHOOTING

The table below lists the anomalies of operation of the unit, the relevant causes and the corrective measures. For anomalies of any other type or not listed, contact one of Itelco-Clima's Service Centre for technical assistance.

Anomaly	Cause	Operation
The unit continues to work, but without cooling.	Insufficient charge of refrigerant.	Refill.
	The dehydrating filter is clogged.	Replace.
Ice on the suction line.	Wrong calibration of overheating.	Increase overheating.
		Check the charge.
Excessive noise.	Vibration of lines.	Check the clamping brackets, if any.
	Whistler emitted by the thermostatic expansion valve.	Refill.
		Check the dehydrating filter.
Noisy compressor.		Seized bearings; replace the compressor.
		Check that the compressor's locknuts are tightened.
Low oil level in the compressor.	One or more gas or oil leaks in the circuit.	Identify and remove leaks.
	Mechanical failure of the compressor.	Request the intervention of a Service Centre.
	Anomaly of the oil heater of the compressor's base.	Check the electric circuit and the resistor of the heater of the motor base, and replace defective components.

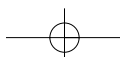

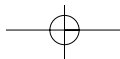

## Troubleshooting

Anomaly	Cause	Operation
One or both compressors are not working.	Breaking of the electric circuit.	Check the electric circuit and detect any ground dispersions and short circuits. Check fuses.
	Intervention of the HP pressure switch.	Reset the pressure switch and the control panel and restart the appliance. Identify and remove the cause that enabled the pressure switch.
	The fuse of the control circuit is broken.	Check for ground dispersions and short circuits. Replace fuses.
	Loosened terminals.	Check and tighten.
	Halt caused by thermal overload of the electric circuit.	Check the operation of check and safety devices. Identify and remove the cause.
	Wrong wiring.	Check wiring of check and safety devices.
	The line voltage is too low.	Check voltage. If problems regard the system, solve them. If they are caused by the distribution network, inform the Energy Distributor.
	Short-circuit of the compressor's motor.	Check the continuity of the winding.
	Seized compressor.	Replace the compressor.
Activation of the LP alarm, stop of the unit.	Gas leak.	Identify and remove the leak.
	Insufficient charge	Refill.
	Failure of the pressure switch.	Replace the pressure switch.
Activation of the HP alarm, stop of the unit.	Failure of the pressure switch.	Check the operation of the pressure switch, replace it if defective.
	The delivery valve is partially closed.	Open the valve and replace it, if faulty.
	Substances with condensable gases in the circuit.	Drain the circuit.
The liquid line is too hot.	Insufficient charge.	Identify and remove the cause of the loss of charge and refill.
Frosting of the liquid line.	The valve of the liquid line is partially closed.	Check that valves are open.
	The liquid filter is clogged.	Replace the cartridge or the filter.

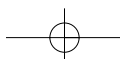

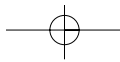

## Spare parts

---

### 11 SPARE PARTS

#### 11.1 Spare part list

The table below shows the list of spare parts recommended during the first two years of operation.

Component	Number
HP pressure switch	1
LP pressure switch	1
Gas filter	2
Thermostatic valve	2
Auxiliary relays	2
Compressor's fuses	12
Auxiliary fuses	6
Set of compressor contactors	1
Water sensor	1
Electronic card	1
Keyboard	1
Compressor oil resistor	1

#### 11.2 Oil for compressors

The compressors are lubricated with polyester oil (P.O.E.).

#### 11.3 Wiring diagrams

The wiring diagrams are installed inside the doors of the electrical panels of the unit. Any request for wiring diagrams shall be forwarded to Itelco-Clima's Service Centre.

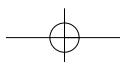

## Dismantling, Demolition and Scrapping

### 12 DISMANTLING, DEMOLITION AND SCRAPPING



**During the draining of the refrigeration circuits, do not let the refrigerant overflow in the surrounding atmosphere. The circuit must be drained using suitable recovery equipment.**



**Do not disperse the waste oil of the compressors in the environment, since it contains some dissolved refrigerant.**

**For the disposal, contact the competent authority for information.**

Unless otherwise specified, the maintenance operations listed below may be carried out by any trained maintenance operator.

#### 12.1 Generalities

Open each line that supplies the unit, including the ones of control circuits. Make sure that all disconnecting switches are secured in the off position. The power cables can be disconnected and disassembled. Refer to Chapter 4 for the position of connection points.

Remove all the refrigerant from the refrigeration circuits of the unit and store it in suitable containers, using a recovery unit. If its characteristics have remained the same, the refrigerant can be used again. Contact the competent authority to obtain information about disposal. In **NO** event shall the refrigerant be discharged into the atmosphere. The oil in each refrigeration circuit must be drained and collected into a suitable container; then it shall be disposed of in conformity with local regulations that apply to the disposal of waste lubricants. Any oil spillage must be recovered and disposed of in like manner.

Isolate the unit's heat exchangers from the external hydraulic circuits and drain the heat exchange sections of the plant.



**If no shutoff valves have been provided, it may be necessary to drain the whole plant. If a glycoled solution or a similar fluid has been used in the hydraulic circuits, or if chemical additives have been added to the circulating water, the circulating fluid MUST be drained in a proper way. For NO reason shall a circuit containing glycoled water or a similar solution be discharged directly into the drains or surface waters.**

After draining operations, the piping of the hydraulic networks can be disconnected and disassembled.

Once they have been disconnected as specified, the packaged units can be disassembled in a single piece. First of all, disassemble the anchoring screws and then lift the unit from the position of installation, and hook it to the lifting points provided, using suitable lifting equipment.

To this end, refer to Chapter 4 for the installation of these appliances, to Chapter 8 for their weights and Chapter 3 for handling.

The units that, once disconnected, cannot be removed in a single piece, must be dismantled on site; in this case, be very careful with the weight and handling of every single component.

It is always advisable to dismantle the units following the installation steps, but in reverse.



**Some residues of oil, glycoled water or similar solutions may remain in certain parts of the unit. These residues must be recovered and disposed of according to the procedures specified above.**

It is very important to ensure that, while a component of the unit is being removed, all the others are properly supported.



**Use only lifting means of adequate capacity.**

Once disassembled, the components of the unit can be disposed of in conformity with current regulations.

**Itelco Industry**

Via XXV Aprile, 29  
20030 Barlassina (MI) - Italy

☎ : +39 0362 6801

☎ : +39 0362 680281

[www.itelco-clima.com](http://www.itelco-clima.com)

---

*As part of our ongoing product improvement programme, our products are subject to change without prior notice. Non contractual photos.*

*Dans un souci d'amélioration constante, nos produits peuvent être modifiés sans préavis. Photos non contractuelles.*

Your distributor / Votre agent commercial :

