



CLS/CLC/CLH 182 ÷ 602



English



41
↓
140 kW



46
↓
152 kW



Air cooled water chillers, air cooled condensing units and air-to-water reverse cycle heat pumps

IOM CLSCH-N.1GB
Date : **November 2005**
Supersedes : **None**



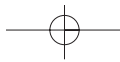
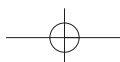

Table of contents

Table of contents

1 FOREWORD		5 START-UP	
1.1 Introduction	3	5.1 Preliminary check	19
1.2 Warranty	3	5.2 Start-up	19
1.3 Emergency stop/Normal stop	3	5.3 Checking the operation	20
1.4 An introduction to this manual	3	5.4 Delivery to the customer	20
2 SAFETY		6 CONTROL	
2.1 Foreword	4	6.1 General information	21
2.2 Definitions	4	6.2 Control system	21
2.3 Access to the unit	5	6.3 Display	22
2.4 General precautions	5	6.4 Start-up	23
2.5 Precautions against residual risks	5	6.5 Switching the working temperature	23
2.6 Precautions during maintenance operations	6	6.6 Main alarms	24
2.7 Safety labels	7	7 GENERAL DESCRIPTION	
2.8 Safety regulations	9	7.1 Introduction	25
3 TRANSPORT, LIFTING AND POSITIONING		7.2 General specifications	25
3.1 Inspection	12	7.3 Compressors	25
3.2 Lifting	12	7.4 Refrigeration circuits	25
3.3 Anchoring	13	7.5 Water-type heat exchanger	26
3.4 Storage	13	7.6 Air-type heat exchanger	26
4 INSTALLATION		7.7 Fans	26
4.1 Positioning of the unit	14	7.8 Power supply and control system	28
4.2 Installation of Spring Shock Absorbers	14	7.9 Accessories	28
4.3 External hydraulic circuit	15	8 TECHNICAL DATA	
4.4 Hydraulic connection	16	8.1 Pressure drops in the evaporator	29
4.5 Draining the Defrosting Waste Water (for heat pump unit only)	16	8.2 Technical Data	30
4.6 Power supply	16	8.3 Electrical data	50
4.7 Electrical connections	17	8.4 Position of shock absorbers and weight distribution on supports	62
		8.5 Overall dimensions	69
		8.6 Service spaces	74



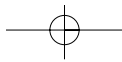

Table of contents

9 MAINTENANCE

9.1 General requirements	75
9.2 Planned maintenance	75
9.3 Refrigerant charge	76
9.4 Compressor	76
9.5 Condenser	76
9.6 Fans	76
9.7 Dehydrating filter	77
9.8 Sight glass	77
9.9 Thermostatic expansion valve	77
9.10 Evaporator	77

10 TROUBLESHOOTING

11 SPARE PARTS

11.1 Spare parts list	80
11.2 Oil for compressors	80
11.3 Wiring diagram	80

12 DISMANTLING, DEMOLITION AND SCRAPPING

12.1 Generalities	81
-------------------	----

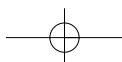

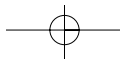

Foreword

1 FOREWORD

1.1 Introduction

Itelco-Clima units, manufactured to state-of-the-art design and implementation standards, ensure top performance, reliability and fitness to any type of air-conditioning systems.

These units are designed for cooling water or glycoled water (and for water heating in heat pump models) and are unfit for any purposes other than those specified in this manual.

This manual includes all the information required for a proper installation of the units, as well as the relevant operating and maintenance instructions.

It is therefore recommended to read this manual carefully before installation or any operation on the machine. The chiller installation and maintenance must be carried out by skilled personnel only (where possible, by one of Itelco-Clima's Authorised Service Centers).

The manufacturer may not be held liable for any damage to people or property caused by improper installation, start-up and/or improper use of the unit and/or failure to implement the procedures and instructions included in this manual.

1.2 Warranty

These units are delivered complete, tested and ready for being operated. Any form of warranty will become null and void in the event that the appliance is modified without Itelco-Clima's preliminary written authorisation.

This warranty shall apply providing that the installation instructions have been complied with (either issued by Itelco-Clima, or deriving from the current practice), and the Form 1 ("Start-up") has been filled-in and mailed to Itelco-Clima (attn. After-Sales Service).

In order for this warranty to be valid, the following conditions shall be met:

- The machine must be operated only by skilled personnel from Itelco-Clima's Authorised After-Sales Service.
- Maintenance must be performed only by skilled personnel - from one of Itelco-Clima's Authorised After-Sales Centers.
- Use only original Itelco-Clima spare parts.
- Carry out all the planned maintenance provided for by this manual in a timely and proper way.

Failure to comply with any of these conditions will automatically void the warranty.

1.3 Emergency stop / Normal stop

The emergency stop of the unit can be enabled using the master switch on the control panel (move down the lever).

For a normal stop, press the relevant push-buttons.

To restart the appliance, follow the procedure detailed in this manual.

1.4 An introduction to the manual

For safety reasons, it is imperative to follow the instructions given in this manual. In case of any damage caused by non-compliance with these instructions, the warranty will immediately become null and void.

Conventions used throughout the manual:



The Danger sign recalls your attention to a certain procedure or practice which, if not followed, may result in serious damage to people and property.



The Warning sign precedes those procedures that, if not followed, may result in serious damage to the appliance.



The Notes contain important observations.



The Useful Tips provide valuable information that optimises the efficiency of the appliance.

This manual and its contents, as well as the documentation which accompanies the unit, are and remain the property of Itelco-Clima, which reserves any and all rights thereon. This manual may not be copied, in whole or in part, without Itelco-Clima's written authorization.

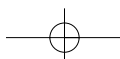

Safety

2 SAFETY

2.1 Foreword

These units must be installed in conformity with the provisions of Machinery Directive 98/37/EC, Low Voltage Directive 73/23/EC, Pressure Vessels Directive 97/23/EC, Electromagnetic Interference Directive 89/336/EC, as well as with other regulations applicable in the country of installation. If these provisions are not complied with, the unit must not be operated.



The unit must be grounded, and no installation and/or maintenance operations may be carried out before deenergising the electrical panel of the unit.

Failure to respect the safety measures mentioned above may result in electrocution hazard and fire in the presence of any short-circuits.



Inside the heat exchangers, the compressors and the refrigeration lines, this unit contains liquid and gaseous refrigerant under pressure. The release of this refrigerant may be dangerous and cause injuries.



The units are not designed to be operated with natural refrigerants, such as hydrocarbons. Itelco-Clima may not be held liable for any problems deriving from the replacement of original refrigerant or the introduction of hydrocarbons.

Itelco-Clima units are designed and manufactured according to the requirements of European Standard PED 97/23/EC (pressure vessels).

- The used refrigerants are included in group II (non-hazardous fluids).
- The maximum working pressure values are mentioned on the unit's data plate.
- Suitable safety devices (pressure switches and safety valves) have been provided, to prevent any anomalous overpressure inside the plant.
- The vents of the safety valves are positioned and oriented in such a way as to reduce the risk of contact with the operator, in the event that the valve is operated. Anyway, the installer will convey the discharge of the valves far from the unit.
- Dedicated guards (removable panels with tools) and danger signs indicate the presence of hot pipes or components (high surface temperature).



The guards of the fans (only for units provided with air heat exchangers) must be always mounted and must never be removed before de-energising the appliance.



It is the User's responsibility to ensure that the unit is fit for the conditions of intended use and that both installation and maintenance are carried out by experienced personnel, capable of respecting all the recommendations provided by this manual. It is important that the unit is adequately supported, as detailed in this manual. Non-compliance with these recommendations may create hazardous situations for the personnel.



The unit must rest on a base which meets the characteristics specified in this manual; a base with inadequate characteristics is likely to become a source of serious injury to the personnel.



The unit has not been design to withstand loads and/or stress that may be transmitted by adjacent units, piping and/or structures. Each external load or stress transmitted to the unit may break or cause breakdowns in the unit's structure, as well as serious dangers to people. In these cases, any form of warranty will automatically become null and void.



The packaging material must not be disposed of in the surrounding environment or burnt.

2.2 Definitions

OWNER: means the legal representative of the company, body or individual who owns the plant where Itelco-Clima unit has been installed; he/she has the responsibility of making sure that all the safety regulations specified in this manual are complied with, along with the national laws in force.

INSTALLER: means the legal representative of the company who has been given by the owner the job of positioning and performing the hydraulic, electric and other connections of Itelco-Clima unit to the plant: he/she is responsible for handling and properly installing the appliance, as specified in this manual and according to the national regulations in force.

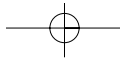

Safety

OPERATOR: means a person authorised by the owner to do on Itelco-Clima unit all the regulation and control operations expressly described in this manual, that must be strictly complied with, without exceeding the scope of the tasks entrusted to him.

ENGINEER: means a person authorised directly by Itelco-Clima or, in all EC countries, excluding Italy, under his full responsibility, by the distributor of Itelco-Clima product, to perform any routine and extraordinary maintenance operations, as well as any regulation, control, servicing operations and the replacement of pieces, as may be necessary during the life of the unit.

2.3 Access to the unit

The unit must be placed in an area which can be accessed also by OPERATORS and ENGINEERS; otherwise the unit must be surrounded by a fence at not less than 2 meters from the external surface of the machine.

OPERATORS and ENGINEERS must enter the fenced area only after wearing suitable clothing (safety shoes, gloves, helmet etc.). The INSTALLER personnel or any other visitor must always be accompanied by an OPERATOR.

For no reason shall any unauthorised personnel be left alone in contact with the unit.

2.4 General precautions

The OPERATOR must simply use the controls of the unit; he must not open any panel, other than the one providing access to the control module.

The INSTALLER must simply work on the connections between plant and machine; he must not open any panels of the machine and he must not enable any control.

When you approach or work on the unit, follow the precautions listed below:

- do not wear loose clothing or jewellery or any other accessory that may be caught in moving parts
- wear suitable personal protective equipment (gloves, goggles etc.) when you have to work in the presence of free flames (welding operations) or with compressed air
- if the unit is placed in a closed room, wear ear protection devices
- cut off connecting pipes, drain them in order to balance the pressure to the atmospheric value before disconnecting them, disassemble connections, filters, joints or other line items

- do not use your hands to check for any pressure drops
- use tools in a good state of repair; be sure to have understood the instructions before using them
- be sure to have removed all tools, electrical cables and any other objects before closing and starting the unit again

2.5 Precautions against residual risks

Prevention of residual risks caused by the control system

- be sure to have perfectly understood the operating instructions before carrying out any operation on the control panel
- when you have to work on the control panel, keep always the operating instructions within reach
- start the unit only after you have checked its perfect connection to the plant
- promptly inform the ENGINEER about any alarm involving the unit
- do not reset manual restoration alarms unless you have identified and removed their cause

Prevention of residual mechanical risks

- install the unit according to the instructions provided in this manual
- carry out all the periodical maintenance operations prescribed by this manual
- wear a protective helmet before accessing the interior of the unit
- before opening any panelling of the machine, make sure that it is secured to it by hinges
- do not touch air condensation coils without wearing protective gloves
- do not remove the guards from moving elements while the unit is running
- check the correct position of the moving elements' guards before restarting the unit

Prevention of residual electrical risks

- connect the unit to the mains according to the instructions provided in this manual
- periodically carry out all the maintenance operations specified by this manual
- disconnect the unit from the mains by the external disconnecting switch before opening the electrical board

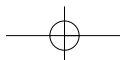

Safety

- check the proper grounding of the unit before start-up
 - check all the electrical connections, the connecting cables, and in particular the insulation; replace worn or damaged cables
 - periodically check the board's internal wiring
 - do not use cables having an inadequate section or flying connections, even for limited periods of time or in an emergency
 - place a warning sign "do not turn on - maintenance in progress" on the external disconnecting switch
 - make sure that on-off remote controls are inhibited
 - wear suitable personal protective equipment (helmet, safety gloves, goggles and shoes etc.)
- To carry out any measurements or checks which require the activation of the machine:

Prevention of other residual risks

- make sure that the connections to the unit conform to the instructions provided in this manual and on the unit's panelling
- if you have to disassemble a piece, make sure that it has been properly mounted again before restarting the unit
- do not touch the delivery pipes from the compressor, the compressor and any other piping or component inside the machine before wearing protective gloves
- keep a fire extinguisher for electrical appliances near the machine
- close the electrical board as soon as the measurement or check has been completed
- for outdoor units, do not carry out any operations in the presence of dangerous climatic conditions (rain, snow, mist etc.)

The following precautions must be always adopted:

- do not scatter the fluids of the refrigeration circuit in the surrounding environment
- when replacing an eprom or electronic cards, use always suitable devices (extractor, antistatic bracelet, etc.)
- do not scatter the fluids of the refrigeration circuit in the surrounding environment
- when replacing a compressor, the evaporator, the condensing coils or any other heavy element, make sure that the lifting equipment is consistent with the weight to be lifted
- in air units with independent compressor compartment, do not access the fan compartment unless you have disconnected the machine by the disconnecting switch on the board and you have placed a warning sign "do not turn on - maintenance in progress"
- contact Itelco-Clima for any modifications to the refrigeration, hydraulic or wiring diagram of the unit, as well as to its control logics
- contact Itelco-Clima if it is necessary to perform very difficult disassembly and assembly operations
- use only original spare parts purchased directly from Itelco-Clima or the official retailers of the companies on the recommended spare parts list
- contact Itelco-Clima if it is necessary to handle the unit one year after its positioning on site or if you wish to dismantle it.
- remove and leak of fluid inside and outside the unit
- collect the waste liquids and dry any oil spillage
- periodically clean the compressor compartment, to remove any fouling
- do not store flammable liquids near the unit
- do not disperse the refrigerant and the lubricating oil into the environment
- weld only empty pipes; do not approach flames or other sources of heat to refrigerant pipes
- do not bend/hit pipes containing fluids under pressure

2.6 Precautions during maintenance operations

Maintenance operations can be carried out by authorised technicians only.
Before performing any maintenance operations:

- disconnect the unit from the mains with the external disconnecting switch

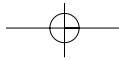

Safety

2.7 Safety plates

The labels below will be affixed to each unit in the indicated point:



Identification of the refrigerant - External door

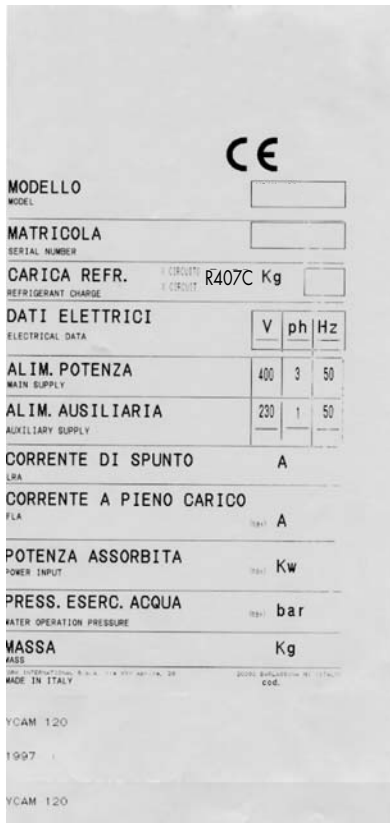

Identification of the unit - Outside, on the right-hand front column

**TENERE SU QUESTA LINEA
GANCIO DI SOLLEVAMENTO**



**KEEP LIFT HOOK
ON THIS LINE**
Gravity centre - Base

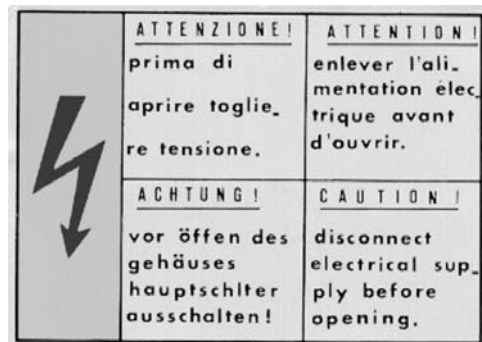

Electrical warning
Adjacent to the master switch

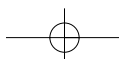

Safety

ATTENZIONE

INSERIRE LE RESISTENZE DI RISCALDAMENTO OLIO ALMENO 12 ORE PRIMA DI OGNI AVVIAMENTO (SE PREVISTE).

PRIMA DELLA MESSA IN TENSIONE ASSICURARSI CHE LE VITI DEI CIRCUITI ELETTRICI SIANO SERRATE COMPLETAMENTE.

WARNING

ENERGIZE THE CRANCKCASE HEATER FOR AT LEAST 12 HOURS BEFORE EACH STARTING (IF FITTED).

BEFORE TIGHTENING-UP, TO TIGHTEN ALL TERMINAL SCREWS ESPECIALLY THOSE IN MAIN CIRCUIT.

881000215/B

Start-up warning - Outside the door of the electrical board

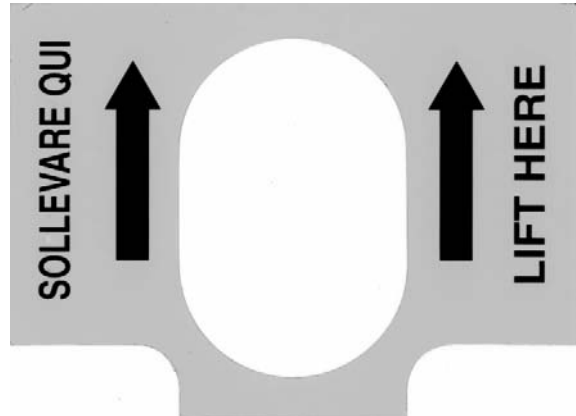

Lifting point - Base

CERTIFICATO DI COLLAUDO PRODUZIONE ITELCO-CLIMA
ITELCO-CLIMA PRODUCTION TEST CERTIFICATE
UNITA' ARIA-ARIA/ARIA-ACQUA - SEMICENTRALI - CHILLER AIR/AIR AIR/WATER

PROGR. COLL. NUMBER CHECK	DESCRIZIONE DEI TEST DESCRIPTION OF QUALITY CHECK	TIMERO OPERAT. INSP. CODE
01	VERIFICA ASSEMBLAGGIO VERIFY ASSEMBLY COMPLETE	
02	VERIFICA VISIVA CABLAGGIO COLLEG. ELETTRICI E CONNESSIONE VERIFY WIRING CONNECTIONS	
03	VUOTO E CARICA REF. VACUUM AND CHARGE TEST	
04	VERIFICA CON CERCAFUGHE TENUTA CIRCUITO FRIGORIFERO REFRIGERANT LEAK TEST	
05	PROVE FUNZIONALI CON RILIEVI TEMPERATURE/PRESSIONI-RUMORE FUNCTION AND RUN TEST NOISE TEST	
06	VERIFICA INTERVENTI SICUREZZE PRESSIONE E TEMPERATURA CHECK OPERATION AND SAFETY DEVICES	
07	VERIFICA TENUTA CIRCUITO IDR. E FUNZIONAMENTO POMPA (SU PACK) HYDRAULIC CIRCUIT TEST (PUMP CHECK ONLY FOR PACK UNIT)	
08	VERIFICA MONTAGGIO ACCESSORI (SE PREVISTI) E DOCUMENTAZIONE CHECK ACCESSORIES/DOCUMENTATION	
09	CONTROLLO ESTETICO FINALE E PULIZIA INTERNA VISUAL CHECK FOR DIRT AND DAMAGE	

Final Test Certificate - Inside the external door

EIN - INLET
ENTRÉE - ENTRATA
AUS - OUTLET
SORTIE - USCITA

Fitting identification - Adjacent to fittings



Grounding connection - On the electrical board, adjacent to the connection

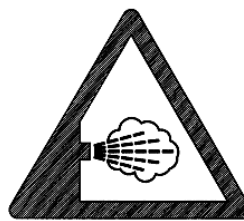

Warning - safety valves' vents



Warning - high-temperature zones Adjacent to hot pipes or components

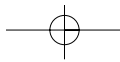

Safety

2.8 Safety regulations

Refrigerant data	Safety data: R407C, R134a
Toxicity	Low
Contact with skin	If sprayed, the refrigerant is likely to cause frost burns. If absorbed by the skin, the danger is very limited; it may cause a slight irritation, and the liquid is degreasing. Unfreeze the affected skin with water. Remove the contaminated clothes with great care - in the presence of frost burns, the clothes may stick to the skin. Wash with plenty of warm water the affected skin. In the presence of symptoms such as irritation or blisters, obtain medical attention.
Contact with eyes	Vapours do not cause harmful effects. The spraying of refrigerant may cause frost burns. Wash immediately with a proper solution or with tap water for at least 10 minutes, and then obtain medical attention.
Ingestion	Very unlikely - should something happen, it will cause frost burns. Do not induce vomiting. Only if the patient is conscious, wash out mouth with water and give some 250 ml of water to drink. Then, obtain medical attention.
Inhalation	R407C, R134a: remarkable concentrations in the air may have an anaesthetic effect, up to fainting. The exposure to considerable amounts may cause irregular heartbeat, up to the sudden death of the patient. Very high concentrations may result in the risk of asphyxia, due to the reduction in the oxygen percentage in the atmosphere. Remove the patient to fresh air and keep warm and at rest. If necessary, give oxygen. In case of breathing difficulties or arrest, proceed with artificial respiration. In case of cardiac arrest, proceed with cardiac massage. Then, obtain medical attention.
Recommendations	Semiotics or support therapy is recommended. Cardiac sensitisation has been observed that, in the presence of circulating catecholamines such as adrenalin, may cause cardiac arrhythmia and accordingly, in case of exposure to high concentrations, cardiac arrest.
Prolonged exposure	R407C, R134a: a study on the effects of exposure to 50,000 ppm during the whole life of rats has identified the development of benign testicle tumour. This situation should therefore be negligible for personnel exposed to concentrations equal to or lower than professional levels.
Professional levels	R407C, R134a: Recommended threshold: 1000 ppm v/v - 8 hours TWA.
Stability	R407C, R134a: Not specified
Conditions to avoid	Do not use in the presence of flames, burning surfaces and excess humidity.
Hazardous reactions	May react with sodium, potassium, barium and other alkaline metals. Incompatible substances: magnesium and alloys with magnesium concentrations > 2%.
Hazardous decomposition products	R407C, R134a: Halogen acids produced by thermal decomposition and hydrolysis.

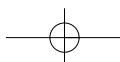

Safety

General precautions	Do not inhale concentrated vapours. Their concentration in the atmosphere should not exceed the minimum preset values and should be maintained below the professional threshold. Being more weighty than the air, the vapour concentrates on the bottom, in narrow areas. Therefore, the exhaust system must work at low level.
Respiratory system protection	If you are in doubt about the concentration in the atmosphere, it is recommended to wear a respirator approved by an accident-prevention Authority, of the independent or oxygen type.
Storage	Cylinders must be stored in a dry and fresh place, free from any fire hazard, far from direct sunlight or other sources of heat, radiators etc. Keep a temperature below 45°C.
Protective clothing	Wear overalls, protective gloves and goggles or a mask.
Accidental release measures	It is important to wear protective clothing and a respirator. Stop the source of the leak, if you can do this without danger. Negligible leaks can be left evaporating under the sun, providing that the room is well ventilated. Considerable leaks: ventilate the room. Reduce the leak with sand, earth or other absorbing substances. Make sure that the liquid does is not channelled into gutters, sewers or pits where the vapours are likely to create a stuffy atmosphere.
Disposal	The best method is recovery and recycling. If this method is not practicable, dispose according to an approved procedure, that shall ensure the absorption and neutralization of acids and toxic agents.
Fire fighting information	R407C, R134a: Not flammable in the atmosphere.
Cylinders	The cylinders, if exposed to fire, shall be cooled by water jets; otherwise, if heated, they may explode.
Protective fire fighting equipment	In case of fire, wear an independent respirator and protective clothing.

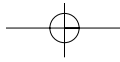

Safety

Refrigerant oil data	Safety data: Polyolester oil (POE)
Classification	Not harmful
Contact with skin	May cause slight irritation. Does not require first aid measures. It is recommended to follow usual personal hygiene measures, including washing the exposed skin with soap and water several times a day. It is also recommended to wash your overalls at least once a week.
Contact with eyes	Wash thoroughly with a suitable solution or tap water.
Ingestion	Seek medical advice immediately.
Inhalation	Seek medical advice immediately.
Conditions to avoid	Strong oxidising substances, caustic or acid solutions, excess heat. May corrode some types of paint or rubber.
Protection of the respiratory system	Use in well ventilated rooms.
Protective clothing	Always wear protective goggles or a mask. Wearing protective gloves is not mandatory, but is recommended in case of prolonged exposure to refrigerant oil.
Accidental release measures	It is important to wear protective clothing and, especially, goggles. Stop the source of the leak. Reduce the leak with absorbing substances (sand, sawdust or any other absorbing material available on the market).
Disposal	The refrigerant oil and its waste will be disposed of in an approved incinerator, in conformity with the provisions and the local regulations applicable to oil waste.
Fire fighting information	In the presence of hot liquid or flames, use dry powder, carbon dioxide or foam. If the leak is not burning, use a water jet to remove any vapours and to protect the personnel responsible for stopping the leak.
Cylinders	The cylinders exposed to a fire will be cooled with water jets in case of fire.
Fire fighting protective equipment	In case of fire, wear an independent respirator.

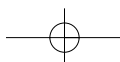

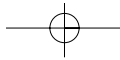

Transport, Lifting and Positioning

3 TRANSPORT, LIFTING AND POSITIONING

Refrigerators are supplied assembled (apart from standard antivibrating rubber supports, that will be installed on site). The equipment are full of refrigerant and oil (except to the condensing unit), in the quantity required for a proper operation.

3.1 Inspection

When the unit is delivered, it is recommended to check it carefully and to identify any damage occurred during transportation. The goods are shipped ex-factory, at the buyer's risk. Check that the delivery includes all the components listed in the order.

In case of damage, note it down on the carrier's delivery note and issue a claim according to the instructions provided in the delivery note.

In the presence of any serious damage, that does not affect the surface only, it is recommended to inform Itelco-Clima immediately.

Please note that Itelco-Clima may not be held liable for any damage to the equipment during transportation, even though the carrier has been appointed by the factory.

3.2 Lifting

The unit must be lifted with cables inserted in the eyebolts provided. It is recommended to use a spacer to prevent the cables from damaging the unit (see the figure).

Before positioning the unit, make sure that the place of installation is appropriate and sturdy enough to hold the weight and to withstand the stress caused by the operation of the whole assembly.



Do not displace the unit on rollers, and do not lift it with a lift truck.

To lift and displace the unit:

- Insert and secure eyebolts into the holes marked on the frame.
- Connect cables to eyebolts.
- Insert spacer between cables.

- Hook near the barycentre of the unit.
- The cables must be long enough to form, if tensioned, an angle of at least 45° with respect to the horizontal plane.

L = Depth

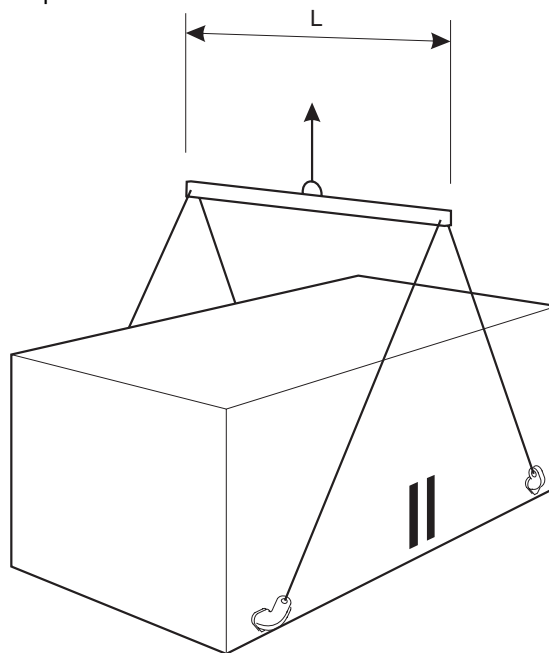

Eyebolts

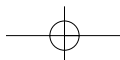
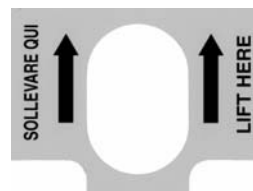
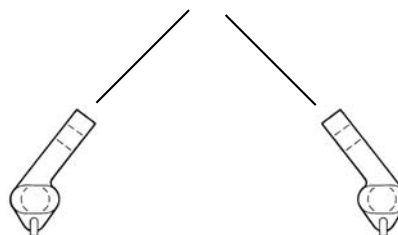

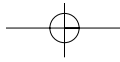

Transport, Lifting and Positioning



For lifting operations, use only tools and material fit for this purpose, in accordance with accident-prevention regulations.



During the lifting and handling of the unit, be careful not to damage the finned pack of the coils positioned on the sides of the unit. The sides of the unit must be protected by cardboard or plywood sheets.



It is recommended not to remove the protective plastic envelope, that should prevent scraps from penetrating into the appliance and any damage to the surfaces, until the unit is ready for operation.

3.3 Anchoring

It is not essential to secure the unit to the foundations, unless in areas where there is a serious risk of earthquake, or if the appliance is installed on the top of a steel frame.

3.4 Storage

When the unit is to be stored before installation, adopt a few precautions to prevent any damage or risk of corrosion or wear:

- plug or seal every single opening, such as water fittings
- do not store the appliance in a room where the temperature exceeds 50°C for the units using R407C and, if possible, do not expose to direct sunlight
- it is recommended to store the unit in a roof where traffic is minimized, to prevent the risk of accidental damage
- the unit must not be washed with a steam jet
- take away and leave to the site manager all the keys providing access to the control board

Finally, it is recommended to carry out visual inspections at regular intervals.

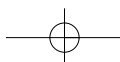

Installation

4 INSTALLATION

4.1 Positioning of the unit



Before installing the unit, make sure that the structure of the building and/or the supporting surface can withstand the weight of the appliance. The weights of the units are listed in Chapter 8 of this manual.

These units have been designed for outdoor installation on a solid surface. Standard accessories include antivibrating rubber supports, that must be positioned under the base.

When the unit is to be installed on the ground, it is necessary to provide a concrete base, to ensure a uniform distribution of the weights.

As a general rule, no special sub-bases are required. However, if the unit is to be installed on the top of inhabited rooms, it is advisable to rest it on spring shock absorbers (optional), that will minimise the transmission of any vibration to the structures.

To choose the place of installation of the unit, bear in mind that:

- the longitudinal axis of the unit must be parallel to the direction of prevailing winds, so as to ensure a uniform distribution of the air on finned exchangers
- the unit must not be installed near boilers' vent pipes
- the unit must not be installed leeward with respect to sources of air contaminated by greases, such as, for example, the outlets to kitchen exhaust hoods into the atmosphere. Otherwise, the grease is likely to deposit on the fins of the refrigerant /air exchangers, and would fix every type of atmospheric impurity, resulting in the quick clogging of the exchangers
- the unit must not be installed in areas subject to considerable snow falling
- the unit must not be installed in areas subject to flooding, under gutters etc.
- the unit must not be installed in air shafts, narrow courts or other small places, where the noise may be reflected by the walls or the air ejected by fans may short-circuit itself on refrigerant/air heat exchangers or condenser
- the place of installation must be have all the necessary spaces for air circulation and maintenance operations (see Chapter 9).

4.2 Installation of Spring Shock Absorbers

- Prepare the base, that must be flat and plane.
- Lift the appliance and insert shock absorbers as follows:

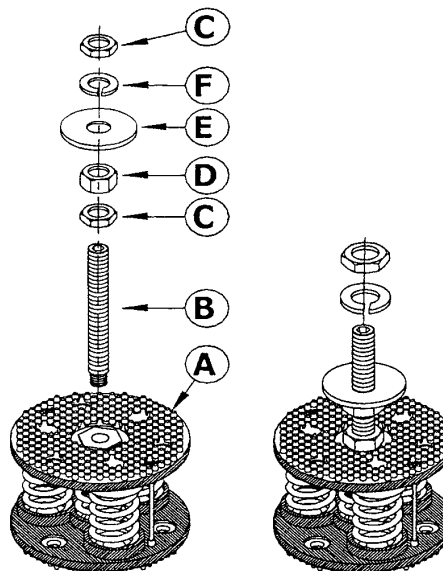

1) proceed with the assembly of the jack components

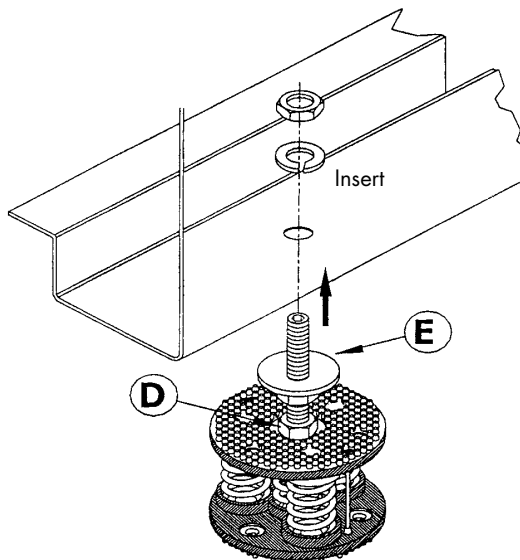

2) insert the jack into the threaded seat provided on the upper plate of the shock absorber. Then insert the jack mounted on the shock absorber, in the hole provided on the base of the machine.

Installation

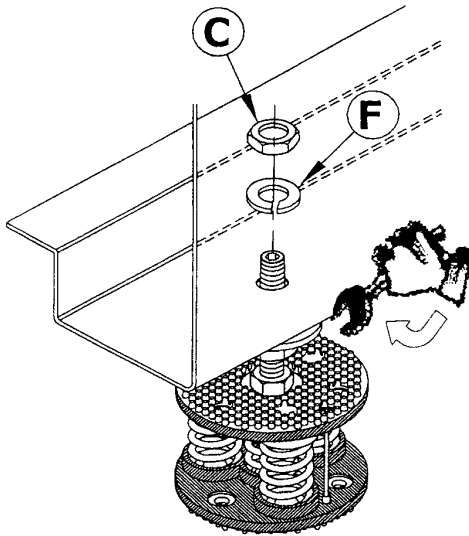

- 3) make sure that the base of the machine is resting on the flat washer (E) of the jack. To offset any difference in height, work on high nut (D), using a 24 wrench. Clamp in the obtain position with the grower washer (F) and the relevant low nut (C).

At the end of this operation, check that the machine is elastic on its axes, and preset for the installation of antivibrating joints in the water connections.

4.3 External hydraulic circuit



The external hydraulic circuit must ensure the water flow to the evaporator under any working conditions and with any adjustment.

The external hydraulic circuit should consist of the following elements:

- A circulation pump which delivers a sufficient water flow and discharge head.
- The capacity of the primary hydraulic circuit should not be less than 5 litres/KW of cooling capacity, in order to prevent the repeated start-up of the compressor and any damage to it. If the water capacity in the primary piping of the circuit and in the evaporator is lower than this value, an insulated storage tank shall be installed.
- A membrane expansion vessel provided with safety valve with vent, that must be visible.



The capacity of the expansion vessel must allow for an expansion of at least 2% of the volume of the fluid in the circuit (evaporator, piping, user circuit and standby tank, if any). The expansion vessel needs not be isolated, because no water can circulate inside it.

- A flow meter, to disable the appliance when the water is not circulating.



The flow meter must be connected in series, as shown in the wiring diagram of the control panel.

To install the flow meter, conform to the manufacturer's instructions.

As a general rule, the flow meter must be mounted on a horizontal pipe, and its distance from the curves must be 10 times the diameter of the pipe, far from valves or other components that may hinder the water flow upstream of or downstream from the flow meter.

- The air exhaust valves must be mounted in the highest point of the piping.
- The stop valves must be mounted on the water inlet/outlet piping of the evaporator and the heat recovery condenser.
- The drain points (provided with plugs, cocks etc.) must be positioned in the lowest point of the piping.

Furthermore:

- Provide the evaporator with a by-pass circuit equipped with valve, to wash the plant.
- Insulate the piping, to prevent the risk of heat loss.
- Install a filter on the suction side of the evaporator or the heat recovery condenser.

Installation

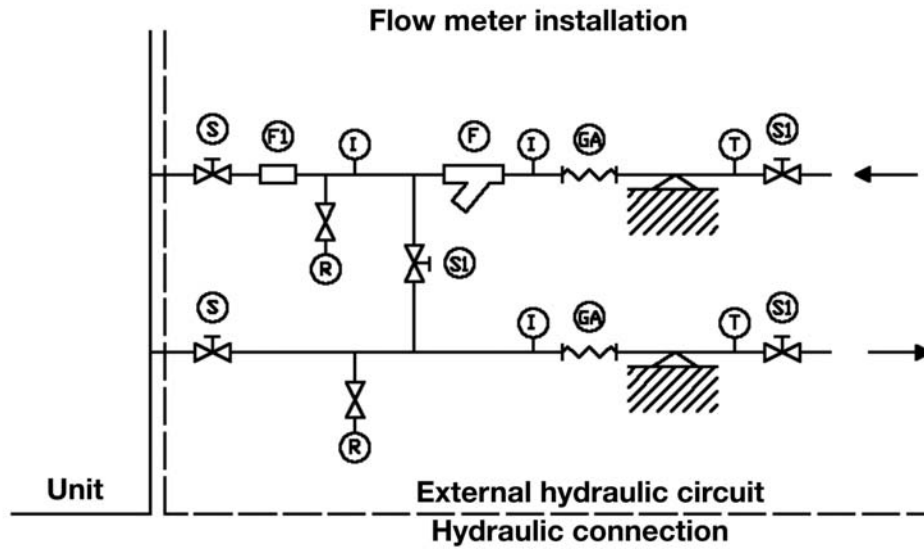

Legends:

- I: Pressure gauge connection
- S: Gate valve
- Fl: Flow meter

- GA: Flexible hoses
- R: Drain cock
- T: Thermometer
- F: Filter



Before filling the circuit, it is important to check that it is free from any foreign matter, sand, gravels, rust, welding deposits, waste and other materials that may damage the evaporator.

When cleaning the lines, it is recommended to create a circuit by-pass. It is important to mount a filtering medium (30 mesh) upstream of the chiller.



If necessary, the water required to fill the circuit must be treated to obtain the requested PH.

4.4 Hydraulic connection

The water inlet/outlet fittings shall conform to the instructions provided by the plates affixed neat the connection points.

4.5 Draining the defrosting waste water (for heat pump unit only)

When heat pump units work in heating mode, during defrosting cycles, they may discharge water from the base. This is why the units should be installed at least 200 mm above the floor level, so as to allow the free drainage of waste water, without the risk of producing ice banks.

The heat pump units must be installed in positions where the defrosting water cannot create any damage.

4.6 Power supply



Before carrying out any operations on the electrical system, make sure that the unit is deenergised.



It is important that the appliance is grounded.

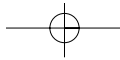

Installation



The company in charge of the installation shall conform to the standards applicable to outdoor electrical connections.



Before connecting the power supply lines, check that the available voltage value does not exceed the range specified in the Electric Data (Chapter 8).

Itelco-Clima may not be held liable for any damage and/or injury caused by failure to comply with these precautions.

The unit conforms to EN 60204-1.

The following connections shall be provided:

- A 3-phase and grounding connection for the power supply circuit.
- The electrical distribution system shall meet the power absorbed by the appliance.
- The disconnecting and magnetothermal switches must be sized to control the starting current of the unit.
- The power supply lines and the insulation devices must be designed in such a way that every line independent.
- It is recommended to install differential switches, to prevent any damage caused by phase drops.
- The fans and compressors are supplied through contactors controlled from the control panel.
- Each motor is provided with an internal safety thermal device and external fuses.
- The power supply cables must be inserted into dedicated openings on the front of the unit, and they will enter the electrical board through holes drilled on the bottom of the board.

For 3-phase systems, check also that the unbalance between the phases does not exceed 2%. To perform this check, measure the differences between the voltage of each phase couple and their mean value during operation. The maximum % value of these differences (unbalance) must not exceed 2% of the mean voltage. If the unbalance is unacceptable, contact the Energy Distributor to solve this problem.



Supplying the unit through a line whose unbalance exceeds the permissible value will automatically void the warranty.

4.7 Electrical connections

The unit must be installed on site according to the Machinery Directive (98/37/EC), the Low Voltage Directive (73/23/EC), the Electromagnetic Interference Directive (89/336/EC) and the usual procedures and standards applicable in the place of installation. The unit must not be operated if its installation has not been carried out according to the instructions provided in this manual.

The power supply lines must consist of insulated copper conductors, dimensioned for the maximum absorbed current.

Connection to terminals must be performed according to the diagram of connections provided in this manual and according to the wiring diagram which accompanies the unit.

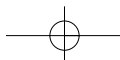

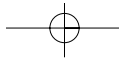

Installation

Terminal box CLS/CLH/CLC STD-LN-ELN-HPF-HT

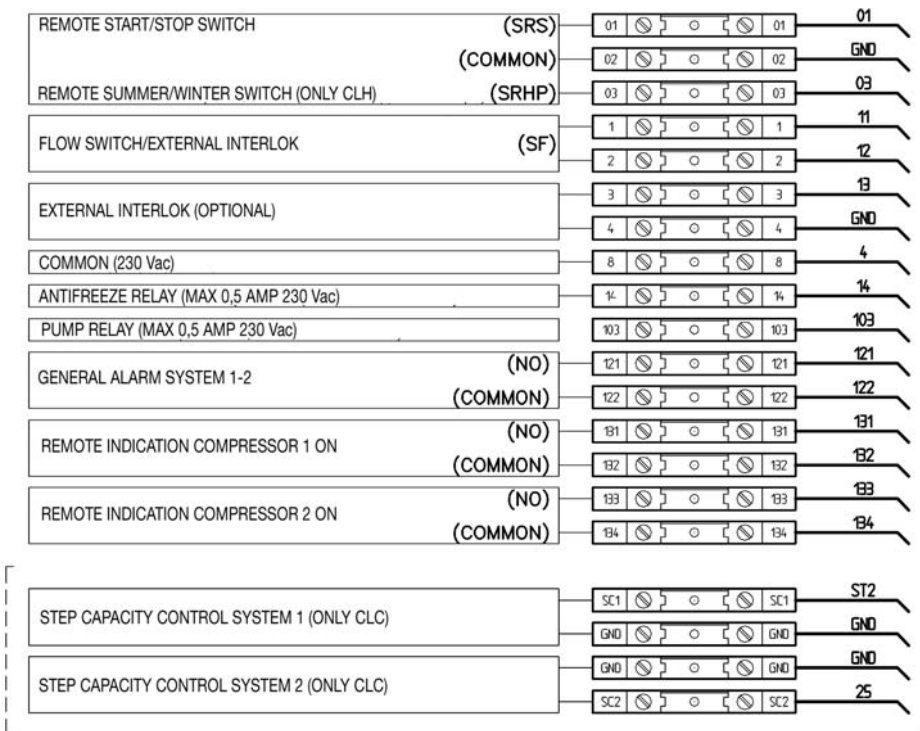

Terminal box CLH EH

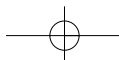
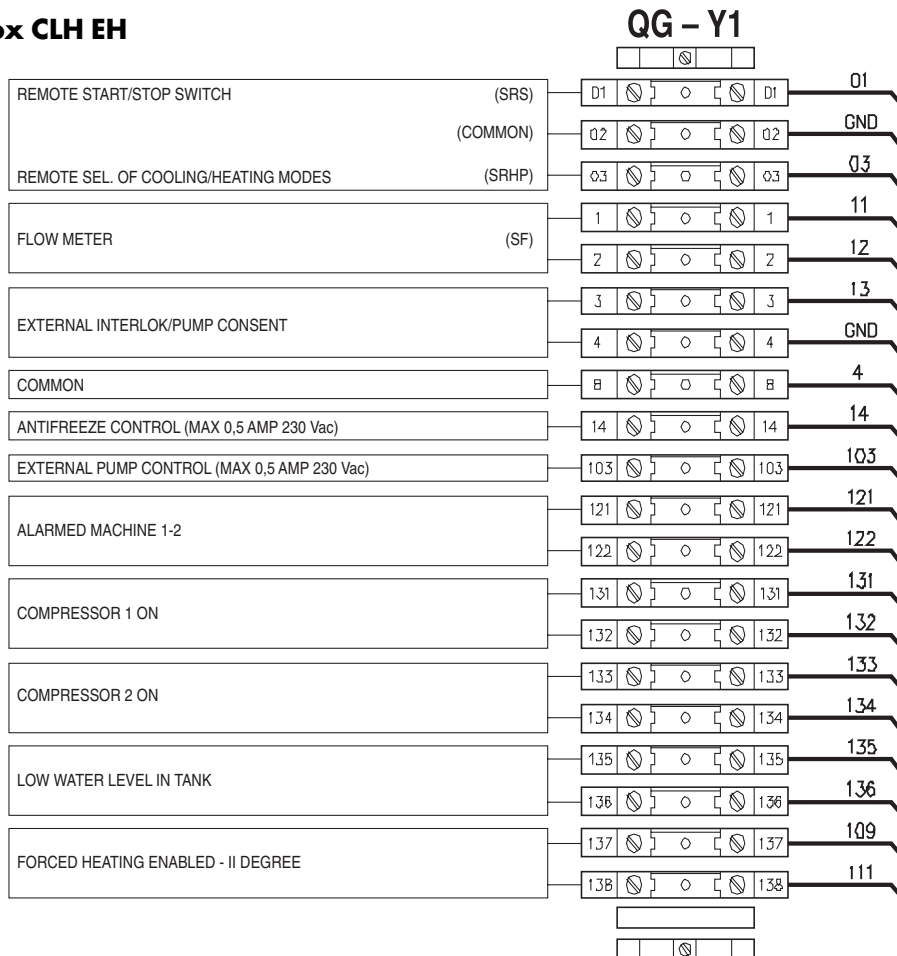

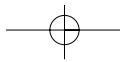

Start-up

5 START-UP



The unit must be started for the first time by personnel suitably trained by one of Itelco-Clima's Authorised Service Centre. Failure to meet this requirement will immediately void the warranty.



The operations carried out by Itelco-Clima personnel are limited to the start-up of the unit, and do not include any other operation on the plant, such as, for example, electrical and hydraulic connections etc. All the other operations before start-up, including oil pre-heating for at least 12 hours, must be performed by the Installer.

5.1 Preliminary check

The checks listed below shall be performed before starting the unit and before the arrival of the personnel authorised by Itelco-Clima.

- Check the section of power supply and grounding cables; make sure that terminals are tightened and check the correct operation of contactors, with the master switch open.
- Check that any voltage and phase variation in the power supply does not exceed the prefixed thresholds.
- Connect the contacts of the flow meter and the thermal relay of the pump and of the other devices (if any), to terminals 1-2 and 3-4, respectively.
- Check that the components of the external water circuit (pump, user equipment, filters, power supply tank and reservoir, if any) have been installed properly, and according to the manufacturer's instructions.
- Check the filling of the hydraulic circuits, and make sure that the fluid circulation is correct, without any trace of leaks and air bubbles. If you use ethylene glycol as antifreeze, check that its percentage is correct.
- Check that the direction of rotation of the pumps is correct, and that fluids have been circulating for at least 12 hours for both pumps. Then, clean the filters on the suction side of the pumps.
- Adjust the liquid distribution network in such a way that the flow rate is within the specified range.
- Check that the water quality is up to the specifications.
- Check that oil heaters, if any, have been turned on at least 12 hours before.

5.2 Start-up

Start-up sequence:

- Turn on the master switch (at least 12 hours before).
- Check that the oil in the compressor has reached the requested temperature (the minimum temperature outside the pan must be approx. 40°C) and that the auxiliary control circuit is energised.
- Check the operation of all the external equipment, and make sure that the control devices of the plant are properly calibrated.
- Start the pump and check that the water flow is correct.
- Set the desired fluid temperature on the control board.
- Start the appliance (see Chapter 6).
- Check the correct direction of rotation of compressors. Scroll compressors cannot compress the refrigerant when they rotate in the opposite direction. To make sure that they are rotating in the correct direction, simply check that, just after the start-up of the compressor, the pressure drops on the LP side and rises on the HP side. Furthermore, if a scroll compressor rotate in the opposite direction, there is a considerable rise in the sound level of the unit, as well as in a dramatic reduction of current absorption compared to normal values. In case of wrong rotation, the scroll compressor can be definitely damaged.
- After about 15 minutes of operation check that there are no bubbles, through the sight glass on the liquid line.



The presence of bubbles may indicate that a part of the refrigerant charge has been released in one or more points. It is important to remove these leaks before proceeding.

- Repeat the start-up procedure after removing the leaks.
- Check the oil level in the compressor's sight glass.

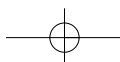

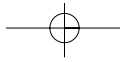

Start-up

5.3 Checking the operation

Check the following:

- The temperature of the water entering the evaporator.
- The temperature of the water leaving the evaporator.
- The level of the water flow rate in the evaporator, if possible.
- The current absorption upon the start of the compressor and in case of stabilised operation.
- The fan's current absorption.

Check that the condensing and evaporation temperatures, during operation at high and low pressure detected by the pressure gauges of the refrigerant, are within the following range:
(On the units not provided with HP/LP pressure gauges for the refrigerant, connect a pressure gauge to the Schrader valves on the refrigeration circuit).

HP side	Approx. 15 to 21°C above the temperature of the air entering the condenser, for R407C units.
LP side	Approx. 2 to 4°C below the temperature of the leaving chilled water, for R407C units.

5.4 Delivery to the customer

- Train the user according to the instructions provided in Section 6.

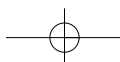

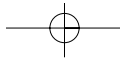

Control

6 CONTROL

The standard equipment of the units includes a control and monitoring electronic system, which ensures the deployment of all control, monitoring and alarm functions of these units.

6.1 General information

The system consists of an electronic card and a panel terminal.

Control functions:

- Checking of the heating/cooling capacity of the unit.
- Management of the compressors' delayed start-up.
- Defrosting (CLH models).
- Antifreeze protection.
- Pump control (internal hydronic kit)

6.2 Control system

■ Temperature regulation

The regulator mounted on the units (COOLING ONLY version) is shop-calibrated to check the unit, as a function of the temperature of the chilled water back from the plant.

Its sensor is then installed on the water inlet in the refrigerant/water heat exchanger, so that it can measure the plant load.

The only regulation required for the regulator is the calibration of the set point, in the +7 to +20 °C range (the shop calibration is +10 °C).

In case of HEAT PUMP units, the regulator can be calibrated in the +20 to +47 °C range for heating (the shop calibration is +40 °C); as for cooling, refer to the data provided for the cooling only version.



If you wish to set the set point of the entering water temperature to values below +9 °C, consult our Technical Dept. to learn all the precautions required to obtain the ideal operation of the appliance. Anyway, consider always the ΔT between water inlet and water outlet, so as not to exceed the minimum temperature of the produced water.

■ Antifreeze functions

These units are provided with antifreeze protection for the chilled fluid. This protection consists of a resistor in contact with the refrigerant/fluid heat exchanger, which is enabled (also when the unit is off) when the fluid temperature drops below 5 °C: standard value for non-glycolated units. The activation of the antifreeze protection causes the safety stop of the involved circuit.

This safety device supplements the action of the differential safety pressure switch (glycolated). An antifreeze alarm is activated. If the circulating fluid is water, before the beginning of winter it is advisable to drain the circuit to prevent the icing of the water inside it.

If the circuit cannot be drained, it is imperative to deenergise the unit, so as to allow, when necessary, the activation of the antifreeze protection.

■ Defrosting

The CLH heat pump units are provided with an automatic defrosting system that prevents the formation of excess ice on the refrigerant/air heat exchanger during heat pump operation.

This system, which is part of the electronic control system, is of the time /temperature type, and when the temperature measured by a sensor at the inlet of the coil, once the preset time has expired, drops below a pre-determined value, switches the operation of the unit from heating to cooling.

During the defrosting cycle the compressor works normally, but the fans of the external coil remain off. The defrosting cycle stops after the coil has been defrosted; at this point the unit works in heating mode again.

Both circuits are defrosted at the same time. For safety reasons, if the delivery pressure reaches considerable values, fans are started also during defrosting.

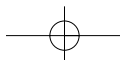

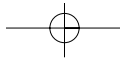

Control

6.3 Display

The display allows to indicate, in particular:

- The temperature of the water entering the machine in Celsius degrees
- The alarm code, if an alarm has been activated

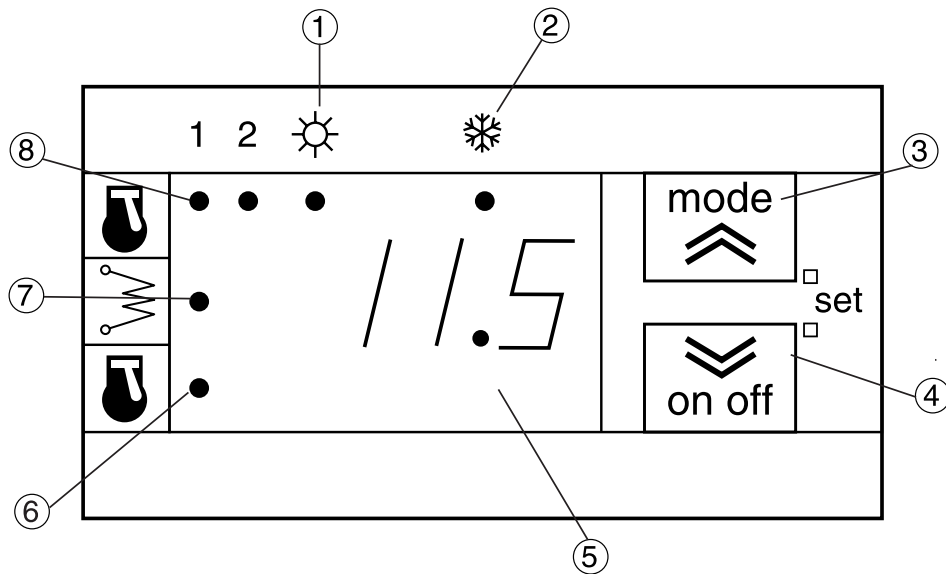

LED's:

- 1 Displays the "Heating" mode of operation
- 2 Displays the "Cooling" mode of operation
- 3 Selects the operation mode
- 4 Unit start/stop; Reset of the alarms
- 5 Displays the parameter values and quantities
- 6 Displays Compressor 2 running (blinking = timing in progress)
- 7 Displays Resistor on (CLH Extra Heater versions)
- 8 Displays Compressor 1 running (blinking = timing in progress)

If **LED's 1** and **2** are both off, the control is in stand-by.

If **LED's 6** and **8** are slowly blinking at the same time, the control is in defrosting mode.

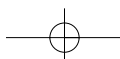

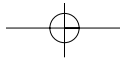

Control

6.4 Start-up

Once you have checked that the electrical connections are workmanlike, the unit can be started as follows:

– Hold down the ON-OFF button for 2 seconds to turn on the regulator.

– If, upon start-up, only the decimal point appears on the screen of the display, the regulator is in standby mode.

– **“Cooling only” models:**

■ Press the MODE button to restart the machine, the water return temperature will appear on the display and the cooling LED will light up.

When the compressor LED starts blinking, there is a demand for cooling capacity, and the timing is in progress.

■ To stop the machine, press the MODE button again.

■ When you press the MODE button, you obtain the following sequence :

Standby or Cooling or Standby

– **“Heat pump” models:**

■ For heat pump operation, follow the same procedure adopted for operation in cooling mode.

■ To operate the machine in heat pump mode, press the MODE button again; the Heating LED will light up. To stop the machine, press the same button again.

■ When you press the MODE button, you obtain the following sequence:

Standby or Cooling or Heating or Standby



Do not switch from heating to cooling mode suddenly; wait until the temperature of the circulating water drops below +25 °C.

6.5 Switching the working temperature

– Put the machine in Standby (using the MODE key).

– **“Cold only” models :**

1) Press the MODE and ON OFF buttons at the same time and release them after a second; the “SET” message will appear.

2) **Repeat step 1); the “Coo” message will appear on the display.**

3) Repeat step 1) to display the preset temperature. To modify it, use the UP and DOWN arrows.

To store the change, press the MODE and ON-OFF keys at the same time for 5 seconds; the “Coo” message will appear on the display.

Repeat this step another time to display the “SET” message, and a third time to go back to normal display.

– **“Heat pump” models:**

■ Carry out the operations 1) and 2) as described above, then press either arrow to display the “HEA” message.

■ Carry out the operation 3) to switch the programming to hot, and then go back to normal display.

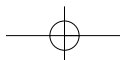

Control

6.6 Main alarms

Code	Description	Reset
E00	Remote Off	Automatic
E01	High pressure 1	Manual
E02	Low pressure 1	Automatic/manual
E03	Thermal protection, compressor 1	Manual
E04	Thermal protection, fans	Manual
E05	Antifreeze, circuit 1	Manual
E06	Failure of leaving water sensor 1	Automatic
E07	Failure of coil sensor 1	Automatic
E21	High pressure 2	Manual
E22	Low pressure 2	Automatic/manual
E23	Thermal protection, compressor 2	Manual
E25	Antifreeze, circuit 2	Manual
E26	Failure of leaving water sensor 2	Automatic
E27	Failure of coil sensor 2	Automatic
E40	Failure of entering water sensor	Automatic
E41	Flow meter - no water	Manual
E42	Failure of ST4 sensor	Automatic
E44	Machine discharge	Manual
E45	Configuration error	Manual
E46	High temperature of entering water	Automatic

Once you have solved the problem that originated the alarm, reset the alarms by pressing the ON-OFF button.

E00 does not close the relay that signals an alarm state (terminals 121-122)

High pressure alarm

When this alarm is activated, the control system halts the operation of the involved refrigeration circuit and opens the compressor's control chain (safety against failures). The alarm is reset manually from the control panel when the pressure switch has been reset automatically.

Low pressure alarm

When this alarm is activated, the control system halts the operation of the involved refrigeration circuit. The activation of this alarm is inhibited for approx. 40 seconds from start-up. The reset is automatic for the first three times during the same hour. Upon the fourth activation, a manual reset is required.

Antifreeze alarm

This alarm is enabled when the temperature of the fluid leaving the evaporator drops below 4 °C. After the activation of this alarm, the control system halts the operation of the involved refrigeration circuit. The reset is manual from the control panel.

External interlock alarm

When this alarm is activated, the control system halts the operation of the unit. The reset is automatic.

General Description

7 GENERAL DESCRIPTION

7.1 Introduction

The CLS/CLH units are water chillers/air - water heat pumps with hermetic scroll compressors with double refrigeration circuit.

These units are fit for cooling and heating the water necessary for each air-conditioning application and

other types of fluids, such as, for example, glycoled water, that can be used in industrial processes.

The units are fit for outdoor installation on the roof of a building, or at ground level.

The series includes the following variances:

Version	Description
CLS/CLH Standard (STD) version	Chillers/ Heat Pumps with air condensation, working with the R407C refrigerant (or with R22, on demand, in extra European countries)
CLS/CLH Low Noise (LN) version	
CLS/CLH Extra Low Noise (ELN) version	
CLS/CLH High Pressure Fans (HPF) version	
CLS High Temperature (HT) version	

For each CLS version is available the equivalent condensing unit: CLC.

Available options:

Options	Description
CLS/CLH P	Unit provided with hydronic kit, 1 pump
CLS/CLH 2P	Unit provided with hydronic kit, 2 pumps
CLS/CLH 1PT	Unit provided with hydronic kit, 1 pump and 1 storage tank
CLS/CLH 2PT	Unit provided with hydronic kit, 2 pumps and 1 storage tank
CLH EH	Heat pump unit, with 1 or 2 pumps + tank with additional resistors

7.2 General specifications

The CLS/CLH units are supplied complete and provided with all connecting pipes for the refrigerant and internal wiring.

The refrigeration circuit of each CLS/CLH unit undergoes a pressure test, is drained, vacuumised, dehydrated and filled with refrigerant, and includes the necessary oil. Once assembled, each unit is subjected to a complete final testing and the correct operation of all refrigeration circuits is checked.

The base and the frame of each unit are made of very thick galvanised sheet, and are secured by screw and tropicalised steel bolts. All panels can be disassembled for easy access to internal components.

All galvanised steel parts are painted with white polyester resin (RAL 9001), to ensure the resistance of the unit to corrosion and weather agents over time.

7.3 Compressors

The CLS/CLH units are provided with hermetic scroll compressors, with built-in motor protection.

Compressors are mounted on shock absorbers to reduce vibrations. Motors are of direct start-up type, cooled by the sucked refrigerant gas.

Thermistors protect the windings from any overtemperatures and the electronic control checks that the delivery temperature is within the permissible range.

The capacity control, as well as the control of the delivered cooling capacity, are always ensured by the electronic control.

7.4 Refrigeration circuits

Each unit has two complete refrigeration circuits, one per each compressor. Each refrigeration circuit includes: a service valve to fill the unit with refrigerant, shut-off valves, thermostatic expansion valve, dehydrating filter, sight glass with humidity indicator, a differential pressure switch for the water. Condensing unit CLC deriving from CLS and are without evaporator. This units have check valve on suction line and liquid line, it allows to collect with remote evaporators. Furthermore, each circuit is equipped with safety devices in accordance with PED 97/23/EC: high and low pressure switches, safety valves providing protection in case of fire or malfunction of compressors.

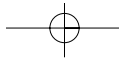

General Description

7.5 Water heat exchanger

The evaporators are of stainless steel plate type. Their thermal insulation is ensured by a thick flexible closed-cell heat-insulating jacket.

Furthermore, the frost protection is ensured by electric heaters. These exchangers can work at pressures up to 10 bar on the hydraulic side and 30 bar on the refrigerant side.

The hydraulic connections to the evaporator are of 2" Victaulic type, while the connection to the network is ensured by 2" threaded male fittings.

7.6 Air heat exchanger

Coils are made of copper pipes in staggered rows, mechanically expanded inside an aluminium finned pack.

7.7 Fans

Fans are of directly coupling propeller type, provided with aluminium blade with wing profile. Each fan is provided with galvanised steel accident-prevention guard.

Finally, motors are completely closed, protection class IP54, protection thermostat immersed in windings.

The continuous speed regulator is provided as shop-mounted accessory (standard on the ELN version).

CLS refrigeration diagram

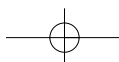
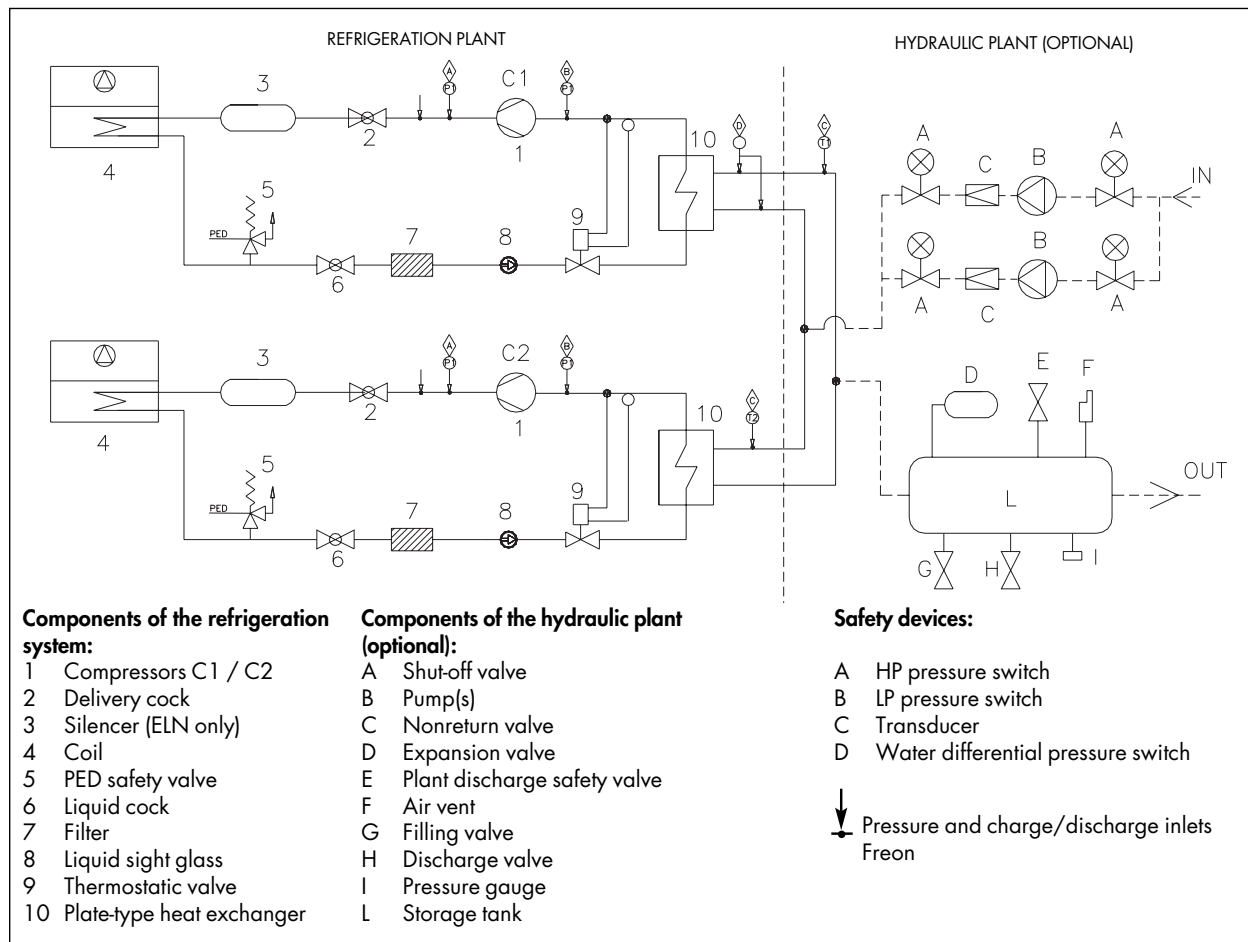

General Description

CLH refrigeration diagram

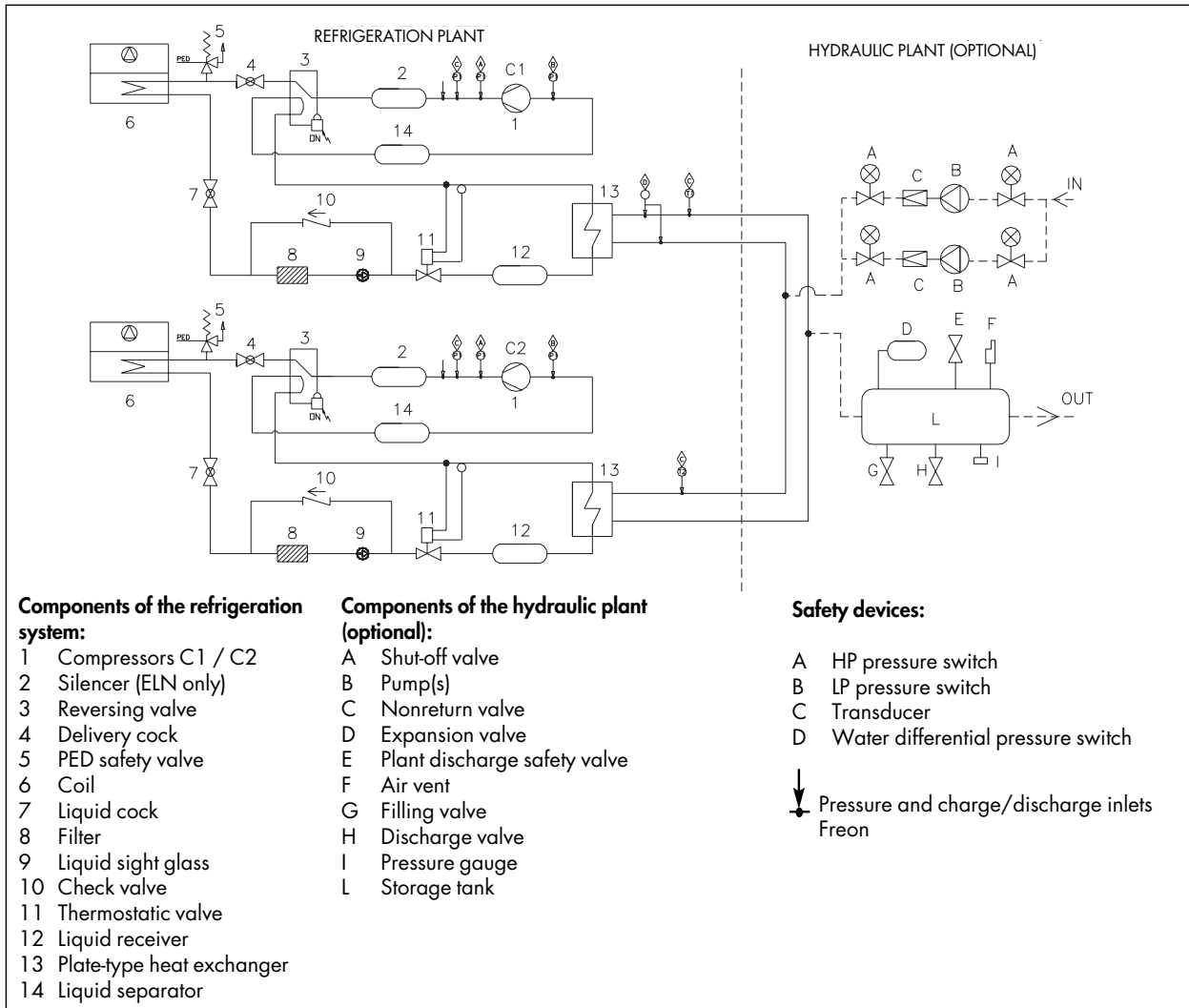

CLC refrigeration diagram

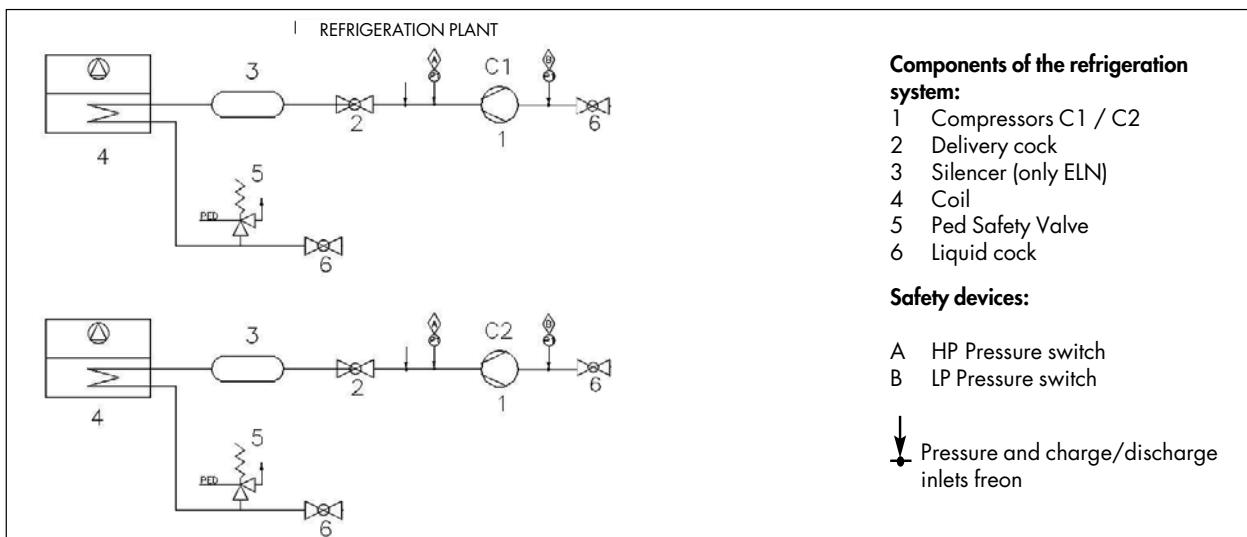

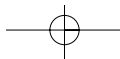

General Description

7.8 Electric power supply and control system

The control compartment contains an electronic card with keyboard and a display for working parameters, alarms, if any, and operating blocks.

It is complete with remote control switches and protection fuses for the motors of compressors, fans and pumps.

7.9 Accessories

List of available accessories, provided separately, to be mounted on site by the installer:

Water flow meter

Prevents the operation of the unit when the chilled fluid is insufficient. It is advisable to install a flow meter, to ensure the correct operation of the unit.

Water filter

Filter to be mounted on the suction side of the water heat exchanger.

Antivibrating supports (AVM)

Isolating spring supports, equipped with bolts for fastening to the base. They are supplied separated from the unit and must be mounted on site by the customer, at his own expense.

Wire-type remote control kit

The kit includes a remote control for wall mounting, complete with 3m-long connecting cable, and installation manual and a transformer.

For longer distances (i.e. up to 50m) you can use a multipolar cable of minimum section (0.25mm). Conductors should be connected directly and according to the diagram with accompanies the installation instructions.

Remote wall terminal (200 m)

Makes it possible to check the unit through a remote terminal, up to a maximum distance of 200 meters.

RS 485 MODBUS serial card

A communication interface makes it possible to control and manage the unit from a local station, with RS485 connection, up to a distance of 1,000m.

It is possible to obtain the remote control and the management, by inserting the control into the management plant of the building.

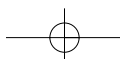

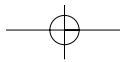

Technical data

8 TECHNICAL DATA

8.1 Pressure drops in the evaporator

PRESSURE DROPS IN THE EVAPORATOR						
		CLS 182	CLS 202	CLS 242	CLS 302	CLS 352
K		52.3	41.5	29.4	21.0	12.5
Min. water flow rate	l/s	1.4	1.8	2.2	2.5	3.1
Nominal flow rate	l/s	1.9	2,6	3,1	3.5	4.3
Max. water flow rate	l/s	3.2	4.3	5.2	5.9	7.2
Min. pressure drops	kPa	10.1	14.1	14.4	13.5	11.8
Nominal pressure drops	kPa	19.9	27.7	28.3	26.4	23.2
Max. pressure drops	kPa	55.3	77.0	78.6	73.3	64.4

PRESSURE DROPS IN THE EVAPORATOR						
		CLS 402	CLS 502	CLS 552	CLS 602	
K		10.6	10.6	10.6	10.6	
Min. water flow rate	l/s	3.6	4.1	4.6	5.1	
Nominal flow rate	l/s	5.0	5.8	6.5	7.1	
Max. water flow rate	l/s	8.4	9.7	10.8	11.9	
Min. pressure drops	kPa	13.7	18.2	22.7	27.6	
Nominal pressure drops	kPa	26.9	35.7	44.4	54.1	
Max. pressure drops	kPa	74.6	99.5	123.5	150.4	

PRESSURE DROPS IN THE EVAPORATOR						
		CLH 182	CLH 202	CLH 242	CLH 302	CLH 352
K		52.3	41.5	29.4	21.0	12.5
Min. water flow rate	l/s	1.4	1.9	2.3	2.7	3.0
Nominal flow rate	l/s	1.9	2,6	3,2	3.8	4.2
Max. water flow rate	l/s	3.2	4.4	5.4	6.3	7.0
Min. pressure drops	kPa	10.1	14.5	15.5	15.1	11.3
Nominal pressure drops	kPa	19.9	28.4	30.4	29.5	22.1
Max. pressure drops	kPa	55.3	78.9	84.5	82.1	61.5

PRESSURE DROPS IN THE EVAPORATOR						
		CLH 402	CLH 502	CLH 552	CLH 602	
K		10.6	10.6	10.6	10.6	
Min. water flow rate	l/s	3.4	3.8	4.1	4.5	
Nominal flow rate	l/s	4.7	5.3	5.8	6.3	
Max. water flow rate	l/s	7.9	8.8	9.6	10.5	
Min. pressure drops	kPa	12.0	15.1	18.1	21.3	
Nominal pressure drops	kPa	23.6	29.5	35.4	41.8	
Max. pressure drops	kPa	65.6	82.0	98.4	116.2	

$$\Delta P = K \cdot Q^2 / 10$$

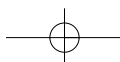

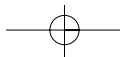

Technical data

8.2 Technical data

CLS STD		182	202	242	302	352
Power supply	V/ph/Hz	400/3/50				
Number of circuits		2	2	2	2	2
Number of steps		2	2	2	2	3
Capacity control steps	%	50/100	50/100	50/100	50/100	43-57/100

Refrigerant

Type		R407C				
Charge (1)	kg	7.0	7.0	9.0	10.0	12.0

Compressors

Type		Scroll	Scroll	Scroll	Scroll	Scroll
Number		2	2	2	2	2
Start-up type		Direct				

Evaporator

Type		Plate type				
Number		2	2	2	2	2
Water flow rate	l/s	1.8	2.6	3.1	3.5	4.3
Pressure drop	kPa	20.0	27.7	28.3	26.4	23.2
Minimum water content	l	3.3	3.9	2.8	3.3	4.4

Condenser

Type		Coil type (Al/Cu)				
------	--	-------------------	--	--	--	--

Hydraulic connections

Type		Gas threaded male type				
Inlet diameter	inch	2"	2"	2"	2"	2"
Outlet diameter	inch	2"	2"	2"	2"	2"

Weights

Basic unit	kg	610	640	764	818	898
Unit with single pump	kg	642	672	796	850	930
Unit with double pump	kg	662	692	816	870	950
Unit with tank and single pump	kg	907	937	1061	1115	1350
Unit with tank and double pump	kg	927	957	1081	1135	1370

Dimensions

Length	mm	2100	2100	2100	2100	2760
Width	mm	1110	1110	1110	1110	1110
Height	mm	1750	1750	1750	1750	1750

(1) Indicative value. Always refer to the value specified on the unit's label.

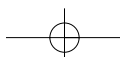

Technical data

CLS STD		402	502	552	602
Power supply	V/ph/Hz	400/3/50			
Number of circuits		2	2	2	2
Number of steps		2	2	3	2
Capacity control steps	%	50/100	50/100	43-57/100	50/100
Refrigerant					
Type		R407C			
Charge (1)	kg	12.0	17.0	18.5	20.0
Compressors					
Type		Scroll	Scroll	Scroll	Scroll
Number		2	2	2	2
Start-up type		Direct			
Evaporator					
Type		Plate type			
Number		2	2	2	2
Water flow rate	l/s	5.0	5.8	6.5	7.1
Pressure drop	kPa	26.9	35.7	44.4	54.1
Minimum water content	l	5.0	5.0	5.0	5.0
Condenser					
Type		Coil type (Al/Cu)			
Hydraulic connections					
Type		Gas threaded male type			
Inlet diameter	inch	2"	2"	2"	2"
Outlet diameter	inch	2"	2"	2"	2"
Weights					
Basic unit	kg	972	1060	1195	1230
Unit with single pump	kg	1004	1092	1227	1262
Unit with double pump	kg	1024	1112	1247	1282
Unit with tank and single pump	kg	1424	1602	1737	1772
Unit with tank and double pump	kg	1444	1622	1757	1792
Dimensions					
Length	mm	2760	3110	3110	3110
Width	mm	1110	1110	1110	1110
Height	mm	1750	1750	1750	1750

(1) Indicative value. Always refer to the value specified on the unit's label.

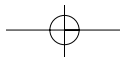

Technical data

CLS LN		182	202	242	302	352
Power supply	V/ph/Hz	400/3/50				
Number of circuits		2	2	2	2	2
Number of steps		2	2	2	2	3
Capacity control steps	%	50/100	50/100	50/100	50/100	43-57/100

Refrigerant

Type		R407C				
Charge (1)	kg	7.0	7.0	9.0	11.0	12.0

Compressors

Type		Scroll	Scroll	Scroll	Scroll	Scroll
Number		2	2	2	2	2
Start-up type		Direct				

Evaporator

Type		Plate type				
Number		2	2	2	2	2
Water flow rate	l/s	1.8	2.6	3.1	3.5	4.3
Pressure drop	kPa	20.0	27.7	28.3	26.4	23.2
Minimum water content	l	3.3	3.9	2.8	3.3	4.4

Condenser

Type		Coil type (Al/Cu)				
------	--	-------------------	--	--	--	--

Hydraulic connections

Type		Gas threaded male type				
Inlet diameter	inch	2"	2"	2"	2"	2"
Outlet diameter	inch	2"	2"	2"	2"	2"

Weights

Basic unit	kg	610	640	764	818	898
Unit with single pump	kg	642	672	796	850	930
Unit with double pump	kg	662	692	816	870	950
Unit with tank and single pump	kg	907	937	1061	1115	1350
Unit with tank and double pump	kg	927	957	1081	1135	1370

Dimensions

Length	mm	2100	2100	2100	2100	2760
Width	mm	1110	1110	1110	1110	1110
Height	mm	1850	1850	1850	1850	1850

(1) Indicative value. Always refer to the value specified on the unit's label.

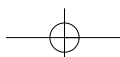

Technical data

CLS LN		402	502	552	602
Power supply	V/ph/Hz	400/3/50			
Number of circuits		2	2	2	2
Number of steps		2	2	3	2
Capacity control steps	%	50/100	50/100	43-57/100	50/100
Refrigerant					
Type		R407C			
Charge (1)	kg	13.0	17.0	18.5	20.0
Compressors					
Type		Scroll	Scroll	Scroll	Scroll
Number		2	2	2	2
Start-up type		Direct			
Evaporator					
Type		Plate type			
Number		2	2	2	2
Water flow rate	l/s	5.0	5.8	6.5	7.1
Pressure drop	kPa	26.9	35.7	44.4	54.1
Minimum water content	l	5.0	5.0	5.0	5.0
Condenser					
Type		Coil type (Al/Cu)			
Hydraulic connections					
Type		Gas threaded male type			
Inlet diameter	inch	2"	2"	2"	2"
Outlet diameter	inch	2"	2"	2"	2"
Weights					
Basic unit	kg	972	1060	1195	1230
Unit with single pump	kg	1004	1092	1227	1262
Unit with double pump	kg	1024	1112	1247	1282
Unit with tank and single pump	kg	1424	1602	1737	1772
Unit with tank and double pump	kg	1444	1622	1757	1792
Dimensions					
Length	mm	2760	3110	3110	3110
Width	mm	1110	1110	1110	1110
Height	mm	1850	1850	1850	1850

(1) Indicative value. Always refer to the value specified on the unit's label.

Technical data

CLS ELN		182	202	242	302	352
Power supply	V/ph/Hz	400/3/50				
Number of circuits		2	2	2	2	2
Number of steps		2	2	2	2	3
Capacity control steps	%	50/100	50/100	50/100	50/100	43-57/100

Refrigerant

Type		R407C				
Charge (1)	kg	7.5	7.5	9.0	11.0	12.0

Compressors

Type		Scroll	Scroll	Scroll	Scroll	Scroll
Number		2	2	2	2	2
Start-up type		Direct				

Evaporator

Type		Plate type				
Number		2	2	2	2	2
Water flow rate	l/s	2.0	2.6	3.0	3.3	4.2
Pressure drop	kPa	19.9	27.7	27.3	23.0	22.6
Minimum water content	l	3.3	3.9	2.8	3.3	4.4

Condenser

Type		Coil type (Al/Cu)				
------	--	-------------------	--	--	--	--

Hydraulic connections

Type		Gas threaded male type				
Inlet diameter	inch	2"	2"	2"	2"	2"
Outlet diameter	inch	2"	2"	2"	2"	2"

Weights

Basic unit	kg	652	678	806	828	960
Unit with single pump	kg	684	710	838	860	992
Unit with double pump	kg	704	730	858	880	1012
Unit with tank and single pump	kg	949	975	1103	1125	1412
Unit with tank and double pump	kg	969	995	1123	1145	1432

Dimensions

Length	mm	2100	2100	2100	2100	2760
Width	mm	1110	1110	1110	1110	1110
Height	mm	1850	1850	1850	1850	1850

(1) Indicative value. Always refer to the value specified on the unit's label.

Technical data

CLS ELN		402	502	552	602
Power supply	V/ph/Hz	400/3/50			
Number of circuits		2	2	2	2
Number of steps		2	2	2	3
Capacity control steps	%	50/100	50/100	43-57/100	50/100
Refrigerant					
Type		R407C			
Charge (1)	kg	12.0	17.0	18.5	20.0
Compressors					
Type		Scroll	Scroll	Scroll	Scroll
Number		2	2	2	2
Start-up type		Direct			
Evaporator					
Type		Plate type			
Number		2	2	2	2
Water flow rate	l/s	4.7	5.5	6.5	7.1
Pressure drop	kPa	23.8	35.7	44.4	54.1
Minimum water content	l	5.0	5.0	5.0	5.0
Condenser					
Type		Coil type (Al/Cu)			
Hydraulic connections					
Type		Gas threaded male type			
Inlet diameter	inch	2"	2"	2"	2"
Outlet diameter	inch	2"	2"	2"	2"
Weights					
Basic unit	kg	984	1080	1215	1250
Unit with single pump	kg	1016	1112	1247	1282
Unit with double pump	kg	1036	1132	1267	1302
Unit with tank and single pump	kg	1436	1622	1757	1792
Unit with tank and double pump	kg	1456	1642	1777	1812
Dimensions					
Length	mm	2760	3110	3110	3110
Width	mm	1110	1110	1110	1110
Height	mm	1850	1850	1850	1850

(1) Indicative value. Always refer to the value specified on the unit's label.

Technical data

CLS HPF		182	202	242	302	352
Power supply	V/ph/Hz	400/3/50				
Number of circuits		2	2	2	2	2
Number of steps		2	2	2	2	3
Capacity control steps	%	50/100	50/100	50/100	50/100	43-57/100

Refrigerant

Type		R407C				
Charge (1)	kg	7.5	7.5	9.0	11.0	12.0

Compressors

Type		Scroll	Scroll	Scroll	Scroll	Scroll
Number		2	2	2	2	2
Start-up type		Direct				

Evaporator

Type		Plate type				
Number		2	2	2	2	2
Water flow rate	l/s	2.0	2.6	3.1	3.5	4.3
Pressure drop	kPa	20.0	27.7	28.3	26.4	23.2
Minimum water content	l	3.3	3.9	2.8	3.3	4.4

Condenser

Type		Coil type (Al/Cu)				
------	--	-------------------	--	--	--	--

Hydraulic connections

Type		Gas threaded male type				
Inlet diameter	inch	2"	2"	2"	2"	2"
Outlet diameter	inch	2"	2"	2"	2"	2"

Weights

Basic unit	kg	610	640	764	818	898
Unit with single pump	kg	642	672	796	850	930
Unit with double pump	kg	662	692	816	870	950
Unit with tank and single pump	kg	907	937	1061	1115	1350
Unit with tank and double pump	kg	927	957	1081	1135	1370

Dimensions

Length	mm	2100	2100	2100	2100	2760
Width	mm	1110	1110	1110	1110	1110
Height	mm	1850	1850	1850	1850	1850

(1) Indicative value. Always refer to the value specified on the unit's label.

Technical data

CLS HPF		402	502	552	602
Power supply	V/ph/Hz	400/3/50			
Number of circuits		2	2	2	2
Number of steps		2	2	3	2
Capacity control steps	%	50/100	50/100	43-57/100	50/100
Refrigerant					
Type		R407C			
Charge (1)	kg	12.0	17.0	18.5	20.0
Compressors					
Type		Scroll	Scroll	Scroll	Scroll
Number		2	2	2	2
Start-up type		Direct			
Evaporator					
Type		Plate type			
Number		2	2	2	2
Water flow rate	l/s	5.0	5.8	6.5	7.1
Pressure drop	kPa	26.9	35.7	43.1	51.2
Minimum water content	l	5.0	5.0	5.0	5.0
Condenser					
Type		Coil type (Al/Cu)			
Hydraulic connections					
Type		Gas threaded male type			
Inlet diameter	inch	2"	2"	2"	2"
Outlet diameter	inch	2"	2"	2"	2"
Weights					
Basic unit	kg	972	1060	1195	1230
Unit with single pump	kg	1004	1092	1227	1262
Unit with double pump	kg	1024	1112	1247	1285
Unit with tank and single pump	kg	1424	1602	1737	1772
Unit with tank and double pump	kg	1444	1622	1757	1792
Dimensions					
Length	mm	2760	3110	3110	3110
Width	mm	1110	1110	1110	1110
Height	mm	1850	1850	1850	1850

(1) Indicative value. Always refer to the value specified on the unit's label.

Technical data

CLS HT		182	202	242	302	352
Power supply	V/ph/Hz	400/3/50				
Number of circuits		2	2	2	2	2
Number of steps		2	2	2	2	3
Capacity control steps	%	50/100	50/100	50/100	50/100	43-57/100

Refrigerant

Type		R407C				
Charge (1)	kg	7.5	7.5	9.0	11.0	12.0

Compressors

Type		Scroll	Scroll	Scroll	Scroll	Scroll
Number		2	2	2	2	2
Start-up type		Direct				

Evaporator

Type		Plate type				
Number		2	2	2	2	2
Water flow rate	l/s	2.1	2.8	3.3	3.8	4.5
Pressure drop	kPa	23.0	32.2	32.9	30.2	25.0
Minimum water content	l	3.3	3.9	2.8	3.3	4.4

Condenser

Type		Coil type (Al/Cu)				
------	--	-------------------	--	--	--	--

Hydraulic connections

Type		Gas threaded male type				
Inlet diameter	inch	2"	2"	2"	2"	2"
Outlet diameter	inch	2"	2"	2"	2"	2"

Weights

Basic unit	kg	610	640	764	818	898
Unit with single pump	kg	642	672	796	850	930
Unit with double pump	kg	662	692	816	870	950
Unit with tank and single pump	kg	907	937	1061	1115	1350
Unit with tank and double pump	kg	927	957	1081	1135	1370

Dimensions

Length	mm	2100	2100	2100	2100	2760
Width	mm	1110	1110	1110	1110	1110
Height	mm	1850	1850	1850	1850	1850

(1) Indicative value. Always refer to the value specified on the unit's label.

Technical data

CLS HT		402	502	552	602
Power supply	V/ph/Hz	400/3/50			
Number of circuits		2	2	2	2
Number of steps		2	2	3	2
Capacity control steps	%	50/100	50/100	43-57/100	50/100
Refrigerant					
Type		R407C			
Charge (1)	kg	12.0	17.0	18.5	20.0
Compressors					
Type		Scroll	Scroll	Scroll	Scroll
Number		2	2	2	2
Start-up type		Direct			
Evaporator					
Type		Plate type			
Number		2	2	2	2
Water flow rate	l/s	5.2	6.0	6.5	7.1
Pressure drop	kPa	28.9	38.4	47.8	58.2
Minimum water content	l	5.0	5.0	5.0	5.0
Condenser					
Type		Coil type (Al/Cu)			
Hydraulic connections					
Type		Gas threaded male type			
Inlet diameter	inch	2"	2"	2"	2"
Outlet diameter	inch	2"	2"	2"	2"
Weights					
Basic unit	kg	972	1060	1195	1230
Unit with single pump	kg	1004	1092	1227	1262
Unit with double pump	kg	1024	1112	1247	1282
Unit with tank and single pump	kg	1424	1602	1737	1772
Unit with tank and double pump	kg	1444	1622	1757	1792
Dimensions					
Length	mm	2760	3110	3110	3110
Width	mm	1110	1110	1110	1110
Height	mm	1850	1850	1850	1850

(1) Indicative value. Always refer to the value specified on the unit's label.

Technical data

CLC STD-LN-HPF-HT		182	202	242	302	352
Power supply	V/ph/Hz	400/3/50				
Number of circuit		2	2	2	2	2
Number of steps		2	2	2	2	3
Capacity control steps	%	50/100	50/100	50/100	50/100	43-57/100

Compressors

Type		Scroll	Scroll	Scroll	Scroll	Scroll
Number		2	2	2	2	2
Start-up type		Direct				

Condenser

Type		Coil type (Al/Cu)				
------	--	-------------------	--	--	--	--

Refrigerant connections

Type		To be welded				
Liquid diameter	inch	1/2"	1/2"	5/8"	5/8"	5/8"
Suction diameter	inch	7/8"	7/8"	1 5/8"	1 5/8"	1 5/8"

Weights

Shipping weight	kg	578	603	730	776	840
-----------------	----	-----	-----	-----	-----	-----

Dimensions

Length	mm	2100	2100	2100	2100	2760
Width	mm	1110	1110	1110	1110	1110
Height (2)	mm	1850	1850	1850	1850	1850

(1) Indicative value. Always refer to the value specified on the unit's label.

(2) STD Version Height 1750 mm

CLC STD-LN-HPF-HT		402	502	552	602
Power supply	V/ph/Hz	400/3/50			
Number of circuit		2	2	2	2
Number of steps		2	2	3	2
Capacity control steps	%	50/100	50/100	43-57/100	50/100

Compressors

Type		Scroll	Scroll	Scroll	Scroll
Number		2	2	2	2
Start-up type		Direct			

Condenser

Type		Coil type (Al/Cu)			
------	--	-------------------	--	--	--

Refrigerant connections

Type		To be welded			
Liquid diameter	inch	5/8"	5/8"	5/8"	5/8"
Suction diameter	inch	1 5/8"	1 5/8"	1 5/8"	1 5/8"

Weights

Shipping weight	kg	907	995	1131	1167
-----------------	----	-----	-----	------	------

Dimensions

Length	mm	2760	3110	3110	3110
Width	mm	1110	1110	1110	1110
Height (2)	mm	1850	1850	1850	1850

(1) Indicative value. Always refer to the value specified on the unit's label.

(2) STD Version Height 1750 mm

Technical data

CLC ELN		182	202	242	302	352
Power supply	V/ph/Hz	400/3/50				
Number of circuit		2	2	2	2	2
Number of steps		2	2	2	2	3
Capacity control steps	%	50/100	50/100	50/100	50/100	43-57/100

Compressors

Type		Scroll	Scroll	Scroll	Scroll	Scroll
Number		2	2	2	2	2
Start-up type		Direct				

Condenser

Type		Coil type (Al/Cu)				
------	--	-------------------	--	--	--	--

Refrigerant connections

Type		To be welded				
Liquid diameter	inch	1/2"	1/2"	5/8"	5/8"	5/8"
Suction diameter	inch	7/8"	7/8"	1 5/8"	1 5/8"	1 5/8"

Weights

Shipping weight	kg	620	641	772	786	903
-----------------	----	-----	-----	-----	-----	-----

Dimensions

Length	mm	2100	2100	2100	2100	2760
Width	mm	1110	1110	1110	1110	1110
Height	mm	1850	1850	1850	1850	1850

(1) Indicative value. Always refer to the value specified on the unit's label.

CLC ELN		402	502	552	602
Power supply	V/ph/Hz	400/3/50			
Number of circuit		2	2	2	2
Number of steps		2	2	3	2
Capacity control steps	%	50/100	50/100	43-57/100	50/100

Compressors

Type		Scroll	Scroll	Scroll	Scroll
Number		2	2	2	2
Start-up type		Direct			

Condenser

Type		Coil type (Al/Cu)			
------	--	-------------------	--	--	--

Refrigerant connections

Type		To be welded			
Liquid diameter	inch	5/8"	5/8"	5/8"	5/8"
Suction diameter	inch	1 5/8"	1 5/8"	1 5/8"	1 5/8"

Weights

Shipping weight	kg	919	1015	1151	1187
-----------------	----	-----	------	------	------

Dimensions

Length	mm	2760	3110	3110	3110
Width	mm	1110	1110	1110	1110
Height	mm	1850	1850	1850	1850

(1) Indicative value. Always refer to the value specified on the unit's label.

Technical data

CLH STD		182	202	242	302	352
Power supply	V/ph/Hz	400/3/50				
Number of circuits		2	2	2	2	2
Number of steps		2	2	2	2	3
Capacity control steps	%	50/100	50/100	50/100	50/100	43-57/100

Refrigerant

Type		R407C				
Charge (1)	kg	7.0	11.0	13.0	14.5	15.0

Compressors

Type		Scroll	Scroll	Scroll	Scroll	Scroll
Number		2	2	2	2	2
Start-up type		Direct				

Evaporator

Type		Plate type				
Number		2	2	2	2	2
Water flow rate	l/s	1.5	2.6	3.2	3.8	4.2
Pressure drop	kPa	19.9	28.4	30.4	29.5	22.1
Minimum water content	l	3.3	3.9	2.8	3.3	4.4

Condenser

Type		Coil type (Al/Cu)				
------	--	-------------------	--	--	--	--

Hydraulic connections

Type		Gas threaded male type				
Inlet diameter	inch	2"	2"	2"	2"	2"
Outlet diameter	inch	2"	2"	2"	2"	2"

Weights

Basic unit	kg	650	700	860	910	1010
Unit with single pump	kg	682	732	892	942	1042
Unit with double pump	kg	702	752	912	962	1062
Unit with tank and single pump	kg	947	997	1157	1362	1552
Unit with tank and double pump	kg	967	1017	1177	1382	1572

Dimensions

Length	mm	2100	2100	2100	2760	3110
Width	mm	1110	1110	1110	1110	1110
Height	mm	1750	1750	1750	1750	1750

(1) Indicative value. Always refer to the value specified on the unit's label.

Technical data

CLH STD		402	502	552	602
Power supply	V/ph/Hz	400/3/50			
Number of circuits		2	2	2	2
Number of steps		2	2	3	2
Capacity control steps	%	50/100	50/100	43-57/100	50/100
Refrigerant					
Type		R407C			
Charge (1)	kg	17.0	20.0	22.0	24.0
Compressors					
Type		Scroll	Scroll	Scroll	Scroll
Number		2	2	2	2
Start-up type		Direct			
Evaporator					
Type		Plate type			
Number		2	2	2	2
Water flow rate	l/s	4.7	5.3	5.8	6.3
Pressure drop	kPa	23.6	29.5	35.4	41.8
Minimum water content	l	5.0	5.0	5.0	5.0
Condenser					
Type		Coil type (Al/Cu)			
Hydraulic connections					
Type		Gas threaded male type			
Inlet diameter	inch	2"	2"	2"	2"
Outlet diameter	inch	2"	2"	2"	2"
Weights					
Basic unit	kg	1160	1160	1295	1330
Unit with single pump	kg	1192	1192	1327	1362
Unit with double pump	kg	1212	1212	1347	1382
Unit with tank and single pump	kg	1702	1702	1837	1872
Unit with tank and double pump	kg	1722	1722	1857	1892
Dimensions					
Length	mm	3110	3110	3110	3110
Width	mm	1110	1110	1110	1110
Height	mm	1750	1750	1750	1750

(1) Indicative value. Always refer to the value specified on the unit's label.

Technical data

CLH LN		182	202	242	302	352
Power supply	V/ph/Hz	400/3/50				
Number of circuits		2	2	2	2	2
Number of steps		2	2	2	2	3
Capacity control steps	%	50/100	50/100	50/100	50/100	43-57/100

Refrigerant

Type		R407C				
Charge (1)	kg	7.0	11.0	13.0	14.5	15.0

Compressors

Type		Scroll	Scroll	Scroll	Scroll	Scroll
Number		2	2	2	2	2
Start-up type		Direct				

Evaporator

Type		Plate type				
Number		2	2	2	2	2
Water flow rate	l/s	1.8	2.6	3.2	3.8	4.3
Pressure drop	kPa	19.9	28.4	30.4	29.5	22.1
Minimum water content	l	3.3	3.9	2.8	3.3	4.4

Condenser

Type		Coil type (Al/Cu)				
------	--	-------------------	--	--	--	--

Hydraulic connections

Type		Gas threaded male type				
Inlet diameter	inch	2"	2"	2"	2"	2"
Outlet diameter	inch	2"	2"	2"	2"	2"

Weights

Basic unit	kg	650	700	860	910	1010
Unit with single pump	kg	682	732	892	942	1042
Unit with double pump	kg	702	752	912	962	1062
Unit with tank and single pump	kg	947	997	1157	1362	1552
Unit with tank and double pump	kg	967	1017	1177	1382	1572

Dimensions

Length	mm	2100	2100	2100	2760	3110
Width	mm	1110	1110	1110	1110	1110
Height	mm	1850	1850	1850	1850	1850

(1) Indicative value. Always refer to the value specified on the unit's label.

Technical data

CLH LN		402	502	552	602
Power supply	V/ph/Hz	400/3/50			
Number of circuits		2	2	2	2
Number of steps		2	2	3	2
Capacity control steps	%	50/100	50/100	43-57/100	50/100
Refrigerant					
Type		R407C			
Charge (1)	kg	17.0	20.0	22.0	24.0
Compressors					
Type		Scroll	Scroll	Scroll	Scroll
Number		2	2	2	2
Start-up type		Direct			
Evaporator					
Type		Plate type			
Number		2	2	2	2
Water flow rate	l/s	4.8	5.4	5.8	6.3
Pressure drop	kPa	23.6	29.5	35.4	41.8
Minimum water content	l	5.0	5.0	5.0	5.0
Condenser					
Type		Coil type (Al/Cu)			
Hydraulic connections					
Type		Gas threaded male type			
Inlet diameter	inch	2"	2"	2"	2"
Outlet diameter	inch	2"	2"	2"	2"
Weights					
Basic unit	kg	1160	1160	1295	1330
Unit with single pump	kg	1192	1192	1327	1362
Unit with double pump	kg	1212	1212	1347	1382
Unit with tank and single pump	kg	1702	1702	1837	1872
Unit with tank and double pump	kg	1722	1722	1857	1892
Dimensions					
Length	mm	3110	3110	3110	3110
Width	mm	1110	1110	1110	1110
Height	mm	1850	1850	1850	1850

(1) Indicative value. Always refer to the value specified on the unit's label.

Technical data

CLH ELN		182	202	242	302	352
Power supply	V/ph/Hz	400/3/50				
Number of circuits		2	2	2	2	2
Number of steps		2	2	2	2	3
Capacity control steps	%	50/100	50/100	50/100	50/100	43-57/100

Refrigerant

Type		R407C				
Charge 1)	kg	9.0	12.0	15.0	15.0	15.0

Compressors

Type		Scroll	Scroll	Scroll	Scroll	Scroll
Number		2	2	2	2	2
Start-up type		Direct				

Evaporator

Type		Plate type				
Number		2	2	2	2	2
Water flow rate	l/s	2.0	2.6	3.1	3.4	4.2
Pressure drop	kPa	19.9	27.7	27.9	24.4	21.7
Minimum water content	l	3.3	3.9	2.8	3.3	4.4

Condenser

Type		Coil type (Al/Cu)				
------	--	-------------------	--	--	--	--

Hydraulic connections

Type		Gas threaded male type				
Inlet diameter	inch	2"	2"	2"	2"	2"
Outlet diameter	inch	2"	2"	2"	2"	2"

Weights

Basic unit	kg	670	720	910	960	1130
Unit with single pump	kg	702	752	942	992	1162
Unit with double pump	kg	722	772	962	1012	1182
Unit with tank and single pump	kg	967	1017	1362	1412	1672
Unit with tank and double pump	kg	987	1037	1382	1432	1692

Dimensions

Length	mm	2100	2100	2760	2760	3110
Width	mm	1110	1110	1110	1110	1110
Height	mm	1850	1850	1850	1850	1850

(1) Indicative value. Always refer to the value specified on the unit's label.

Technical data

CLH ELN		402	502	552	602
Power supply	V/ph/Hz	400/3/50			
Number of circuits		2	2	2	2
Number of steps		2	2	2	3
Capacity control steps	%	50/100	50/100	43-57/100	50/100
Refrigerant					
Type		R407C			
Charge (1)	kg	17.0	20.0	18.5	20.0
Compressors					
Type		Scroll	Scroll	Scroll	Scroll
Number		2	2	2	2
Start-up type		Direct			
Evaporator					
Type		Plate type			
Number		2	2	2	2
Water flow rate	l/s	4.4	5.0	5.8	6.3
Pressure drop	kPa	21.0	26.3	35.4	41.8
Minimum water content	l	5.0	5.0	5.0	5.0
Condenser					
Type		Coil type (Al/Cu)			
Hydraulic connections					
Type		Gas threaded male type			
Inlet diameter	inch	2"	2"	2"	2"
Outlet diameter	inch	2"	2"	2"	2"
Weights					
Basic unit	kg	1180	1180	1315	1350
Unit with single pump	kg	1212	1212	1347	1382
Unit with double pump	kg	1232	1232	1367	1402
Unit with tank and single pump	kg	1722	1722	1857	1892
Unit with tank and double pump	kg	1742	1742	1877	1912
Dimensions					
Length	mm	3110	3110	3110	3110
Width	mm	1110	1110	1110	1110
Height	mm	1850	1850	1850	1850

(1) Indicative value. Always refer to the value specified on the unit's label.

Technical data

CLH HPF		182	202	242	302	352
Power supply	V/ph/Hz	400/3/50				
Number of circuits		2	2	2	2	2
Number of steps		2	2	2	2	3
Capacity control steps	%	50/100	50/100	50/100	50/100	43-57/100

Refrigerant

Type		R407C				
Charge (1)	kg	9.0	12.0	15.0	15.0	15.0

Compressors

Type		Scroll	Scroll	Scroll	Scroll	Scroll
Number		2	2	2	2	2
Start-up type		Direct				

Evaporator

Type		Plate type				
Number		2	2	2	2	2
Water flow rate	l/s	2.0	2.6	3.2	3.8	4.2
Pressure drop	kPa	19.9	28.4	30.4	29.5	22.1
Minimum water content	l	3.3	3.9	2.8	3.3	4.4

Condenser

Type		Coil type (Al/Cu)				
------	--	-------------------	--	--	--	--

Hydraulic connections

Type		Gas threaded male type				
Inlet diameter	inch	2"	2"	2"	2"	2"
Outlet diameter	inch	2"	2"	2"	2"	2"

Weights

Basic unit	kg	650	700	860	910	1010
Unit with single pump	kg	682	732	892	942	1042
Unit with double pump	kg	702	752	912	962	1062
Unit with tank and single pump	kg	947	997	1157	1362	1552
Unit with tank and double pump	kg	967	1017	1177	1382	1572

Dimensions

Length	mm	2100	2100	2760	2760	3110
Width	mm	1110	1110	1110	1110	1110
Height	mm	1850	1850	1850	1850	1850

(1) Indicative value. Always refer to the value specified on the unit's label.

Technical data

CLH HPF		402	502	552	602
Power supply	V/ph/Hz	400/3/50			
Number of circuits		2	2	2	2
Number of steps		2	2	3	2
Capacity control steps	%	50/100	50/100	43-57/100	50/100
Refrigerant					
Type		R407C			
Charge (1)	kg	17.0	20.0	18.5	20.0
Compressors					
Type		Scroll	Scroll	Scroll	Scroll
Number		2	2	2	2
Start-up type		Direct			
Evaporator					
Type		Plate type			
Number		2	2	2	2
Water flow rate	l/s	4.7	5.3	5.8	6.3
Pressure drop	kPa	23.6	29.5	35.4	41.8
Minimum water content	l	5.0	5.0	5.0	5.0
Condenser					
Type		Coil type (Al/Cu)			
Hydraulic connections					
Type		Gas threaded male type			
Inlet diameter	inch	2"	2"	2"	2"
Outlet diameter	inch	2"	2"	2"	2"
Weights					
Basic unit	kg	1160	1160	1295	1330
Unit with single pump	kg	1192	1192	1327	1362
Unit with double pump	kg	1212	1212	1347	1382
Unit with tank and single pump	kg	1702	1702	1837	1872
Unit with tank and double pump	kg	1722	1722	1857	1892
Dimensions					
Length	mm	3110	3110	3110	3110
Width	mm	1110	1110	1110	1110
Height	mm	1850	1850	1850	1850

(1) Indicative value. Always refer to the value specified on the unit's label.

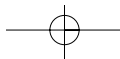

Technical data

8.3 Unit Electrical data

CLS/CLC STD		182	202	242	302	352
Rated voltage	V(%) / ph/Hz	400 ±10% / 3 / 50				
Max. absorbed power	kW	18.8	25.4	30.0	35.6	42.5
Rated current	A	22.2	30.6	41.9	50.5	58.5
Max. current (FLA)	A	32.1	43.3	49.9	59.9	70.3
Max. start-up current (LRA)	A	116.0	149.6	175.9	205.9	246.8
External fuses	(A)	50	63	63	80	100
Max. cable section (1)	mm ²	16	25	25	35	35

CLS STD with pump

CLS STD with pump		182	202	242	302	352
Rated voltage	V(%) / ph/Hz	400 ±10% / 3 / 50				
Max. absorbed power	kW	19.6	26.2	31.5	37.1	44.3
Rated current	A	24.3	32.7	45.7	54.3	63.4
Max. current (FLA)	A	34.2	45.4	53.7	63.7	75.2
Max. start-up current (LRA)	A	118.1	151.6	179.7	209.7	251.7
External fuses	(A)	50	63	63	80	100
Max. cable section (2)	mm ²	16	25	25	35	35

CLS/CLC STD		402	502	552	602
Rated voltage	V(%) / ph/Hz	400 ±10% / 3 / 50			
Max. absorbed power	kW	49.0	59.4	64.7	71.8
Rated current	A	65.6	79.8	81.3	91.2
Max. current (FLA)	A	79.8	97.2	108.8	119.8
Max. start-up current (LRA)	A	256.3	320.0	370.0	381.0
External fuses	(A)	100	125	125	160
Max. cable section (1)	mm ²	35	50	70	70

CLS STD with pump

CLS STD with pump		402	502	552	602
Rated voltage	V(%) / ph/Hz	400 ±10% / 3 / 50			
Max. absorbed power	kW	50.8	61.2	66.5	73.6
Rated current	A	70.5	84.7	86.2	96.1
Max. current (FLA)	A	84.7	102.1	113.7	124.7
Max. start-up current (LRA)	A	261.2	324.9	375.0	386.0
External fuses	(A)	100	125	125	160
Max. cable section (2)	mm ²	35	50	70	70

- (1) The dimensioning of the unit's power cables is the responsibility of the installer, who shall consider: the rating, the maximum working temperature in the room, the type of insulation and the cable laying, the maximum length of the power supply line.
- (2) Data which refer to a single pump.

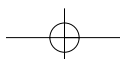

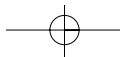

Technical data

Unit Electrical data

CLS/CLC LN-ELN		182	202	242	302	352
Rated voltage	V(%) / ph/Hz	400 ±10% / 3 / 50				
Max. absorbed power	kW	19.3	25.9	30.4	36.0	43.2
Rated current	A	22.6	31.0	42.3	50.9	59.2
Max. current (FLA)	A	32.5	43.7	50.3	60.3	71.0
Max. start-up current (LRA)	A	116.4	150.0	176.3	206.3	247.5
External fuses	(A)	50	63	63	80	100
Max. cable section (1)	mm ²	16	25	25	35	35

CLS LN-ELN with pump

CLS LN-ELN with pump		182	202	242	302	352
Rated voltage	V(%) / ph/Hz	400 ±10% / 3 / 50				
Max. absorbed power	kW	20.1	26.7	31.9	37.5	45.0
Rated current	A	24.7	33.1	46.1	54.7	64.1
Max. current (FLA)	A	34.6	45.8	54.1	64.1	75.9
Max. start-up current (LRA)	A	118.5	152.1	180.1	210.1	252.4
External fuses	(A)	50	63	63	80	100
Max. cable section (2)	mm ²	16	25	25	35	35

CLS/CLC LN-ELN		402	502	552	602
Rated voltage	V(%) / ph/Hz	400 ±10% / 3 / 50			
Max. absorbed power	kW	49.7	60.1	65.4	72.5
Rated current	A	66.3	80.5	82.0	91.9
Max. current (FLA)	A	80.5	97.9	109.5	120.5
Max. start-up current (LRA)	A	257.0	320.7	371.0	382.0
External fuses	(A)	100	125	125	160
Max. cable section (1)	mm ²	35	50	70	70

CLS LN-ELN with pump

CLS LN-ELN with pump		402	502	552	602
Rated voltage	V(%) / ph/Hz	400 ±10% / 3 / 50			
Max. absorbed power	kW	51.5	61.9	67.9	74.3
Rated current	A	71.2	85.4	86.9	96.8
Max. current (FLA)	A	85.4	102.8	114.4	125.4
Max. start-up current (LRA)	A	261.9	325.6	376.0	387.0
External fuses	(A)	100	125	125	160
Max. cable section (2)	mm ²	35	50	70	70

- (1) The dimensioning of the unit's power cables is the responsibility of the installer, who shall consider: the rating, the maximum working temperature in the room, the type of insulation and the cable laying, the maximum length of the power supply line.
 (2) Data which refer to a single pump.

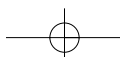

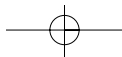

Technical data

Unit Electrical data

CLS/CLC HT-HPF		182	202	242	302	352
Rated voltage	V(%) / ph/Hz	400 ±10% / 3 / 50				
Max. absorbed power	kW	19.8	26.4	31.0	36.6	44.0
Rated current	A	23.7	32.1	43.4	52.0	60.8
Max. current (FLA)	A	33.6	44.8	51.4	61.4	72.6
Max. start-up current (LRA)	A	117.5	151.1	177.4	207.4	248.0
External fuses	(A)	50	63	63	80	100
Max. cable section (1)	mm ²	16	25	25	35	35

CLS HT-HPF with pump

CLS HT-HPF with pump		182	202	242	302	352
Rated voltage	V(%) / ph/Hz	400 ±10% / 3 / 50				
Max. absorbed power	kW	20.6	27.2	32.5	38.1	45.8
Rated current	A	25.8	34.2	47.2	55.8	65.7
Max. current (FLA)	A	35.7	46.9	55.2	65.2	77.5
Max. start-up current (LRA)	A	119.6	153.2	181.2	211.2	254.0
External fuses	(A)	50	63	63	80	100
Max. cable section (2)	mm ²	16	25	25	35	35

CLS/CLC HT-HPF		402	502	552	602
Rated voltage	V(%) / ph/Hz	400 ±10% / 3 / 50			
Max. absorbed power	kW	50.5	60.9	64.7	73.3
Rated current	A	67.9	82.1	83.6	93.5
Max. current (FLA)	A	82.1	99.5	111.1	122.1
Max. start-up current (LRA)	A	258.6	322.3	373.0	384.0
External fuses	(A)	100	125	125	160
Max. cable section (1)	mm ²	35	50	70	70

CLS HT-HPF with pump

CLS HT-HPF with pump		402	502	552	602
Rated voltage	V(%) / ph/Hz	400 ±10% / 3 / 50			
Max. absorbed power	kW	52.3	62.7	66.5	75.1
Rated current	A	72.8	87.0	88.5	98.4
Max. current (FLA)	A	87.0	104.4	116.0	147.0
Max. start-up current (LRA)	A	263.5	327.2	378.0	389.0
External fuses	(A)	100	125	125	160
Max. cable section (2)	mm ²	35	50	70	70

- (1) The dimensioning of the unit's power cables is the responsibility of the installer, who shall consider: the rating, the maximum working temperature in the room, the type of insulation and the cable laying, the maximum length of the power supply line.
 (2) Data which refer to a single pump.

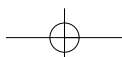

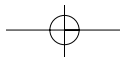

Technical data

Electrical Data Compressors and pumps

Compressors CLS/CLC		182	202	242	302	352
Number		2	2	2	2	2
Absorbed power rating, compr. 1	kW	6	8.5	12	13.7	13.7
Absorbed power rating, compr. 2	kW	6	8.5	12	13.7	18.6
Max. absorbed power, compr. 1	kW	9	12	15	17	17
Max. absorbed power, compr. 2	kW	9	12	15	17	24
Rated current, compressor 1	A	10.1	14.4	20	24.3	24.3
Rated current, compressor 2	A	10.1	14.4	20	24.3	31.4
Max. current (FLA), compressor 1	A	15	21	24	29	29
Max. current (FLA), compressor 2	A	15	21	24	29	38.5
Max. start-up current (LRA) compr. 1	A	99	127	150	175	175
Max. start-up current (LRA) compr. 2	A	99	127	150	175	215
Oil pan resistor, compressor 1	W	70	70	65	75	75
Oil pan resistor, compressor 2	W	70	70	65	75	130

Pump (unit with 1 pump)

Supply voltage	V-ph-Hz	400 / 3 / 50				
Rated power	kW	0.8	0.8	1.1	1.1	1.5
Absorbed rated current	A	1.7	1.7	3.1	3.1	3.8

Pump (unit with 2 pumps)

Supply voltage	V-ph-Hz	400 / 3 / 50				
Rated power (2)	kW	0.8	0.8	1.5	1.5	1.8
Absorbed rated current (2)	A	2.1	2.1	3.8	3.8	4.9

Compressors CLS/CLC		402	502	552	602
Number		2	2	2	2
Absorbed power rating, compr. 1	kW	18.6	23	20.3	25.3
Absorbed power rating, compr. 2	kW	18.6	23	25.3	25.3
Max. absorbed power, compr. 1	kW	24	29	28	35
Max. absorbed power, compr. 2	kW	24	29	35	35
Rated current, compressor 1	A	31.4	38.5	34.3	44.2
Rated current, compressor 2	A	31.4	38.5	44.2	44.2
Max. current (FLA), compressor 1	A	38.5	47	48	59
Max. current (FLA), compressor 2	A	38.5	47	58.5	59
Max. start-up current (LRA) compr. 1	A	215	270	272	320
Max. start-up current (LRA) compr. 2	A	215	270	320	320
Oil pan resistor, compressor 1	W	130	130	150	150
Oil pan resistor, compressor 2	W	130	130	150	150

Pump (unit with 1 pump)

Supply voltage	V-ph-Hz	400 / 3 / 50			
Rated power	kW	1.8	1.8	1.8	1.8
Absorbed rated current	A	4.9	4.9	4.9	4.9

Pump (unit with 2 pumps)

Supply voltage	V-ph-Hz	400 / 3 / 50			
Rated power (2)	kW	1.8	1.8	1.8	1.8
Absorbed rated current (2)	A	4.9	4.9	4.9	4.9

(2) Data which refer to a single pump.

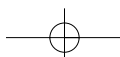

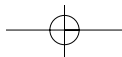

Technical data

Fans Electrical data

Fans CLS/CLC STD		182	202	242	302	352
Power supply	V-ph-Hz	400 ±10% / 3 / 50				
Number	n°	2	2	2	2	3
Rated power per fan	kW	0.48	0.48	0.48	0.48	0.48
Max. absorbed current per fan	A	0.93	0.93	0.93	0.93	0.93

Fans CLS/CLC STD		402	502	552	602
Power supply	V-ph-Hz	400 ±10% / 3 / 50			
Numero	n°	3	3	3	3
Rated power per fan	kW	0.48	0.48	0.48	0.48
Max. absorbed current per fan	A	0.93	0.93	0.93	0.93

Fans CLS/CLC LN/ELN		182	202	242	302	352
Power supply	V-ph-Hz	400 ±10% / 3 / 50				
Number	n°	2	2	2	2	3
Rated power per fan	kW	0.7	0.7	0.7	0.7	0.7
Max. absorbed current per fan	A	1.15	1.15	1.15	1.15	1.15

Fans CLS/CLC LN/ELN		402	502	552	602
Power supply	V-ph-Hz	400 ±10% / 3 / 50			
Numero	n°	3	3	3	3
Rated power per fan	kW	0.7	0.7	0.7	0.7
Max. absorbed current per fan	A	1.15	1.15	1.15	1.15

Fans CLS/CLC HT/HPF		182	202	242	302	352
Power supply	V-ph-Hz	400 ±10% / 3 / 50				
Number	n°	2	2	2	2	3
Rated power per fan	kW	0.98	0.98	0.98	0.98	0.98
Max. absorbed current per fan	A	1.7	1.7	1.7	1.7	1.7

Fans CLS/CLC HT/HPF		402	502	552	602
Power supply	V-ph-Hz	400 ±10% / 3 / 50			
Number	n°	3	3	3	3
Rated power per fan	kW	0.98	0.98	0.98	0.98
Max. absorbed current per fan	A	1.7	1.7	1.7	1.7

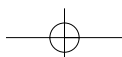

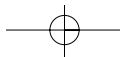

Technical data

Unit Electrical data

CLH STD		182	202	242	302	352
Rated voltage	V(%) / ph/Hz	400 ±10% / 3 / 50				
Max. absorbed power	kW	18.8	25.4	31.0	36.0	42.1
Rated current	A	22.2	30.6	41.9	51.4	51.3
Max. current (FLA)	A	32.1	43.3	49.9	60.8	71.6
Max. start-up current (LRA)	A	116	150	176	207	256
External fuses	(A)	50	63	63	80	100
Max. cable section (1)	mm ²	16	25	25	35	35

CLH STD with pump

	V(%) / ph/Hz	400 ±10% / 3 / 50				
Rated voltage	V(%) / ph/Hz	400 ±10% / 3 / 50				
Max. absorbed power	kW	19.6	26.2	32.5	37.5	43.9
Rated current	A	24.3	32.7	45.7	55.2	56.2
Max. current (FLA)	A	34.2	45.4	53.7	64.6	76.5
Max. start-up current (LRA)	A	118	152	180	211	260
External fuses	(A)	50	63	63	80	100
Max. cable section (2)	mm ²	16	25	25	35	35

CLH STD		402	502	552	602
Rated voltage	V(%) / ph/Hz	400 ±10% / 3 / 50			
Max. absorbed power	kW	49.9	57.6	64.7	71.8
Rated current	A	56.2	66.4	81.3	91.2
Max. current (FLA)	A	84.8	97.8	108.8	119.8
Max. start-up current (LRA)	A	269	322	370	381
External fuses	(A)	100	125	125	160
Max. cable section (1)	mm ²	35	50	70	70

CLH STD with pump

	V(%) / ph/Hz	400 ±10% / 3 / 50			
Rated voltage	V(%) / ph/Hz	400 ±10% / 3 / 50			
Max. absorbed power	kW	51.7	59.4	66.5	73.6
Rated current	A	61.1	71.3	86.2	96.1
Max. current (FLA)	A	89.7	102.7	113.7	124.7
Max. start-up current (LRA)	A	274	327	375	386
External fuses	(A)	100	125	125	160
Max. cable section (2)	mm ²	35	50	70	70

- (1) The dimensioning of the unit's power cables is the responsibility of the installer, who shall consider: the rating, the maximum working temperature in the room, the type of insulation and the cable laying, the maximum length of the power supply line.
 (2) Data which refer to a single pump.

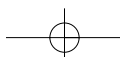

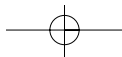

Technical data

Unit Electrical data

CLH LN		182	202	242	302	352
Rated voltage	V(%) / ph/Hz	400 ±10% / 3 / 50				
Max. absorbed power	kW	19.3	25.9	31.4	36.7	42.8
Rated current	A	22.6	31.0	42.3	52.1	52.0
Max. current (FLA)	A	32.5	43.7	50.3	61.5	72.3
Max. start-up current (LRA)	A	116	150	176	207	256
External fuses	(A)	50	63	63	80	100
Max. cable section (1)	mm ²	16	25	25	35	35

CLH LN with pump

	V(%) / ph/Hz	400 ±10% / 3 / 50				
Rated voltage	V(%) / ph/Hz	400 ±10% / 3 / 50				
Max. absorbed power	kW	20.1	26.7	32.9	38.2	44.6
Rated current	A	24.7	33.1	46.1	55.9	56.9
Max. current (FLA)	A	34.6	45.8	54.1	65.3	77.2
Max. start-up current (LRA)	A	119	152	180	211	261
External fuses	(A)	50	63	63	80	100
Max. cable section (2)	mm ²	16	25	25	35	35

CLH LN		402	502	552	602
Rated voltage	V(%) / ph/Hz	400 ±10% / 3 / 50			
Max. absorbed power	kW	50.6	58.3	65.4	72.5
Rated current	A	56.9	67.0	82.0	91.9
Max. current (FLA)	A	85.5	98.5	109.5	120.5
Max. start-up current (LRA)	A	269	323	371	382
External fuses	(A)	100	125	125	160
Max. cable section (1)	mm ²	35	50	70	70

CLH LN with pump

	V(%) / ph/Hz	400 ±10% / 3 / 50			
Rated voltage	V(%) / ph/Hz	400 ±10% / 3 / 50			
Max. absorbed power	kW	52.4	60.1	67.2	74.3
Rated current	A	61.8	71.9	86.9	96.8
Max. current (FLA)	A	90.4	103.4	114.4	125.4
Max. start-up current (LRA)	A	274	328	376	387
External fuses	(A)	100	125	125	160
Max. cable section (2)	mm ²	35	50	70	70

- (1) The dimensioning of the unit's power cables is the responsibility of the installer, who shall consider: the rating, the maximum working temperature in the room, the type of insulation and the cable laying, the maximum length of the power supply line.
 (2) Data which refer to a single pump.

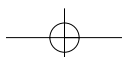

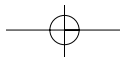

Technical data

Unit Electrical data

CLH ELN		182	202	242	302	352
Rated voltage	V(%) / ph/Hz	400 ±10% / 3 / 50				
Max. absorbed power	kW	19.3	25.9	32.1	36.7	42.8
Rated current	A	22.6	31.0	43.5	52.1	52.0
Max. current (FLA)	A	32.5	43.7	51.5	61.5	72.3
Max. start-up current (LRA)	A	116	150	177	207	256
External fuses	(A)	50	63	63	80	100
Max. cable section (1)	mm ²	16	25	25	35	35

CLH ELN with pump

	V(%) / ph/Hz	400 ±10% / 3 / 50				
Rated voltage	V(%) / ph/Hz	400 ±10% / 3 / 50				
Max. absorbed power	kW	20.1	26.7	33.6	38.2	44.6
Rated current	A	24.7	33.1	47.3	55.9	56.9
Max. current (FLA)	A	34.6	45.8	55.3	65.3	77.2
Max. start-up current (LRA)	A	119	152	181	211	261
External fuses	(A)	50	63	63	80	100
Max. cable section (2)	mm ²	16	25	25	35	35

CLH ELN		402	502	552	602
Rated voltage	V(%) / ph/Hz	400 ±10% / 3 / 50			
Max. absorbed power	kW	50.6	58.3	65.4	72.5
Rated current	A	56.9	67.0	82.0	91.9
Max. current (FLA)	A	85.5	98.5	109.5	120.5
Max. start-up current (LRA)	A	269	323	371	382
External fuses	(A)	100	125	125	160
Max. cable section (1)	mm ²	35	50	70	70

CLH ELN with pump

	V(%) / ph/Hz	400 ±10% / 3 / 50			
Rated voltage	V(%) / ph/Hz	400 ±10% / 3 / 50			
Max. absorbed power	kW	52.4	60.1	67.2	74.3
Rated current	A	61.8	71.9	86.9	96.8
Max. current (FLA)	A	90.4	103.4	114.4	125.4
Max. start-up current (LRA)	A	274	328	376	387
External fuses	(A)	100	125	125	160
Max. cable section (2)	mm ²	35	50	70	70

- (1) The dimensioning of the unit's power cables is the responsibility of the installer, who shall consider: the rating, the maximum working temperature in the room, the type of insulation and the cable laying, the maximum length of the power supply line.
 (2) Data which refer to a single pump.

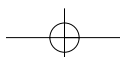

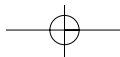

Technical data

Unit Electrical data

CLH HPF		182	202	242	302	352
Rated voltage	V(%) / ph/Hz	400 ±10% / 3 / 50				
Max. absorbed power	kW	19.8	26.4	32.0	37.5	43.6
Rated current	A	23.7	32.1	43.4	53.7	53.6
Max. current (FLA)	A	33.6	44.8	51.4	63.1	73.9
Max. start-up current (LRA)	A	118	151	177	209	258
External fuses	(A)	50	63	63	80	100
Max. cable section (1)	mm ²	16	25	25	35	35

CLH HPF with pump

CLH HPF with pump		182	202	242	302	352
Rated voltage	V(%) / ph/Hz	400 ±10% / 3 / 50				
Max. absorbed power	kW	20.6	27.2	33.5	39.0	45.4
Rated current	A	25.8	34.2	47.2	57.5	58.5
Max. current (FLA)	A	35.7	46.9	55.2	66.9	78.8
Max. start-up current (LRA)	A	120	153	181	213	263
External fuses	(A)	50	63	63	80	100
Max. cable section (2)	mm ²	16	25	25	35	35

CLH HPF		402	502	552	602
Rated voltage	V(%) / ph/Hz	400 ±10% / 3 / 50			
Max. absorbed power	kW	51.4	59.1	66.2	73.3
Rated current	A	58.5	73.8	83.6	93.5
Max. current (FLA)	A	87.1	100.1	111.1	122.1
Max. start-up current (LRA)	A	271	325	373	384
External fuses	(A)	100	125	125	160
Max. cable section (1)	mm ²	35	50	70	70

CLH HPF with pump

CLH HPF with pump		402	502	552	602
Rated voltage	V(%) / ph/Hz	400 ±10% / 3 / 50			
Max. absorbed power	kW	53.2	60.9	68.0	75.1
Rated current	A	63.4	78.7	88.5	98.4
Max. current (FLA)	A	92.0	105.0	116.0	127.0
Max. start-up current (LRA)	A	276	330	378	389
External fuses	(A)	100	125	125	160
Max. cable section (2)	mm ²	35	50	70	70

- (1) The dimensioning of the unit's power cables is the responsibility of the installer, who shall consider: the rating, the maximum working temperature in the room, the type of insulation and the cable laying, the maximum length of the power supply line.
 (2) Data which refer to a single pump.

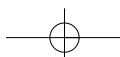

Technical data

Electrical Data Compressors and pumps

Compressors CLH		182	202	242	302	352
Number		2	2	2	2	2
Absorbed power rating, compr. 1	kW	6	8.5	12	13.7	12.9
Absorbed power rating, compr. 2	kW	6	8.5	12	13.7	15.8
Max. absorbed power, compr. 1	kW	9	12	15	17	16
Max. absorbed power, compr. 2	kW	9	12	15	17	24
Rated current, compressor 1	A	10.1	14.4	20	24.3	21.8
Rated current, compressor 2	A	10.1	14.4	20	24.3	26.7
Max. current (FLA), compressor 1	A	15	21	24	29	28
Max. current (FLA), compressor 2	A	15	21	24	29	41
Max. start-up current (LRA) compr. 1	A	99	127	150	175	198
Max. start-up current (LRA) compr. 2	A	99	127	150	175	225
Oil pan resistor, compressor 1	W	70	70	65	75	70
Oil pan resistor, compressor 2	W	70	70	65	75	120

Pump (unit with 1 pump)

Supply voltage	V-ph-Hz	400 / 3 / 50				
Rated power	kW	0.8	0.8	1.1	1.1	1.5
Absorbed rated current	A	1.7	1.7	3.1	3.1	3.8

Pump (unit with 2 pumps)

Supply voltage	V-ph-Hz	400 / 3 / 50				
Rated power (2)	kW	0.8	0.8	1.5	1.5	1.8
Absorbed rated current (2)	A	2.1	2.1	3.8	3.8	4.9

Compressors CLH		402	502	552	602
Number		2	2	2	2
Absorbed power rating, compr. 1	kW	15.8	18.8	20.3	25.3
Absorbed power rating, compr. 2	kW	15.8	18.8	25.3	25.3
Max. absorbed power, compr. 1	kW	24	28	28	35
Max. absorbed power, compr. 2	kW	24	28	35	35
Rated current, compressor 1	A	26.7	31.8	34.3	44.2
Rated current, compressor 2	A	26.7	31.8	44.2	44.2
Max. current (FLA), compressor 1	A	41	48	48	59
Max. current (FLA), compressor 2	A	41	48	58.5	59
Max. start-up current (LRA) compr. 1	A	225	272	272	320
Max. start-up current (LRA) compr. 2	A	225	272	320	320
Oil pan resistor, compressor 1	W	120	150	150	150
Oil pan resistor, compressor 2	W	120	150	150	150

Pump (unit with 1 pump)

Supply voltage	V-ph-Hz	400 / 3 / 50			
Rated power	kW	1.8	1.8	1.8	1.8
Absorbed rated current	A	4.9	4.9	4.9	4.9

Pump (unit with 2 pumps)

Supply voltage	V-ph-Hz	400 / 3 / 50			
Rated power (2)	kW	1.8	1.8	1.8	1.8
Absorbed rated current (2)	A	4.9	4.9	4.9	4.9

2) Data which refer to a single pump.

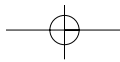

Technical data

Fans Electrical data

Fans CLH STD		182	202	242	302	352
Power supply	V-ph-Hz	400 ±10% / 3 / 50				
Number	n°	2	2	2	3	3
Rated power per fan	kW	0.48	0.48	0.48	0.48	0.48
Max. absorbed current per fan	A	0.93	0.93	0.93	0.93	0.93

Fans CLH STD		402	502	552	602
Power supply	V-ph-Hz	400 ±10% / 3 / 50			
Number	n°	3	3	3	3
Rated power per fan	kW	0.48	0.48	0.48	0.48
Max. absorbed current per fan	A	0.93	0.93	0.93	0.93

Fans CLH LN/ELN		182	202	242	302	352
Power supply	V-ph-Hz	400 ±10% / 3 / 50				
Number LN/ELN	n°	2	2	2/3	3	3
Rated power per fan	kW	0.7	0.7	0.7	0.7	0.7
Max. absorbed current per fan	A	1.15	1.15	1.15	1.15	1.15

Fans CLH LN/ELN		402	502	552	602
Power supply	V-ph-Hz	400 ±10% / 3 / 50			
Number	n°	3	3	3	3
Rated power per fan	kW	0.7	0.7	0.7	0.7
Max. absorbed current per fan	A	1.15	1.15	1.15	1.15

Fans CLH HPF		182	202	242	302	352
Power supply	V-ph-Hz	400 ±10% / 3 / 50				
Number	n°	2	2	2	3	3
Rated power per fan	kW	0.98	0.98	0.98	0.98	0.98
Max. absorbed current per fan	A	1.7	1.7	1.7	1.7	1.7

Fans CLH HPF		402	502	552	602
Power supply	V-ph-Hz	400 ±10% / 3 / 50			
Number	n°	3	3	3	3
Rated power per fan	kW	0.98	0.98	0.98	0.98
Max. absorbed current per fan	A	1.7	1.7	1.7	1.7

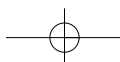

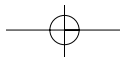

Technical data

CLH with additional resistances

CLH HE Option 0		182	202	242	302	352	402	502
Rated voltage	V(%) / ph/Hz	400 ±10% / 3 / 50						
Additional resistances	kW	24	24	32	32	32	48	48
Max. absorbed power	kW	43.6	50.2	64.5	69.5	75.9	99.7	107.4
Rated current	A	58.9	67.3	91.9	101.4	102.4	130.3	140.5
Max. current (FLA)	A	68.8	80.0	99.9	110.8	122.7	158.9	171.9
Max. start-up current (LRA)	A	153	186	226	257	307	343	396

CLH HE Option 1		182	202	242	302	352	402	502
Rated voltage	V(%) / ph/Hz	400 ±10% / 3 / 50						
Additional resistances	kW	32	32	48	48	48	56	56
Max. absorbed power	kW	51.6	58.2	80.5	85.5	91.9	107.7	115.4
Rated current	A	70.5	78.9	114.9	124.4	125.4	141.9	152.1
Max. current (FLA)	A	80.4	91.6	122.9	133.8	145.7	170.5	183.5
Max. start-up current (LRA)	A	164	198	249	280	330	354	408

CLH HE Option 2		182	202	242	302	352	402	502
Rated voltage	V(%) / ph/Hz	400 ±10% / 3 / 50						
Additional resistances	kW	48	48	56	56	56	64	64
Max. absorbed power	kW	67.6	74.2	88.5	93.5	99.9	115.7	123.4
Rated current	A	93.5	101.9	126.5	136.0	137.0	153.5	163.7
Max. current (FLA)	A	103.4	114.6	134.5	145.4	157.3	182.1	195.1
Max. start-up current (LRA)	A	187	221	260	291	341	366	420

CLH EH Resistors		6 kW	12 kW	16 kW
Power	kW	6	12	16
Current	A	8.7	17.3	23.1

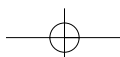

Technical data

8.4 Position of shock absorbers and weight distribution on supports

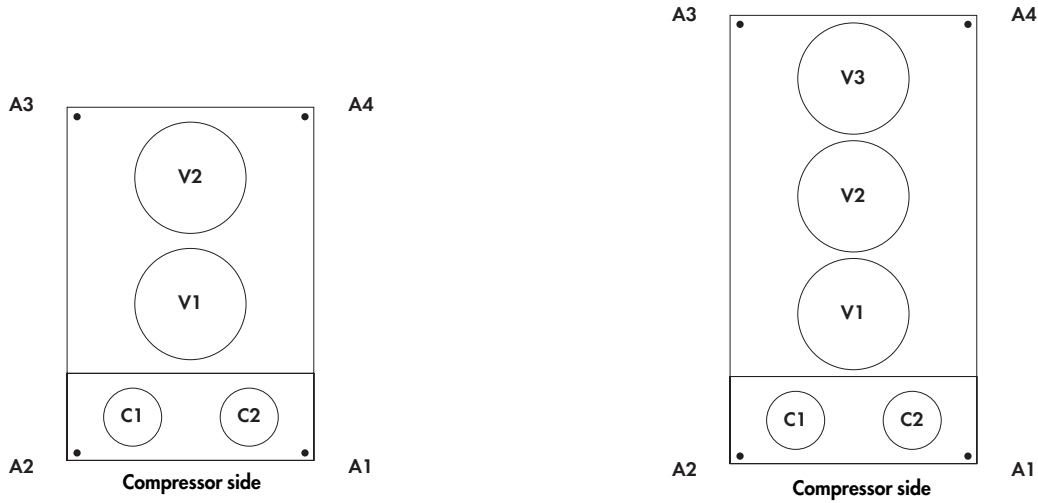

(For the support position, see paragraph 8.5).

BASIC UNIT					
CLS	Weight (kg)	Support 1 (A1)	Support 2 (A2)	Support 3 (A3)	Support 4 (A4)
182 STD/LN/HPF/HT	610	211	196	94	109
202 STD/LN/HPF/HT	640	225	208	95	112
242 STD/LN/HPF/HT	764	271	254	111	128
302 STD/LN/HPF/HT	818	284	267	125	142
352 STD/LN/HPF/HT	898	317	297	132	152
402 STD/LN/HPF/HT	972	336	317	150	169
502 STD/LN/HPF/HT	1060	367	346	163	184
552 STD/LN/HPF/HT	1195	414	390	184	207
602 STD/LN/HPF/HT	1230	426	401	189	214
182 ELN	652	220	204	106	122
202 ELN	678	231	215	108	124
242 ELN	806	279	263	124	140
302 ELN	828	288	270	126	144
352 ELN	960	330	311	150	169
402 ELN	984	340	320	152	172
502 ELN	1080	374	351	166	189
552 ELN	1215	420	395	187	212
602 ELN	1250	432	407	193	218

UNIT WITH 2 PUMPS					
CLS	Weight (kg)	Support 1 (A1)	Support 2 (A2)	Support 3 (A3)	Support 4 (A4)
182 STD/LN/HPF/HT	642	223	207	98	114
202 STD/LN/HPF/HT	672	236	219	100	117
242 STD/LN/HPF/HT	796	282	265	116	133
302 STD/LN/HPF/HT	850	296	278	129	147
352 STD/LN/HPF/HT	930	328	308	137	157
402 STD/LN/HPF/HT	1004	348	328	154	174
502 STD/LN/HPF/HT	1092	378	356	168	190
552 STD/LN/HPF/HT	1227	425	400	189	213
602 STD/LN/HPF/HT	1262	437	412	194	219
182 ELN	684	231	214	111	128
202 ELN	710	242	225	113	130
242 ELN	838	291	274	128	145
302 ELN	860	299	281	131	149
352 ELN	992	341	322	155	174
402 ELN	1016	352	331	156	177
502 ELN	1112	385	362	171	194
552 ELN	1247	431	406	192	218
602 ELN	1282	444	417	197	224

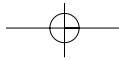

Technical data

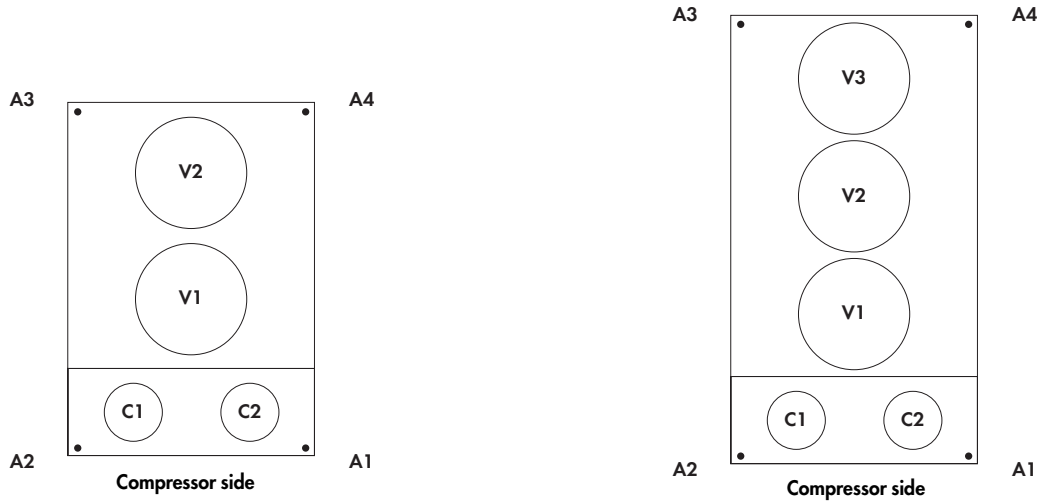

(For the support position, see paragraph 8.5).

UNIT WITH 2 PUMPS					
CLS	Weight (kg)	Support 1 (A1)	Support 2 (A2)	Support 3 (A3)	Support 4 (A4)
182 STD/LN/HPF/HT	662	229	213	102	118
202 STD/LN/HPF/HT	692	243	225	103	121
242 STD/LN/HPF/HT	816	289	272	119	136
302 STD/LN/HPF/HT	870	303	284	132	151
352 STD/LN/HPF/HT	950	335	315	140	160
402 STD/LN/HPF/HT	1024	354	334	158	178
502 STD/LN/HPF/HT	1112	385	363	171	193
552 STD/LN/HPF/HT	1247	432	407	192	216
602 STD/LN/HPF/HT	1282	444	418	197	223
182 ELN	704	238	220	114	132
202 ELN	730	249	232	116	133
242 ELN	858	297	280	132	149
302 ELN	880	306	287	134	153
352 ELN	1012	348	328	158	178
402 ELN	1036	358	337	160	181
502 ELN	1132	392	368	174	198
552 ELN	1267	438	412	195	221
602 ELN	1302	450	424	201	227

UNIT WITH 1 PUMPS AND 1 TANK					
CLS	Weight (kg)	Support 1 (A1)	Support 2 (A2)	Support 3 (A3)	Support 4 (A4)
182 STD/LN/HPF/HT	907	314	292	139	162
202 STD/LN/HPF/HT	937	329	305	140	164
242 STD/LN/HPF/HT	1061	376	353	155	177
302 STD/LN/HPF/HT	1115	388	364	170	193
352 STD/LN/HPF/HT	1350	476	447	199	228
402 STD/LN/HPF/HT	1424	493	465	219	247
502 STD/LN/HPF/HT	1602	555	523	246	278
552 STD/LN/HPF/HT	1737	601	567	267	302
602 STD/LN/HPF/HT	1772	613	578	273	308
182 ELN	949	321	297	154	177
202 ELN	975	333	309	155	178
242 ELN	1103	382	360	169	191
302 ELN	1125	391	367	172	195
352 ELN	1412	486	458	220	248
402 ELN	1436	497	467	221	251
502 ELN	1622	561	528	250	283
552 ELN	1757	608	572	271	307
602 ELN	1792	620	583	276	313

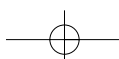

Technical data

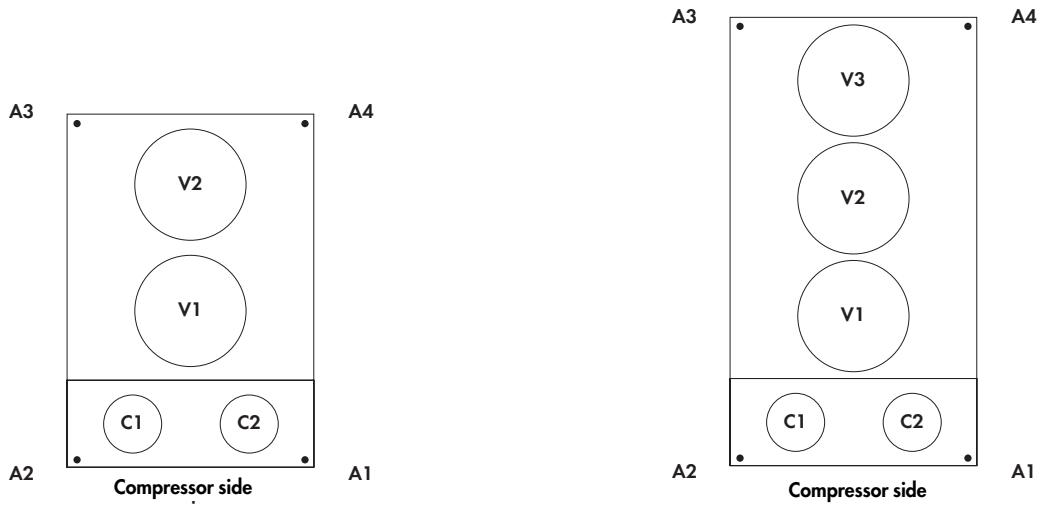

(For the support position, see paragraph 8.5).

UNIT WITH 2 PUMPS AND 1 TANK					
CLS	Weight (kg)	Support 1 (A1)	Support 2 (A2)	Support 3 (A3)	Support 4 (A4)
182 STD/LN/HPF/HT	927	321	298	142	165
202 STD/LN/HPF/HT	957	336	311	143	167
242 STD/LN/HPF/HT	1081	383	360	158	181
302 STD/LN/HPF/HT	1135	395	371	173	197
352 STD/LN/HPF/HT	1370	483	454	202	231
402 STD/LN/HPF/HT	1444	500	471	222	251
502 STD/LN/HPF/HT	1622	561	529	250	282
552 STD/LN/HPF/HT	1757	608	573	270	305
602 STD/LN/HPF/HT	1792	620	585	276	311
182 ELN	969	328	303	157	181
202 ELN	995	340	316	158	182
242 ELN	1123	389	367	172	195
302 ELN	1145	398	374	175	199
352 ELN	1432	493	464	223	252
402 ELN	1456	504	474	224	254
502 ELN	1642	568	534	253	287
552 ELN	1777	615	578	274	310
602 ELN	1812	627	590	279	316

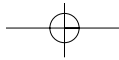

Technical data

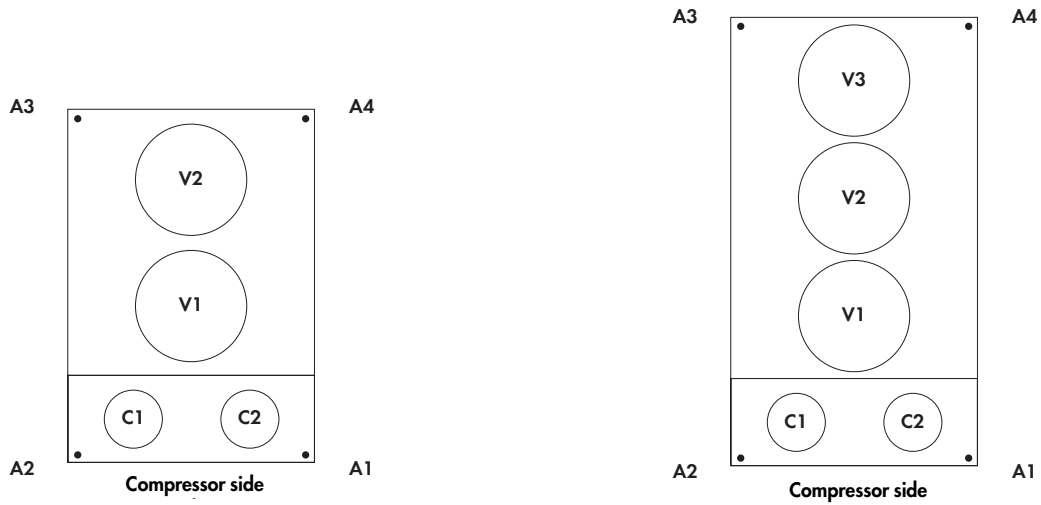

(For the support position, see paragraph 8.5.)

CLC	Weight (kg)	Support 1 (A1)	Support 2 (A2)	Support 3 (A3)	Support 4 (A4)
182 STD/LN/HPF/HT	578	200	186	89	103
202 STD/LN/HPF/HT	603	212	196	90	105
242 STD/LN/HPF/HT	730	258	243	106	122
302 STD/LN/HPF/HT	776	270	254	118	134
352 STD/LN/HPF/HT	841	296	278	124	142
402 STD/LN/HPF/HT	907	314	296	139	157
502 STD/LN/HPF/HT	995	344	325	153	173
552 STD/LN/HPF/HT	1131	391	369	174	196
602 STD/LN/HPF/HT	1167	404	381	179	203
182 ELN	620	210	194	100	116
202 ELN	641	219	203	102	117
242 ELN	772	268	252	118	134
302 ELN	786	273	257	120	136
352 ELN	903	311	293	141	159
402 ELN	919	318	299	141	160
502 ELN	1015	351	330	156	177
552 ELN	1151	398	375	177	201
602 ELN	1187	411	386	183	207

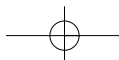

Technical data

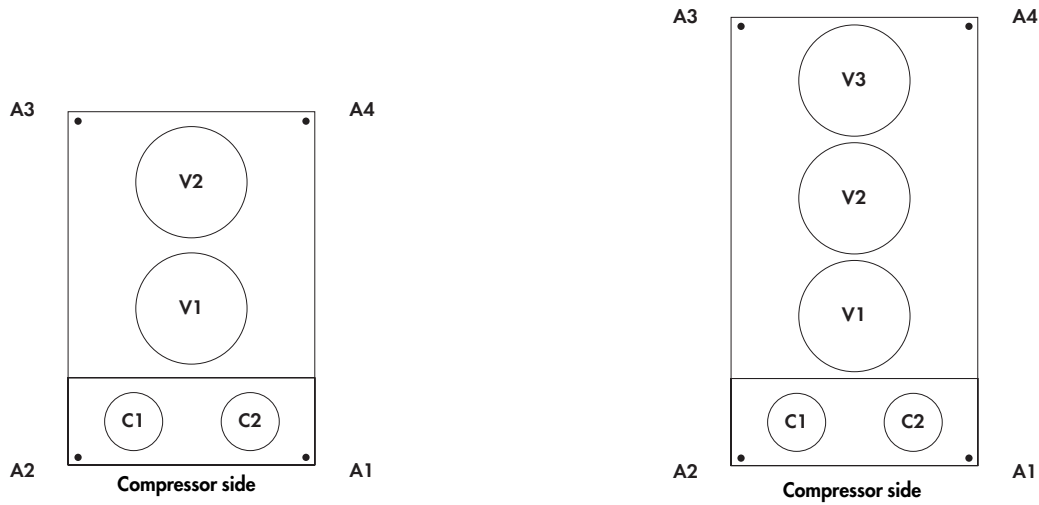

(For the support position, see paragraph 8.5).

BASIC UNIT					
CLH	Weight (kg)	Support 1 (A1)	Support 2 (A2)	Support 3 (A3)	Support 4 (A4)
182 STD/LN/HPF	650	224	209	101	116
202 STD/LN/HPF	700	238	223	112	127
242 STD/LN/HPF	860	296	280	134	150
302 STD/LN/HPF	910	317	300	138	155
352 STD/LN/HPF	1010	355	336	150	169
402 STD/LN/HPF	1160	401	379	179	201
502 STD/LN/HPF	1160	401	379	179	201
552 STD/LN/HPF	1295	447	423	200	224
602 STD/LN/HPF	1330	459	435	206	230
182 ELN	670	225	211	110	124
202 ELN	720	239	224	121	136
242 ELN	910	298	283	157	172
302 ELN	960	327	311	153	169
352 ELN	1130	388	367	177	198
402 ELN	1180	407	385	183	205
502 ELN	1180	407	385	183	205
552 ELN	1315	453	429	204	228
602 ELN	1350	465	441	210	234

UNIT WITH 1 PUMP					
CLH	Weight (kg)	Support 1 (A1)	Support 2 (A2)	Support 3 (A3)	Support 4 (A4)
182 STD/LN/HPF	682	236	220	105	121
202 STD/LN/HPF	732	249	233	117	133
242 STD/LN/HPF	892	307	291	139	155
302 STD/LN/HPF	942	328	311	143	160
352 STD/LN/HPF	1042	367	347	154	174
402 STD/LN/HPF	1192	412	390	184	206
502 STD/LN/HPF	1192	412	390	184	206
552 STD/LN/HPF	1327	458	434	205	230
602 STD/LN/HPF	1362	470	445	211	236
182 ELN	702	236	221	115	130
202 ELN	752	249	234	127	142
242 ELN	942	309	292	162	179
302 ELN	992	338	321	158	175
352 ELN	1162	399	378	182	203
402 ELN	1212	418	396	188	210
502 ELN	1212	418	396	188	210
552 ELN	1347	464	440	209	234
602 ELN	1382	476	451	215	240

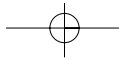

Technical data

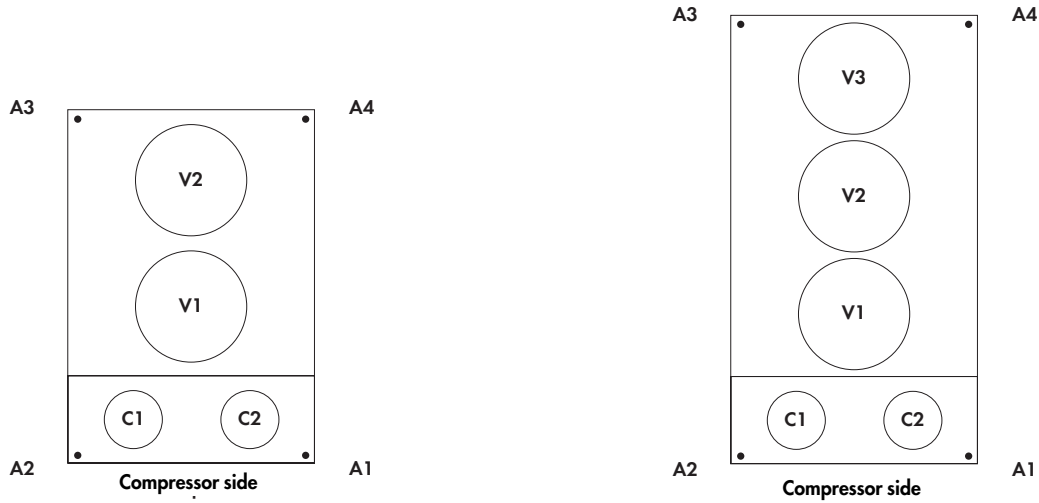

(For the support position, see paragraph 8.5).

UNIT WITH 2 PUMPS					
CLH	Weight (kg)	Support 1 (A1)	Support 2 (A2)	Support 3 (A3)	Support 4 (A4)
182 STD/LN/HPF	702	242	226	109	125
202 STD/LN/HPF	752	255	239	121	137
242 STD/LN/HPF	912	314	297	143	159
302 STD/LN/HPF	962	335	317	146	164
352 STD/LN/HPF	1062	374	353	157	178
402 STD/LN/HPF	1212	419	396	187	210
502 STD/LN/HPF	1212	419	396	187	210
552 STD/LN/HPF	1347	465	440	208	233
602 STD/LN/HPF	1382	477	452	214	239
182 ELN	722	243	227	118	134
202 ELN	772	256	240	130	146
242 ELN	962	315	299	166	182
302 ELN	1012	344	327	162	179
352 ELN	1182	405	384	186	207
402 ELN	1232	425	402	191	214
502 ELN	1232	425	402	191	214
552 ELN	1367	471	446	212	237
602 ELN	1402	483	458	218	243

UNIT WITH 1 PUMP AND 1 TANK					
CLH	Weight (kg)	Support 1 (A1)	Support 2 (A2)	Support 3 (A3)	Support 4 (A4)
182 STD/LN/HPF	947	327	305	146	169
202 STD/LN/HPF	997	339	317	160	181
242 STD/LN/HPF	1157	398	377	181	202
302 STD/LN/HPF	1362	474	449	207	232
352 STD/LN/HPF	1552	546	516	230	260
402 STD/LN/HPF	1702	588	556	263	295
502 STD/LN/HPF	1702	588	556	263	295
552 STD/LN/HPF	1837	634	600	284	318
602 STD/LN/HPF	1872	647	612	289	324
182 ELN	967	325	304	158	180
202 ELN	1017	337	317	171	192
242 ELN	1362	446	423	235	258
302 ELN	1412	481	457	225	249
352 ELN	1672	574	544	262	292
402 ELN	1722	593	562	268	299
502 ELN	1722	593	562	268	299
552 ELN	1857	640	606	289	323
602 ELN	1892	652	617	294	329

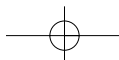

Technical data

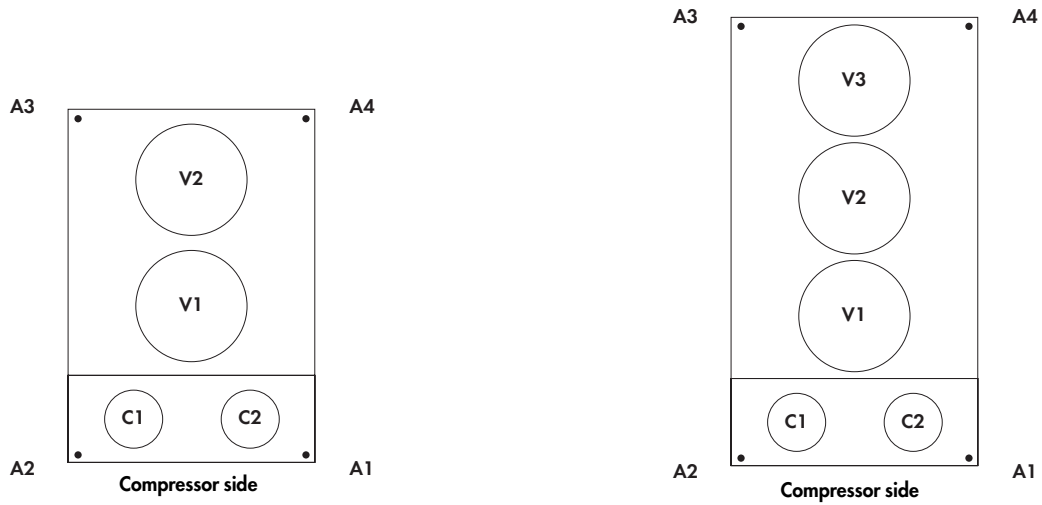

(For the support position, see paragraph 8.5).

UNIT WITH 2 PUMP AND 1 TANK					
CLH	Weight (kg)	Support 1 (A1)	Support 2 (A2)	Support 3 (A3)	Support 4 (A4)
182 STD/LN/HPF	967	334	311	150	172
202 STD/LN/HPF	1017	345	323	163	185
242 STD/LN/HPF	1177	405	383	184	205
302 STD/LN/HPF	1382	481	456	210	235
352 STD/LN/HPF	1572	553	523	233	263
402 STD/LN/HPF	1722	595	563	266	298
502 STD/LN/HPF	1722	595	563	266	298
552 STD/LN/HPF	1857	641	607	287	322
602 STD/LN/HPF	1892	653	618	293	328
182 ELN	987	332	310	162	183
202 ELN	1037	344	323	175	196
242 ELN	1382	453	429	238	262
302 ELN	1432	487	463	229	253
352 ELN	1692	580	550	266	296
402 ELN	1742	600	568	271	303
502 ELN	1742	600	568	271	303
552 ELN	1877	647	613	292	326
602 ELN	1912	659	624	297	332

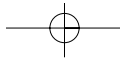

Technical data

8.5 Overall dimensions

CLS 182-302 STD-LN-ELN-HT-HPF

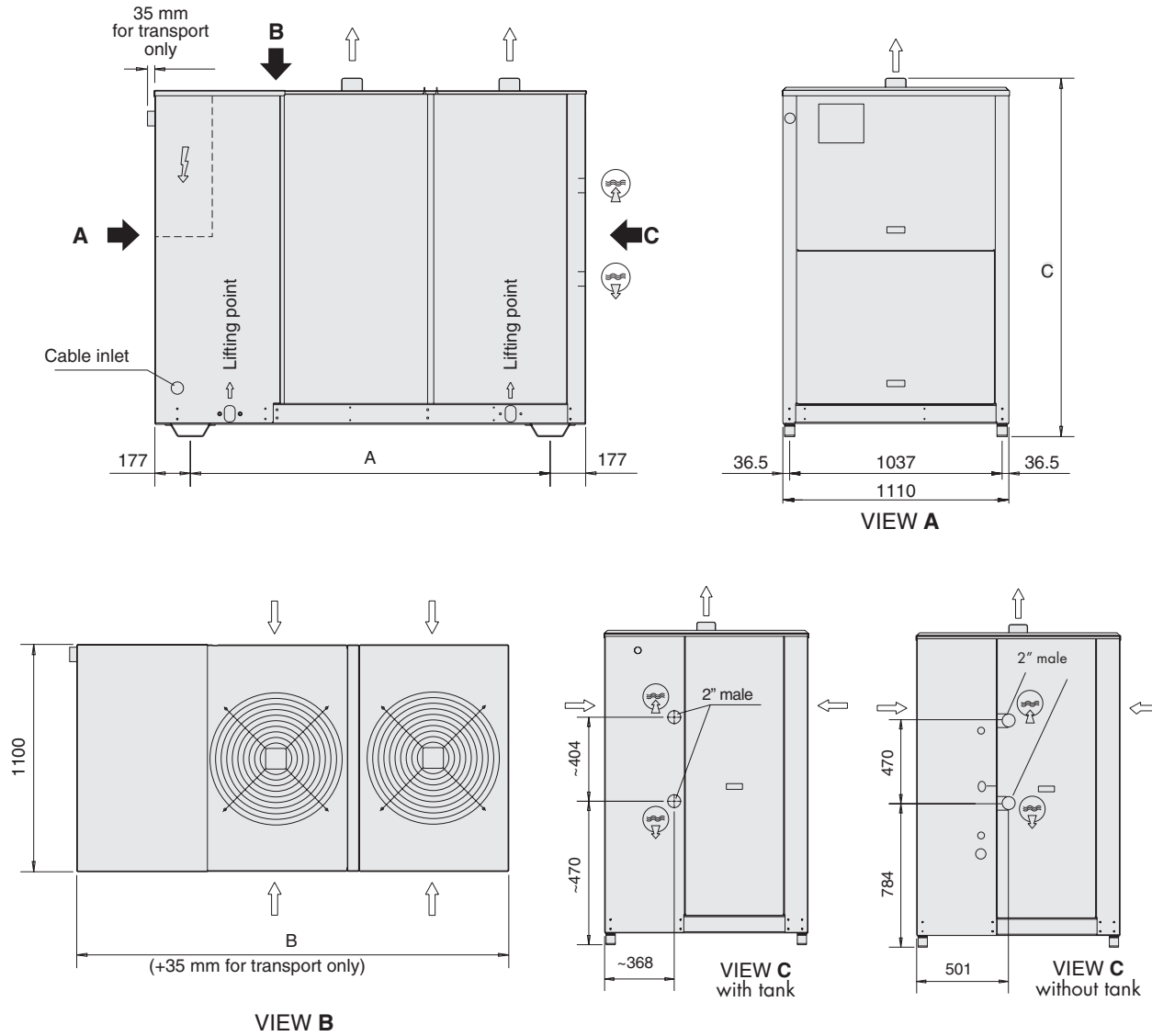

Models	Versions	Dimensions A (mm)	Dimensions B (mm)	Dimensions C (mm)
CLS 182-202-242-302	STD	1756	2110	1750
	LN/ELN/HT/HPF	1756	2110	1850

Note: Do not extract dimensions if not specified in the drawings.

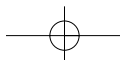

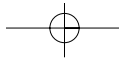

Technical data

CLS 352-602 STD-LN-ELN-HT-HPF

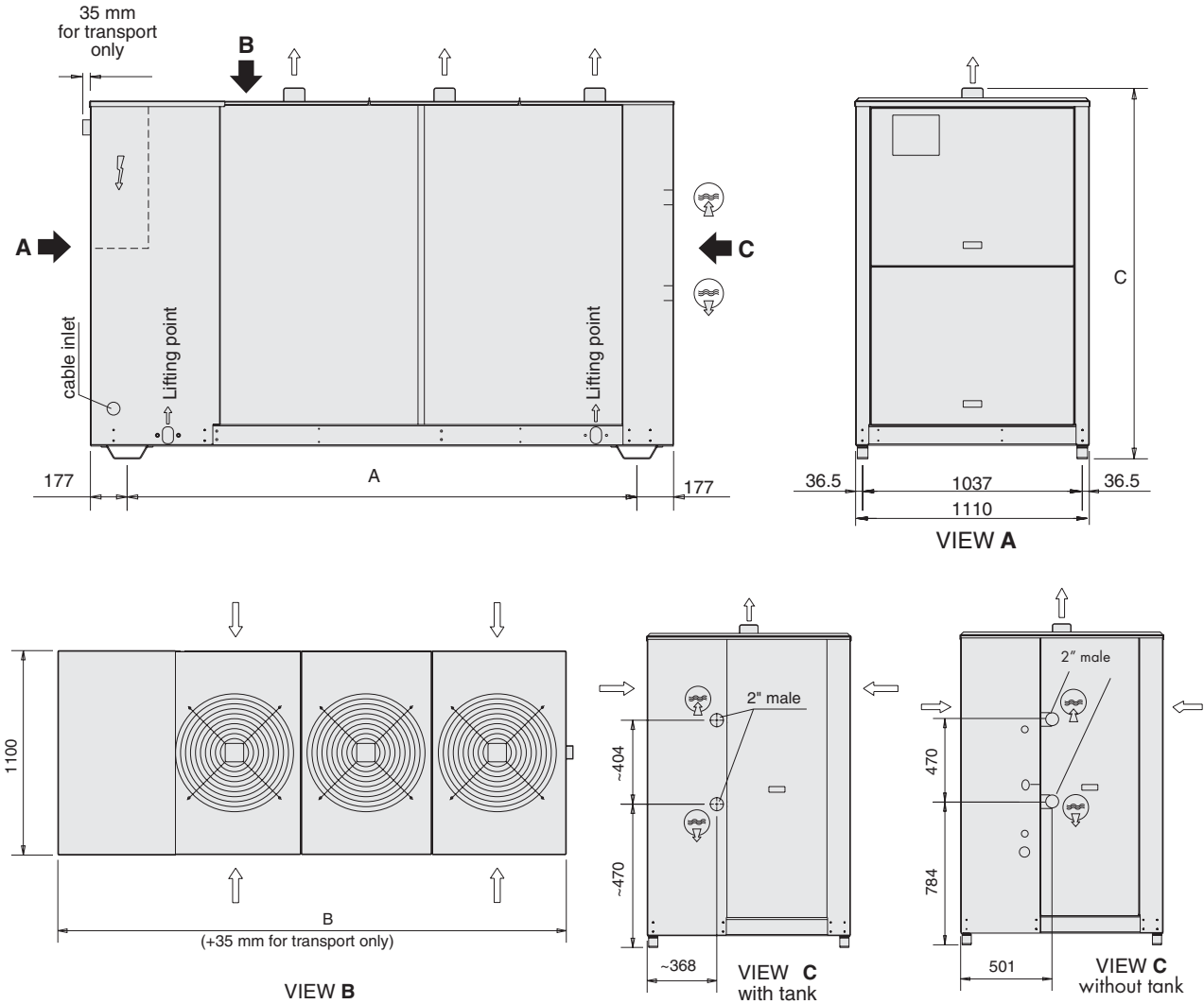

Models	Versions	Dimensions A (mm)	Dimensions B (mm)	Dimensions C (mm)
CLS 352-402	STD	2406	2760	1750
	LN/ELN/HT/HPF	2406	2760	1850
CLS 502-552-602	STD	2756	3110	1750
	LN/ELN/HT/HPF	2756	3110	1850

Note: Do not extract dimensions if not specified in the drawings.

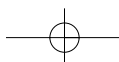

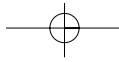

Technical data

CLC 182-602 STD-LN-ELN-HT-HPF

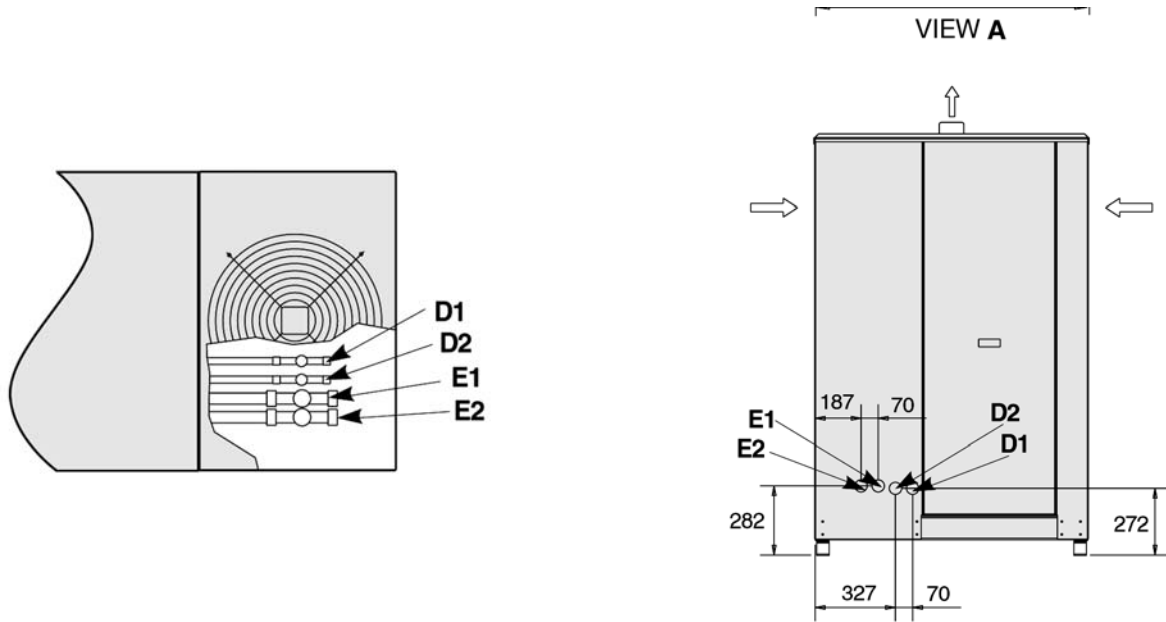

D1 - D2 = Liquid line
 E1 - E2 = Suction line

CLC	D1-D2	E1-E2
182-202	1/2"	7/8"
242-602	5/8"	1 5/8"

Note:

Back view shows the refrigerant attacks. For the other dimensions to reference to CLS units.
 The refrigerant connections doesn't arrive to the back frame (see above) but they are easily attainable from the outside.

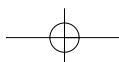

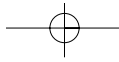

Technical data

CLH 182-242 STD-LN-HPF / CLH 182-202 ELN

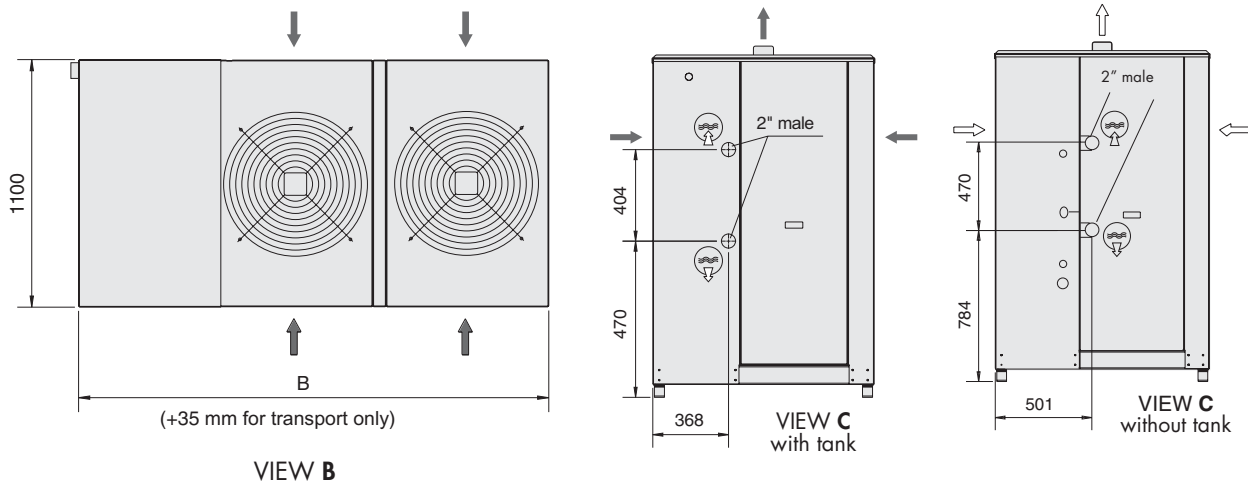
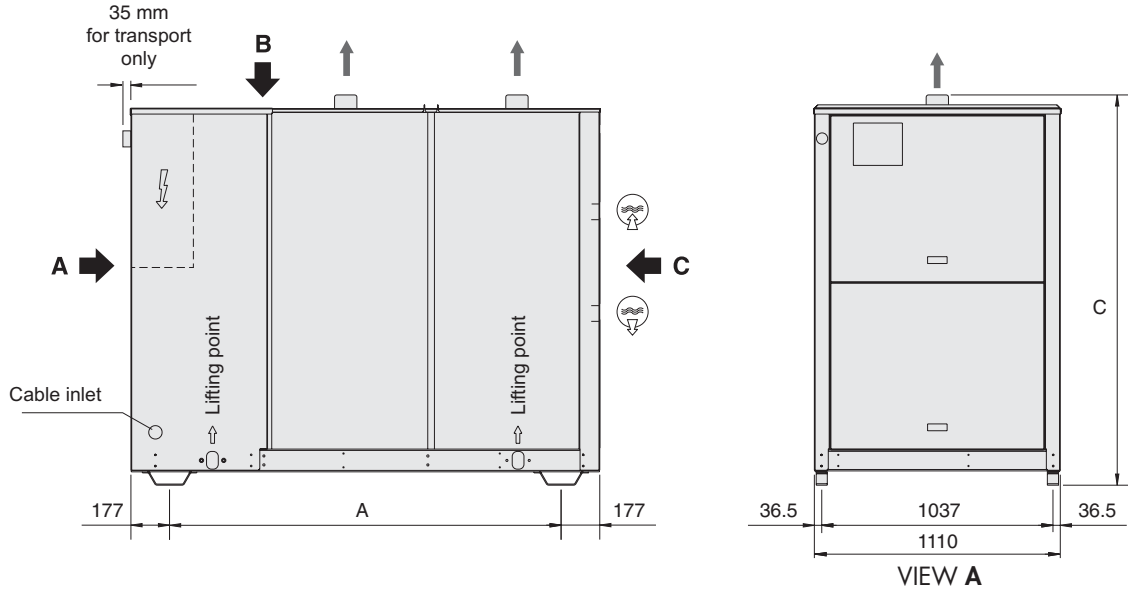

Models	Versions	Dimensions A (mm)	Dimensions B (mm)	Dimensions C (mm)
CLH 182	STD	1756	2110	1750
	LN/ELN/HPF	1756	2110	1850
CLH 202	STD	1756	2110	1750
	LN/ELN/HPF	1756	2110	1850
CLH 242	STD	1756	2110	1750
	LN	1756	2110	1850

Note: Do not extract dimensions if not specified in the drawings.

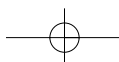

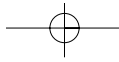

Technical data

CLH 302 STD-LN-ELN-HPF / CLH 242 ELN / CLH 352-602 STD-LN-ELN-HPF

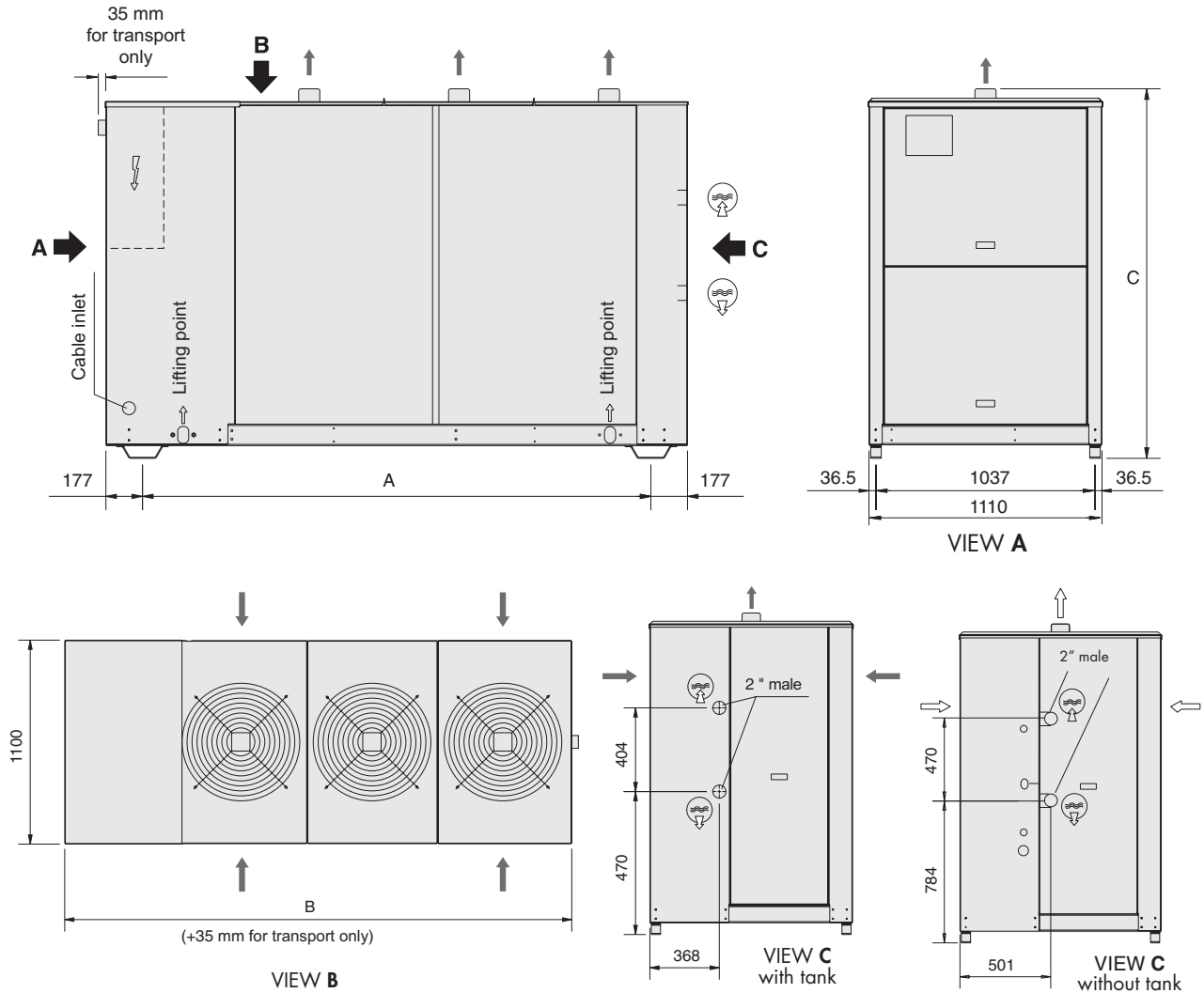

Models	Versions	Dimensions A (mm)	Dimensions B (mm)	Dimensions C (mm)
CLH 242	ELN/HPF	2406	2760	1850
CLH 302	STD	2406	2760	1750
	LN/ELN/HPF	2406	2760	1850
CLH 352-402-502-552-602	STD	2756	3110	1750
	LN/ELN/HPF	2756	3110	1850

Note: Do not extract dimensions if not specified in the drawings.

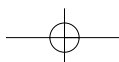

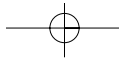

Technical data

8.6 Service spaces

Installation of Single Units

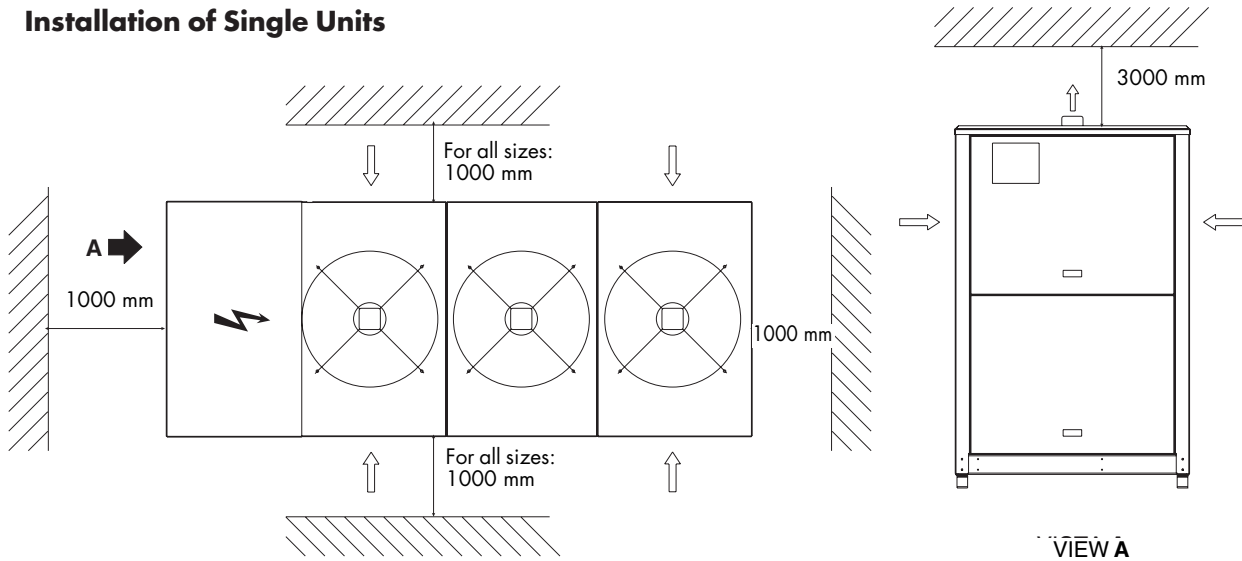

Installation of several Units

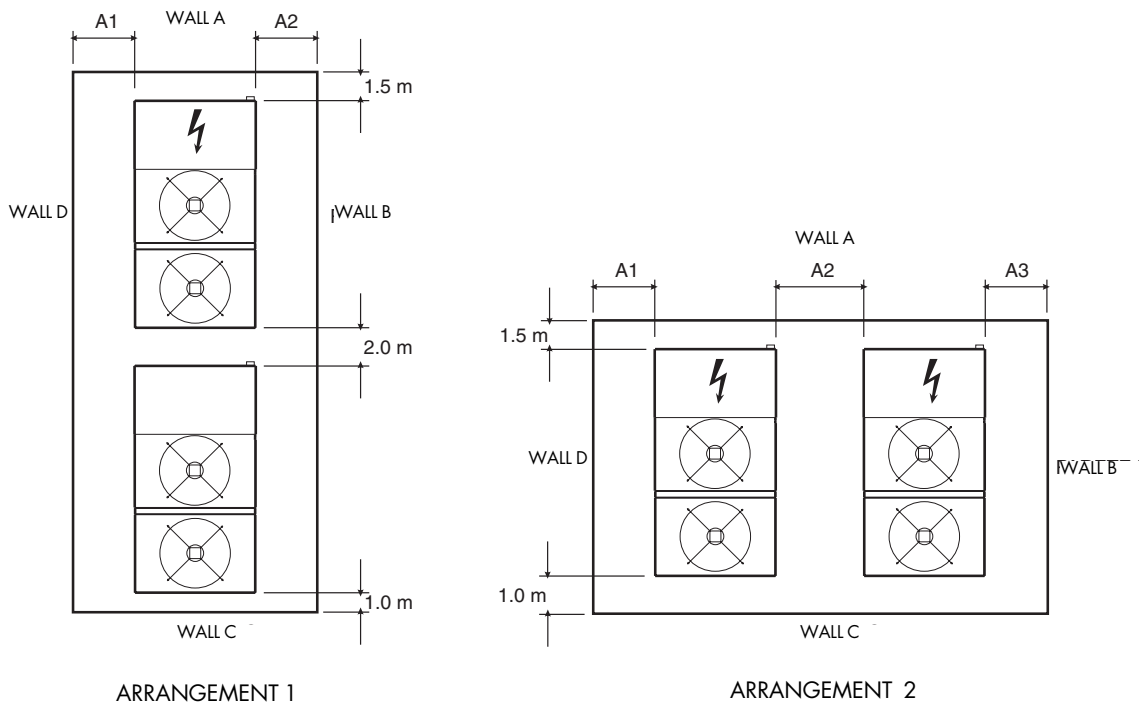

	A and C SCREENED B and D SOLID			A and B SOLID C and D SOLID			B and D SCREENED A and C SOLID			A and B SCREENED C and D SOLID			A and D SCREENED B and D SOLID		
	A1	A2	A3	A1	A2	A3	A1	A2	A3	A1	A2	A3	A1	A2	A3
Arrangement 1 (m)	1.0	1.0		1.0	1.0		0.8	0.8		1.0	0.8		0.8	1.0	
Arrangement 2 (m)	1.0	1.5	1.0	1.0	2.0	1.0	0.8	2.0	0.8	1.0	1.5	0.8	0.8	1.5	1.0

A wall only may be higher than the units.
The area between the walls must be kept free from any obstacle which may hinder the free air inflow towards the unit(s).

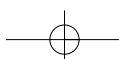

Maintenance

9 MAINTENANCE

Carefully read the "Safety" section of this manual before carrying out any maintenance operations.



Do not discharge the refrigerant into the atmosphere while the refrigeration circuits are being drained. Use appropriate recovery equipment. When the recovered refrigerant cannot be re-used, return it to the manufacturer.



Do not throw away the waste oil of the compressor, because it contains refrigerant in solution. The waste oil must be returned to the manufacturer.

Unless otherwise specified, the operations described below may be carried out only by a trained maintenance operator.

9.1 General requirements

Itelco-Clima units have been designed for continuous operation, providing that they are subjected to regular maintenance, within the limits specified in this manual. Each unit must be serviced according to the programme by the User/Customer, and must be inspected at regular intervals by the personnel of one of Itelco-Clima's authorised Service Centers.

It is the responsibility of the User to meet these maintenance requirements and/or to enter into an agreement with one of Itelco-Clima's Service Centers, so as to properly safeguard the operation of the appliance.

During the warranty period, in case of damage or failures caused by improper maintenance, Itelco-Clima will not refund the costs incurred to repair the appliance in its original state.

The provisions of this section apply only to standard units; according to the order requirements, other documentation may be added, concerning any modifications or supplementary accessories.

9.2 Planned maintenance

Maintenance inspections must be carried out according to the program below, by a qualified person. As a general rule, units cannot be repaired directly by the user, who shall not try to service or repair any failures or anomalies identified during daily inspections. If you are in doubt, please contact Itelco-Clima Service Centre.

Planned maintenance

Operations	Daily	Weekly	Monthly	Beginning of season	End of season
Check the temperature of the leaving fluid	●				
Check the pressure drops in the heat exchanger		●			
Check for electric absorption		●			
Check suction pressure and temperature		●			
Check delivery pressure and temperature		●			
Check the oil level in the compressor		●			
Check that there are no gas bubbles in the liquid line		●			
Check that the fins of the external coil are clean (if any)			●		
Check the operation of the oil heaters			●		
Check the remote control switches			●		
Check the operation of the LP pressure switch				●	
Check the operation of the HP pressure switch				●	
Check the insulation of the heat exchanger				●	
Check that terminals are tightened				●	
Check that the terminals' screws are tightened				●	
Clean the exterior of the unit with water and soap				●	
Check the density of the antifreeze (if any)				●	●
Check the operation of the flow switches				●	
Check the operation of the solenoid valve				●	●

Maintenance

9.3 Refrigerant charge



Do not inject refrigerant liquid into the LP side of the circuit. Be very careful, and charge the circuit properly. If the charge is insufficient, the efficiency of the unit will be lower than expected. In the worst of cases the LP pressure switch may be activated, resulting in the halting of the unit.

In the presence of an excess charge, the condensing pressure will rise (in the worst of cases, the HP pressure switch may be activated, resulting in the stop of the equipment), and the consumption will increase as well.



It is strictly forbidden to use the compressor as a vacuum pump to drain the plant.

Fill the refrigeration circuit after it has been drained for maintenance purposes (leaks, replacement of the compressor etc.). The amount of the charge is indicated on the plate affixed to the unit.

Before refilling, it is important to drain and dehydrate the circuit, thus obtaining a minimum abs. pressure value of 50 Pa.

Inject the refrigerant fluid before removing the vacuum, then fill the circuit up to 90% of the total gas requirement (in liquid form). The appliance must be filled through the filling valve on the liquid line, on the outlet side of the condenser.

It is recommended to connect the refrigerant cylinder to the filling valve on the liquid line, and to arrange it in such a way as to inject only liquid refrigerant.

Then start the compressor and let the gas flow from the cylinder, up until the liquid flow, which can be observed through the sight glass, is limpid.

9.4 Compressor

Compressors are delivered with the necessary charge of lubricating oil. During normal operation, this charge is sufficient for the whole life of the unit, providing that the efficiency of the refrigeration circuit is satisfactory and if it has not been overhauled.

If the compressor needs to be replaced (following a mechanical failure or if burnt), contact one of Itelco-Clima's Service Centers.



Compressors use polyester oil, for both the versions manufactured for R134a and R407C. During maintenance operations on the compressor, or if you have to open the refrigerant circuit in any point, remember that this type of oil is highly hygroscopic, and accordingly it is important that it is not left exposed to the weather for prolonged periods, as this would require the replacement of the oil.

In a few cases, the polyester oil may be present also in R22 units (a refrigerant that can be used also in extra UE countries).

9.5 Condenser

The condenser's coils consist of copper pipes and aluminium fins. In the presence of leaks caused by any damage or shock, the coils shall be repaired or replaced by one of Itelco-Clima's authorised Service Centers. To ensure the effective and correct operation of the condenser coils, it is important to keep the condenser's surface perfectly clean, and to check that there is no foreign matter, such as leaves, wires, insects, waste etc. If the coil becomes dirty, there is an increase in the absorption of electric energy. Furthermore, the maximum pressure alarm may be activated and may halt the unit.



Be careful not to damage the aluminium fins during cleaning.

The condenser must be cleaned with a LP compressed air jet, parallel to the aluminium fins, in the direction opposite to the air circulation.

To clean the coil you can use also a vacuum cleaner, or a jet of water and soap.

9.6 Fans

The fans of the condenser, of axial type, are complete with impeller with aerodynamic profile blades and a cylindrical nozzle. The motor's bearings are lubricated forever.

Before starting the appliance, after any maintenance operations involving the disconnection of 3-phase connections, check that the direction of rotation of the fans is the one indicated by the arrow (upward air current). If the direction of rotation is wrong, invert two of the three supply phases to the motor.

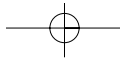

Maintenance

9.7 Dehydrating filter

The refrigeration circuits are provided with dehydrating filters.

The filter clogging is marked by the presence of air bubbles in the sight glass, or by the difference between the temperatures measured downstream from and upstream of the drying filter. If, once the cartridge has been cleaned, there are still some air bubbles, the appliance has lost a part of the refrigerant charge in one or more points, that must be identified and serviced.

9.8 Sight glass

The sight glass is used for inspecting the refrigerant flow and the humidity % of the refrigerant. The presence of bubbles indicates that the dehydrating filter is clogged or the charge insufficient.

A colour indicator is positioned inside the sight glass. If you compare the colour of the indicator to the scale on the ring of the sight glass, you can calculate the percentage of humidity of the refrigerant. If it is excessive, replace the filter's cartridge, operate the appliance for 1 day and then check the humidity % again. When the humidity % is within the pre-determined range, no other operations are required. If the humidity % is still too high, replace the dehydrating filter again, start the unit and operate it for another day.

9.9 Thermostatic expansion valve

The circuit of the unit is equipped with a thermostatic expansion valve, with external equalizer. The valve is shop-calibrated for an overheating of 5°C.

Procedure to check for overheating:

- Measure the suction pressure with the pressure gauges on the board of the unit or using a pressure gauge connected to the service valve on the suction side.
- From the pressure gauge's temperature scale, measure the saturated suction temperature (T_{sa}) which corresponds to the pressure value.
- Using a contact pressure gauge affixed to the outlet fitting of the gas of the evaporator, measure the actual temperature (T_{se}).

Overheating calculation (S):

$$S = T_{se} - T_{sa}$$

Overheating is regulated through the thermostatic expansion valve.

Make the adjusting screw follow a complete turn, and operate the appliance for five minutes. Check again and, if necessary, repeat the regulation.

If the expansion valve cannot be regulated, it is probably broken, and shall be replaced. The replacement must be carried out by a Service Centre.

9.10 Evaporator

Check at regular intervals that the water side of the heat exchanger is perfectly clean. To do this, measure the pressure drop, water side (see Section 8) or measure the temperature of the liquid leaving and entering the heat exchanger, and compare it to the evaporation temperature.

To obtain an effective heat exchange, the difference between the temperature of the leaving water and the saturated evaporating temperature must be in the 2 - 4°C range. A greater difference would indicate a low efficiency of the heat exchanger (i.e. the heat exchanger is dirty).

In this case, the heat exchanger must be subjected to chemical cleaning, an operation that shall be carried out by authorised engineers.

For other maintenance operations (extraordinary overhauling, replacement of the heat exchanger etc.), contact an authorised Service Centre.

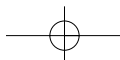

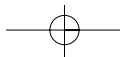

Troubleshooting

10 TROUBLESHOOTING

The table below lists the anomalies of operation of the unit, the relevant causes and the corrective measures. For anomalies of any other type or not listed, contact one of Itelco-Clima's Service Centre for technical assistance.

Anomaly	Cause	Operation
The unit continues to work, but without cooling.	Insufficient charge of refrigerant.	Refill.
	The dehydrating filter is clogged.	Replace.
Ice on the suction line.	Wrong calibration of overheating.	Increase overheating.
		Check the charge.
Excessive noise.	Vibration of lines.	Check the clamping brackets, if any.
	Whistler emitted by the thermostatic expansion valve.	Refill. Check the dehydrating filter.
	Noisy compressor.	Seized bearings; replace the compressor. Check that the compressor's locknuts are tightened.
Low oil level in the compressor.	One or more gas or oil leaks in the circuit	Identify and remove leaks.
	Mechanical failure of the compressor.	Request the intervention of a Service Centre.
	Anomaly of the oil heater of the compressor's base.	Check the electric circuit and the resistor of the heater of the motor base, and replace defective components.

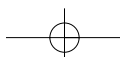

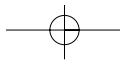

Troubleshooting

Anomaly	Cause	Operation
One or both compressors are not working.	Breaking of the electric circuit.	Check the electric circuit and detect any ground dispersions and short circuits. Check fuses.
	Intervention of the HP pressure switch.	Reset the pressure switch and the control panel and restart the appliance. Identify and remove the cause that enabled the pressure switch.
	The fuse of the control circuit is broken.	Check for ground dispersions and short circuits. Replace fuses.
	Loosened terminals.	Check and tighten.
	Halt caused by thermal overload of the electric circuit.	Check the operation of check and safety devices. Identify and remove the cause.
	Wrong wiring.	Check wiring of check and safety devices.
	The line voltage is too low.	Check voltage. If problems regard the system, solve them. If they are caused by the distribution network, inform the Energy Distributor.
	Short-circuit of the compressor's motor.	Check the continuity of the winding.
	Seized compressor.	Replace the compressor.
Activation of the LP alarm, stop of the unit.	Gas leak.	Identify and remove the leak.
	Insufficient charge.	Refill.
	Failure of the pressure switch.	Replace the pressure switch.
Activation of the HP alarm, stop of the unit.	Failure of the pressure switch.	Check the operation of the pressure switch, replace it if defective.
	The delivery valve is partially closed.	Open the valve and replace it, if faulty.
	Substances with condensable gases in the circuit.	Drain the circuit.
	The fan (i) of the condenser is stopped.	Check cables and motor. If defective, repair or replace.
The liquid line is too hot.	Insufficient charge.	Identify and remove the cause of the loss of charge and refill.
Frosting of the liquid line.	The valve of the liquid line is partially closed.	Check that valves are open.
	The liquid filter is clogged.	Replace the cartridge or the filter.

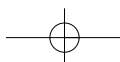

Spare parts

11 SPARE PARTS

11.1 Spare part list

The table below shows the list of spare parts recommended during the first two years of operation.

Component	Number
HP pressure switch	1
LP pressure switch	1
Gas filter	2
Thermostatic valve	2
Auxiliary relays	2
Fan's fuses	6
Compressor's fuses	6
Auxiliary fuses	6
Set of compressor contactors	1
Fan's contactor	1
Water sensor	1
Air sensor	1
Electronic card	1
Keyboard	1
Compressor oil resistor	1

11.2 Oil for compressors

The compressors are lubricated with polyester oil (P.O.E.).

11.3 Wiring diagrams

The wiring diagrams are installed inside the doors of the electrical panels of the unit. Any request for wiring diagrams shall be forwarded to Itelco-Clima's Service Centre..

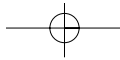

Dismantling, Demolition and Scrapping

12 DISMANTLING, DEMOLITION AND SCRAPPING



During the draining of the refrigeration circuits, do not let the refrigerant overflow in the surrounding atmosphere. The circuit must be drained using suitable recovery equipment.



Do not disperse the waste oil of the compressors in the environment, since it contains some dissolved refrigerant.

For the disposal, contact the competent authority for information.

Unless otherwise specified, the maintenance operations listed below may be carried out by any trained maintenance operator.

12.1 Generalities

Open each line that supplies the unit, including the ones of control circuits. Make sure that all disconnecting switches are secured in the off position. The power cables can be disconnected and disassembled. Refer to Chapter 4 for the position of connection points.

Remove all the refrigerant from the refrigeration circuits of the unit and store it in suitable containers, using a recovery unit. If its characteristics have remained the same, the refrigerant can be used again. Contact the competent authority to obtain information about disposal. In **NO** event shall the refrigerant be discharged into the atmosphere. The oil in each refrigeration circuit must be drained and collected into a suitable container; then it shall be disposed of in conformity with local regulations that apply to the disposal of waste lubricants. Any oil spillage must be recovered and disposed of in like manner.

Isolate the unit's heat exchangers from the external hydraulic circuits and drain the heat exchange sections of the plant.



If no shutoff valves have been provided, it may be necessary to drain the whole plant. If a glycoled solution or a similar fluid has been used in the hydraulic circuits, or if chemical additives have been added to the circulating water, the circulating fluid MUST be drained in a proper way. For NO reason shall a circuit containing glycoled water or a similar solution be discharged directly into the drains or surface waters.

After draining operations, the piping of the hydraulic networks can be disconnected and disassembled.

Once they have been disconnected as specified, the packaged units can be disassembled in a single piece. First of all, disassemble the anchoring screws and then lift the unit from the position of installation, and hook it to the lifting points provided, using suitable lifting equipment.

To this end, refer to Chapter 4 for the installation of these appliances, to Chapter 8 for their weights and Chapter 3 for handling.

The units that, once disconnected, cannot be removed in a single piece, must be dismantled on site; in this case, be very careful with the weight and handling of every single component.

It is always advisable to dismantle the units following the installation steps, but in reverse.



Some residues of oil, glycoled water or similar solutions may remain in certain parts of the unit. These residues must be recovered and disposed of according to the procedures specified above.

It is very important to ensure that, while a component of the unit is being removed, all the others are properly supported.



Use only lifting means of adequate capacity.

Once disassembled, the components of the unit can be disposed of in conformity with current regulations.

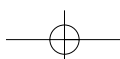

As part of our ongoing product improvement programme, our products are subject to change without prior notice. Non contractual photos.

Your distributor :

CE *Aurwell*
