

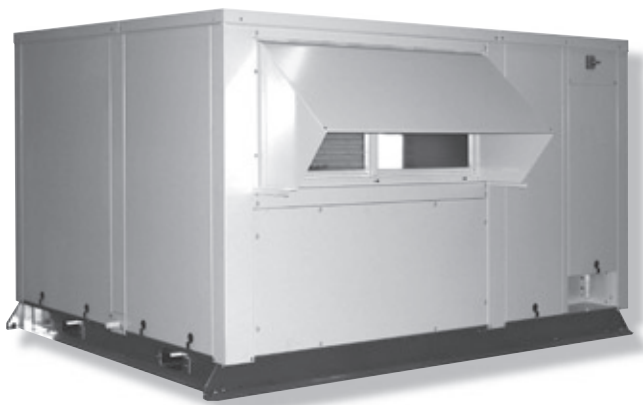

IATC

RoofTech



RoofT@ir

English

Français



UM IATC-N.2GBF

Date : **February / Février 2007**

Supersedes / Annule et remplace : **None/Aucun**



CONTROL MANUAL

NOTICE DE REGULATION

REGELUNGSHANDBUCH

MANUALE DI REGOLAZIONE

INSTRUCCIONES DE REGULACIÓN

English

Français

Deutsch

Italiano

Español

CONTENTS

INTRODUCTION	3
INPUTS/OUTPUTS DESCRIPTION.....	4
ROOFT@IR (2 COMPRESSORS).....	4
DIGITAL INPUTS.....	4
ANALOGUE INPUTS.....	4
DIGITAL OUTPUTS.....	4
ANALOGUE OUTPUTS.....	4
ROOFTECH (4 COMPRESSORS).....	5
DIGITAL INPUTS.....	5
EXPANSION BOARD.....	5
ANALOGUE INPUTS.....	5
EXPANSION BOARD.....	5
DIGITAL OUTPUTS.....	6
EXPANSION BOARD.....	6
ANALOGUE OUTPUTS.....	6
EXPANSION BOARD.....	6
ROOM AIR TEMPERATURE CONTROL	7
SUMMER/WINTER SWITCHING.....	7
UNIT ON/OFF.....	7
KEYING ON/OFF.....	7
REMOTE ON/OFF.....	8
ON/OFF BASED ON TIMER CLOCK.....	8
ON/OFF BY SUPERVISOR (OR BMS: BUILDING MANAGEMENT SYSTEM).....	8
ON/OFF BY PLAN NETWORK.....	8
COMPRESSOR CONTROL.....	9
COMPRESSOR ROTATION.....	9
COMPRESSOR CYCLING.....	10
DEFROST MODE.....	10
MAIN FAN.....	10
TEMPERATURE-BASED FREECOOLING AND FREEHEATING CONTROL.....	10
SUMMER FREECOOLING.....	11
WINTER FREEHEATING.....	11
WINTER FREECOOLING.....	11
ENTHALPY-BASED FREECOOLING AND FREEHEATING CONTROL.....	12
THREE DAMPERS ECONOMIZER OPTION.....	13
SUPPLY AIR TEMPERATURE MINIMUM LIMIT.....	13
HEAT RECOVERY.....	14
AUXILIARY HEATING.....	14
AUXILIARY ELECTRIC HEATING ELEMENTS.....	15
HOT WATER COIL.....	15
GAS BURNER.....	16
SET POINT COMPENSATION.....	16
ROOM AIR QUALITY CONTROL.....	18
SMOKE DETECTOR	18
EXHAUST BLOWER	18
SCHEDULING.....	19
WEEKLY SCHEDULING.....	19
DAILY SCHEDULING.....	20
ON/OFF.....	20
UNOCCUPIED MODE OUTSIDE THE BAND.....	20
USER INTERFACE.....	21
KEYPAD.....	21
LEDS.....	21
MENUS.....	21
USER INTERFACE CONNECTION.....	22
MULTI ROOFTOPS INSTALLATION.....	23
PRINCIPLE.....	23
SHARED DISPLAY.....	23
MASTER/SLAVE.....	23
CONNECTIONS.....	24
ADDRESSES CONFIGURATION.....	25
ACCESS TO THE UNITS OF THE PLAN NETWORK VIA THE SINGLE TERMINAL.....	27
ALARM MANAGEMENT	28
ALARM LOG.....	30
ALARM-WARNING SMS.....	30
SERVICING.....	30
COMPRESSOR AND UNIT HOUR-METER CONTROL.....	30
INPUTS/OUTPUTS TEST.....	30
MENU DESCRIPTION.....	31



POWER SUPPLY MUST BE SWITCHED OFF BEFORE STARTING TO WORK IN THE ELECTRIC CONTROL BOX

INTRODUCTION

The **IATC** (Intelligent Air Technology Control) can manage rooftop air-conditioning unit with:

- One, two or four compressors
- One or 2 circuits
- Main blower
- Economiser: 2 or 3 dampers
- Electric heaters (2 stages)
- Heating valve
- Gas burner
- Heat recovery

Room air temperature can be controlled based on both temperature and humidity values.

Energy-saving features:

- Summer freecooling,
- Winter freecooling,
- Winter freeheating,

These features operate the return and outdoor air dampers, controlling the flow of outdoor air entering the room when outdoor temperature or enthalpies are favourable.

The IATC manages the rooftop unit's main alarms: antifreeze, generic interlocks, clogged filters and all refrigerant circuit alarms, such as: compressor thermal overload, high and low pressure switch.

INPUTS/OUTPUTS DESCRIPTION**ROOFT@IR (2 COMPRESSORS)****DIGITAL INPUTS**

N°	Description
ID1	Antifreeze protection (hot water coil)
ID2	Clogged filter alarm
ID3	Remote Summer/Winter (*)
ID4	Main blower thermal cut-out
ID5	Remote start/stop (*)
ID6	Electric Heater 1 thermal cut-out
ID7	Low-pressure switch circuit 1
ID8	Compressor thermal cut-out circuit 1
ID9	Low-pressure switch circuit 2
ID10	Compressor thermal cut-out circuit 2
ID11	Electric Heater 2 thermal cut-out
ID12	Air Flow-switch
ID13	High-pressure switch circuit 1
ID14	High-pressure switch circuit 2

(*) Customer input

ANALOGUE INPUTS

N°	Description	
B1	Return air relative humidity or indoor air quality	RAH or IAQ
B2	Outdoor air relative humidity	OAH
B3	Defrost temperature circuit 1	OCT1
B4	Defrost temperature circuit 2	OCT2
B5	Smoke Detector	SD
B6	Return air temperature	RAT
B7	Outdoor air temperature	OAT
B8	Supply air temperature	SAT

DIGITAL OUTPUTS

N°	Description
NO1	Compressor 1 circuit 1 contactor
NO2	Condenser fan circuit 1
NO3	Compressor 2 circuit 1 contactor
NO4	Compressor 1 circuit 2 contactor
NO5	Condenser fan circuit 2
NO6	Compressor 2 circuit 2 contactor
NO7	Main blower
NO8	General alarm
NO9	Electric Heater 1
NO10	Electric Heater 2
NO11	Exhaust blower
NO12	Cycle reversing solenoid valve circuit 1
NO13	Cycle reversing solenoid valve circuit 2

ANALOGUE OUTPUTS

N°	Description
Y1	Economiser damper
Y2	Heating valve
Y3	Not used
Y4	Not used

ROOFTECH (4 COMPRESSORS)**DIGITAL INPUTS**

N°	Description
ID1	Antifreeze protection (hot water coil)/Burner alarm
ID2	Clogged filter alarm
ID3	Remote Summer/Winter (*)
ID4	Main blower thermal cut-out
ID5	Remote start/stop (*)
ID6	Electric Heater 1 thermal cut-out
ID7	Low-pressure switch circuit 1
ID8	Compressor thermal cut-out circuit 1
ID9	Low-pressure switch circuit 2
ID10	Compressor thermal cut-out circuit 2
ID11	Electric Heater 2 thermal cut-out/Main blower thermostat
ID12	Air Flow-switch
ID13	High-pressure switch circuit 1
ID14	High-pressure switch circuit 2

(*) Customer input

EXPANSION BOARD

N°	Description
ID1	Return blower thermal cut-out

ANALOGUE INPUTS

N°	Description	
B1	Low pressure transducer circuit 1	EP1
B2	Low pressure transducer circuit 2	EP2
B3	Defrost temperature circuit 1	OCT1
B4	Defrost temperature circuit 2	OCT2
B5	Smoke Detector	SD
B6	Return air temperature	RAT
B7	Suction temperature circuit 1	CST1
B8	Suction temperature circuit 2	CST2

EXPANSION BOARD

N°	Description	
B1	Return air relative humidity or quality	RAH or IAQ
B2	Outdoor air relative humidity	OAH
B3	Outdoor air temperature	OAT
B4	Supply air temperature	SAT

DIGITAL OUTPUTS

N°	Description
NO1	Compressor 1 circuit 1 contactor
NO2	Condenser fan circuit 1
NO3	Compressor 2 circuit 1 contactor
NO4	Compressor 1 circuit 2 contactor
NO5	Condenser fan circuit 2
NO6	Compressor 2 circuit 2 contactor
NO7	Main blower
NO8	General alarm
NO9	Electric Heater 1
NO10	Electric Heater 2
NO11	Exhaust blower/Return blower
NO12	Cycle reversing solenoid valve circuit 1
NO13	Cycle reversing solenoid valve circuit 2

EXPANSION BOARD

N°	Description
NO1	Heat recovery pump
NO2	Burner ON/OFF signal

ANALOGUE OUTPUTS

N°	Description
Y1	Electronic expansion valve circuit 1
Y2	Electronic expansion valve circuit 2
Y3	Heating valve/Burner
Y4	Not used

EXPANSION BOARD

N°	Description
Y1	Economiser damper

ROOM AIR TEMPERATURE CONTROL

Room temperature is regulated with following devices:

- Compressors,
- Heating elements
- Economiser: 2 or 3 dampers

2 set points can be managed, one for summer mode and one for winter mode.

SUMMER/WINTER SWITCHING

You can switch from summer to winter mode (or vice versa) as follow:

1. From the display with Summer/Winter facility (optional)

Press "PRG" key to enter to the main menu - select Summer/Winter and press ENTER. Pressing the ENTER key, you switch between summer and winter. The unit must be first switched OFF.
2. From remote switching via digital input ID3 and terminal 24V
 - Contact open: summer mode
 - Contact closed: winter mode
3. From automatic changeover, based on room air temperature

The unit switches from summer to winter mode or vice versa depending on the room air temperature.

 - $RAT > \text{summer setpoint and } RAT > \text{winter setpoint} + \text{Auto change differential} => \text{summer mode}$
 - $RAT < \text{winter setpoint and } RAT < \text{summer setpoint} - \text{Auto change differential} => \text{winter mode}$

A differential is used to avoid constant summer ↔ winter switching. Moreover, automatic changeover can change the mode only one time each 30 minutes.
4. From PC Supervisor (if selected)
5. From PLAN network if the unit is configured as slave

UNIT ON/OFF

The unit can be switched ON/OFF, by priority order, as follow:

1. From the display with ON/OFF unit facility
2. From remote ON/OFF digital input (ID5) (if active)
3. From daily and/or weekly scheduling (if active, see the related part)
4. From PC Supervisor program (if connected and active)
5. From PLAN (if Plan active, see the related part)

IMPORTANT: All the ON/OFF active conditions must be switched ON to turn the unit ON. If one of these conditions is OFF, the unit is turned OFF.

NB.: It is possible to configure via the Service menu if the unit must start after a random time (60s max), to avoid start-up current peaks. After a power failure or a switch ON, the unit will wait a random time before starting the main blower.

KEYING ON/OFF:

Select UNIT ON/OFF from the main menu and press ENTER: pressing the ENTER key on the display, you switch the unit ON and OFF. If the unit is switched OFF via the display, none of the other ON/OFF procedures can be used to switch it back ON. If the unit is OFF, all unit functions and its various controls are disabled, except smoke detection.

REMOTE ON/OFF

The unit is ON if the following conditions are encountered:

- If the digital input ID5 is active via the Service menu
- If the dry contact is closed

The unit is OFF if the contact is open.

ON/OFF BASED ON TIMER CLOCK

The unit is ON if all the following conditions are encountered:

If the unit has a clock card fitted

- If the clock card is active via the Service menu
- If the daily scheduling is active via the Clock menu
- If the daily scheduling is configured in ON/OFF (not in Unoccupied)
- If the hour is inside the programmed time band
- If the weekly scheduling is active and the current day is programmed ON

The unit is OFF if the hour is outside the band or the current day is programmed OFF.

ON/OFF BY SUPERVISOR (OR BMS: BUILDING MANAGEMENT SYSTEM)

The unit is ON if all the following conditions are encountered:

- If the unit is connected to a supervisor
- If ON/OFF by supervisor is active via the Service menu
- If the communication parameters are configured via the Service menu
- If the supervisor sends ON

The unit is OFF if the supervisor sends OFF.

ON/OFF BY PLAN NETWORK

The unit is ON if all the following conditions are encountered:

- If the unit is connected to a Master unit in Plan
- If the unit is configured as Slave
- If the Master unit is ON

The (Slave) unit is OFF if the Master unit is OFF.

COMPRESSOR CONTROL

The number of compressors and circuits depends on unit configuration.

Compressors ON/ OFF is controlled by the room air temperature (RAT).

The compressors will not work as long as they are locked in the Service menu (P1 and P2).

Operation with 2 Compressors (1/2 circuit) with proportional (P) regulation

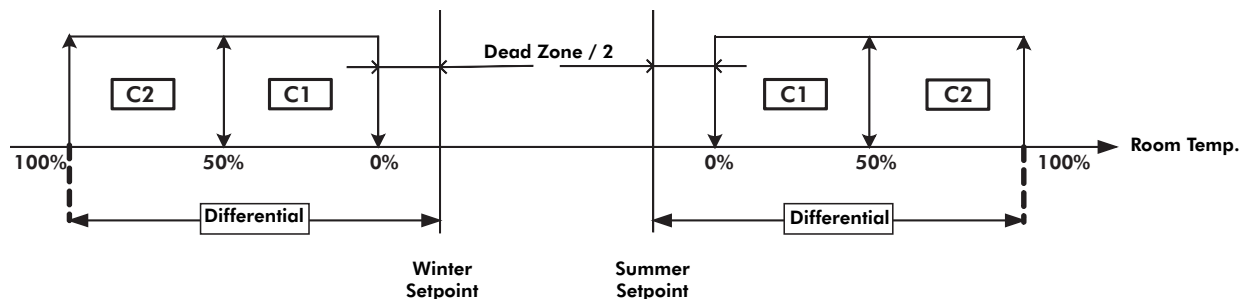

Operation with 4 Compressors (2 circuits) with proportional (P) regulation

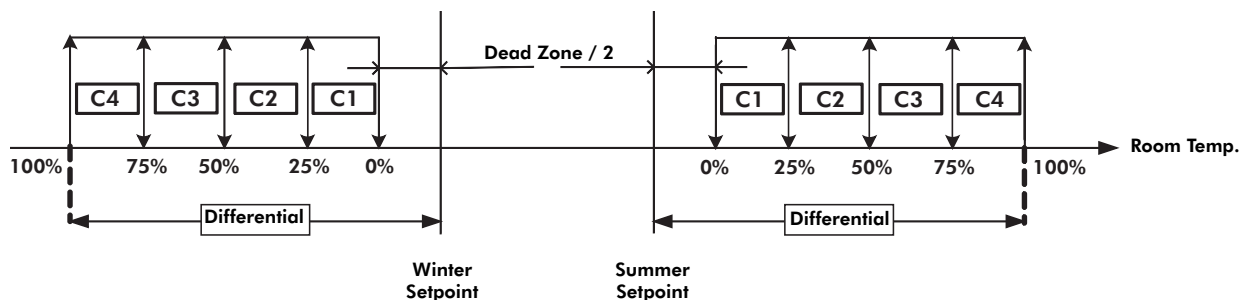

In standard operation, Summer Setpoint = 24°C, Summer Differential = 2°C, Winter Setpoint = 21°C, Winter Differential = 2°C.

COMPRESSOR ROTATION

The compressors rotation is managed according to the circuits (in the case of a 2-circuits configuration) and the compressors status.

The circuits and the compressors of each circuit rotation follows FIFO (First In First Out) logic, i.e. the first circuit to switch ON will be the first to switch OFF and the first compressor of one circuit to switch ON will be the first to switch OFF.

When a compressor is requested to start, the following conditions are observed:

The first circuit to stop will be the first to start.

In the selected circuit, the compressor that has been OFF for a longer time will be the first one to switch ON.

The first compressor to switch ON is the first one to switch OFF.

A compressor will switch ON again, not before all the other compressors have started.

COMPRESSOR CYCLING

The compressor cycling is driven by different delays:

- Compressor start-up delay after main blower has been started: the compressor will switch ON only when the blower is ON for a certain time
- Minimum compressor OFF-time: it makes sure that the compressor stays OFF for a while before it is switched ON again.
- Minimum compressor ON-time: this time makes sure that the compressor, once switched ON, stays ON for a while before it is switched OFF again (should any alarm be activated, the compressor will switch OFF immediately regardless of the above-mentioned delays).
- Time lag between starts of a compressor: this time ensures that, once a compressor has been started, the said time is taken before this compressor starts again (limits demands per hour).
- Time lag between the starts of different compressors: this time ensures that the said time is taken before other compressors can switch ON (limits current peaks).

DEFROST MODE

The 2 circuits (depending on unit size) can not defrost at the same time.

If both circuits are requested to defrost at the same time, one circuit will be kept waiting. A circuit will enter defrost mode provided the following conditions are met:

If the defrost temperature is below a certain limit for a certain cumulative time, the circuit will defrost until the defrost temperature heats up to a certain limit.

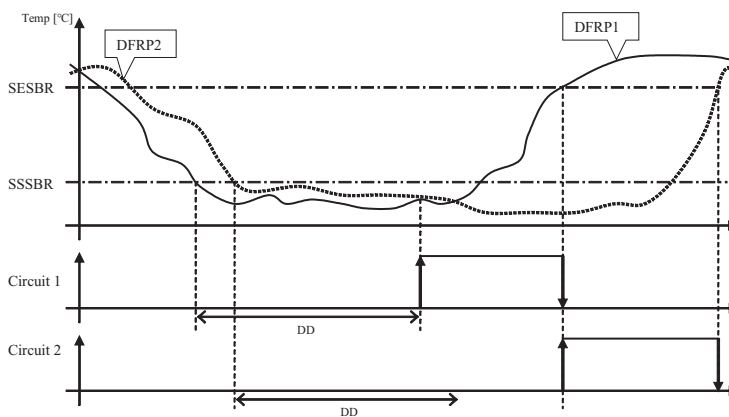

NB.: During defrost, the main fan stays on.

When one circuit is defrosting, the second is forced to full heat capacity (one or two compressors ON, depending on the unit configuration) and maintained 3 minutes after the end of defrost, to attenuate the effect of defrost on supply air temperature. Moreover, the second circuit is not allowed to defrost during the 5 minutes after the defrost of the first circuit.

DFRP1	Circuit 1 defrost sensor [°C]
DFRP2	Circuit 2 defrost sensor [°C]
SESBR	End-of-defrost threshold [°C]
SSSBR	Start-of-defrost threshold [°C]
DD	Defrost delay [s]

MAIN FAN

The main fan is the first device to switch ON once the unit has been turned ON. Once the unit has been turned OFF, the main fan will stay ON for a certain time.

In normal operation (unit ON), the main is always ON. But it can be switched OFF depending of the configuration of the scheduling (see the related part).

The main fan, as all the other electric components of the unit, can be started by the digital output test procedure (Maintenance menu) if there are no alarms to inhibit it.

TEMPERATURE-BASED FREECOOLING AND FREEHEATING CONTROL

With the unit working in FREECOOLING or FREEHEATING mode, external air can be exploited when its temperature conditions are favourable with respect to the temperature of the room air. **This control is not available without the ECONOMISER (2 or 3 dampers) Temperature control option.**

SUMMER FREECOOLING

The summer freecooling is allowed only if: $\text{Outdoor Temp} < \text{Room temperature} - \text{Freecooling/heating differential}$, to ensure that outdoor air is cold enough to cool room air.

The opening of the external damper is controlled by the room air temperature as illustrated in the following figure.

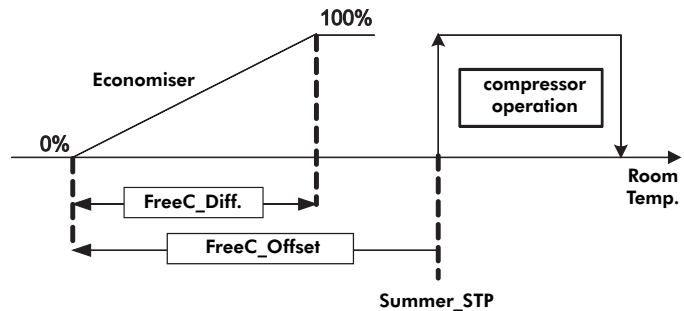

In standard operation, Summer STP = 24°C, FreeC_Offset = -2°C, FreeC_Diff = 2°C

If the offset is set null or positive, freecooling can be made to start after the set point.

WINTER FREEHEATING

The winter freeheating is allowed only if: $\text{Outdoor Temp} > \text{Room temperature} + \text{Freecooling/heating differential}$, to ensure that outdoor air is hot enough to heat room air.

The opening of the external damper is controlled by the room air temperature as illustrated in the following figure.

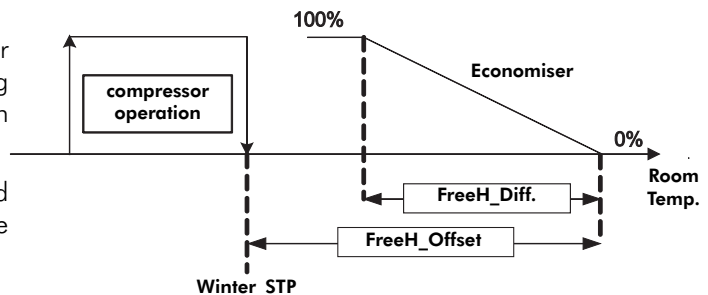

In standard operation, Winter STP = 21°C, FreeC_Offset = 2°C, FreeC_Diff = 2°C

If the offset is set null or negative, freeheating can be made to start before the set point.

WINTER FREECOOLING

Winter freecooling is useful in shopping centres during operation in winter, where overcrowding inevitably causes temperature to exceed the set point, meaning the place needs cooling as opposed to heating. Therefore, for the job of cooling, external conditions are exploited, which are almost always favourable for this purpose in winter.

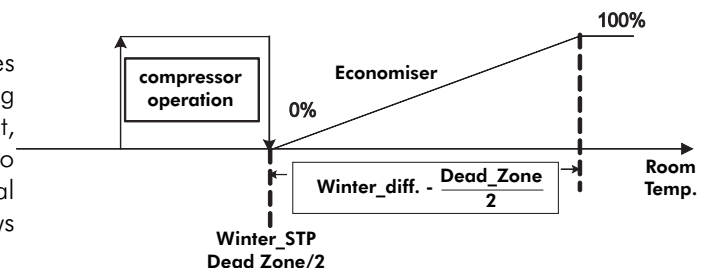

The summer freecooling is allowed only if: $\text{Outdoor Temp} < \text{Room temperature} - \text{Freecooling/heating differential}$, to ensure that outdoor air is cold enough to cool room air.

The opening of the external damper is controlled by the room air temperature as illustrated in the following figure.

The set point and differential (also considered the dead zone/2) are the ones relating to winter mode.

In SUMMER FREECOOLING and WINTER FREEHEATING situations, the normally closed (at minimum position) external damper starts to mix external air with room air in an attempt to move the work point as near as possible to the set point, hence turning off as many devices as possible switched ON for cooling or possibly heating purposes.

The ideal condition would be when the desired temperature or enthalpy is reached just by modulating the damper.

There is an option in the Service menu to select the minimum damper opening when the unit is ON.

Bear in mind the supply air temperature limit. This overrides damper modulation, forcing it to close.

ENTHALPY-BASED FREECOOLING AND FREEHEATING CONTROL

The enthalpy-based freecooling and freeheating control feature manages external damper opening based on internal and external enthalpy conditions.

With room temperature and air humidity, the controller calculates the room enthalpy (see the Inputs/Outputs menu), with external (outdoor) temperature and humidity, the controller calculates the outdoor enthalpy; and with the temperature and Humidity control set points, it calculates the enthalpy set point. The aim of the control feature is to keep room enthalpy as near as possible to the Enthalpy set point to save energy.

The following conditions may occur:

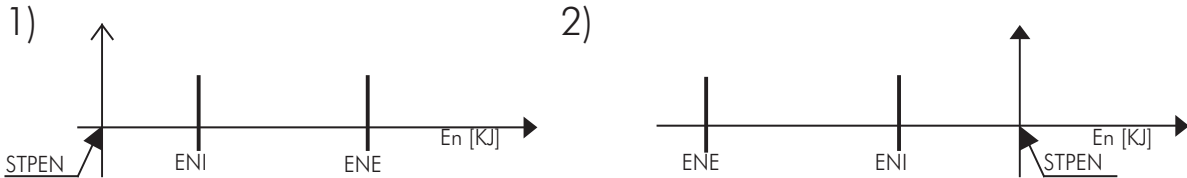

Opening the outdoor-air damper will not be a suitable response in either of the conditions illustrated above (1, 2) since indoor enthalpy is nearer to the enthalpy set point than the outdoor enthalpy.

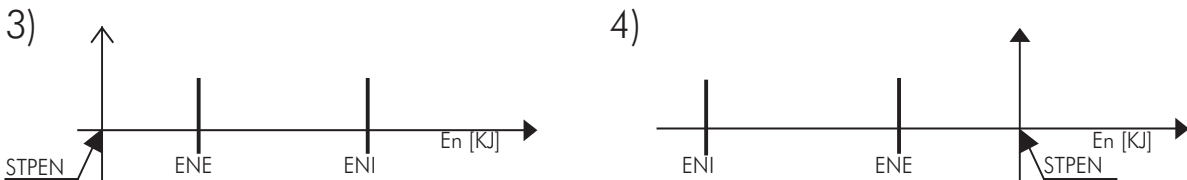

Opening the damper will be a suitable response in either of the conditions illustrated above (3, 4) since external enthalpy is nearer to the enthalpy set point than internal enthalpy.

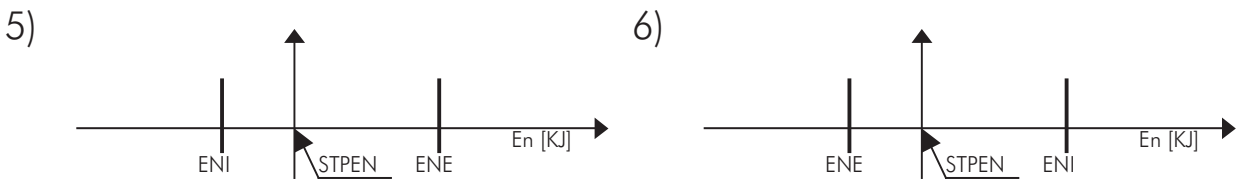

STPENS	Enthalpy set point [KJ]
ENI	Indoor enthalpy [KJ]
ENE	External enthalpy [KJ]

In case number 5 illustrated above, indoor enthalpy is nearer to the enthalpy set point than external enthalpy. However, in this case, opening the damper is a suitable response because, with the mixing of the two enthalpies (indoor and external), indoor enthalpy will however approach the enthalpy set point.

In case number 6 illustrated above, external enthalpy is nearer to the enthalpy set point than indoor enthalpy. Consequently, opening the damper is a suitable response because, with the mixing of room air and external air, indoor enthalpy will however approach the enthalpy set point.

Should any of the cases illustrated above (3, 4, 5, 6) occur, damper opening will depend on internal enthalpy as shown in the figure below:

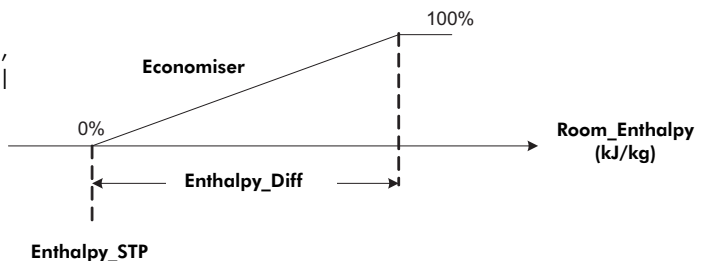

In standard operation, Enthalpy setpoint = 38 kJ/kg (from temperature and humidity setpoints), Enthalpy diff = 5kJ/kg.

THREE DAMPERS ECONOMIZER OPTION

The return blower is a part of the 3-Damper economizer option.

This blower is automatically started 10 seconds after the main supply blower.

If the return blower cuts out, the unit is immediately stopped.

SUPPLY AIR TEMPERATURE MINIMUM LIMIT

The Supply air temperature minimum limit protects the room against sudden drops in temperature and cold air draughts. This function is available only with Supply air temperature sensor (provided with the function ECONOMISER 2 or 3 dampers).

Winter mode

When supply air temperature drops below the supply set point + differential, the winter freecooling is disabled, the heating valve is forced to fully open and the external air damper is gradually forced to close, as illustrated below:

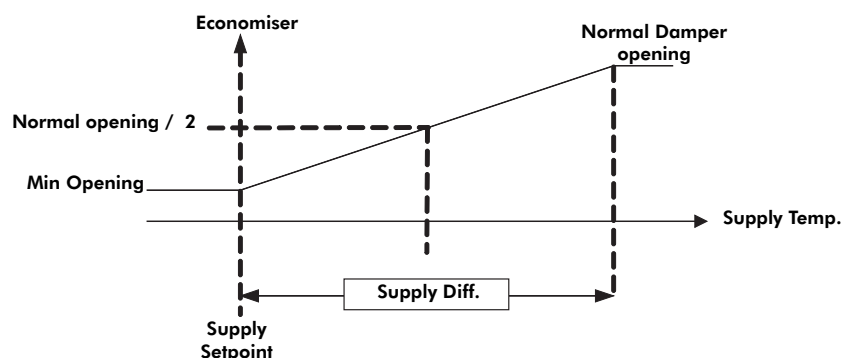

For example, if the winter freecooling function opens the damper at 60% (normal opening), and the supply air function closes the damper of 50%, the final opening will be 50% of 60%, that is to say 30%.

When supply air temperature starts to increase to the point of exceeding supply set point + differential, then both the external damper and heating valve revert to normal operating mode (the minimum limit on supply air during winter mode does not interact with compressor operation).

Summer mode

When supply air temperature drops below the supply set point, the external air damper is gradually forced to close (**similar to winter mode**). Circuits are gradually switched off as illustrated in the figure below:

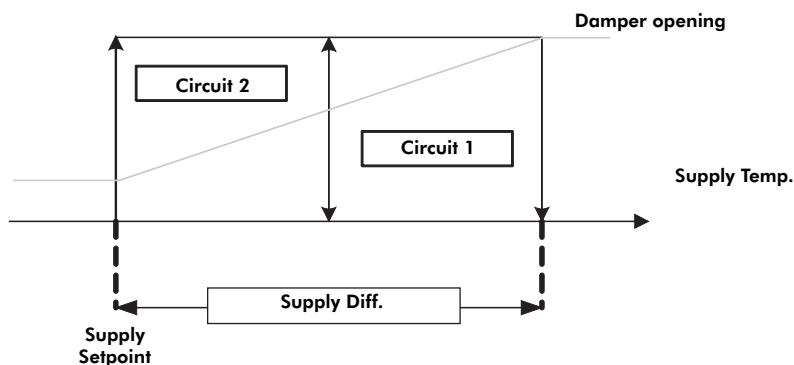

HEAT RECOVERY

This option is only available with the 3-damper option. The heat recovery function manages a pump according to room air temperature, outdoor air temperature and dampers opening. This function has to be activated in the Service menu.

Winter mode

To run the pump, the following conditions have to be respected:

- $RAT > OAT + Recovery_diff$ (settable in the Service menu, 10°C by default)
- Damper opening $>$ recovery_open_min (settable in the Service menu, 20% by default)

Note: The pump is disabled in winter freecooling

Summer mode

By default, the pump stays OFF in this mode, but can be enabled in the Service menu. If enabled, the pump will start according to the following conditions:

- $OAT > RAT + Recovery_diff$
- Damper opening $>$ recovery_open_min

AUXILIARY HEATING

When an auxiliary heating device is present (electrical heaters, hot water coil or gas burner) and Outdoor Air Temperature (OAT) probe is connected, the management in heating mode related to the compressors can be configured:

Via the SERVICE menu, an outdoor air temperature can be set to configure the auxiliary heating element as an extra heater (standard) or replace the thermodynamic heating.

Below this limit, the auxiliary heating element replaces the thermodynamic heating which is also enabled to run if the auxiliary heating capacity is not sufficient. By default, this limit is set to -30°C.

If set to a high value (30°C for example), the auxiliary heating will always start before the compressors.

If set to a low value (-30°C for example), the compressors will start first (standard).

Below the OAT limit, it is also possible to let the compressors start or not.

If the auxiliary heating element is in alarm or if the unit is cooling only, the compressors automatically run classically.

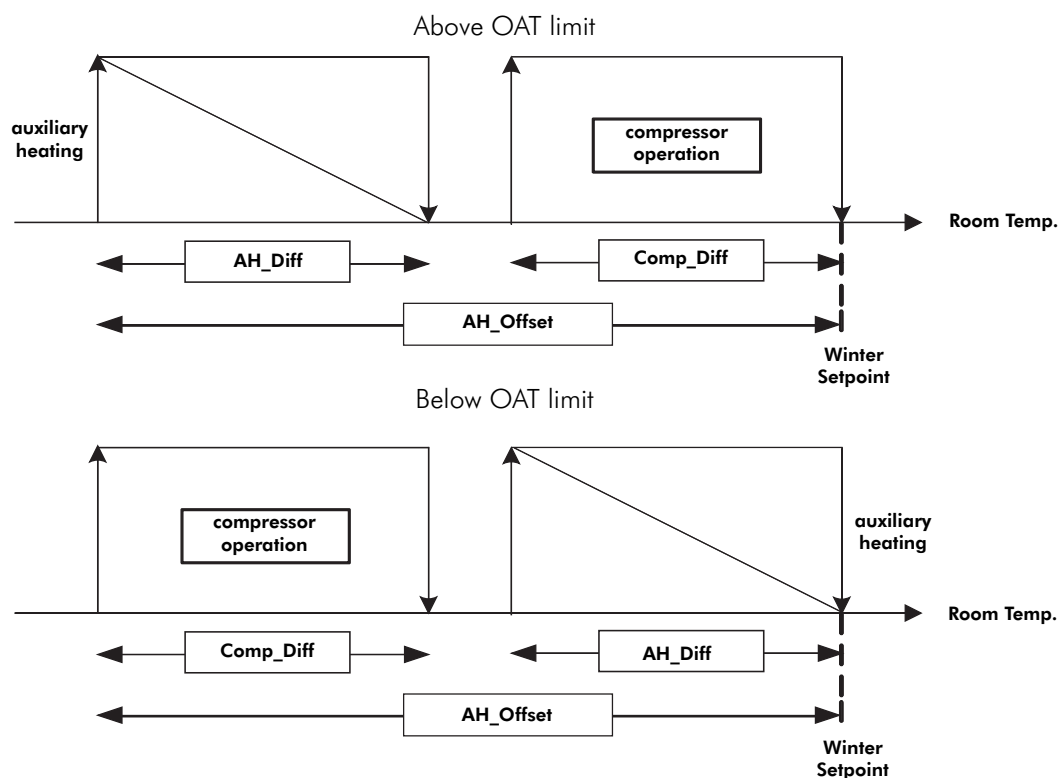

AUXILIARY ELECTRIC HEATING ELEMENTS

This function is only available with the Electric Heaters (2 stages) option.

Auxiliary electric heating elements are controlled by room air temperature as illustrated in the figure below provided the following conditions are met:

- The unit is in winter mode
- Electric Heaters 1 and 2 are enabled (via the Service menu)

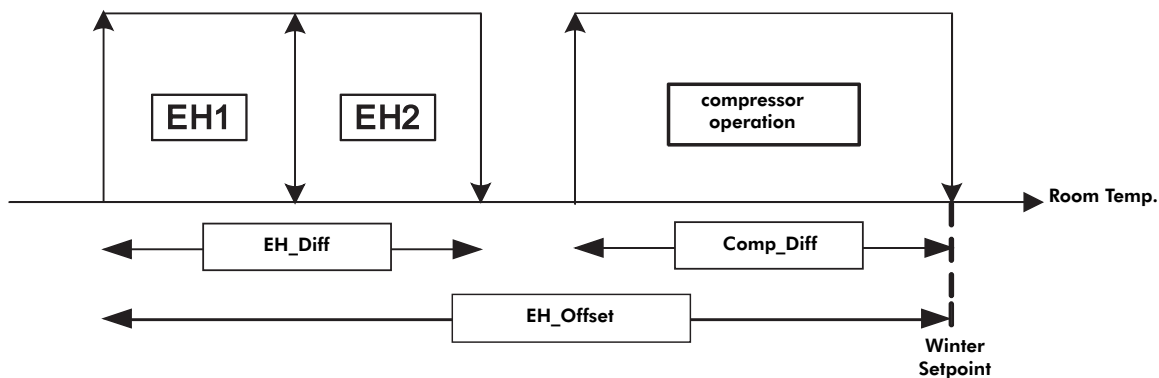

HOT WATER COIL

In winter mode, a 0-10V valve controls the hot water flow through the hot water coil, according to the figure below:

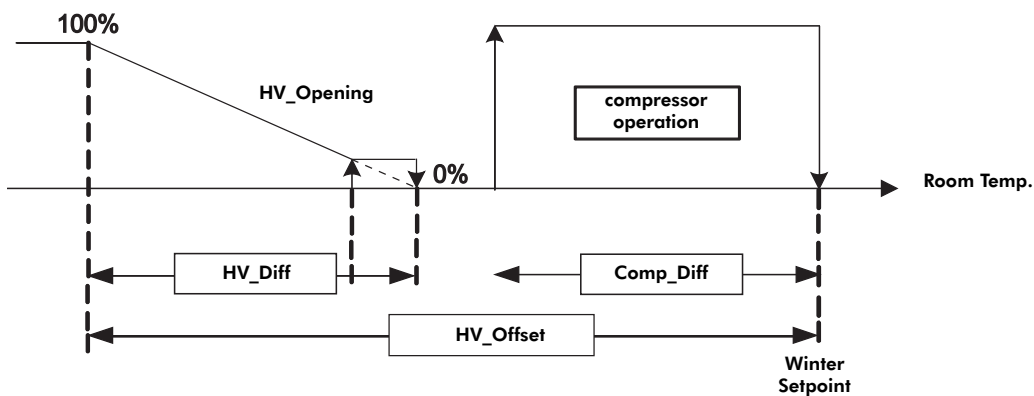

GAS BURNER

In winter mode, a 0-10V output controls the gas burner capacity according to the figure below:

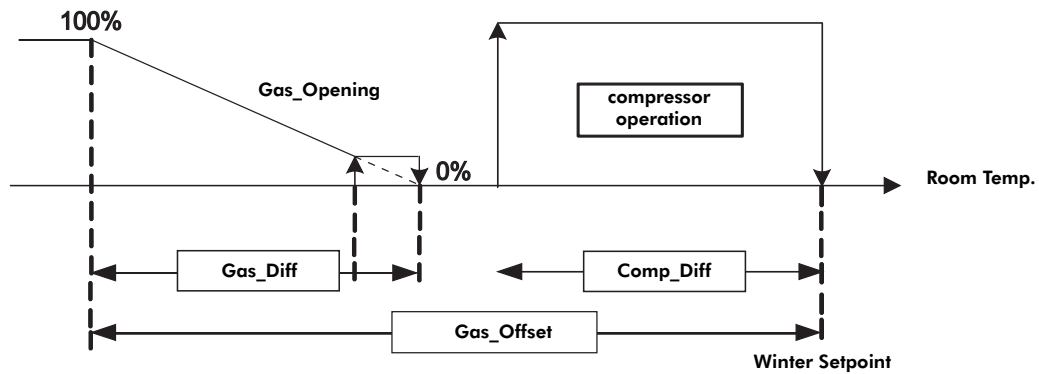

Maximum Supply Air Temperature limitation

If the supplied air is too high, this function can proportionally reduce the burner capacity as the figure below:

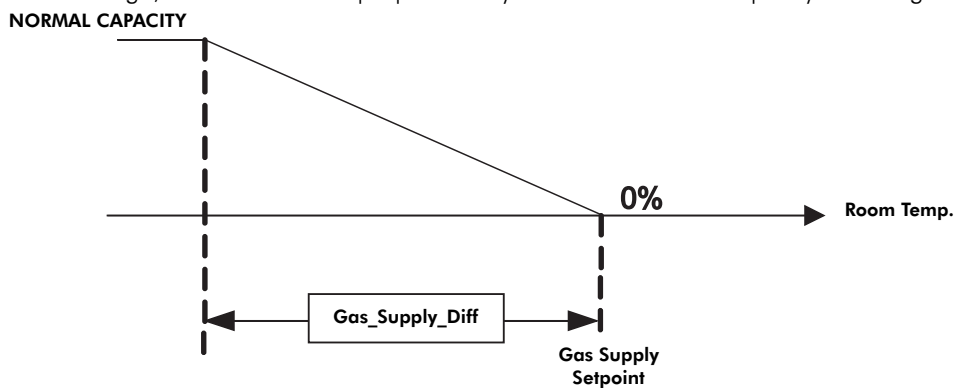

The supply setpoint is set to 65°C and the differential to 10°C.

The gas burner can also be stopped by:

- Main blower motor air thermostat; automatic reset up to 3 times in 30 minutes then manual reset is needed
- Alarm generated by the burner internal electronic board and which is sent to the main controller. Stops the gas burner operation until manual reset on both controllers.

When stopped, the gas burner will stay OFF for two minutes before being enabled to start.

Moreover, the airflow detector is present with the gas burner option.

SET POINT COMPENSATION

Set point compensation allows saving energy when external temperature values are particularly unfavourable considering the demands of the room to be controlled. The compensation can also be used to increase the comfort. Compensation varies the control set point according to external temperature. This function is available with the external air temperature sensor option.

Set point compensation differs between winter mode and summer mode in terms of the type of action and the parameters employed.

Summer Compensation

STPCOMP	Compensation set point [°C]
COMPM	Maximum compensation [°C]
DIFFC	Compensation differential [°C]
T _{EXT}	External temperature [°C]

Compensation - Positive differential

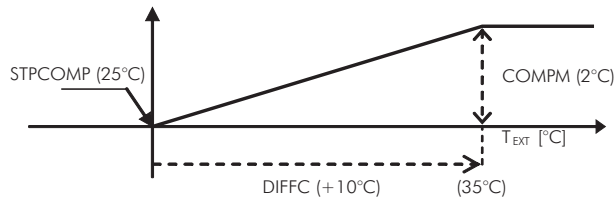

Compensation - Negative differential

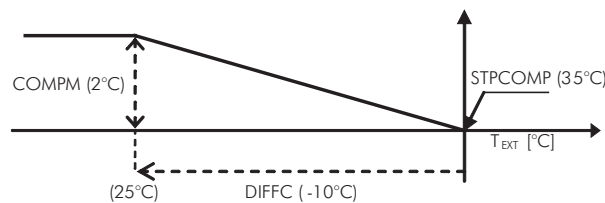

Example with manual Cooling setpoint = 24°C

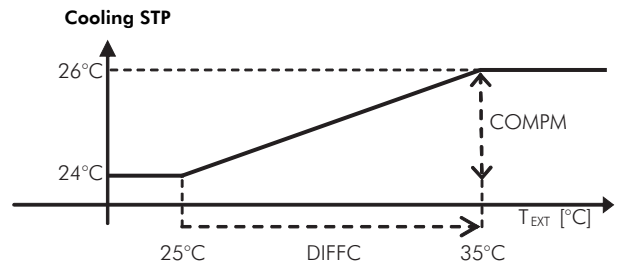

Example with manual Cooling setpoint = 24°C

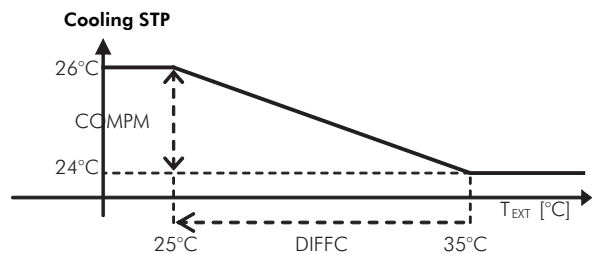

Winter Compensation

Winter set point compensation is enabled when the following conditions are encountered:
the unit is in winter mode;

STPCOMP	Compensation set point [°C]
COMPM	Maximum compensation [°C]
DIFFC	Compensation differential [°C]
T _{EXT}	External temperature [°C]

Compensation - Positive differential

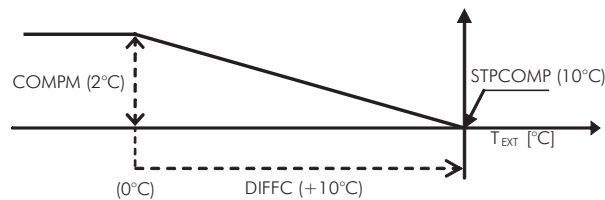

Compensation - Negative differential

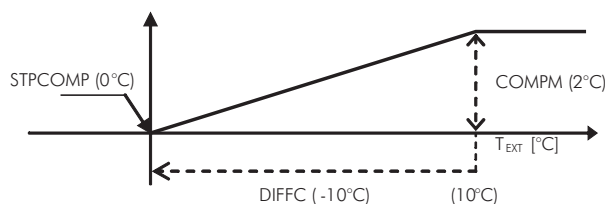

Example with manual Heating setpoint = 21°C

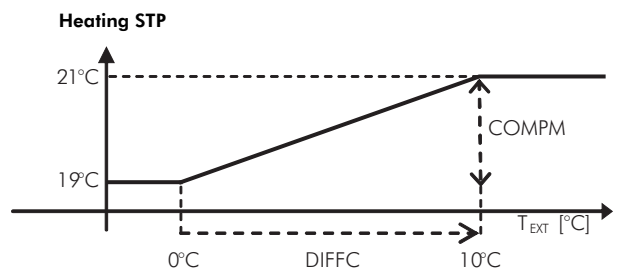

Example with manual Heating setpoint = 21°C

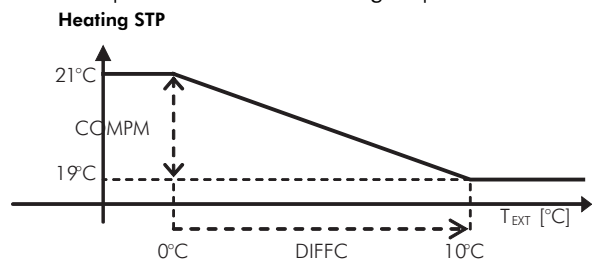

ROOM AIR QUALITY CONTROL

Room air quality control opens the external damper to increase the percentage of fresh air when the room air is too much polluted compared to the IAQ (Indoor Air Quality) sensor setpoint.

This function is available only with the IAQ sensor option, which is incompatible with the Indoor air humidity sensor option. This function also needs the modulating external damper.

External damper is controlled by IAQ as illustrated in the figure below:

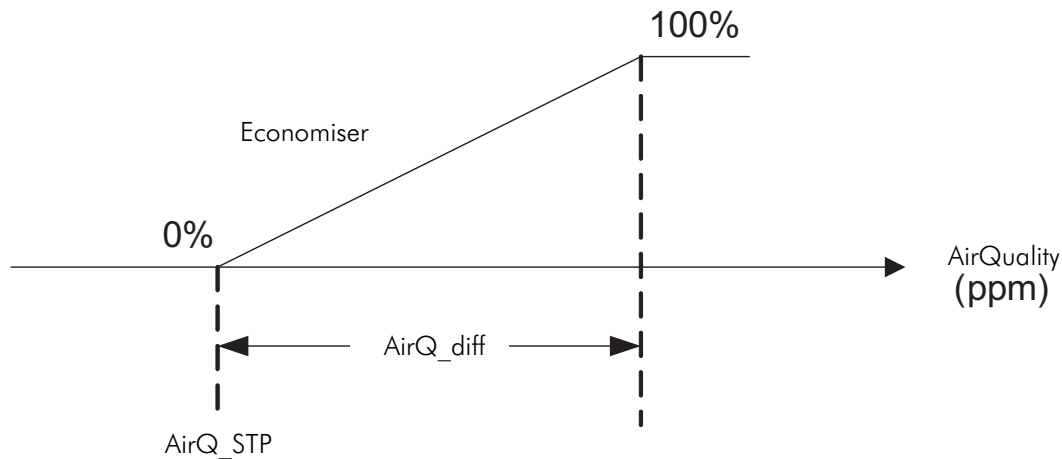

NB:

When this function asks for opening the external damper at the same time as freecooling for example, the highest opening has the priority.

SMOKE DETECTOR

The smoke detector is an option.

When smoke is detected in the room air, the exhaust blower and the economiser (external damper) are managed separately via the Service menu. The unit is forced OFF, the main fan is stopped but the exhaust blower can be switched ON or OFF and the economiser can be open or closed.

EXHAUST BLOWER

The exhaust blower is optional.

It is activated when the modulating external damper reaches 100% opening (settable in the Service menu) or when smoke is detected by the smoke detector (settable).

SCHEDULING

This feature is only available if the board has a clock card fitted.

Two kinds of scheduling are available, via the Clock menu:

- Weekly scheduling
- Daily scheduling

WEEKLY SCHEDULING

Weekly scheduling controls the unit's switching ON and OFF during the week, determining either the ON or OFF state for each single day.

Weekly scheduling can be enabled via the Clock menu.

For each day of the week, a parameter is set that controls the unit's switching ON and OFF.

Each day at midnight, the controller will check whether the variable related to that day is set to ON or OFF and will switch the unit ON or OFF accordingly.

Example:

- Weekly scheduling enabled
- Unit running on Monday = ON
- Unit running on Tuesday = ON
- Unit running on Wednesday = ON
- Unit running on Thursday = ON
- Unit running on Friday = OFF
- Unit running on Saturday = OFF
- Unit running on Sunday = OFF

With this setup, the unit will be ON from 00:00 on Monday until 23:59 Thursday evening; it will stay OFF from 00:00 on Friday until 23:59 Sunday evening.

It is also possible to parameter a specific operation for the main fan when the unit is OFF by scheduling. For example, at night (daily scheduling ON/OFF, outside the band) or the days that are programmed OFF, it can be interesting to let the main fan ON, to have a continuous air circulation in the building. This parameter is available in the Clock menu.

DAILY SCHEDULING

The daily scheduling can be managed by two different ways:

- ON/OFF
- Unoccupied mode

For both options it is necessary to configure a time band with the Start and End hours, that determines 2 zones: inside and outside the band.

ON/OFF

When the hour is inside the band (between Start and End hours), the unit is switched ON. When the hour is outside the band, the unit is switched OFF. If the Start and End hours are inverted (for example Start = 20:30, End = 7:30), the unit will be ON between Start hour and midnight and also ON between midnight and End hour the following day.

UNOCCUPIED MODE OUTSIDE THE BAND

When the scheduling is configured in Unoccupied, the unit is in unoccupied mode outside the band. Inside the band, as for the ON/OFF configuration, the unit runs normally.

Different parameters are available:

- Main fan operation : when the unit is in unoccupied mode (outside the band), the main fan can be always ON or only ON when the unit is on demand (compressors, freecooling ...) and OFF if there is no demand.
- Summer compressors start enabling : in unoccupied mode, it is possible to force the compressors OFF. Typically, with an economiser and in summer mode, this parameter gives the possibility to take advantage of the freecooling (if possible) at night, but also not to allow the compressors to start. That way, the electric consumption is reduced to the maximum, and if the freecooling is not possible, the unit will stay in standby (with main fan OFF if configured previously) until the morning and the end of the unoccupied mode.
- Economiser minimum position (if active in the Service menu) : when the unit is ON and main fan ON, the economiser is always open at least at the minimum position set in the Service menu (manually or by analogue input). But in unoccupied mode, it is also possible to set this minimum opening to 0% because there could be no need to take fresh air when the building is unoccupied (especially in winter mode).
- Summer and Winter setpoints : in unoccupied mode, these setpoints replace the setpoints set in the Setpoints menu

NB:

It is possible to mix weekly and daily scheduling

USER INTERFACE

The terminal is a 6-button, 4-line x 20-character LCD model, which can display text in various sizes and icons.

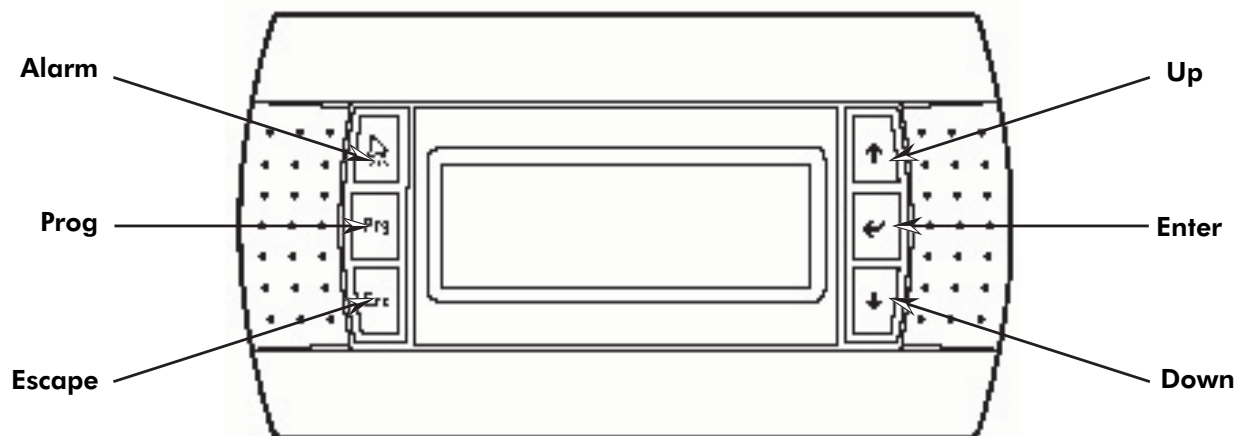

KEYPAD

ALARM: pressing this key calls up the first active alarm screen. Pressing the key again resets the active alarm or alarms. Various alarm screens can be viewed by pressing UP/DOWN. If no alarms are reported, pressing this key skips to the NO ACTIVE ALARM screen (see Alarm management).

ESC: ESC exits a loop and goes back to the previous menu.

PRG: PRG from any screen, provides access to the main menu so that you can perform programming procedures.

UP/DOWN: these keys are dual purpose:

- use to scroll screen loops when the cursor is in the top left corner;
- use to increase/decrease parameters or change their values when the cursor is positioned on said values.

ENTER: ENTER in the value setup screens, the first time the key is pressed, the cursor moves onto the first parameter on the screen. When pressed again, you confirm the set value and move the cursor to the next parameter. From the last parameter, the cursor will return to the top left position (cursor on 0.0 on display).

LEDS

This terminal features the alarm key, which indicates the alarm condition, and the prog key, which tells the user that he is entering the unit's configurations. 5 minutes after the last key is pressed, the application automatically calls up the main screen and switches off the display's LEDs and backlighting.

MENUS

The application program's user interface includes screens that can be viewed without restriction and others that, for security purposes, are password protected. Hence screens are split into different security levels:

Screens not password protected: they appear in all loops except MANUFACTURER and SERVICE and show sensor values, alarms, hours of operation of the various devices, time, date, and can be used to enter set points and for clock setup.

Password-protected sub-screens: in MAINTENANCE and CLOCK loops, there are unrestricted screens not protected by passwords followed by a logon screen for access to the other screens. Via these screens you can check devices at regular intervals, set connected sensors, edit hours of operation, manage devices in manual mode and set time bands.

Password-protected screens: these are the MANUFACTURER and SERVICE loops. The SERVICE screens allow devices enabling, set-points limits setting, communication parameters configuration... The MANUFACTURER screens are factory reserved.

USER INTERFACE CONNECTION

The semi-graphic terminal is connected to the controller using the supplied 80cm telephone cable between the back of the terminal and the J10 plug of the controller.

For other applications, it is possible to extend the distance between the terminal and the controller:

- Up to 50m using a 6-wire shielded telephone-type cable, 2 telephone 6-pin connectors (straight pin to pin connection) and 2 ferrites mounted on the telephone cable, one on the terminal side and the other on the controller side. The shield has to be connected to the GND pin of J11.

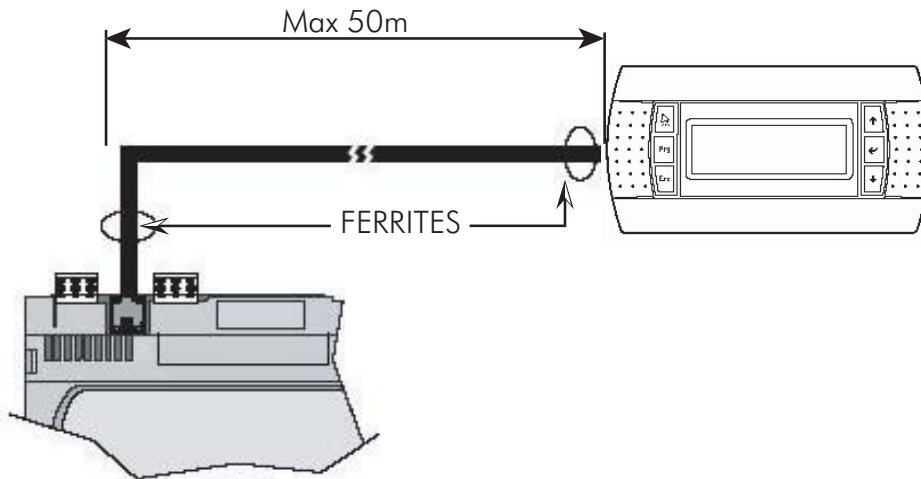

- Up to 200m, with the same shielded cable, two communication boards (optional) have to be added at controller and display sides to relay the signal.

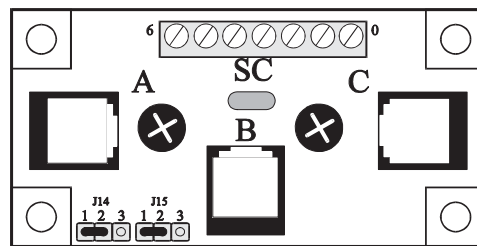

J14 and J15 set between 1-2

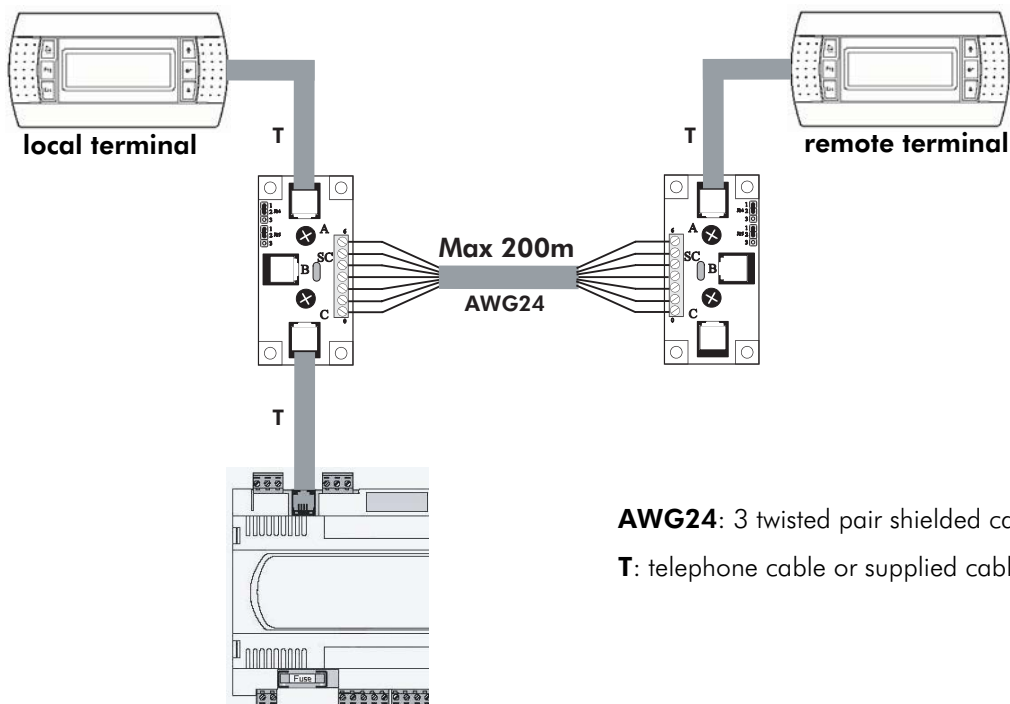

AWG24: 3 twisted pair shielded cable

T: telephone cable or supplied cable

MULTI ROOFTOPS INSTALLATION

PRINCIPLE

SHARED DISPLAY

When an installation is composed of many units (in different zones/groups or not), it is possible to connect all the Rooftops together and display each unit parameters using only one interface for the whole installation.

MASTER/SLAVE

Keeping the unique display, it is also possible to configure the network in Master/Slave. In that case, the first unit (with address 1) is considered as the Master and all the other units (with address from 2 to 31) are the Slaves. The aim is to have all the units running in the same way. The master sends ON/OFF, Summer/Winter, active setpoint, Hour/Date, unoccupied mode and economiser minimum opening to the connected slaves. All the other parameters have to be configured on each unit. One of the advantages is to fit only one clock board in the master unit and send the hour and the date via the network to the slaves (also available in the Shared Display configuration).

Via the Service menu on the master unit, several parameters must be configured for the PLAN,. There is nothing to configure on the slaves concerning the PLAN:

- PLAN network enabling (for Shared Display also): If No, the alarms in relation with the PLAN are not generated any more. But the PLAN for the Shared Display is still available (with the slaves units that are connected). In the Master/Slave configuration, the master stops sending the data to the slaves and the units configured as PLAN slaves run in stand-alone. To have a unit running as stand-alone or master, its PLAN address must be 1. If the PLAN is enabled, PLAN alarms can be generated and in the Master/Slave configuration, the slaves always run with the data sent by the master unit.

IMPORTANT: If a unit configured as PLAN slave is disconnected before configuring it as stand-alone or if the PLAN network fails, the slave unit(s) will continue to run as slave with the last data sent by the master unit.

- Number of units connected (for Shared Display also): From 2 to 31. It is strongly recommended to set the units address by increasing order and not let a missing address. If 20 units are to be connected, the addresses must be set from 1 (for the master) to 20.
- PLAN configuration: Display only (Shared Display) or Master/Slave
- PLAN units activation: To run as slave, the units must be activated. If a unit has to be shut down or disconnected from the PLAN, it must be deactivated. Otherwise, an alarm will appear on the master and the slave to signal a PLAN failure. Moreover, the slave unit will continue to run with the last sent data.
- PLAN units configuration: If the network is configured in Master/Slave, the connected units with the addresses from 2 to 31 can be separately configured as Display only (stand-alone with the shared display) or as slave.

NB: If a unit is not detected any more by the master, a PLAN failure alarm is displayed on the master. To know which unit(s) is disconnected, have a look at M5 and M6 (main screens) where the units that are connected are displayed.

The principle is to connect all the units in parallel via one PLAN bus, using the J11 plug of the controller, while the graphic interface is connected to one of the units (preferably the one with the address 1) using the J10 plug.

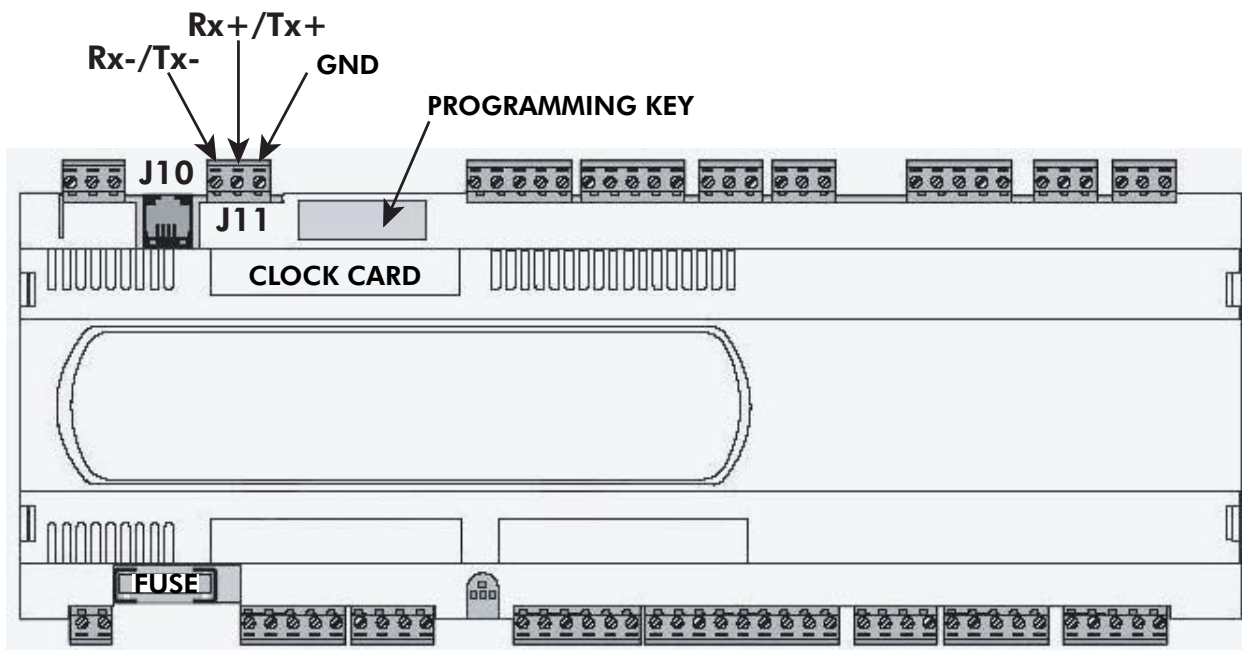

In PLAN, it is possible to connect up to 32 elements (controllers or terminals) identified by their individual address from 1 to 31 for controllers and 1 to 32 for terminals (displays). The 32nd unit must always be a terminal.

Be careful: terminals and controllers use the same type of address, so **all PLAN elements must have different addresses**. For the Master/Slave configuration, with 20 units connected (1 master, 19 slaves) and 3 displays for example, the controllers must have following addresses (from 1 to 20) and the displays must have the addresses 30 to 32. With one display, it is preferable to set the address to 32.

CONNECTIONS

The connection between boards in PLAN is carried out using a 0.33 to 0.5 mm² (AWG20/22) shielded cable, twisted pair + shield.

The network polarity is very important: RX/TX+ on one controller must be connected to RX/TX+ on the other controllers and the same for RX/TX-. The shield must be connected on all the controllers to the GND pin of J11.

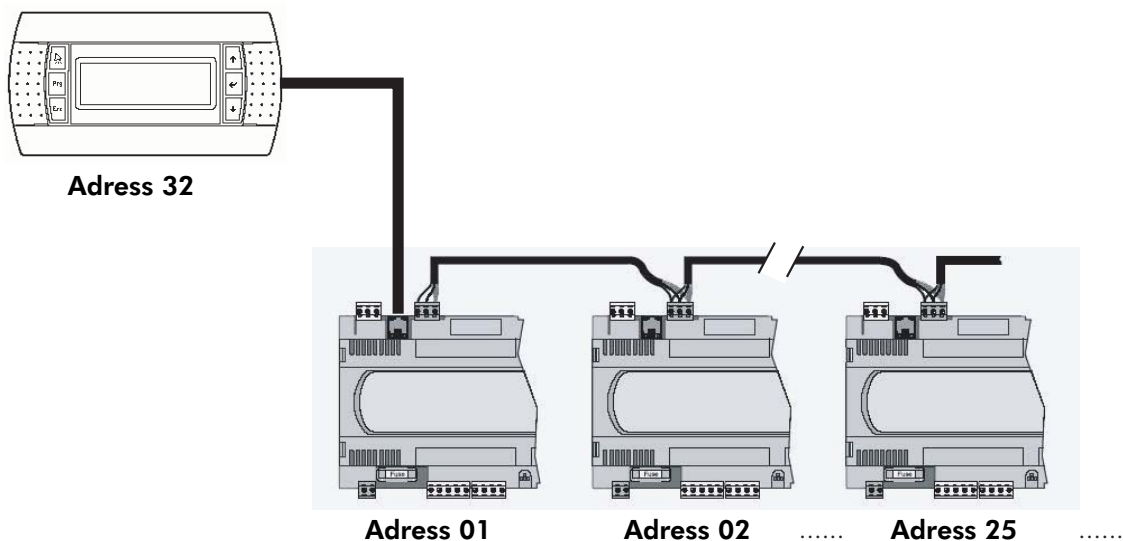

ADDRESSES CONFIGURATION

By default, the controllers are always configured with the PLAN address 1, while the terminals have the address 32.

The configuration of the addresses of the controllers and the terminals is done with the following procedure:

1. To modify the controller address, the terminal must have the address 0.

To modify the terminal address:

- Connect it to a non power supply controller.
- Disconnect the controller from any PLAN connection (J11 plug).
- Power the controller, pressing the UP, ENTER and DOWN keys simultaneously; the following screen will be displayed 2 or 3 seconds later:

Display address
Setting.....:32

I/O Board address:—

- Press the ENTER button to enter the display address setting field and press two times the DOWN key to have the following screen:

Display address
Setting.....:00

- Press ENTER, "Display Address changed" must appear, then power down the controller

2. To modify the controller address (with a display whose address is 0):
- Power up the controller (with the J11 plug disconnected).
 - After 20 seconds, the following screen must appear:

```
#####
Selftest
please wait...
#####
```

As soon as this screen appears, press simultaneously the UP and ALARM keys, the following screen will be displayed:

```
PLAN address: I
UP: increase
DOWN: decrease
ENTER: save & exit
```

Change the controller PLAN address by pressing the UP and DOWN buttons, and then presses ENTER to confirm.

Do these 2 procedures for all the controllers of the PLAN network (address from 1 to 31).

Share the terminal for all the controllers:

- The simplest way to configure a PLAN network is to give to the controllers the addresses from 1 to x and to give to the display(s) the addresses 32, 31, 30
- Connect the 0-address display to the controller previously chosen (powered or not). Once the controller is started (25 seconds after power up and after the Self test screen, then the screen must be empty), press simultaneously the UP, ENTER and DOWN keys, the following screen will appear:

```
Display address
Setting.....:00
```

- Press ENTER to enter the Display address setting field.
- Change the display address by pressing the UP and DOWN buttons.
- Press ENTER. If you have empty screen, or NO LINK or Display Address changed, press again the UP, ENTER and DOWN keys. By pressing ENTER two times, you should be able to modify the I/O Board address. Preferably, put the address of the controller on which the display is connected. Finally, you should see the next screen (for example):

```
Display address
Setting.....:32

I/O Board address:11
```

- Press ENTER

```

Terminal config
Press ENTER
to continue

```

- Press ENTER as recommended
- The following screen will be displayed:

Controller address Display address

```

P:11 Adr Priv/Shared
Trm1 01 Pr — Pr (Private), Sh (Shared) or Sp
Trm2 None —
Trm3 None — Ok?No

```

- In the display address of Trm1, put the address of the display (32 for the example). Press ENTER. In the Pr field of Trm1, put Sh (with the UP and DOWN keys):

```

P:11 Adr Priv/Shared
Trm1 32 Sh
Trm2 None —
Trm3 None — Ok?No

```

- Press ENTER five times. In the No field, put Yes and press ENTER. The first screen of the Rooftop software should be displayed now.

ACCESS TO THE UNITS OF THE PLAN NETWORK VIA THE SINGLE TERMINAL

With all the controllers and one or a few displays configured for PLAN network, it is possible to display the parameters of each unit with one display.

In the main menu (Prg key), select the UNIT SELECTION item. The following screen will be displayed:

```

Press ENTER for L0
change controlled
unit:
Unit n: 11

```

By pressing ENTER, the display will jump to the next available address of controller in the PLAN network. It is not possible to directly select the unit to be displayed.

ALARM MANAGEMENT

When an Alarm is triggered, action is taken on devices, where this option is provided for, and the LED, remote relay and relevant screens are all activated at the same time.

To view the alarm triggered, simply press the Alarm key - you can then use the UP/DOWN keys to scroll through the list and view other alarms that might have been triggered. To reset Alarms in the log, you must call up the alarm screens and press the ALARM key again.

An alarm history is always available where the 150 last alarms are stored. It is possible to reset this history via the maintenance menu. When the clock board is present, the hour and date of appearance of each alarm are also stored.

Code	Alarm description	Action	Reset	Delay	Notes
AL01	Compressor(s) / condensing fan(s) circuit 1 thermal lockout	Circuit 1 OFF	Manual	No	
AL02	Compressor(s) / condensing fan(s) circuit 2 thermal lockout	Circuit 2 OFF	Manual	No	
AL03	Circuit 1 High Pressure lockout	Circuit 1 OFF	Manual	No	
AL04	Circuit 2 High Pressure lockout	Circuit 2 OFF	Manual	No	
AL05	Hot water coil antifreeze alarm	Close the economiser, open the hot water valve	Manual	No	
AL06	High room temperature	/	Manual	Settable	View only
AL07	Low room temperature	/	Manual	Settable	View only
AL08	Circuit 1 Low Pressure lockout	Circuit 1 OFF	Manual	No	
AL09	Circuit 2 Low Pressure lockout	Circuit 2 OFF	Manual	No	
AL10	Compressor 1 circuit 1 maintenance	/	Manual	Settable	View only
AL11	Compressor 1 circuit 2 maintenance	/	Manual	Settable	View only
AL12	Compressor 2 circuit 1 maintenance	/	Manual	Settable	View only
AL13	Compressor 2 circuit 2 maintenance	/	Manual	Settable	View only
AL14	Unit maintenance	/	Manual	Settable	View only
AL15	Main fan thermal lockout	General OFF	Manual	No	
AL16	Dirty filter	/	Manual	Settable	View only
AL17	Summer Set point < Winter Set point - 2	Auto changeover OFF	Manual	No	
AL18	Air Flow-switch	General OFF	Manual	Settable	
AL19	Clock broken or no clock	/	Manual	No	View only

Code	Alarm description	Action	Reset	Delay	Notes
AL20	B1 sensor fail - RAH or IAQ - EP 1	/ Circuit 1 OFF	Manual	60 s	Stops the functions Needed for EEV1
AL21	B2 sensor fail - OAH - EP 2	/ Circuit 2 OFF	Manual	60 s	Stops the functions Needed for EEV2
AL22	B3 sensor fail (OCT 1)	Circuit 1 OFF in winter mode	Manual	60 s	Stops the functions
AL23	B4 sensor fail (OCT 2)	Circuit 2 OFF in winter mode	Manual	60 s	Stops the functions
AL24	B5 sensor fail (Smoke detector converted in digital input)	/	Manual	60 s	Stops the functions
AL25	B6 sensor fail (RAT)	General OFF	Manual	60 s	
AL26	B7 sensor fail - OAT - CST 1	/ Circuit 1 OFF	Manual	60 s	Stops the functions Needed for EEV1
AL27	B8 sensor fail - OAT - CST 2	/ Circuit 2 OFF	Manual	60 s	Stops the functions Needed for EEV2
AL28	Electric Heater 1 thermal lockout	Heater 1 OFF	Manual	No	View only
AL29	Electric Heater 2 thermal lockout	Heater 2 OFF	Manual	No	View only
AL30	Smoke detector	General OFF, parametrable actions on economiser and extractor fan	Automatic	No	
AL31	Circuit 1 High pressure cutout	Circuit 1 OFF	Automatic	No	
AL32	Circuit 2 High pressure cutout	Circuit 2 OFF	Automatic	No	
AL33	Circuit 1 Low pressure cutout	Circuit 1 OFF	Automatic	Yes, fixed*	
AL34	Circuit 2 Low pressure cutout	Circuit 2 OFF	Automatic	Yes, fixed*	
AL35	PLAN network failure (on the Master unit)	/			
AL36	PLAN network failure (on each Slave unit)	/	Manual	Yes, fixed	
AL37...AL66	General alarm of each Plan unit	/	Automatic	No	View only
AL67	B1 sensor fail (I/O expansion RAH OR IAQ)	/	Manual	60 s	Stops the functions
AL68	B2 sensor fail (I/O expansion IAH)	/	Manual	60 s	Stops the functions
AL69	B3 sensor fail (I/O expansion OAT)	/	Manual	60 s	Stops the functions
AL70	B4 sensor fail (I/O expansion SAT)	/	Manual	60 s	Stops the functions
AL71	MI/O expansion communication failure	/	Manual	30 s	Stops the functions
AL72	Main blower thermostat lockout	Gas burner OFF	Manual	No	
AL73	Main blower thermostat cutout	Gas burner OFF	Automatic	No	
AL74	Gas burner internal board alarm	Gas burner OFF	Manual	No	Display and board reset
AL75	Return blower thermal lockout	General OFF	Manual	No	

* with delay from compressors start-up

Manual : The alarm is displayed until a manual reset but the function(s) linked to the alarm automatically restart if the alarm cause is not present any more.

Automatic: The alarm is displayed while the alarm is active and automatically disappears

ALARM LOG

The log is always available. If the board has a clock card fitted, the hour and date of appearance of each alarm are also stored.

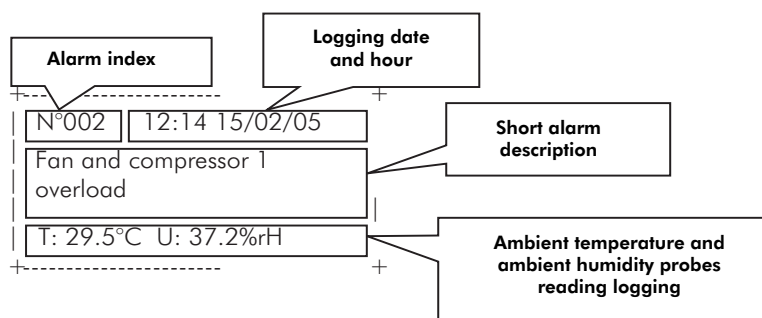

All the alarms are logged.

Select HISTORY from the main menu (Prg button) and press ENTER: the UP/DOWN keys can be used to scroll up and down the list of alarms logged. The number of events in the top left corner increases every time there is a new alarm. The maximum number of events that can be logged is 150. Once the logging limit is reached, new events overwrite the older ones. The alarm log can be cleared completely via the maintenance menu.

ALARM-WARNING SMS

If a GSM modem is connected to the board and configured in the Service menu, the unit also offers the option of sending an alarm-warning SMS.

The SMS is sent the moment the alarm is triggered.

SERVICING

COMPRESSOR AND UNIT HOUR-METER CONTROL

At any time, it is possible to check the number of compressors running hours for unit maintenance.

When the hour-meter of the individual device reaches the set alarm threshold (Maintenance menu), the maintenance alarm related to the relevant device is activated. The maintenance alarm is a warning-only alarm.

INPUTS/OUTPUTS TEST

All the inputs and outputs can be checked in the Inputs/Outputs menu. To see the inputs exactly as they are read by the controller without any setting or conversion, look at the Maintenance menu.

Moreover, it is possible to activate manually all the analogue and the digital outputs, when the unit is switched OFF, via the Maintenance menu.

Be careful : When operating manually the digital outputs, the basic protections are still active and the relevant alarms are still displayed and stored but the devices will stay ON unless the unit is switched ON. In that case, all the manual outputs are reseted to avoid mistakes when the unit is switched OFF again.

MENU DESCRIPTION

Main menu Q0	Item	Screen code	Parameter	Unit	Min	Fact.	Max	Description / Note
MAINTENANCE	General information	A0	Version	-				Software version / Date
			Unit	-				Unit capacity and Heat Pump/Cooling only
	Working time	A1	Unit	h				Unit ON time
		A2	Compressor 1	h				Compressor 1 circuit 1
			Compressor 1B	h				Compressor 2 circuit 1 (dependent on unit configuration)
		A3	Compressor 2	h				Compressor 1 circuit 2 (dependent on unit configuration)
	Password		Compressor 2B	h				Compressor 2 circuit 2 (dependent on unit configuration)
		A4	Maintenance Password	-	0	-	9999	Enter maintenance password.
		A5	Unit	h	1000	20000	200000	Threshold to generate a unit maintenance alarm
		A6	Compressor 1	h	1000	10000	200000	Threshold to generate a compressor 1 circuit 1 maintenance alarm
A7		Compressor 1B	h	1000	10000	200000	Threshold to generate a compressor 2 circuit 1 maintenance alarm	
Working time threshold	A8	Compressor 2	h	1000	10000	200000	Threshold to generate a compressor 1 circuit 2 maintenance alarm	
	A9	Compressor 2B	h	1000	10000	200000	Threshold to generate a compressor 2 circuit 2 maintenance alarm	
	Aa	Unit	N/Y		N		Reset unit working time	
	Working time reset		Compressor 1	N/Y		N		Reset compressor 1 circuit 1 working time
		Compressor 1B	N/Y		N		Reset compressor 1 circuit 2 working time	
		Compressor 2	N/Y		N		Reset compressor 2 circuit 1 working time	
Alarm history		Compressor 2B	N/Y		N		Reset compressor 2 circuit 2 working time	
	Ad	Alarm history reset	N/Y		N		Resets the last 150 alarms stored in the alarm log. (if clock board present)	
Defrost period	Ae	Defrost time Circuit 1/2	min				Cumulative time when OCT<limit to start defrost (only in heat pump units)	
	Af	Room	°C	-9.9	0	9.9	Allows to add an offset to the desired temperature sensor value, if the said sensor is connected.	
Temperature sensors calibration	Ag	Supply	°C	-9.9	0	9.9		
		Outdoor	°C	-9.9	0	9.9		
	Ah	S 1	°C	-9.9	0	9.9	Defrost sensor circuit 1	
		S 2	°C	-9.9	0	9.9	Defrost sensor circuit 2	
Ai	Suction sensors	°C	-9.9	0	9.9	Suction sensors circuit 1 and 2		

Main menu Q0	Item	Screen code	Parameter	Unit	Min	Fact.	Max	Description / Note	
MAINTENANCE	Pressure sensors	Aj	Pressure sensors	bar	-9.9	0	9.9	Evaporating pressure transducers circuit 1 and 2	
		Humidity / Air quality sensors calibration	Ak	Room Humidity	%rH	-99.9	0	99.9	The display shows room humidity or air quality, depending of the option chosen for this analog input. %rH is for % of relative humidity.
	Al		Air Quality	ppm	-99.9	0	99.9		
	Am		Outdoor humidity	%rH	-99.9	0	99.9		
	Real analog inputs	An	Inputs 1 ... 6	-				Analog inputs as they are measured by the board. Values are theoretically contained between -1000 and 1000. If not, the sensor is disconnected or short-circuited.	
		An	Inputs 7, 8 I/O expansion	-					
	Analog inputs after treatment	Ao	Inputs 1 ... 6	-					
		Ap	Inputs 7, 8 I/O expansion	-				Analog inputs after being treated by the board	
	Digital outputs test	Main fan	Aq	Main fan	OFF/ON		OFF		Allows to test the operation of the components when the unit is OFF. Basic securities are still active in this mode. To start the compressors, it is recommended to start the main fan before. When the compressor(s) are started, the EEV (when equipped) are automatically managed except if manually driven (see analog outputs).
				Compressor 1	OFF/ON		OFF		
				Compressor 1B	OFF/ON		OFF		
				Compressor 2	OFF/ON		OFF		
		Reversing valve 1	As	Compressor 2B	OFF/ON		OFF		
				Reversing valve 1	SUM/WIN		SUM		Circuit 1. Choice of Summer or Winter mode
		Electric heater 1	At	Reversing valve 2	SUM/WIN		SUM		Circuit2. Choice of Summer or Winter mode
				Electric heater 1	OFF/ON		OFF		The main fan must be ON to manage manually the electric heaters (option).
	Heat recovery pump	Au	Electric heater 2	OFF/ON		OFF			
		Exhaust/return blower	OFF/ON		OFF		(option)		
		Heat recovery pump	OFF/ON		OFF		(option)		
EEV test		General alarm	OFF/ON		OFF				
		EEV1 manual	N/Y		N		Enables the manual driving of EEV1. BE CAREFUL, when enabled, the automatic management is totally by-passed.		
		EEV1 manual opening	%		O		It is recommended to set the opening before setting to Y the manual management.		
		EEV2 manual	N/Y		N		Enables the manual driving of EEV2.		
	EEV2 manual opening	%		O					

Main menu Q0	Item	Screen code	Parameter	Unit	Min	Fact.	Max	Description / Note	
MAINTENANCE	Digital / Analog outputs test	Aw	Condenser fan 1	OFF/ON/%		OFF/0		The condenser(s) fan(s) are basically driven by the compressors ON/OFF. But if they are driven by analog outputs, they can be tested with an analog value.	
	Analog outputs	Ax	Condenser fan 2	OFF/ON/%		OFF/0			
			Economiser opening	%	0	0	100	(option)	
			Hot water valve	%	0	0	100	Hot water coil proportionnal valve (option)	
			Gas burner capacity	%	0	0	100	When manual output is above 25%, the correspondent digital output activates the gas burner.	
	New password	Ay	New maintenance pwd	-	0	-	9999		
	INPUTS / OUTPUTS	See Alarm log part							
		Temperature sensors	11	Room	°C				Gives the value of each sensor (if present), including the manual offset of the Maintenance part.
				Outdoor	°C				
				Supply	°C				(option)
EEV circuit 1 and 2 dedicated sensors (available only with RTC units)		12	EEV1	%				Electronic Expansion Valve opening (circuit 1)	
			EP1	bar				Evaporating Pressure (circuit 1)	
			CST1	°C				Suction Temperature (circuit 1)	
			EEV2	%				Electronic Expansion Valve opening (circuit 2)	
			EP2	bar				Evaporating Pressure (circuit 2)	
Humidity sensors		13	CST2	°C				Suction Temperature (circuit 2)	
			Room	%rH				(option)	
			Outdoor	%rH				(option)	
Superheat / Air quality		14	Superheat 1	K				Circuit 1 superheat (calculated from EP1 and CST1), only on RTC unit	
			Superheat 2	K				Circuit 2 superheat (calculated from EP2 and CST2), only on RTC unit	
Condensers / defrost sensors		15	Air quality	ppm				(option)	
			Circuit 1	°C				Condenser(s) or defrost sensor(s), depending on Summer or Winter mode and unit configuration	
Enthalpy		16	Circuit 2	°C					
	Room		kJ/kg				If the room humidity sensor is connected		
	Outdoor		kJ/kg				If the outdoor temperature and humidity sensors are connected		
		17	Setpoint	kJ/kg			Calculated from the temperature and humidity setpoints		

Main menu Q0	Item	Screen code	Parameter	Unit	Min	Fact.	Max	Description / Note	
INPUTS / OUTPUTS	Digital inputs	I8	Inputs 1 ...12	-				Digital inputs status	
		I9	Input 13 I/O expansion	-					
	Digital outputs	Ia		Compressor 1	OFF/ON				Digital outputs status
				Compressor 1B	OFF/ON				
				Compressor 2	OFF/ON				
				Compressor 2B	OFF/ON				
	Digital outputs	Ib		Electric Heater 1	OFF/ON				(option)
				Electric Heater 2	OFF/ON				(option)
		Ic		Reversing valve 1	OFF/ON				Circuit 1
				Reversing valve 2	OFF/ON				Circuit2
				Condenser(s) fan(s) 1	OFF/ON				Circuit 1, if the fan(s) are not driven by Inverter
				Condenser(s) fan(s) 2	OFF/ON				Circuit2, if the fan(s) are not driven by Inverter
	Analog outputs	Id		Main fan	OFF/ON				(option)
				Exhaust/return blower	OFF/ON				(option)
				heat recovery pump	OFF/ON				(option)
				burner control	OFF/ON				(option)
		Ie		Economiser/3 dampers	%				(option)
			Hot water coil valve	%				(option)	
			Gas burner capacity	%				(option)	
Modern status	Ih		Condenser(s) fan(s) 1	%				Fan(s) speed, circuit 1, if Inverter	
			Condenser(s) fan(s) 2	%				Fan(s) speed, circuit 2, if Inverter	
								Available if GSM or RS232 selected in screen Pv	

Main menu Q0	Item	Screen code	Parameter	Unit	Min	Fact.	Max	Description / Note	
CLOCK	Clock not available	J0						This screen appears if the clock board is not connected.	
	Hour/Date Setting	K0	Hour	h	0	Hour	23		This screen appears if the clock board is connected.
			Minutes	min	0	Minutes	59		
			Day	-	1	Day	31		
			Month	-	1	Month	12		
			Year	-	05	Year	99		
		Week day	-	-	-	-	-		The day of the week is automatically deduced from the date.
	Password		K1	Clock password	-	0	-	9999	Enter clock password.
	Daily scheduling		K2	Enable	N/Y		N		Daily scheduling enabling. If Yes, the unit operation will be driven by the hour. In all cases, the unit must be set ON manually (screen N0) to allow the unit starting by scheduling. If OFF manually, the unit will <u>always</u> stay OFF.
		Type		ON/OFF / Unoccupied		ON/OFF		When enabling the daily scheduling, 2 zones are defined: in and out the band (in K6). When choosing Unit On/Off, the unit will be OFF outside the band and ON inside the band. When choosing unoccupied, the unit will remain ON. Inside the band, the setpoints are those defined in S0/S1 and the unit runs normally. Outside the band, the setpoints are those defined in K5, and the main fan and the economiser are driven in a different way.	

Main menu Q0	Item	Screen code	Parameter	Unit	Min	Fact.	Max	Description / Note	
CLOCK		K3	Main fan	Always ON / ON on demand		Always ON		This parameter defines the main fan operation when the unoccupied mode is active and the hour is outside the band. In that case, the main fan can remain ON or can be stopped when there is no Heat or Cool demand (compressors, freecooling...).	
			Summer compressors start	N/Y		Y (comp. allowed to start)		In winter mode, the compressors are always allowed to start. In summer mode, it is possible to disable the compressors when the unoccupied mode is active and the hour is outside the band, in order to reduce the electric consumption at night and try to profit to the maximum of the freecooling. If the freecooling is not possible, the room temperature will rise until the hour is inside the band and the unit starts normally.	
		Unoccupied mode	K4	Economiser minimum opening	Closed / Set position (Pi)		Set position		As for the main fan, it is possible to choose the minimum economiser opening when the unoccupied mode is active and the hour is outside the band. At night typically, the economiser is able to close completely if free cooling/heating is not available instead of staying open at a set position (in Pi screen).
				Summer setpoint	°C	STP low limit Sum	26,0	STP high limit	For setpoints limits, see P4 and S0/S1. This setpoint replaces the standard summer setpoint when the unoccupied mode is active and the hour is outside the band.
		Daily scheduling	K6	Winter setpoint	°C	STP low limit	19,0	STP high limit Win	For setpoints limits, see P4 and S0/S1. This setpoint replaces the standard winter setpoint when the unoccupied mode is active and the hour is outside the band.
				Start	h : min	0:00	0:00	23:59	Between Start and End hours, the unit is considered inside the band, otherwise it is outside.
		Weekly scheduling	K7	End	h : min	0:00	0:00	23:59	
				Enable	N/Y		N		This function gives the possibility to program unit OFF/ON according to the day of the week. It is of course possible to associate this function to daily scheduling.
		Scheduling	K9	Week day	N/Y		N		Programming of each day OFF/ON
				Main fan operation unit OFF by scheduling	OFF/ON		OFF		When the unit is OFF by scheduling (hour in ON/OFF daily scheduling, day in weekly scheduling or both), it is possible to choose the main fan operation, contrary to manual unit OFF (screen N0) where the main fan is forced OFF.
	New password	Ka	New Clock pwd	-	0	-	9999		

Main menu Q0	Item	Screen code	Parameter	Unit	Min	Fact.	Max	Description / Note
SETPPOINT	Temperature setpoint	S0	Summer	°C	STP low limit Summer	24,0	STP high limit	Summer setpoint always used except when the unoccupied mode is active and the hour is outside the band. Otherwise, see screen K5. Typically, the summer setpoint is higher than the winter one. However, it is possible to have a maximum winter setpoint higher than summer + 2°C to avoid problems in case of automatic changeover. STP low limit summer = Winter STP - 2
		S1	Winter	°C	STP low limit	21,0	STP high limit Winter	Winter setpoint always used except when the unoccupied mode is active and the hour is outside the band. Otherwise, see screen K5. STP high limit winter = Summer STP + 2
	Humidity setpoint	S2	Summer	%RH	Hum low limit	45,0	Hum high limit	Summer setpoint for humidity. Available only if room humidity sensor is connected. This parameter is used in Summer mode for dehumidification and for enthalpy setpoint calculation if outdoor humidity and temperature sensors are connected.
		S3	Winter	%RH	Hum low limit	50,0	Hum high limit	Winter setpoint for humidity. Available only if room humidity, outdoor humidity and temperature sensors are connected. This parameter is used in Winter mode for enthalpy setpoint calculation.

Main menu Q0	Item	Screen code	Parameter	Unit	Min	Fact.	Max	Description / Note
SERVICE	Password	P0	Service password	-	0	-	9999	
	Compressors enabling	P1	Compressor 1	N/Y		Y		Compressor 1 circuit 1. Allows to stop manually one compressor
			Compressor 1B	N/Y		Y		Compressor 2 circuit 1 (dependent on unit configuration)
		P2	Compressor 2	N/Y		Y		Compressor 1 circuit 2 (dependent on unit configuration)
			Compressor 2B	N/Y		Y		Compressor 2 circuit 2 (dependent on unit configuration)
	Electric heaters enabling	P3	Elec. heater 1	N/Y		Y		Only displayed if the electric heaters are present in the unit (option)
			Elec. heater 2	N/Y		Y		
	Temperature setpoint limit	P4	High	°C	0	30,0		Allows to limit the summer and winter setpoints in the setpoint and clock sections, in addition to the 2°C limitation of the winter setpoint towards the summer one.
			Low	°C	0	12,0		
	Temperature regulation	P5	Regulation type	P/PI		P		Choice of the regulation type for the compressors: P (proportional) or PI (Proportional Integral)
			Integration constant	s	0	600	1800	Integral constant for PI. Be careful when modifying this parameter.
		P6	Summer	°C	0	2,0		Temperature regulation band that corresponds to the proportional parameter in the P or PI summer regulation. See the Compressors control part.
			Winter	°C	0	2,0		Temperature regulation band that corresponds to the proportional parameter in the P or PI winter regulation
			Dead zone	°C	0	0	3,0	Divided by 2, this parameter is the value above or below the setpoint (in summer or winter mode) to start compressors regulation. See the compressors control part.
	Humidity setpoint limit	P7	High	%rH	0	80,0		Allows to limit the summer and winter humidity setpoints in the setpoint section.
Low			%rH	0	20,0		(option)	
Dehumidification	P8	Enabling	N/Y		Y			
		Differential	%rH	0	5,0		See the Dehumidification part.	
Economiser/3 dampers	P9	Dead zone	%rH	0	0			
			Present	N/Y	Y		(option)	

Main menu Q0	Item	Screen code	Parameter	Unit	Min	Fact.	Max	Description / Note
SERVICE	Air quality	Pa	Enabling	N/Y		Y		(option, when available)
			Setpoint	ppm	0	1000	5000	See the Air quality part.
			Differential	ppm	0	500	2000	
	FreeCooling / FreeHeating	Pb	Enable	N/Y		Y		At least outdoor sensor must be connected. See the FreeCooling and FreeHeating control part (option).
			Type of control	Temperature/Enthalpy		Temp.		See the Temperature and Enthalpy based FreeCooling and FreeHeating control parts.
	FreeCooling / FreeHeating in temperature	Pd	Summer FreeCooling enabling	N/Y		Y		
			Winter FreeHeating enabling	N/Y		Y		
			Winter FreeCooling enabling	N/Y		Y		
	FreeCooling / FreeHeating in temp.	Pe	Differential	°C	0	4,0	20,0	Minimum difference between the room and the outdoor temperatures to allow freecooling or freeheating in temperature.
			Offset	°C	-9.9	-2,0	9.9	Difference compared to the summer setpoint to start to open the economiser
	Summer FreeCooling in temp.	Pf	Differential	°C	-9.9	2,0	9.9	Economiser regulation band for summer freecooling
			Offset	°C	-9.9	2,0	9.9	Difference compared to the winter setpoint to finish to close the economiser
Winter FreeHeating in temp.	Pg	Differential	°C	-9.9	2,0	9.9	Economiser regulation band for winter freeheating	
		Differential	kJ/kg	0	5,0	20,0	Economiser regulation band for freecooling/ freeheating in enthalpy	
FreeCooling / FreeHeating in enthalpy	Ph	Atmospheric pressure	hPa	800	1013	1200	Average pressure. Important parameter to calculate the enthalpy	

Main menu Q0	Item	Screen code	Parameter	Unit	Min	Fact.	Max	Description / Note	
SERVICE	Economiser/3 dampers	Pi	Minimum opening setting	Analog In. B2 / Manual		Manual		Choice of the mean to set the minimum economiser opening when the unit is operating in normal mode (not unoccupied). In manual, the set opening is directly a percentage. By analog input, the B2 input is used and must be configured.	
			Manual min. opening	%	0	20	100	Displayed if manual is selected	
			Analog Input type	0-1V, 0-5V 0-20mA, 4-20mA		0-5V			Displayed if analog input is selected. 0-1V, 0-20mA and 4-20mA must be externally supplied. 0-5V can be generated using the 0-5V supply from the J9 connector of the PC board.
			Winter start	Normal / Closed		Normal		In winter start-up (unit set from OFF to ON), when this parameter is set to closed, the economiser will stay totally closed until the room temperature reaches the setpoint.	
	Supply air temperature limitation	Pk	Smoke detection	Closed/Open		Closed			Economiser behaviour when smoke is detected (option). Open corresponds to 100%.
			Enabling	N/Y		Y		This function is active in summer and winter (including winter freecooling) (option).	
			Setpoint	°C	0	8,0	30,0		Minimum supply temperature In summer, below this value, the economiser is set to the minimum opening and the compressors are stopped. In winter, the economiser closes to the minimum position and the hot water coil valve is open (option).
			Differential	°C	0	2,0	10,0		Temperature band to progressively close the economiser (when open by freecooling or air quality in summer and winter) and stop the compressors (in summer)
			Enabling	N/Y		Y			Enables heat recovery pump (option).
			Differential	°C	0	10,0	20,0		Minimum differential between RAT and OAT to run the pump.
Heat recovery	Pm	Minimum damper opening	%	0	20		99	Minimum damper opening (fresh air) to run the pump.	
		Summer enabling	N/Y		N			Enables heat recovery pump in summer mode.	
Setpoint compensation	Pn		Enabling	N/Y		N		See the Setpoint compensation part (option).	

Main menu Q0	Item	Screen code	Parameter	Unit	Min	Fact.	Max	Description / Note
SERVICE	Summer compensation	Po	Outdoor temperature	°C	-10,0	25,0	50,0	Outdoor temperature to start summer setpoint compensation. The goal is to increase the summer setpoint while the outdoor temperature rises.
			Differential	°C	-30,0	10,0	30,0	Temperature band to calculate the compensation value
			Max. compensation	°C	0	5,0	15,0	Maximum summer setpoint compensation
	Winter compensation	Pp	Outdoor temperature	°C	-10,0	10,0	50,0	Outdoor temperature to end winter setpoint compensation. The goal is to decrease the winter setpoint while the outdoor temperature drops.
			Differential	°C	-30,0	10,0	30,0	Temperature band to calculate the compensation value
			Max. compensation	°C	0	3,0	15,0	Maximum winter setpoint compensation
	Automatic changeover	Pq	Enable	N/Y		Y		See the Automatic changeover part.
			Differential	°C	0	3,0	6,0	Minimum difference between the room temperature and the winter setpoint to change to summer mode and between the room temperature and the summer setpoint to change in winter mode, to avoid constant switching between the modes.
	Summer room temp. threshold	Pr	High	°C	-10,0	32,0	50,0	High and low room temperature limits in summer mode to generate a room temperature alarm.
			Low	°C	-10,0	14,0	50,0	High and low room temperature limits in winter mode to generate a room temperature alarm.
	Winter room temp. threshold	Ps	High	°C	-10,0	28,0	50,0	High and low room temperature limits in winter mode to generate a room temperature alarm.
			Low	°C	-10,0	14,0	50,0	High and low room temperature limits in summer mode to generate a room temperature alarm.
	Room high/low temp.	Pt	Alarm delay	min	0	30	600	Time during which the room temperature must stay above the high limit or below the low limit to generate a room temperature alarm.
			Offset	°C	-20,0	-4,0	20,0	Difference compared to the winter setpoint to have both electric heaters ON.
	Electric heaters	Pu	Differential	°C	0	2,0	10,0	Temperature band to regulate the electric heaters stages ON/OFF.
			Enabling	N/Y		N		See the hot water coil part (option, when available).
	Hot water coil valve	Pv	Offset	°C	-20,0	-4,0	20,0	Difference compared to the winter setpoint to have the proportional valve fully open.
			Differential	°C	0	2,0	10,0	Temperature band to regulate the proportional valve opening.
	Gas burner	Pw	Enabling	N/Y		Y		Enables the gas burner operation (option).
			Offset	°C	-20,0	-4,0	20,0	Difference compared to the winter setpoint to run the burner at full capacity.
			Differential	°C	0	2,0	10,0	Temperature band to regulate the proportional burner capacity.

Main menu Q0	Item	Screen code	Parameter	Unit	Min	Fact.	Max	Description / Note
SERVICE	Additional heater balance	Px	OAT limit	°C	-40	-30	-40	Below this OAT limit, auxiliary heater replaces thermodynamic heating.
			Hysteresis differential	°C	0	2	9	Hysteresis on OAT limit to avoid switches between compressors and additional heater when OAT is near the limit.
	Exhaust blower	Py	Enable compressors in extra heating	N/Y		N		Enables the compressors to run in addition to electrical heaters, heating valve or gas burner, when OAT is below OAT limit.
			Eco. Open start	%	0	60	100	Minimum economiser opening to switch the exhaust blower ON (option).
	Air parts presence	PA	Smoke detection	OFF/ON		ON		Exhaust blower behaviour when smoke is detected.
			Air flow switch	N/Y		Y		Possibility to activate or not the air flow switch and the clogged filter switch, in case
			Clogged filter switch	N/Y		Y		of maintenance or failure.
	Defrost	PB	Start delay	min	0	40	120	Cumulative time when the defrost (coil) temperature is below -5°C to start the deicing.
			Maximum duration	min	0	10	20	The defrost ends normally when the defrost temperature exceeds 14°C, but it will also end if it lasts more than the maximum duration.
	Clock presence	PC	Clock board presence	N/Y		Y		This parameter allows to activate the clock board functions when it is not factory mounted. Switching to yes when the board is absent will generate an alarm (option).
	Remote controls Digital inputs	PD	ON/OFF ID5	N/Y		N		Activation of the digital input which can control the unit ON/OFF.
			Summer/Winter ID3	N/Y		N		Activation of the digital input which can control the unit Summer/Winter mode.
	Miscellaneous	PE	ON after blackout	N/Y		Y		Automatic restart of the unit after an electric power cut
			Show language screen at start-up	N/Y		N		Allows to select if the language selection screen appears at each unit start-up. Only English is available for now.
			Random start time	N/Y		Y		If the unit is not a Plan slave, it can start after a random time (60s max) after being switched ON, or after a power failure.
	Supervision	PF	ON/OFF by supervisor	N/Y		N		No parameter written or read by a supervisor needs a manual activation, except the ON/OFF function because all ON/OFF functions (display, digital input, scheduling, supervisor and PLAN) are in series. The supervisor ON/OFF variable at 0 would always lead to unit OFF, even with no supervisor connected.

Main menu Q0	Item	Screen code	Parameter	Unit	Min	Fact.	Max	Description / Note
SERVICE	Communication	PG	Protocol	Reserved / Modbus / Lon/Analog Modem /GSM/Load		Modbus		Modbus needs a supervisor as bus master. Lon is a proprietary protocol. Analog modem is for standard analog modem. GSM is for GSM modem. Load is for software loading with specific tools.
			Identification address	-	0	0	32	See the communication part.
	Modem configuration	PH	Baud rate	bps	1200	9600	19200	
			Maximum numbers	-	1	1	4	Displayed only if Analog Modem is selected for the protocol. The unit modem can call consecutively a maximum of 4 phone numbers at each alarm appearance.
			View number	-	1	1	Max. num.	Allows to set each phone number
			Ring number	-	0	3	9	Displayed with GSM. Number of rings before the modem connection
			Phone number	-	-	-	-	With GSM and Analog Modem
			Modem password	-	0000	0000	9999	Password needed to connect to the unit modem
	SMS	PK	Ring number	-	0	3	9	Displayed with Analog Modem. Number of rings before the modems connection
			Modem type	Tone/Impulse		Tone		
	PLAN network	PL	SMS text	-	-	-	-	Text that will appear on each alarm SMS, in addition to the standard screens, with the hour and date of appearance, alarm code and explanation.
			Enable	N/Y		N		PLAN is to connect directly up to 31 units plus 1 display with not necessarily a supervisor, to share On/OFF, mode, setpoint... between a head unit and the others. This screen is only available on the Master unit. See the multi RoofTops installation part.
Units number			-	1	2	31	Number of units connected to the Plan network. Only on the Master unit	
			Configuration	Disp. Only / MasterSlave		Disp. Only		General Plan network configuration, available on the Master unit (with the PLAN address 1). With Display only, one display on the Master unit 1 gives the possibility to navigate through all the connected units. With Master/Slave, in addition, all the units will run in the same way: ON/OFF, Summer/Winter, Setpoint... It is always possible to have a specified configuration for each unit if the "Master" is in Master/Slave.

Main menu Q0	Item	Screen code	Parameter	Unit	Min	Fact.	Max	Description / Note
SERVICE	PLAN units activation	PM, PN, PO	Each unit activation	N/Y		N		Allows to activate and deactivate some units of the Plan network (only on the Master unit). For example, if one unit must be disconnected, it is necessary to deactivate it, otherwise, an alarm will be generated on the Master unit until the missing unit is connected again.
	PLAN units configuration	PP, PQ, PR	Each unit configuration	D/S		D		Only on Master unit, when the Plan network is configured in Master/Slave. Each unit can be configured in Display only (D) or in Slave (S). In Slave, the unit will run in the same way as the Master unit.
	Thermostat digital inputs configuration	PS	Enabling	N/Y		N		Enables the use of a thermostat to totally run the unit (compressors...)(on demand)
		PT	Summer/Winter	ID2/ID12/B5		B5		Digital input configuration for Summer/Winter selection.
MANUFACTURER	New password	PU	Electrical heaters	ID2/ID12/B6		ID2		Digital input configuration to run the electrical heaters.
			New Service pwd	-	0	-	9999	
		Unit status	N0	Unit status				Factory reserved
ON/OFF UNIT	Unit status	N0	ON/OFF change	Switch ON / OFF				See the Unit ON/OFF part.
	Summer/winter mode	R0	Summer/winter change	-SUMMER- / -WINTER-		SUMMER		Pressing the 'Enter' key switches the unit from ON/OFF to OFF/ON
UNIT SELECTION	Unit selection	L0						Pressing the 'Enter' key switches the unit from Summer/Winter to Winter/Summer, unless auto changeover or Digital input are selected. See the Summer/winter part. Pressing the 'Enter' key makes the display jump to the next available unit of the PLAN network. At least two units must be connected. See the Access to the units of the PLAN network via the single terminal part.

Main screens code	Item	Unit	Description
M0	Hour	-	The hour is displayed if a clock board is present in the controller or if the unit is connected in Plan to a Master unit with a clock board fitted.
	Unit (address)	-	Unit address on the Plan network
	Indoor (room) temperature	°C	Room temperature
			ON : the unit is running correctly.
			OFF by alarm : one or several alarms don't allow the unit to start.
			OFF by PLAN : if the unit is a Slave unit on Plan, it is stopped by the Master unit.
			OFF by Supervisor : if a the unit is connected to a supervisor, it can stop the unit.
			OFF by scheduling : if a clock board is fitted, scheduling can stop the unit.
	Unit status	-	OFF by Digital Input : unit OFF by digital input ID5 (if selected in the Service menu)
			OFF by display : OFF selected via the display ON/OFF
M1	Hour / Date	-	Mode Unoccupied : if a clock board is present and the Unoccupied option is selected for scheduling, the unit is in unoccupied mode if the hour is outside the programmed hour band.
	Air quality / Room humidity / Outdoor temp.	°C %RH ppm	Starting... : appears for 5 seconds at unit start-up.
	Unit status	-	The room air quality is displayed in priority if the option has been chosen. The room humidity is displayed in second priority if the dehumidification or the economiser management in enthalpy have been chosen. Finally, the outdoor temperature is displayed if the economiser management in temperature or the setpoint compensation have been selected.
M2	Hour / Date	-	
	Active temperature setpoint	°C	Temperature setpoint currently used by the unit to regulate the room temperature, determined from the manual setpoints, the unoccupied setpoints and the setpoint compensation
M3	Unit status	-	
	Unit mode	Summer / Winter	
	Scheduling	<input type="checkbox"/> / <input checked="" type="checkbox"/>	Only displayed if the clock board is present. <input checked="" type="checkbox"/> is for function active, <input type="checkbox"/> is for function inactive.
	Dehumidification	<input type="checkbox"/> / <input checked="" type="checkbox"/>	Only displayed if the room humidity sensor is connected.
	Set. compensation	<input type="checkbox"/> / <input checked="" type="checkbox"/>	Only displayed if the outdoor temperature sensor is connected.

Main screens code	Item	Unit	Description
	Defrost	<input type="checkbox"/> / <input checked="" type="checkbox"/>	Only displayed if the unit is heat pump. <input checked="" type="checkbox"/> means that one circuit is deicing.
M4	Freecooling Temp.	<input type="checkbox"/> / <input checked="" type="checkbox"/>	Only displayed if the room and the outdoor temperature sensors are connected and if the economiser has been activated.
	Freeheating Temp.	<input type="checkbox"/> / <input checked="" type="checkbox"/>	Only displayed if the room and the outdoor temperature sensors are connected and if the economiser has been activated.
	Enthalpy Free.	<input type="checkbox"/> / <input checked="" type="checkbox"/>	Only displayed if the room and outdoor temperature and humidity sensors are connected and if the economiser has been activated.
	Air quality	<input type="checkbox"/> / <input checked="" type="checkbox"/>	Only displayed if the air quality sensor is connected and the economiser has been activated.
M5	Electrical heaters	<input type="checkbox"/> / <input checked="" type="checkbox"/>	Only displayed if electrical heaters are present in the unit. <input checked="" type="checkbox"/> means at least one heater is active.
	Heat valve	<input type="checkbox"/> / <input checked="" type="checkbox"/>	Only displayed if hot water coil with modulating valve is present in the unit. <input checked="" type="checkbox"/> means the valve is opened.
	Gas burner	<input type="checkbox"/> / <input checked="" type="checkbox"/>	Only displayed if gas burner is present in the unit. <input checked="" type="checkbox"/> means the gas burner is running.
M6 / M7	Units connected in Plan	-	Only on the Plan Master unit. Displays all the units connected by Plan to the Master unit. If one unit is disconnected, its figure is empty. Screen available if Plan is activated in the Service menu.
M8	Unit Plan configuration	-	Address and configuration of the unit connected by Plan, with a Plan address between 2 and 31

*As part of our ongoing product improvement programme, our products are subject to change without prior notice. Non contractual photos.
Dans un souci d'amélioration constante, nos produits peuvent être modifiés sans préavis. Photos non contractuelles.*

