



Authorised User No. 00007



INSTALLATION, OPERATING & MAINTENANCE MANUAL

Ultima Remote Air Cooled Air Cooled Chiller 75kW - 450kW



ISO 14001
EM552086



ISO 9001
FM00542

About Airedale Products & Customer Services

WARRANTY, COMMISSIONING & MAINTENANCE

The equipment carries Airedale's standard **Parts** (non consumable) & **Labour** warranty for a period of **12 months** from the date of commissioning or **18 months** from the date of despatch, which ever is the sooner. (Excludes the cost of any specialist access or lifting equipment.) Commissioning will be carried out by Airedale International Air Conditioning Ltd or an approved Airedale commissioning company.

To further protect your investment in Airedale products, we have introduced Airedale Service, who can provide full commissioning services, comprehensive maintenance packages and service cover 24 hours a day, 365 days a year (UK mainland). For a free quotation contact our Airedale Service or your local Sales Engineer.

All Airedale products are designed in accordance with EU Directives regarding prevention of build up of water, associated with the risk of contaminants such as Legionella.

Where applicable, effective removal of condensate is achieved by gradient drainage to outlets and where used, humidification systems produce sterile, non-toxic steam during normal operation.

For effective prevention of such risk it is necessary that the equipment is maintained in accordance with Airedale recommendations.

CAUTION

Warranty cover is not a substitute for Maintenance. Warranty cover is conditional to maintenance being carried out in accordance with the recommendations provided during the warranty period. Failure to have the maintenance procedures carried out will invalidate the warranty and any liabilities by Airedale International Air Conditioning Ltd.

SPARES

A spares list for 1, 3 and 5 years will be supplied with every unit and is also available from our Spares department on request.

TRAINING

As well as our comprehensive range of products, Airedale offers a modular range of Refrigeration and Air Conditioning Training courses, for further information please contact Airedale.

AIAC Ltd endeavours to ensure that the information in this document is correct and fairly stated, but none of the statements are to be relied upon as a statement or representation of fact. AIAC Ltd does not accept liability for any error or omission, or for any reliance placed on the information contained in this document.

The development of Airedale products and services is continuous and the information in this document may not be up to date. It is important to check the current position with AIAC Ltd at the address stated. This document is not part of a contract or licence unless expressly agreed.

No part of this document may be reproduced or transmitted in any form or by any means, electronic or mechanical, including photocopying, recording, or information storage and retrieval systems, for any purpose other than the purchaser's personal use, without the express written permission of AIAC Ltd.

© 2004 Airedale International Air Conditioning Limited. All rights reserved. Printed in the UK.

CUSTOMER SERVICES

For further assistance, please e-mail: enquiries@airedale.com or telephone:

UK Sales Enquiries	+ 44 (0) 113 238 7789	uk.sales@airedale.com
International Enquiries	+ 44 (0) 113 239 1000	enquiries@airedale.com
Spares Hot Line	+ 44 (0) 113 238 7878	spares@airedale.com
Airedale Service	+ 44 (0) 113 239 1000	service@airedale.com
Technical Support	+ 44 (0) 113 239 1000	tech.support@airedale.com
Training Enquiries	+ 44 (0) 113 239 1000	marketing@airedale.com

For information, visit us at our Web Site: www.airedale.com

Contents

GENERAL STATEMENT	4
WARRANTY	5
GENERAL DESCRIPTION	6
Unit Identification	6
Introduction	6
Standard Features	6
Optional Extras – Energy Saving	7
Optional Extras – General	8
INSTALLATION DATA	9
Dimensions	9
Point Loadings, Weights & Centre of Gravity (C of G)	10
Unit Lifting	11
Anti Vibration Mounting - Optional	12
Positioning	13
Refrigeration System	14
Pipework Installation - Good Practices	15
Water System	16
Glycol Data	18
Interconnecting Wiring	19
Electrical Data	20
CONTROLS	23
Control Scheme Features	23
Operation	24
Setting up	25
Viewing Unit Operating Status	26
Alarms	27
COMMISSIONING DATA	28
Operating Limits	28
Mechanical Data	28
Waterside Pressure Drops	29
Operational Sequence	30
COMMISSIONING PROCEDURE	31
Pre Commissioning Checklist	31
Commissioning Checklist	33
MAINTENANCE	34
General Maintenance	34
Compressor Maintenance	35
Shut Down Periods	35
PARTS IDENTIFICATION	36
Spares	36



General Statement

IMPORTANT

The information contained in this manual is critical to the correct operation and maintenance of the unit and should be read by all persons responsible for the installation, commissioning and maintenance of this Airedale unit.

SAFETY

The equipment has been designed and manufactured to meet international safety standards but, like any mechanical/electrical equipment, care must be taken if you are to obtain the best results.

- CAUTION**  1 **Service and maintenance of Airedale equipment should only be carried out by Technically trained competent personnel.**
- CAUTION**  2 **When working with any air conditioning units ensure that the electrical isolator is switched off prior to servicing or repair work and that there is no power to any part of the equipment.**
- 3 Also ensure that there are no other power feeds to the unit such as fire alarm circuits, BMS circuits etc
- 4 Electrical installation commissioning and maintenance work on this equipment should be undertaken by competent and trained personnel in accordance with local relevant standards and codes of practice.
- 5 Refrigerant used in this range of products is classified under the COSHH regulations as an irritant, with set Occupational Exposure Levels (OEL) for consideration if this plant is installed in confined or poorly ventilated areas.
- 6 A full hazard data sheet in accordance with COSHH regulations is available should this be required.

Warranty

GENERAL

To be read in conjunction with Airedale International Air Conditioning Ltd standard Conditions of Sale and any related quotation.

The equipment carries Airedale's standard **Parts** (non consumable) & **Labour** warranty for a period of **12 months** from the date of commissioning or **18 months** from the date of despatch, whichever is the sooner. Commissioning must be carried out by Airedale or an approved Airedale company.

WARRANTY IS ONLY VALID IN THE EVENT THAT:

- 1 In the period between delivery and commissioning the equipment:
 - o is properly protected & serviced
 - o water flow safety devices are in place and fully operational
- 2 The equipment is serviced & maintained by Airedale or an approved Airedale company in accordance with the Installation & Maintenance manual provided, during the Warranty Period.

In the event of a problem being reported, Airedale will cover the full cost of rectification (excluding costs for any specialist access or lifting equipment) if warranty is valid under these conditions.

Any spare part supplied by Airedale under the warranty shall be warranted for the unexpired period of the warranty or 3 months from delivery whichever period is the longer, with the exception of compressors on which a further 12 months warranty is granted.

PROCEDURE

- The on site contractor or service company place an official order on Airedale for the replacement part including site labour if required. Airedale will acknowledge this order with detailed prices for components, travel and labour rates.
- Should warranty be accepted, following inspection of the faulty component, a credit note will be issued against the invoice raised in line with the acknowledgement.
- Should warranty be refused the invoice raised against the acknowledgement becomes payable on normal terms.
- Airedale reserves the right to carry out site warranty labour work using their own direct labour or by sub contracting to an approved company of their choice.

EXCLUSIONS

Warranty may be refused for the following reasons:

- Misapplication of product or component.
- Incorrect site installation.
- Incomplete commissioning documentation.
- Inadequate site installation.
- Inadequate site maintenance.
- Damage caused by mishandling.
- Replaced part being returned damaged without explanation.
- Unnecessary delays incurred in return of defective component.

GENERAL

Dead on arrival or manufacturing defects are the responsibility of Airedale and should be reported immediately.

In the event of a warranty failure, dead on arrival or manufacturing defect, the Airedale Service department should be contacted and on receipt of an order, an Airedale engineer (or representative) will be directed to site as soon as possible.

RETURNS ANALYSIS

All faulty components returned under warranty are analysed on a monthly basis as a means of verifying component and product reliability as well as supplier performance. It is important that all component failures are reported correctly.

General Description

UNIT IDENTIFICATION

REMOTE AIR COOLED LIQUID CHILLER	
URAC	Ultima Remote Air Cooled Chiller
75 – 450	Model Size (Expressed as Nominal Cooling in kW)
D	Double Circuit - Standard Chiller
DQ	Double Circuit - Quiet Chiller
DSQ	Double Circuit - Super Quiet Chiller
Example	URAC250DQ

INTRODUCTION

The Airedale range of Ultima Remote Air Cooled liquid chillers covers the nominal capacity range 75kW to 450kW in 45 model sizes incorporating Standard **D**, Quiet **DQ** and Super Quiet **DSQ** variations.

Attention has been placed on maximising the unit's performance while keeping the sound and vibration levels and footprint to an absolute minimum.

The range has been specifically designed for plant room installations.

A matching range of Air Cooled Condensers is available to complement the Remote Air Cooled Liquid Chiller, please refer to Airedale.

CE DIRECTIVE

Airedale certify that the equipment detailed in this manual conforms with the following EC Directives:

Electromagnetic Compatibility Directive (EMC)	89/336/EEC
Low Voltage Directive (LVD)	73/23/EEC
Machinery Directive (MD)	89/392/EEC in the version 98/37/EC
Pressure Equipment Directive (PED)	97/23/EC

To comply with these directives appropriate national & harmonised standards have been applied. These are listed on the Declaration of Conformity, supplied with each product.

REFRIGERANTS

The range has been designed and optimised for operation with the ozone benign R407C refrigerant.

STANDARD FEATURES

Standard Chiller - D

The Standard Ultima Air Cooled Remote Chiller comes complete with:

- **AIRET**ronix Microprocessor Control
- Evaporator Pad Heater
- Multiple Scroll Compressors
- Plate Evaporator
- Connections to Remote Condenser
- Dual Independent Refrigeration Circuits
- Electronic Expansion Valve(s)
- Connections for External Trace Heating (240V/500W available)
- A set of 4 M24 collared eye bolts to BS4278

Quiet Chiller - DQ

With the benefits of the Standard range, the Quiet chiller is supplied with an acoustic package, which incorporates:

- Compressor enclosure lined with Acoustic material

Super Quiet Chiller - DSQ

With the benefits of the Standard range, the Super Quiet chiller is supplied with a Quiet acoustic package, which incorporates the following to become one of the quietest chillers available:

- Compressor enclosure lined with 40mm Acoustic material

General Description

STANDARD FEATURES

Refrigeration

Each refrigeration circuit is supplied with the following:

- Holding charge of nitrogen
- Electronic expansion valve
- Liquid line ball valve
- Discharge line ball valve
- Large capacity filter drier with replaceable cores
- Liquid line sight glass
- Low pressure switch with manual reset via microprocessor controller
- High pressure switch with manual reset
- Suction and liquid pressure transducers
- Pressure relief valve with integral rupture disc and indicator gauge

Controls

As standard, the **AIRETrix** microprocessor controller can provide 4 or 6 stages of capacity control, dependent upon model type.

Optionally, the controller is designed to provide capabilities for;

- Building Management Systems
- Networking
- Sequencing (Master/Slave and Run/Standby)

to meet all your system requirements, please confirm at time of order.

Unit initial set up details can be found in the **Controls** section.

Electrical

Dedicated weatherproof electrical power and controls panels are situated at the end of the unit and contain:

- Separate, fully accessible, controls compartment, allowing adjustment of control set points whilst the unit is operational
- Circuit breakers for protection of all major unit components
- Separate, permanent supply for controls/trace heating, 230v/50Hz/1ph
- The electrical power and control panel is wired to the latest European standards and codes of practice
- Separate door locking electrical isolation for each mains compartment

OPTIONAL EXTRAS – ENERGY SAVING

Power Factor Correction

When applied to the motors of each compressor, the compressor power factor is controlled to a minimum operating value of 0.95 at the full operating capacity. This satisfies many supply authorities that may impose surcharges on equipment with power factor less than 0.95.

General Description

OPTIONAL EXTRAS – GENERAL

Loose Item

- Anti Vibration Mounts
- Victaulic Counterpipe Kit
- Flow Switch
- Water Filter

} Loose Parts Instructions provided

Factory Fitted

- Sequence Control

(CAUTION ▼ : It is only possible to set up sequencing following completion of interconnecting communication wiring. Airedale Service can arrange Sequence setup on request.)

- BMS Interface Card
- Dual Pressure Relief Valve
- Leak Detection Kit (DQ & DSQ Only)
- Electronic Soft Start
- Alternative Refrigerant (Outside EU)

OPTIONAL UNIT COVER

- Commissioning
- Chillerguard® Maintenance

} For details and a competitive quotation, contact Airedale Service.

Installation Data

DIMENSIONS

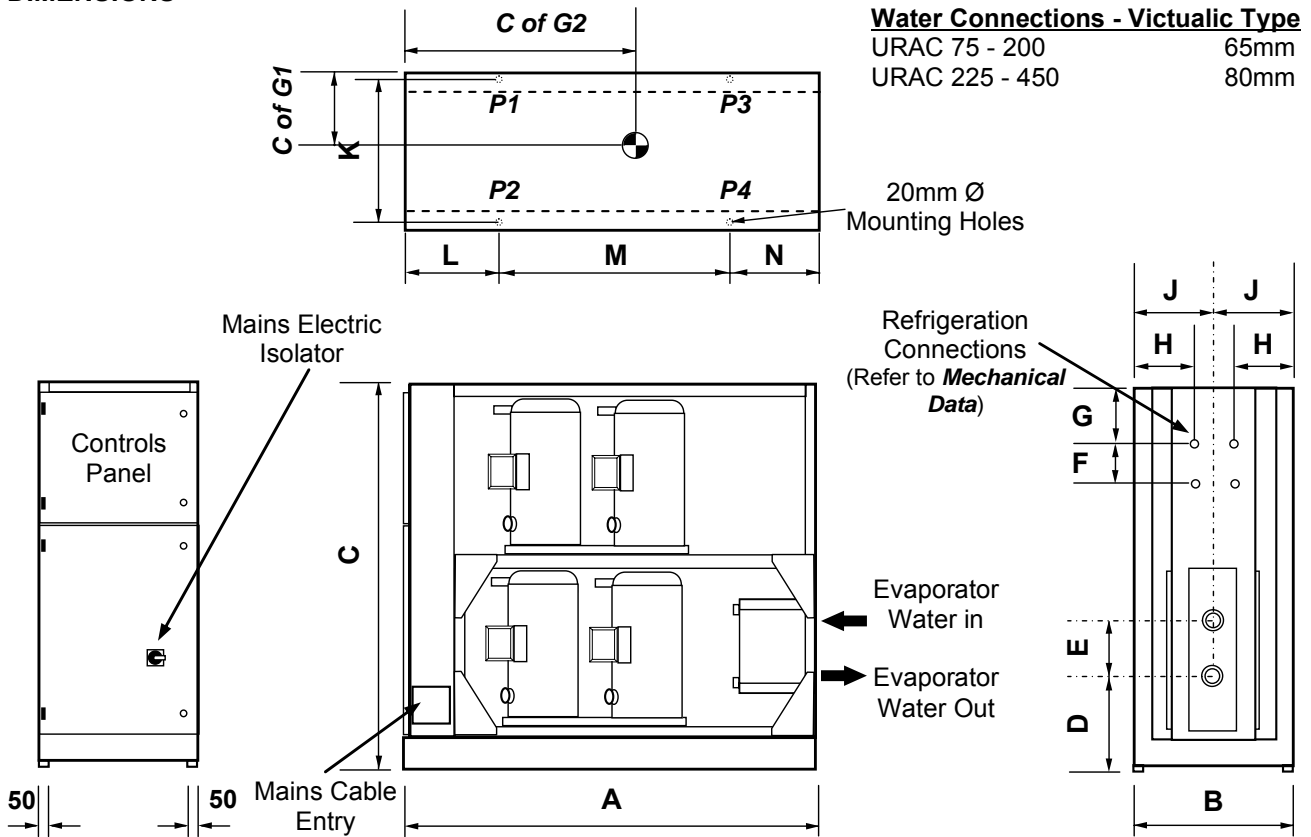

Model Size		A	B	C	D	E	F	G	H	J	K	L	M	N
URAC75	mm	1800	760	1850	383	397	200	220	280	380	710	462	876	462
URAC100	mm	1800	760	1850	383	397	200	220	280	380	710	462	876	462
URAC125	mm	1800	760	1850	383	397	200	220	280	380	710	462	876	462
URAC150	mm	2000	760	1850	380	397	200	220	280	380	710	462	1076	462
URAC175	mm	2000	760	1850	380	397	200	220	280	380	710	462	1076	462
URAC200	mm	2000	760	1850	380	397	200	220	280	380	710	462	1076	462
URAC225	mm	2000	760	1850	268	628	200	220	280	380	710	462	1076	462
URAC240	mm	3200	900	1900	256	628	500	250	250	450	850	970	1730	500
URAC250	mm	2000	760	1850	268	628	200	220	280	380	710	462	1076	462
URAC300	mm	3200	900	1900	256	628	500	250	250	450	850	970	1730	500
URAC330	mm	3200	900	1900	256	628	500	250	250	450	850	970	1730	500
URAC360	mm	3200	900	1900	256	628	500	250	250	450	850	970	1730	500
URAC400	mm	3200	900	1900	256	628	500	250	250	450	850	970	1730	500
URAC450	mm	3200	900	1900	256	628	500	250	250	450	850	970	1730	500

VICTAULIC TYPE FITTING

The unit water services are designed to accept a Victaulic type fitting as illustrated.

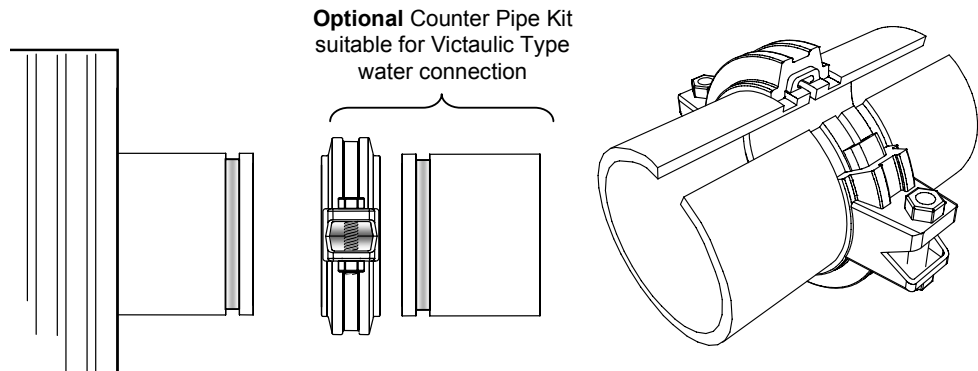

Installation Data

POINT LOADINGS, WEIGHTS & CENTRE OF GRAVITY (C OF G)

Model D		P1	P2	P3	P4	Operating Weight	C of G1 (mm)	C of G2 (mm)
URAC75D	kg	165	165	230	230	790	380	710
URAC100D	kg	175	175	240	240	830	380	710
URAC125D	kg	180	180	250	250	860	380	710
URAC150D	kg	255	255	340	340	1190	380	820
URAC175D	kg	275	275	370	370	1290	380	820
URAC200D	kg	300	300	390	390	1380	380	820
URAC225D	kg	315	315	410	410	1450	380	820
URAC240D	kg	560	560	210	210	1540	450	1442
URAC250D	kg	330	330	430	430	1520	380	820
URAC270D	kg	610	610	230	230	1680	450	1444
URAC300D	kg	660	660	250	250	1820	450	1445
URAC330D	kg	680	680	270	270	1900	450	1462
URAC360D	kg	710	710	280	280	1980	450	1459
URAC400D	kg	750	750	310	310	2120	450	1476
URAC450D	kg	800	800	340	340	2280	450	1486

Model DQ		P1	P2	P3	P4	Operating Weight	C of G1 (mm)	C of G2 (mm)
URAC75DQ	kg	170	170	235	235	810	380	360
URAC100DQ	kg	180	180	248	248	855	380	710
URAC125DQ	kg	190	190	250	250	880	380	360
URAC150DQ	kg	260	260	355	355	1230	380	420
URAC175DQ	kg	285	285	378	378	1325	380	420
URAC200DQ	kg	305	305	405	405	1420	380	820
URAC225DQ	kg	325	325	420	420	1490	380	420
URAC240DQ	kg	580	580	230	230	1620	450	1461
URAC250DQ	kg	340	340	438	438	1555	380	820
URAC270DQ	kg	630	630	250	250	1760	450	1461
URAC300DQ	kg	680	680	270	270	1900	450	1462
URAC330DQ	kg	700	700	280	280	1960	450	1464
URAC360DQ	kg	730	730	300	300	2060	450	1474
URAC400DQ	kg	770	770	320	320	2180	450	1478
URAC450DQ	kg	820	820	350	350	2340	450	1488

Model DSQ		P1	P2	P3	P4	Operating Weight	C of G1 (mm)	C of G2 (mm)
URAC75DSQ	kg	175	175	248	248	845	380	710
URAC100DSQ	kg	190	190	255	255	890	380	700
URAC125DSQ	kg	195	195	263	263	915	380	710
URAC150DSQ	kg	270	270	363	363	1265	380	820
URAC175DSQ	kg	290	290	390	390	1360	380	820
URAC200DSQ	kg	310	310	418	418	1455	380	820
URAC225DSQ	kg	330	330	433	433	1525	380	820
URAC240DSQ	kg	580	580	230	230	1620	450	1461
URAC250DSQ	kg	345	345	450	450	1590	380	820
URAC270DSQ	kg	630	630	260	260	1780	450	1475
URAC300DSQ	kg	680	680	270	270	1900	450	1462
URAC330DSQ	kg	710	710	290	290	2000	450	1472
URAC360DSQ	kg	730	730	300	300	2060	450	1474
URAC400DSQ	kg	780	780	330	330	2220	450	1484
URAC450DSQ	kg	820	820	360	360	2360	450	1498

1 For C of G diagram refer to **Unit Lifting**.

Installation Data

UNIT LIFTING

- Employ lifting specialists.
- Local codes and regulations relating to the lifting of this type of equipment should be observed.
- Use the lifting eye bolts/lifting lugs provided.
- Attach lifting chains to the 4 lifting eye bolts/lifting lugs provided, each chain and eye bolt must be capable of lifting the whole chiller.
- Use the appropriate spreader bars/lifting slings with the holes/lugs provided.
- Lift the unit slowly and evenly.
- If the unit is dropped, it should immediately be checked for damage and reported to Airedale Service.

CAUTION  Only use lifting points provided.

The unit should be lifted from the base and where possible, with all packing and protection in position. If any other type of slinging is used, due care should be taken to ensure that the slings do not crush the casework or coil.

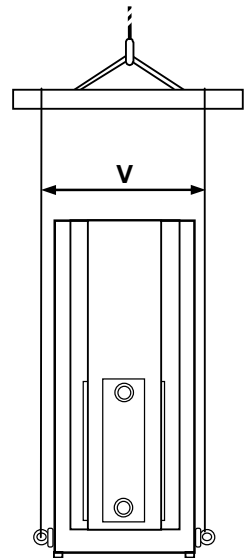
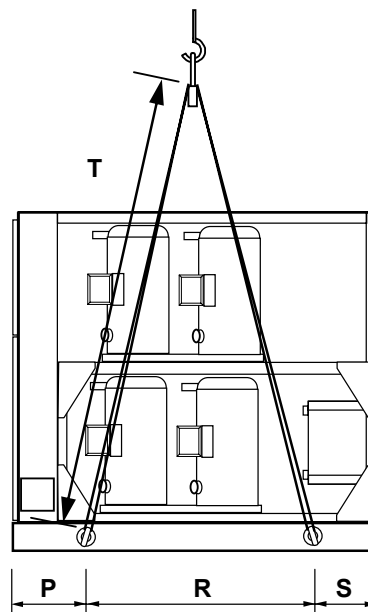
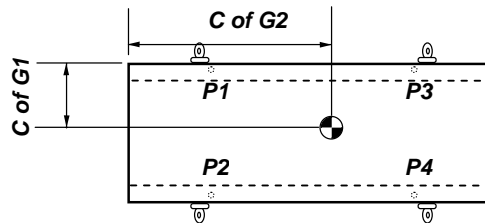

LIFTING DIMENSIONS

		P	R	S	T	V
URAC 75 - 125	mm	370	1060	370	2100	850
URAC 150 - 250	mm	370	1260	370	2100	850
URAC 240 - 450	mm	885	1900	415	2100	990

Date: 18/10/05

MANUAL AFFECTED: TECHNICAL & INSTALLATION

ULTIMA: UCC/UCCU 30-450
UCFC/URAC/UWC75-450
UFC/USC200-750

MANUAL PART NO: 901-108 TM E 02/05/A

CHANGE:

ANTI-VIBRATION MOUNT (SPRING TYPE) SPECIFICATION & INSTALLATION INSTRUCTIONS:

COMPONENTS:

- 1 Locating Screw
- 2 Retaining Nut & Washer
- 3 Levelling Screw
- 4 Levelling Lock Nut
- 5 Retaining Studs
- 6a Upper Retaining Nuts
- 6b Lower Retaining Nuts
- 7 Spring assembly
- 8 Pressure Plate
- 9 Top Plate
- 10 Bolting-down holes

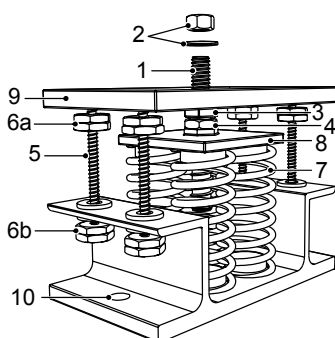

DIMENSIONS:

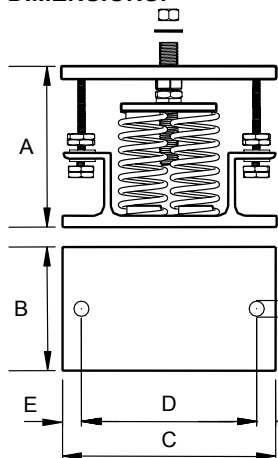

		A ⁽¹⁾	B	C	D	E	FØ
UCC30-70	2 SPRING	136	110	180	148	16	11
UCC75, 80, 100, 125 & 150							
UCCU30-70							
UCCU75, 80, 100, 125 & 150							
UCFC75-150							
UCC110, 130, 160-450	4 SPRING	180	130	225	186	20	16
UCCU110, 130, 160-450							
UCFC160-450							
UFC200-750							
URAC75-450							
USC200-750							
UWC75-450							

- (1) Unloaded dimension
- (2) Refer to relevant **Loose Parts Instructions** sheet for positioning of each mount.

INSTALLATION

- 1 Locate and secure mount using bolting down holes (10) in base plate.
- 2 Ensure mounts are located in line with the unit base.
- 3 If applicable, remove compressor enclosure covers to allow access to mount fixing holes in the unit base.
- 4 Lock the upper retaining nuts (6a) to the underside of the top plate (9) before a load is applied.
- 5 Remove retaining nut and washer (2), lower the unit onto the mounts and replace retaining nut and washer.
- 6 Beginning with the mount with the largest deflection, adjust the height of each mount using the levelling screw (3).

CAUTION **Mountings must be adjusted incrementally in turn. Do not fully adjust 1 mount at a time as this may overload and damage springs.**

7 When all mounts are level, lock each into place using the levelling lock nut (4).

8 Lock all retaining nuts (6a and 6b) to the extreme ends of the retaining studs (5).

CAUTION **Do not connect any services until all anti vibration mounts have been fully adjusted.**

Installation Data

ANTI VIBRATION MOUNTING - OPTIONAL

Spring Type (CLS)

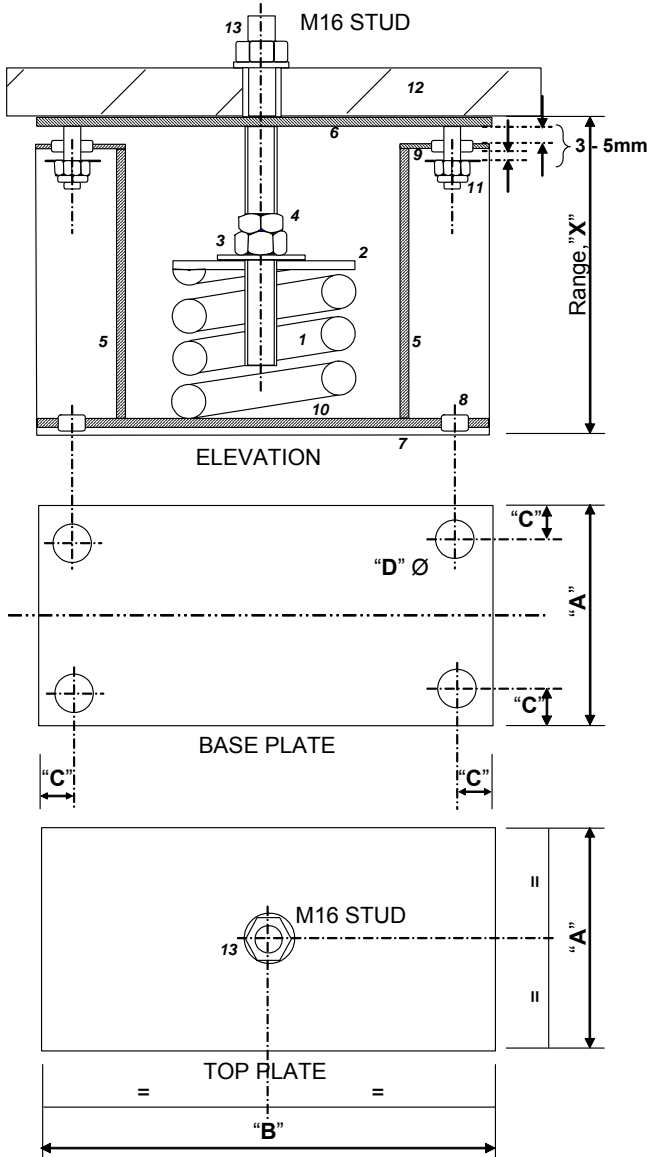

- 1 High deflection steel spring.
- 2 Spring pressure plate.
- 3 Height adjusting nut.
- 4 Locking nut.
- 5 Load bearing supports.
- 6 Load bearing top plate.
- 7 High frequency isolation pad.
- 8 10 dia holding down bolt holes.
- 9 High frequency isolation grommets.
- 10 Steel spring location rings.
- 11 Transportation/restraining bolts.
- 12 Machine frame.
- 13 Machine holding stud/nuts.

Selection:

Model Size	A	B	C	D	Range, X
75 - 250 (ex 240) mm	75	150	15	10	120 - 150
240 - 450 (ex 250) mm	100	200	20	14	180 - 210

Installation:

- 1 Locate and secure mount using bolting down holes provided in base plate.
- 2 Ensure mounts are located in line with the chiller base.
- 3 Position the machine using the centrally located stud, which allows the machine to be bolted down securely.
- 4 Loosen transit bolts and turn nut 3 clockwise until top plate 6 lifts clear of support posts. Tighten lock nut 4 when machine is at desired height and level.
- 5 Adjust and lock nuts on transit bolts such that a small (3-5mm) gap is left between washer and grommet. Refer to diagram.

CAUTION

Mountings must be adjusted in increments of no more than 1mm in turn. Do not adjust 1 mount completely at a time as this may overload and damage springs.

Do not connect any services until all anti vibration mounts have been fully adjusted.

FINALLY, recheck/adjust mounts following unit connection to services and system is filled with water.

Pad Type

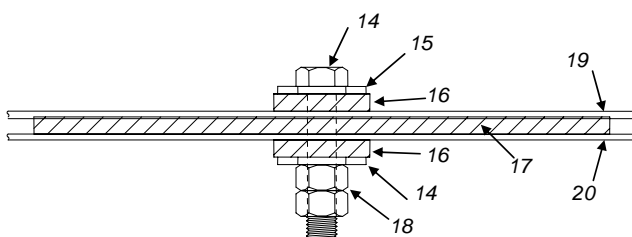

- 14 M16 Bolt (Not Supplied)
- 15 Washer (Not Supplied)
- 16 Fixing Pad 506-063
- 17 A V Pad 506-062
- 18 2 x M16 Nut (Not Supplied)
- 19 Unit Base
- 20 Unit Mounting Plinth

Installation Data

POSITIONING

The installation position should be selected with the following points in mind:

- Position on a stable and even base, levelled to ensure that the compressor operates correctly.
- Levelling should be to +/- 5mm
- Where vibration transmission to the building structure is possible, fit spring anti-vibration mounts and flexible water connections.
- Observe airflow and maintenance clearances.
- Pipework and electrical connections are readily accessible.
- Where multiple units are installed, due care should be taken to avoid the discharge air from each unit adversely affecting other units in the vicinity.

CAUTION  Prior to connecting services, ensure that the equipment is installed and completely level.

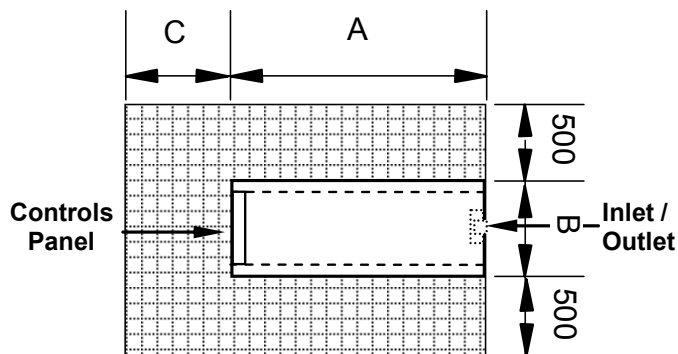

Model Size		A	B	C
URAC75 – URAC125	mm	1800	760	760
URAC150 – URAC250 (Ex. 240)	mm	2000	760	760
URAC240 – URAC450 (Ex. 250)	mm	3200	900	900

Installation Data

REFRIGERATION SYSTEM

Pressure Testing

When installation is complete, fill the system with dry nitrogen to the required PED pressure, (Airedale recommends **27/40 bar**). Record the pressure over a period of time. If there is any reduction in pressure, trace the leak and repair before conducting a further pressure test.

Evacuation

Evacuation for systems operating on R407C(or optional R22) refrigerant should be carried out as follows (for other refrigerants refer to Airedale for advice):

- 1 The procedure should be carried out using a high vacuum pump. The pump should be connected to the high and low pressure sides of the system via a gauge manifold fitted with compound gauges. A high vacuum gauge should be fitted to the system at the furthest point from the vacuum pump.
- 2 Triple evacuation should be used to ensure that all contaminants are removed or at least reduced to significantly low proportions.
- 3 The vacuum pump should be operated until a pressure of 1.5 torr (200 Pa) absolute pressure is reached, at which time the vacuum pump should be stopped and the vacuum broken with oxygen free Nitrogen until the pressure rises above zero.
- 4 The above operation should be repeated a second time.
- 5 The system should then be evacuated a third time but this time to 0.5 torr absolute pressure and broken with the correct refrigerant, until pressures equalise between the charging bottle and the System.

Installation Data

PIPEWORK INSTALLATION - GOOD PRACTICES

Oil Traps

For long vertical rises in discharge lines, it is essential that oil traps are located every 6m to ensure proper oil movement / entrapment. In addition there should be an oil trap at the exit of the chiller before a vertical riser is applied (see example below).

Pipe Supports

The following table identifies the maximum distance between pipe supports on vertical and horizontal pipe runs.

Pipe O/D (inches)	Support distance (m)
3/8 - 5/8	2.0
7/8 - 1 1/8	2.5
1 3/8 - 2.0	3.0

Horizontal Sections

It is good practice to ensure a slight gradient toward the compressor in the direction of the refrigerant flow for suction lines running horizontal. This assists oil return to the compressor. A gradient of approximately 1:200 (0.5%) shall be used.

Condenser above Chiller

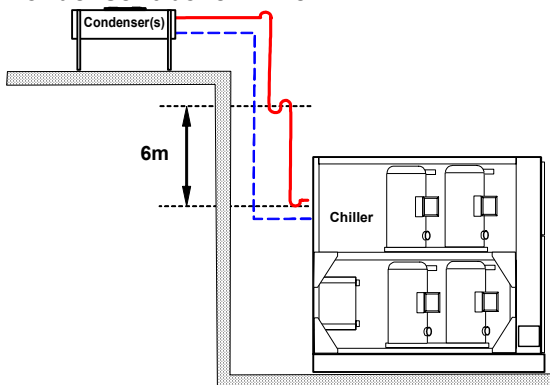

Condenser below Chiller

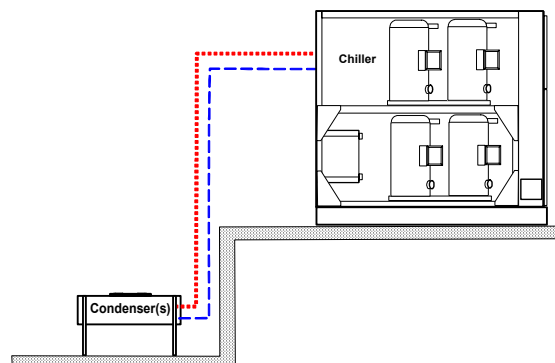

— Discharge Line Liquid

- 1 'U' oil traps to be installed at 6m intervals on suction line only.
- 2 Diagrams show 1 circuit only.



It is the responsibility of the installing contractor/site engineer to check the pipe sizes/refrigerant charge is correct for each system installation and application.

Split systems may require additional oil which should be added to the low side of each compressor.

Design should be in accordance with accepted refrigeration practice to ensure good oil return to the compressor(s) under all normal operating conditions.

Installation Data

WATER SYSTEM

Water pipework and ancillary components must be installed in accordance with:

- National and Local Water supply company standards.
- The manufacturer's instructions are followed when fitting ancillary components.
- The system water is treated to prevent corrosion and algae forming.
- In ambients of 0°C and below and when water supply temperatures of +5°C are required, the necessary concentration of Glycol or use of an electrical trace heater is added where static water can be expected.
- The schematic is referred to as a guide to ancillary recommendations.

CAUTION ▼ The unit water connections are **NOT** designed to support external pipework, pipework should be supported during installation.

The water flow commissioning valve set is not shown in the diagram, as the valve can be fitted elsewhere within the chilled water circuit.

Component Recommended Requirements

The recommended requirements to allow commissioning to be carried out correctly are:

- The inclusion of Binder Points adjacent to the flow and return connections, to allow temperature and pressure readings.
- A flow switch or equivalent, fitted adjacent to the water outlet side of the Chiller.

CAUTION ▼ The correct operation of the flow switch is critical if the chiller warranty is to be valid.

- A 20 mesh strainer fitted prior to the evaporator inlet.
- A water-flow commissioning valve set fitted to the system.
- In multiple chiller installations, 1 commissioning valve set is required per chiller
- Air vents are to be installed at all high points and where air is likely to be trapped at intermediate points.
- Drain points are to be installed at all low points in the system and in particular adjacent to the unit for maintenance to be carried out.
- Isolating valves should be installed adjacent to all major items of equipment for ease of maintenance.
- Balancing valves can be installed if required to aid correct system balancing.
- All chilled water pipework must be insulated and vapour sealed to avoid condensation.
- If several units are installed in parallel adjacent to each other, reverse return should be applied to avoid unnecessary balancing valves.

Standard Recommended Installation (Parts Supplied By Others)

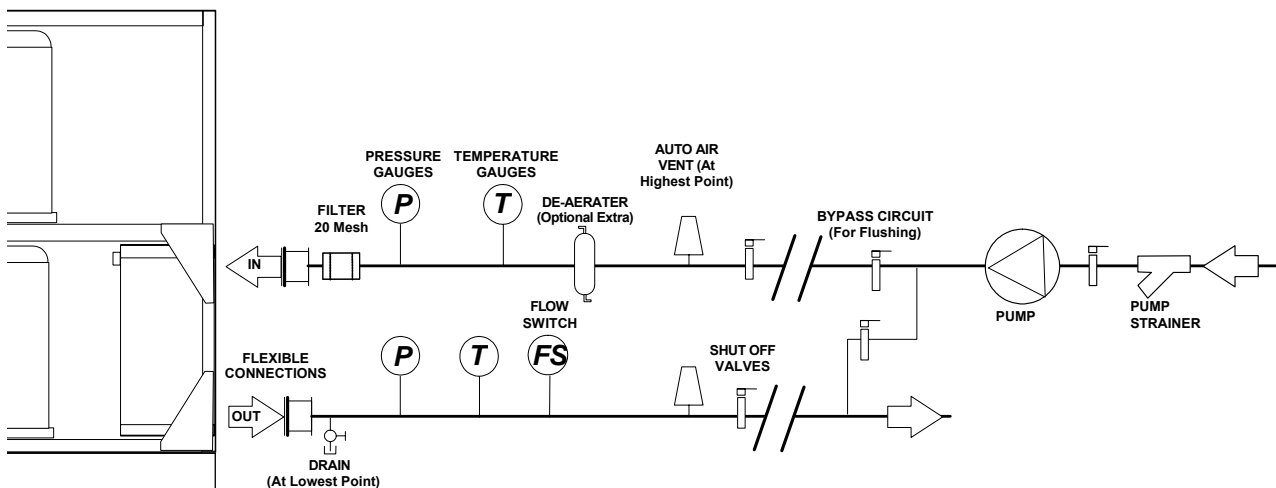

CAUTION ▼ Constant water flow **MUST** be maintained. Variable water volume is **NOT** recommended.

Installation Data

WATER SYSTEM

Pressure Testing

When all the pipework has been connected in the system, proceed as follows:

- Ensure all shut off and control valves are fully open.
- Pressurise system to the operating pressure, hold for 1 hour (a gradual fall in pressure shown on the gauge indicates a leak).
- Leaks should be found and repaired and the unit pressure tested for a further hour.

When the pressure remains at the operating pressure for 1 hour, the system can be considered leak free.

CAUTION ▽ Although a pressure of 1.5 x working pressure is adequate for testing purposes, most local water authorities require 2 x working pressure.

Filling

CAUTION ▽ The whole system **MUST** be flushed prior to filling to remove debris left in the water pipework by using a flushing bypass as shown to avoid serious damage to the plate evaporator.

During filling the system should be vented at all high points.

Once the system has been completely vented all vents should be closed.

To prevent air locking in the system it is advisable to fill the systems from the lowest point, ie drain point on pipework.

If auto air vents are used then we strongly recommend an auto pressurisation unit be fitted to the system.

		URAC75	URAC100	URAC125	URAC150	URAC175
Connections - Evaporator		Suits "Victaulic" type Coupling & Pipe Assembly				
Water Inlet / Outlet	mm / (in)	65 (2 1/2")	65 (2 1/2")	65 (2 1/2")	65 (2 1/2")	65 (2 1/2")
Connections - Condenser						
Discharge Line (brazed)	in	1 1/8	1 1/8	1 3/8	1 5/8	1 5/8
Liquid Line (brazed)	in	7/8	7/8	1 1/8	1 3/8	1 3/8
Water System - Evaporator						
Min. System Water Volume (1)	l	358	489	625	755	696
Max. System Press	Bar	10	10	10	10	10

		URAC200	URAC225	URAC240	URAC250	URAC270
Connections - Evaporator		Suits "Victaulic" type Coupling & Pipe Assembly				
Water Inlet / Outlet	mm / (in)	80 (3")	80 (3")	80 (3")	80 (3")	80 (3")
Connections - Condenser - CCT1						
Discharge Line (Brazed)	in	1 5/8	1 5/8	1 5/8	1 5/8	1 5/8
Liquid Line (Brazed)	in	1 3/8	1 3/8	1 3/8	1 3/8	1 3/8
Connections - Condenser - CCT2						
Discharge Line (Brazed)	in	N/A	N/A	1 5/8	N/A	1 5/8
Liquid Line (Brazed)	in	N/A	N/A	1 3/8	N/A	1 3/8
Water System - Evaporator						
Min. System Water Volume (1)	l	991	890	763	1235	995
Max. System Press	Bar	10	10	10	10	10

		URAC300	URAC330	URAC360	URAC400	URAC450
Connections - Evaporator		Suits "Victaulic" type Coupling & Pipe Assembly				
Water Inlet / Outlet	mm / (in)	80 (3")	80 (3")	80 (3")	80 (3")	80 (3")
Connections - Condenser - CCT1						
Discharge Line (Brazed)	in	1 5/8	2 1/8	2 1/8	2 1/8	2 1/8
Liquid Line (Brazed)	in	1 3/8	1 5/8	1 5/8	1 5/8	1 5/8
Connections - Condenser - CCT2						
Discharge Line (Brazed)	in	1 5/8	1 5/8	2 1/8	2 1/8	2 1/8
Liquid Line (Brazed)	in	1 3/8	1 3/8	1 5/8	1 5/8	1 5/8
Water System - Evaporator						
Min. System Water Volume (1)	l	1029	1289	1286	1498	1539
Max. System Press	Bar	10	10	10	10	10

(1) For minimum system volume, refer to the **Technical Manual**.

Installation Data

GLYCOL DATA

Glycol is recommended when a supply water temperature of +5°C or below is required or when static water can be exposed to freezing temperatures.

Ethylene Glycol Nominal Correction Factors

Glycol in System / Freezing Point °C	10% / -4°C	20% / -9°C	30% / -15°C	40% / -23°C
Cooling Duty	0.98	0.97	0.95	0.93
Input Power	0.99	0.98	0.96	0.95
Water Flow	0.99	1.02	1.04	1.07
Pressure Drop	1.05	1.20	1.38	1.57

Propylene Glycol Nominal Correction Factors

Glycol in System / Freezing Point °C	10% / -2°C	20% / -6°C	30% / -12°C	40% / -20°C
Cooling Duty	0.97	0.95	0.91	0.88
Input Power	0.99	0.98	0.96	0.95
Water Flow	0.98	0.97	0.95	0.95
Pressure Drop	1.08	1.17	1.31	1.45

Example URAC250D operating at 7/12°C water temperature & 45°C dew point, 20% Ethylene Glycol

Cooling kW	(287.3) (refer to <i>Technical Data</i>)	x 0.97	20% Ethylene Glycol =	278.7 kW
Input kW	(77.2) (refer to <i>Technical Data</i>)	x 0.98		75.7 kW
Flow l/s	(13.7) (calculated: $\frac{\text{DX Cooling kW}}{\Delta T \times 4.19}$)	x 1.02		14.0 l/s
Pressure Drop kPa	(47.0) (refer to <i>Waterside Pressure Drops</i>)	x 1.20		56.4 kPa

CAUTION  Waste glycol needs to be handled responsibly, recycled or turned over to professional personnel for correct disposal. Most anti-freeze manufacturers recommend that used anti-freeze be collected and disposed according to Local Legislation. Waste glycol should NOT be drained onto the ground, rainwater drainage system or natural waters.

If the glycol contains heavy metals or other contaminants from gas or oil, the level of hazard posed by the glycol is increased and could be characterised as hazardous waste.

STEPS IF GLYCOL IS RELEASED/SPILLED

Small spill - soak up with absorbent material.

Large spill - contain spill and pump to suitable container for disposal.

Installation Data

ELECTRICAL DATA

General

- As standard the equipment is designed for 400V, 3 phase, 3 wire 50Hz and a separate permanent 230V, 1 phase, 50Hz supply, to all relevant IEE regulations, British standards and IEC requirements.
- A fused and isolated electrical supply of the appropriate phase, frequency and voltage should be installed.
- The control voltage to the interlocks is 24V. Always size the low voltage interlock and protection cabling for a maximum voltage drop of 2V.

CAUTION ⚠ **Wires should be capable of carrying the maximum load current under non-fault conditions at the stipulated voltage.**

- Avoid large voltage drops on cable runs, particularly low voltage wiring.
- Once the connecting pipework is complete the electrical supply can be connected by routing the cable through the appropriate casing hole and connecting the cables, refer to the **Wiring Diagram** supplied with each unit.

CAUTION ⚠ **A separately fused, locally isolated, permanent single phase and neutral supply MUST BE FITTED for the compressor sump heater, evaporator trace heating and control circuits, FAILURE to do so could INVALIDATE WARRANTY.**

Interlocks & Protection

Always electrically interlock the operation of the chiller with the pump controls and water flow switch.

These safety devices prevent the chiller operating with low water flow which can cause serious damage.

CAUTION ⚠ **Failure to install both safety devices will invalidate the chiller warranty.**

CAUTION ⚠ **Do not rely solely on the BMS to protect the chiller against low flow conditions.**

An evaporator pump interlock and flow switch MUST be directly wired to the chiller, refer to *Interconnecting Wiring* diagram.

INTERCONNECTING WIRING

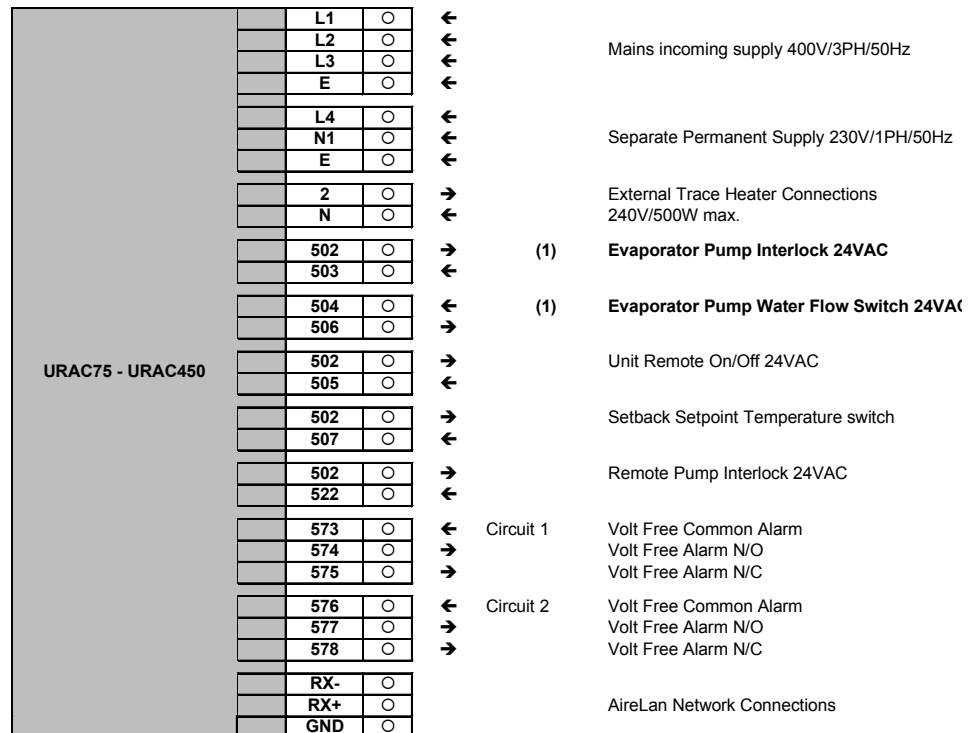

CAUTION ⚠ **(1) MUST be directly wired to the chiller to validate warranty.**

Installation Data

ELECTRICAL DATA			URAC75	URAC100	URAC125	URAC150	URAC175
Unit Data							
Nominal Run Amps	(1)	A	46	57	65	80	90
Maximum Start Amps	(2)	A	134	170	216	258	290
Permanent Supply		VAC			230V 1PH 50Hz		
Mains Supply		VAC			400V 3PH 50Hz		
Rec Permanent Fuse Size		A	16	16	16	16	16
Rec Mains Fuse Size		A	63	80	100	125	125
Max Permanent Incoming Cable Size		mm ²			4 mm ² terminals		
Max Mains Incoming Cable Size		mm ²			70 (direct to MCCB)		
Control Circuit		VAC			24V/230VAC		
Evaporator							
Pad Heater Rating		W	40	40	40	80	100
External Trace Heating							
Available (fitted by others)		W	500	500	500	500	500
Compressor - Per Compressor							
Quantity			4	4	4	4	2+2
Motor Rating		kW	5.3	7.3	9.1	10.9	10.9/14.4
Nominal Run Amps	(1)	A	11.5	14.2	16.3	20.0	20.0/25.2
Crankcase Heater Rating		W	70.0	70.0	70.0	70.0	70.0/120.0
Start Amps	(2)		99	127	167	198	198/225
Type Of Start					Direct on line		
OPTIONAL EXTRAS							
Power Factor Correction							
Nominal Run Amps	(1)	A	41	51	58	72	81
Maximum Start Amps	(2)	A	130	165	211	252	283
Recommended Mains Fuse		A	63	80	100	100	125
Compressor Nominal Run Amps - Per Compressor		A	10.3	12.7	14.6	17.9	17.9/22.5
Electronic Soft-Start							
Nominal Run Amps	(1)	A	46	57	65	80	90
Maximum Start Amps	(2)	A	90	119	149	179	200
Recommended Mains Fuse		A	63	80	100	125	125

- (1) Based at 12/7°C water and 45°C dew point
 (2) Starting amps refers to the direct on line connections.

Installation Data

ELECTRICAL DATA			URAC200	URAC225	UWC240	URAC250	UWC270
Unit Data							
Nominal Run Amps	(1)	A	101	115	120	129	141
Maximum Start Amps	(2)	A	301	355	298	369	314
Permanent Supply		VAC			230V 1PH 50Hz		
Mains Supply		VAC			400V 3PH 50Hz		
Rec Permanent Fuse Size		A	16	16	16	16	16
Rec Mains Fuse Size		A	160	160	160	200	200
Max Permanent Incoming Cable Size		mm ²			4 mm ² terminals		
Max Mains Incoming Cable Size		mm ²			70 (direct to MCCB)		
Control Circuit		VAC			24V/230VAC		
Evaporator							
Pad Heater Rating		W	100	100	100	100	100
External Trace Heating							
Available (fitted by others)		W	500	500	500	500	500
Compressor - Per Compressor							
Quantity			4	2+2	3+3	4	3+3
Motor Rating		kW	14.4	14.4/17.9	10.9/10.9	17.9	10.9/14.4
Nominal Run Amps	(1)	A	25.2	25.2/32.2	20.0/20.0	32.2	20.0/25.2
Crankcase Heater Rating		W	120.0	120.0/150.0	70.0/70.0	150.0	70.0/120.0
Start Amps	(2)		225	225/272	198/198	272	198/225
Type Of Start					Direct on line		
OPTIONAL EXTRAS							
Power Factor Correction							
Nominal Run Amps	(1)	A	90	103	112	115	126
Maximum Start Amps	(2)	A	293	346	288	358	301
Recommended Mains Fuse		A	125	160	125	160	160
Compressor Nominal Run Amps - Per Compressor		A	22.5	22.5/28.8	17.9/17.9	28.8	17.9/22.5
Electronic Soft-Start							
Nominal Run Amps	(1)	A	101	115	120	129	141
Maximum Start Amps	(2)	A	211	246	219	260	234
Recommended Mains Fuse		A	160	160	160	200	200

- (1) Based at 12/7°C water and 45°C dew point
 (2) Starting amps refers to the direct on line connections.

Installation Data

ELECTRICAL DATA			URAC300	URAC330	URAC360	URAC400	URAC450
Unit Data							
Nominal Run Amps	(1)	A	158	180	201	228	252
Maximum Start Amps	(2)	A	376	412	433	497	522
Permanent Supply		VAC			230V 1PH 50Hz		
Mains Supply		VAC			400V 3PH 50Hz		
Rec Permanent Fuse Size		A	16	16	16	16	16
Rec Mains Fuse Size		A	200	250	250	315	315
Max Permanent Incoming Cable Size		mm ²			4 mm ² terminals		
Max Mains Incoming Cable Size		mm ²			70 (direct to MCCB)		
Control Circuit		VAC			24V/230VAC		
Evaporator							
Pad Heater Rating		W	100	100	100	100	100
External Trace Heating							
Available (fitted by others)		W	500	500	500	500	500
Compressor - Per Compressor							
Quantity			3+3	3+3	3+3	3+3	3+3
Motor Rating		kW	14.4/14.4	17.9/14.4	17.9/17.9	22.5/17.9	22.5/22.5
Nominal Run Amps	(1)	A	25.2/25.2	32.2/25.2	32.2/32.2	40.3/32.2	40.3/40.3
Crankcase Heater Rating		W	120.0/120.0	150.0/120.0	150.0/150.0	150.0/150.0	150.0/150.0
Start Amps	(2)		225/225	272/225	272/272	320/272	320/320
Type Of Start					Direct on line		
OPTIONAL EXTRAS							
Power Factor Correction							
Nominal Run Amps	(1)	A	141	161	180	204	226
Maximum Start Amps	(2)	A	363	397	416	479	501
Recommended Mains Fuse		A	200	200	200	250	315
Compressor Nominal Run Amps - Per Compressor		A	22.5/22.5	28.8/22.5	28.8/28.8	36.1/28.8	36.1/36.1
Electronic Soft-Start							
Nominal Run Amps	(1)	A	158	180	201	228	252
Maximum Start Amps	(2)	A	276	303	324	369	394
Recommended Mains Fuse		A	200	250	250	315	315

- (1) Based at 12/7°C water and 45°C dew point
 (2) Starting amps refers to the direct on line connections.

AIRETronix - Controls

CONTROL SCHEME FEATURES

Airedale recognises that all chiller applications are different but fall mainly into 2 application categories; Variable Supply Temperature and Constant Supply Temperature.

The onboard microprocessor has the capability of satisfying either control requirement as illustrated below. Using the Airedale Variable Supply Temperature control scheme, energy savings are available when compared with previous schemes and that of the Constant Supply Temperature application.

Variable Supply Temperature control schemes offer energy savings where the supply water temperature is not critical to its operation.

Selection of the best application control scheme can be made via a soft switch in the microprocessor during initial commissioning.

Examples based on Models URAC200D having 6 Stages of Cooling

Variable Supply Temperature Control

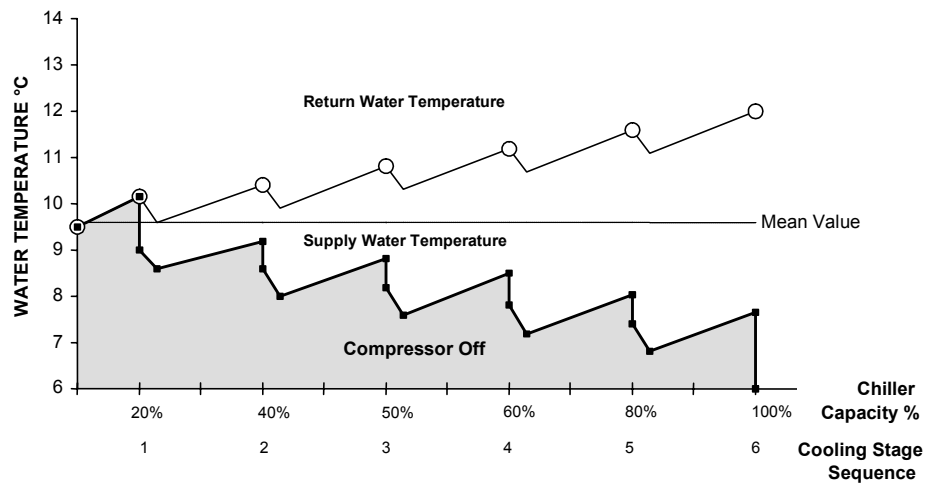

Constant Supply Temperature Control

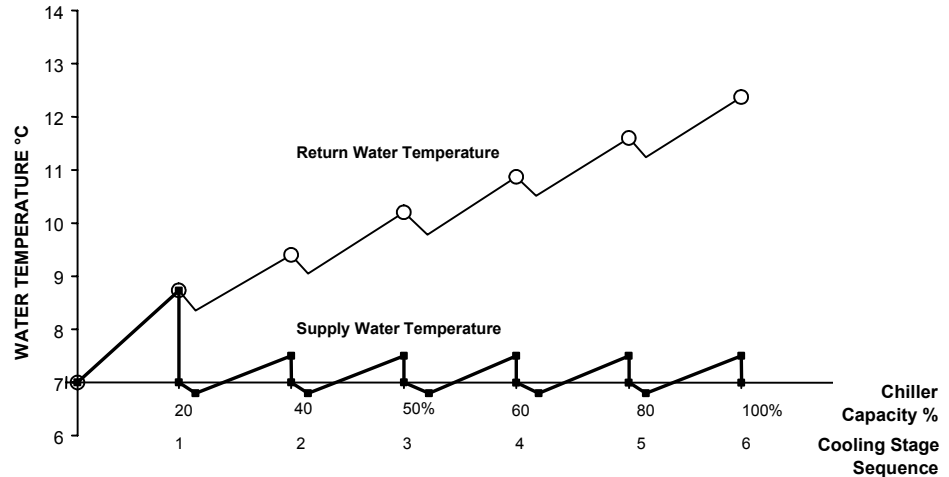

CAUTION Factory set to Variable Supply Temperature Control unless otherwise stated at order.

Only when the mode selection has been set can the unit be enabled.

AIRETronix - Controls

GENERAL

The microprocessor controller offers powerful analogue and digital control to meet a wide range of monitoring and control features including a real time clock and Industry standard communication port and network connections.

The controller's inbuilt display is used for viewing the unit operating status and making adjustments to control parameters by allowing the operator access to a series of display pages.

OPERATION

Standard Keypad /Display

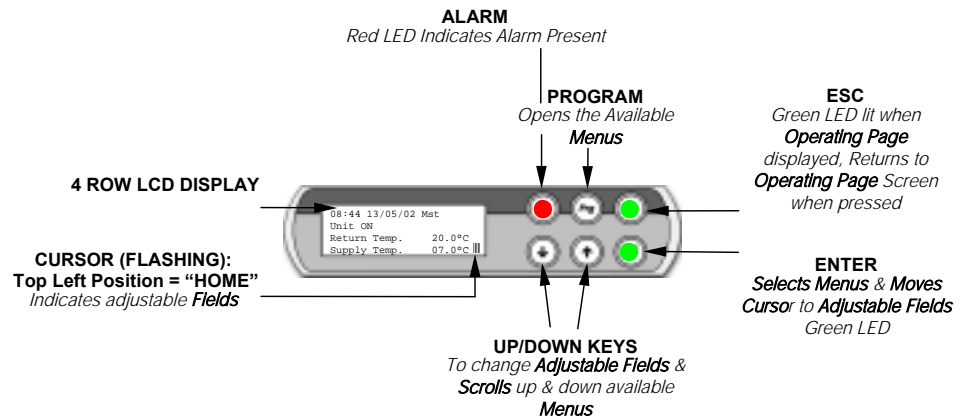

Navigation

The display is used for **Viewing Unit Operating Status** and **Adjusting Customer Control Settings** by allowing the operator access to a series of **Menus & sub-menus**. Viewing information is unrestricted, however set up and adjustment requires password entry, refer to **Password Protection**.

Initially, use the **Prg** key to **access Menus**, the symbol ← will appear top right and the first menu will appear in CAPITALS, these **indicators** shows which menu is selected.

Use the **↓** **↑** keys to **move the indicator ←** to the desired menu and press **↩** to **open the menu**.

Use the **↩** key to **move the flashing cursor █** to adjustable **fields** and the **↓** **↑** keys to change the values.

Press the **↩** key to **move the cursor to the next field or Home**.

When the cursor is **Home** either use the **↓** **↑** keys to scroll to next **sub-menu** or the **Esc** to **exit and return to the Standard Operating page**.

Standard Operating Page

The **Operating Page** will appear and remain present following start up of the controller as illustrated:

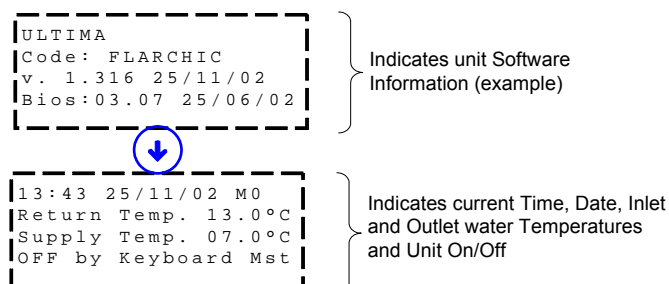

AIRETronix - Controls

OPERATION (CONT..)

Standard Operating Page cont.

The following **Menus** can be accessed from the **Operating Page**, it is recommended that the display is always returned to the **Operating Page** by using the  key

Password Protection

To guard against unauthorised adjustments, a password is required to gain access to certain menus as defined below.

FACTORY SET PASSWORD PIN NUMBER: 4648 (or Customer chosen number).



When a password is requested use the   keys to enter the number and  to access the page.

Menus (Listed in Sequence)

Menu	Description	Password
Switch On/Off	Enable or Disable the unit	Open Access
Service	Allows selection of setpoint limits, enables unit on/off from display, remote on/off and remote pump on/off.	Default 4648
Setpoint	Allows setpoint adjustment, includes supply temperature setpoint and unit temperature differential.	Default 4648
Status	Displays current status on digital and analogue inputs and outputs.	Open Access
Maintenance	Displays hours run for compressors and pumps (if fitted). Also includes Electronic Expansion Valves (if fitted).	Default 4648
Clock	Allows adjustment of real time clock, time zones	Default 4648
Alarm Log	Display last 100 alarms in chronological order.	Open Access
Manufacturer	Factory use only.	Airedale Only

SETTING UP

Unit ON/OFF

By pressing the  and  simultaneously for approximately 5 seconds, the unit operation will stop or start. The unit can also be enabled through the Switch On/Off menu.

Real Time Clock

The units leave the factory set, however follow the **Navigation** instructions if necessary.

Time Zones

The programme provides 3 On/Off periods per day, 7 days per week. The unit is factory set for continuous operation.

Technical Support

For further details, please contact Airedale.

AIRETronix - Controls

VIEWING UNIT OPERATING STATUS

Status Menu

Allows access to view operating status of Digital and Analogue Inputs and Outputs.

Using the **Navigation** instructions, the following **Sub-Menus** shown in sequence can be accessed:

Digital Inputs	
ID1	Phase Rotation (Optional) or MCCB status
ID2	Emergency Stop
ID3	Evaporator Flow Switch
ID4	Remote On/Off (Optional)
ID5	Compressor 1 Contactor Status
ID6	Compressor 2 Contactor Status
ID7	Compressor 3 Contactor Status
ID8	Compressor 4 Contactor Status
ID9	Circuit 1 Low Pressure Switch
ID10	Circuit 2 Low Pressure Switch
ID11	Pump 1 Contactor Status (Optional) or Remote Pump Interlock
ID12	Pump 2 Contactor Status (Optional)
ID13	Remote Pump On/Off (Optional)
ID14	Remote Summer/Winter Or Night Setback (Optional)
ID15	Not Used
ID16	Not Used
ID17	Compressor 5 Contactor Status
ID18	Compressor 6 Contactor Status

Analogue Inputs Standard	
B1	Circuit 1 Liquid Pressure
B2	Circuit 2 Liquid Pressure
B3	Circuit 1 Suction Pressure (Not connected with EEV option) or Leak Detector
B4	Return Water Temperature
B5	Supply Water Temperature
B6	Circuit 2 Suction Pressure (Not connected with EEV option) or Leak Detector
B7	Chilled Water Differential Pressure (Optional)
B8	Remote Setpoint Adjustment or Condenser Water Inlet
B9	Evaporator Inlet Water or Coil 1 Temperature
B10	Ambient or Coil 2 Temperature

Analogue Inputs Fitted with Electronic Expansion Valve Option (EEV)	
B1	Circuit 1 & Circuit 2 Suction Temperature
B3	Circuit 1 & Circuit 2 Suction Pressure

Digital Outputs	
NO1	Compressor Contactor 1
NO2	Compressor Contactor 2
NO3	Pump 1 Contactor (Optional)
NO4	Compressor Contactor 3
NO5	Compressor Contactor 4
NO6	Pump 2 Contactor (Optional)
NO7	Circuit 1 Condenser Coil Valve 1
NO8	Circuit 1 Condenser Coil Valve 2
NO9	Circuit 2 Condenser Coil Valve 1
NO10	Circuit 2 Condenser Coil Valve 2
NO11	Not Used
NO12	Alarm Circuit 1
NO13	Alarm Circuit 2
NO14	Circuit 1 Reversing Valve
NO15	Circuit 2 Reversing Valve
NO16	Supplementary Heat
NO17	Compressor 5 Contactor
NO18	Compressor 6 Contactor

Analogue Outputs	
Y1	Not Used
Y2	Circuit 1 & 2 Condenser Fan Speed Controller (Modulated Head Pressure Control)
Y3	Circuit 2 Condenser Fan Speed Controller (Modulated Head Pressure Control)

AIRETronix - Controls







ALARMS

The controller logs and allows viewing of the last 100 conditions recorded in descending chronological order.

```

13/05/02      11:32
Event number   001
Alarm Active
37-Diff Pressr Evap
    
```

Alarm Handling

- 1 A **Red LED** behind the **Alarm**  key will light in the event of an alarm. To view the alarms, simply press the  key and the   keys to scroll through.
- 2 Auto reset alarms will clear following this first depression of the **Alarm**  key. If however the **Red LED** behind the **Alarm**  key remains illuminated, the unit requires some form of manual reset.
- 3 For manual reset alarms, isolate the affected circuits before further investigation.
- 4 To reset or delete the alarms displayed in the alarm screen, simply press  again.

COMMON ALARMS

Outlined below is a selection of Common Alarms, a full list is available, please contact Airedale.

Phase Rotation

A normally closed contact. When Phase Rotation is incorrect all controller outputs are de-activated.

Emergency Stop

A normally open contact. On closing, all controller outputs are de-activated.

Evaporator Flow Failure

A normally closed contact. On opening, all controller outputs are de-activated.

Low Supply Temperature

Supply Water Temperature Low Limit alarm is generated when the supply water temperature falls below the low limit value set. All controller outputs are de-activated.

INDIVIDUAL CIRCUIT ALARMS

Outlined below is a selection of Individual Circuit Alarms, a full list is available, please contact Airedale.

Electronic Expansion Valve Failure

This indicates that the electronic expansion valve controller has detected an operating problem.

Low Suction Pressure

When the suction pressure sensor value falls below the value set by the low suction level for a period exceeding 1 minute (or 3 minutes on compressor start-up), a visual alarm will be generated at the in-built display and the relevant compressor will be de-activated. On units with tandem compressors, both compressors from the same circuit will be switched off.

High Liquid Pressure

When the liquid pressure reaches 25 BarG, the relevant circuit will be switched off and an alarm activated, this can only be rectified by manual reset via the microprocessor.

Compressor Status

A normally closed contact when the compressor is operating. If this contact remains open for a period of 3 seconds during operation of the compressor, a visual alarm is generated and the relevant compressor will be de-activated. This alarm comprises of compressor motor protection module, discharge gas thermostat and safety high pressure switch.

Commissioning Data

OPERATING LIMITS (For 100% Water)

Minimum Ambient Air DB °C	-5°C
Maximum Ambient Air DB °C	Refer to <i>Technical Manual</i>
Minimum Leaving Water Temperature °C	+6°C
Maximum Return Water Temperature °C	+20°C

- 1 Temperatures lower than those stated can be obtained with the addition of glycol.
 2 For conditions outside those quoted, please refer to Airedale.

MECHANICAL DATA

Oil & Refrigerant Charges

	URAC75	URAC100	URAC125	URAC150	URAC175
Compressor	Tandem Scroll – Hermetic				
Quantity	4	4	4	4	4
Oil Charge Volume (Total) l	4 x 4.1	4 x 4.1	4 x 4.1	4 x 4.1	2 x 4.7 + 4.1
Oil Type	Polyol Ester				
Refrigeration	Dual Circuit				
Refrigerant Control	Electronic Expansion Valve				
Refrigerant Type	R407C				
Holding Charge	Dry Nitrogen				

	URAC200	URAC225	URAC240	URAC250	URAC270
Compressor	Tandem Scroll - Hermetic		Trio Scroll – Hermetic	Tandem Scroll - Hermetic	Trio Scroll – Hermetic
Quantity	4	4	6	4	6
Oil Charge Volume (Total) l	4 x 4.7	2 x 6.3 + 4.7	6 x 4.1	4 x 6.3	3 x 4.7 & 3 x 4.1
Oil Type	Polyol Ester				
Refrigeration	Dual Circuit				
Refrigerant Control	Electronic Expansion Valve				
Refrigerant Type	R407C				
Holding Charge	Dry Nitrogen				

	URAC300	URAC330	URAC360	URAC400	URAC450
Compressor	Trio Scroll - Hermetic				
Quantity	6	6	6	6	6
Oil Charge Volume (Total) l	6 x 4.7	2 x 6.3 + 4.7	6 x 6.3	3 x 5.9 & 3 x 6.3	6 x 5.9
Oil Type	Polyol Ester				
Refrigeration	Dual Circuit				
Refrigerant Control	Electronic Expansion Valve				
Refrigerant Type	R407C				
Holding Charge	Dry Nitrogen				

Commissioning Data

WATERSIDE PRESSURE DROPS

CAUTION  Constant water flow **MUST** be maintained. Variable water volume is **NOT** recommended.

UWC75 – UWC250
(Except UWC240)

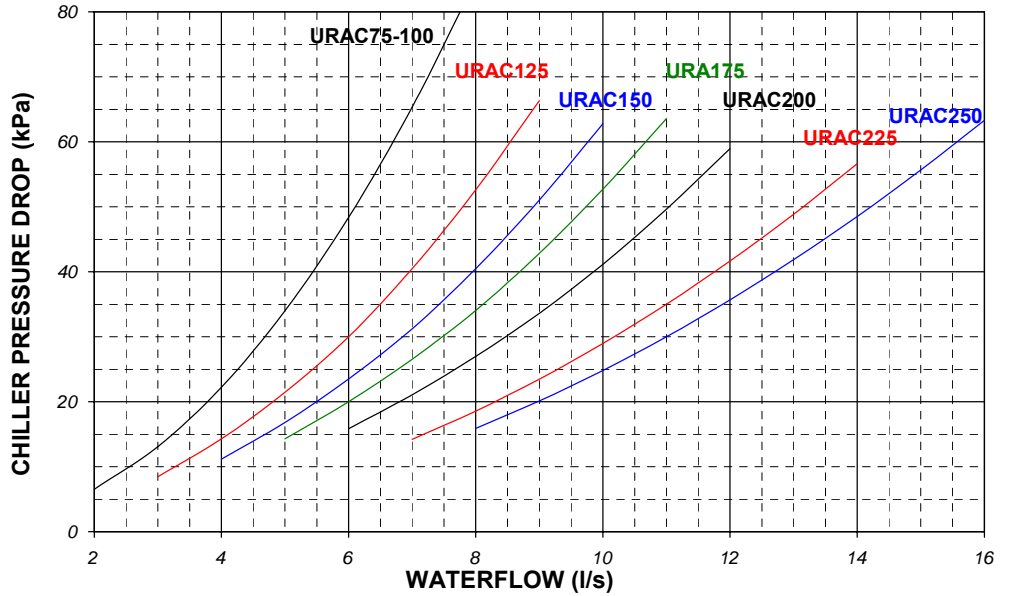

URAC240 – URAC450
(Except URAC250)

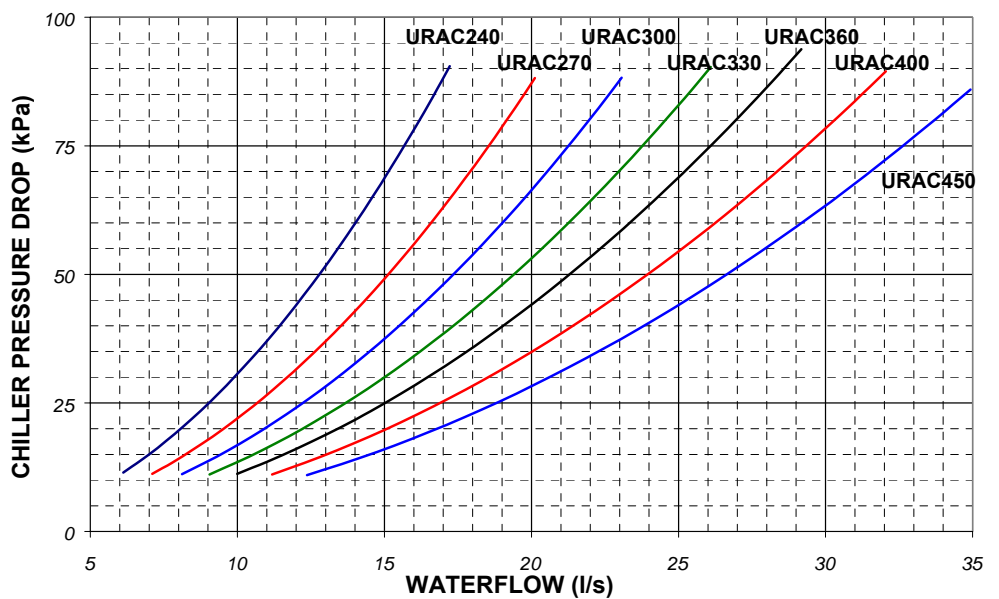

(1) For glycol solutions, please refer to [Glycol Data](#).

Commissioning Data

OPERATIONAL SEQUENCE

Refrigerant Charge Check for the presence of a refrigerant charge in the condenser side.

Crankcase Heater (If fitted) The mains supply to the crankcase (oil) heater should be switched on at least 8 hours prior to compressor starting to avoid refrigerant migration.

CAUTION  **A separately fused, locally isolated, permanent single phase and neutral supply MUST BE FITTED for the compressor sump heater, evaporator trace heating and control circuits, FAILURE to do so could INVALIDATE WARRANTY.**

Pre-Start-Up Check Before compressor start-up, make sure that an oil level is showing in the compressor sight glass, and that all refrigerant ball valves are opened.

CAUTION  **Check phase rotation by connecting pressure gauges to the suction and discharge ports, if no differential pressure occurs, isolate immediately.**

Adding Refrigerant Additional refrigerant should be added to the system via 1/4" schrader connection on the expansion line if required.

Pump Down Never pump down without the low pressure trip and high discharge temperature switches being operative.

UNLOADING PROTECTION

Head Pressure The microprocessor has inbuilt protection against nuisance trips. If the head pressure rises above 23BarG the system will unload 1 compressor and remain unloaded until the head pressure drops below 21BarG.

Low Pressure If low pressure drops below the microprocessor setting, the compressor will unload to 1 compressor, if low pressure persists for 1 minute, the circuit will be switched off and sound an alarm.

Commissioning Procedure

GENERAL

To be read in conjunction with the commissioning sheets provided, items highlighted should be recorded.

CAUTION  Please ensure all documents have been completed correctly and return to Airedale Service immediately to validate warranty.

PRE COMMISSIONING CHECKLIST

CAUTION  ALL work MUST be carried out by Technically Trained competent personnel.

The equipment contains live electrical and moving parts, ISOLATE prior to maintenance or repair work.

The door interlocking MCCB should be in the OFF position and the auxiliary alarm contact from the MCCB should be linked out.

Ensure all items listed in the Pre commissioning section are complete.

RECORD

The unit should be visually inspected and any damage noted.





- Secure commissioning gauges to the high side of the system, check for a positive charge.
- Check tightness of electrical components.
- Check that the remote on/off switch (if fitted) is in the off position.
- With the MCBs in the off position measure the incoming voltage.
- Check Phase Rotation.
- Check voltage at permanent supply.
- Measure and record the primary (230V) and secondary (24V) voltages at each of the transformers, adjust tapping if necessary and record on the commissioning document.
- Check all timer settings are correct.
- Check Sump Heater.
- Check oil level.
- Check water filter is fitted.
- Check design water flow is available.
- Check flow switch and pump interlocks are fitted to the water system and wired directly to the chiller.
- Switch on the controls and individual circuits, primary and secondary, MCBs to the ON position. At this stage the control display panel should be illuminated.
- Record Optional Extras.
- Record Controller Data.

CAUTION  Disable remote ON/OFF to ensure the unit does not start unintentionally.

The chiller will not start until microprocessor control SWITCH 1 is in the ON position. DO NOT SWITCH TO ON AT THIS STAGE

- Adjust the water temperature supply and return set points (if necessary) to call for 100% cooling (refer to the **Controls** section).
- Ensure all KNOBS and SWITCHES are adjusted to suit the design requirements (refer to the **Controls** section).

To switch the unit ON, use the microprocessor keypad as follows:

Press  , press  , press  , press  & finally .

CAUTION  There will always be a delay between the enabling of the unit and the energising of the compressor contactors, anything between 1 to 2 minutes. Be patient.

Commissioning Procedure





PRE COMMISSIONING CHECKLIST (CONT..)

- Check that each circuit trips on low pressure. The alarm should appear within 3 minutes.
- The alarm will be recognised at the display circuit trip, to clear the alarms refer to **Alarm Handling**.

RECORD ▼

- Reduce the flow rate to 75% of design and ensure that the evaporator pressure or flow protection switch trips at this flow rate, adjust as necessary.
- With compressors off, ensure this alarm is recognised as “**Water Flow Fail**” at the display and disengages the circuits operation immediately. Restore flow rate to the design and check the alarm has self-cleared.

To switch the unit OFF, use the microprocessor keypad as follows:

Press , press , press , press  & finally .

Fully open all liquid line and discharge service ball valves on each circuit.





Commissioning Procedure

COMMISSIONING CHECKLIST

The following should be carried out with a load on the system, otherwise the unit is likely to short cycle. The following tests are to be carried out on 1 circuit at a time.

- Switch the door interlocking MCCB to the ON position but again only on the circuit which is to be tested.
- Adjust the water temperature supply and return set points to match the system requirements.

To switch the unit ON, use the microprocessor keypad as follows:

Press , press , press , press  & finally .

- Check pressures at suction and discharge ports for correct phase rotation.

CAUTION  **If no differential pressure occurs, isolate immediately.**





RECORD 

- Measure and record the compressor amps once the compressors are fully loaded and at the unloading stage.
- Measure and record full speed amps of each condenser.

CAUTION  **The microprocessor LP setting is adjustable via the micro display. It is recommended that this setting be 0.6Bar below the equipment freezing point of the cooling medium ie for water (no glycol) LP micro settings is 3.2BarG.**

- Ensure that the low water temperature safety cuts out at the correct setting +/- 0.5°C, to clear the alarms refer to **Alarm Handling** section.
For water (no glycol) application the recommended setting is 3°C or 3°C below the design supply water temperature.

RECORD 

- Check the liquid line sight glass is clear and dry.
- Check the superheat setting adjusts the expansion valve to maintain a superheat setting of 5 – 8°C at all operating loads.
- Check and record the following:
Suction and discharge pressures
Liquid, discharge and suction line temperature
Water inlet and outlet temperature
- Ensure the above are all within the design parameters.
- Repeat as follows for each circuit:
- **To switch the unit OFF**, use the microprocessor keypad as follows:
Press , press , press , press  & finally .
- **To switch the unit ON**, repeat above.

The unit is now commissioned and will provide many years of trouble free operation providing the following maintenance schedule is followed.

Maintenance

CAUTION  ALL work **MUST** be carried out by Technically Trained competent personnel.

The equipment contains live electrical and moving parts, **ISOLATE** prior to maintenance or repair work.

GENERAL MAINTENANCE

The maintenance schedule indicates the time period between maintenance operations.

3 MONTHS	ACTION	NOTES
REFRIGERATION	Check the following and compare results with commissioning records. <ul style="list-style-type: none"> • Suction and discharge readings. • Head pressure control is maintained. • Pressure relief indicator gauge. • Check each circuit sight glass for dryness and bubbles for indication of leaks. • Check compressor oil level and shell/sump temperature. • Visually inspect the unit for oil patches. 	Investigate and rectify variations. Remember to re-cap the Schraeder connections!
SYSTEM	Check the following against the commissioning records. <ul style="list-style-type: none"> • Control settings. • Alarm log for unusual occurrences. • Chilled water control maintains design temperature. • Chilled water flow is within design limits of zero to plus 10%. • Concurrently ensure chilled water pump and flow switch operate efficiently, and that interlocks function correctly. • Operation of waterflow switch and pump interlock. 	Investigate and adjust as necessary.
Finally!	Record operating conditions.	
FABRIC	Visually inspect the unit for general wear and tear, treat metalwork. Visually inspect pipe and pipework insulation. Clean evaporator water strainer. Visually check the following: <ul style="list-style-type: none"> • Pipework clamps are secure. • Tightness and condition of fan and compressor mounts. • Anti-Vibration mounts fixings (if fitted). 	Rust should be inhibited, primed and touched up with matching paint (available from Airedale or your Distributor). Repair/rectify as necessary. At first maintenance visit and then as frequently as necessary (12 months). Secure/tighten as necessary.
Finally!	Ensure control panel lids and access panels have been correctly replaced and securely fastened in position.	

Maintenance

GENERAL MAINTENANCE (CONT..)

6 MONTHS	ACTION	NOTES
	Repeat 3 month checks plus the following:	
SYSTEM	Check evaporator trace heating and low ambient thermostat are set to activate at 4.0°C.	Remember to re-cap the Schraeder connections!
12 MONTHS	ACTION	NOTES
	Repeat 6 month checks plus the following:	
SYSTEM	Check safety devices cut out the compressor at the correct settings.	
REFRIGERATION	Check glycol concentration if appropriate.	Adjust as necessary.
	Leak test all R407C joints and inspect all water connections.	Rectify as necessary.
	Check superheats with chiller running on full load (the height of summer is recommended). Recheck the charge following major adjustment of the superheats.	Adjust as necessary. A period of 30 minutes should be allowed between each resetting of the valve to allow pressures to stabilise. Thermostatic expansion valve only.
ELECTRICAL	Tighten all electrical terminals.	

COMPRESSOR MAINTENANCE Periodic maintenance and inspection of this equipment is necessary to prevent premature failure, the following periodic inspections should be carried out by period or hourly use which ever is sooner.

1 Year Measure compressor motor insulation.

7,500 Hours or 4 Years Inspect compressor oil.

SHUT DOWN PERIODS For periods of winter shut down the following precautions are recommended:

- Close the liquid and discharge ball valve
- Cap service ports
- Turn off electrical circuits
- Drain the water from the chiller evaporator via the evaporator drain plug.

Parts Identification

SPARES

For ease of identification when ordering spares or contacting Airedale about your unit, please quote the unit type, unit serial number and the date of manufacture, which can be found on the unit serial plate.

A spares list for 1, 3 and 5 years will be supplied with every unit and is also available from our Spares department on request.

The serial plate can be located inside Item 9.

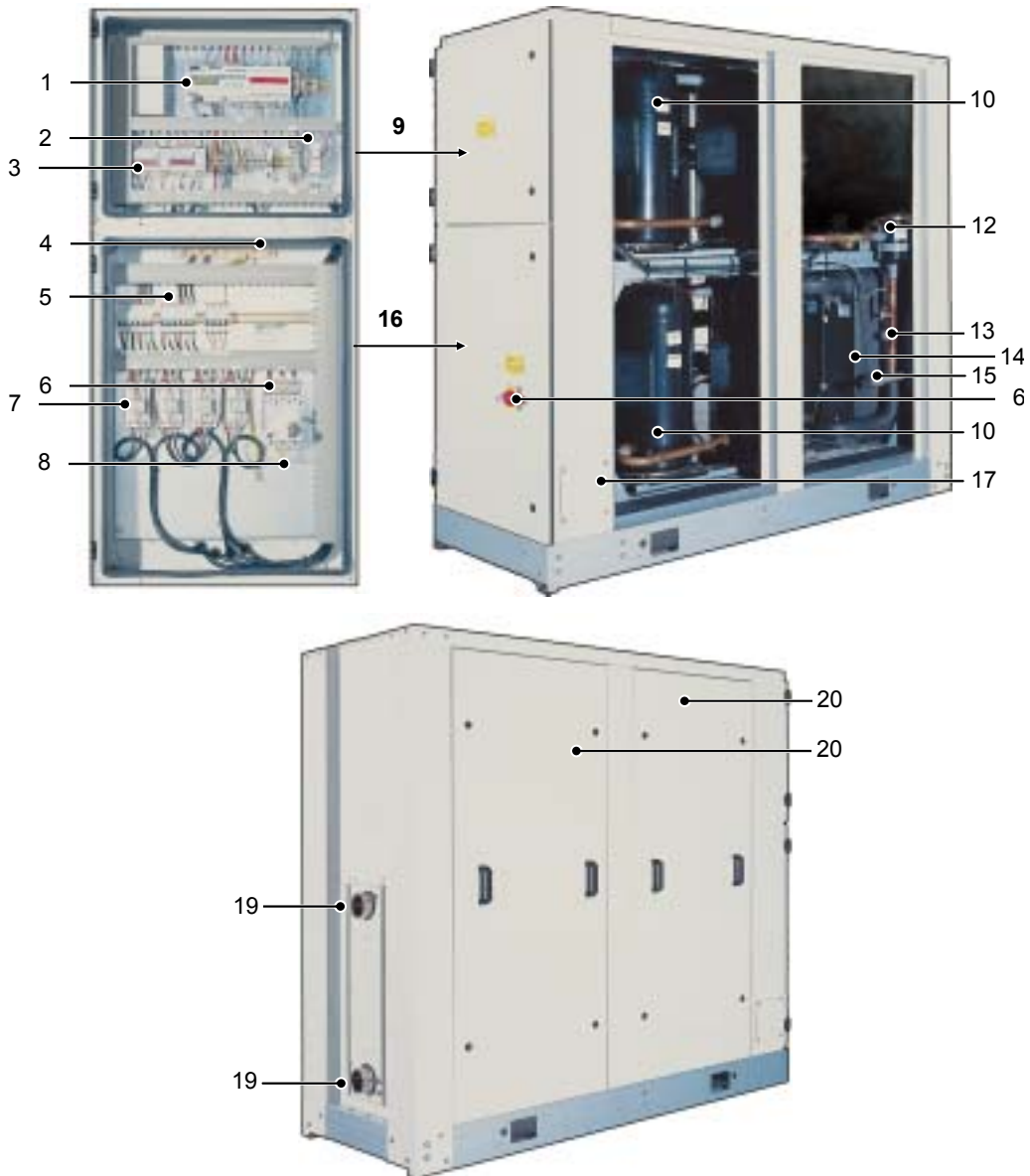

- | | | | |
|----------|--------------------------------------|-----------|--------------------------------------|
| 1 | AireTronix Microprocessor Controller | 11 | N/A |
| 2 | Controls Transformer | 12 | Filter Drier |
| 3 | Electronic Expansion Valve drives | 13 | Sight Glass |
| 4 | Earth | 14 | Evaporator |
| 5 | Compressor MCBs | 15 | Electronic Expansion Valve |
| 6 | Door Interlocking Isolator | 16 | Mains Panel |
| 7 | Compressor Contactors | 17 | Incoming Customer Mains Access Point |
| 8 | Mains Incoming | 18 | N/A |
| 9 | Controls Panel | 19 | Evaporator Water Connections |
| 10 | Compressor | 20 | Acoustic Panels (Optional) |

Notes:

Notes:

Notes:



Head Office:

Airedale International Air Conditioning Ltd

Leeds Road
Rawdon
Leeds LS19 6JY
United Kingdom

Tel: +44 (0) 113 239 1000

Fax: +44 (0) 113 250 7219

e-mail: enquiries@airedale.com

website: www.airedale.com



PART NO:	ISSUE	DATE
903-127 IM E	A	01/10/04

Airedale Departmental Contact Details:

CUSTOMER SERVICES For further assistance, please e-mail: enquiries@airedale.com or telephone:

UK Sales Enquiries	+ 44 (0) 113 238 7789	uk.sales@airedale.com
International Enquiries	+ 44 (0) 113 239 1000	enquiries@airedale.com
Spares Hot Line	+ 44 (0) 113 238 7878	spares@airedale.com
Airedale Service	+ 44 (0) 113 239 1000	service@airedale.com
Technical Support	+ 44 (0) 113 239 1000	tech.support@airedale.com
Training Enquiries	+ 44 (0) 113 239 1000	marketing@airedale.com

For information, visit us at our Web Site: www.airedale.com