



ATOL



**Column radiators**

# Atol: Column radiators

Owing to their round edges, making them much safer, and elegant design, ATOL column radiators are often installed in high-traffic areas in public buildings. The steel columns contribute to the low weight of the radiator. Individual columns consist of a specific number of pipes, as indicated in the radiator's identification. For example: C3 refers to a column made up of three pipes. ATOL radiators feature optimum heating fluid circulation with high heat-transfer efficiency. They are also suitable for low-temperature systems. Their high output makes them a popular and sought-after choice for installation in renovated old residential buildings, while their shape facilitates cleaning and maintenance.



△ atol C2



△ atol C2 – vertical

## Basic specifications

Material	steel tubes diameter 25 mm thickness 1,25 mm
Max. operating overpressure	1 MPa (10 bar)
Testing overpressure	1,3 MPa (13 bar)
Max. operating temperature	95 °C
Basic colour	snow white RAL 9016
Connection thread	G1/2" (G3/4" or G1" on request)
Built-in valve thread (VL,VR)	M 30 × 1,5 mm
Width of one element	46 mm +/- 1,5 %
Max. number of elements	see the Technical parameters table

## Features

- Elegant radiators with a smooth surface
- Ideal replacement for conventional column heating units
- Round edges to minimize the risk of injury
- Easy service and cleaning
- High heat output
- Excellent heat-transfer fluid circulation
- Also suitable for low-temperature systems

*Stylish retro design in modern colours...*



△ atol C3



△ atol C3

△ atol C4

△ atol C5

△ atol C6

# Atol Radius: Curved column radiators

The heating unit is a great complement to rounded walls, polygonal floor plans and other architectural elements. Atol Radius is made to fit the curvature of the wall and can often be used in place of several individual units required to fill in the rounded space, providing you with a balanced interior. This is also possible thanks to the wide range of smooth, structured or metallic colours available in a multitude of shades and hues.

The radiator dimensions should always be measured directly at the installation location as the actual curvature usually varies from the drawing documentation. Especially with regard to older buildings, the variable wall radius should always be factored in and the radiator suitability considered.



△ atol C3

## Basic specifications

Material	steel tubes diameter 25 mm thickness 1,25 mm
Max. operating overpressure	1 MPa (10 bar)
Testing overpressure	1,3 MPa (13 bar)
Max. operating temperature	95 °C
Basic colour	snow white RAL 9016
Connection thread	G1/2" (G3/4" or G1" on request)
Built-in valve thread (VL,VR)	M 30 × 1,5 mm
Width of one element	46 mm +/- 1,5 %
Max. number of elements	see the Technical parameters table

## Features

- Individual solution
- Retro design
- Curved design
- Round corners - injury prevention

## Atol Radius options

- all models - C2, C3, C4, C5, C6 - can be produced in curved versions
- colour design identical to standard units
- the maximum height of curved radiators is 2,000 mm

*When you need to conform to shape constraints...*



△ atol C2

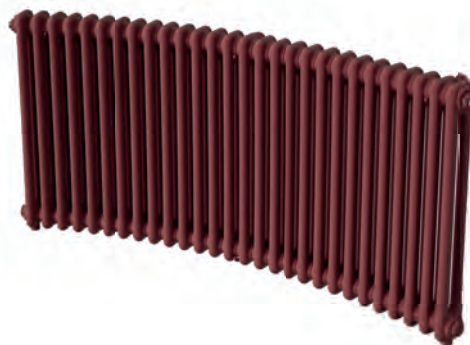

△ atol C2



## How to design and select your own radiator

Select the desired shape (C2 - C6 models), height and length (number of columns) of the radiator, taking into account the output and dimensional requirements. Specify the heating system connection and the required connection sets based on the project and/or the existing piping. Depending on the wall type, choose between wall or floor mounting options. See the ISAN colour reference chart or the broad range of RAL colours to choose the right coating shade and to best integrate the Atol unit into your interior.



△ C4

=

*Always go for an original interior design...*



**radiator type**

+

**connection**

+

**thermostatic set**

+

**mounting**

+

**colour**

/page 9

/page 10

/page 11

/page 14

/page 16



# How to determine radiator dimensions

To determine the right size of the heating unit, refer to the table of technical parameters provided.

**Unit height** - the models available range from 300 to 2,500 mm in height. Make sure to leave sufficient space under the radiator to allow for cool air circulation and easy floor cleaning.

**Unit width** - depending on the type of the Atol radiator used, the unit width can range from 66 to 230 mm (C2 to C6 type). Remember to take the distance of the radiator from the wall into account.

**Unit length** - determined by the sum of the length of the columns used, which is 46 mm. Add 30 mm for the plugs and do not forget to leave some room for the connection fittings/valves.

The overall heating output of the Atol unit is determined by its dimensions. Refer to the technical documentation to check the heating water parameters and calculate the unit output.

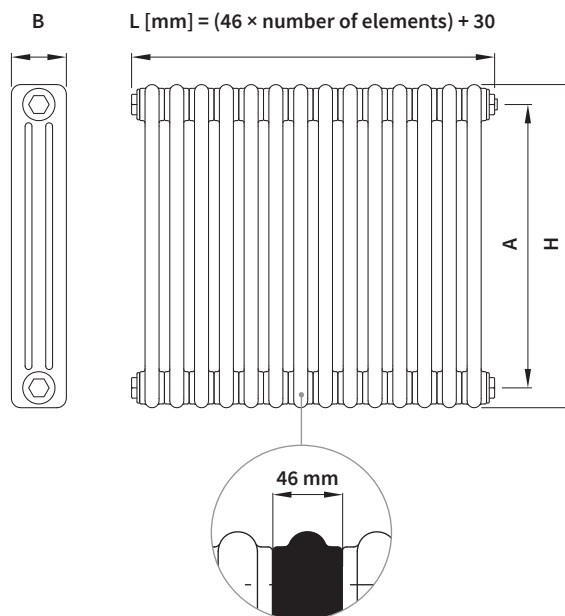

Dimensions of the radiator above:

**B = 148 / L = 1 226 / A = 830 / H = 900 mm**

# How to determine the radiator radius

When considering installing a curved radiator, particular attention should be devoted to determining the radius of the wall curvature. The measurements usually need to be taken directly on site.

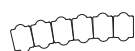
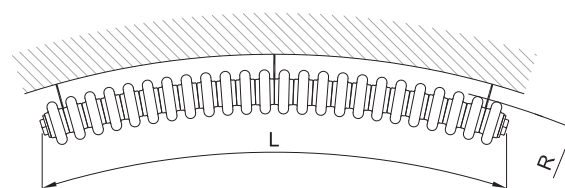
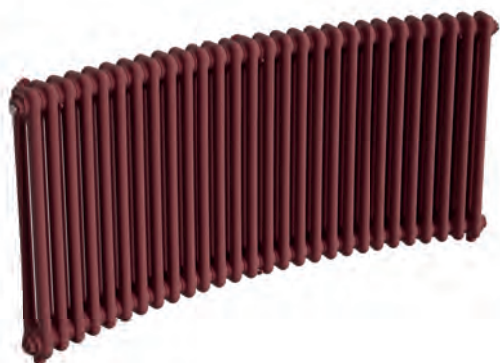

**C2**  
R = min. 1 100



**C3**  
R = min. 1 150

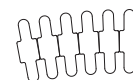

**C4**  
R = min. 1 350

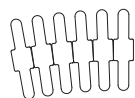

**C5**  
R = min. 1 400

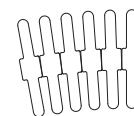





**C6**  
R = min. 1 450

The radius of the radiator above:

**L = 1 318 / R = 1 800 mm**



# Heat output and technical parameters / 1 column

Radiator type	Height H	Connection spacing A	Width B	Water volume	Weight	Heat output 75/65/20 °C	Heat output 55/45/20 °C	Temperature exponent n	Maximum number of elements
	[mm]	[mm]	[mm]	[l]	[kg]	[W]	[W]	[-]	[pcs]
 C2	300	230	66	0,42	0,47	23,1	12,3	1,24	60
	400	330	66	0,49	0,62	30,1	16	1,24	60
	500	430	66	0,57	0,76	37,1	19,6	1,25	60
	600	530	66	0,65	0,91	44	23,2	1,25	60
	750	680	66	0,77	1,13	54,4	28,6	1,26	60
	900	830	66	0,89	1,34	64,8	33,9	1,27	60
	1 000	930	66	0,97	1,49	71,7	37,5	1,27	60
	1 500	1 430	66	1,37	2,21	107,1	55,1	1,3	60
	1 800	1 730	66	1,61	2,65	129	66,1	1,31	50
	2 000	1 930	66	1,77	2,94	144	73,7	1,31	45
	2 500	2 430	66	2,16	3,67	182,7	93,1	1,32	36
 C3	300	230	107	0,6	0,85	32,2	16,9	1,26	60
	400	330	107	0,72	1,08	41,9	22	1,26	60
	500	430	107	0,83	1,29	51,4	27	1,26	60
	600	530	107	0,95	1,51	60,9	32	1,26	60
	750	680	107	1,13	1,83	75	39,4	1,26	60
	900	830	107	1,31	2,16	89,2	46,9	1,26	60
	1 000	930	107	1,43	2,38	98,6	51,8	1,26	56
	1 500	1 430	107	2,03	3,47	146,7	75,5	1,3	38
	1 800	1 730	107	2,39	4,13	176,4	89,4	1,33	32
	2 000	1 930	107	2,62	4,56	196,6	100,2	1,32	29
	2 500	2 430	107	3,22	5,65	249	127,5	1,31	23
 C4	300	230	148	0,78	0,94	42,5	22,6	1,24	60
	400	330	148	0,93	1,24	55,8	29,5	1,25	60
	500	430	148	1,09	1,52	68,9	36,2	1,26	60
	600	530	148	1,25	1,81	81,9	42,8	1,27	60
	750	680	148	1,49	2,26	101,2	52,6	1,28	59
	900	830	148	1,73	2,69	120,4	62,3	1,29	49
	1 000	930	148	1,89	2,98	133,1	68,9	1,29	44
	1 500	1 430	148	2,68	4,44	196,4	101,1	1,3	30
	1 800	1 730	148	3,16	5,31	234,3	120,6	1,3	25
	2 000	1 930	148	3,48	5,88	259,6	133,6	1,3	22
	2 500	2 430	148	4,27	7,34	323,1	166,3	1,3	18
 C5	300	230	189	0,97	1,2	51,6	26,6	1,3	60
	400	330	189	1,17	1,57	67,2	34,6	1,3	60
	500	430	189	1,63	1,93	82,6	42,7	1,29	60
	600	530	189	1,56	2,3	97,8	50,6	1,29	58
	750	680	189	1,86	2,84	120,4	62,6	1,28	47
	900	830	189	2,16	3,38	142,7	74,2	1,28	39
	1 000	930	189	2,36	3,75	157,6	81,5	1,29	35
	1 500	1 430	189	3,35	5,57	231,8	118,1	1,32	24
	1 800	1 730	189	3,95	6,65	276,5	139,4	1,34	20
	2 000	1 930	189	4,35	7,38	306,5	155,4	1,33	18
	2 500	2 430	189	5,34	9,19	382,4	196,8	1,3	14
 C6	300	230	230	1,16	1,6	62,2	31,9	1,31	60
	400	330	230	1,39	2,04	81,5	41,7	1,31	60
	500	430	230	1,63	2,47	100,6	51,5	1,31	54
	600	530	230	1,87	2,91	119,4	61,5	1,3	46
	750	680	230	2,23	3,57	147,2	75,8	1,3	37
	900	830	230	2,59	4,21	174,6	89,9	1,3	31
	1 000	930	230	2,83	4,65	192,7	99,2	1,3	28
	1 500	1 430	230	4,02	6,84	281,6	145	1,3	19
	1 800	1 730	230	4,73	8,14	334	171,1	1,31	16
	2 000	1 930	230	5,21	9,01	368,5	187,8	1,32	14
	2 500	2 430	230	6,4	11,19	453,8	230	1,33	11

# Column radiator connection

Heating system lines can be conducted in floors, in walls, under ceilings or through entries between floor levels. To facilitate connection to the heating system, the Atol comes in a range of design variations, including a combined heating water inlet and outlet. Specify your preferred connection by entering the relevant two-letter abbreviation at positions 13 and 14 of the order code.



Connection type:  
AM

## Connection options

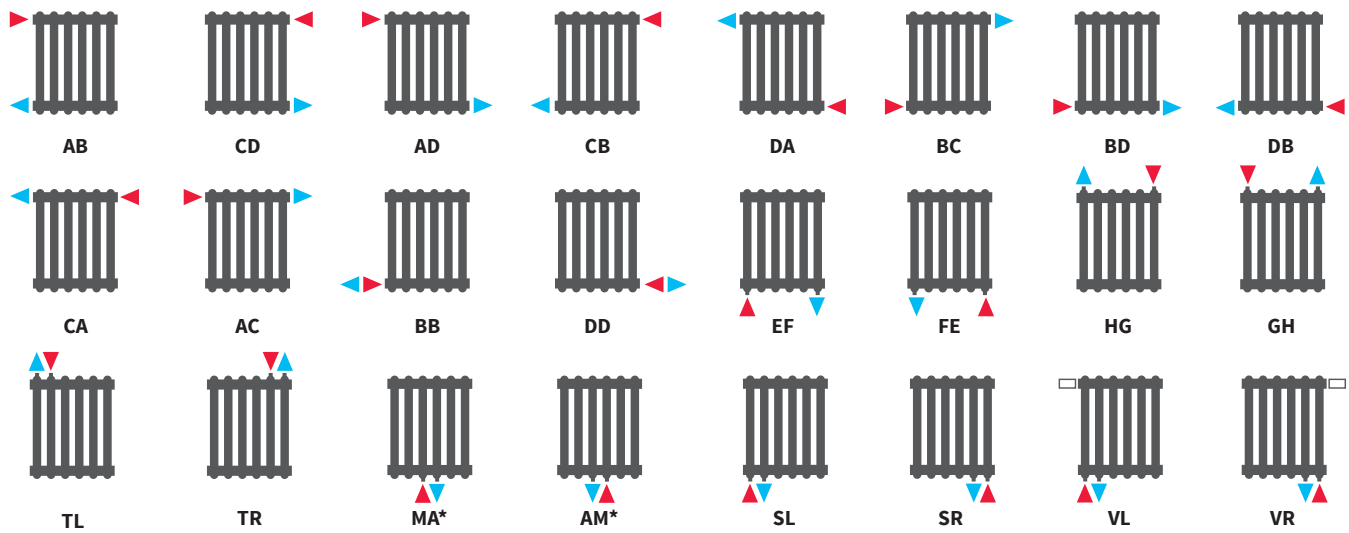

\* the centre connection (MA, AM) requires an even number of columns

## ATOL connection details

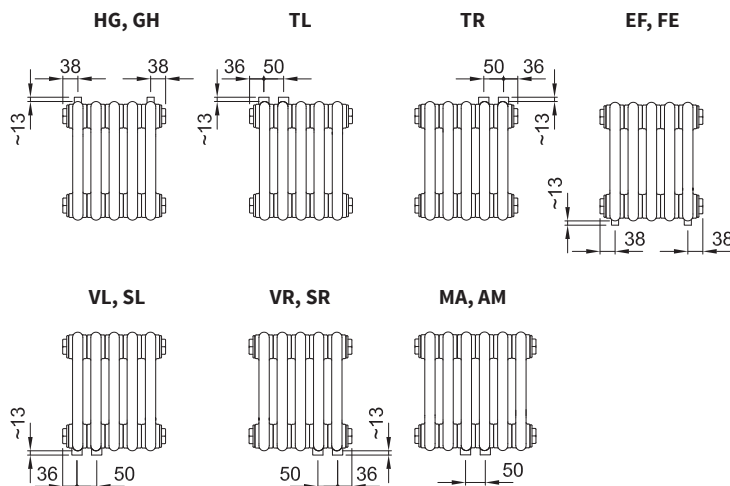

## Integrated thermostatic valve parameters (VL, VR models)

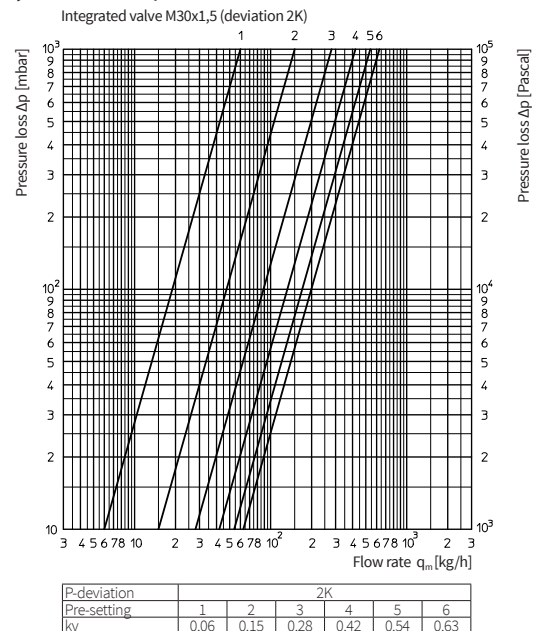

# Designer thermostatic sets

Select connection fittings compatible with the Atol connection used. They come in white, stainless steel or chrome design. The drawings provided for each set indicate the installation method and the required flow direction of the heat-transfer fluid.



Connection type:  
VR

## Thermostatic set angular - triax

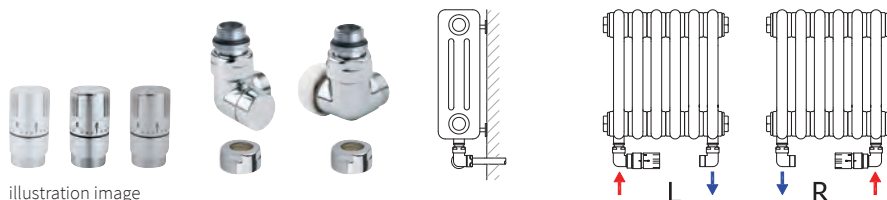

illustration image

**Pack nr. 101L / white / left / Code: O37BUCL101**  
**Pack nr. 101R / white / right / Code: O37BUCR101**  
**Connection to copper pipes Ø 15 mm**  
 Thermostatic head, design – white  
 Valve – angular thermostatic valve and lockshield valve / white  
 Clamping fittings for copper pipes / chrome

**Pack nr. 103L / chrome / left / Code: O37CUCL103**  
**Pack nr. 103R / chrome / right / Code: O37CUCR103**  
**Connection to copper pipes Ø 15 mm**  
 Thermostatic head / chrome  
 Valve – angular thermostatic valve and lockshield valve / chrome  
 Clamping fittings for copper pipes / chrome

**Pack nr. 105L / inox / left / Code: O37NUCL105**  
**Pack nr. 105R / inox / right / Code: O37NUCR105**  
**Connection to copper pipes Ø 15 mm**  
 Thermostatic head, design – inox  
 Valve – angular thermostatic valve and lockshield valve / inox  
 Clamping fittings for copper pipes / inox

**Pack nr. 102L / white / left / Code: O37BUAL102**  
**Pack nr. 102R / white / right / Code: O37BUAR102**  
**Connection to Al/PE-X and Al/PERT pipes Ø 16×2 mm**  
 Thermostatic head / white  
 Valve – angular thermostatic valve and lockshield valve / white  
 Clamping fittings for Al/PE-X and Al/PERT pipes / chrome

**Pack nr. 104L / chrome / left / Code: O37CUAL104**  
**Pack nr. 104R / chrome / right / Code: O37CUAR104**  
**Connection to Al/PE-X and Al/PERT pipes Ø 16×2 mm**  
 Thermostatic head, design – chrome  
 Valve – angular thermostatic valve and lockshield valve / chrome  
 Clamping fittings for Al/PE-X and Al/PERT pipes / chrome

**Pack nr. 106L / inox / left / Code: O37NUAL106**  
**Pack nr. 106R / inox / right / Code: O37NUAR106**  
**Connection to Al/PE-X and Al/PERT pipes Ø 16×2 mm**  
 Thermostatic head, design – inox  
 Valve – angular thermostatic valve and lockshield valve / inox  
 Clamping fittings for Al/PE-X and Al/PERT pipes / inox

## Thermostatic set direct



illustration image

**Pack nr. 107 / white / Code: O37BPC-107**  
**Connection to copper pipes Ø 15 mm**  
 Thermostatic head, design – white  
 Valve – direct thermostatic valve and lockshield valve / white  
 Clamping fittings for copper pipes / chrome

**Pack nr. 109 / chrome / Code: O37CPC-109**  
**Connection to copper pipes Ø 15 mm**  
 Thermostatic head / chrome  
 Valve – direct thermostatic valve and lockshield valve / chrome  
 Clamping fittings for copper pipes, design – chrome

**Pack nr. 111 / inox / Code: O37NPC-111**  
**Connection to copper pipes Ø 15 mm**  
 Thermostatic head, design – inox  
 Valve – direct thermostatic valve and lockshield valve / inox  
 Clamping fittings for copper pipes / inox

**Pack nr. 108 / white / Code: O37BPA-108**  
**Connection to Al/PE-X and Al/PERT pipes Ø 16×2 mm**  
 Thermostatic head, design – white  
 Valve – direct thermostatic valve and lockshield valve / white  
 Clamping fittings for Al/PE-X and Al/PERT pipes / chrome

**Pack nr. 110 / chrome / Code: O37CPA-110**  
**Connection to Al/PE-X and Al/PERT pipes Ø 16×2 mm**  
 Thermostatic head, design – chrome  
 Valve – direct thermostatic valve and lockshield valve / chrome  
 Clamping fittings for Al/PE-X and Al/PERT pipes / chrome

**Pack nr. 112 / inox / Code: O37NPA-112**  
**Connection to Al/PE-X and Al/PERT pipes Ø 16×2 mm**  
 Thermostatic head, design – inox  
 Valve – direct thermostatic valve and lockshield valve / inox  
 Clamping fittings for Al/PE-X and Al/PERT pipes / inox

## Thermostatic set corner



illustration image

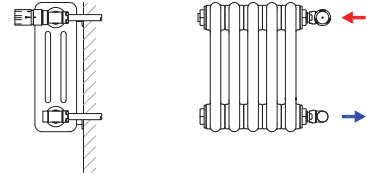

### Pack nr. 113 / white / Code: O37BRC-113

#### Connection to copper pipes Ø 15 mm

Thermostatic head / white

Valve – corner thermostatic valve and lockshield valve / white  
Clamping fittings for copper pipes / chrome

### Pack nr. 115 / chrome / Code: O37CRC-115

#### Connection to copper pipes Ø 15 mm

Thermostatic head / chrome

Valve – corner thermostatic valve and lockshield valve / chrome  
Clamping fittings for copper pipes / chrome

### Pack nr. 117 / inox / Code: O37NRC-117

#### Connection to copper pipes Ø 15 mm

Thermostatic head / inox

Valve – corner thermostatic valve and lockshield valve / inox  
Clamping fittings for copper pipes / inox

### Pack nr. 114 / white / Code: O37BRA-114

#### Connection to Al/PE-X and Al/PERT pipes Ø 16×2 mm

Thermostatic head / white

Valve – corner thermostatic valve and lockshield valve / white  
Clamping fittings for Al/PE-X and Al/PERT pipes / chrome

### Pack nr. 116 / chrome / Code: O37CRA-116

#### Connection to Al/PE-X and Al/PERT pipes Ø 16×2 mm

Thermostatic head / chrome

Valve – corner thermostatic valve and lockshield valve / chrome  
Clamping fittings for Al/PE-X and Al/PERT pipes / chrome

### Pack nr. 118 / inox / Code: O37NRA-118

#### Connection to Al/PE-X and Al/PERT pipes Ø 16×2 mm

Thermostatic head / inox

Valve – corner thermostatic valve and lockshield valve / inox  
Clamping fittings for Al/PE-X and Al/PERT pipes / inox

## Thermostatic valve corner



illustration image

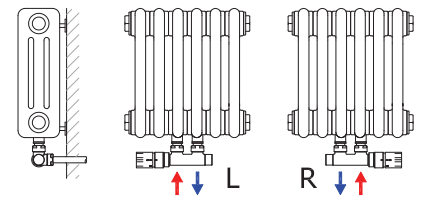

### Pack nr. 119L / white / left / Code: O37BWCL119

### Pack nr. 119R / white / right / Code: O37BWC119

#### Connection to copper pipes Ø 15 mm

Thermostatic head / white

Corner thermostatic valve and lockshield valve / white  
Clamping fittings for copper pipes / chrome

### Pack nr. 122L / chrome / left / Code: O37CWAL122

### Pack nr. 122R / chrome / right / Code: O37CWAR122

#### Connection to Al/PE-X and Al/PERT pipes Ø 16×2 mm

Thermostatic head / chrome

Corner thermostatic valve and lockshield valve / chrome  
Clamping fittings for Al/PE-X and Al/PERT pipes / chrome

### Pack nr. 219L / black / left / Code: O37SWCL219

### Pack nr. 219R / black / right / Code: O37SWCR219

#### Connection to copper pipes Ø 15 mm

Thermostatic head, design – black

Corner thermostatic valve and lockshield valve / black  
Clamping fittings for copper pipes / chrome

### Pack nr. 120L / white / left / Code: O37BWAL120

### Pack nr. 120R / white / right / Code: O37BWAR120

#### Connection to Al/PE-X and Al/PERT pipes Ø 16×2 mm

Thermostatic head / white

Corner thermostatic valve and lockshield valve / white  
Clamping fittings for Al/PE-X and Al/PERT pipes / chrome

### Pack nr. 123L / inox / left / Code: O37NWC123

### Pack nr. 123R / inox / right / Code: O37NWC123

#### Connection to copper pipes Ø 15 mm

Thermostatic head / inox

Corner thermostatic valve and lockshield valve / inox  
Clamping fittings for copper pipes / inox

### Pack nr. 220L / black / left / Code: O37SWAL220

### Pack nr. 220R / black / right / Code: O37SWAR220

#### Connection to Al/PE-X and Al/PERT pipes Ø 16×2 mm

Thermostatic head, design – black

Corner thermostatic valve and lockshield valve / black  
Clamping fittings for Al/PE-X and Al/PERT pipes / chrome

### Pack nr. 121L / chrome / left / Code: O37CWCL121

### Pack nr. 121R / chrome / right / Code: O37CWCR121

#### Connection to copper pipes Ø 15 mm

Thermostatic head / chrome

Corner thermostatic valve and lockshield valve / chrome  
Clamping fittings for copper pipes / chrome

### Pack nr. 124L / inox / left / Code: O37NWC124

### Pack nr. 124R / inox / right / Code: O37NWC124

#### Connection to Al/PE-X and Al/PERT pipes Ø 16×2 mm

Thermostatic head / inox

Corner thermostatic valve and lockshield valve / inox  
Clamping fittings for Al/PE-X and Al/PERT pipes / inox

## Thermostatic valve direct



illustration image

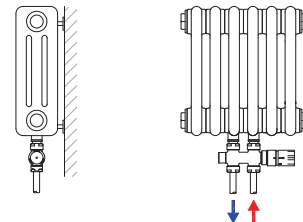

### Pack nr. 125 / white / Code: O37BFC-125

#### Connection to copper pipes Ø 15 mm

Thermostatic head / white

Direct thermostatic valve and lockshield valve / white  
Clamping fittings for copper pipes / chrome

### Pack nr. 127 / chrome / Code: O37CFC-127

#### Connection to copper pipes Ø 15 mm

Thermostatic head / chrome

Direct thermostatic valve and lockshield valve / chrome  
Clamping fittings for copper pipes / chrome

### Pack nr. 129 / inox / Code: O37NFC-129

#### Connection to copper pipes Ø 15 mm

Thermostatic head / inox

Direct thermostatic valve and lockshield valve / inox  
Clamping fittings for copper pipes / inox

### Pack nr. 126 / white / Code: O37BFA-126

#### Connection to Al/PE-X and Al/PERT pipes Ø 16×2 mm

Thermostatic head / white

Direct thermostatic valve and lockshield valve / white  
Clamping fittings for Al/PE-X and Al/PERT pipes / chrome

### Pack nr. 128 / chrome / Code: O37CFA-128

#### Connection to Al/PE-X and Al/PERT pipes Ø 16×2 mm

Thermostatic head / chrome

Direct thermostatic valve and lockshield valve / chrome  
Clamping fittings for Al/PE-X and Al/PERT pipes / chrome

### Pack nr. 130 / inox / Code: O37NFA-130

#### Connection to Al/PE-X and Al/PERT pipes Ø 16×2 mm

Thermostatic head / inox

Direct thermostatic valve and lockshield valve / inox  
Clamping fittings for Al/PE-X and Al/PERT pipes / inox

## Thermostatic valve universal



illustration image

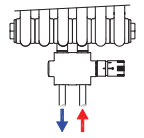
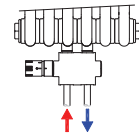
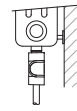
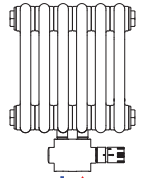
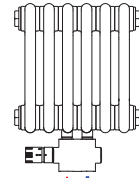
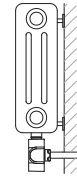

**Pack nr. 131L / white / left / Code: O37BUCL131**

**Pack nr. 131R / white / right / Code: O37BUCR131**  
Connection to copper pipes Ø 15 mm

Thermostatic head / white

Universal centre thermostatic valve and lockshield valve / white

Clamping fittings for copper pipes / chrome

**Pack nr. 133L / chrome / left / Code: O37CUCL133**

**Pack nr. 133R / chrome / right / Code: O37CUCR133**  
Connection to copper pipes Ø 15 mm

Thermostatic head / chrome

Universal centre thermostatic valve and lockshield valve / chrome

Clamping fittings for copper pipes / chrome

**Pack nr. 132L / white / left / Code: O37BUAL132**

**Pack nr. 132R / white / right / Code: O37BUAR132**  
Connection to Al/PE-X and Al/PERT pipes Ø 16×2 mm

Thermostatic head / white

Universal centre thermostatic valve and lockshield valve / white

Clamping fittings for Al/PE-X and Al/PERT pipes / chrome

**Pack nr. 134L / chrome / left / Code: O37CUAL134**

**Pack nr. 134R / chrome / right / Code: O37CUAR134**  
Connection to Al/PE-X and Al/PERT pipes Ø 16×2 mm

Thermostatic head / chrome

Universal centre thermostatic valve and lockshield valve / chrome

Clamping fittings for Al/PE-X and Al/PERT pipes / chrome

## LockShield set corner



illustration image

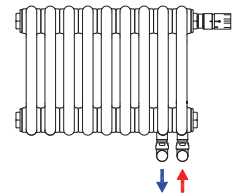
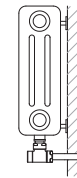

**Pack nr. 160 / white / Order code: O37BRC-160**  
Corner thermostatic set. Connection to copper pipes Ø 15 mm

Thermostatic head, design white.

Corner lockshield valve 2 pc / white.

Clamping fittings for copper pipes / chrome.

**Pack nr. 162 / chrome / Order code: O37CRC-162**  
Corner thermostatic set. Connection to copper pipes Ø 15 mm

Thermostatic head, design chrome.

Corner lockshield valve 2 pc / chrome.

Clamping fittings for copper pipes / chrome.

**Pack nr. 164 / inox / Order code: O37NRC-164**  
Corner thermostatic set. Connection to copper pipes Ø 15 mm

Thermostatic head, design INOX.

Corner lockshield valve 2 pc / INOX.

Clamping fittings for copper pipes / INOX.

**Pack nr. 161 / white / Order code: O37BRA-161**  
Corner thermostatic set. Connection to Al/PE-X pipes Ø 16×2

Thermostatic head, design white.

Corner lockshield valve 2 pc / white.

Clamping fittings for Al/PE-X pipes / chrome.

**Pack nr. 163 / chrome / Order code: O37CRA-163**  
Corner thermostatic set. Connection to Al/PE-X pipes Ø 16×2

Thermostatic head, design chrome.

Corner lockshield valve 2 pc, design chrome.

Clamping fittings for Al/PE-X pipes, design chrome.

**Pack nr. 165 / inox / Order code: O37NRA-165**  
Corner thermostatic set. Connection to Al/PE-X pipes Ø 16×2

Thermostatic head, design INOX.

Corner lockshield valve 2 pc / INOX.

Clamping fittings for Al/PE-X pipes / INOX.

# Atol mounting options

ATOL radiators can be mounted on a wall, using hooks or brackets. The radiator utilizes feet (stands) for floor mounting.



**W**



**G**



**F**

## W - mounting on walls made of solid material

Designed for mounting ATOL units on walls made of solid bricks, blocks or cast concrete. The wall must comply with the minimum thickness requirements.

Number of columns	Radiator length	Number of hooks
4-21	214 - 996 mm	3 (2+1)
22-48	1 042 - 2 238 mm	4 (3+1)
49-60	2 284 - 2 790 mm	5 (4+1)

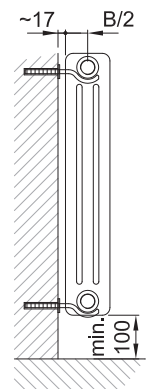

## G - wall-mounting alternatives using GTX, GTX+GTXP brackets

These wall brackets provide an alternative to the W brackets, facilitating ATOL mounting on all other types of walls. Thinner walls and plasterboard walls require additional reinforcement to meet the load-bearing capacity requirements.

Number of columns	Radiator length	Number of brackets	
		GTX H ≤ 1000 mm	GTX + GTXP H > 1 000 mm
4-9	214-444 mm	2	2
10-20	490-950 mm	2	3
21-35	996-1 640 mm	3	4
36-48	1 686-2 238 mm	4	5
49-60	2 284-2 790 mm	5	6

### Minimum number of columns for connection

EF	5 columns
MA, AM	6 columns
SL, SR	6 columns
VL, VR	6 columns

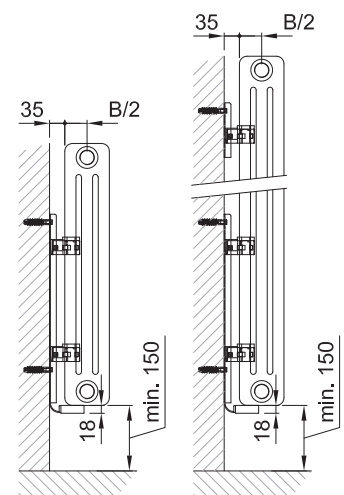

## F - Floor mounting

Stands designed to anchor the radiator to the floor. The radiator is fixed to the stands using clamps. Additional wall fastening is recommended (e.g. the W brackets) for higher radiators to prevent the floor anchoring from breaking.

Number of columns	Radiator length	Number of stands
5-21	260-996 mm	2
22-48	1 042-2 238 mm	3
49-60	2 284-2 790 mm	4

### Plastic covers

Plastic covers are available in the following colours:



RAL 9016



RAL 9006



RAL 7024



RAL 9005

### Minimum number of columns for connection

MA, AM: 6 columns

EF, VL, VR, SL, SR: 7 columns

Notice:

When selecting a design thermostatic set, make sure it does not collide with the F-stands (e.g. MA connection with the Pack nr.119R is suitable Atol with at least 12 columns)

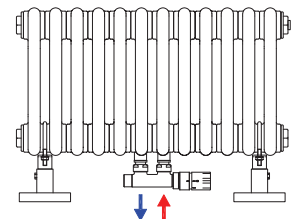
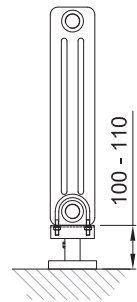

MA, Pack nr.119R, 12 columns

## R - wall mounting made of solid material, suitable for the Radius version.

Special brackets with the possibility of setting the distance from the wall. It is used with advantage for the arc radiators where the exact curvature of wall is not guaranteed. For this reason, the Radius models always require precise surveying directly on the construction site

Number of columns	Radiator length	Number of brackets straight Atol	Number of brackets Radius
4-21	214-996 mm	3 (2 + 1)	4 (2 + 2)
22-48	1 042-2 238 mm	4 (3 + 1)	5 (3 + 2)
49-60	2 284- 2 790 mm	5 (4 + 1)	6 (4 + 2)

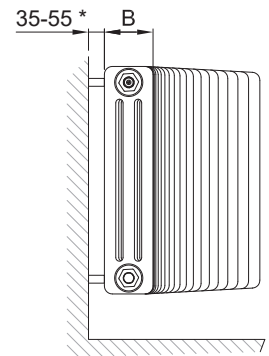

\* C2 35-47 mm

## Accessories



### Chrome hook - 2 pc set

Order code: O15AM80-01-0101



### Chrome towel rail

- the spacing of the towel rail axes is 322 mm
- for ATOL with 9 or more columns

Order code: O15AM80-02-0101

# Colour Reference Chart

	colour series <b>RAL 9016</b> shade snow-white finish - extra charge - order code 01		colour series <b>S09</b> shade snow-white finish texture extra charge 30 % order code 68		colour series <b>RAL 9001</b> shade ivory finish - extra charge 30 % order code 04
	colour series <b>S31</b> shade champagne finish metallic extra charge 30 % order code 25		colour series <b>RAL 9018</b> shade papyrus finish - extra charge 30 % order code 14		colour series <b>S08</b> shade ivory finish texture extra charge 30 % order code 67
	colour series <b>S26</b> shade lime finish - extra charge 30 % order code 09		colour series <b>S27</b> shade khaki finish texture extra charge 30 % order code 21		colour series <b>S36</b> shade antique gold finish metallic extra charge 30 % order code 48
	colour series <b>S32</b> shade pink coral finish texture extra charge 30 % order code 26		colour series <b>RAL 3002</b> shade fiery red finish - extra charge 30 % order code 08		colour series <b>S34</b> shade ruby finish - extra charge 30 % order code 28
	colour series <b>S13</b> shade sandstone finish texture extra charge 30 % order code 72		colour series <b>S28</b> shade gold olive finish texture extra charge 30 % order code 22		colour series <b>RAL 6021</b> shade linden green finish - extra charge 30 % order code 06
	colour series <b>S29</b> shade aquamarine finish metallic extra charge 30 % order code 23		colour series <b>RAL 5014</b> shade pigeon blue finish - extra charge 30 % order code 07		colour series <b>S30</b> shade sapphire finish texture extra charge 30 % order code 24
	colour series <b>S33</b> shade lava ash finish texture extra charge 30 % order code 27		colour series <b>S03</b> shade copper finish metallic extra charge 30 % order code 62		colour series <b>S19</b> shade brass finish metallic extra charge 30 % order code 83
	colour series <b>S38</b> shade dark grey finish texture extra charge 30 % order code 50		colour series <b>S05</b> shade silver finish metallic extra charge 30 % order code 64		colour series <b>S37</b> shade light grey finish texture extra charge 30 % order code 49
	colour series <b>S02</b> shade anthracite finish metallic extra charge 30 % order code 61		colour series <b>S35</b> shade cinnamon finish texture extra charge 30 % order code 29		colour series <b>S10</b> shade slate finish texture extra charge 30 % order code 69
			colour series <b>RAL 9005</b> shade black finish - extra charge 30 % order code 19		colour series <b>S40</b> shade black velvet finish mat extra charge 30 % order code 51

## RAL surcharge

Other RAL colours (1-10 pc) - 40 % surcharge  
Other RAL colours (over 10 pc) - individual calculation

## Special treatment

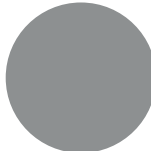
	colour series <b>S41</b> shade RAL 9016 finish antibacterial* extra charge 30 % order code 88		colour series <b>S20</b> shade transparent paint finish transparent paint extra charge 30 % order code 84
---	---	---	---

\*A silver-ion antibacterial finish provides protection against a wide range of bacteria and fungi.

The printed version of the colour chart is for reference only and does not correspond to the actual surface treatment shades.



*Due to particular requirements,  
the vertical design is up to 2,5 m high.*



# Atol: Heating bench

The Atol radiator is placed horizontally between a pair of stable sideboards. The upper part features a massive wooden board. The radiator can be used to sit or place things on, providing a practical solution to room heating.



△ atol L4 Birch

## Technical data

Material	solid feet board heating unit	steel beech Atol C4 · 5 columns · Ø 25 mm pipe · 1.25 mm thick
Max. operating overpressure		1 MPa (10 bar)
Test overpressure		1,3 MPa (13 bar)
Max. operating temperature		95 °C
Base colour		snow white RAL 9016
Connection threads		G1/2" (to order G3/4" or G1")
Built-in valve thread (VL,VR)		M 30 × 1,5

## Features

- Stable feet
- Concealed connection fittings
- Massive beech top
- Wide colour selection

## Suitable for use in

- public buildings
- entrance areas, corridors
- gymnasiums
- changing rooms, hallways

*Have a seat and enjoy the beauty of winter...*



△ atol L4 Maple



△ atol L4 Beech natur / varnished



△ atol L4 Oak natur / varnished



△ atol L4 Maple / varnished

# Create your own design

A heating unit concealed in an elegant frame that can be used as a bench, a place to put things on, or a shelf for house plants. The top board is made of beech, oak, maple or birch wood. The right combination of colours will help you achieve another original aesthetic expression of the Atol Bench. The legs and the unit itself can be finished in different colours.



Top design +

feet colour +

heating unit colour



Maple



Anthracit [S02]



RAL 9016 [S01]

## Available wooden top designs

The top boards come in four versions made of solid wood. All boards are coated with a clear varnish. For other options, including the use of different wood or your own board, contact the ISAN Technical Department.



wood surface finish

**Beech natur**  
varnished standard



wood surface finish

**Oak natur**  
varnished to order



wood surface finish

**Maple**  
varnished to order



wood surface finish

**Birch**  
varnished to order

Note: Please specify any wood finish other than Beech natur in a note following the order code.

*Perfect interior*

**The bench top can be matched to your floor**



# Atol bench structure

The five-column Atol C4 is installed horizontally just below the wooden top. The heater comes with a radiator valve and a white thermostatic head.



\* The LockShield valve is not included in the delivery

## Standard parameters

Type	Bench dimensions [mm]			Connection spacing [mm]	Weight [kg]	Output [W] 75/65/20 °C
	Height	Length	Width			
Atol L4	455	1 100	250	930	27,5	466
Atol L4	455	1 300	250	1 130	31,8	555
Atol L4	455	1 600	250	1 430	35,7	687

## Dimensional sketch

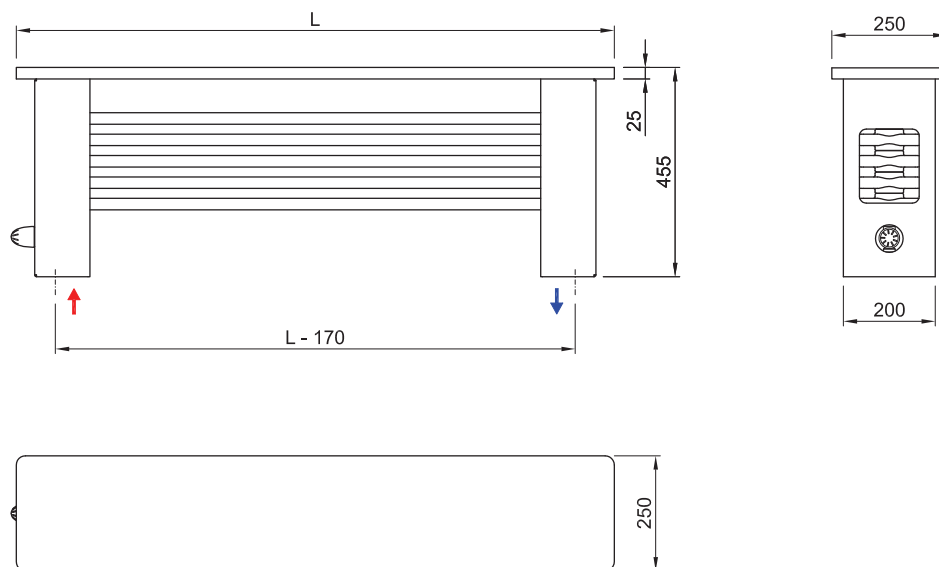

# How to order Atol column radiators



Radiator code example:  
**CAT20900026WAD01A**

1	2	3	4	5	6	7	8	9	10	11	12	13	14	15	16	17
<b>C</b>	<b>A</b>	<b>T</b>	<b>2</b>	<b>0</b>	<b>9</b>	<b>0</b>	<b>0</b>	<b>0</b>	<b>2</b>	<b>6</b>	<b>W</b>	<b>A</b>	<b>D</b>	<b>0</b>	<b>1</b>	<b>A</b>
product			model	height			number of elements			mounting	connection		colour		Atyp	

**Order** → ATOL C2, height 900 mm, 26 columns, wall mounting, standard connection AD, colour RAL 9016

## Code explanatory notes

<b>Position 1, 2, 3</b>	PRODUCT	e.g. CAT	CAT - ATOL column radiator; CAR - Atol Radius
<b>Position 4</b>	MODEL	e.g. 4	2 (C2), 3 (C3), 4 (C4), 5 (C5), 6 (C6)
<b>Position 5, 6, 7, 8</b>	HEIGHT [mm]	e.g. 600	300, 400, 500, 600, 750, 900, 1000, 1500, 1800, 2000, 2500
<b>Position 9, 10, 11</b>	NUMBER OF ELEMENTS	2 - 60	2, 3, 4, 5, 6, ..... , 60 > the number of columns can be affected based on: - the selected connection to the heating system (e.g. VL, VR) - the selected wall mounting (e.g. GTX) > for the maximum number of columns in each model see the Technical Parameters table
<b>Position 12</b>	MOUNTING	W	wall hook mounting
		G	GTX, GTX+P mounting
		F	floor stand
		R	wall mounting for arc Atol radius
<b>Position 13, 14</b>	CONNECTION	e.g. AB	AB, CD, AD, CB, DA, BC, BD, DB, CA, AC, BB, DD, EF, FE, HG, GH, TL, TR, MA, AM, SL, SR, VL, VR
<b>Position 15, 16</b>	COLOUR	e.g. 08	colour design as per the ISAN Colour Reference Chart (p.16) or the RAL colour range, boards p. 20
<b>Position 17</b>	ATYP	A	atypical version of the radiator Atol

# How to order Atol Bench column radiators



Radiator code example:  
**CAB4L4551100SF01A**

1	2	3	4	5	6	7	8	9	10	11	12	13	14	15	16	17
<b>C</b>	<b>A</b>	<b>B</b>	<b>4</b>	<b>L</b>	<b>4</b>	<b>5</b>	<b>5</b>	<b>1</b>	<b>1</b>	<b>0</b>	<b>0</b>	<b>S</b>	<b>F</b>	<b>0</b>	<b>1</b>	<b>A</b>
product			model	side	height			length				connection	colour		atyp	

**Order**→ ATOL BENCH C4, height 455 mm, 1,100 mm, standard connection L, colour RAL 9016

## Code explanatory notes

<b>Position 1, 2, 3</b>	PRODUCT	CAB	Atol bench heater
<b>Position 4</b>	MODEL	4	Installed heating unit: Atol C4
<b>Position 5</b>	SIDE	e.g. L	L, P - left-sided bench heater connection (note: the right or left design is identical for standard connection)
<b>Position 6, 7, 8</b>	HEIGHT	455	Atol bench heater height
<b>Position 9, 10, 11, 12</b>	LENGTH	e.g. 1,100	1 100, 1 300, 1 600 mm
<b>Position 13</b>	S	S	water connection: inlet on one side and outlet on the other
<b>Position 14</b>	F	F	heating water conducted into the floor
<b>Position 15,16</b>	COLOUR	e.g. 01	colour design as per the ISAN Colour Reference Chart (page 16) or the RAL colour range, boards page 20
<b>Position 17</b>	ATYP	A	atypical version of the radiator Atol



**ISAN Radiátory s.r.o | Poříčí 26, 678 01 Blansko, CZ**

CZ | Tel.: +420 516 489 138 | Fax: +420 516 489 605 | [obchod@isan.cz](mailto:obchod@isan.cz) | [www.isan.cz](http://www.isan.cz)  
SK | Tel.: +420 516 489 186 | Fax: +420 516 489 605 | [obchod@isan.sk](mailto:obchod@isan.sk) | [www.isan.sk](http://www.isan.sk)  
Export | Tel.: +420 516 489 190 | Fax: +420 516 489 605 | [sales@isan.cz](mailto:sales@isan.cz) | [www.isan.cz](http://www.isan.cz)