



TERMO

ECO &
SAFE

24
VOLTAGE

Trench heaters



About the Company

Trademark ISAN represents a traditional Czech manufacturer of heating bodies with a history and experience stretching back more than 60 years. ISAN Radiátory s.r.o. has been developing and manufacturing trench heaters for more than 18 years. Top-notch technological procedures and the progressive thinking of our designers and developers always guarantee high technical and aesthetic parameters of the products, thanks to which the products have become popular on the Czech and foreign market. We export 90% of our production into the countries of the European Union.

Our prime objective is the satisfaction on the customer's part and service. Ecological processing with maximal consideration for the environment goes without saying. The production is controlled by ISO 9001:2016 system. Moreover, all heating bodies comply with certification requirements applicable for current legislative regulations of individual states in a way that corresponds to the strictest standards. The certification process for the Czech Republic took place in Testing Institute for Mechanical Engineering in Brno, notified body ES1015.

The complete ISAN portfolio consists of a wide range of radiant trench heaters and lamella-fitted radiators ISAN EXACT, trench heaters with a lamellar heat exchanger ISAN ECOLITE, trench heaters ISAN TERMO, column radiators ISAN ATOL, ribbed-tube radiators ISAN SPIRAL, glass radiators ISAN JOY and, last but not least, bathroom radiators ISAN MELODY, in which case the company was the first manufacturer of this type in the Czech Republic.

A speciality of ISAN Radiátory s.r.o. is creating made-to-measure radiators based on the requirements of our customers.

Contents of the Catalogue

Basic Information 1–19

	About the Company	8	Peripheral ledge
2	Basic Information	9	Self-standing trench heaters
3	EC technology	10	Atypical trench heaters
3	Construction	13	Acoustics
4	Overview components TERMO	14	Accessories TERMO
6	Grilles		

TERMO electric trench heaters 20-27

20	TERMO – ELECTRIC TRENCH HEATER
24	WITH FAN, HEATING FET - Electric trench heaters with fan NEW PRODUCT
25	NATURAL CONVECTION, HEATING FEK - Electric trench heaters with natural convection NEW PRODUCT
26	FET, FEK - outputs and acoustic parameters
27	Trench heating wiring diagram

TERMO -trench heaters for heating systems 28-131

28	TERMO WITH FAN	102	TERMO NATURAL CONVECTION
32	WITH FAN, HEATING FRT - Fan-assisted trench heater with lamellar heat exchanger, heating, dry environment	106	NATURAL CONVECTION, HEATING FRK - Trench heater with lamellar heat exchanger, heating, dry environment
84	WITH FAN, HEATING / COOLING FRC, FRD - Fan-assisted trench heater with lamellar heat exchanger, heating and cooling, dry environment	124	NATURAL CONVECTION, HEATING, HUMID ENVIRONMENT FRM - Trench heater with lamellar heat exchanger, heating, humid environment
94	WITH FAN, HEATING, HUMID ENVIRONMENT FRB - Fan-assisted trench heater with lamellar heat exchanger, heating, humid environment		TECHNICAL INFORMATION
98	WITH FAN AND POWER SUPPLY 24 V DC FRZ, FDZ, FZC, FZD - Fan-assisted trench heaters with installed power supply 24 V DC	126	Heat exchanger - Hydraulic resistance
		129	Electric connection of trench heaters with fan
		130	Electrical diagram

The coding 132-133

132	The coding of trench heaters TERMO
-----	------------------------------------



marking of an environmentally friendly product with low consumption, economical operation, working on the basis of safe direct current voltage of 24 V DC



All-electric trench heater



Cooling, convector with cooling in summer



Power input for trench heaters with fan



2 pipe (single circuit heating / cooling system)



Trench heater with fan, increased output with forced convection



Convector for spaces with increased air humidity (up to 100%)



The convector includes an Al-Cu lamellar heat (cold) exchanger



4 pipe (double circuit heating / cooling system)



Heating, a trench heater for hot water heating system with forced circulation



Acoustic power parameters of trench heaters with fan



24 V DC power supply installed in the trench convector

We reserve the right to changes and misprints.

Basic Information about TERMO

Use

Trench heaters are suitable for places with large glass walls. They are installed in commercial and administrative buildings, commercial centres, entrance halls and other public spaces. They are also common in residential buildings, in which they are used to heat living rooms, corridors, halls and indoor gardens.

Placement

Trench heaters are installed in the floor and therefore do not occupy any space suitable for furniture and do not interfere with the interior the way traditional heating bodies do. The final look of the trench heater depends on the upper design grille. Available grilles are made of anodized aluminium, wood and stainless steel.

Operation

The trench heaters with fan are controlled with a digital thermostat with continuous control. This secures comfortable and economical operation at optimal thermal comfort and low noise level. All parts of the trench heaters work on the basis of safe direct voltage of 24 V DC. (with the exception of the heating unit in all-electric heaters)

The low volume of water in heat exchangers secures fast warming up to operating temperature. The trench heaters provide heating at the moment when it is necessary without a delay during start-up and without inertia when the requirement is cancelled. By generating their own heat, electric heat exchangers also eliminate any potential heat loss in piping.

Function

A "thermal screen" is created in front of a glazed surface, which separates the cold surface from the indoor environment. At the same time air flow prevents condensation of air humidity on the surface. The trench heaters are installed in the floor with the heat exchanger nearer to the window. The vertical and horizontal distribution of temperatures in the heated space is even and favourable conditions are created to secure thermal comfort.

Air flow is comparable with heat transmission provided by traditional heating bodies located on the wall under the window. The reversed arrangement in the floor is possible (the heat exchanger towards the room's centre, the ventilator at the window).

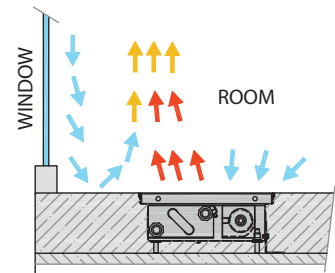

Low temperature heating systems

High performance models with modern tangential ventilators 24 V DC EC allow for the implementation into low temperature heating systems making use of thermal pumps and other ecological heating sources.

BMS

Trench heaters with the EC fans technology combined with a modern digital thermostat can easily be incorporated into building management systems (BMS). Communication with the superior system either directly or through a thermostat with an output for communication with the KNX protocol. For other systems it is possible to use protocol converters.

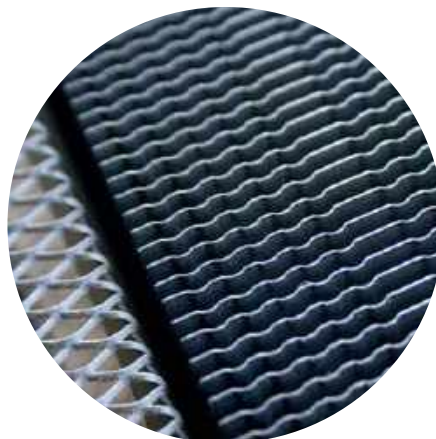

EC technology

This technical advancement affects all areas of human activity and enables the requirements for low energy consumption and safety of devices to be met. Modern 24 V DC fans with electronically commutated (EC) motors are among the most important elements of the trench heaters.

Properties of 24 V DC EC FANS

- Safe voltage of 24 V DC
- Remarkably low energy consumption, calculated in units of watts
- Comfortable continuous speed control using a voltage of 0...10 V DC
- Pulse to start the motor at low speeds
- Protection function when the rotor is stopped by an outside influence
- Synchronization of fan speeds
- Long service life of the motor with electronic control
- Simple implementation into complex control systems



The fans in TERMO trench heaters with their rotors cover the entire length of the exchanger. Even at low speeds they achieve optimum performance and a quiet operation.

Trench heater design

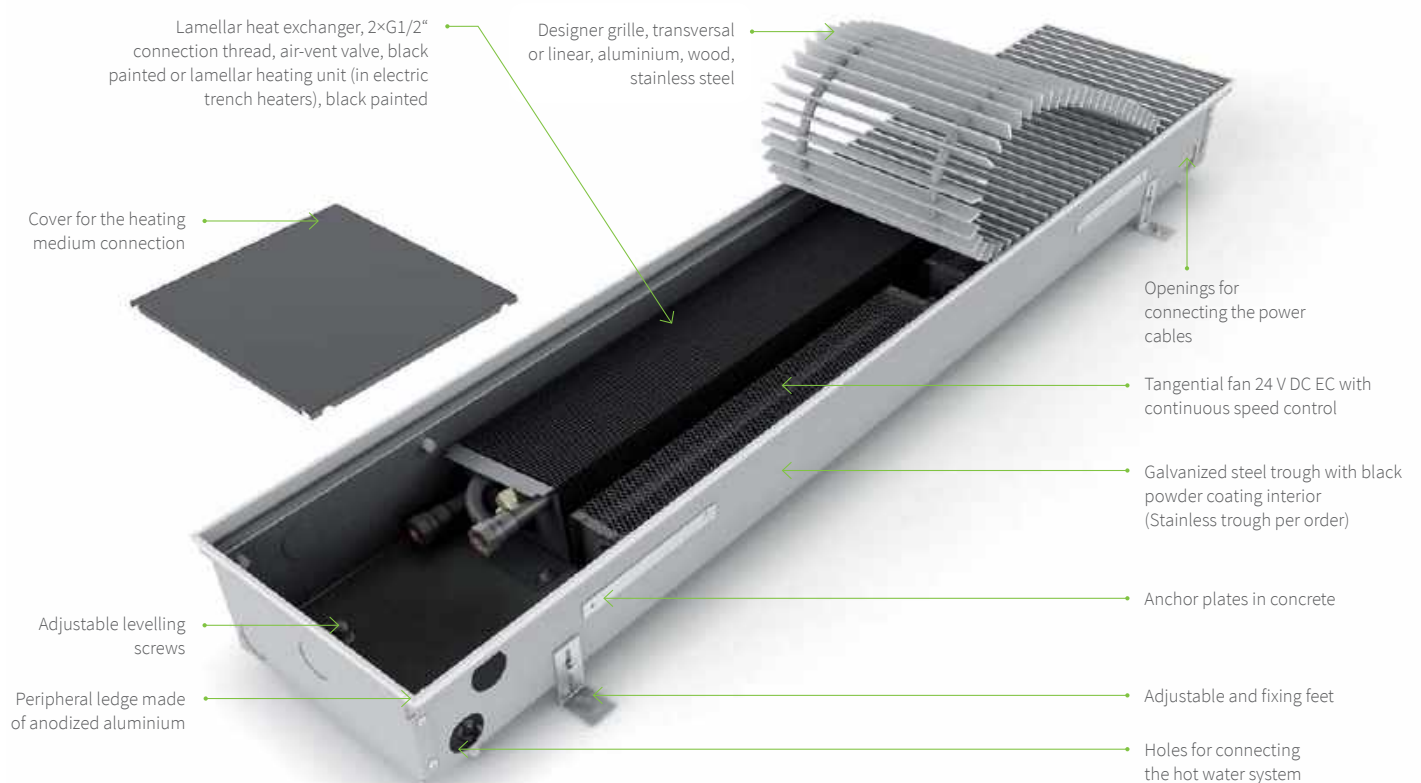

Note: FET and FEK electric trench heaters are also equipped with an electronic regulator to control the heating unit and the fan; see page 22 for more details.

Overview of TERMO trench heaters

Electric trench heaters 20-27

FET NEW PRODUCT

Electric trench heater with a lamellar heating unit, fan and regulator, **heating**, dry environment



More details → page 24



FEK NEW PRODUCT

Electric trench heater with a lamellar **heating** unit and regulator, heating, dry environment



More details → page 25



Trench heaters for heating systems 28-131

With fan 28-95

FRT

Fan-assisted trench heater with **lamellar** heat exchanger, **heating**, dry environment



More details → page 34



FRC, FRD

Fan-assisted trench heater with **lamellar** heat exchanger, **heating and cooling**, dry environment



More details → page 86



FRB

Fan-assisted trench heater with **lamellar** heat exchanger, **heating**, humid environment



More details → page 94



New! All-electric trench heaters

With fan and power supply 96–103

FRZ

24 V DC power supply installed in FRT and FDT heaters, safe installation with IP67 electrical protection



More details → page 98



FZC, FZD

24 V DC power supply installed in FRC and FRD heaters, safe installation with IP67 electrical protection



More details → page 100



Natural convection 104-125

FRK

Trench heater with **lamellar** heat exchanger, **heating**, dry environment



More details → page 108



FRM

Trench heater with **lamellar** heat exchanger, heating, **humid environment**.



More details → page 124



Grilles

The lamellas in grilles are made of anodized aluminium. The surface is durable and resistant to abrasion and its colours are stable. The lamellas are supplied in the following colours: NATUR, BRONZE, BLACK and STAINLESS STEEL.

Aluminium low transverse grilles

For models FRT 0065 0175, FRT 0065 0200, FRT 0065 0250, FRT 0065 0300, FRT 0080 0175, FRT 0080 0200

The grille of the low trench heater type. It allows for installation into floor configuration with the heights of 65 and 80 mm. The aluminium lamellas are pressed into plastic longitudinal strips of black colour. The grille comes in 520 mm sections and an additional piece joined together at the installation site to form the required length.



NATUR - marking 15



BRONZE - marking 25



BLACK - marking 35

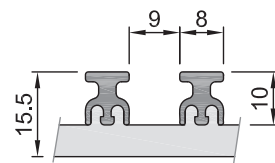

Grille's cross section

Low grilles can also be used for other types of convectors. Please, consult the ISAN Technical Department about this alternative.

Aluminium roll-up transverse grilles

Transverse lamellas are linked with a loaded spring and their limits are defined with distance rolls of hardened plastic. The rolling of the grille facilitates handling in the course of the installation and cleaning of the trench heater. The plastic rolls are assigned as follows based on the colour of the lamellas: NATUR – silver, BRONZE – black, BLACK – black. Aluminum grilles anodized to form a STAINLESS finish are fitted with stainless steel spacers. The lamellas may be provided with a surface finish of sprayed powder colour according to the RAL sample list.

Grilles suitable for electric trench heaters are marked with ⚡. These are non-roll grilles with a reduced distance between individual lamellas (as shown in the sectional view). Marking 17, 27, 37, 47.

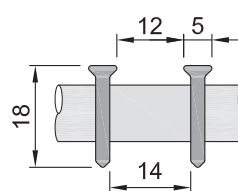

Grille's cross section

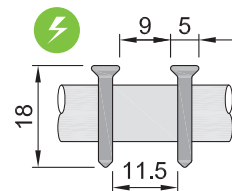

Grille's cross section

The maximal length of the grille in one piece is **6 500 mm**.



NATUR - marking 11

⚡ NATUR - marking 17



BRONZ - marking 21

⚡ BRONZ - marking 27



BLACK - marking 31

⚡ BLACK - marking 37



STAINLESS - marking 41

⚡ STAINLESS - marking 47

Note: the grilles cannot be used for trench heaters **FRT 0065 0175, FRT 0065 0200, FRT 0065 0250, FRT 0065 0300, FRT 0080 0175, FRT 0080 0200**.

Aluminium linear non-rolling grilles

Aluminium lamellas provided with holes along their length and joined with a steel supporting bar. The grille is divided into more pieces for easy handling. The span between the lamellas is defined by distance rolls of hardened plastic. The plastic rolls are assigned as follows based on the colour of the lamellas: NATUR – silver, BRONZE – black, BLACK – black. Aluminum grilles anodized to form a STAINLESS finish are fitted with stainless steel spacers. The lamellas may be provided with a surface finish of sprayed powder colour according to the RAL sample list.

The maximal length of a single piece is **3 000 mm**. Greater lengths can be achieved by linking more pieces together.

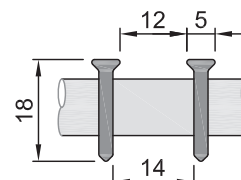

Grille's cross section



NATUR - marking 12



BRONZE - marking 22



BLACK - marking 32



STAINLESS - marking 42

Note: the grilles cannot be used for trench heaters **FRT 0065 0175, FRT 0065 0200, FRT 0065 0250, FRT 0065 0300, FRT 0080 0175, FRT 0080 0200**.

Wooden roll-up grilles

The grilles are manufactured as a roll-up version, i.e. a transverse roll-up grille. The material used is beech and oak. It is possible to order grilles made of wood in natural state or of stained wood. The grilles are a suitable complement of interiors and can be harmonized with a wooden or floating floor. Additional surface modification may be used to increase the resistance and durability of the grille's material.

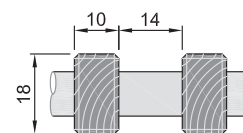

Grille's cross section

Surface finish NATUR – natural wood

Processed wood without an additional surface finish. The wood can be left in the raw state or provided with a surface finish to protect the wood. Based on the type of protection required and the external look (harmonizing with the interior) use staining, oil impregnation, waxing or varnish. The plastic rolls for the NATUR version are in beige.



BEECH NATUR - marking 61



OAK NATUR - marking 63

Surface finish STAINED – stained wood

The wooden lamellas of the grille are stained with a penetrating dyestuff to secure a darker brown colour. This brings out the wood grain and provides a basic surface protection. The plastic rolls are in black.

The maximal length of the wooden grille in one piece is **6 500 mm**.



STAINED BEECH - marking 62



STAINED OAK - marking 64

Note: the grilles cannot be used for trench heaters **FRT 0065 0175, FRT 0065 0200, FRT 0065 0250, FRT 0065 0300, FRT 0080 0175, FRT 0080 0200**.

Transverse stainless steel grille

The grilles are made of 20 × 10 mm stainless steel profiles. This model features robust design, strength and rigidity. Individual grille lamellas have a brushed steel finish running lengthwise.

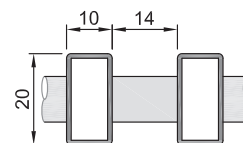

Grille's cross section

Car showroom

A fixed non roll-up grille with a rigid structure designed primarily for use in car showrooms. The grille lamellas are linked by steel rods and held apart by stainless steel spacers. A solid layer of concrete must be poured below the trench heater casing where the grille is to be placed.

The maximum length of 1 section of the stainless steel grille (51) is **2 000 mm**.



STAINLESS Car showroom - marking 51

Design construction, roll up grilles

Interior design with spring-jointed grille lamellas separated by gray hardened plastic spacers.

The maximum length of 1 section of the stainless steel grille (52) is **3 000 mm**.



STAINLESS - marking 52

Highly resistant grille

A special grille made of thick-walled stainless steel. Robust construction resistant to mechanical stress and wear. Ideal for installation in frequented areas (restaurants, cafés, entrance halls, business centers). Its rigid and compact design also ensures high resistance to concentrated loading (high heels). While the vents provide adequate air permeability, a 10% reduction in the trench heater output should still be expected.

The maximum length of one section is **1 000 mm**. The grille is composed of several sections of equal size to achieve the required length. The maximum width of the convector heater is **300 mm**.

Notes:

- The grilles are not suitable for convector heaters with a standard low grille: **FRT0065 0175, FRT 0065 0200, FRT 0065 0250, FRT 0065 0300, FRT 0080 0175, FRT 0080 0200**.
- grille is not suitable for heating / cooling trench heaters **FRC, FRD, FZC, FZD**



STAINLESS Solid - marking 95

Peripheral ledge

It forms the architectural and functional borders of the trench heater after its installation in the floor. The ledge of anodized aluminium is available in colours „NATUR“, „BRONZE“ and „BLACK“. The peripheral ledges may be provided with a surface finish of sprayed powder colour according to the RAL sample list. A trench heater without the peripheral ledge can be supplied for the hidden installation of the trench heater in the floor. In such case this should be written down in the form of a note (a different width of the grille)



The ledge of anodized aluminium

Ledge „J“

A standard ledge that forms an architectural frame alongside the perimeter of the trench heater. Used for installation into floors that fit closely to the trench heater's body. Suitable for paving, architectural concrete, polished concrete floors, stone floors, lino, cork, ...

The ledge is permanently installed during the manufacture of the trench heater.

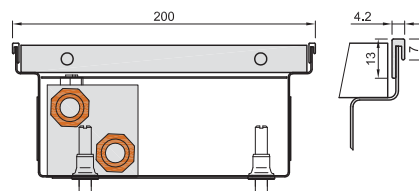

Ledge „L“

A peripheral ledge with an overlap. The L cross section 15×15×1.5 enables the covering of the expansion gap with the width of up to 10 mm. The ledge is put besides the trench heater. It is installed after the final floor is completed. It is glued onto the inner edge of the trench heater. When installing the trench heater should be installed in a way so it does not exceed the level of the final floor. Suitable for wooden floors, plywood floors, laminate flooring, vinyl. It can be used in cases when the technology of the floor laying requires an expansion gap. The length and width of the trench heater is greater by 21 mm than the dimensions presented in the catalogue.

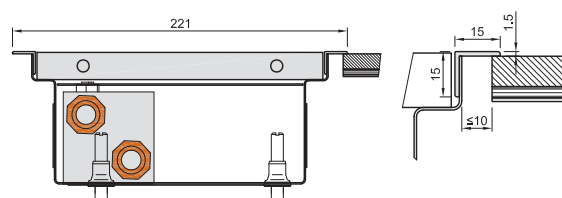

Trench heater installation with an L-profile peripheral ledge



Peripheral ledge L-profile



Peripheral ledge J-profile

Self-standing trench heaters

Its bottom supports make the trench heater a self-standing unit. The setting of the heating unit is final with no additional underlayment concrete required as with standard installations. The self-supporting components allow for height-adjustment in three positions: 0-35 mm, 10-70 mm and 60-300 mm. In this way, the trench heater can be installed in openings deeper than its height.

- installation with the heater not resting on a firm base
- the installation opening is deeper than the height of the planned trench heater unit
- double floor structure (administrative buildings)

NOTICE:

- If this mounting option (self-standing) is selected, the heater acoustic parameters specified in the catalog cannot be guaranteed. Appropriate resonance absorption materials should be used.
- When using the self-standing supports, check the installation opening for adequate size to ensure that there is enough room to use the required tools.
- The self-standing options given are valid for FRT and FRK heaters. Other heater types should be discussed with the Technical Department of ISAN Radiatory s.r.o.

Self-standing option B, 0-35 mm

This type is compatible with FRK heating units only.

In contrast with the standard design, this trench heater features more supporting screws located inside the heater casing.

FRK trench heaters allow 0-35 mm height adjustment.

Note: This alternative is not available for FRT trench heaters. In this case, use underlayment concrete or self-standing option D where applicable.

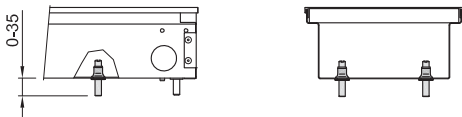

ADJUSTING SCREWS, 0-35 mm

Convector length [mm]	Number of adjusting screw pairs
700-900	2
1000-1400	3
1500-1900	4
2000-2400	5
2500-2900	6
3000-3400	7
3500-3900	8
4000-4400	9
4500-4800	10

Self-standing option D, 10-70 mm

FRT and FRK heating units

The trench heater is fitted with supporting legs and adjusting screws on the sides. The metal leg box is designed for rough height adjustment, while the screw is used for fine-tuning. Lower models might require adjustment of the screw length. The anchor stands are used to prevent the unit from shifting on the floor.

FRT and FRK trench heaters allow 10-70 mm height adjustment.

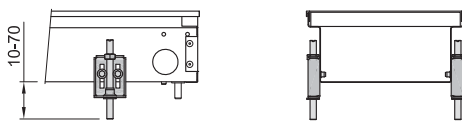

leg with screw



anchor stand

ANCHOR STANDS, 10-70 mm

Convector length [mm]	Number of supporting legs	Number of anchor stands
700-900	4	2
1000-1400	6	4
1500-1900	8	4
2000-2400	10	4
2500-2900	12	4
3000-3400	14	6
3500-3900	16	6
4000-4400	18	6
4500-4800	20	6

Self-standing option V, 60-300 mm

FRT and FRK heating units.

The trench heater is fitted with brackets and a metal box for mounting to the heater. The heating unit is set in the correct position by reducing the bracket height (following measurements at the installation site) and shifting the metal box attached to the heater body.

Given the setting height of the heater, anchor the brackets firmly to the floor.

FRT and FRK trench heaters allow 60-300mm height adjustment.

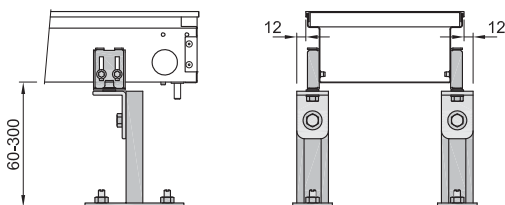

bracket

BRACKETS, 60-300 mm

Convector length [mm]	Number of bracket pairs
700-900	2
1000-1400	3
1500-1900	4
2000-2400	5
2500-2900	6
3000-3400	7
3500-3900	8
4000-4400	9
4500-4800	10

Atypical trench heaters

Folded and cranked

Use broken-line trench heaters to cover heat losses from glassed-in surfaces copying irregular ground plans of rooms. We supply both acute and obtuse angles and multiple cranked trench heaters.

Folded trench heaters comprising from multiple units can be installed in front of long glassed-in surfaces. The trench heater is equipped with a grille from one or multiple pieces which looks like a single long piece at the first sight. Specification of the trench heater location and approval of the design documentation by the customer are required before the start of the production.



Aluminium

transverse grilles
TYPE: 15, 25, 35

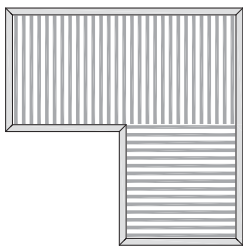

90° angle only

transverse roll-up grilles
TYPE: 11, 21, 31, 41

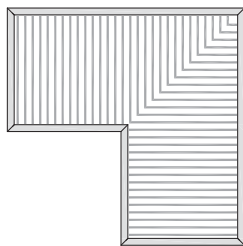

angle 40°– 320°

linear non-rolling grilles
TYPE: 12, 22, 32, 42

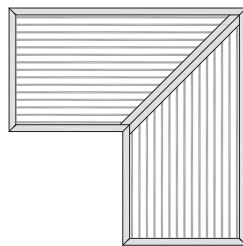

angle 40°– 320°

Wood

roll-up grilles
TYPE: 61, 62, 63, 64

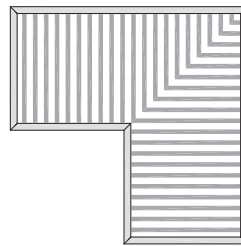

angle 40°– 320°

Stainless

roll-up grilles
TYPE: 51, 52

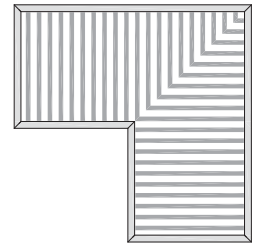

90° angle only

more about grilles on page 6

Examples

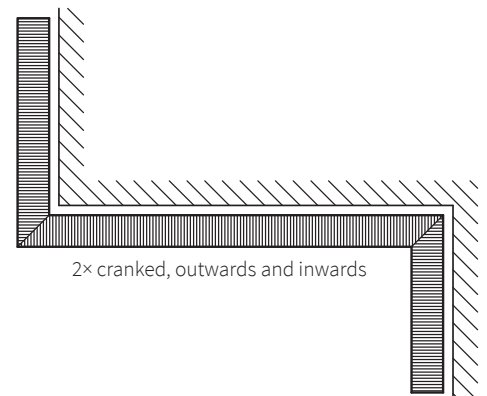
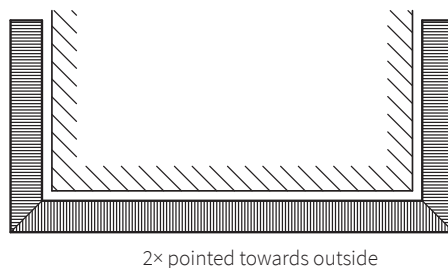
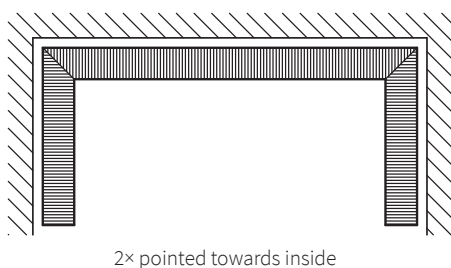
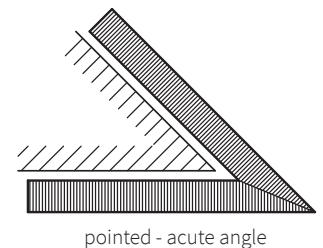
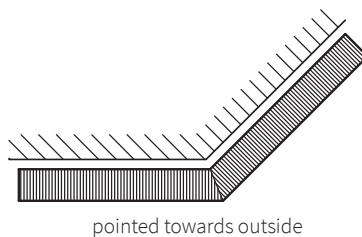
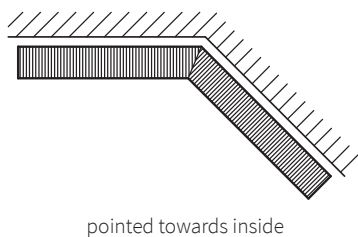
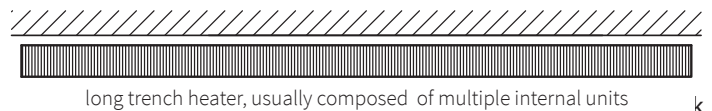
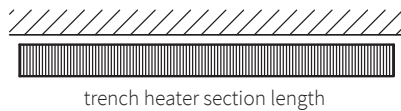

Atypical trench heaters

Arched

Modern structures with glassed-in arched sections can be equipped with rounded trench heaters. Windows are of arched or multiple broken-line shapes. The arch must follow the running line of the glassed-in surface. The trench heater's location must be measured at the construction site since the actual ground plan frequently differs from the design. Please consult this type of the trench heater in advance with the Technical Department of ISAN Radiatory s.r.o.



Examples

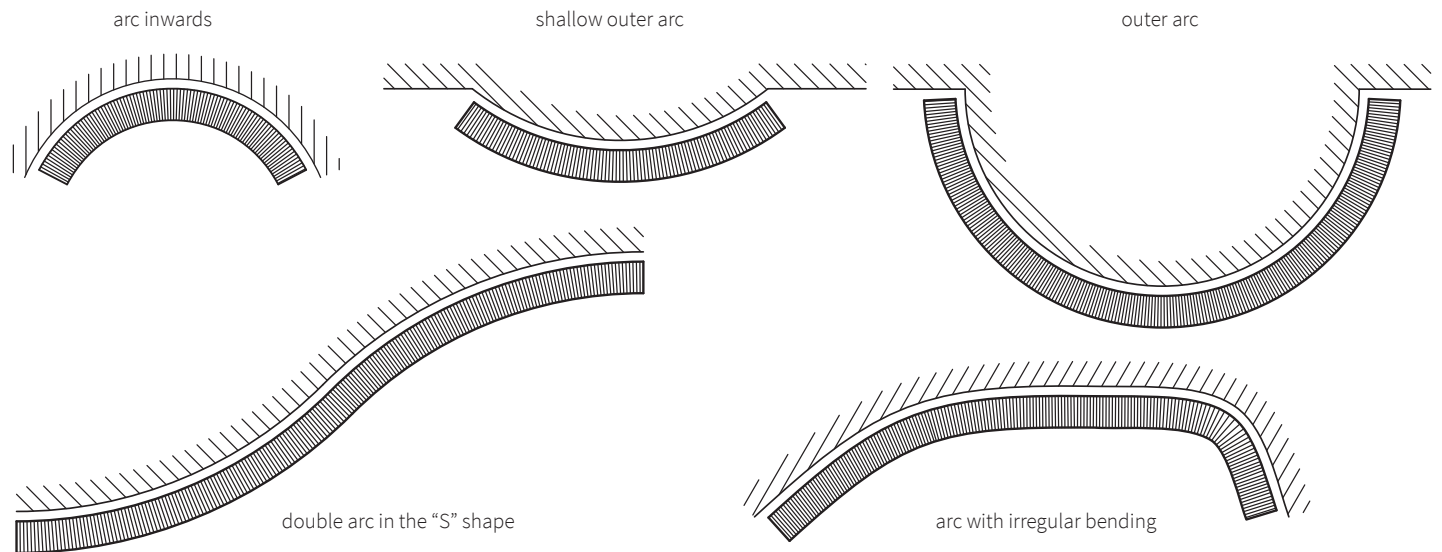

Cutouts in trench heaters

Trench heaters frequently intersect component parts of the structure, such as columns and partition walls. Columns may be fully incorporated in a trench heater or they can only interfere with it. A grille bypasses the column.

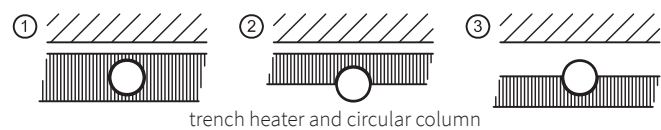
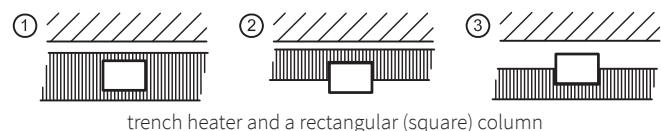

Atypical trench heaters

Preset connection of trench heater

Some projects, due to their scope, require special modifications to the trench heater. One of them is simplified connection of the trench heater, usually for the heating/cooling system, where, due to the number of inner fittings and interconnections, it is advantageous to have everything ready from manufacture. The heater includes thermostatic valves, reverse thread and electrothermal actuators. All of these are connected to the sideboard of the heater, pressure tested and ready for simple connection of heating system pipes. This connection is used in double floor structures, where it is permanently accessible. In some cases the fittings are located in the double floor interspace, with only the exchanger connection brought to the sideboard. A specific solution should be discussed with ISAN technicians to determine the suitability for individual heaters with regard to their dimensions and individual requirements on the elements installed.

Design of trench heater connection

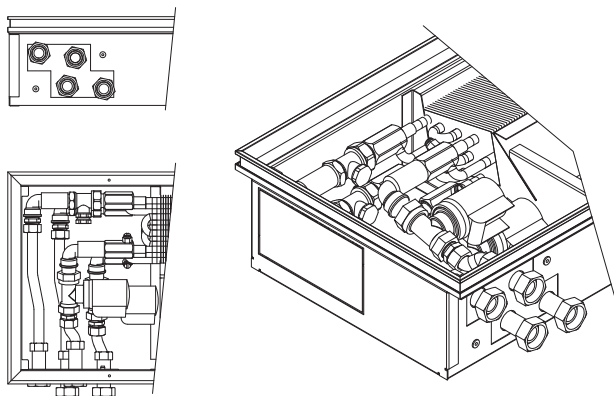

Verification sample



Model installation - functionality verification



Example of double floor structure installation



Fan-assisted trench heating acoustics

When planning fan-assisted trench heater installations for living quarters, it is essential that due consideration is given to both the trench heating acoustics and the environment in which the heater is to be installed. Trench heating units are very quiet, only emitting an audible humming sound when operated at maximum fan speeds. Individual heating units are incorporated into each project based on their output, dimensions, design and the required acoustic parameters. These requirements vary with the environment in which the installation is to take place, which includes residential areas, commercial establishments and public spaces.

Varying environment-based requirements

- Entrance halls, hallways, waiting rooms, lobbies
- Offices, administrative buildings
- Living quarters, public buildings, car showrooms, shops
- Spaces designed for rest and relaxation (living rooms, bedrooms)

Acoustic parameters in the catalogue

The trench heating acoustic parameters are determined in accordance with the EN 16430-1 standard. The parameter for determining the floor heater acoustics is its sound power level. Each fan-assisted product has a table listing these values. All measurements were conducted at an accredited testing facility in Brno in full compliance with EN ISO 9614-2: Acoustics – Determination of sound power levels of noise sources using sound intensity – Part 2: Measurement by scanning.



Description of acoustic parameters

In acoustics, there are two basic parameters: sound **power** and sound **pressure**. The unit determining sound parameters is the decibel [dB(A)].

The level of **sound power** is the total amount of propagated sound energy emitted by a source. It involves sound power propagation via sound waves. The **sound pressure** level is a measure of the effective pressure of a sound at a specific point in the room. It varies at different measurement points and changes greatly (usually decreases) relative to the increasing distance of the source. The EN 16430-1 standard stipulates **sound power** as the primary acoustic parameter which we specify for each product.

Design

Product acoustic parameters constitute an important parameter with respect to trench heating dimensioning. The objective is both to reach the required heat output and to meet the specifications set out in the directive concerning health protection from adverse effects of noise and vibrations.

The project engineer factors in room acoustic parameters as well as the placement of the trench heater in the floor. An empty unfurnished room, which exacerbates the echo sound, will vary significantly, in terms of acoustics, from a room that has been furnished and equipped with sound attenuating elements. If the room furnishing is not known in advance, the least advantageous alternative should be considered. This is accomplished by choosing a more powerful heating unit that can be operated at lower speeds with quieter operation.

Installation of the trench heater inside the floor structure may present other challenges, such as noise and vibration transmission. The bottom part of the heater should therefore rest entirely on a solid support to prevent the reverberation of sound generated by the heater bottom. Where the heating unit comes in direct contact with hollow structures, appropriate sound absorbing transitional materials should be used.

Accessories TERMO

Controls and a power supply need to be added to trench heaters to secure their correct function. The temperature in the room is assessed by a room thermostat (RTD201, RTM201), which controls the fan's revs and the flow of heating medium through the heat exchanger. The flow is controlled via an electrothermal actuator (Z-TS24), which opens or closes a thermostatic valve (Z-TD001, Z-TE001). We install the thermostatic valve at the inlet of the heat exchanger. In order to adjust the flow of the heating medium it is necessary to install and set a screw joint (Z-RD001, Z-RE001) at the exchanger's outlet. The entire circuit functions on the basis of safe voltage of 24 V DC, which is provided by a power supply 24 V DC (DR, DRP), which shall be sized according to the number of installed trench heaters.

Thermostats for trench heaters with fan

RTD201 DIGITAL ROOM THERMOSTAT

For controlling of trench heaters with fans 24 V DC EC and electrothermal actuators 24 V DC



Description

- Digital room thermostat with backlit LCD display
- 2 and 4 pipe heating/cooling circuits
- Week program, 8 time blocks/day
- Manual or automatic switching of speeds
- Operating modes: Comfort, Economy and Protection
- Colour of front cover: white RAL9003

Parameters

- Temperature range 5-40 °C (Comfort mode)
- Rated voltage 24 V DC
- Power consumption max. 2 VA/1 W
- Control of fans 24 V DC EC 0...10 V DC EC, max. ±5 mA
- Max. connecting of 10 pieces of electrothermal actuators Z-TS24
- Degree of protection IP30
- Ambient temperature 0-50 °C
- Relative humidity <95%
- Dimensions: 128×93×31 mm

Optional accessories

- External temperature sensor TE40
- Sensor of exchanger's temperature TE30
- Remote infrared control RC10
- Possibility to connect open window sensor

Setting the thermostat

When putting into operation it is necessary to switch over the DIP switch and set the thermostat's internal parameters, for more see the page 129.

RTD201KN KNX ROOM THERMOSTAT

A digital RTD201KN thermostat to facilitate trench heating integration into the BMS system.



Description

- Digital room thermostat with backlit LCD display
- 2 and 4 pipe heating/cooling circuits
- KNX bus communication (S-mode and LTE-mode)
- Manual or automatic switching of speeds
- Operating modes: Comfort, Economy and Protection
- Colour of front cover: white RAL9003

Parameters

- Temperature range 5-40 °C (Comfort mode)
- Rated voltage 24 V DC
- Power consumption max. 2 VA/1 W
- Control of fans 24 V DC EC 0...10 V DC EC, max. ±5 mA
- Max. connecting of 10 pieces of electrothermal actuators Z-TS24
- Degree of protection IP30
- Ambient temperature 0-50 °C
- Relative humidity <95%
- Dimensions: 128×93×31 mm

BMS integration

- commissioning via the ACS790 software, ETS configuration software or control elements
- integrated with Synco controllers
- integrated into the DESIGO system via group (ETS) or individual addresses
- integrated into external systems via group addresses (ETS)

Optional accessories

- External temperature sensor TE40
- Remote infrared control RC10
- Possibility to connect open window sensor

RTM201 ROOM THERMOSTAT

A mechanical thermostat for 3-stage control of trench heaters fitted with 24 V DC EC fans and 24 V DC electrothermal actuators.



Description

- mechanical thermostat for trench heating control
- 2-pipe heating/cooling system
- manual 3-speed fan switch
- front cover color - RAL9003 White

Parameters

- Temperature range 8...30°C
- Rated voltage 24 V DC
- Input: 2mA (without external loading)
- 24 V DC EC fan control, max. 10 mA
- Max. connecting of 4 pieces of electrothermal actuators Z-TS24
- fan operation blocking in the event of low heating medium temperature
- anti-freeze protection
- IP30 protection rating
- Ambient temperature 0-50 °C
- Relative humidity <95%
- imensions: 110×96×36 mm

Optional accessories

- Sensor of exchanger's temperature TE30

* The heat-transfer circuit must be in operation in order for this function to work properly.

Accessories TERMO

Controls and possibly a power supply need to be added to trench heaters to secure their correct function. The temperature in the room is assessed by a special thermostat (RTD301, Z-RT001, Z-TF001), which controls the flow of heating medium through the exchanger. The thermostat Z-RT001 controls the flow via an electrothermal actuator (Z-TS24, Z-TS230), which opens or closes a thermostatic valve (Z-TD001, Z-TE001) in the opened/closed mode. The thermostat Z-TF001 controls the thermostatic valve continuously without the need to connect it to a power supply. We install the thermostatic valve at the inlet into the exchanger. In order to adjust the flow of the heating medium it is necessary to install and set a lockshield valve (Z-RD001, Z-RE001) at the exchanger's outlet. The entire circuit functions on the basis of safe voltage of 24 V DC, which is provided by a switched power supply 24 V DC (DR, DRP). This type of connection will especially be used in rooms with the combination of trench heaters with a fan and trench heaters without a fan – this all is connected to thermostat RTD201. The second option is the connection of Z-TS230 without the use of a power source – only for rooms with trench heaters without fans.

Thermostats for trench heaters with natural convection

RTD301

PROGRAMMABLE ROOM TEMPERATURE THERMOSTAT

The thermostat controls heat-transfer fluid flow through natural convection trench heaters. It works in combination with Z-TS230 electrothermal actuators activated based on a time schedule adjustable to 15-minute intervals.



Description

- 2 position ON/OFF heating control
- Weekly time schedule
- Operating modes: Comfort, Standby, Automatic and Protection
- Front cover color - RAL9003 White

Parameters

- Temperature range: 5-35 °C
- Supply voltage: 3 V DC (2x 1.5 V batteries)
- Switching voltage: 230 V AC
- Connectable to up to 15 pcs Z-TS24 electrothermal actuators
- Degree of protection IP30
- Ambient temperature 0-50 °C
- Relative humidity <95%
- Dimensions: 127×85×22 mm

Optional accessories

- External TE40 temperature sensor
- Optional open-window sensor

Z-RT001

ROOM THERMOSTAT FOR FLOW CONTROL IN TRENCH HEATERS WITHOUT FAN

It controls electrothermal actuators Z-TS24 with a switched power supply 24 V DC (DR). Without the power supply it directly controls the electrothermal actuator Z-TS230 working with the voltage of 230 V AC. Function opened/closed.



Parameters

- Temperature range: 10 to 30 °C
- Operating voltage: 24 V DC or 230 V AC
- The number of controlled electrothermal actuators:
 - 24 V DC - 10×Z-TS24
 - 230 V AC - 30×Z-TS230
- Protection: IP30
- Colour: white
- Dimension: 83×83×40 mm

Z-TF001

ROOM THERMOSTAT WITH A THERMOSTATIC HEAD WITH A CAPILLARY

The thermostatic head Z-TF001 with remote control with a liquid sensor is meant for the control of thermostatic valves of FRK trench heaters. The temperature is regulated in dependence on the user's requirements without the need for other energy sources. Each trench heater must have its own Z-TF001, more trench heaters cannot be controlled!



Parameters

- Thermostatic radiator valve head with remote liquid-filled sensing element
- Temperature range: 9 to 26 °C, antifreeze temperature 9°C
- Mode: proportional control
- Operating temperature: without additional energy, liquid-filled sensing
- Capillara tube length: 5 m
- Body-head connection: M30×1,5 mm
- Dimension: 75×75 mm, sensor ø 50×68 mm
- Colour: white to RAL 9010

 The accessories are also suitable for electric trench heaters.

Accessories TERMO

DR60-24 / DR100-24 / DRP240-24 / DRP480-24 POWER SUPPLY

Converts the mains voltage of 230 V AC to safe voltage of 24 V DC, power supply made ready for installation on DIN bar.

Description

- For the placement of the source provide sufficient space in the switchboard
- Size the output to fit the input of installed bodies and cabling, provide 5% output reserve on the source against calculated consumption
- DR60-24 and DR100-24 may be installed in a box for wall installation



DR60-24, 60 W

24 V DC, 78×93×56 mm



DR100-24, 100 W

24 V DC, 100×93×56 mm



DRP240-24, 240 W

24 V DC, 126×126×100 mm



DRP480-24, 480 W

24 V DC, 227×126×100 mm

Z-TS24 / Z-TS24-5m ELECTROTHERMAL ACTUATOR 24 V DC

Opened/closed function (without voltage closed).

Parameters

- Input voltage: 24 V DC
- Power consumption: at switch-on 6 VA, input at operation: 2,5 W
- Opening/closing time: 270 s
- Degree of protection: IP54 cover of the casing
- Connection to valve: M30×1,5 mm
- Total height at max. lift: 74 mm
- Colour of actuator and cable: black RAL9005
- Z-TS24** cable length 3 m
- Z-TS24-5m** cable length 5 m

Z-TS230/Z-TS230-5m ELECTROTHERMAL ACTUATOR 230 V AC

opened/closed function (without voltage closed)

Parameters

- Input voltage: 230 V AC
- Power consumption: at switch-on 58 VA, input at operation: 2,5 W
- Opening/closing time: 210 s
- Degree of protection: IP54 cover of the casing
- Connection to valve: M30×1,5 mm
- Total height at max. lift: 74 mm
- Colour of actuator and cable: black RAL9005
- Z-TS230** cable length 3 m
- Z-TS230-5m** cable length 5 m

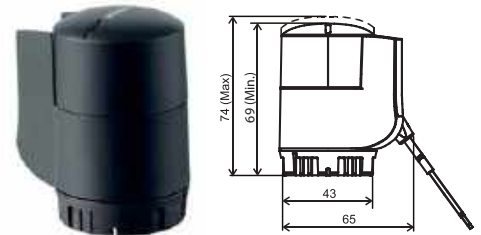

Z-RD001 / Z-RE001 LOCKSHIELD VALVE DIRECT AND CORNER

Direct and corner closing and regulation screw connection, flow setting, installation on the exchanger's outlet pipe.

Parameters

- Size: DN15
- Value kvs
 - direct 0.30-1.80
 - corner 0.30-3.00
- Max. operating temperature: 110 °C
- Max. operating overpressure: 10 bar



Z-RD001
direct screw connection



Z-RE001
corner screw connection

T – Speed	0,5	0,75	1	1,5	2	2,5	3	3,5	4	5	6	Max.
Kv (m³/h) – direct type	0,3	0,4	0,55	0,75	0,91	1,05	1,25	1,33	1,4	1,6	1,7	1,8
Kv (m³/h) – corner type	0,2	0,25	0,29	0,4	0,5	0,69	0,8	1	1,2	1,55	1,9	2,2

Accessories TERMO

Z-TD001 / Z-TE001 THERMOSTATIC VALVE DIRECT AND CORNER

Direct and corner thermostatic valve, heating medium flow regulation in the system, installation on the heat exchanger's inlet pipe direct/corner.

Parameters

- Size: DN15, NF standard
- Connecting thread: M30×1,5 mm
- Max. operating temperature 120 °C
- Max. operating pressure PN10
- Option to change pre-setting of kv-value
- kv value (m3/h) range 0.10-0.89
- kv value (m3/h) for zone 2K 0.52



Z-TD001
direct thermostatic valve



Z-TE001
corner thermostatic valve

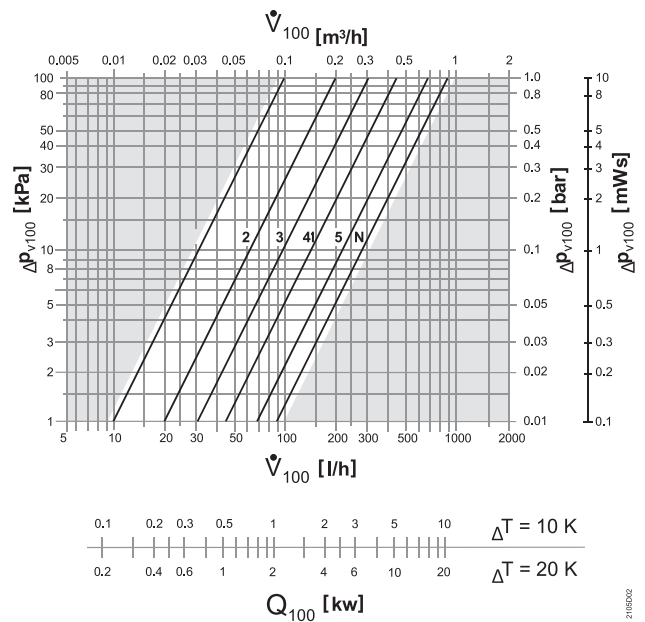

PR40, PR50 EXTENSION PIECES WITH ELBOWS for FRT, FRK heaters

For easy connection of the trench heater to the heating system in the direction towards the room centre. The length of the extension piece and the types of elbows will set the connection points opposite the openings in the trench heater's trough.

PR50 extension piece 50 mm, 2×elbow 90°

Use for models

- FRT 0065 0175
- FRT 0065 0200
- FRT 0065 0250
- FRT 0065 0300
- FRT 0080 0250
- FRT 0080 0300
- FRK 0065 0250
- FRK 0065 0300
- FRK 0080 0250
- FRK 0080 0300
- FRK 0080 0425

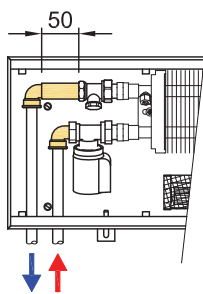

PR40 – extension piece 40 mm, 2×elbow 90°

All other models FRT, FRK, except for the ones stated with PR50

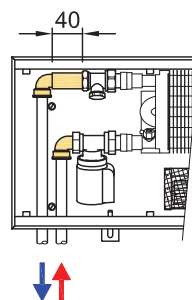

Accessories TERMO

DF10 FAN INTAKE FILTER FOR FRC, FRD, FZC AND FZD HEATERS

Parameters

- Available only for models of dimension 135 × 325 mm
- Colour: black
- Filter dimensions: please mention in the order the length of the convector (e.g. DF10 for FRC 135x325, l=2000 mm)



CP10 CONDENSATE DIAPHRAGM PUMP FOR FRC, FRD, FZC AND FZD HEATERS

A membrane pump of condensate that may occur at cooling, connection to the convector drain pipe

Parameters

- Operation voltage: 230 V/50 Hz
- Power input: 16 W / 0.17 A
- Max. recommended delivery: 10 m
- Capacity l/h: 12 l (0 m) – 4.5 l (10 m)
- Acoustic pressure at delivery of 1m: 21 dB(A)
- Voltage-free contact - alarm: 3 A induction, contacts N.O., N.C.



RL10 RELAY

The thermostat RTD201 allows for the connection of 10 pieces of electrothermal actuators at most, if the number of installed actuators is higher use RL10 according to the electric scheme.

Parameters

- voltage in winding 24 V DC
- Degree of protection IP20
- Max. switching current 12 A
- Without voltage: disconnection
- 37×20×39 mm
- Max. operating temperature 60 °C



KP10 BOX FOR POWER SUPPLY

Box to place under plaster, for the installation of the power supply.

Parameters

- Option of installation of DR60-24 and DR100-24
- Attachment to DIN bar
- Installation under plaster, hidden in the wall
- 234×176×79 mm
- For the case when more supplies need to be installed
- When the space in the switchboard is not sufficient



Accessories TERMO

TE30 SEPARATED TEMPERATURE SENSOR / for thermostat RTD201 and RTM201

Parameters

Heating

a separate temperature sensor monitors the heat exchanger temperature, ensuring the fans are not activated while the heat exchanger is cool

Heating / cooling

automatic switching between heating/cooling modes

- Connection to thermostat RTD201, RTM201
- Measuring sensor NTC, 3 k Ω at 25 °C
- Measuring accuracy at 25 °C: ± 0.3 K
- Cable length ca. 2.5 m, can be adjusted, max. total length 80 m
- Temperature range 5-40°C



TE40 EXTERNAL SPATIAL SENSOR FOR TEMPERATURE / for thermostat RTD201

Parameters

- Measures room temperature on a different spot than the spot where the thermostat is installed
- Connection to thermostat RTD201
- Measuring range 0-40 °C
- Measuring sensor NTC, 3 k Ω at 25 °C
- Measuring accuracy at 25 °C: ± 0.3 K
- Degree of protection IP30
- Operating temperature 0-50 °C
- Relative humidity <85 %
- White colour RAL9003
- 97×100×36mm



RC10 REMOTE CONTROL / for thermostat RTD201, Infrared

RC10 is an infrared control for use with room thermostat RTD201. Communication between the remote control and the spatial regulator is one way. Current setting is shown on the display. Any change carried out directly on the spatial regulator will not be synchronized with the remote control.

Parameters

- Operating mode selection: Comfort, Automatic with a time mode or Protective mode
- Change of the setting of required spatial temperature in the Comfort mode
- Selection of the fan's operating mode: Automatic or manual selection of the fan's speed
- Operating distance (infrared transceiver), distance ≤ 7.5 m, angle $\leq \pm 30^\circ$



 The accessories are also suitable for electric trench heaters.

FET, FEK





electric trench heater
**with an electric heating unit,
heating**

TERMO - electric trench heaters



Features

- optimum heat outputs
- all electric
- no heating system connection required
- continuous output regulation
- safety features
- electronic regulator
- 24 V DC EC tangential fans
- 4 grille designs



Electric trench heaters are normally installed directly in front of large glass surfaces. The advantage of electric-only heaters lies in their independence of forced-circulation heating systems. The heat output produced by trench heaters is sufficient to be used either as the primary or secondary heat source. They make a perfect fit in the existing building space, in contemporary low-energy and passive homes, in electric-only houses, in buildings under construction and wherever connection to the heating system is not possible or desirable.

The family of electric trench heaters includes the **FEK** model with natural convection and a fan-operated **FET** model. The trench heater includes a built-in electric heating unit controlled by an electronic regulator. Forced convection models feature a tangential ventilator with cylindrical rotors, designed to force air into the ribbed heating unit. This allows for more than doubling the heat output without any increase in size. The heaters utilize efficient EC motors supplied with safe 24 V DC voltage. The motors have very low power consumption. The fan speed is continuously regulated by a control voltage in the range from 0 to 10 V DC.

Function

The trench heater is controlled via a room thermostat or 0-10 V DC higher-level regulation. The room thermostat ensures correct functioning, adjusts the difference between the preset and actual room temperature, activates the heating unit and regulates the fan speed based on the temperature difference and the set operation mode.

Operation of the heater is regulated by an electronic power controller located in each unit. The output of the heater (both the heating unit and the fan) is smoothly regulated ensuring that any changes in room temperature are continuously monitored and adjusted. This in turn significantly increases the room's thermal comfort. The same applies when using an appropriate control device such as the RTD201 digital thermostat.

Safety

The power electronics are placed in an IP44 aluminium box connected to the heating unit with the same degree of protection. The fan is powered by safe 24 V DC voltage.

The electronics feature a multi-stage function control, including sensors installed above the heat exchanger. The regulating mechanism responds promptly to any changes in conditions if it detects a deviation from normal operation. Especially if the heater is accidentally covered by a rug or if the free air flow through the grille is otherwise impeded, it immediately switches the unit into a stand-by mode or shuts the heater down. The designer grille is securely fixed to the unit and cannot be removed without the appropriate tool.

Heat and safety sensors monitor the output temperature from the trench heater. The grille temperature will not exceed 45 K above the ambient temperature. (in accordance with EN 603335-1 and 603335-2-30).

The range of electric trench heaters

Electric trench heater with fan

FET

- heating
- tangential fan
- lamellar electric heating unit
- dry environment
- page 24

Electric trench heater with natural convection

FEK

- heating
- lamellar electric heating unit
- dry environment
- page 25

Overview of FET, FEK electric trench heaters

FET

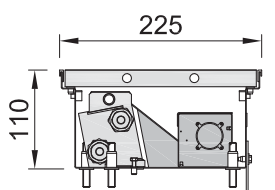

FET 0110 0225
page 24

FEK

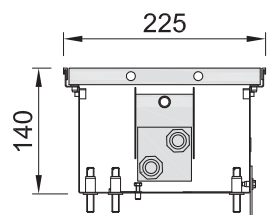

FEK 0140 0225
page 25

Placement in the floor

The trench heaters are laid in the floor so that the heat exchanger is closer to the window side, while fans are placed deeper into the room. The vertical and horizontal distribution of temperatures in the heated room is uniform and conditions are created to provide thermal comfort.

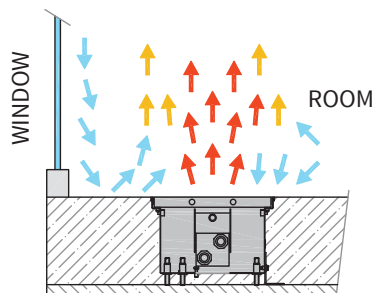
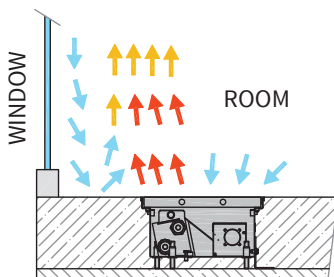

Heating function

- Air becomes heated by flowing through the heat exchanger
- Warm air is mixed with cool air running down the window surfaces
- Air circulation:
 - Heating air in the room
 - Screening out window surfaces
 - Secondary demisting window surfaces

Operating conditions

- Rated voltage of the heater: 230 V AC, 50/60 Hz
- Rated voltage of the heating unit: 230 V AC, 50/60 Hz
- Rated voltage of the fan: 24 V DC (EC motor with continuous speed regulation)
- Protection rating of the heater: IP20, use in dry environments
- Ambient conditions: Ambient temperature +2 - 40°C; Relative humidity 20 - 70%

FET 0110 0225

FAN-ASSISTED ELECTRIC TRENCH HEATER



- glass-walled rooms
- high performance of the heating unit in combination with the fan
- operation independent of the central heating system
- continuous speed regulation, silent operation
- safe 24 V DC fan voltage
- 230 V AC / 50 Hz heating unit
- cable connection to IP44 control regulation
- safety sensors along the entire length of the heating unit



* at an indoor temperature of 20 °C

Technical data

Trench heater

Height [H]	110 mm
Width [W]	225 mm
Length [L]	800-2 000 mm in step 400 mm

Heating unit

Type	Al-Cu type with a heating element
Length	L-410 mm

Operating conditions

Protection	IP 20
Control unit and connection cabling protection	IP 44
Ambient conditions	Temp. T = +2 to +40 °C Humidity RH = 20 to 70%

Trench heater standard equipment

Trough	Galvanized steel trough with surface finish and black spray layer inside, black cover plates of connection
Heating unit	Heating unit with aluminium ribs and tubing, including temperature and safety sensors, black coating
Grille	Design walkable grille according to the customer's choice (stainless grilles surcharge)
Ledge	Made of anodized aluminium, type and colour according to the customer's choice
Fan	Modern tangential fan with 24 V DC EC motor with high efficiency, rotors protection
Assembly elements	Leveling screws for setting up the trough, mounting brackets
Manual	Manual for the progress of work during installation and user manual
Wiring	Electrical wiring diagram of the trench heaters
Mounting board	Cover and the spacer particle board for easy installation
Package	Transport package for protection against damage during transportation and handling

Safety

- Rigid non-roll grille is secured to the trench heater casing - child-tamper resistant
- The surface temperature of the grille does not normally exceed 65°C - in accordance with EN 60335-1 and EN 6035-2-30
- Safety features designed to reduce the output temperature if the grille gets accidentally covered - multiple electronic protection to ensure safety of operation

Technical drawing

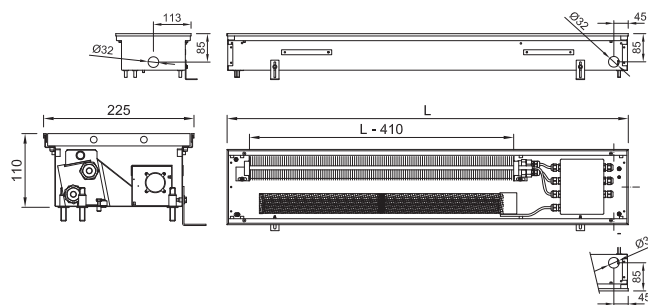

Wiring preview

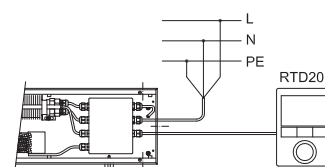

Controls

Room thermostat



Digital room thermostat



Room thermostat

Variants

Grilles

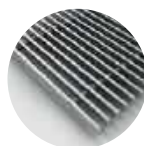

Rigid

Peripheral ledge



- ① Grilles → 6
 ② Ledges → 8
 ③ Acoustic power → 13
 ④ Accessories → 14
 ⑤ Wiring → 27

Code example: FET 0110 0225 1600 C 37 J3 R - 6

Trench heater **FET** H = 110 mm, W = 225 mm, L = 1 600 mm, „**C**“ Galvanized steel trough with black inside, heat exchanger and inner parts painted black, „**37**“ black anodized aluminium grille, transverse, rigid „**J3**“ peripheral ledge „**J**“, black anodized aluminium, „**R**“ right-side power connection (with the heating unit installed closer to the window and fans on the room side) „**6**“ 24 V DC fans + installed control unit

FEK 0140 0225

NATURAL CONVECTION ELECTRIC TRENCH HEATER



- glass-walled rooms
- high performance of the heating unit
- operation independent of the central heating system
- silent operation
- safe 24 V DC fan voltage
- 230 V AC / 50 Hz heating unit
- cable connection to IP44 control regulation
- safety sensors along the entire length of the heating unit

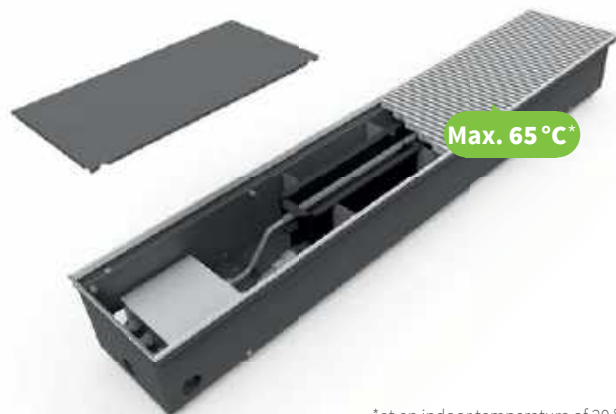

* at an indoor temperature of 20 °C

Technical data

Trench heater

Height [H]	140 mm
Width [W]	225 mm
Length [L]	800-2 000 mm in step 400 mm

Heating unit

Type	Al-Cu type with a heating element
Length	L-410 mm

Operating conditions

Protection	IP 20
Control unit and connection cabling protection	IP 44
Ambient conditions	Temp. T = +2 to +40 °C Humidity RH = 20 to 70%

Trench heater standard equipment

Trough	Galvanized steel trough with surface finish and black spray layer inside, black cover plates of connection
Heating unit	Heating unit with aluminium ribs and tubing, including temperature and safety sensors, black coating
Grille	Design walkable grille according to the customer's choice (stainless grilles surcharge)
Ledge	Made of anodized aluminium, type and colour according to the customer's choice
Fan	Modern tangential fan with 24 V DC EC motor with high efficiency, rotors protection
Assembly elements	Leveling screws for setting up the trough, mounting brackets
Manual	Manual for the progress of work during installation and user manual
Wiring	Electrical wiring diagram of the trench heaters
Mounting board	Cover and the spacer particle board for easy installation
Package	Transport package for protection against damage during transportation and handling

Safety

- Rigid non-roll grille is secured to the trench heater casing - child-tamper resistant
- The surface temperature of the grille does not normally exceed 65°C - in accordance with EN 60335-1 and EN 6035-2-30
- Safety features designed to reduce the output temperature if the grille gets accidentally covered - multiple electronic protection to ensure safety of operation

Technical drawing

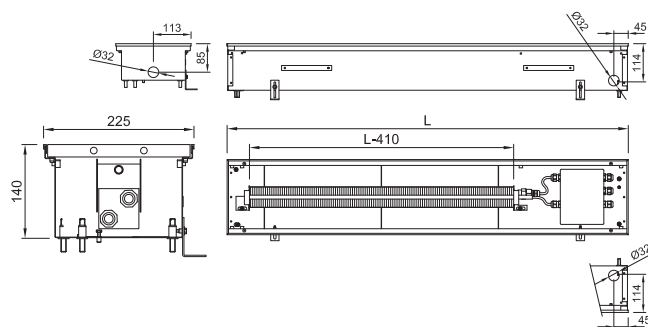

Wiring preview

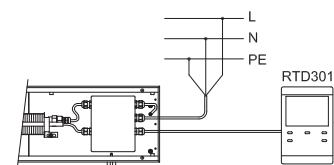

Controls

Room thermostat



Digital room thermostat



Room thermostat

Variants

Grilles

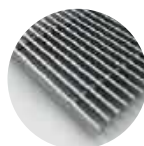

Rigid

Peripheral ledge



- 🔊 Grilles → 6
🔊 Ledges → 8
🔊 Accessories → 14
🔊 Wiring → 27

Code example: FEK 0140 0225 1200 C 17 J1 R - 1

Trench heater FEK H = 140 mm, W = 225 mm, L = 1 200 mm, „C“ Galvanized steel trough with black inside, heat exchanger and inner parts painted black, „17“ natural anodized aluminium grille, transverse, rigid „J1“ peripheral ledge „J“, natur anodized aluminium, „R“ right-side power connection, „1“ installed control unit

FET, FEK – outputs and acoustic parameters

Technical data

Heating output FET 0110 0225

Length L [mm]	Speed [-] / Heating output [W]		
	minimum	medium	maximum
800	90 W	340 W	550 W
1200	165 W	620 W	1 000 W
1600	260 W	990 W	1 600 W
2000	360 W	1 360 W	2 200 W

Heating output can be continuously controlled with 0 ... 10 V DC

Heating output FEK 0140 0225

Length L [mm]	Heating output [W]
	maximum
800	250 W
1200	500 W
1600	750 W
2000	1 000 W

Heating output can be continuously controlled with 0 ... 10 V DC

Acoustic power [dB(A)]

Length L [mm]	Speed [-] / Acoustic power [dB(A)]		
	minimum	medium	maximum
800	< 25 dB(A)	26 dB(A)	29 dB(A)
1200	< 25 dB(A)	27 dB(A)	30 dB(A)
1600	< 25 dB(A)	29 dB(A)	33 dB(A)
2000	< 25 dB(A)	30 dB(A)	34 dB(A)

Trench heater design

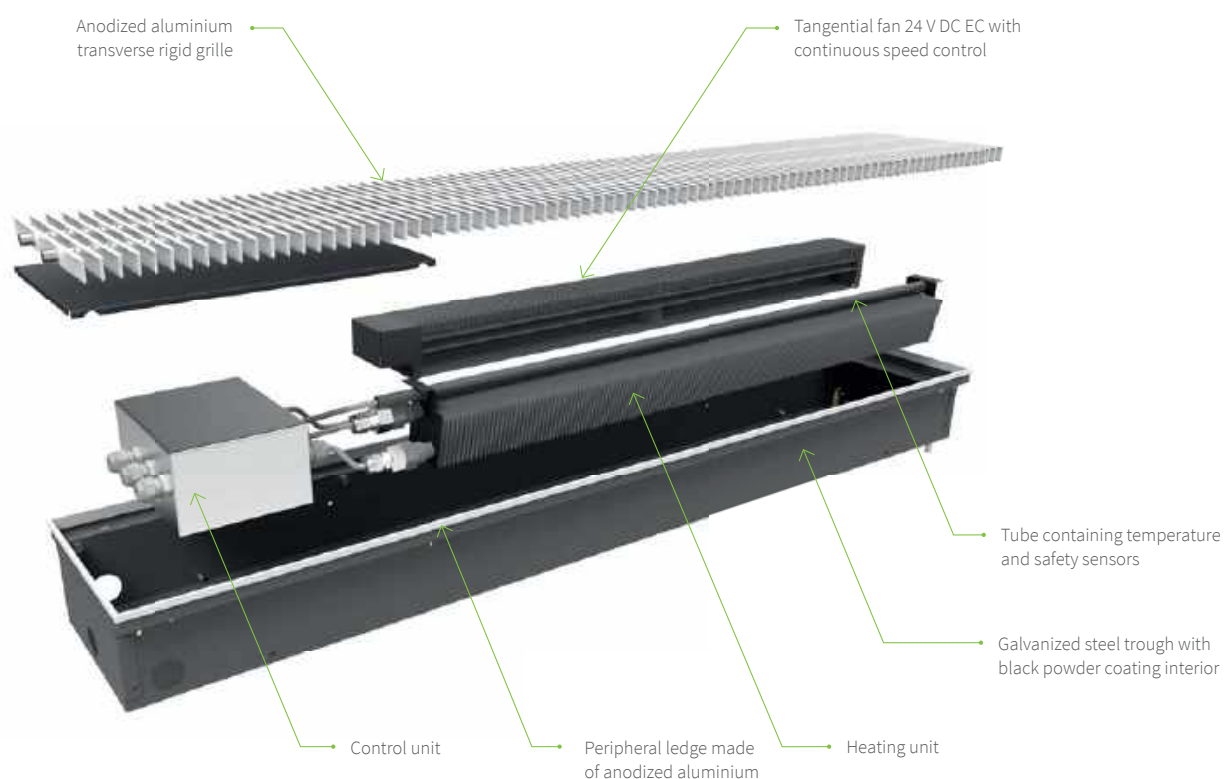

Trench heating wiring diagram

Basic wiring diagram for FET models with the RTD201 thermostat

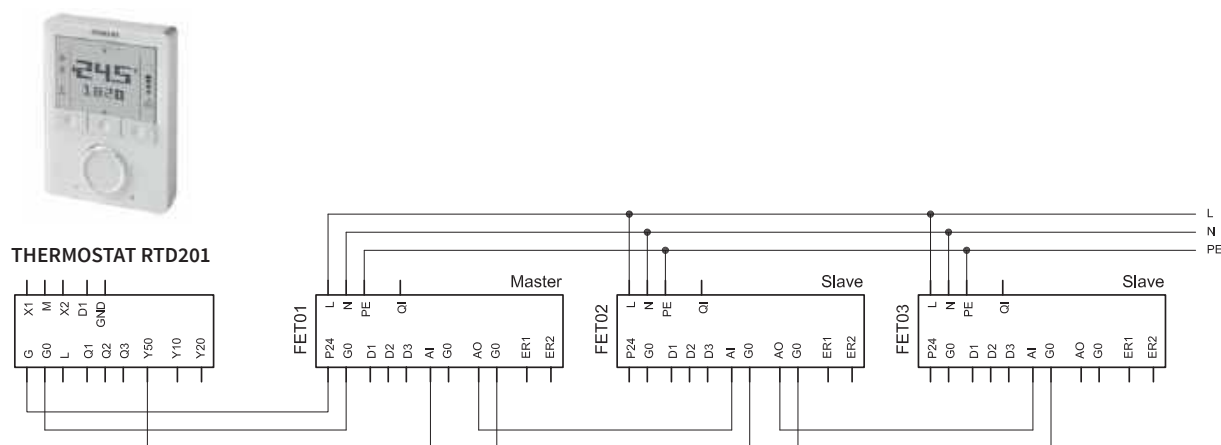

Basic wiring diagram for FEK models with the RTD301 thermostat

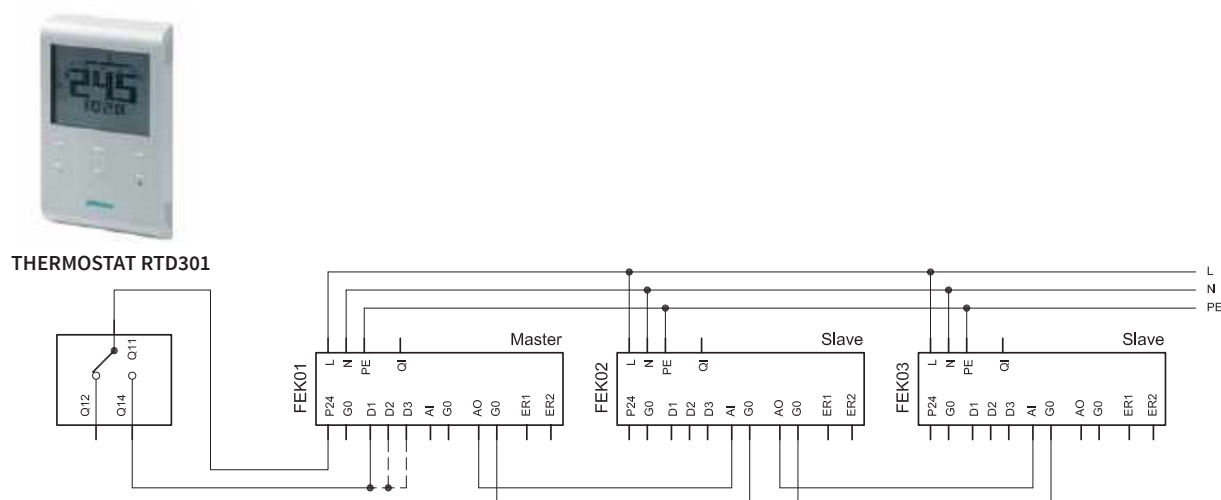

0...10 V DC continuous control

Both FET and FEK electric trench heaters allow for continuous control using a 0...10 V DC signal. The regulator uses this signal to adjust the heating unit output and, in FET models, to continuously regulate the fan speed.

This means that the heater continuously corrects any deviations from the desired room temperature. The RTD201 thermostat functions in the same way.

The 0...10 V DC control facilitates easy integration of the trench heater into modern BMS-controlled buildings and smart homes.

All of these systems are capable of device control using the 0...10 V DC range. As the central control processes information obtained from room sensors, it proceeds to regulate the heating system, including trench heaters, based on the supplier-specified algorithm.

The KNX protocol allows the use of the RTD201KN thermostat, capable of communicating with this higher-level control system (see the accessories).

Combination

It is possible to combine fan-forced and natural-convection trench heaters within one branch. The electricity network must be properly designed with consideration for the power input of individual units.

TERMO for the heating system

WITH FAN



Trench heaters TERMO with forced convection via a fan provide a very good thermal output. This is achieved via installed fans with longitudinal tangential rotors, which force air into a heat exchanger. The fans are fitted with effective electrically commuted (EC) motors functioning on the basis of safe voltage of 24 V DC.

The motors have very small consumption of electric power. The speeds of fans are controlled continuously with a controlling voltage of 0...10 V DC. The room thermostat secures the correct function of all installed TERMO trench heaters, compares the set and actual temperature in the room, opens the flowing of heating medium in the heat exchanger and controls the fan's revs according to the difference in the temperatures and the set mode of operation.

The use of new technologies secures the optimal heating of the interior, which results in energy savings, the economical operation of the trench heater, the high efficiency and flexibility of heating. The trench heater is powered with safe voltage only, all components are powered with direct current of 24 V.

The substantial range of the heights and widths of trench heaters gives the designer a lot of options for selecting a model with the required output for the composition of the floor in question. The necessary data are presented in data sheets of individual products, including the acoustic parameters of the trench heaters.

The range of models with a fan 24 V DC

Heating	Heating / cooling	Heating, humid environment	Heating, installed power supply	Heating and cooling, installed power supply
FRT <ul style="list-style-type: none"> heating with fan lamellar exchanger dry environment page 32 	FRC <ul style="list-style-type: none"> heating and cooling 2 pipe, single circuit with fan lamellar exchanger dry environment page 84 	FRB <ul style="list-style-type: none"> heating with fan lamellar exchanger humid environment page 94 	FRZ <ul style="list-style-type: none"> heating with fan lamellar exchanger installed power supply dry environment page 98 	FZC <ul style="list-style-type: none"> heating and cooling 2 pipe, single circuit with fan lamellar exchanger dry environment installed power supply page 100
	FRD <ul style="list-style-type: none"> heating and cooling 4 pipe, double circuit with fan lamellar exchanger dry environment page 90 			FZD <ul style="list-style-type: none"> heating and cooling 4 pipe, double circuit with fan lamellar exchanger dry environment installed power supply page 100

Trench heater „made to measure“

Based on the requirements of larger projects it is possible to supply a „made to measure“ trench heater with adjusted height and width. Having approved the structure we will submit a protocol from a test room presenting output parameters. We also offer modifications of the trench heater for the use in humid environment, the connection of air handling piping and others. The technical documentation is first consulted with the customer and only then the production of the trench heater starts.

Operating conditions

- Installation in a hot water heating system with forced circulation
- Maximal operating temperature of heating medium 110 °C
- Maximal operating overpressure 1 MPa
- Electric parts with IP20 cover protection, use in dry environment (FRB: use in wet environment)
- Operating voltage 24 V DC
- Ambient temperature +2 to +40 °C
- Relative humidity of environment 20 to 70% (FRB: 20 - 100%)

Connecting to the mains

The connection into the electric circuit is done according to the scheme. The entire circuit is powered with a switched power supply (placed in the switchboard), which provides the voltage of 24 V DC. All trench heaters and the room thermostat are connected to this voltage. The cabling shall be sized to ensure that the voltage in distribution lines never drops below 22 V DC in any individual device. More details concerning the sizing of the electric circuit are presented on page 129.

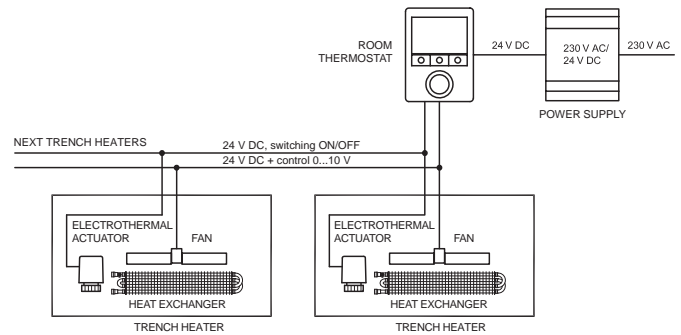

Connecting in the heating system

Lamellar **Al-Cu** heat exchangers have aluminium lamellas pressed onto a copper pipe through which the heating medium flows.

The pipe's outlet and inlet are equipped with a connecting end with internal thread G1/2". Normally the water connection of the exchanger is on the left side (when the exchanger is placed nearer the window).

We install a thermostatic valve fitted with an electrothermal actuator on the inlet of the lamellar heat exchanger. The actuator works in the opened/closed mode and controls the flow of the heating medium. It is not necessary to use a thermostatic valve if the temperature of the heating medium is controlled by the heating system (e.g. equithermal system). The way of regulation is to be determined by the designer of the heating and this shall be specified in the project documentation.

A return regulating screw connection shall be used for the outlet. This enables the incorporation of the trench heater into the heating system from the viewpoint of the hydraulic balancing. Based on the parameters of the screw connection used the designer determines the setting (corresponding to pressure loss at the fitting) and this value shall be specified in the project documentation.

Each exchanger is fitted with an air vent valve. When the heating system is connected and filled air bubbles remain caught in the upper part of the exchanger. These shall be let out through the air vent valve.

Hydraulics

- Tables with hydraulic resistance are presented on page 126.
- Some trench heaters have a too high output at thermal gradient of 75/65/20°C, during the calculation of the required flow and hydraulic resistance we will exceed the recommended limitations.
- We design such trench heaters for low-temperature systems or systems with a high difference between inlet and outlet, in which the output and thus also the flow of the heating medium are at acceptable level. Let us consider the flow rate of the heating medium to be up to 300 kg/hour. The designer may increase the flow in the trench heater's exchanger being aware of the fact that this will increase hydraulic resistance and flow rate in the piping (correct sizing of overpressure and the pump), the table with hydraulic parameters is presented on page 126.
- If the output is too high, it is possible to use a trench heater with a reduced number of fans;
- it is best to consult our technical department ISAN Radiátory s.r.o. if this variant is to be selected.

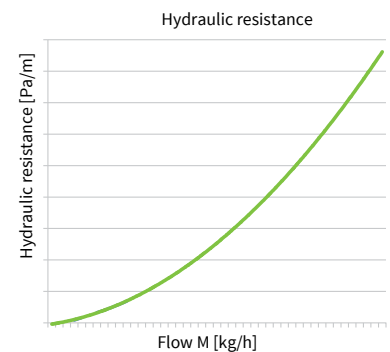

How to size the trench heater

What room the trench heater is to be placed in

We always consider output and acoustic parameters of the trench heater taking into account the room's nature – residential rooms, bedrooms, corridors, offices, theatres, hospital rooms, halls, presentation rooms and others. The trench heater shall comply with the requirement for thermal output at a selected temperature gradient, however at the same time the operation shall not disturb the user with excessive noise. The noise issue is regulated by the applicable standard, which defined permitted limits for individual types of rooms. (more info on page 13).

The output of the trench heater

The tables contain output data for thermal gradient 75/65/20°C, standardized output according to standard ČSN EN 16 430-2. This standard also defines the procedure for conversion to other thermal gradients. The second table presents a converted thermal gradient of 55/45/20°C and a fast approximate conversion for gradients of 90/70/20°C and 70/55/20°C.

Cooling capacity is indicated for dry cooling 17/19/28 °C.

- Convert the output to the required thermal gradient, check acoustic parameters.
- It is not a problem if the calculated output is higher than the required one – the automatic regulation functions from the lowest revs per the output that is equal to the current thermal loss in the room, the trench heater will not overheat, on the contrary it will function with less noise (it will achieve the required output at lower revs), the comfort temperature in the room will be achieved faster

FRT





Fan-assisted trench heaters
with **lamellar heat exchanger,**
heating

TERMO - FRT

Fan-assisted heaters with lamellar heat exchanger

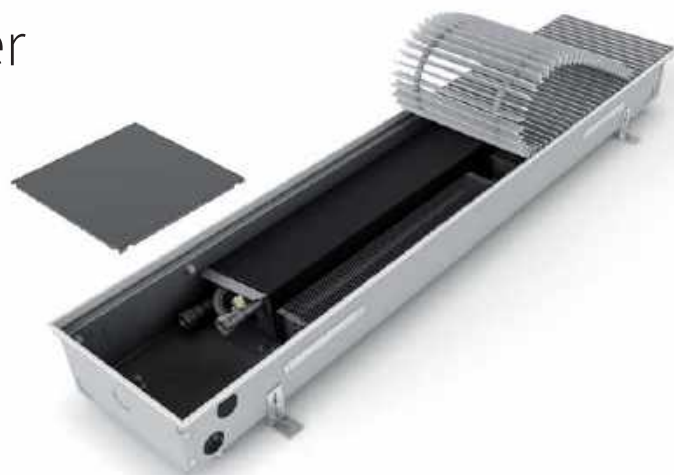

Trench heaters FRT with forced convection via a fan provide a very good thermal output. This is achieved via installed fans with longitudinal tangential rotors, which force air into a heat exchanger with lamellas. The fans are fitted with effective electrically commuted (EC) motors functioning on the basis of safe voltage of 24 V DC. The motors have very small consumption of electric power. The speeds of fans are controlled continuously with a controlling voltage of 0...10 V DC. The room thermostat secures the correct function of all installed FRT trench heaters, compares the set and actual temperature in the room, opens the flowing of heating medium in the heat exchanger and controls the fan's revs according to the difference in the temperatures and the set mode of operation.

The use of new technologies secures the optimal heating of the interior, which results in energy savings, the economical operation of the trench heater, the high efficiency and flexibility of heating. The trench heater is powered with safe voltage only, all components are powered with direct current of 24 V.

The substantial range of the heights and widths of trench heaters gives the designer a lot of options for selecting a model with the required output for the composition of the floor in question. The necessary data are presented in data sheets of individual products, including the acoustic parameters of the trench heaters.

The range of FRT models with a fan 24 V DC

Height	65 mm	80 mm	90 mm	110 mm	125 mm	140 mm
Width	175 mm	175 mm	175 mm	175 mm	-	-
	200 mm	200 mm	200 mm	200 mm	--	-
	250 mm	250 mm	250 mm	250 mm	250 mm	250 mm
	300 mm	300 mm	300 mm	300 mm	300 mm	300 mm
	-	-	425 mm	425 mm	425 mm	425 mm

Placement in the floor

The trench heaters are laid in the floor so that the heat exchanger is closer to the window side, while fans are placed deeper into the room. The vertical and horizontal distribution of temperatures in the heated room is uniform and conditions are created to provide thermal comfort. Air flow is comparable to the heat transfer with classical heating bodies placed on the wall below windows.

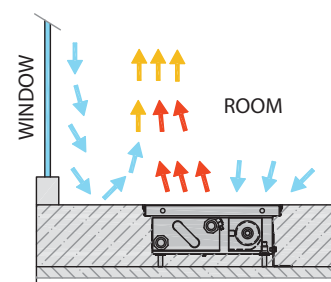

FRT overview of trench heaters with fan



Trench heaters according to the customer's requirements

For the needs of large projects we may adjust the dimensions, structure and internal arrangement. A solution for humid spaces, the connection of an air handling system with modified air. Thermal output measurements will be supplied with the project.

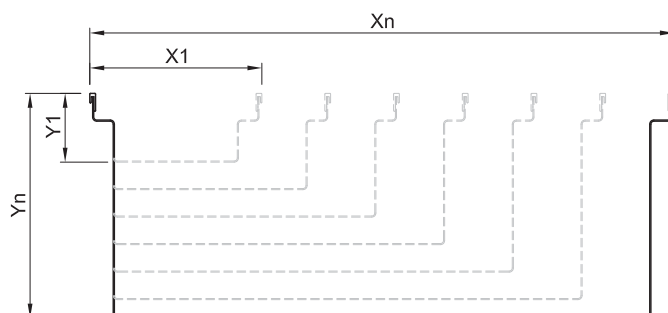

FRT 0065 0175

TRENCH HEATER WITH FAN



- Flats, detached houses, offices, administrative buildings
- The lowest and the most narrow fan assisted trench heater
- High heating output
- Continuous speed control
- Quiet operation
- Common electricity consumption **2 W/m**
- Using in dry environment



Technical data

Trench heater

Height [H]	65 mm
Width [W]	175 mm
Length [L]	700-4800 mm in step 100 mm

Heat exchanger

Type	Al-Cu lamellar
Length	L-295 mm
Connection thread	2×G1/2" inner

Working conditions

Max. temperature	110 °C
Max. overpressure	1 MPa (10 bar)
Protection	IP 20
Ambient conditions	Temp. T = +2 to +40 °C Humidity Rh = 20 to 70%

Trench heater standard equipment

Trough	Galvanized steel trough with surface finish and black spray layer inside, black cover plates of connection
Heat exchanger	Al-Cu lamellar exchanger with air vent valve, black painted
Grille	Design walkable grille according the customer's choice
Ledge	Made of anodized aluminium, type and colour according the customer's choice
Fan	Modern tangential fan with 24 V DC EC motor with high efficiency
Assembly elements	Leveling screws for setting up the trough, mounting brackets
Manual	Manual for the progress of work during installation and user manual
Wiring	Electrical wiring diagram of the trench heaters
Mounting board	Cover and the spacer particle board for easy installation
Package	Transport package for protection against damage during transportation and handling

Technical drawing

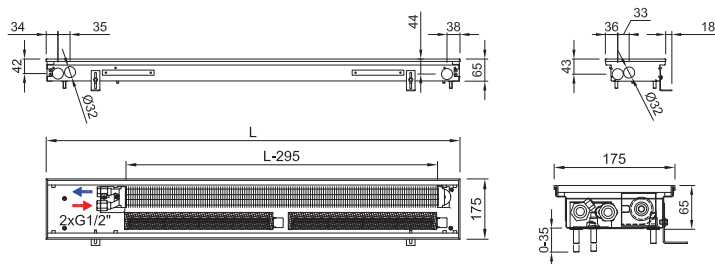

Connection to heating system

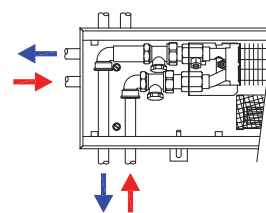

Electrothermal actuator can't be installed in the body of the trench heater due to limited internal space

Accessories per order



Room thermostat



Power supply



Lockshield valve

Variants

Grilles

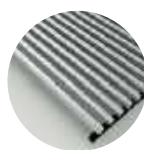

Transverse grilles - rigid

Peripheral ledge



- ① Grilles → 6
 ② Ledges → 8
 ③ Acoustic power → 13
 ④ Accessories → 14
 ⑤ Hydraulic parameters → 126
 ⑥ Wiring → 129

Code example: FRT 0065 0175 1200 C 35 L3 L - 5

Trench heater FRT H = 65 mm, W = 175 mm, L = 1 200 mm, „C“ Galvanized steel trough with black inside, heat exchanger and inner parts painted black, „35“ Low black anodized aluminium grille, transverse, rigid „L3“ peripheral ledge „L“, black anodized aluminium, „L“ water connection on the left side (when installing the heat exchanger closer to the window, fans to the room) „5“ 24 V DC fans without controller (controller is not needed)

FRT 0065 0200

TRENCH HEATER WITH FAN



- Flats, detached houses, offices, administrative buildings
- The lowest and narrow fan assisted trench heater
- High heating output
- Continuous speed control
- Quiet operation
- Common electricity consumption **2 W/m**
- Using in dry environment



Technical data

Trench heater

Height [H]	65 mm
Width [W]	200 mm
Length [L]	700-4800 mm in step 100 mm

Heat exchanger

Type	Al-Cu lamellar
Length	L-295 mm
Connection thread	2xG1/2" inner

Working conditions

Max. temperature	110 °C
Max. overpressure	1 MPa (10 bar)
Protection	IP 20
Ambient conditions	Temp. T = +2 to +40 °C Humidity Rh = 20 to 70%

Trench heater standard equipment

Trough	Galvanized steel trough with surface finish and black spray layer inside, black cover plates of connection
Heat exchanger	Al-Cu lamellar exchanger with air vent valve, black painted
Grille	Design walkable grille according the customer's choice
Ledge	Made of anodized aluminium, type and colour according the customer's choice
Fan	Modern tangential fan with 24 V DC EC motor with high efficiency
Assembly elements	Leveling screws for setting up the trough, mounting brackets
Manual	Manual for the progress of work during installation and user manual
Wiring	Electrical wiring diagram of the trench heaters
Mounting board	Cover and the spacer particle board for easy installation
Package	Transport package for protection against damage during transportation and handling

Technical drawing

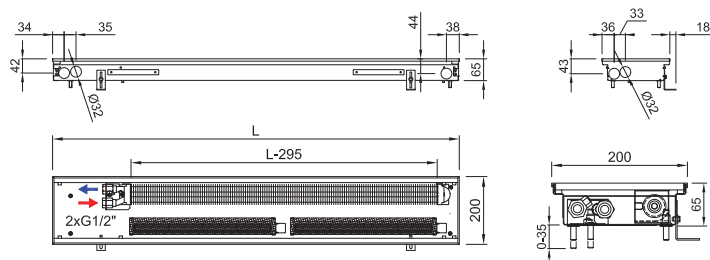

Connection to heating system

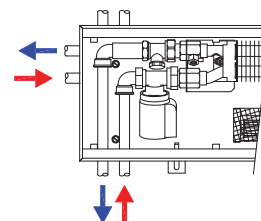

Accessories per order



Variants

Grilles

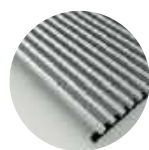

Transverse grilles - rigid

Peripheral ledge



① Grilles → 6 ② Ledges → 8 ③ Acoustic power → 13 ④ Accessories → 14 ⑤ Hydraulic parameters → 126 ⑥ Wiring → 129

Code example: FRT 0065 0200 2000 C 25 J2 L - 5

Trench heater FRT H = 65 mm, W = 200 mm, L = 2 000 mm, „C“ Galvanized steel trough with black inside, heat exchanger and inner parts painted black, „25“ Low bronze anodized aluminium grille, transverse, rigid, „J2“ peripheral ledge „J“, bronze anodized aluminium, „L“ water connection on the left side (when installing the heat exchanger closer to the window, fans to the room) „5“ 24 V DC fans without controller (controller is not needed)

FRT 0065 0250

TRENCH HEATER WITH FAN



- Flats, detached houses, offices, administrative buildings
- The lowest and narrow fan assisted trench heater
- High heating output
- Continuous speed control
- Quiet operation
- Common electricity consumption **2 W/m**
- Using in dry environment



Technical data

Trench heater

Height [H]	65 mm
Width [W]	250 mm
Length [L]	700-4800 mm in step 100 mm

Heat exchanger

Type	Al-Cu lamellar
Length	L-295 mm
Connection thread	2xG1/2" inner

Working conditions

Max. temperature	110 °C
Max. overpressure	1 MPa (10 bar)
Protection	IP 20
Ambient conditions	Temp. T = +2 to +40 °C Humidity Rh = 20 to 70%

Trench heater standard equipment

Trough	Galvanized steel trough with surface finish and black spray layer inside, black cover plates of connection
Heat exchanger	Al-Cu lamellar exchanger with air vent valve, black painted
Grille	Design walkable grille according to the customer's choice
Ledge	Made of anodized aluminium, type and colour according to the customer's choice
Fan	Modern tangential fan with 24 V DC EC motor with high efficiency
Assembly elements	Leveling screws for setting up the trough, mounting brackets
Manual	Manual for the progress of work during installation and user manual
Wiring	Electrical wiring diagram of the trench heaters
Mounting board	Cover and the spacer particle board for easy installation
Package	Transport package for protection against damage during transportation and handling

Technical drawing

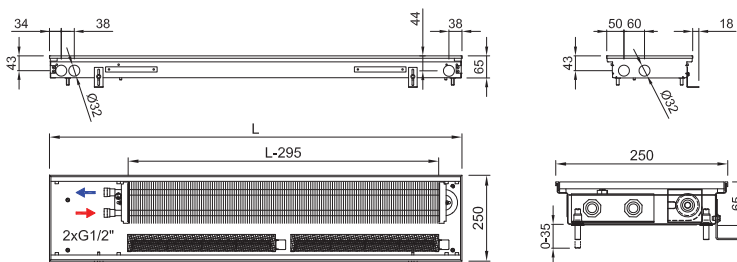

Connection to heating system

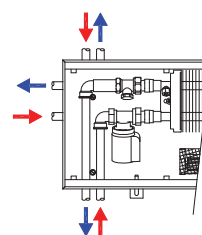

Accessories per order



Variants

Grilles

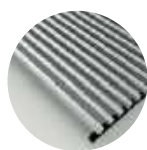

Transverse grilles - rigid

Peripheral ledge



① Grilles → 6 ② Ledges → 8 ③ Acoustic power → 13 ④ Accessories → 14 ⑤ Hydraulic parameters → 126 ⑥ Wiring → 129

Code example: FRT 0065 0250 1600 C 15 J1 L - 5

Trench heater **FRT** H=65 mm, W=250 mm, L=1 600 mm, „C“ Galvanized steel trough with black inside, heat exchanger and inner parts painted black, „15“ Low natural anodized aluminium grille, transverse, rigid, „J1“ peripheral ledge „J“, natur anodized aluminium, „L“ water connection at the left side (when installing the heat exchanger closer to the window, fans to the room), „5“ 24 V DC fans without controller (controller is not needed)



Trench heater heating output FRT 0065 0250

Q[W] 75/65/20 °C (ΔT=50 °C)

Temperature exponent 1,1

Length L [mm]	Speed [-] / Heating output [W]				
	0	1	2	3	4 max.
700	41 W	149 W	312 W	401 W	469 W
800	51 W	198 W	416 W	535 W	625 W
900	61 W	238 W	499 W	642 W	750 W
1000	71 W	337 W	707 W	909 W	1 062 W
1100	81 W	337 W	707 W	909 W	1 062 W
1200	92 W	396 W	832 W	1 069 W	1 249 W
1300	102 W	436 W	915 W	1 176 W	1 374 W
1400	112 W	486 W	1 019 W	1 310 W	1 531 W
1500	122 W	535 W	1 123 W	1 444 W	1 687 W
1600	132 W	586 W	1 229 W	1 580 W	1 846 W
1700	142 W	586 W	1 229 W	1 580 W	1 846 W
1800	152 W	674 W	1 414 W	1 818 W	2 124 W
1900	162 W	734 W	1 541 W	1 981 W	2 315 W
2000	172 W	784 W	1 645 W	2 115 W	2 471 W
2100	183 W	824 W	1 728 W	2 222 W	2 596 W
2200	193 W	824 W	1 728 W	2 222 W	2 596 W
2300	203 W	923 W	1 936 W	2 489 W	2 908 W
2400	213 W	923 W	1 936 W	2 489 W	2 908 W
2500	223 W	982 W	2 061 W	2 649 W	3 095 W
2600	233 W	1 022 W	2 144 W	2 756 W	3 220 W
2700	243 W	1 062 W	2 228 W	2 863 W	3 345 W
2800	253 W	1 121 W	2 352 W	3 024 W	3 533 W
2900	264 W	1 172 W	2 458 W	3 160 W	3 692 W
3000	274 W	1 172 W	2 458 W	3 160 W	3 692 W
3200	294 W	1 320 W	2 770 W	3 561 W	4 161 W
3400	314 W	1 370 W	2 874 W	3 695 W	4 317 W
3600	334 W	1 509 W	3 166 W	4 069 W	4 754 W
3800	355 W	1 558 W	3 270 W	4 203 W	4 910 W
4000	375 W	1 647 W	3 457 W	4 443 W	5 191 W
4200	395 W	1 757 W	3 688 W	4 740 W	5 538 W
4400	415 W	1 846 W	3 873 W	4 978 W	5 816 W
4600	435 W	1 956 W	4 104 W	5 275 W	6 163 W
4800	456 W	1 995 W	4 187 W	5 382 W	6 288 W

75/65/20 °C → 75 °C inlet temperature, 65 °C outlet temp., 20 °C room temp. / Output 90/70/20 °C = ~ 1,22 x 75/65/20 °C / Output 70/55/20 °C = ~ 0,84 x 75/65/20 °C / Heating outputs in accordance with EN 16430 / Not listed heating outputs for lengths per 100 mm steps calculate linearly. Exact values can be found at www.isan.cz

Q[W] 55/45/20 °C (ΔT=30 °C)

Length L [mm]	Speed [-] / Heating output [W]				
	0	1	2	3	4 max.
700	20 W	85 W	178 W	229 W	267 W
800	25 W	113 W	237 W	305 W	356 W
900	30 W	136 W	284 W	366 W	428 W
1000	35 W	192 W	403 W	518 W	605 W
1100	39 W	192 W	403 W	518 W	605 W
1200	44 W	226 W	474 W	609 W	712 W
1300	49 W	249 W	522 W	670 W	783 W
1400	54 W	277 W	581 W	747 W	873 W
1500	59 W	305 W	640 W	823 W	962 W
1600	64 W	334 W	701 W	901 W	1 052 W
1700	69 W	334 W	701 W	901 W	1 052 W
1800	74 W	384 W	806 W	1 036 W	1 211 W
1900	79 W	418 W	879 W	1 129 W	1 320 W
2000	84 W	447 W	938 W	1 206 W	1 409 W
2100	88 W	470 W	985 W	1 267 W	1 480 W
2200	93 W	470 W	985 W	1 267 W	1 480 W
2300	98 W	526 W	1 104 W	1 419 W	1 658 W
2400	103 W	526 W	1 104 W	1 419 W	1 658 W
2500	108 W	560 W	1 175 W	1 510 W	1 765 W
2600	113 W	583 W	1 222 W	1 571 W	1 836 W
2700	118 W	605 W	1 270 W	1 632 W	1 907 W
2800	123 W	639 W	1 341 W	1 724 W	2 014 W
2900	128 W	668 W	1 401 W	1 802 W	2 105 W
3000	132 W	668 W	1 401 W	1 802 W	2 105 W
3200	142 W	753 W	1 579 W	2 030 W	2 372 W
3400	152 W	781 W	1 639 W	2 107 W	2 461 W
3600	162 W	860 W	1 805 W	2 320 W	2 710 W
3800	172 W	888 W	1 864 W	2 396 W	2 799 W
4000	181 W	939 W	1 971 W	2 533 W	2 959 W
4200	191 W	1 002 W	2 103 W	2 702 W	3 157 W
4400	201 W	1 052 W	2 208 W	2 838 W	3 316 W
4600	211 W	1 115 W	2 340 W	3 007 W	3 514 W
4800	221 W	1 137 W	2 387 W	3 068 W	3 585 W

Acoustic power [dB(A)]

Length L [mm]	Speed [-] / Acoustic power [dB(A)]				
	0	1	2	3	4 max.
700	-	< 25	26	33	39
800	-	< 25	27	33	40
900	-	< 25	27	34	40
1000	-	< 25	28	34	41
1100	-	< 25	28	35	41
1200	-	< 25	29	35	41
1300	-	< 25	29	35	42
1400	-	< 25	30	36	42
1500	-	< 25	30	36	42
1600	-	< 25	30	36	43
1700	-	< 25	30	37	43
1800	-	< 25	31	37	43
1900	-	< 25	31	37	43
2000	-	< 25	31	37	44
2100	-	< 25	31	38	44
2200	-	< 25	32	38	44
2300	-	25	32	38	44
2400	-	25	32	38	44
2500	-	25	32	38	45
2600	-	25	33	39	45
2700	-	25	33	39	45
2800	-	25	33	39	45
2900	-	26	33	39	45
3000	-	26	33	39	45
3200	-	26	34	40	46
3400	-	26	34	40	46
3600	-	27	34	40	46
3800	-	27	34	40	46
4000	-	27	35	41	47
4200	-	27	35	41	47
4400	-	27	35	41	47
4600	-	28	35	41	47
4800	-	28	35	41	47

Fans input power [W]*

Length L [mm]	Number of fans	Speed [-] / Fans input power [W]*			
		1	2	3	4 max.
700	1	1 W	1 W	2 W	2 W
800	1	1 W	1 W	2 W	2 W
900	1	1 W	1 W	2 W	2 W
1000	1	2 W	2 W	2 W	3 W
1100	1	2 W	2 W	2 W	3 W
1200	2	2 W	3 W	3 W	4 W
1300	2	2 W	3 W	3 W	4 W
1400	2	3 W	3 W	4 W	5 W
1500	2	3 W	3 W	4 W	5 W
1600	1	3 W	3 W	4 W	5 W
1700	2	3 W	3 W	4 W	5 W
1800	2	3 W	3 W	4 W	5 W
1900	2	3 W	4 W	5 W	6 W
2000	2	4 W	5 W	6 W	7 W
2100	2	4 W	5 W	6 W	7 W
2200	2	4 W	5 W	6 W	7 W
2300	2	4 W	5 W	6 W	7 W
2400	2	4 W	5 W	6 W	7 W
2500	3	5 W	6 W	7 W	9 W
2600	3	5 W	6 W	7 W	9 W
2700	3	5 W	6 W	7 W	9 W
2800	3	5 W	6 W	7 W	9 W
2900	2	5 W	6 W	7 W	9 W
3000	3	5 W	6 W	7 W	9 W
3200	3	6 W	8 W	9 W	11 W
3400	3	6 W	8 W	9 W	11 W
3600	3	7 W	8 W	10 W	12 W
3800	4	7 W	9 W	11 W	13 W
4000	4	7 W	9 W	11 W	13 W
4200	3	7 W	9 W	11 W	13 W
4400	4	8 W	10 W	12 W	14 W
4600	4	8 W	10 W	12 W	15 W
4800	4	8 W	10 W	12 W	15 W

* Approximate fan input powers / When using electrothermal actuator add in the trench heater's power 3 W

FRT 0065 0300

TRENCH HEATER WITH FAN



- Flats, detached houses, offices, administrative buildings
- Low construction of the trench heater
- High heating output
- Continuous speed control
- Quiet operation
- Common electricity consumption **2 W/m**
- Using in dry environment

Technical data

Trench heater

Height [H]	65 mm
Width [W]	300 mm
Length [L]	700-4800 mm in step 100 mm

Heat exchanger

Type	Al-Cu lamellar
Length	L-295 mm
Connection thread	2×G1/2" inner

Working conditions

Max. temperature	110 °C
Max. overpressure	1 MPa (10 bar)
Protection	IP 20
Ambient conditions	Temp. T = +2 to +40 °C Humidity Rh = 20 to 70%

Trench heater standard equipment

Trough	Galvanized steel trough with surface finish and black spray layer inside, black cover plates of connection
Heat exchanger	Al-Cu lamellar exchanger with air vent valve, black painted
Grille	Design walkable grille according to the customer's choice
Ledge	Made of anodized aluminium, type and colour according to the customer's choice
Fan	Modern tangential fan with 24 V DC EC motor with high efficiency
Assembly elements	Leveling screws for setting up the trough, mounting brackets
Manual	Manual for the progress of work during installation and user manual
Wiring	Electrical wiring diagram of the trench heaters
Mounting board	Cover and the spacer particle board for easy installation
Package	Transport package for protection against damage during transportation and handling

Technical drawing

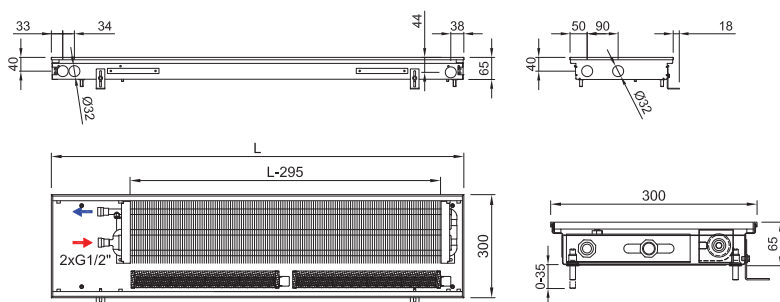

Connection to heating system

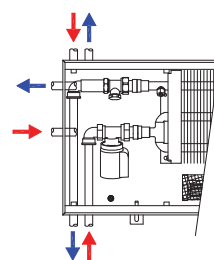

Accessories per order



Variants

Grilles

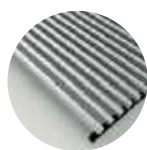

Transverse grilles - rigid

Peripheral ledge



① Grilles → 6 ② Ledges → 8 ③ Acoustic power → 13 ④ Accessories → 14 ⑤ Hydraulic parameters → 126 ⑥ Wiring → 129

Code example: FRT 0065 0300 2000 C 25 J2 R - 5

Trench heater **FRT** H=65 mm, W= 300 mm, L= 2 000 mm, „**C**“ Galvanized steel trough with black inside, heat exchanger and inner parts painted black, „**25**“ Low bronze anodized aluminium grille, transverse, rigid, „**J2**“ peripheral ledge „**J**“, bronze anodized aluminium, „**R**“ water connection at the right side (when installing the heat exchanger closer to the window, fans to the room), „**5**“ 24 V DC fans without controller (controller is not needed)

FRT 0080 0175

TRENCH HEATER WITH FAN



- Flats, detached houses, offices, administrative buildings
- Narrow and low trench heater
- High heating output
- Continuous speed control
- Quiet operation
- Common electricity consumption **2 W/m**
- Using in dry environment



Technical data

Trench heater

Height [H]	80 mm
Width [W]	175 mm
Length [L]	700-4800 mm in step 100 mm

Heat exchanger

Type	Al-Cu lamellar
Length	L-295 mm
Connection thread	2×G1/2" inner

Working conditions

Max. temperature	110 °C
Max. overpressure	1 MPa (10 bar)
Protection	IP 20
Ambient conditions	Temp. T = +2 to +40 °C Humidity Rh = 20 to 70%

Trench heater standard equipment

Trough	Galvanized steel trough with surface finish and black spray layer inside, black cover plates of connection
Heat exchanger	Al-Cu lamellar exchanger with air vent valve, black painted
Grille	Design walkable grille according to the customer's choice
Ledge	Made of anodized aluminium, type and colour according to the customer's choice
Fan	Modern tangential fan with 24 V DC EC motor with high efficiency, rotors protection
Assembly elements	Leveling screws for setting up the trough, mounting brackets
Manual	Manual for the progress of work during installation and user manual
Wiring	Electrical wiring diagram of the trench heaters
Mounting board	Cover and the spacer particle board for easy installation
Package	Transport package for protection against damage during transportation and handling

Technical drawing

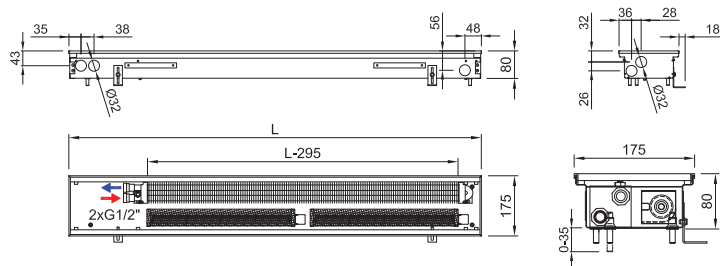

Connection to heating system

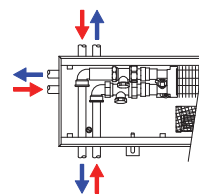

Electrothermal actuator can't be installed in the body of the trench heater due to limited internal space

Accessories per order



Room thermostat



Power supply



Lockshield valve

Variants

Grilles

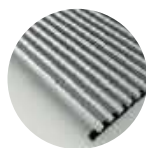

Transverse grilles - rigid

Peripheral ledge



- ① Grilles → 6
② Ledges → 8
③ Acoustic power → 13
④ Accessories → 14
⑤ Hydraulic parameters → 126
⑥ Wiring → 129

Code example: FRT 0080 0175 1700 C 35 J3 L - 5

Trench heater **FRT** H=80 mm, W= 175 mm, L= 1 700 mm, „C“ Galvanized steel trough with black inside, heat exchanger and inner parts painted black, „35“ low black anodized aluminium grille, transverse, rigid, „J3“ peripheral ledge „J“, black anodized aluminium „L“ water connection at the left side (when installing the heat exchanger closer to the window, fans to the room), „5“ 24 V DC fans without controller (controller is not needed)



Trench heater heating output FRT 0080 0175

Q[W] 75/65/20 °C (ΔT=50 °C)

Temperature exponent 1,1

Length L [mm]	Speed [-] / Heating output [W]				
	0	1	2	3	4 max.
700	27 W	94 W	235 W	291 W	347 W
800	34 W	126 W	313 W	388 W	463 W
900	41 W	151 W	375 W	466 W	556 W
1000	47 W	213 W	532 W	660 W	788 W
1100	54 W	213 W	532 W	660 W	788 W
1200	61 W	251 W	625 W	776 W	927 W
1300	67 W	276 W	688 W	854 W	1 019 W
1400	74 W	308 W	766 W	951 W	1 135 W
1500	81 W	339 W	844 W	1 048 W	1 251 W
1600	87 W	371 W	924 W	1 147 W	1 369 W
1700	94 W	371 W	924 W	1 147 W	1 369 W
1800	101 W	427 W	1 063 W	1 320 W	1 575 W
1900	108 W	465 W	1 159 W	1 438 W	1 716 W
2000	114 W	497 W	1 237 W	1 535 W	1 832 W
2100	121 W	522 W	1 299 W	1 613 W	1 925 W
2200	128 W	522 W	1 299 W	1 613 W	1 925 W
2300	134 W	584 W	1 456 W	1 807 W	2 157 W
2400	141 W	584 W	1 456 W	1 807 W	2 157 W
2500	148 W	622 W	1 549 W	1 923 W	2 296 W
2600	155 W	647 W	1 612 W	2 001 W	2 388 W
2700	161 W	672 W	1 674 W	2 079 W	2 481 W
2800	168 W	710 W	1 768 W	2 195 W	2 620 W
2900	175 W	742 W	1 848 W	2 294 W	2 738 W
3000	181 W	742 W	1 848 W	2 294 W	2 738 W
3200	195 W	836 W	2 083 W	2 585 W	3 085 W
3400	208 W	868 W	2 161 W	2 682 W	3 201 W
3600	222 W	955 W	2 380 W	2 954 W	3 526 W
3800	235 W	987 W	2 458 W	3 051 W	3 641 W
4000	248 W	1 043 W	2 598 W	3 226 W	3 850 W
4200	262 W	1 113 W	2 772 W	3 441 W	4 107 W
4400	275 W	1 169 W	2 911 W	3 614 W	4 313 W
4600	289 W	1 239 W	3 085 W	3 829 W	4 570 W
4800	302 W	1 264 W	3 147 W	3 907 W	4 663 W

75/65/20 °C → 75 °C inlet temperature, 65 °C outlet temp., 20 °C room temp. / Output 90/70/20 °C = ~ 1,22 x 75/65/20 °C / Output 70/55/20 °C = ~ 0,84 x 75/65/20 °C / Heating outputs in accordance with EN 16430 / Not listed heating outputs for lengths per 100 mm steps calculate linearly. Exact values can be found at www.isan.cz

Acoustic power [dB(A)]

Length L [mm]	Speed [-] / Acoustic power [dB(A)]				
	0	1	2	3	4 max.
700	-	< 25	< 25	30	35
800	-	< 25	25	30	35
900	-	< 25	25	31	36
1000	-	< 25	26	31	36
1100	-	< 25	26	31	37
1200	-	< 25	26	32	37
1300	-	< 25	26	32	37
1400	-	< 25	27	32	38
1500	-	< 25	27	32	38
1600	-	< 25	27	33	38
1700	-	< 25	27	33	38
1800	-	< 25	28	33	39
1900	-	< 25	28	33	39
2000	-	< 25	28	33	39
2100	-	< 25	28	34	39
2200	-	< 25	28	34	39
2300	-	< 25	28	34	39
2400	-	< 25	29	34	40
2500	-	< 25	29	34	40
2600	-	< 25	29	34	40
2700	-	< 25	29	35	40
2800	-	< 25	29	35	40
2900	-	< 25	29	35	40
3000	-	< 25	29	35	40
3200	-	25	30	35	41
3400	-	25	30	35	41
3600	-	25	30	36	41
3800	-	25	30	36	41
4000	-	25	30	36	42
4200	-	25	31	36	42
4400	-	26	31	36	42
4600	-	26	31	36	42
4800	-	26	31	37	42

Q[W] 55/45/20 °C (ΔT=30 °C)

Length L [mm]	Speed [-] / Heating output [W]				
	0	1	2	3	4 max.
700	13 W	54 W	134 W	166 W	198 W
800	16 W	72 W	178 W	221 W	264 W
900	20 W	86 W	214 W	266 W	317 W
1000	23 W	121 W	303 W	376 W	449 W
1100	26 W	121 W	303 W	376 W	449 W
1200	30 W	143 W	356 W	442 W	529 W
1300	32 W	157 W	392 W	487 W	581 W
1400	36 W	176 W	437 W	542 W	647 W
1500	39 W	193 W	481 W	597 W	713 W
1600	42 W	212 W	527 W	654 W	780 W
1700	46 W	212 W	527 W	654 W	780 W
1800	49 W	243 W	606 W	753 W	898 W
1900	52 W	265 W	661 W	820 W	978 W
2000	55 W	283 W	705 W	875 W	1 044 W
2100	59 W	298 W	741 W	920 W	1 097 W
2200	62 W	298 W	741 W	920 W	1 097 W
2300	65 W	333 W	830 W	1 030 W	1 230 W
2400	68 W	333 W	830 W	1 030 W	1 230 W
2500	72 W	355 W	883 W	1 096 W	1 309 W
2600	75 W	369 W	919 W	1 141 W	1 361 W
2700	78 W	383 W	954 W	1 185 W	1 414 W
2800	81 W	405 W	1 008 W	1 251 W	1 494 W
2900	85 W	423 W	1 054 W	1 308 W	1 561 W
3000	88 W	423 W	1 054 W	1 308 W	1 561 W
3200	94 W	477 W	1 188 W	1 474 W	1 759 W
3400	101 W	495 W	1 232 W	1 529 W	1 825 W
3600	107 W	544 W	1 357 W	1 684 W	2 010 W
3800	114 W	563 W	1 401 W	1 739 W	2 076 W
4000	120 W	595 W	1 481 W	1 839 W	2 195 W
4200	127 W	635 W	1 580 W	1 962 W	2 341 W
4400	133 W	666 W	1 660 W	2 060 W	2 459 W
4600	140 W	706 W	1 759 W	2 183 W	2 605 W
4800	146 W	721 W	1 794 W	2 227 W	2 658 W

Fans input power [W]*

Length L [mm]	Number of fans	Speed [-] / Fans input power [W]*			
		1	2	3	4 max.
700	1	1 W	1 W	2 W	2 W
800	1	1 W	1 W	2 W	2 W
900	1	1 W	1 W	2 W	2 W
1000	1	2 W	2 W	2 W	3 W
1100	1	2 W	2 W	2 W	3 W
1200	2	2 W	3 W	3 W	4 W
1300	2	2 W	3 W	3 W	4 W
1400	2	3 W	3 W	4 W	5 W
1500	2	3 W	3 W	4 W	5 W
1600	1	3 W	3 W	4 W	5 W
1700	2	3 W	3 W	4 W	5 W
1800	2	3 W	3 W	4 W	5 W
1900	2	3 W	4 W	5 W	6 W
2000	2	4 W	5 W	6 W	7 W
2100	2	4 W	5 W	6 W	7 W
2200	2	4 W	5 W	6 W	7 W
2300	2	4 W	5 W	6 W	7 W
2400	2	4 W	5 W	6 W	7 W
2500	3	5 W	6 W	7 W	9 W
2600	3	5 W	6 W	7 W	9 W
2700	3	5 W	6 W	7 W	9 W
2800	3	5 W	6 W	7 W	9 W
2900	2	5 W	6 W	7 W	9 W
3000	3	5 W	6 W	7 W	9 W
3200	3	6 W	8 W	9 W	11 W
3400	3	6 W	8 W	9 W	11 W
3600	3	7 W	8 W	10 W	12 W
3800	4	7 W	9 W	11 W	13 W
4000	4	7 W	9 W	11 W	13 W
4200	3	7 W	9 W	11 W	13 W
4400	4	8 W	10 W	12 W	14 W
4600	4	8 W	10 W	12 W	15 W
4800	4	8 W	10 W	12 W	15 W

* Approximate fan input powers / When using electrothermal actuator add in the trench heater's power 3 W

FRT 0080 0200

TRENCH HEATER WITH FAN



- Flats, detached houses, offices, administrative buildings
- Small universal trench heater
- High heating output
- Continuous speed control
- Quiet operation
- Common electricity consumption **2 W/m**
- Using in dry environment



Technical data

Trench heater

Height [H]	80 mm
Width [W]	200 mm
Length [L]	700-4 800 mm in step 100 mm

Heat exchanger

Type	Al-Cu lamellar
Length	L-295 mm
Connection thread	2×G1/2" inner

Working conditions

Max. temperature	110 °C
Max. overpressure	1 MPa (10 bar)
Protection	IP 20
Ambient conditions	Temp. T = +2 to +40 °C Humidity Rh = 20 to 70%

Trench heater standard equipment

Trough	Galvanized steel trough with surface finish and black spray layer inside, black cover plates of connection
Heat exchanger	Al-Cu lamellar exchanger with air vent valve, black painted
Grille	Design walkable grille according to the customer's choice
Ledge	Made of anodized aluminium, type and colour according to the customer's choice
Fan	Modern tangential fan with 24 V DC EC motor with high efficiency
Assembly elements	Leveling screws for setting up the trough, mounting brackets
Manual	Manual for the progress of work during installation and user manual
Wiring	Electrical wiring diagram of the trench heaters
Mounting board	Cover and the spacer particle board for easy installation
Package	Transport package for protection against damage during transportation and handling

Technical drawing

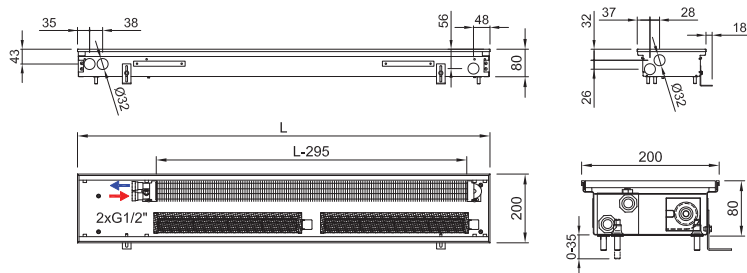

Connection to heating system

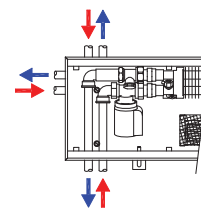

Accessories per order



Variants

Grilles

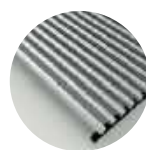

Transverse grilles - rigid

Peripheral ledge



① Grilles → 6 ② Ledges → 8 ③ Acoustic power → 13 ④ Accessories → 14 ⑤ Hydraulic parameters → 126 ⑥ Wiring → 129

Code example: FRT 0080 0200 1900 C 15 L1 L - 5

Trench heater **FRT** H=80 mm, W= 200 mm, L= 1 900 mm, „C” Galvanized steel trough with black inside, heat exchanger and inner parts painted black, „15” Low natural anodized aluminium grille, transverse, rigid, „L1” peripheral ledge „L” with an overlap, natur anodized aluminium „L” water connection at the left side (when installing the heat exchanger closer to the window, fans to the room), „5” 24 V DC fans without controller (controller is not needed)

FRT 0080 0250

TRENCH HEATER WITH FAN



- Flats, detached houses, offices, administrative buildings
- Small universal trench heater
- High heating output
- Continuous speed control
- Quiet operation
- Common electricity consumption **2 W/m**
- Using in dry environment

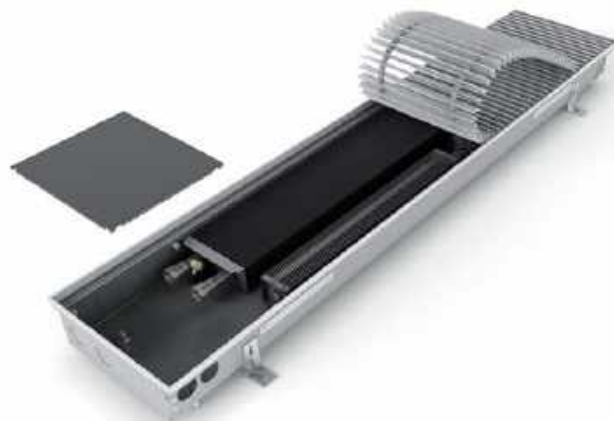

Technical data

Trench heater

Height [H]	80 mm
Width [W]	250 mm
Length [L]	700-4800 mm in step 100 mm

Heat exchanger

Type	Al-Cu lamellar
Length	L-295 mm
Connection thread	2xG1/2" inner

Working conditions

Max. temperature	110 °C
Max. overpressure	1 MPa (10 bar)
Protection	IP 20
Ambient conditions	Temp. T = +2 to +40 °C Humidity Rh = 20 to 70%

Trench heater standard equipment

Trough	Galvanized steel trough with surface finish and black spray layer inside, black cover plates of connection
Heat exchanger	Al-Cu lamellar exchanger with air vent valve, black painted
Grille	Design walkable grille according to the customer's choice
Ledge	Made of anodized aluminium, type and colour according to the customer's choice
Fan	Modern tangential fan with 24 V DC EC motor with high efficiency
Assembly elements	Leveling screws for setting up the trough, mounting brackets
Manual	Manual for the progress of work during installation and user manual
Wiring	Electrical wiring diagram of the trench heaters
Mounting board	Cover and the spacer particle board for easy installation
Package	Transport package for protection against damage during transportation and handling

Technical drawing

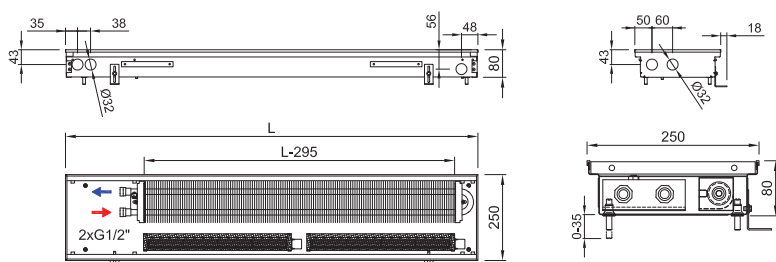

Connection to heating system

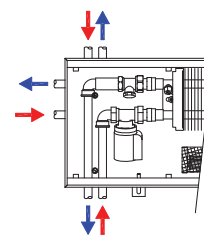

Electrothermal actuator can't be installed in the body of the trench heater due to limited internal space

Accessories per order



Variants

Grilles

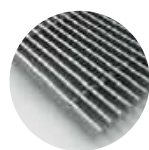

Transverse roll-up

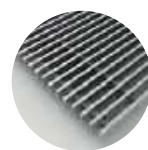

Linear non-rolling

Peripheral ledge



- ① Grilles → 6 ② Ledges → 8 ③ Acoustic power → 13 ④ Accessories → 14 ⑤ Hydraulic parameters → 126 ⑥ Wiring → 129

Code example: FRT 0080 0250 0900 C 12 J1 L - 5

Trench heater FRT H= 80 mm, W= 250 mm, L=900 mm, „C“ Galvanized steel trough with black inside, heat exchanger and inner parts painted black, „12“ natur anodized aluminium grille, linear, rigid „J1“ peripheral ledge „J“, natur anodized aluminium, „L“ water connection at the left side (when installing the heat exchanger closer to the window, fans to the room), „5“ 24 V DC fans without controller (controller is not needed)

FRT 0080 0300

TRENCH HEATER WITH FAN



- Flats, detached houses, offices, administrative buildings
- Low trench heater with a good heating output
- High heating output
- Continuous speed control
- Quiet operation
- Common electricity consumption **2 W/m**
- Using in dry environment



Technical data

Trench heater

Height [H]	80 mm
Width [W]	300 mm
Length [L]	700-4800 mm in step 100 mm

Heat exchanger

Type	Al-Cu lamellar
Length	L-295 mm
Connection thread	2xG1/2" inner

Working conditions

Max. temperature	110 °C
Max. overpressure	1 MPa (10 bar)
Protection	IP 20
Ambient conditions	Temp. T = +2 to +40 °C Humidity Rh = 20 to 70%

Trench heater standard equipment

Trough	Galvanized steel trough with surface finish and black spray layer inside, black cover plates of connection
Heat exchanger	Al-Cu lamellar exchanger with air vent valve, black painted
Grille	Design walkable grille according the customer's choice (stainless grilles surcharge)
Ledge	Made of anodized aluminium, type and colour according the customer's choice
Fan	Modern tangential fan with 24 V DC EC motor with high efficiency, rotors protection
Assembly elements	Leveling screws for setting up the trough, mounting brackets
Manual	Manual for the progress of work during installation and user manual
Wiring	Electrical wiring diagram of the trench heaters
Mounting board	Cover and the spacer particle board for easy installation
Package	Transport package for protection against damage during transportation and handling

Technical drawing

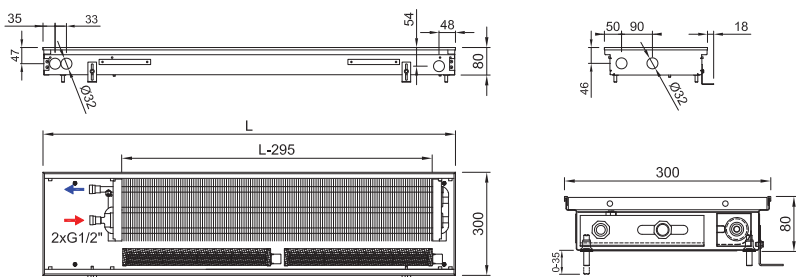

Connection to heating system

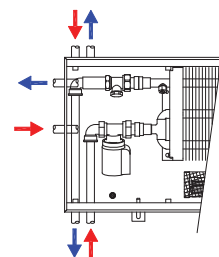

Accessories per order



Variants

Grilles

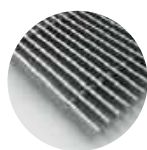

Transverse roll-up

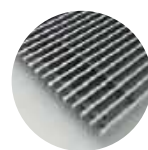

Linear non-rolling

Peripheral ledge



- ⓘ Grilles → 6
 Ⓜ Ledges → 8
 Ⓜ Acoustic power → 13
 ⊕ Accessories → 14
 Ⓜ Hydraulic parameters → 126
 Ⓜ Wiring → 129

Code example: FRT 0080 0300 2200 C 21 J2 R - 5

Trench heater FRT H = 80 mm, W = 300 mm, L = 2 200 mm, „C“ Galvanized steel trough with black inside, heat exchanger and inner parts painted black, „21“ bronze anodized aluminium grille, transverse, roll-up „J2“ peripheral ledge „J“, bronze anodized aluminium, „R“ water connection at the right side (when installing the heat exchanger closer to the window, fans to the room), „5“ 24 V DC fans without controller (controller is not needed)

FRT 0090 0175

TRENCH HEATER WITH FAN



- Flats, detached houses, offices, administrative buildings
- Small narrow trench heater
- High heating output
- Continuous speed control
- Quiet operation
- Common electricity consumption **2 W/m**
- Using in dry environment



Technical data

Trench heater

Height [H]	90 mm
Width [W]	175 mm
Length [L]	700-4800 mm in step 100 mm

Heat exchanger

Type	Al-Cu lamellar
Length	L-295 mm
Connection thread	2×G1/2" inner

Working conditions

Max. temperature	110 °C
Max. overpressure	1 MPa (10 bar)
Protection	IP 20
Ambient conditions	Temp. T = +2 to +40 °C Humidity Rh = 20 to 70%

Trench heater standard equipment

Trough	Galvanized steel trough with surface finish and black spray layer inside, black cover plates of connection
Heat exchanger	Al-Cu lamellar exchanger with air vent valve, black painted
Grille	Design walkable grille according the customer's choice (stainless grilles surcharge)
Ledge	Made of anodized aluminium, type and colour according the customer's choice
Fan	Modern tangential fan with 24 V DC EC motor with high efficiency, rotors protection
Assembly elements	Leveling screws for setting up the trough, mounting brackets
Manual	Manual for the progress of work during installation and user manual
Wiring	Electrical wiring diagram of the trench heaters
Mounting board	Cover and the spacer particle board for easy installation
Package	Transport package for protection against damage during transportation and handling

Technical drawing

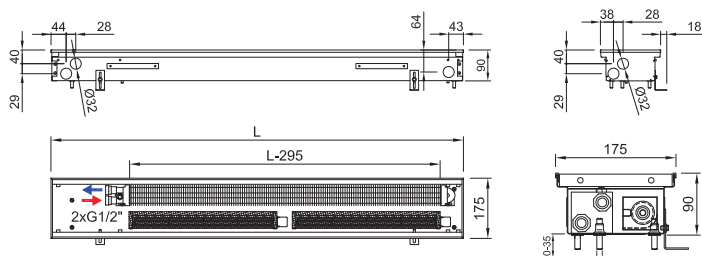

Connection to heating system

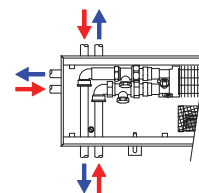

Electrothermal actuator can't be installed in the body of the trench heater due to limited internal space

Accessories per order



Room thermostat



Power supply



Lockshield valve

Variants

Grilles

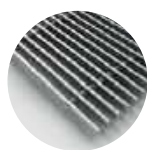

Transverse roll-up

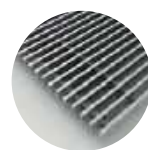

Linear non-rolling

Peripheral ledge



- ① Grilles → 6
② Ledges → 8
③ Acoustic power → 13
④ Accessories → 14
⑤ Hydraulic parameters → 126
⑥ Wiring → 129

Code example: FRT 0090 0175 1400 C 63 L1 L - 5

Trench heater **FRT** H=90 mm, W= 175 mm, L=1 400 mm, „C“ Galvanized steel trough with black inside, heat exchanger and inner parts painted black, „63“ natural oak grille, transverse, roll-up „L1“ peripheral ledge „L“ with an overlap, natur anodized aluminium „L“ water connection at the left side (when installing the heat exchanger closer to the window, fans to the room) „5“ 24 V DC fans without controller (controller is not needed)

FRT 0090 0200

TRENCH HEATER WITH FAN



- Flats, detached houses, offices, administrative buildings
- Small universal trench heater
- High heating output
- Continuous speed control
- Quiet operation
- Common electricity consumption **3 W/m**
- Using in dry environment



Technical data

Trench heater

Height [H]	90 mm
Width [W]	200 mm
Length [L]	700-4800 mm in step 100 mm

Heat exchanger

Type	Al-Cu lamellar
Length	L-295 mm
Connection thread	2×G1/2" inner

Working conditions

Max. temperature	110 °C
Max. overpressure	1 MPa (10 bar)
Protection	IP 20
Ambient conditions	Temp. T = +2 to +40 °C Humidity Rh = 20 to 70%

Trench heater standard equipment

Trough	Galvanized steel trough with surface finish and black spray layer inside, black cover plates of connection
Heat exchanger	Al-Cu lamellar exchanger with air vent valve, black painted
Grille	Design walkable grille according the customer's choice (stainless grilles surcharge)
Ledge	Made of anodized aluminium, type and colour according the customer's choice
Fan	Modern tangential fan with 24 V DC EC motor with high efficiency, rotors protection
Assembly elements	Leveling screws for setting up the trough, mounting brackets
Manual	Manual for the progress of work during installation and user manual
Wiring	Electrical wiring diagram of the trench heaters
Mounting board	Cover and the spacer particle board for easy installation
Package	Transport package for protection against damage during transportation and handling

Technical drawing

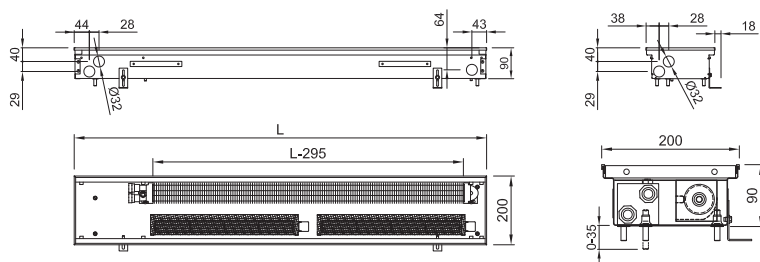

Connection to heating system

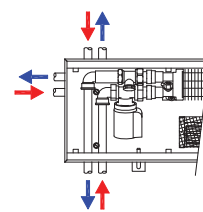

Accessories per order



Variants

Grilles

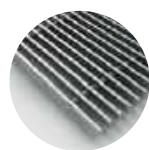

Transverse roll-up

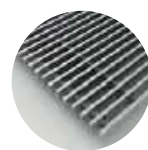

Linear non-rolling

Peripheral ledge



- ① Grilles → 6
② Ledges → 8
③ Acoustic power → 13
④ Accessories → 14
⑤ Hydraulic parameters → 126
⑥ Wiring → 129

Code example: FRT 0090 0200 1900 C 52 J1 R - 5

Trench heater **FRT** H=90 mm, W= 200 mm, L=1 900 mm, „C“ Galvanized steel trough with black inside, heat exchanger and inner parts painted black, „52“ stainless grille, transverse, roll-up, „J1“ peripheral ledge „J“, natur anodized aluminium, „R“ water connection at the right side (when installing the heat exchanger closer to the window, fans to the room), „5“ 24 V DC fans without controller (controller is not needed)

FRT 0090 0250

TRENCH HEATER WITH FAN



- Flats, detached houses, offices, administrative buildings
- Small universal trench heater
- High heating output
- Continuous speed control
- Quiet operation
- Common electricity consumption **3 W/m**
- Using in dry environment



Technical data

Trench heater

Height [H]	90 mm
Width [W]	250 mm
Length [L]	700-4800 mm in step 100 mm

Heat exchanger

Type	Al-Cu lamellar
Length	L-295 mm
Connection thread	2×G1/2" inner

Working conditions

Max. temperature	110 °C
Max. overpressure	1 MPa (10 bar)
Protection	IP 20
Ambient conditions	Temp. T = +2 to +40 °C Humidity Rh = 20 to 70%

Trench heater standard equipment

Trough	Galvanized steel trough with surface finish and black spray layer inside, black cover plates of connection
Heat exchanger	Al-Cu lamellar exchanger with air vent valve, black painted
Grille	Design walkable grille according the customer's choice (stainless grilles surcharge)
Ledge	Made of anodized aluminium, type and colour according the customer's choice
Fan	Modern tangential fan with 24 V DC EC motor with high efficiency, rotors protection
Assembly elements	Leveling screws for setting up the trough, mounting brackets
Manual	Manual for the progress of work during installation and user manual
Wiring	Electrical wiring diagram of the trench heaters
Mounting board	Cover and the spacer particle board for easy installation
Package	Transport package for protection against damage during transportation and handling

Technical drawing

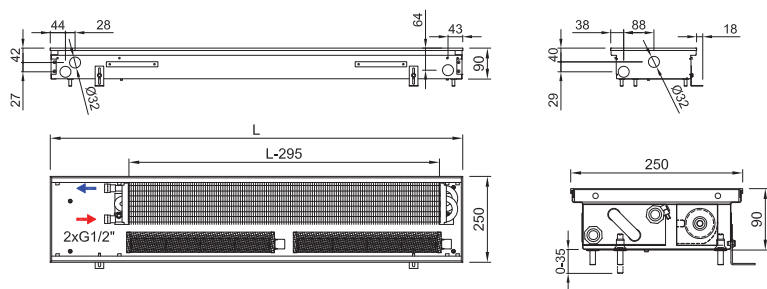

Connection to heating system

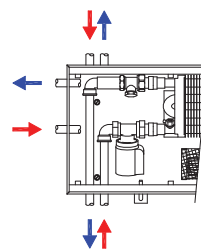

Accessories per order



Variants

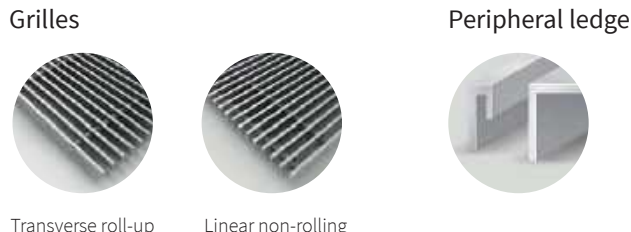

① Grilles → 6 ② Ledges → 8 ③ Acoustic power → 13 ④ Accessories → 14 ⑤ Hydraulic parameters → 126 ⑥ Wiring → 129

Code example: FRT 0090 0250 1500 C 62 L2 L - 5

Trench heater **FRT** H=90 mm, W= 250 mm, L=1 500 mm, „C“ Galvanized steel trough with black inside, heat exchanger and inner parts painted black, „62“ stained beech grille, transverse, roll-up „L2“ peripheral ledge „L“ with an overlap, bronze anodized aluminium, „L“ water connection at the left side (when installing the heat exchanger closer to the window, fans to the room) „5“ 24 V DC fans without controller (controller is not needed)

FRT 0090 0300

TRENCH HEATER WITH FAN



- Flats, detached houses, offices, administrative buildings
- Low trench heater with a good heating output
- High heating output
- Continuous speed control
- Quiet operation
- Common electricity consumption **3 W/m**
- Using in dry environment

Technical data

Trench heater

Height [H]	90 mm
Width [W]	300 mm
Length [L]	700-4800 mm in step 100 mm

Heat exchanger

Type	Al-Cu lamellar
Length	L-295 mm
Connection thread	2xG1/2" inner

Working conditions

Max. temperature	110 °C
Max. overpressure	1 MPa (10 bar)
Protection	IP 20
Ambient conditions	Temp. T = +2 to +40 °C Humidity Rh = 20 to 70%

Trench heater standard equipment

Trough	Galvanized steel trough with surface finish and black spray layer inside, black cover plates of connection
Heat exchanger	Al-Cu lamellar exchanger with air vent valve, black painted
Grille	Design walkable grille according the customer's choice (stainless grilles surcharge)
Ledge	Made of anodized aluminium, type and colour according the customer's choice
Fan	Modern tangential fan with 24 V DC EC motor with high efficiency, rotors protection
Assembly elements	Leveling screws for setting up the trough, mounting brackets
Manual	Manual for the progress of work during installation and user manual
Wiring	Electrical wiring diagram of the trench heaters
Mounting board	Cover and the spacer particle board for easy installation
Package	Transport package for protection against damage during transportation and handling

Technical drawing

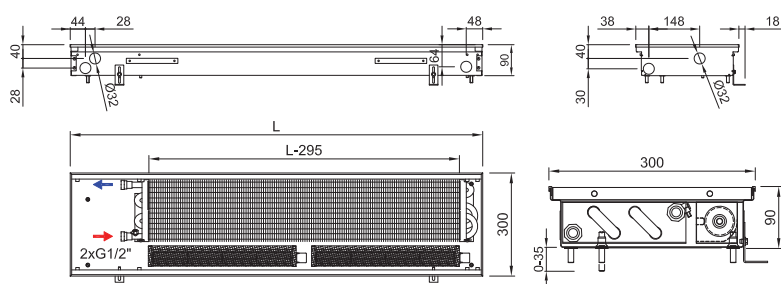

Connection to heating system

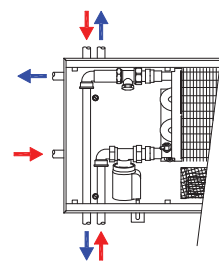

Accessories per order



Variants

Grilles

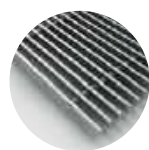

Transverse roll-up

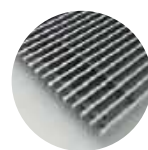

Linear non-rolling

Peripheral ledge



① Grilles → 6 ② Ledges → 8 ③ Acoustic power → 13 ④ Accessories → 14 ⑤ Hydraulic parameters → 126 ⑥ Wiring → 129

Code example: FRT 0090 0300 2700 C 32 J3 R - 5

Trench heater **FRT** H=90 mm, W= 300 mm, L=2 700 mm, „C“ Galvanized steel trough with black inside, heat exchanger and inner parts painted black, „32“ black anodized aluminium grille, linear, rigid, „J3“ peripheral ledge „J“, black anodized aluminium „R“ water connection at the right side (when installing the heat exchanger closer to the window, fans to the room), „5“ 24 V DC fans without controller (controller is not needed)

FRT 0090 0425

TRENCH HEATER WITH FAN



- Flats, detached houses, offices, administrative buildings
- High heating output
- Continuous speed control
- Quiet operation
- Common electricity consumption **3 W/m**
- Using in dry environment



Technical data

Trench heater

Height [H]	90 mm
Width [W]	425 mm
Length [L]	700-4800 mm in step 100 mm

Heat exchanger

Type	Al-Cu lamellar
Length	L-295 mm
Connection thread	2xG1/2" inner

Working conditions

Max. temperature	110 °C
Max. overpressure	1 MPa (10 bar)
Protection	IP 20
Ambient conditions	Temp. T = +2 to +40 °C Humidity Rh = 20 to 70%

Trench heater standard equipment

Trough	Galvanized steel trough with surface finish and black spray layer inside, black cover plates of connection
Heat exchanger	Al-Cu lamellar exchanger with air vent valve, black painted
Grille	Design walkable grille according the customer's choice (stainless grilles surcharge)
Ledge	Made of anodized aluminium, type and colour according the customer's choice
Fan	Modern tangential fan with 24 V DC EC motor with high efficiency, rotors protection
Assembly elements	Leveling screws for setting up the trough, mounting brackets
Manual	Manual for the progress of work during installation and user manual
Wiring	Electrical wiring diagram of the trench heaters
Mounting board	Cover and the spacer particle board for easy installation
Package	Transport package for protection against damage during transportation and handling

Technical drawing

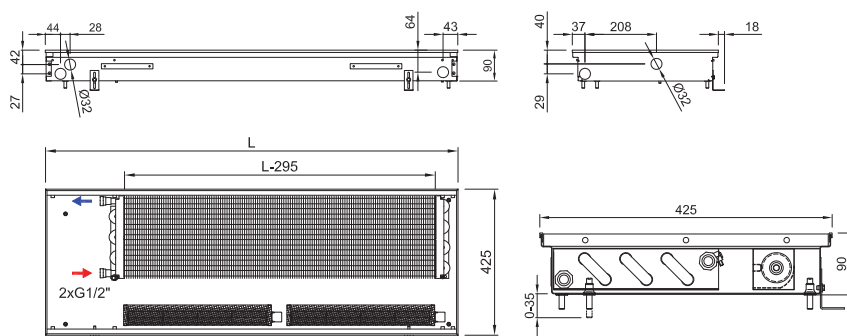

Connection to heating system

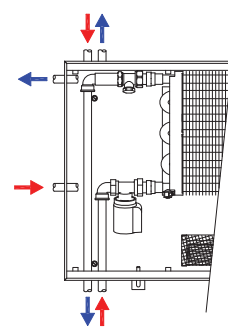

Accessories per order



Variants

Grilles

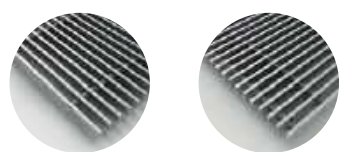

Transverse roll-up

Linear non-rolling

Peripheral ledge



① Grilles → 6 ② Ledges → 8 ③ Acoustic power → 13 ④ Accessories → 14 ⑤ Hydraulic parameters → 126 ⑥ Wiring → 129

Code example: FRT 0090 0425 4400 C 64 L2 L - 5

Trench heater FRT H=90 mm, W= 425 mm, L=4 400 mm, „C“ Galvanized steel trough with black inside, heat exchanger and inner parts painted black, „64“ stained oak grille, transverse, roll-up, „L2“ peripheral ledge, „L“ with an overlap, bronze anodized aluminium, „L“ water connection at the left side (when installing the heat exchanger closer to the window, fans to the room), „5“ 24 V DC fans without controller (controller is not needed)

FRT 0110 0175

TRENCH HEATER WITH FAN



- Flats, detached houses, offices, administrative buildings
- Narrow trench heater suitable for a standard floor
- High heating output
- Continuous speed control
- Quiet operation
- Common electricity consumption **2 W/m**
- Using in dry environment



Technical data

Trench heater

Height [H]	110 mm
Width [W]	175 mm
Length [L]	700-4800 mm in step 100 mm

Heat exchanger

Type	Al-Cu lamellar
Length	L-295 mm
Connection thread	2xG1/2" inner

Working conditions

Max. temperature	110 °C
Max. overpressure	1 MPa (10 bar)
Protection	IP 20
Ambient conditions	Temp. T = +2 to +40 °C Humidity Rh = 20 to 70%

Trench heater standard equipment

Trough	Galvanized steel trough with surface finish and black spray layer inside, black cover plates of connection
Heat exchanger	Al-Cu lamellar exchanger with air vent valve, black painted
Grille	Design walkable grille according the customer's choice (stainless grilles surcharge)
Ledge	Made of anodized aluminium, type and colour according the customer's choice
Fan	Modern tangential fan with 24 V DC EC motor with high efficiency, rotors protection
Assembly elements	Leveling screws for setting up the trough, mounting brackets
Manual	Manual for the progress of work during installation and user manual
Wiring	Electrical wiring diagram of the trench heaters
Mounting board	Cover and the spacer particle board for easy installation
Package	Transport package for protection against damage during transportation and handling

Technical drawing

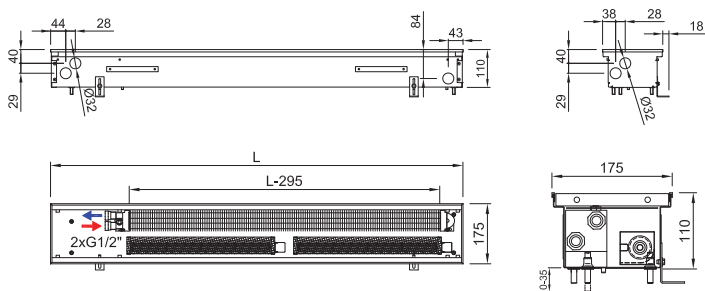

Connection to heating system

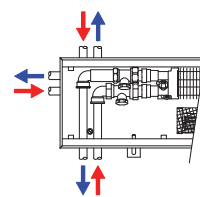

Electrothermal actuator can't be installed in the body of the trench heater due to limited internal space

Accessories per order



Room thermostat



Power supply



Lockshield valve

Variants

Grilles

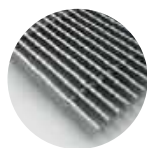

Transverse roll-up

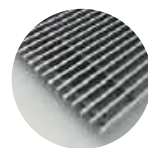

Linear non-rolling

Peripheral ledge



- ① Grilles → 6 ② Ledges → 8 ③ Acoustic power → 13 ④ Accessories → 14 ⑤ Hydraulic parameters → 126 ⑥ Wiring → 129

Code example: FRT 0110 0175 1400 C 63 L1 L - 5

Trench heater FRT H=110 mm, W=175 mm, L=1400 mm, „C“ Galvanized steel trough with black inside, heat exchanger and inner parts painted black, „63“ natural oak grille, transverse, roll-up, „L1“ peripheral ledge „L“ with an overlap, natur anodized aluminium, „L“ water connection at the left side (when installing the heat exchanger closer to the window, fans to the room), „5“ 24 V DC fans without controller (controller is not needed)

FRT 0110 0200

TRENCH HEATER WITH FAN



- Flats, detached houses, offices, administrative buildings
- Narrow trench heater suitable for a standard floor
- High heating output
- Continuous speed control
- Quiet operation
- Common electricity consumption **3 W/m**
- Using in dry environment



Technical data

Trench heater

Height [H]	110 mm
Width [W]	200 mm
Length [L]	700-4800 mm in step 100 mm

Heat exchanger

Type	Al-Cu lamellar
Length	L-295 mm
Connection thread	2×G1/2" inner

Working conditions

Max. temperature	110 °C
Max. overpressure	1 MPa (10 bar)
Protection	IP 20
Ambient conditions	Temp. T = +2 to +40 °C Humidity Rh = 20 to 70%

Trench heater standard equipment

Trough	Galvanized steel trough with surface finish and black spray layer inside, black cover plates of connection
Heat exchanger	Al-Cu lamellar exchanger with air vent valve, black painted
Grille	Design walkable grille according the customer's choice (stainless grilles surcharge)
Ledge	Made of anodized aluminium, type and colour according the customer's choice
Fan	Modern tangential fan with 24 V DC EC motor with high efficiency, rotors protection
Assembly elements	Leveling screws for setting up the trough, mounting brackets
Manual	Manual for the progress of work during installation and user manual
Wiring	Electrical wiring diagram of the trench heaters
Mounting board	Cover and the spacer particle board for easy installation
Package	Transport package for protection against damage during transportation and handling

Technical drawing

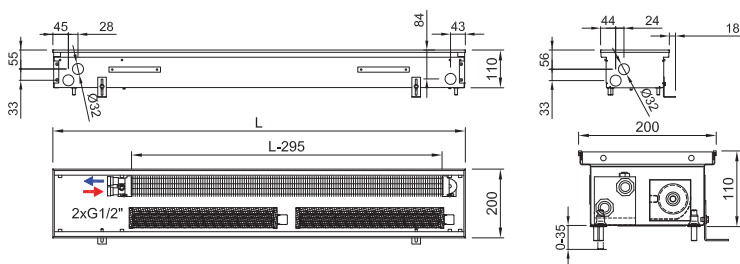

Connection to heating system

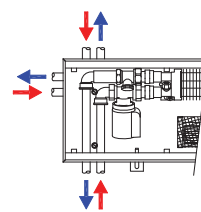

Accessories per order



Variants

Grilles

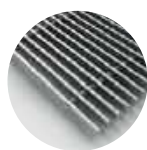

Transverse roll-up

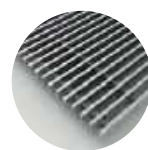

Linear non-rolling

Peripheral ledge



- ① Grilles → 6
② Ledges → 8
③ Acoustic power → 13
④ Accessories → 14
⑤ Hydraulic parameters → 126
⑥ Wiring → 129

Code example: FRT 0110 0200 1900 C 52 J1 R - 5

Trench heater **FRT** H = 110 mm, W = 200 mm, L = 1 900 mm, „C“ Galvanized steel trough with black inside, heat exchanger and inner parts painted black, „52“ stainless grille, transverse, roll-up, „J1“ peripheral ledge „J“, natur anodized aluminium, „R“ water connection at the right side (when installing the heat exchanger closer to the window, fans to the room), „5“ 24 V DC fans without controller (controller is not needed)

FRT 0110 0250

TRENCH HEATER WITH FAN



- Flats, detached houses, offices, administrative buildings
- Narrow trench heater suitable for a standard floor
- High heating output
- Continuous speed control
- Quiet operation
- Common electricity consumption **3 W/m**
- Using in dry environment



Technical data

Trench heater

Height [H]	110 mm
Width [W]	250 mm
Length [L]	700-4800 mm in step 100 mm

Heat exchanger

Type	Al-Cu lamellar
Length	L-295 mm
Connection thread	2×G1/2" inner

Working conditions

Max. temperature	110 °C
Max. overpressure	1 MPa (10 bar)
Protection	IP 20
Ambient conditions	Temp. T = +2 to +40 °C Humidity Rh = 20 to 70%

Trench heater standard equipment

Trough	Galvanized steel trough with surface finish and black spray layer inside, black cover plates of connection
Heat exchanger	Al-Cu lamellar exchanger with air vent valve, black painted
Grille	Design walkable grille according the customer's choice (stainless grilles surcharge)
Ledge	Made of anodized aluminium, type and colour according the customer's choice
Fan	Modern tangential fan with 24 V DC EC motor with high efficiency, rotors protection
Assembly elements	Leveling screws for setting up the trough, mounting brackets
Manual	Manual for the progress of work during installation and user manual
Wiring	Electrical wiring diagram of the trench heaters
Mounting board	Cover and the spacer particle board for easy installation
Package	Transport package for protection against damage during transportation and handling

Technical drawing

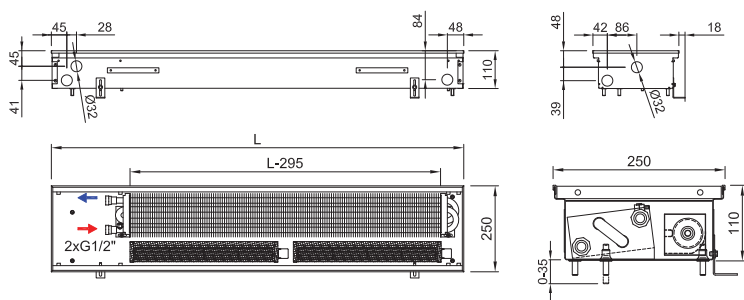

Connection to heating system

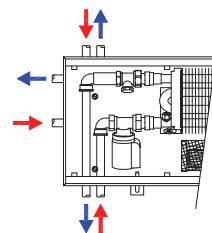

Accessories per order



Variants

Grilles

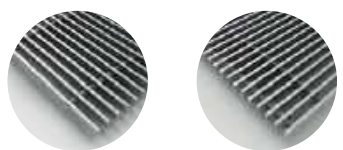

Transverse roll-up

Linear non-rolling

Peripheral ledge



- ① Grilles → 6
- ② Ledges → 8
- ③ Acoustic power → 13
- ④ Accessories → 14
- ⑤ Hydraulic parameters → 126
- ⑥ Wiring → 129

Code example: FRT 0110 0250 1500 C 62 L2 L - 5

Trench heater FRT H = 110 mm, W = 250 mm, L = 1 500 mm, „C“ Galvanized steel trough with black inside, heat exchanger and inner parts painted black, „62“ stained beech grille, transverse, roll-up, „L2“ peripheral ledge „L“ with an overlap, bronze anodized aluminium, „L“ water connection at the left side (when installing the heat exchanger closer to the window, fans to the room) „5“ 24 V DC fans without controller (controller is not needed)

FRT 0110 0300

TRENCH HEATER WITH FAN



- Flats, detached houses, offices, administrative buildings
- Universal trench heater suitable for a standard floor
- High heating output
- Continuous speed control
- Quiet operation
- Common electricity consumption **3 W/m**
- Using in dry environment

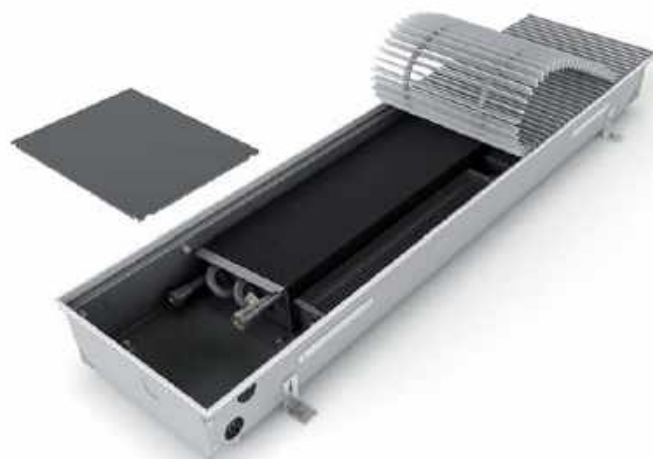

Technical data

Trench heater

Height [H]	110 mm
Width [W]	300 mm
Length [L]	700-4800 mm in step 100 mm

Heat exchanger

Type	Al-Cu lamellar
Length	L-295 mm
Connection thread	2xG1/2" inner

Working conditions

Max. temperature	110 °C
Max. overpressure	1 MPa (10 bar)
Protection	IP 20
Ambient conditions	Temp. T = +2 to +40 °C Humidity Rh = 20 to 70%

Trench heater standard equipment

Trough	Galvanized steel trough with surface finish and black spray layer inside, black cover plates of connection
Heat exchanger	Al-Cu lamellar exchanger with air vent valve, black painted
Grille	Design walkable grille according to the customer's choice (stainless grilles surcharge)
Ledge	Made of anodized aluminium, type and colour according to the customer's choice
Fan	Modern tangential fan with 24 V DC motor with high efficiency, rotors protection
Assembly elements	Leveling screws for setting up the trough, mounting brackets
Manual	Manual for the progress of work during installation and user manual
Wiring	Electrical wiring diagram of the trench heaters
Mounting board	Cover and the spacer particle board for easy installation
Package	Transport package for protection against damage during transportation and handling

Technical drawing

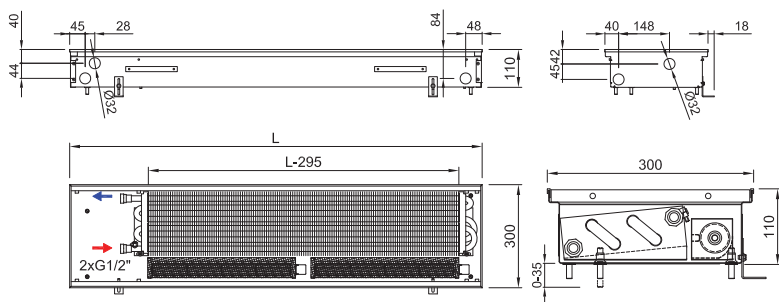

Connection to heating system

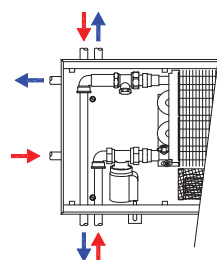

Accessories per order



Variants

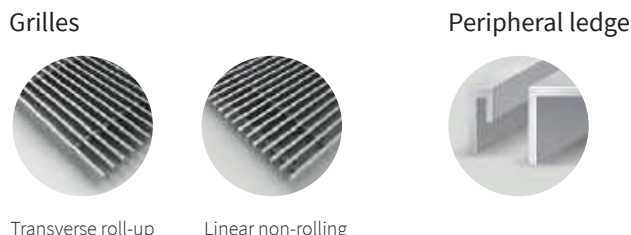

① Grilles → 6 ② Ledges → 8 ③ Acoustic power → 13 ④ Accessories → 14 ⑤ Hydraulic parameters → 126 ⑥ Wiring → 129

Code example: FRT 0110 0300 2700 C 32 J3 R - 5

Trench heater **FRT** H = **110** mm, W = **300** mm, L = **2 700** mm, „**C**“ Galvanized steel trough with black inside, heat exchanger and inner parts painted black, „**32**“ black anodized aluminium grille, linear, rigid, „**J3**“ peripheral ledge „**J**“, black anodized aluminium „**R**“ water connection at the right side (when installing the heat exchanger closer to the window, fans to the room), „**5**“ 24 V DC fans without controller (controller is not needed)

FRT 0110 0425

TRENCH HEATER WITH FAN



- Flats, detached houses, offices, administrative buildings
- Suitable for low-temperature systems
- High heating output
- Continuous speed control
- Quiet operation
- Common electricity consumption **3 W/m**
- Using in dry environment



Technical data

Trench heater

Height [H]	110 mm
Width [W]	425 mm
Length [L]	700-4800 mm in step 100 mm

Heat exchanger

Type	Al-Cu lamellar
Length	L-295 mm
Connection thread	2xG1/2" inner

Working conditions

Max. temperature	110 °C
Max. overpressure	1 MPa (10 bar)
Protection	IP 20
Ambient conditions	Temp. T = +2 to +40 °C Humidity Rh = 20 to 70%

Trench heater standard equipment

Trough	Galvanized steel trough with surface finish and black spray layer inside, black cover plates of connection
Heat exchanger	Al-Cu lamellar exchanger with air vent valve, black painted
Grille	Design walkable grille according the customer's choice (stainless grilles surcharge)
Ledge	Made of anodized aluminium, type and colour according the customer's choice
Fan	Modern tangential fan with 24 V DC EC motor with high efficiency, rotors protection
Assembly elements	Leveling screws for setting up the trough, mounting brackets
Manual	Manual for the progress of work during installation and user manual
Wiring	Electrical wiring diagram of the trench heaters
Mounting board	Cover and the spacer particle board for easy installation
Package	Transport package for protection against damage during transportation and handling

Technical drawing

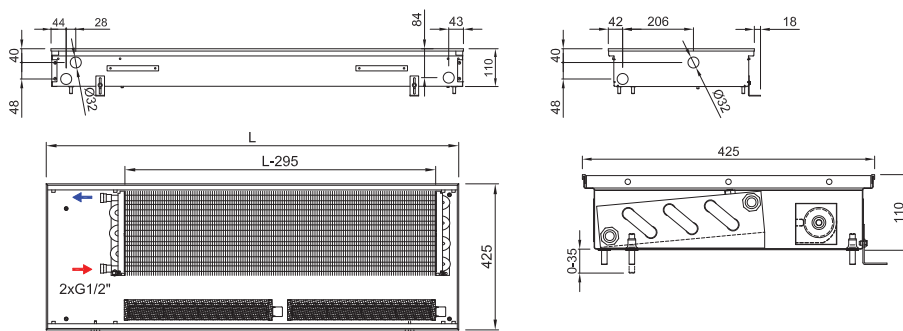

Connection to heating system

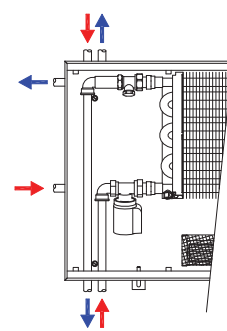

Accessories per order



Variants

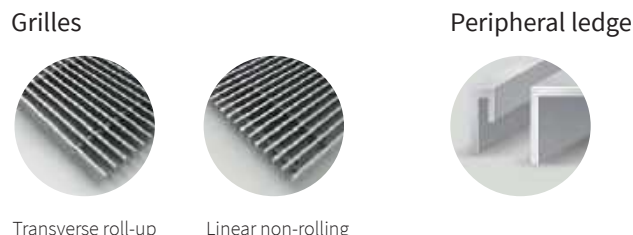

- ① Grilles → 6
 ② Ledges → 8
 ③ Acoustic power → 13
 ④ Accessories → 14
 ⑤ Hydraulic parameters → 126
 ⑥ Wiring → 129

Code example: FRT 0110 0425 4400 C 64 L2 L - 5

Trench heater FRT H = 110 mm, W = 425 mm, L = 4 400 mm, „C“ Galvanized steel trough with black inside, heat exchanger and inner parts painted black, „64“ stained oak grille, transverse, roll-up, „L2“ peripheral ledge, „L“ with an overlap, bronze anodized aluminium, „L“ water connection at the left side (when installing the heat exchanger closer to the window, fans to the room), „5“ 24 V DC fans without controller (controller is not needed)

FRT 0125 0250

TRENCH HEATER WITH FAN



- Flats, detached houses, offices, administrative buildings
- Good balance of heating output and size
- High heating output
- Continuous speed control
- Quiet operation
- Common electricity consumption **3 W/m**
- Using in dry environment



Technical data

Trench heater

Height [H]	125 mm
Width [W]	250 mm
Length [L]	700-4800 mm in step 100 mm

Heat exchanger

Type	Al-Cu lamellar
Length	L-295 mm
Connection thread	2×G1/2" inner

Working conditions

Max. temperature	110 °C
Max. overpressure	1 MPa (10 bar)
Protection	IP 20
Ambient conditions	Temp. T = +2 to +40 °C Humidity Rh = 20 to 70%

Trench heater standard equipment

Trough	Galvanized steel trough with surface finish and black spray layer inside, black cover plates of connection
Heat exchanger	Al-Cu lamellar exchanger with air vent valve, black painted
Grille	Design walkable grille according the customer's choice (stainless grilles surcharge)
Ledge	Made of anodized aluminium, type and colour according the customer's choice
Fan	Modern tangential fan with 24 V DC EC motor with high efficiency, rotors protection
Assembly elements	Leveling screws for setting up the trough, mounting brackets
Manual	Manual for the progress of work during installation and user manual
Wiring	Electrical wiring diagram of the trench heaters
Mounting board	Cover and the spacer particle board for easy installation
Package	Transport package for protection against damage during transportation and handling

Technical drawing

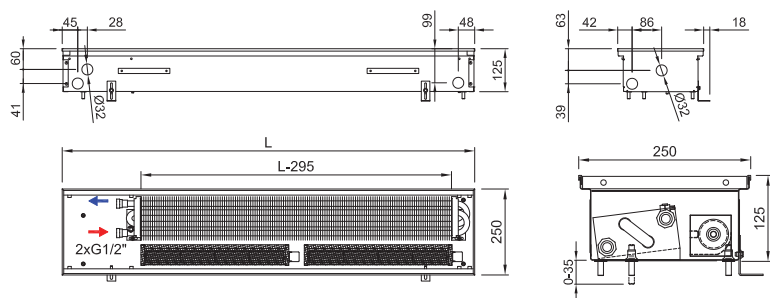

Connection to heating system

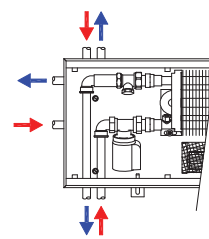

Accessories per order



Variants

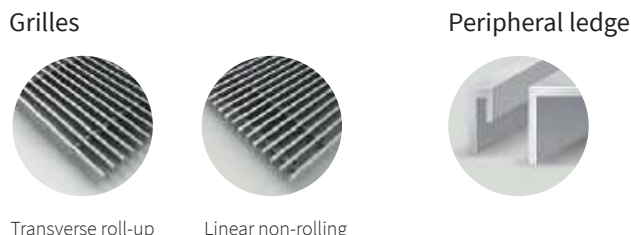

① Grilles → 6 ② Ledges → 8 ③ Acoustic power → 13 ④ Accessories → 14 ⑤ Hydraulic parameters → 126 ⑥ Wiring → 129

Code example: FRT 0125 0250 1500 C 62 L2 L - 5

Trench heater **FRT** H = 125 mm, W = 250 mm, L = 1 500 mm, „C“ Galvanized steel trough with black inside, heat exchanger and inner parts painted black, „62“ stained beech grille, transverse, roll-up, „L2“ peripheral ledge, „L“ with an overlap, bronze anodized aluminium, „L“ water connection at the left side (when installing the heat exchanger closer to the window, fans to the room) „5“ 24 V DC fans without controller (controller is not needed)

FRT 0125 0300

TRENCH HEATER WITH FAN

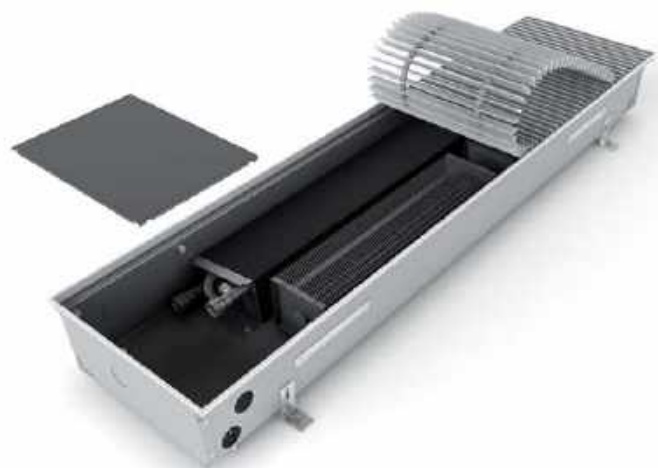

- Flats, detached houses, offices, administrative buildings
- Suitable for low-temperature systems
- High heating output
- Continuous speed control
- Quiet operation
- Common electricity consumption **2 W/m**
- Using in dry environment

Technical data

Trench heater

Height [H]	125 mm
Width [W]	300 mm
Length [L]	700-4800 mm in step 100 mm

Heat exchanger

Type	Al-Cu lamellar
Length	L-295 mm
Connection thread	2×G1/2" inner

Working conditions

Max. temperature	110 °C
Max. overpressure	1 MPa (10 bar)
Protection	IP 20
Ambient conditions	Temp. T = +2 to +40 °C Humidity Rh = 20 to 70%

Trench heater standard equipment

Trough	Galvanized steel trough with surface finish and black spray layer inside, black cover plates of connection
Heat exchanger	Al-Cu lamellar exchanger with air vent valve, black painted
Grille	Design walkable grille according the customer's choice (stainless grilles surcharge)
Ledge	Made of anodized aluminium, type and colour according the customer's choice
Fan	Modern tangential fan with 24 V DC EC motor with high efficiency, rotors protection
Assembly elements	Leveling screws for setting up the trough, mounting brackets
Manual	Manual for the progress of work during installation and user manual
Wiring	Electrical wiring diagram of the trench heaters
Mounting board	Cover and the spacer particle board for easy installation
Package	Transport package for protection against damage during transportation and handling

Technical drawing

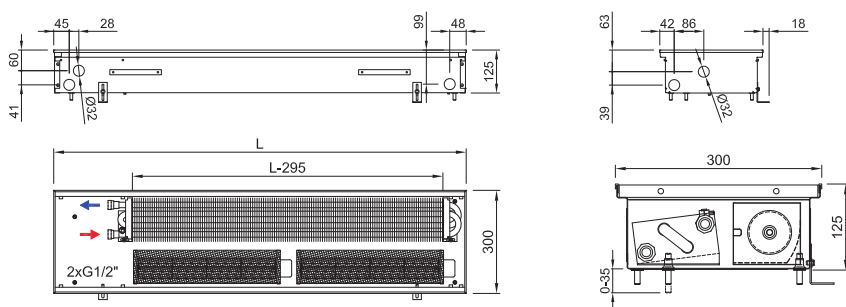

Connection to heating system

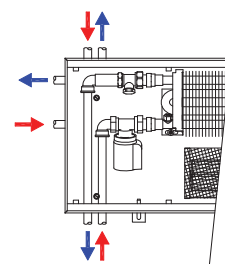

Accessories per order



Variants

Grilles

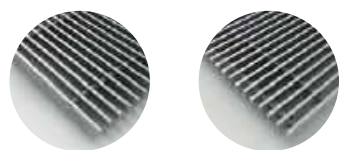

Transverse roll-up

Linear non-rolling

Peripheral ledge



① Grilles → 6 ② Ledges → 8 ③ Acoustic power → 13 ④ Accessories → 14 ⑤ Hydraulic parameters → 126 ⑥ Wiring → 129

Code example: FRT 0125 0300 2700 C 32 J3 R - 5

Trench heater **FRT** H = 125 mm, W = 300 mm, L = 2 700 mm, „**C**“ Galvanized steel trough with black inside, heat exchanger and inner parts painted black, „**32**“ black anodized aluminium grille, linear, rigid, „**J3**“ peripheral ledge „**J**“, black anodized aluminium „**R**“ water connection at the right side (when installing the heat exchanger closer to the window, fans to the room), „**5**“ 24 V DC fans without controller (controller is not needed)

FRT 0125 0425

TRENCH HEATER WITH FAN



- Flats, detached houses, offices, administrative buildings
- Suitable for low-temperature systems
- High heating output
- Continuous speed control
- Quiet operation
- Common electricity consumption **2 W/m**
- Using in dry environment



Technical data

Trench heater

Height [H]	125 mm
Width [W]	425 mm
Length [L]	700-4800 mm in step 100 mm

Heat exchanger

Type	Al-Cu lamellar
Length	L-295 mm
Connection thread	2xG1/2" inner

Working conditions

Max. temperature	110 °C
Max. overpressure	1 MPa (10 bar)
Protection	IP 20
Ambient conditions	Temp. T = +2 to +40 °C Humidity Rh = 20 to 70%

Trench heater standard equipment

Trough	Galvanized steel trough with surface finish and black spray layer inside, black cover plates of connection
Heat exchanger	Al-Cu lamellar exchanger with air vent valve, black painted
Grille	Design walkable grille according the customer's choice (stainless grilles surcharge)
Ledge	Made of anodized aluminium, type and colour according the customer's choice
Fan	Modern tangential fan with 24 V DC EC motor with high efficiency, rotors protection
Assembly elements	Leveling screws for setting up the trough, mounting brackets
Manual	Manual for the progress of work during installation and user manual
Wiring	Electrical wiring diagram of the trench heaters
Mounting board	Cover and the spacer particle board for easy installation
Package	Transport package for protection against damage during transportation and handling

Technical drawing

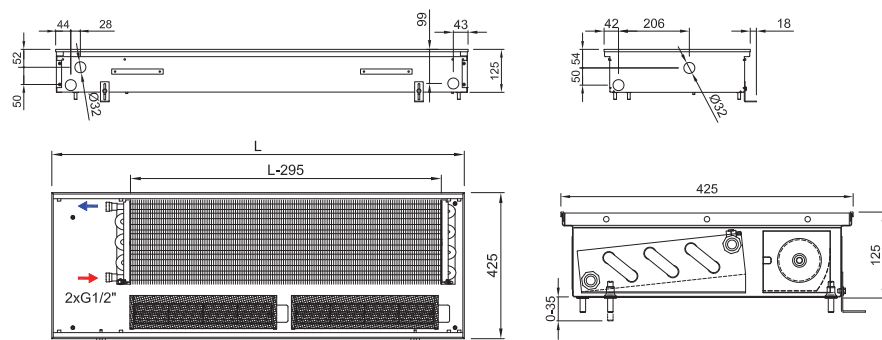

Connection to heating system

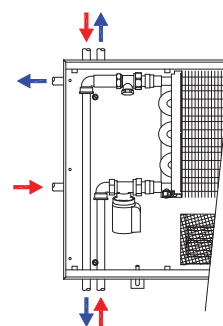

Accessories per order



Variants

Grilles

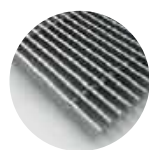

Transverse roll-up

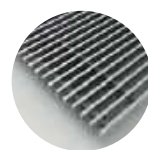

Linear non-rolling

Peripheral ledge



- ① Grilles → 6
 ② Ledges → 8
 ③ Acoustic power → 13
 ④ Accessories → 14
 ⑤ Hydraulic parameters → 126
 ⑥ Wiring → 129

Code example: FRT 0125 0425 4400 C 64 L2 L - 5

Trench heater FRT H=125 mm, W=425 mm, L=4400 mm, „C“ Galvanized steel trough with black inside, heat exchanger and inner parts painted black, „64“ stained oak grille, transverse, roll-up, „L2“ peripheral ledge, „L“ with an overlap, bronze anodized aluminium, „L“ water connection at the left side (when installing the heat exchanger closer to the window, fans to the room), „5“ 24 V DC fans without controller (controller is not needed)

FRT 0140 0250

TRENCH HEATER WITH FAN



- Flats, detached houses, offices, administrative buildings
- Narrow trench heater suitable for deeper floor
- High heating output
- Continuous speed control
- Quiet operation
- Common electricity consumption **3 W/m**
- Using in dry environment



Technical data

Trench heater

Height [H]	140 mm
Width [W]	250 mm
Length [L]	700-4800 mm in step 100 mm

Heat exchanger

Type	Al-Cu lamellar
Length	L-295 mm
Connection thread	2xG1/2" inner

Working conditions

Max. temperature	110 °C
Max. overpressure	1 MPa (10 bar)
Protection	IP 20
Ambient conditions	Temp. T = +2 to +40 °C Humidity Rh = 20 to 70%

Trench heater standard equipment

Trough	Galvanized steel trough with surface finish and black spray layer inside, black cover plates of connection
Heat exchanger	Al-Cu lamellar exchanger with air vent valve, black painted
Grille	Design walkable grille according the customer's choice (stainless grilles surcharge)
Ledge	Made of anodized aluminium, type and colour according the customer's choice
Fan	Modern tangential fan with 24 V DC EC motor with high efficiency, rotors protection
Assembly elements	Leveling screws for setting up the trough, mounting brackets
Manual	Manual for the progress of work during installation and user manual
Wiring	Electrical wiring diagram of the trench heaters
Mounting board	Cover and the spacer particle board for easy installation
Package	Transport package for protection against damage during transportation and handling

Technical drawing

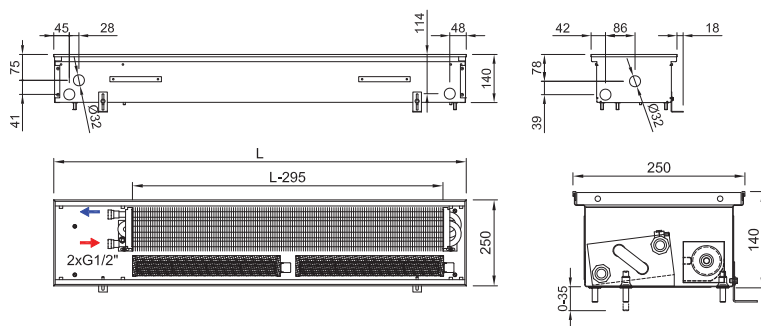

Connection to heating system

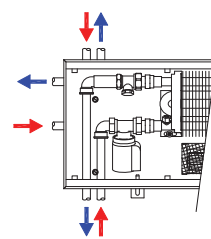

Accessories per order



Variants

Grilles

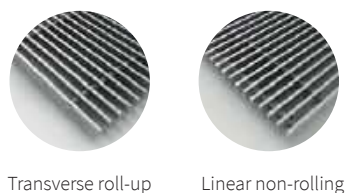

Peripheral ledge



① Grilles → 6 ② Ledges → 8 ③ Acoustic power → 13 ④ Accessories → 14 ⑤ Hydraulic parameters → 126 ⑥ Wiring → 129

Code example: FRT 00140 0250 1500 C 62 L2 L - 5

Trench heater FRT H=140 mm, W=250 mm, L=1500 mm, „C“ Galvanized steel trough with black inside, heat exchanger and inner parts painted black, „62“ stained beech grille, transverse, roll-up, „L2“ peripheral ledge „L“ with an overlap, bronze anodized aluminium, „L“ water connection at the left side (when installing the heat exchanger closer to the window, fans to the room) „5“ 24 V DC fans without controller (controller is not needed)

FRT 0140 0300

TRENCH HEATER WITH FAN



- Flats, detached houses, offices, administrative buildings
- Suitable for low-temperature systems
- High heating output
- Continuous speed control
- Quiet operation
- Common electricity consumption **2 W/m**
- Using in dry environment

Technical data

Trench heater

Height [H]	140 mm
Width [W]	300 mm
Length [L]	700-4800 mm in step 100 mm

Heat exchanger

Type	Al-Cu lamellar
Length	L-295 mm
Connection thread	2xG1/2" inner

Working conditions

Max. temperature	110 °C
Max. overpressure	1 MPa (10 bar)
Protection	IP 20
Ambient conditions	Temp. T = +2 to +40 °C Humidity Rh = 20 to 70%

Trench heater standard equipment

Trough	Galvanized steel trough with surface finish and black spray layer inside, black cover plates of connection
Heat exchanger	Al-Cu lamellar exchanger with air vent valve, black painted
Grille	Design walkable grille according the customer's choice (stainless grilles surcharge)
Ledge	Made of anodized aluminium, type and colour according the customer's choice
Fan	Modern tangential fan with 24 V DC EC motor with high efficiency, rotors protection
Assembly elements	Leveling screws for setting up the trough, mounting brackets
Manual	Manual for the progress of work during installation and user manual
Wiring	Electrical wiring diagram of the trench heaters
Mounting board	Cover and the spacer particle board for easy installation
Package	Transport package for protection against damage during transportation and handling

Technical drawing

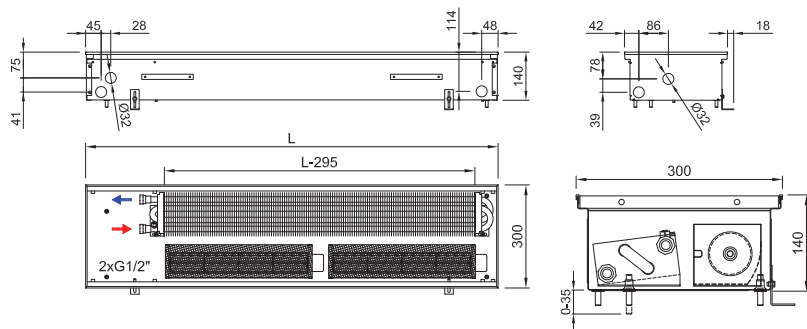

Connection to heating system

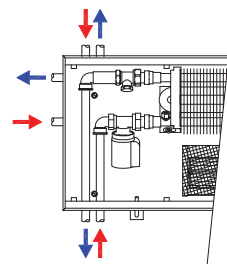

Accessories per order



Variants

Grilles

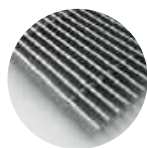

Transverse roll-up

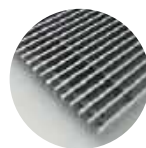

Linear non-rolling

Peripheral ledge



- ① Grilles → 6
 ② Ledges → 8
 ③ Acoustic power → 13
 ④ Accessories → 14
 ⑤ Hydraulic parameters → 126
 ⑥ Wiring → 129

Code example: FRT 0140 0300 2700 C 32 J3 R - 5

Trench heater **FRT** H = 140 mm, W = 300 mm, L = 2 700 mm, „C“ Galvanized steel trough with black inside, heat exchanger and inner parts painted black, „32“ black anodized aluminium grille, linear, rigid, „J3“ peripheral ledge „J“, black anodized aluminium „R“ water connection at the right side (when installing the heat exchanger closer to the window, fans to the room), „5“ 24 V DC fans without controller (controller is not needed)



Trench heater heating output FRT 0140 0300

Q[W] 75/65/20 °C (ΔT=50 °C)

Temperature exponent 1,1

Length L [mm]	Speed [-] / Heating output [W]				
	0	1	2	3	4 max.
700	127 W	446 W	706 W	930 W	1 201 W
800	159 W	597 W	944 W	1 244 W	1 605 W
900	190 W	747 W	1 182 W	1 557 W	2 009 W
1000	222 W	977 W	1 546 W	2 036 W	2 628 W
1100	253 W	977 W	1 546 W	2 036 W	2 628 W
1200	285 W	1 193 W	1 888 W	2 487 W	3 210 W
1300	316 W	1 344 W	2 126 W	2 800 W	3 615 W
1400	347 W	1 423 W	2 252 W	2 966 W	3 829 W
1500	379 W	1 574 W	2 490 W	3 280 W	4 233 W
1600	410 W	1 735 W	2 745 W	3 615 W	4 666 W
1700	442 W	1 735 W	2 745 W	3 615 W	4 666 W
1800	473 W	1 954 W	3 092 W	4 072 W	5 256 W
1900	505 W	2 181 W	3 451 W	4 545 W	5 867 W
2000	536 W	2 331 W	3 689 W	4 858 W	6 271 W
2100	568 W	2 482 W	3 927 W	5 171 W	6 675 W
2200	599 W	2 482 W	3 927 W	5 171 W	6 675 W
2300	630 W	2 712 W	4 291 W	5 651 W	7 294 W
2400	662 W	2 712 W	4 291 W	5 651 W	7 294 W
2500	693 W	2 928 W	4 633 W	6 102 W	7 876 W
2600	725 W	3 078 W	4 871 W	6 415 W	8 280 W
2700	756 W	3 229 W	5 109 W	6 728 W	8 685 W
2800	788 W	3 308 W	5 235 W	6 894 W	8 899 W
2900	819 W	3 469 W	5 489 W	7 229 W	9 331 W
3000	851 W	3 469 W	5 489 W	7 229 W	9 331 W
3200	913 W	3 916 W	6 196 W	8 160 W	10 532 W
3400	976 W	4 066 W	6 434 W	8 473 W	10 937 W
3600	1 039 W	4 446 W	7 035 W	9 265 W	11 959 W
3800	1 102 W	4 663 W	7 378 W	9 716 W	12 542 W
4000	1 165 W	4 963 W	7 854 W	10 343 W	13 350 W
4200	1 228 W	5 204 W	8 234 W	10 844 W	13 997 W
4400	1 291 W	5 423 W	8 581 W	11 301 W	14 587 W
4600	1 354 W	5 800 W	9 178 W	12 088 W	15 602 W
4800	1 417 W	5 951 W	9 416 W	12 401 W	16 007 W

75/65/20 °C → 75 °C inlet temperature, 65 °C outlet temp., 20 °C room temp. / Output 90/70/20 °C = ~ 1,22 x 75/65/20 °C / Output 70/55/20 °C = ~ 0,84 x 75/65/20 °C / Heating outputs in accordance with EN 16430 / Not listed heating outputs for lengths per 100 mm steps calculate linearly. Exact values can be found at www.isan.cz

Q[W] 55/45/20 °C (ΔT=30 °C)

Length L [mm]	Speed [-] / Heating output [W]				
	0	1	2	3	4 max.
700	61 W	254 W	403 W	530 W	685 W
800	77 W	340 W	538 W	709 W	915 W
900	92 W	426 W	674 W	888 W	1 145 W
1000	107 W	557 W	881 W	1 161 W	1 498 W
1100	122 W	557 W	881 W	1 161 W	1 498 W
1200	138 W	680 W	1 076 W	1 418 W	1 830 W
1300	153 W	766 W	1 212 W	1 596 W	2 061 W
1400	168 W	811 W	1 284 W	1 691 W	2 183 W
1500	183 W	897 W	1 420 W	1 870 W	2 413 W
1600	198 W	989 W	1 565 W	2 061 W	2 660 W
1700	214 W	989 W	1 565 W	2 061 W	2 660 W
1800	229 W	1 114 W	1 763 W	2 322 W	2 997 W
1900	244 W	1 243 W	1 967 W	2 591 W	3 345 W
2000	260 W	1 329 W	2 103 W	2 770 W	3 575 W
2100	275 W	1 415 W	2 239 W	2 948 W	3 806 W
2200	290 W	1 415 W	2 239 W	2 948 W	3 806 W
2300	305 W	1 546 W	2 446 W	3 222 W	4 158 W
2400	321 W	1 546 W	2 446 W	3 222 W	4 158 W
2500	336 W	1 669 W	2 641 W	3 479 W	4 490 W
2600	351 W	1 755 W	2 777 W	3 657 W	4 721 W
2700	366 W	1 841 W	2 913 W	3 836 W	4 951 W
2800	382 W	1 886 W	2 985 W	3 930 W	5 073 W
2900	397 W	1 978 W	3 129 W	4 121 W	5 320 W
3000	412 W	1 978 W	3 129 W	4 121 W	5 320 W
3200	442 W	2 233 W	3 532 W	4 652 W	6 005 W
3400	473 W	2 318 W	3 668 W	4 831 W	6 235 W
3600	503 W	2 535 W	4 011 W	5 282 W	6 818 W
3800	534 W	2 658 W	4 206 W	5 539 W	7 150 W
4000	564 W	2 830 W	4 478 W	5 897 W	7 611 W
4200	595 W	2 967 W	4 694 W	6 182 W	7 980 W
4400	625 W	3 092 W	4 892 W	6 443 W	8 316 W
4600	656 W	3 307 W	5 233 W	6 892 W	8 895 W
4800	686 W	3 393 W	5 368 W	7 070 W	9 126 W

Acoustic power [dB(A)]

Length L [mm]	Speed [-] / Acoustic power [dB(A)]				
	0	1	2	3	4 max.
700	-	25	34	46	57
800	-	25	35	46	57
900	-	26	35	47	58
1000	-	26	36	47	58
1100	-	27	36	47	58
1200	-	27	37	48	59
1300	-	28	37	48	59
1400	-	28	37	48	59
1500	-	29	38	48	60
1600	-	29	38	49	60
1700	-	29	38	49	60
1800	-	29	38	49	60
1900	-	30	39	49	61
2000	-	30	39	49	61
2100	-	30	39	50	61
2200	-	31	39	50	61
2300	-	31	40	50	61
2400	-	31	40	50	62
2500	-	31	40	50	62
2600	-	31	40	50	62
2700	-	32	40	51	62
2800	-	32	40	51	62
2900	-	32	41	51	62
3000	-	32	41	51	62
3200	-	32	41	51	63
3400	-	33	41	51	63
3600	-	33	41	52	63
3800	-	33	42	52	63
4000	-	34	42	52	64
4200	-	34	42	52	64
4400	-	34	42	52	64
4600	-	34	43	52	64
4800	-	35	43	53	64

Fans input power [W]*

Length L [mm]	Number of fans	Speed [-] / Fans input power [W]*			
		1	2	3	4 max.
700	1	1 W	1 W	3 W	8 W
800	1	1 W	1 W	4 W	10 W
900	1	1 W	2 W	6 W	15 W
1000	1	1 W	2 W	7 W	17 W
1100	2	1 W	2 W	7 W	17 W
1200	2	1 W	3 W	8 W	20 W
1300	2	2 W	3 W	10 W	24 W
1400	2	2 W	3 W	10 W	24 W
1500	1	2 W	3 W	11 W	27 W
1600	2	2 W	4 W	12 W	29 W
1700	2	2 W	4 W	13 W	32 W
1800	2	2 W	4 W	14 W	34 W
1900	2	2 W	5 W	15 W	36 W
2000	2	2 W	5 W	16 W	39 W
2100	2	3 W	6 W	18 W	44 W
2200	2	3 W	6 W	18 W	44 W
2300	2	3 W	6 W	19 W	46 W
2400	3	3 W	6 W	19 W	46 W
2500	3	3 W	6 W	20 W	48 W
2600	3	3 W	7 W	22 W	53 W
2700	3	4 W	7 W	24 W	58 W
2800	2	4 W	7 W	23 W	56 W
2900	3	4 W	7 W	24 W	58 W
3000	3	4 W	8 W	24 W	60 W
3200	3	4 W	8 W	26 W	65 W
3400	3	4 W	9 W	28 W	68 W
3600	4	5 W	9 W	30 W	75 W
3800	4	5 W	10 W	33 W	80 W
4000	3	5 W	11 W	35 W	87 W
4200	4	5 W	11 W	35 W	87 W
4400	4	6 W	12 W	37 W	92 W
4600	4	6 W	12 W	39 W	96 W
4800	4	6 W	13 W	41 W	101 W

* Approximate fan input powers / When using electrothermal actuator add in the trench heater's power 3 W

FRT 0140 0425

TRENCH HEATER WITH FAN



- Flats, detached houses, offices, administrative buildings
- Suitable for low-temperature systems
- High heating output
- Continuous speed control
- Quiet operation
- Common electricity consumption **2 W/m**
- Using in dry environment



Technical data

Trench heater

Height [H]	140 mm
Width [W]	425 mm
Length [L]	700-4800 mm in step 100 mm

Heat exchanger

Type	Al-Cu lamellar
Length	L-295 mm
Connection thread	2xG1/2" inner

Working conditions

Max. temperature	110 °C
Max. overpressure	1 MPa (10 bar)
Protection	IP 20
Ambient conditions	Temp. T = +2 to +40 °C Humidity Rh = 20 to 70%

Trench heater standard equipment

Trough	Galvanized steel trough with surface finish and black spray layer inside, black cover plates of connection
Heat exchanger	Al-Cu lamellar exchanger with air vent valve, black painted
Grille	Design walkable grille according the customer's choice (stainless grilles surcharge)
Ledge	Made of anodized aluminium, type and colour according the customer's choice
Fan	Modern tangential fan with 24 V DC EC motor with high efficiency, rotors protection
Assembly elements	Leveling screws for setting up the trough, mounting brackets
Manual	Manual for the progress of work during installation and user manual
Wiring	Electrical wiring diagram of the trench heaters
Mounting board	Cover and the spacer particle board for easy installation
Package	Transport package for protection against damage during transportation and handling

Technical drawing

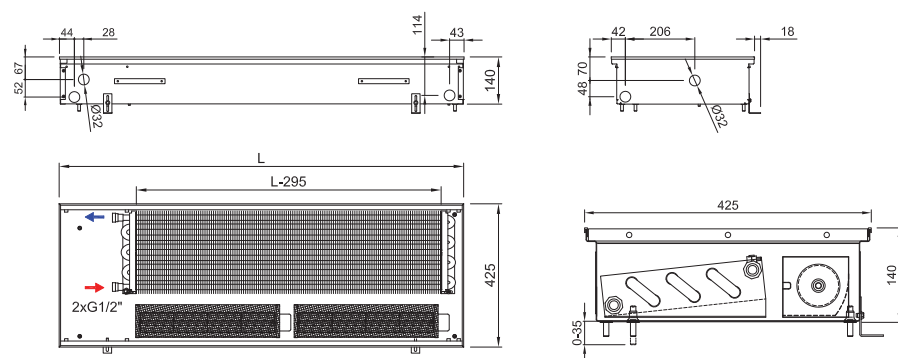

Connection to heating system

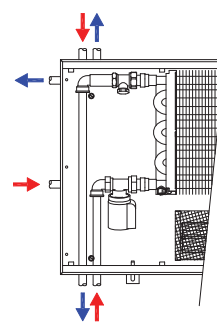

Accessories per order



Variants

Grilles

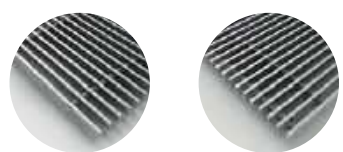

Transverse roll-up

Linear non-rolling

Peripheral ledge



① Grilles → 6 ② Ledges → 8 ③ Acoustic power → 13 ④ Accessories → 14 ⑤ Hydraulic parameters → 126 ⑥ Wiring → 129

Code example: FRT 0140 0425 4400 C 64 L2 L - 5

Trench heater FRT H=140 mm, W=425 mm, L=4400 mm, „C“ Galvanized steel trough with black inside, heat exchanger and inner parts painted black, „64“ stained oak grille, transverse, roll-up, „L2“ peripheral ledge, „L“ with an overlap, bronze anodized aluminium, „L“ water connection at the left side (when installing the heat exchanger closer to the window, fans to the room), „5“ 24 V DC fans without controller (controller is not needed)



Trench heater heating output FRT 0140 0425

Q[W] 75/65/20 °C (ΔT=50 °C)

Temperature exponent 1,1

Length L [mm]	Speed [-] / Heating output [W]				
	0	1	2	3	4 max.
700	216 W	757 W	1 046 W	1 373 W	1 726 W
800	269 W	1 012 W	1 399 W	1 835 W	2 307 W
900	323 W	1 267 W	1 751 W	2 297 W	2 888 W
1000	376 W	1 657 W	2 290 W	3 004 W	3 777 W
1100	429 W	1 657 W	2 290 W	3 004 W	3 777 W
1200	483 W	2 024 W	2 797 W	3 670 W	4 614 W
1300	536 W	2 279 W	3 150 W	4 132 W	5 195 W
1400	589 W	2 414 W	3 336 W	4 377 W	5 503 W
1500	643 W	2 669 W	3 689 W	4 839 W	6 084 W
1600	696 W	2 942 W	4 066 W	5 333 W	6 706 W
1700	749 W	2 942 W	4 066 W	5 333 W	6 706 W
1800	803 W	3 314 W	4 580 W	6 008 W	7 554 W
1900	856 W	3 699 W	5 112 W	6 706 W	8 432 W
2000	909 W	3 954 W	5 464 W	7 168 W	9 013 W
2100	963 W	4 209 W	5 817 W	7 630 W	9 594 W
2200	1 016 W	4 209 W	5 817 W	7 630 W	9 594 W
2300	1 069 W	4 599 W	6 356 W	8 338 W	10 483 W
2400	1 123 W	4 599 W	6 356 W	8 338 W	10 483 W
2500	1 176 W	4 966 W	6 863 W	9 003 W	11 320 W
2600	1 229 W	5 221 W	7 215 W	9 465 W	11 901 W
2700	1 283 W	5 476 W	7 568 W	9 927 W	12 482 W
2800	1 336 W	5 611 W	7 754 W	10 172 W	12 790 W
2900	1 389 W	5 884 W	8 131 W	10 667 W	13 411 W
3000	1 443 W	5 884 W	8 131 W	10 667 W	13 411 W
3200	1 549 W	6 641 W	9 178 W	12 040 W	15 137 W
3400	1 656 W	6 896 W	9 530 W	12 502 W	15 718 W
3600	1 763 W	7 541 W	10 421 W	13 671 W	17 189 W
3800	1 870 W	7 908 W	10 929 W	14 337 W	18 025 W
4000	1 976 W	8 418 W	11 633 W	15 261 W	19 187 W
4200	2 083 W	8 826 W	12 197 W	16 000 W	20 117 W
4400	2 190 W	9 198 W	12 711 W	16 675 W	20 966 W
4600	2 296 W	9 838 W	13 596 W	17 835 W	22 424 W
4800	2 403 W	10 093 W	13 948 W	18 297 W	23 005 W

Q[W] 55/45/20 °C (ΔT=30 °C)

Length L [mm]	Speed [-] / Heating output [W]				
	0	1	2	3	4 max.
700	105 W	432 W	596 W	783 W	984 W
800	130 W	577 W	798 W	1 046 W	1 315 W
900	156 W	722 W	998 W	1 310 W	1 647 W
1000	182 W	945 W	1 306 W	1 713 W	2 153 W
1100	208 W	945 W	1 306 W	1 713 W	2 153 W
1200	234 W	1 154 W	1 595 W	2 092 W	2 631 W
1300	260 W	1 299 W	1 796 W	2 356 W	2 962 W
1400	285 W	1 376 W	1 902 W	2 495 W	3 137 W
1500	311 W	1 522 W	2 103 W	2 759 W	3 469 W
1600	337 W	1 677 W	2 318 W	3 040 W	3 823 W
1700	363 W	1 677 W	2 318 W	3 040 W	3 823 W
1800	389 W	1 889 W	2 611 W	3 425 W	4 307 W
1900	414 W	2 109 W	2 914 W	3 823 W	4 807 W
2000	440 W	2 254 W	3 115 W	4 087 W	5 138 W
2100	466 W	2 400 W	3 316 W	4 350 W	5 470 W
2200	492 W	2 400 W	3 316 W	4 350 W	5 470 W
2300	518 W	2 622 W	3 624 W	4 754 W	5 977 W
2400	544 W	2 622 W	3 624 W	4 754 W	5 977 W
2500	569 W	2 831 W	3 913 W	5 133 W	6 454 W
2600	595 W	2 977 W	4 113 W	5 396 W	6 785 W
2700	621 W	3 122 W	4 315 W	5 660 W	7 116 W
2800	647 W	3 199 W	4 421 W	5 799 W	7 292 W
2900	672 W	3 355 W	4 636 W	6 081 W	7 646 W
3000	699 W	3 355 W	4 636 W	6 081 W	7 646 W
3200	750 W	3 786 W	5 233 W	6 864 W	8 630 W
3400	802 W	3 932 W	5 433 W	7 128 W	8 961 W
3600	854 W	4 299 W	5 941 W	7 794 W	9 800 W
3800	905 W	4 509 W	6 231 W	8 174 W	10 276 W
4000	957 W	4 799 W	6 632 W	8 701 W	10 939 W
4200	1 008 W	5 032 W	6 954 W	9 122 W	11 469 W
4400	1 060 W	5 244 W	7 247 W	9 507 W	11 953 W
4600	1 112 W	5 609 W	7 751 W	10 168 W	12 784 W
4800	1 163 W	5 754 W	7 952 W	10 431 W	13 116 W

75/65/20 °C → 75 °C inlet temperature, 65 °C outlet temp., 20 °C room temp. / Output 90/70/20 °C ≈ 1,22 x 75/65/20 °C / Output 70/55/20 °C ≈ 0,84 x 75/65/20 °C / Heating outputs in accordance with EN 16430 / Not listed heating outputs for lengths per 100 mm steps calculate linearly. Exact values can be found at www.isan.cz



Acoustic power [dB(A)]

Length L [mm]	Speed [-] / Acoustic power [dB(A)]				
	0	1	2	3	4 max.
700	-	25	35	47	58
800	-	26	36	48	59
900	-	27	37	48	59
1000	-	27	37	48	60
1100	-	28	37	49	60
1200	-	28	38	49	61
1300	-	29	38	49	61
1400	-	29	39	50	61
1500	-	29	39	50	62
1600	-	30	39	50	62
1700	-	30	39	50	62
1800	-	30	40	51	62
1900	-	31	40	51	62
2000	-	31	40	51	63
2100	-	31	40	51	63
2200	-	31	41	51	63
2300	-	32	41	51	63
2400	-	32	41	52	63
2500	-	32	41	52	64
2600	-	32	41	52	64
2700	-	33	41	52	64
2800	-	33	42	52	64
2900	-	33	42	52	64
3000	-	33	42	52	64
3200	-	33	42	53	65
3400	-	34	42	53	65
3600	-	34	43	53	65
3800	-	34	43	53	65
4000	-	35	43	54	65
4200	-	35	43	54	66
4400	-	35	44	54	66
4600	-	35	44	54	66
4800	-	36	44	54	66



Fans input power [W]*

Length L [mm]	Number of fans	Speed [-] / Fans input power [W]*			
		1	2	3	4 max.
700	1	1 W	1 W	3 W	8 W
800	1	1 W	1 W	4 W	10 W
900	1	1 W	2 W	6 W	15 W
1000	1	1 W	2 W	7 W	17 W
1100	1	1 W	2 W	7 W	17 W
1200	2	1 W	3 W	8 W	20 W
1300	2	2 W	3 W	10 W	24 W
1400	2	2 W	3 W	10 W	24 W
1500	2	2 W	3 W	11 W	27 W
1600	1	2 W	4 W	12 W	29 W
1700	2	2 W	4 W	13 W	32 W
1800	2	2 W	4 W	14 W	34 W
1900	2	2 W	5 W	15 W	36 W
2000	2	2 W	5 W	16 W	39 W
2100	2	3 W	6 W	18 W	44 W
2200	2	3 W	6 W	18 W	44 W
2300	2	3 W	6 W	19 W	46 W
2400	2	3 W	6 W	19 W	46 W
2500	3	3 W	6 W	20 W	48 W
2600	3	3 W	7 W	22 W	53 W
2700	3	4 W	7 W	24 W	58 W
2800	3	4 W	7 W	23 W	56 W
2900	2	4 W	7 W	24 W	58 W
3000	3	4 W	8 W	24 W	60 W
3200	3	4 W	8 W	26 W	65 W
3400	3	4 W	9 W	28 W	68 W
3600	3	5 W	9 W	30 W	75 W
3800	4	5 W	10 W	33 W	80 W
4000	4	5 W	11 W	35 W	87 W
4200	3	5 W	11 W	35 W	87 W
4400	4	6 W	12 W	37 W	92 W
4600	4	6 W	12 W	39 W	96 W
4800	4	6 W	13 W	41 W	101 W

* Approximate fan input powers / When using electrothermal actuator add in the trench heater's power 3 W

FRC

FRD





Fan-assisted trench heaters
**with lamellar heat exchanger,
heating and cooling**

TERMO - FRC, FRD

Fan-assisted heaters for heating and cooling



Benefits

- High heating /cooling output
- Energy saving 24 V DC fans
- Continuous speed control 0 ... 10 V DC
- Condensate pump may be added



Trench heaters with forced convection via a fan provide a high heating/cooling output. They are a suitable addition to cooling and air-conditioning units, the effect of which does not reach up to the windows. The optimal control of the forced convection is provided by fans with continuous speed control and low energy consumption. Spaces with thermal losses in winter and high thermal gains in summer are effectively regulated from the floor, without disturbing the aesthetics of the room with large-area glazing. The heaters are fitted with an Al-Cu lamellar exchanger through which the heating/cooling medium flows. Tangential fans are placed in front of the exchanger along the whole length, ensuring uniform coverage of the heat exchanger and, subsequently, optimal distribution of temperature within the room. The FRC trench heater 135 × 325 is supplied for both 2-pipe and 4-pipe systems.

The fans are fitted with efficient electrically commuted (EC) motors functioning on the basis of a safe voltage of 24 V DC. The motors have a very low consumption of electric power. The fan speed is controlled continuously with a controlling voltage of 0 ... 10 V DC.

The room thermostat or a higher BMS secures the correct function of all installed FRC trench heaters, compares the set and actual temperature in the room, opens the flowing of the heating/cooling medium in the heat exchanger and controls the fan revolutions according to the difference in the temperatures and the set mode of operation.

The use of new technologies secures optimal heating of the interior, energy savings, high efficiency and flexibility of heating. The trench heater is powered with safe voltage only, all components are powered with 24 V DC.

Trench heaters may be installed with a pump for condensate which is generated in the cooling mode of operation at low temperature of the intake water and high air humidity. The pump is powered with 230 V AC.

FRC, 2 pipe, single-circuit

AVAILABLE MODELS

- FRC 100 x 175 mm
- FRC 135 x 325 mm

2 pipe trench heaters are connected to a single piping circuit. In this case, the heating system contains either a heating or cooling medium. Switching between the heating mode (connection to the source of heat) and the cooling mode (connection to the source of cooling) is usually performed in a technical room.

FRD, 4 pipe, double-circuit

AVAILABLE MODELS

- FRD 135 x 325 mm

4 pipe trench heaters are connected to two separate piping circuits. Both the heating and cooling media are available at the same time. The heater starts heating or cooling upon evaluation of the ambient conditions. Changes may occur at any time during the day.

Heaters with integrated power supply

In summer months, heating/cooling trench heaters are usually operated at full power. With a higher number of heaters installed in a single room, the capacity of a switching source placed in the switchboard may be soon used up. In such cases, it is beneficial to use heaters with their own sources and connect them in an unlimited number and regardless of the connection length. Such heaters are marked FZC and FZD; for details of this option see page 96.

FRC, FRD overview of heaters with fan, heating/cooling

2 PIPE

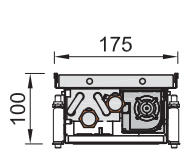

FRC 0100 0175
page 86

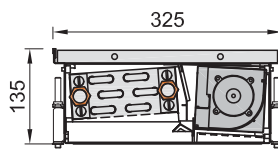

FRC 0135 0325
page 88

4 PIPE

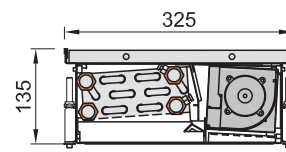

FRD 0135 0325
page 90

Placement in the floor

The trench heaters are laid in the floor so that the heat exchanger is closer to the window side, while fans are placed deeper into the room. The vertical and horizontal distribution of temperatures in the heated room is uniform and conditions are created to provide thermal comfort. Air flow is comparable to the heat transfer with classical heating bodies placed on the wall below windows. When cooling is on, the air is circulated in the space around the windows, creating a pleasant climate in places not reached by air-conditioning or ceiling cooling.

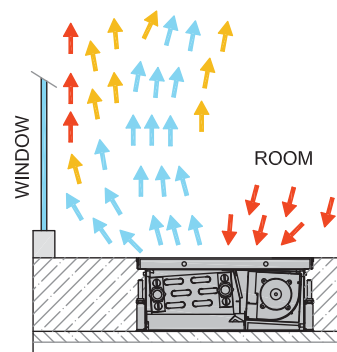
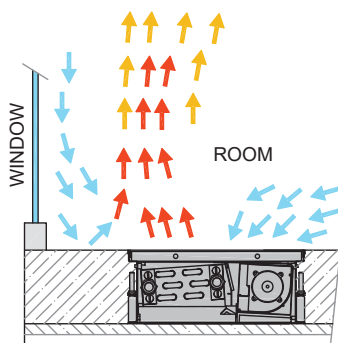

Heating

- Air becomes heated by flowing through the heat exchanger
- Warm air is mixed with cool air running down the window surfaces
- Air circulation:
 - Heating air in the room
 - Screening out window surfaces
 - Secondarily demisting window surfaces

Cooling

- Air becomes cooled by flowing through the heat exchanger
- Cool air is mixed with warm air rising along the window surfaces
- Air circulation:
 - Cooling down air around the window surfaces
 - Reducing radiation of the window surfaces
 - Condensate is formed with water of low temperature, which is removed from heater
 - Local cooling only; completes but does not replace a cooling or air-conditioning system not reaching the window surfaces

Condensate and condensate pump

During the heater operation in cooling mode in summer, air humidity condenses on the heater ledges. Droplets of water are formed and trickle down into a condensate tub located under the heater. The condensate is removed from the tub through a small tube which must be connected to a drainage hose or a condensate pump must be installed.



Intake air filter

Heaters with 135 × 325 mm dimensions may be fitted with a filter placed on the protective grille above the fan. It prevents larger pieces of dirt from passing into the heater space. The filter decreases the trench heater output at maximum revolutions by approximately 12%.



FRC 0100 0175

FAN-ASSISTED TRENCH HEATER FOR HEATING/COOLING, 2 PIPE



- Fully glazed rooms with big heat gains
- Flats, villas, residences, hotels
- High heat output
- Optimum after-cooling output
- Convection with tangential fans
- Dry environment
- Safety voltage 24 V



Technical data

Trench heater

Height [H]	100 mm
Width [W]	175 mm
Length [L]	800-2 800 mm in step 400 mm

Heat exchanger

Type	Al-Cu lamellar
Length	L-430 mm
Connection thread	2×G1/2" inner

Working conditions

Max. temperature	110 °C
Max. overpressure	1 MPa (10 bar)
Protection	IP 20
Ambient conditions	Temp. T = +2 to +40 °C Humidity Rh = 20 to 70%

Trench heater standard equipment

Trough	Galvanized steel trough with surface finish and black spray layer inside, black cover plates of connection, inner condensate trough from stainless steel
Heat exchanger	Al-Cu lamellar exchanger with air vent valve, black painted
Grille	Design walkable grille according the customer's choice*
Ledge	Made of anodized aluminium, type and colour according the customer's choice
Fan	Modern tangential fan with 24 V DC EC motor with high efficiency, rotors protection
Assembly elements	Leveling screws for setting up the trough, mounting brackets
Manual	Manual for the progress of work during installation and user manual
Wiring	Electrical wiring diagram of the trench heaters
Mounting board	Cover and the spacer particle board for easy installation
Package	Transport package for protection against damage during transportation and handling

Technical drawing

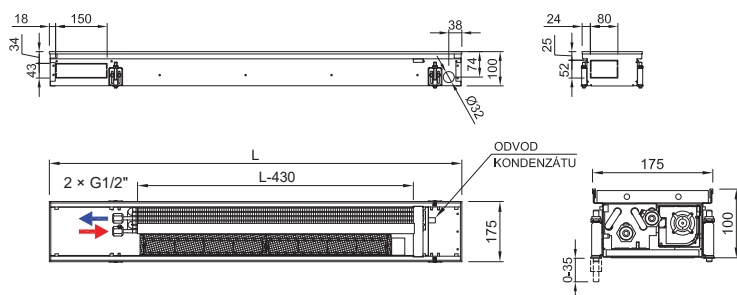

Connection to heating system

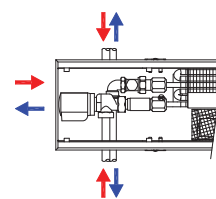

Warning: When a condensate pump is used, the trench heater is **200 mm longer**. If a pump is required, this should be stated in the order. **Lengths:** 1 000; 1 400; 1 800; 2 200; 2 600 and 3 000 mm.

Accessories per order



Variants

Grilles

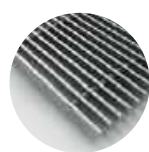

Transverse roll-up

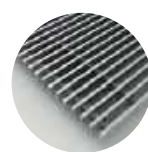

Linear non-rolling

Peripheral ledge



① Grilles → 6 ② Ledges → 8 ③ Acoustic power → 13 ④ Accessories → 14 ⑤ Hydraulic parameters → 126

Code example: FRC 0100 0175 1600 C 12 J1 L - 5

Trench heater **FRC** H = **100** mm, W = **175** mm, L = **1 600** mm, „C“ Galvanized steel trough with black inside, heat exchanger and inner parts painted black, „12“ natur anodized aluminium grille, linear, rigid, „J1“ peripheral ledge „J“, natur anodized aluminium, „L“ water connection at the left side (when installing the heat exchanger closer to the window, fans to the room), „5“ 24 V DC fans without controller (controller is not needed)



Trench heater heating output FRC 0100 0175, 2 pipe

Q[W] 75/65/20 °C (ΔT=50 °C)

Temperature exponent 1,0

Length L [mm]	Speed [-] / Heating output [W]						
	0	1	2	3	4	5	6 max
800	23 W	104 W	240 W	479 W	673 W	822 W	926 W
1200	45 W	235 W	545 W	1 087 W	1 526 W	1 863 W	2 104 W
1600	67 W	339 W	785 W	1 566 W	2 199 W	2 685 W	3 024 W
2000	89 W	471 W	1 089 W	2 173 W	3 052 W	3 727 W	4 197 W
2400	112 W	575 W	1 330 W	2 652 W	3 725 W	4 549 W	5 122 W
2800	134 W	706 W	1 634 W	3 260 W	4 578 W	5 590 W	6 295 W

Q[W] 55/45/20 °C (ΔT=30 °C)

Length L [mm]	Speed [-] / Heating output [W]						
	0	1	2	3	4	5	6 max
800	11 W	62 W	144 W	288 W	404 W	493 W	555 W
1200	22 W	141 W	327 W	652 W	916 W	1 118 W	1 262 W
1600	33 W	204 W	471 W	939 W	1 320 W	1 611 W	1 814 W
2000	43 W	283 W	654 W	1 304 W	1 831 W	2 236 W	2 518 W
2400	54 W	345 W	798 W	1 591 W	2 235 W	2 729 W	3 073 W
2800	65 W	424 W	980 W	1 956 W	2 747 W	3 354 W	3 777 W

75/65/20 °C → 75 °C inlet temperature, 65 °C outlet temp., 20 °C room temp. / Output 90/70/20 °C ≈ 1,22 x 75/65/20 °C / Output 70/55/20 °C ≈ 0,84 x 75/65/20 °C / Heating outputs in accordance with EN 16430



Trench heater cooling output FRC 0100 0175, 2 pipe

17/19/28 °C (ΔT=10 °C)

Temperature exponent 0,9

Length L [mm]	Speed [-] / Cooling output [W]						
	0	1	2	3	4	5	6 max
800	-	10 W	23 W	59 W	90 W	117 W	140 W
1200	-	22 W	51 W	130 W	199 W	259 W	310 W
1600	-	31 W	74 W	187 W	287 W	374 W	447 W
2000	-	43 W	103 W	260 W	399 W	519 W	620 W
2400	-	53 W	125 W	317 W	487 W	633 W	757 W
2800	-	65 W	154 W	390 W	598 W	778 W	931 W

Cooling outputs in accordance with EN 16430



Acoustic power [dB(A)]

Length L [mm]	Speed [-] / Acoustic power [dB(A)]						
	0	1	2	3	4	5	6 max
800	-	< 25	< 25	32	39	48	54
1200	-	< 25	26	34	41	50	56
1600	-	26	30	37	42	51	57
2000	-	27	31	38	43	52	58
2400	-	31	32	38	44	52	59
2800	-	31	33	39	44	53	59

More details on page → 13



Fans input power [W]*

Length L [mm]	Number of fans	Speed [-] / Fans input power [W]*					
		1	2	3	4	5	6 max
800	1	1 W	1 W	2 W	3 W	5 W	8 W
1200	1	1 W	1 W	2 W	5 W	9 W	15 W
1600	2	1 W	2 W	4 W	7 W	13 W	22 W
2000	2	1 W	2 W	4 W	10 W	17 W	29 W
2400	3	2 W	3 W	6 W	12 W	21 W	36 W
2800	3	2 W	3 W	6 W	14 W	25 W	44 W

* Approximate fan input powers / When using electrothermal actuator add in the trench heater's power 3 W

FRC 0135 0325

FAN-ASSISTED TRENCH HEATER FOR HEATING/COOLING, 2 PIPE



- Fully glazed rooms with big heat gains
- Flats, villas, residences, hotels
- High heat output
- Optimum after-cooling output
- Convection with tangential fans
- Dry environment
- Safety voltage 24 V



Technical data

Trench heater

Height [H]	135 mm
Width [W]	325 mm
Length [L]	800-2 800 mm in step 400 mm

Heat exchanger

Type	Al-Cu lamellar
Length	L-490 mm
Connection thread	2xG1/2" inner

Working conditions

Max. temperature	110 °C
Max. overpressure	1 MPa (10 bar)
Protection	IP 20
Ambient conditions	Temp. T = +2 to +40 °C Humidity Rh = 20 to 70%

Trench heater standard equipment

Trough	Galvanized steel trough with surface finish and black spray layer inside, black cover plates of connection, inner condensate trough from stainless steel
Heat exchanger	Al-Cu lamellar exchanger with air vent valve, black painted
Grille	Design walkable grille according the customer's choice*
Ledge	Made of anodized aluminium, type and colour according the customer's choice
Fan	Modern tangential fan with 24 V DC EC motor with high efficiency, rotors protection
Assembly elements	Leveling screws for setting up the trough, mounting brackets
Manual	Manual for the progress of work during installation and user manual
Wiring	Electrical wiring diagram of the trench heaters
Mounting board	Cover and the spacer particle board for easy installation
Package	Transport package for protection against damage during transportation and handling

Technical drawing

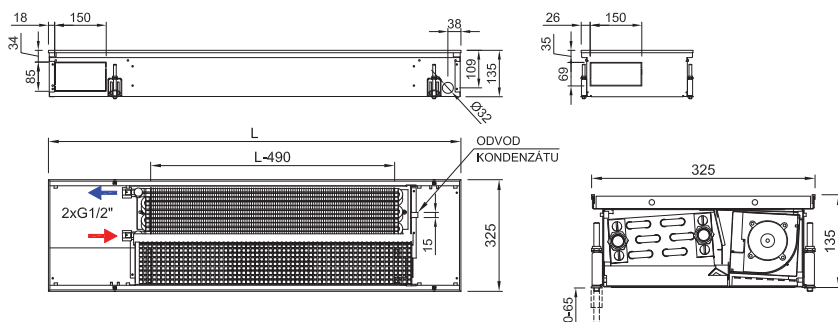

Connection to heating system

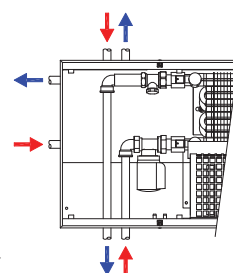

Accessories per order



Variants

Grilles

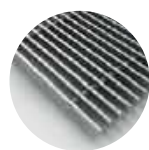

Transverse roll-up

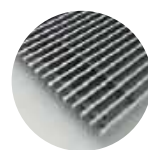

Linear non-rolling

Peripheral ledge



① Grilles → 6 ② Ledges → 8 ③ Acoustic power → 13 ④ Accessories → 14 ⑤ Hydraulic parameters → 126

Code example: FRC 0135 0325 2000 C 21 J2 L - 5

Trench heater FRC H = 135 mm, W = 325 mm, L = 2 000 mm, „C“ Galvanized steel trough with black inside, heat exchanger and inner parts painted black, „21“ bronze anodized aluminium grille, transverse, roll-up low, „J2“ peripheral ledge „J“, bronze anodized aluminium „L“ water connection at the left side (when installing the heat exchanger closer to the window, fans to the room), „5“ 24 V DC fans without controller (controller is not needed)



Trench heater heating output FRC 0135 0325, 2 pipe

Q[W] 75/65/20 °C (ΔT=50 °C)

Temperature exponent 1,1

Length L [mm]	Speed [-] / Heating output [W]						
	0	1	2	3	4	5	6 max
800	58 W	276 W	589 W	1 011 W	1 586 W	1 931 W	2 173 W
1200	132 W	611 W	1 305 W	2 239 W	3 513 W	4 277 W	4 814 W
1600	207 W	887 W	1 894 W	3 250 W	5 099 W	6 208 W	6 987 W
2000	281 W	1 223 W	2 610 W	4 479 W	7 026 W	8 554 W	9 628 W
2400	356 W	1 499 W	3 199 W	5 490 W	8 612 W	10 484 W	11 801 W
2800	430 W	1 834 W	3 915 W	6 718 W	10 539 W	12 830 W	14 442 W

Q[W] 55/45/20 °C (ΔT=30 °C)

Length L [mm]	Speed [-] / Heating output [W]						
	0	1	2	3	4	5	6 max
800	28 W	157 W	336 W	576 W	904 W	1 101 W	1 239 W
1200	64 W	349 W	744 W	1 277 W	2 003 W	2 438 W	2 745 W
1600	100 W	506 W	1 080 W	1 853 W	2 907 W	3 539 W	3 984 W
2000	136 W	697 W	1 488 W	2 553 W	4 006 W	4 877 W	5 489 W
2400	172 W	854 W	1 824 W	3 130 W	4 910 W	5 977 W	6 728 W
2800	208 W	1 046 W	2 232 W	3 830 W	6 008 W	7 315 W	8 234 W

75/65/20 °C → 75 °C inlet temperature, 65 °C outlet temp., 20 °C room temp. / Output 90/70/20 °C ≈ 1,22 x 75/65/20 °C / Output 70/55/20 °C ≈ 0,84 x 75/65/20 °C / Heating outputs in accordance with EN 16430



Trench heater cooling output FRC 0135 0325, 2 pipe

17/19/28 °C (ΔT=10 °C)

Temperature exponent 0,7

Length L [mm]	Speed [-] / Cooling output [W]						
	0	1	2	3	4	5	6 max
800	-	11 W	47 W	101 W	188 W	257 W	324 W
1200	-	24 W	104 W	223 W	417 W	569 W	718 W
1600	-	35 W	151 W	324 W	606 W	826 W	1 042 W
2000	-	48 W	208 W	446 W	834 W	1 138 W	1 436 W
2400	-	58 W	255 W	546 W	1 023 W	1 395 W	1 760 W
2800	-	71 W	312 W	669 W	1 251 W	1 707 W	2 154 W

Cooling outputs in accordance with EN 16430



Acoustic power [dB(A)]

Length L [mm]	Speed [-] / Acoustic power [dB(A)]						
	0	1	2	3	4	5	6 max
800	-	< 25	26	37	53	61	67
1200	-	< 25	29	39	55	63	69
1600	-	25	30	40	56	64	70
2000	-	26	32	42	57	64	71
2400	-	29	34	42	57	65	71
2800	-	34	39	45	58	66	72

More details on page → 13



Fans input power [W]*

Length L [mm]	Number of fans	Speed [-] / Fans input power [W]*					
		1	2	3	4	5	6 max
800	1	1 W	1 W	2 W	5 W	11 W	21 W
1200	1	1 W	2 W	5 W	15 W	34 W	53 W
1600	2	2 W	3 W	7 W	20 W	45 W	74 W
2000	2	2 W	4 W	9 W	29 W	68 W	106 W
2400	3	3 W	5 W	11 W	34 W	78 W	126 W
2800	3	3 W	6 W	13 W	44 W	101 W	159 W

* Approximate fan input powers / When using electrothermal actuator add in the trench heater's power 3 W

FRD 0135 0325

FAN-ASSISTED TRENCH HEATER FOR HEATING/COOLING, 4 PIPE



- Fully glazed rooms with big heat gains
- Flats, villas, residences, hotels
- High heat output
- Optimum after-cooling output
- Convection with tangential fans
- Dry environment
- Safety voltage 24 V



Technical data

Trench heater

Height [H]	135 mm
Width [W]	325 mm
Length [L]	800-2 800 mm in step 400 mm

Heat exchanger

Type	Al-Cu lamellar
Length	L-490 mm
Connection thread	4xG1/2" inner

Working conditions

Max. temperature	110 °C
Max. overpressure	1 MPa (10 bar)
Protection	IP 20
Ambient conditions	Temp. T = +2 to +40 °C Humidity Rh = 20 to 70%

Trench heater standard equipment

Trough	Galvanized steel trough with surface finish and black spray layer inside, black cover plates of connection, inner condensate trough from stainless steel
Heat exchanger	Al-Cu lamellar exchanger with air vent valve, black painted
Grille	Design walkable grille according the customer's choice (stainless grilles surcharge)
Ledge	Made of anodized aluminium, type and colour according the customer's choice
Fan	Modern tangential fan with 24 V DC EC motor with high efficiency, rotors protection
Assembly elements	Leveling screws for setting up the trough, mounting brackets
Manual	Manual for the progress of work during installation and user manual
Wiring	Electrical wiring diagram of the trench heaters
Mounting board	Cover and the spacer particle board for easy installation
Package	Transport package for protection against damage during transportation and handling

Technical drawing

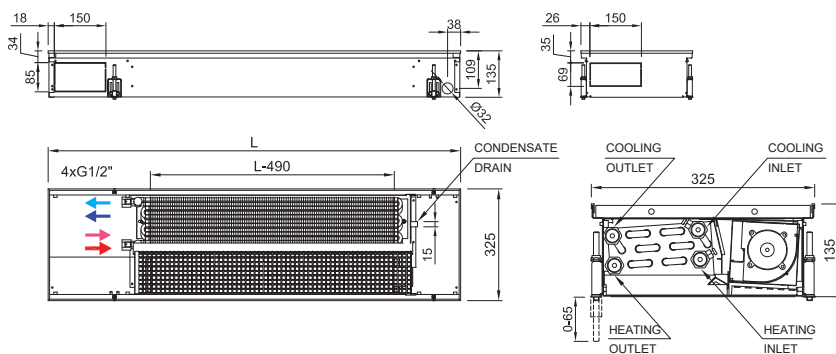

Connection to heating system

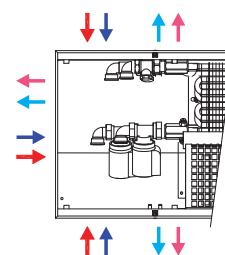

Accessories per order



Variants

Grilles

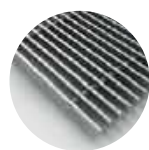

Transverse roll-up

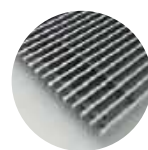

Linear non-rolling

Peripheral ledge



ⓘ Grilles → 6 ⓘ Ledges → 8 ⓘ Acoustic power → 13 ⓘ Accessories → 14 ⓘ Hydraulic parameters → 126

Code example: FRD 0135 0325 1600 C 31 J3 L - 5

Trench heater **FRD** H = **135 mm**, W = **325 mm**, L = **1 600 mm**, „C“ Galvanized steel trough with black inside, heat exchanger and inner parts painted black, „31“ black anodized aluminium grille, transverse, roll-up low, „J3“ peripheral ledge „J“, black anodized aluminium „L“ water connection at the left side (when installing the heat exchanger closer to the window, fans to the room), „5“ 24 V DC fans without controller (controller is not needed)



Trench heater heating output FRD 0135 0325, 4 pipe

Q[W] 75/65/20 °C (ΔT=50 °C)

Temperature exponent 1,1

Length L [mm]	Speed [-] / Heating output [W]						
	0	1	2	3	4	5	6 max
800	54 W	260 W	473 W	755 W	1 124 W	1 330 W	1 456 W
1200	125 W	577 W	1 048 W	1 672 W	2 490 W	2 947 W	3 226 W
1600	195 W	837 W	1 521 W	2 426 W	3 615 W	4 277 W	4 682 W
2000	265 W	1 154 W	2 096 W	3 343 W	4 981 W	5 893 W	6 452 W
2400	336 W	1 414 W	2 569 W	4 098 W	6 105 W	7 223 W	7 908 W
2800	406 W	1 731 W	3 144 W	5 015 W	7 471 W	8 840 W	9 678 W

Q[W] 55/45/20 °C (ΔT=30 °C)

Length L [mm]	Speed [-] / Heating output [W]						
	0	1	2	3	4	5	6 max
800	26 W	148 W	270 W	430 W	641 W	758 W	830 W
1200	60 W	329 W	597 W	953 W	1 420 W	1 680 W	1 839 W
1600	94 W	477 W	867 W	1 383 W	2 061 W	2 438 W	2 669 W
2000	129 W	658 W	1 195 W	1 906 W	2 840 W	3 360 W	3 678 W
2400	163 W	806 W	1 465 W	2 336 W	3 481 W	4 118 W	4 509 W
2800	197 W	987 W	1 792 W	2 859 W	4 259 W	5 040 W	5 518 W

75/65/20 °C → 75 °C inlet temperature, 65 °C outlet temp., 20 °C room temp. / Output 90/70/20 °C ≈ 1,22 x 75/65/20 °C / Output 70/55/20 °C ≈ 0,84 x 75/65/20 °C / Heating outputs in accordance with EN 16430



Trench heater cooling output FRD 0135 0325,4 pipe

17/19/28 °C (ΔT=10 °C)

Temperature exponent 0,7

Length L [mm]	Speed [-] / Cooling output [W]						
	0	1	2	3	4	5	6 max
800	-	< 10	42 W	98 W	183 W	243 W	296 W
1200	-	< 10	92 W	216 W	404 W	538 W	656 W
1600	-	< 10	134 W	314 W	587 W	781 W	952 W
2000	-	< 10	184 W	433 W	809 W	1 076 W	1 312 W
2400	-	11 W	226 W	530 W	991 W	1 318 W	1 608 W
2800	-	13 W	276 W	649 W	1 213 W	1 613 W	1 968 W

Cooling outputs in accordance with EN 16430



Acoustic power [dB(A)]

Length L [mm]	Speed [-] / Acoustic power [dB(A)]						
	0	1	2	3	4	5	6 max
800	-	< 25	26	37	53	61	67
1200	-	< 25	29	39	55	63	69
1600	-	25	30	40	56	64	70
2000	-	26	32	42	57	64	71
2400	-	29	34	42	57	65	71
2800	-	34	39	45	58	66	72

More details on page → 13



Fans input power [W]*

Length L [mm]	Number of fans	Speed [-] / Fans input power [W]*					
		1	2	3	4	5	6 max
800	1	1 W	1 W	2 W	5 W	11 W	21 W
1200	1	1 W	2 W	5 W	15 W	34 W	53 W
1600	2	2 W	3 W	7 W	20 W	45 W	74 W
2000	2	2 W	4 W	9 W	29 W	68 W	106 W
2400	3	3 W	5 W	11 W	34 W	78 W	126 W
2800	3	3 W	6 W	13 W	44 W	101 W	159 W

* Approximate fan input powers / When using electrothermal actuator add in the trench heater's power 3 W

FRB





Fan-assisted trench heaters with
a **lamellar exchanger for a humid
environment, heating**

TERMO - FRB



Fan-assisted heaters for a humid environment

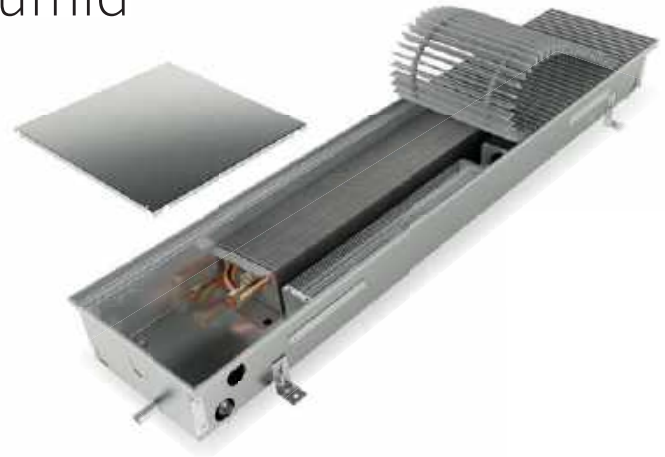

- Use in a humid environment
- Conservatories, greenhouses, bathrooms, saunas
- Garages, warehouses, halls, stadiums
- Not intended for swimming pools to be submerged
- High heater output
- Safe voltage of 24 V DC
- Energy-saving fans
- Quiet operation
- Continuous speed control
- Length **700-4 800 mm** (in step 100 mm)

FRB trench heaters are constructed to be used in conditions with higher moisture and possible water condensation. The heater structure is made of stainless steel resistant even to an aggressive environment and fitted with small drainage tubes along its sides. Tangential fans provide higher resistance against water (both with their structure and electrical protection). Only metal grilles are used for FRB; if a wooden grille is used, its surface must be treated to prevent its degradation (e.g. with boat varnish).

The heater is not designed to be used **in aggressive** environments of pools where it can become submerged, aggressive environments with a higher concentration of chlorine or environments containing salts.

FRB trench heaters achieve high heating outputs. Tangential fans are fitted with effective electrically commuted (EC) motors functioning on the basis of the safe voltage of 24 V DC. The motors have a very low consumption of electric power. The fan speed is controlled continuously with a controlling voltage of 0...10 V DC. A room thermostat secures the correct function of all installed FRB trench heaters, compares the set and actual temperatures in the room, opens the flowing of the heating medium in the exchanger and controls the fan revolutions according to the difference in the temperatures and the set mode of operation.

The use of new technologies secures optimal heating of the interior, energy savings, high efficiency and flexibility of heating. The trench heater is powered with safe voltage only, all components are powered with 24 V DC. The substantial range of heights and widths of trench heaters gives the designer numerous options for selecting a model with the required output for the composition of the floor in question.

The range of FRB models with a fan 24 V DC

Height	65 mm	80 mm	90 mm	110 mm	125 mm	140 mm
Width	-	-	-	-	-	-
	-	-	200 mm	200 mm	-	-
	-	-	250 mm	250 mm	250 mm	250 mm
	-	-	300 mm	300 mm	-	-
	-	-	425 mm	425 mm	-	-

Trench heater standard equipment

Trough	Trough of stainless steel DIN 1,4404, unpainted
Heat exchanger	Al-Cu lamellar exchanger with air vent valve, unpainted
Grille	Grille as selected by the customer; wooden grilles must be provided with appropriate surface finish (stainless grilles surcharge)
Ledge	Made of anodized aluminium, type and colour according to the customer's choice
Fan	Fans 24 V DC with EC motors with higher protection grade, suitable for humid environments
Assembly elements	Leveling screws for setting up the trough, mounting brackets
Manual	Manual for the progress of work during installation and user manual
Wiring	Electrical wiring diagram of the trench heaters
Mounting board	Cover and the spacer particle board for easy installation
Package	Transport package for protection against damage during transportation and handling

Accessories per order



Grilles

Non-corroding metal grilles are most frequently used in a damp environment. If a wooden grille is chosen, its surface must be treated accordingly.

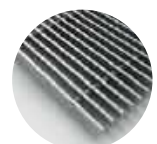

FRB overview of trench heaters with fan

175

200

250

300

425

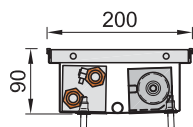

FRB 0090 0200

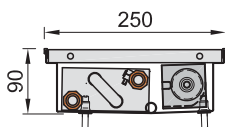

FRB 0090 0250

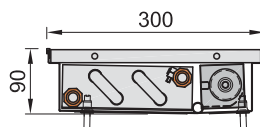

FRB 0090 0300

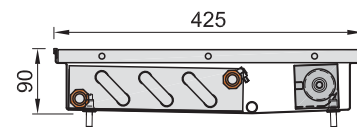

FRB 0090 0425

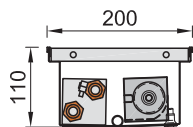

FRB 0110 0200

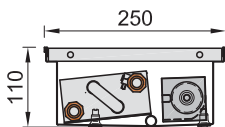

FRB 0110 0250

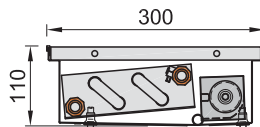

FRB 0110 0300

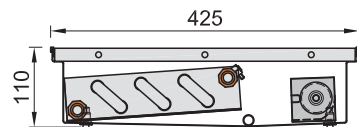

FRB 0110 0425

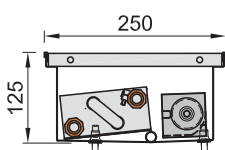

FRB 0125 0250

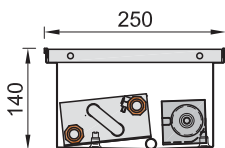

FRB 0140 0250

Thermal output of FRB trench heater

FRB trench heaters have an identical internal arrangement of components as FRT heaters. Their thermal output, acoustic parameters, electrical input and other specifications may be found at the dimensionally similar FRT model.

Example:

Heating output FRB 110x250x1600, speed 2, temperature gradient 75/65/20°C

FRB 0110 0250 1600 = FRT 0110 0250 1600 (page 65)

Temperature gradient: 75/65/20°C

Speed: 2

Output Q = 2 328 W

Acoustic power 34 dB

Input power 6 W

see the range of lengths and outputs of the relevant FRT model

Q[W] 75/65/20°C (ΔT=50°C)

Temperature exponent 1,1

Length L [mm]	Speed [-] / Heating output [W]				
	0	1	2	3	4 max.
700	108 W	288 W	594 W	790 W	851 W
800	134 W	384 W	792 W	1 053 W	1 135 W
900	161 W	461 W	950 W	1 264 W	1 362 W
1000	188 W	653 W	1 346 W	1 790 W	1 930 W
1100	214 W	653 W	1 346 W	1 790 W	1 930 W
1200	241 W	768 W	1 584 W	2 106 W	2 271 W
1300	268 W	845 W	1 742 W	2 317 W	2 498 W
1400	294 W	941 W	1 940 W	2 580 W	2 781 W
1500	321 W	1 037 W	2 138 W	2 844 W	3 065 W
1600	347 W	1 129 W	2 328 W	3 096 W	3 338 W
1700	374 W	1 129 W	2 328 W	3 096 W	3 338 W
1800	401 W	1 306 W	2 692 W	3 581 W	3 860 W
1900	427 W	1 417 W	2 922 W	3 886 W	4 189 W
2000	454 W	1 513 W	3 120 W	4 150 W	4 473 W
2100	481 W	1 590 W	3 278 W	4 360 W	4 700 W

Heater for swimming pools exposed to submersion

An atypical body is offered for the installation of trench heaters for pools. The use of the body which may be submerged in pool water is discussed with the customer and the specific conditions of use.

For more information contact the Technical Department of ISAN Radiátory s.r.o.

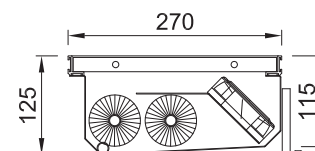

FRZ, FZC, FZD





Fan-assisted trench heaters
with installed power supply of 24 V DC

TERMO - FRZ, FDZ

Fan-assisted trench heaters with installed power supply



Advantages

- Easy connection of a higher number of heaters
- Connection at long distances
- Connection with IP67 electrical protection
- Negligible loss of voltage
- Easy incorporation into smart buildings
- Model range identical to that of FRT heaters
- Length **900-4 800 mm** (in step 100 mm)

Areas of use

- Shopping centres, administrative buildings
- Recreation and sport complexes, gyms, wellness
- Conference rooms
- Restaurants, cafés, hotels



For bigger projects where a high number of heaters are controlled simultaneously and individual sums of cabling distances are in tens of metres, it is advantageous to design **FRZ heaters with installed power supplies**.

The network need not be dimensioned upon the electrical output; the heaters are powered from their own power supplies. It also simplifies those projects where it is not clear until the last moment how many heaters there will be in individual rooms (for example depending on floor spaces rented in shopping centres). The connection may be flexibly modified, individual units may be easily separated and completed with a room thermostat.

The range of FRZ models

Height	65 mm	80 mm	90 mm	110 mm	125 mm	140 mm
Width	-	175 mm	175 mm	175 mm	-	-
	-	200 mm	200 mm	200 mm	-	-
	250 mm	250 mm	250 mm	250 mm	250 mm	250 mm
	300 mm	300 mm	300 mm	300 mm	300 mm	300 mm
	-	-	425 mm	425 mm	425 mm	425 mm

Design

A power supply is placed in the trench heater which converts the mains voltage of 230 V AC to a low DC voltage of 24 V DC. Connection safety is ensured by using components with IP67 electrical protection, which can even withstand submersion in water. All elements inside the trench heater - the tangential fan and electro-thermal actuator - work on a safe DC voltage. The same applies to the RTD201 and RTM201 room thermostats.

Code example: FRZ 0090 0250 2400 C 64 L2 L - 5

Trench heater with integrated power supply FRZ H = 90 mm, W = 250 mm, L = 2 400 mm, „C“ Galvanized steel trough with black inside, heat exchanger and inner parts painted black, „64“ stained oak grille, transverse, roll-up „L2“ peripheral ledge „L“ with an overlap, bronze anodized aluminium, „L“ water connection at the left side (when installing the heat exchanger closer to the window, fans to the room), „5“ 24 V DC fans without controller (controller is not needed)

Output

In the output tables of the TERMO FRT trench heaters, parameters of the 200 mm shorter heater should be considered. Because of the high coverage of the exchanger by the fans in each length, the change in performance is generally not significant. The trench heater achieves its initial performance with a slight increase in the fan speed, which is enabled by continuous control of the thermostat.

Example output determination for FRZ 0090 0250 heater, temperature gradient 75/65/20°C →

Length L [mm]	Speed [-] / Heating output [W]			
	1	2	3	4 max.
1400	826 W	1 748 W	2 302 W	2 457 W
1500	910 W	1 927 W	2 536 W	2 708 W
1600	991 W	2 098 W	2 762 W	2 949 W
1700	991 W	2 098 W	2 762 W	2 949 W
1800	1 146 W	2 426 W	3 194 W	3 410 W
1900	1 244 W	2 633 W	3 466 W	3 701 W
2000	1 328 W	2 811 W	3 701 W	3 952 W

Assembly

The space required for the installed power supply is 200 mm. For the same trench heater length, the installed elements are therefore identical to the 200 mm shorter FRT trench heater. The installation of the trench heater and its connection to the heating system are the same as with the standard trench heater.

Difference in the installation of interior elements in standard trench heaters and trench heaters with an installed power supply.

STANDARD TRENCH HEATER DESIGN (FRT designation)

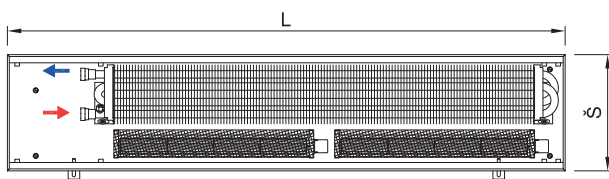

TRENCH HEATER WITH INSTALLED POWER SUPPLY (FRZ designation)

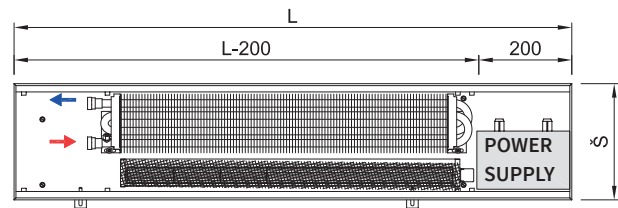

Regulation

For the proper function of the trench heaters, control and regulatory elements should be added. The room temperature is assessed by the room thermostat (RTD201, RTM201) which controls the fan speed and the flow of the heating medium through the exchanger. The flow is regulated using the Z-TS24 electrothermal actuator, which opens or closes the Z-TD001 thermostatic valve. The thermostatic valve is installed at the input to the heat exchanger. For the proper adjustment of the flow volume of the heating medium, it is necessary to install and set the Z-RD001 lockshield at the output of the exchanger. If more than 10 trench heaters are installed, the RL10 relay for opening additional actuators is incorporated.

Fans with motors with EC technology are controlled by a voltage of 0 ... 10 V DC, and electrothermal actuators are controlled with a switching voltage of 24 V DC. Such control allows easy integration into buildings with a BMS (Building Management System) central control. When the European KNX standard is used, it is appropriate to control trench heaters with the RTD201KN thermostat with implemented KNX communication.

Control elements of FRZ trench heaters



Digital thermostat **RTD201**



Manual thermostat **RTM201**



Electrothermal actuator **Z-TS24**



Thermostatic valve **Z-TD001**



LockShield valve **Z-RD001**

Further information about accessories may be found in FRT product range on page 14.

Circuit diagram

An alternating voltage of 230 V AC is fed to the trench heater with a power supply. There it is transformed into a safe voltage of 24 V DC. All the elements of the trench heater (fans, electrothermal actuators and the room thermostat) then work with it.

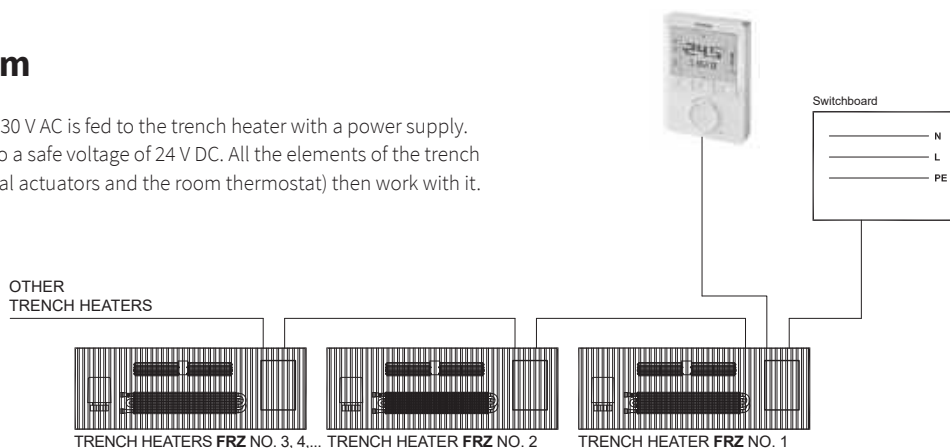

TERMO - FZC, FZD

Fan-assisted heaters with installed power supply



Advantages

- Easy connection of a higher number of heaters
- Connection at long distances
- Connection with IP67 electrical protection
- Negligible loss of voltage
- Easy incorporation into smart buildings
- Model range identical to that of FRC, FRD heaters
- Length **800-2 800** mm in step **400** mm (FRZ 100x175 1000-3 000 mm)



Areas of use

- Shopping centres, administrative buildings
- Recreation and sport complexes, gyms, wellness
- Conference rooms
- Restaurants, cafés, hotels

For bigger projects where a high number of heaters are controlled simultaneously and individual sums of cabling distances are in tens of metres, it is advantageous to design FZC, FZD heaters with installed power supplies. This option should be considered especially for 135 x 325 mm heaters with higher input for the maximum revolutions in cooling, if more than two units are to be installed per room.

For FZC and FZD the network need not be dimensioned upon the electrical output; the heaters are powered from their own installed power supplies. It also simplifies those projects where it is not clear until the last moment how many heaters there will be in individual rooms (for example depending on floor spaces rented in shopping centres). The connection may be flexibly modified, individual units may be easily separated and completed with a room thermostat.

Design

A power supply is placed in the trench heater which converts the mains voltage of 230 V AC to a low DC voltage of 24 V DC. Connection safety is ensured by using components with IP67 electrical protection, which can even withstand submersion in water. All elements inside the trench heater - the tangential fan and electro-thermal actuator - work on a safe DC voltage. The same applies to the RTD201 and RTM201 room thermostats.

The range of FZC models

- **FZC 0100 0175**
installed power supply
FRC 0100 0175
The FZC trench heater is 200 mm longer than FRC
- **FZC 0135 0325**
installed power supply
FRC 0135 0325

The range of FZD models

- **FZD 0135 0325**
installed power supply
FRD 0135 0325

Height	100 mm	135 mm
Width	175 mm	-
	-	325 mm

Height	100 mm	135 mm
Width	-	-
	-	325 mm

Code example: FZC 00135 0325 1800 C 11 J1 L - 5

Trench heater **FZC** with integrated power supply H = **135** mm, W = **325** mm, L = **1800** mm, „**C**“ Galvanized steel trough with black inside, heat exchanger and inner parts painted black, „**11**“ natur anodized aluminium grille, transverse, roll-up „**J1**“ peripheral ledge „**J**“, natur anodized aluminium, „**L**“ water connection at the left side (when installing the heat exchanger closer to the window, fans to the room), „**5**“ 24 V DC fans without controller (controller is not needed)

Heating and cooling output, acoustic parameters

All parameters of heating and cooling outputs, acoustic parameters and other quantities are identical to the FRC and FRD trench heaters. The only deviation is in the FCZ 0100 0175, where the trench length is 200 mm longer compared to the FRC 0100 0175.

- **FZC 0100 0175** → FRC 0100 0175 page 86
- **FZC 0135 0325** → FRC 0135 0325 page 88
- **FZD 0135 0325** → FRD 0135 0325 page 90

Example output determination for FZC 0100 0175 heater, temperature gradient 75/65/20°C →

Length L [mm]	Speed [-] / Heating output [W]				
	0	1	2	3	4
800	23 W	104 W	240 W	479 W	673 W
1200	45 W	235 W	545 W	1 087 W	1 526 W
1600	67 W	339 W	785 W	1 566 W	2 199 W
2000	89 W	471 W	1 089 W	2 173 W	3 052 W

FZC 0100 0175 with installed power supply - 200 mm longer

Due to the small interior space in the 100 x 175 heater it is necessary to make it 200 mm longer if a switched power supply is to be installed.

LENGTHS OF FZC 0100 0175 HEATERS WITH POWER SUPPLY:

L = 1000, 1400, 1800, 2200, 2600 a 3000 mm.

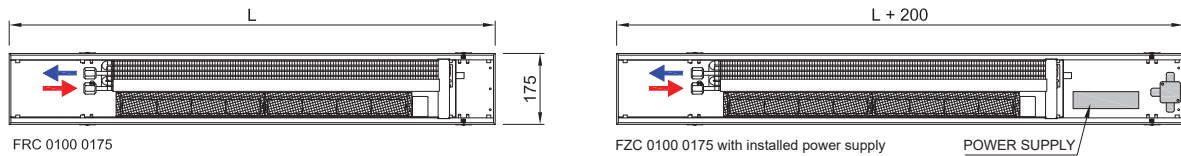

FZC, FZD 0135 0325 with installed power supply

The switched power supply is located in the space for the connecting the electrical wiring. The heater looks the same as the one without the power supply.

LENGTHS OF FZC 0100 0175 HEATERS WITH POWER SUPPLY:

L = 800, 1200, 1600, 2000, 2400, 2800 mm

All parameters of the heater are identical to the model without the installed power supply FRC 0135 0325 (page 88) or FRD 0135 0325 (page 90).

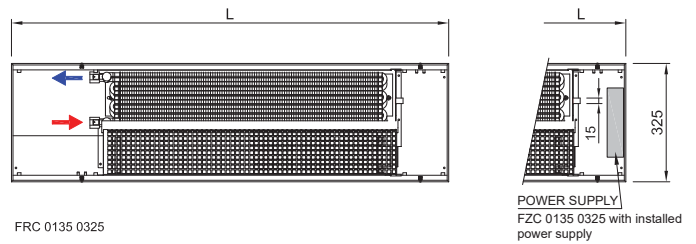

Control elements of FZC, FZD trench heaters



Digital thermostat **RTD201**



Manual thermostat **RTM201**



Electrothermal actuator **Z-TS24**



Thermostatic valve **Z-TD001**



LockShield valve **Z-RD001**

Circuit diagram

An alternating voltage of 230 V AC is fed to the trench heater with a power supply. There it is transformed into a safe voltage of 24 V DC. All the elements of the trench heater (fans, electrothermal actuators and the room thermostat) then work with it.

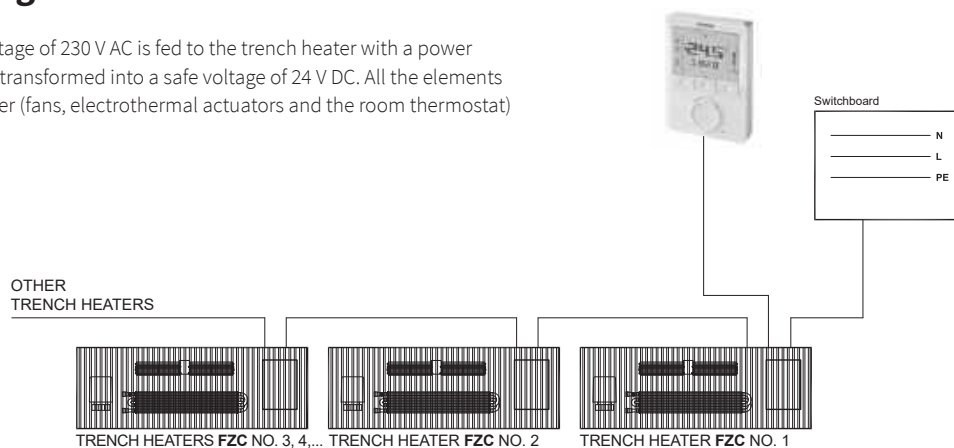

TERMO for the heating system with natural convection

TERMO trench heaters with natural convection are installed under glazing covering the entire area of buildings. Trench heaters form a thermal barrier to keep the flow of cold air from the window surface. A part of warm air is directed inwards and heats residential spaces. The trench heaters are normally used as additional heating combined with other types of heating. If the heat output of the trench heater is sufficient the trench heater may also be used as the main heating system. These trench heaters are also suitable to adjust temperatures in entrance halls, commercial areas and long corridors.

A great range of the heights and widths of the trench heaters gives the designer many options how to fit the model with the required output in the configuration of the floor. Necessary data are presented in data sheets for individual products.

The range of models with natural convection

Heating	Humid environment
FRK <ul style="list-style-type: none">heatingnatural convectionlamellar exchangerdry environmentpage 108	FRM <ul style="list-style-type: none">heatingnatural convectionlamellar exchangerhumid environmentpage 124

Trench heater „made to measure“

Based on the requirements of larger projects it is possible to supply a “made to measure” trench heater with adjusted height and width. Having approved the structure we will submit a protocol from a test room presenting output parameters. We also offer modifications of the trench heater for the use in humid environment, the connection of air handling piping and others. The technical documentation is first consulted with the customer and only then the production of the trench heater starts.

Working conditions

- Installation in a hot water heating system with forced circulation
- Maximal operating temperature of heating medium 110 °C
- Maximal operating overpressure 1 MPa
- Ambient temperature +2 to +40 °C
- Relative humidity of environment 20 to 70% (FRM 20-100%)

Placement in the floor

The trench heaters are laid in the floor so that the exchanger is closer to the window side. The vertical and horizontal distribution of temperatures in the heated room is uniform and conditions are created to provide thermal comfort. Air flow is comparable to the heat transfer with classical heating bodies placed on the wall below windows.

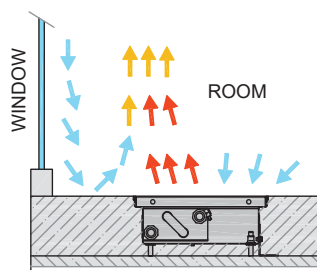

Connecting the heating system

The lamellar **Al-Cu** heat exchangers have aluminium lamellas pressed onto a copper pipe. The heating medium flows through this pipe.

The inlet and outlet of the pipe is provided with a connecting end with internal thread G1/2". Normally the water connection of the heat exchanger is on the left side (when the heat exchanger is placed nearer the window).

We install a thermostatic valve fitted with an electrothermal actuator on the inlet of the lamellar heat exchanger. The actuator works in the opened/closed mode and controls the flow of the heating medium.

The second option is to use a mechanical thermostat with a capillary. The regulation is proportional, no electric power is necessary. However each trench heater shall be fitted with its own thermostat with a capillary. Suitable for single long heating bodies.

It is not necessary to use a thermostatic valve if the temperature of the heating medium is controlled by the heating system (e.g. equithermal system). The way of regulation is to be determined by the designer of the heating and this shall be specified in the project documentation.

A return regulating screw connection shall be used for the outlet. This enables the incorporation of the trench heater into the heating system from the viewpoint of the hydraulic balancing. Based on the parameters of the screw connection used the designer determines the setting (corresponding to pressure loss at the fitting) and this value shall be specified in the project documentation.

Each exchanger is fitted with an air vent valve. When the heating system is connected and filled air bubbles remain caught in the upper part of the exchanger. These shall be let out through the air vent valve.

Connection with an electrothermal actuator

Connection of the electrothermal actuator 24 V DC

The thermostat opens and closes the flow of heating medium through the heat exchanger in dependence on temperature changes in the room. The flow is controlled with an electrothermal actuator 24 V DC. The connection will be used if there is the requirement for safe voltage of 24 V DC in the trench heater or if the trench heaters are combined with the FRT ventilator in a single room. In such case the trench heater is connected to a shared thermostat. Regulation takes place in the opened/closed mode (ON/OFF).

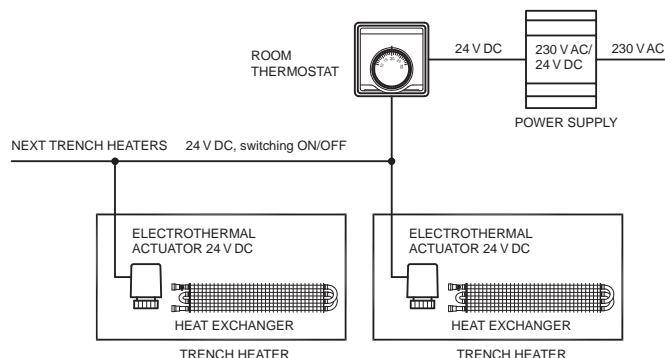

Connection of the electrothermal actuator 230 V AC

Simplified connection using the voltage of 230 V AC for trench heaters with natural convection FRK. Simple cabling, a thermal actuator with IP54 protection. Regulation takes place in the opened/closed mode (ON/OFF).

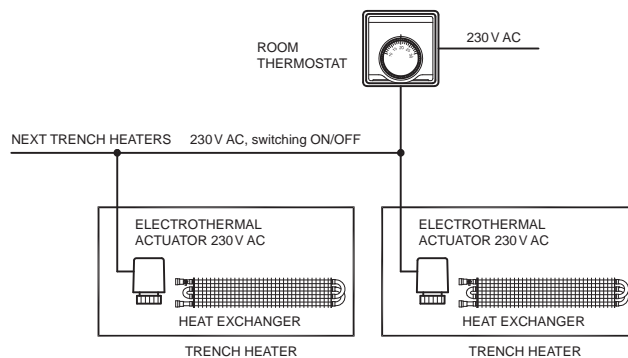

Connection with the capillary thermostat

The capillary thermostat automatically maintains a preset temperature in the room. The temperature is regulated in dependence on the user's requirements without the need for other energy sources. Maintaining the preset temperature is secured by air flowing around the thermal sensor. The thermostatic valve will release only such amount of water into the heating body that is needed to maintain the set temperature in the room. The capillary thermostat is installed to each trench heater.

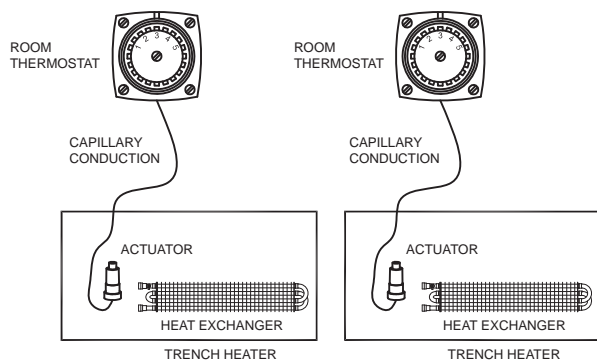

The output of the trench heater

The tables contain output data for thermal gradient 75/65/20°C, standardized output according to standard ČSN EN 16 430-2. This standard also defines the procedure for conversion to other thermal gradients. The second table presents a converted thermal gradient of 55/45/20°C and a fast approximate conversion for gradients of 90/70/20°C and 70/55/20°C.

Hydraulics

The table with hydraulic resistance is presented on page 126.

FRK



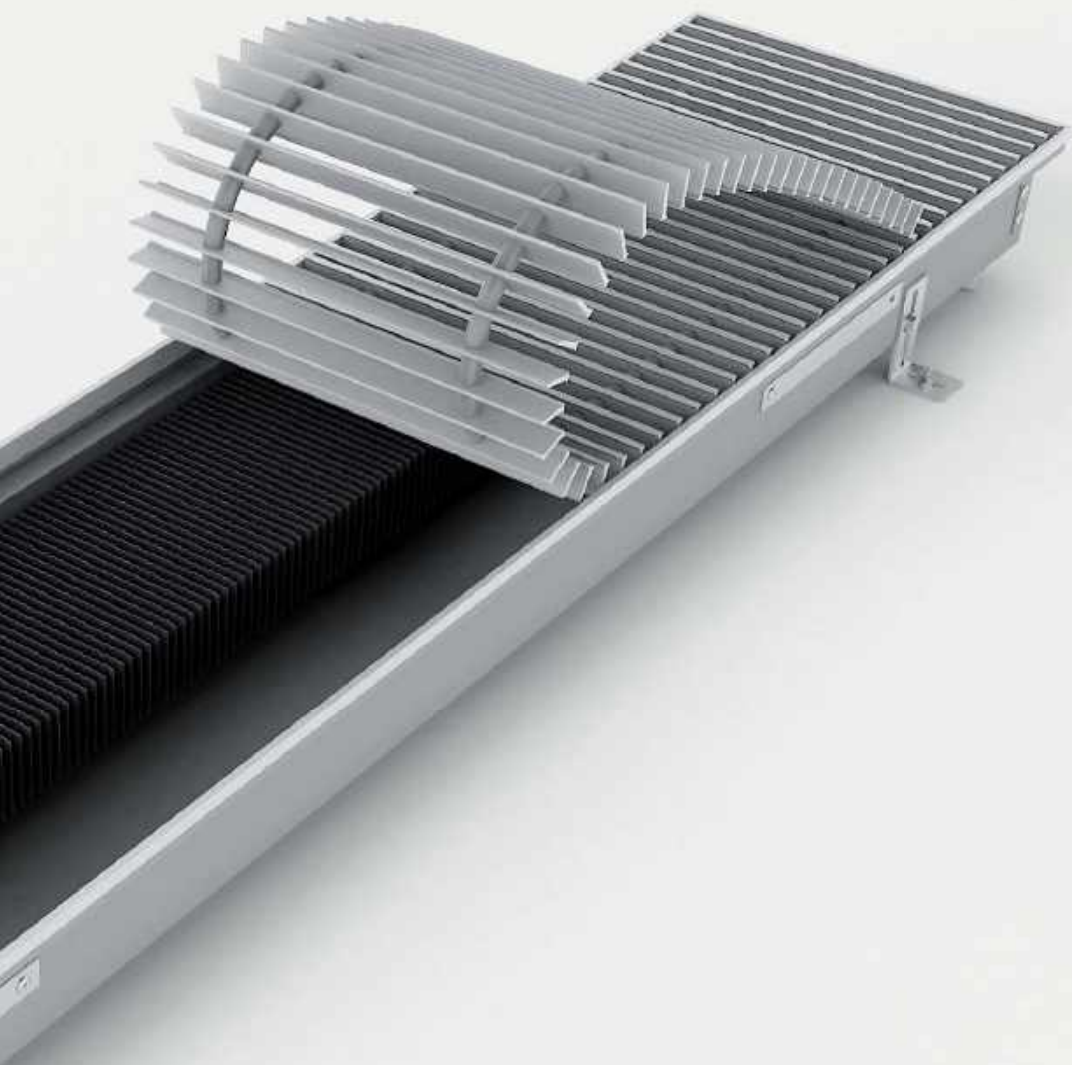

Trench heaters with **natural convection and lamellar exchanger, heating**

TERMO - FRK



trench heaters with natural convection

FRK trench heaters with natural convection are installed under glazing covering the entire area of buildings. Trench heaters form a thermal barrier to keep the flow of cold air from the window surface. A part of warm air is directed inwards and heats residential spaces. The trench heaters are normally used as additional heating combined with other types of heating. If the heat output of the trench heater is sufficient the trench heater may also be used as the main heating system. These trench heaters are also suitable to adjust temperatures in entrance halls, commercial areas and long corridors.

A great range of the heights and widths of the trench heaters gives the designer many options how to fit the model with the required output in the configuration of the floor. Necessary data are presented in data sheets for individual products.

The range of FRK models with natural convection

Height	80 mm	90 mm	110 mm	125 mm	140 mm	165 mm	200 mm
Width	-	175 mm	175 mm	175 mm	175 mm	-	-
	-	200 mm	200 mm	200 mm	200 mm	-	-
	250 mm	250 mm	250 mm	250 mm	250 mm	-	-
	300 mm	300 mm	300 mm	300 mm	300 mm	300 mm	300 mm
	-	350 mm	350 mm	350 mm	350 mm	350 mm	350 mm
	-	425 mm	425 mm	425 mm	425 mm	425 mm	425 mm

Placement in the floor

The trench heaters are laid in the floor so that the exchanger is closer to the window side. The vertical and horizontal distribution of temperatures in the heated room is uniform and conditions are created to provide thermal comfort. Air flow is comparable to the heat transfer with classical heating bodies placed on the wall below windows.

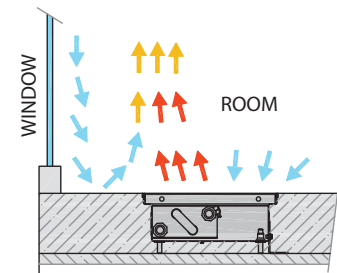

FRK an overview of trench heaters with natural convection

175

200

250

300

350

425

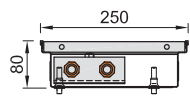

FRK 0080 0250
page 108

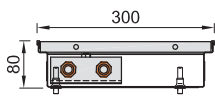

FRK 0080 0300
page 108

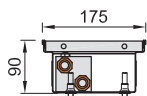

FRK 0090 0175
page 110

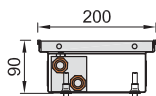

FRK 0090 0200
page 110

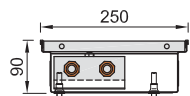

FRK 0090 0250
page 110

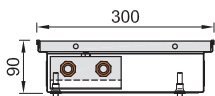

FRK 0090 0300
page 110

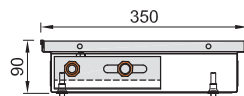

FRK 0090 0350
page 110

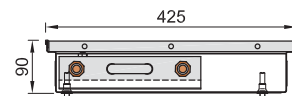

FRK 0090 0425
page 110

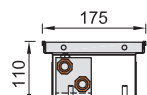

FRK 0110 00175
page 112

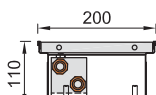

FRK 0110 0200
page 112

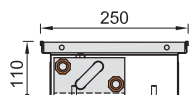

FRK 0110 0250
page 112

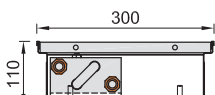

FRK 0110 0300
page 112

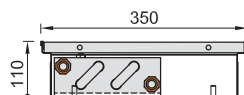

FRK 0110 0350
page 112

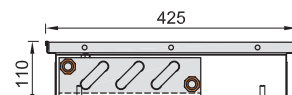

FRK 0110 0425
page 112

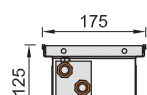

FRK 0125 0175
page 114

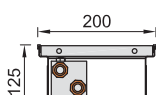

FRK 0125 0200
page 114

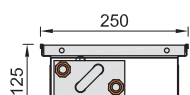

FRK 0125 0250
page 114

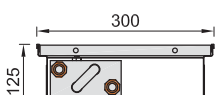

FRK 0125 0300
page 114

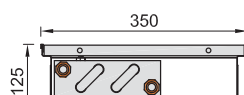

FRK 0125 0350
page 114



FRK 0125 0425
page 114

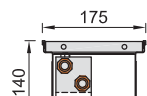

FRK 0140 0175
page 116

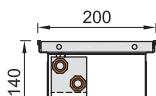

FRK 0140 0200
page 116

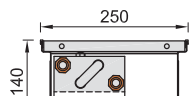

FRK 0140 0250
page 116

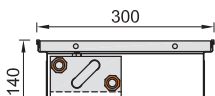

FRK 0140 0300
page 116

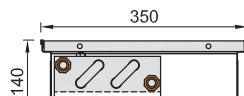

FRK 0140 0350
page 116

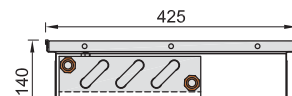

FRK 0140 0425
page 116

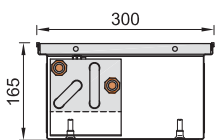

FRK 0165 0300
page 118

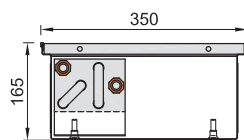

FRK 0165 0350
page 118

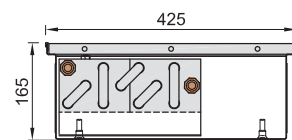

FRK 0165 0425
page 118

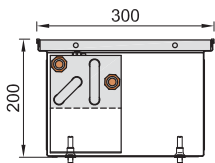

FRK 0200 0300
page 120

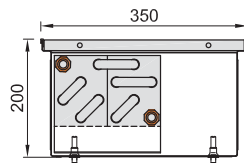

FRK 0200 0350
page 120

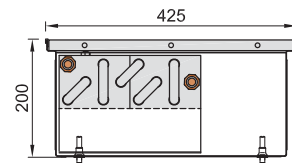

FRK 0200 0425
page 120



FRK 0080 0250/0300

TRENCH HEATERS WITH NATURAL CONVECTION



- Offices, corridors, halls, flats, winter garden
- High heating output of natural convection
- Suitable for combining with other heating systems
- Using in dry environment
- 2pipe system



FRK 0080 0250

Technical data

Trench heater

Height [H]	80 mm
Width [W]	250, 300 mm
Length [L]	700-4800 mm in step 100 mm

Heat exchanger

Type	Al-Cu lamellar
Length	L-295 mm
Connection thread	2xG1/2" inner

Working conditions

Max. temperature	110 °C
Max. overpressure	1 MPa (10 bar)
Protection	IP 20
Ambient conditions	Temp. T = +2 to +40 °C Humidity Rh = 20 to 70%

Accessories per order



Variants

Grilles

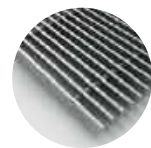

Transverse roll-up

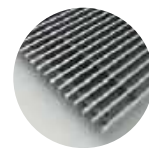

Linear

Peripheral ledges



FRK 0080 0250/0300 Trench heater heating output

Q[W] 75/65/20 °C (ΔT=50 °C)

HxW [mm]	0080 0250 L [mm] n=1,369	0080 0300 L [mm] n=1,376
700	115 W	119 W
800	144 W	148 W
900	172 W	177 W
1000	200 W	206 W
1100	229 W	236 W
1200	257 W	265 W
1300	286 W	294 W
1400	314 W	324 W
1500	343 W	353 W
1600	371 W	382 W
1700	399 W	411 W
1800	428 W	441 W
1900	456 W	470 W
2000	485 W	499 W
2100	513 W	528 W
2200	542 W	558 W
2300	570 W	587 W
2400	598 W	616 W
2500	627 W	646 W
2600	655 W	675 W
2700	684 W	704 W
2800	712 W	733 W
2900	741 W	763 W
3000	769 W	792 W
3200	826 W	850 W
3400	883 W	909 W
3600	940 W	968 W
3800	996 W	1026 W
4000	1053 W	1085 W
4200	1110 W	1143 W
4400	1167 W	1202 W
4600	1224 W	1260 W
4800	1281 W	1319 W

Q[W] 55/45/20 °C (ΔT=30 °C)

HxW [mm]	0080 0250 L [mm] n=1,369	0080 0300 L [mm] n=1,376
700	57 W	59 W
800	72 W	73 W
900	85 W	88 W
1000	99 W	102 W
1100	114 W	117 W
1200	128 W	131 W
1300	142 W	146 W
1400	156 W	160 W
1500	170 W	175 W
1600	184 W	189 W
1700	198 W	204 W
1800	213 W	218 W
1900	227 W	233 W
2000	241 W	247 W
2100	255 W	262 W
2200	269 W	276 W
2300	283 W	291 W
2400	297 W	305 W
2500	312 W	320 W
2600	326 W	334 W
2700	340 W	349 W
2800	354 W	363 W
2900	368 W	378 W
3000	382 W	392 W
3200	410 W	421 W
3400	439 W	450 W
3600	467 W	479 W
3800	495 W	508 W
4000	523 W	537 W
4200	552 W	566 W
4400	580 W	595 W
4600	608 W	624 W
4800	637 W	653 W

75/65/20 °C → 75 °C inlet temperature, 65 °C outlet temp., 20 °C room temp. / Output 90/70/20 °C = ~ 1,29 x 75/65/20 °C / Output 70/55/20 °C = ~ 0,80 x 75/65/20 °C / Heating outputs in accordance with EN 16430 / Not listed heating output for lengths per 100 mm steps calculate linearly. Exact values can be found at www.isan.cz



FRK 0080 0300

Technical drawing

FRK 0080 0250

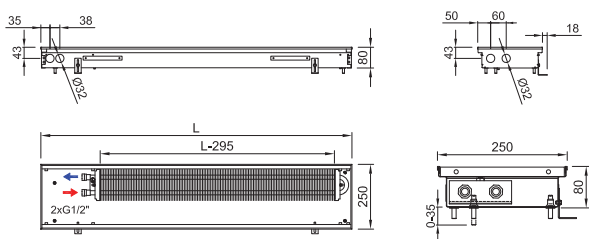

FRK 0080 0300

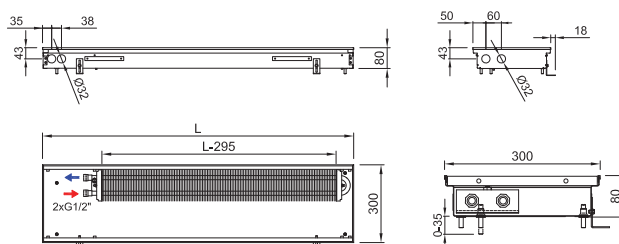

Trench heater standard equipment

Trough	Galvanized steel trough with surface finish and black spray layer inside, black cover plates of connection
Heat exchanger	Al-Cu lamellar exchanger with air vent valve, black painted
Grille	Design walkable grille according the customer's choice (stainless grilles surcharge)
Ledge	Made of anodized aluminium, type and colour according the customer's choice
Assembly elements	Leveling screws for setting up the trough, mounting brackets
Manual	Manual for the progress of work during installation and user manual
Wiring	Electrical wiring diagram of the trench heaters
Mounting board	Cover and the spacer particle board for easy installation
Package	Transport package for protection against damage during transportation and handling

Connection to heating system

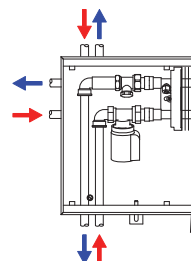

① Grilles → 6 ② Ledges → 8 ③ Accessories → 14 ④ Hydraulic parameters → 126

Code example: FRK 0080 0250 1900 C 11 L1 L - 0 / Trench heater **FRK** H=80 mm, W= 250 mm, L=1 900 mm, „C“ Galvanized steel trough with black inside, heat exchanger and inner parts painted black, „15„ Low natural anodized aluminium grille, transverse, rigid, „L1“ peripheral ledge „L“ with an overlap, natur anodized aluminium „L“ water connection at the left side (when installing the heat exchanger closer to the window, fans to the room), „0“ trench heater with natural convection

FRK 0090 175/0200/0250/0300/0350

TRENCH HEATERS WITH NATURAL CONVECTION



- Offices, corridors, halls, flats, winter garden
- High heating output of natural convection
- Suitable for combining with other heating systems
- Using in dry environment
- 2 pipe system



FRK 0090 0175



FRK 0090 0200

Technical data

Trench heater

Height [H] **90 mm**
Width [W] **175, 200, 250, 300, 350, 425 mm**
Length [L] **700-4800 mm**
in step 100 mm

Heat exchanger

Type **Al-Cu lamellar**
Length **L-295 mm**
Connection thread **2xG1/2" inner**

Working conditions

Max. temperature **110 °C**
Max. overpressure **1 MPa (10 bar)**
Protection **IP 20**
Ambient conditions **Temp. T = +2 to +40 °C**
Humidity Rh = 20 to 70%

Accessories per order



Manual thermostat



Room thermostat with a capillary



Electrothermal actuator



Thermostatic valve



Lockshield valve

Variants

Grilles

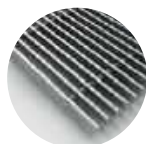

Transverse roll-up

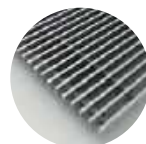

Linear

Peripheral ledges



FRK 0090 0175/0200/0250/0300/0350/0425

Q[W] 75/65/20 °C (ΔT=50 °C)

H×W [mm]	0090 0175	0090 0200	0090 0250	0090 0300	0090 0350	0090 0425
L [mm]	n=1,46	n=1,463	n=1,375	n=1,369	n=1,372	n=1,389
700	79 W	94 W	137 W	146 W	168 W	209 W
800	98 W	117 W	171 W	182 W	210 W	261 W
900	118 W	140 W	205 W	218 W	252 W	313 W
1000	137 W	164 W	239 W	254 W	293 W	365 W
1100	157 W	187 W	273 W	290 W	335 W	416 W
1200	176 W	210 W	306 W	326 W	376 W	468 W
1300	196 W	233 W	340 W	362 W	418 W	520 W
1400	215 W	256 W	374 W	398 W	460 W	572 W
1500	235 W	279 W	408 W	434 W	501 W	623 W
1600	254 W	303 W	442 W	470 W	543 W	675 W
1700	274 W	326 W	476 W	506 W	584 W	727 W
1800	293 W	349 W	510 W	542 W	626 W	778 W
1900	313 W	372 W	544 W	578 W	668 W	830 W
2000	332 W	395 W	577 W	614 W	709 W	882 W
2100	352 W	419 W	611 W	650 W	751 W	934 W
2200	371 W	442 W	645 W	686 W	792 W	985 W
2300	391 W	465 W	679 W	722 W	834 W	1037 W
2400	411 W	488 W	713 W	758 W	876 W	1089 W
2500	430 W	511 W	747 W	794 W	917 W	1140 W
2600	450 W	535 W	781 W	830 W	959 W	1192 W
2700	469 W	558 W	814 W	866 W	1000 W	1244 W
2800	489 W	581 W	848 W	902 W	1042 W	1296 W
2900	508 W	604 W	882 W	938 W	1084 W	1347 W
3000	528 W	627 W	916 W	974 W	1125 W	1399 W
3200	567 W	674 W	984 W	1046 W	1208 W	1502 W
3400	606 W	720 W	1052 W	1118 W	1292 W	1606 W
3600	645 W	766 W	1119 W	1190 W	1375 W	1709 W
3800	684 W	813 W	1187 W	1262 W	1458 W	1813 W
4000	723 W	859 W	1255 W	1334 W	1541 W	1916 W
4200	762 W	906 W	1322 W	1406 W	1624 W	2020 W
4400	801 W	952 W	1390 W	1478 W	1708 W	2123 W
4600	840 W	998 W	1458 W	1550 W	1791 W	2227 W
4800	879 W	1045 W	1526 W	1622 W	1874 W	2330 W

Q[W] 55/45/20 °C (ΔT=30 °C)

H×W [mm]	0090 0175	0090 0200	0090 0250	0090 0300	0090 0350	0090 0425
L [mm]	n=1,46	n=1,463	n=1,375	n=1,369	n=1,372	n=1,389
700	37 W	45 W	68 W	73 W	83 W	103 W
800	46 W	55 W	85 W	90 W	104 W	128 W
900	56 W	66 W	102 W	108 W	125 W	154 W
1000	65 W	78 W	118 W	126 W	145 W	180 W
1100	74 W	89 W	135 W	144 W	166 W	205 W
1200	83 W	99 W	152 W	162 W	187 W	230 W
1300	93 W	110 W	168 W	180 W	207 W	256 W
1400	102 W	121 W	185 W	198 W	228 W	281 W
1500	111 W	132 W	202 W	216 W	249 W	306 W
1600	120 W	144 W	219 W	234 W	269 W	332 W
1700	130 W	154 W	236 W	251 W	290 W	358 W
1800	139 W	165 W	253 W	269 W	311 W	383 W
1900	148 W	176 W	270 W	287 W	331 W	408 W
2000	157 W	187 W	286 W	305 W	352 W	434 W
2100	167 W	198 W	303 W	323 W	373 W	459 W
2200	176 W	209 W	320 W	341 W	393 W	484 W
2300	185 W	220 W	336 W	359 W	414 W	510 W
2400	195 W	231 W	353 W	377 W	435 W	536 W
2500	204 W	242 W	370 W	395 W	455 W	561 W
2600	213 W	253 W	387 W	412 W	476 W	586 W
2700	222 W	264 W	403 W	430 W	496 W	612 W
2800	232 W	275 W	420 W	448 W	517 W	637 W
2900	241 W	286 W	437 W	466 W	538 W	662 W
3000	250 W	297 W	454 W	484 W	558 W	688 W
3200	269 W	319 W	488 W	520 W	599 W	739 W
3400	287 W	341 W	521 W	556 W	641 W	790 W
3600	306 W	363 W	554 W	591 W	682 W	841 W
3800	324 W	385 W	588 W	627 W	723 W	892 W
4000	343 W	407 W	622 W	663 W	765 W	942 W
4200	361 W	429 W	655 W	699 W	806 W	993 W
4400	380 W	451 W	689 W	734 W	847 W	1 044 W
4600	398 W	473 W	722 W	770 W	889 W	1 095 W
4800	417 W	495 W	756 W	806 W	930 W	1 146 W

75/65/20 °C → 75 °C inlet temperature, 65 °C outlet temp., 20 °C room temp. / Output 90/70/20 °C = ~ 1,29 x 75/65/20 °C / Output 70/55/20 °C = ~ 0,80 x 75/65/20 °C / Heating outputs in accordance with EN 16430 / Not listed heating outputs for lengths per 100 mm steps calculate linearly. Exact values can be found at www.isan.cz

/0425



Technical drawing

FRK 0090 0175

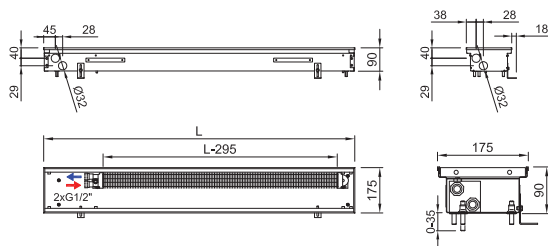

FRK 0090 0200

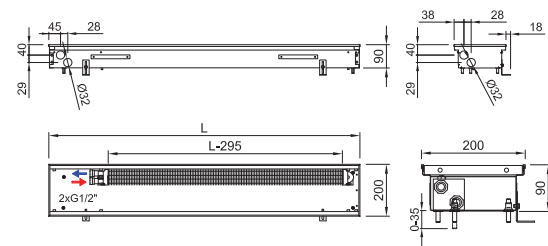

FRK 0090 0250

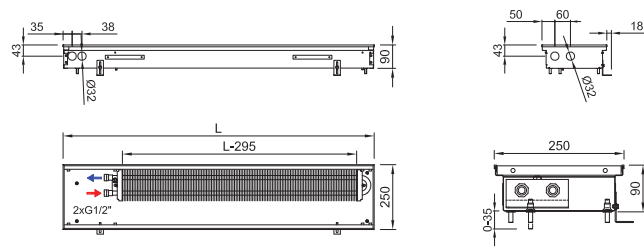

FRK 0090 0300

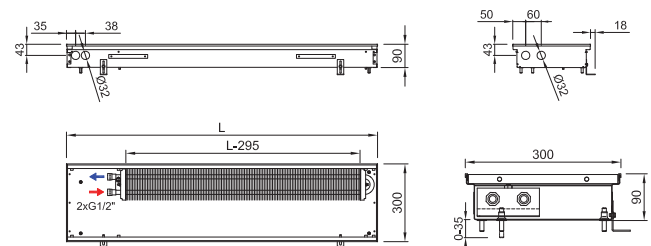

FRK 0090 0350

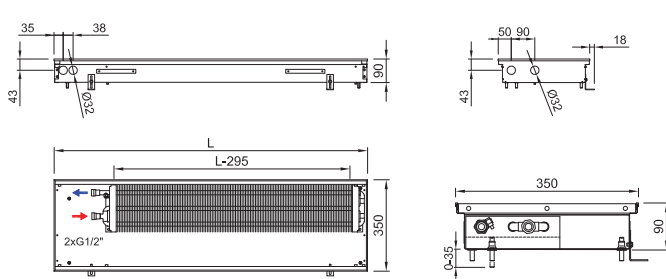

FRK 0090 0425

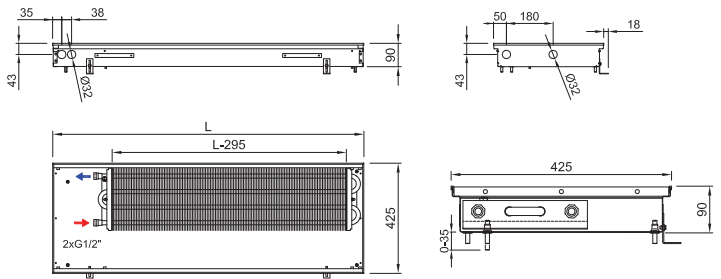

Trench heater standard equipment

Trough	Galvanized steel trough with surface finish and black spray layer inside, black cover plates of connection
Heat exchanger	Al-Cu lamellar exchanger with air vent valve, black painted
Grille	Design walkable grille according to the customer's choice (stainless grilles surcharge)
Ledge	Made of anodized aluminium, type and colour according to the customer's choice
Assembly elements	Leveling screws for setting up the trough, mounting brackets
Manual	Manual for the progress of work during installation and user manual
Wiring	Electrical wiring diagram of the trench heaters
Mounting board	Cover and the spacer particle board for easy installation
Package	Transport package for protection against damage during transportation and handling

Ⓜ Grilles → 6 Ⓜ Ledges → 8 Ⓜ Accessories → 14 Ⓜ Hydraulic parameters → 126

Connection to heating system

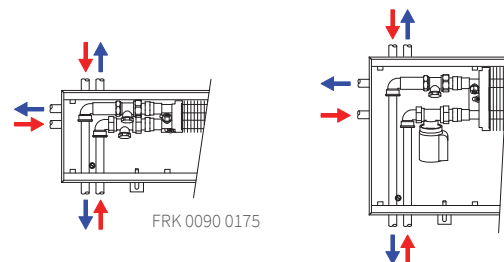

Code example: FRK 0090 0300 0900 C 12 J1 L - 0/ Trench heater FRK H=90 mm, W= 300 mm, L=900 mm, „C“ Galvanized steel trough with black inside, heat exchanger and inner parts painted black, „12“ natur anodized aluminium grille, linear, rigid „J1“ peripheral ledge „J“, natur anodized aluminium, „L“ water connection at the left side (when installing the heat exchanger closer to the window, fans to the room), „0“ trench heater with natural convection

FRK 0110 0175/0200/0250/0300/0350

TRENCH HEATERS WITH NATURAL CONVECTION



- Offices, corridors, halls, flats, winter garden
- High heating output of natural convection
- Suitable for combining with other heating systems
- Using in dry environment
- 2 pipe system



FRK 0110 0175



FRK 0110 0200

Technical data

Trench heater

Height [H]	110 mm
Width [W]	175, 200, 250, 300, 350, 425 mm
Length [L]	700-4800 mm in step 100 mm

Heat exchanger

Type	Al-Cu lamellar
Length	L-295 mm
Connection thread	2×G1/2" inner

Working conditions

Max. temperature	110 °C
Max. overpressure	1 MPa (10 bar)
Protection	IP 20
Ambient conditions	Temp. T = +2 to +40 °C Humidity Rh = 20 to 70%

Accessories per order



Manual thermostat



Room thermostat with a capillary



Electrothermal actuator



Thermostatic valve



Lockshield valve

Variants

Grilles

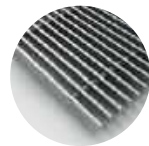

Transverse roll-up

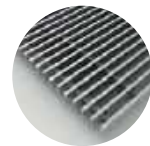

Linear

Peripheral ledges



Trench heater heating output FRK 0110 0175/0200/0250/0300/0350/0425

Q[W] 75/65/20 °C (ΔT=50 °C)

H×W [mm]	0110 0175	0110 0200	0110 0250	0110 0300	0110 0350	0110 0425
L [mm]	n=1,479	n=1,479	n=1,46	n=1,468	n=1,458	n=1,403
700	103 W	110 W	166 W	182 W	194 W	245 W
800	129 W	137 W	207 W	227 W	242 W	305 W
900	155 W	164 W	248 W	272 W	290 W	365 W
1000	180 W	191 W	289 W	316 W	338 W	425 W
1100	206 W	218 W	330 W	361 W	386 W	486 W
1200	232 W	246 W	371 W	406 W	434 W	546 W
1300	257 W	273 W	413 W	451 W	482 W	607 W
1400	283 W	300 W	454 W	496 W	530 W	667 W
1500	308 W	327 W	495 W	541 W	578 W	727 W
1600	334 W	354 W	536 W	586 W	625 W	788 W
1700	359 W	381 W	577 W	631 W	673 W	848 W
1800	385 W	408 W	618 W	676 W	721 W	908 W
1900	411 W	435 W	659 W	720 W	769 W	969 W
2000	436 W	463 W	700 W	765 W	817 W	1 029 W
2100	462 W	490 W	741 W	810 W	865 W	1 089 W
2200	487 W	517 W	782 W	855 W	913 W	1 150 W
2300	513 W	544 W	823 W	900 W	961 W	1 210 W
2400	539 W	571 W	864 W	945 W	1009 W	1 270 W
2500	564 W	598 W	905 W	990 W	1057 W	1 331 W
2600	590 W	625 W	946 W	1 035 W	1105 W	1 391 W
2700	615 W	653 W	987 W	1 080 W	1153 W	1 451 W
2800	641 W	680 W	1 028 W	1 124 W	1201 W	1 512 W
2900	667 W	707 W	1 069 W	1 169 W	1249 W	1 572 W
3000	692 W	734 W	1 110 W	1 214 W	1297 W	1 632 W
3200	743 W	788 W	1 192 W	1 304 W	1392 W	1 753 W
3400	794 W	842 W	1 275 W	1 394 W	1488 W	1 874 W
3600	846 W	897 W	1 357 W	1 484 W	1584 W	1 995 W
3800	897 W	951 W	1 439 W	1 573 W	1680 W	2 115 W
4000	948 W	1 005 W	1 521 W	1 663 W	1776 W	2 236 W
4200	999 W	1 060 W	1 603 W	1 753 W	1872 W	2 357 W
4400	1 050 W	1 114 W	1 685 W	1 843 W	1968 W	2 477 W
4600	1 101 W	1 168 W	1 767 W	1 932 W	2063 W	2 598 W
4800	1 153 W	1 222 W	1 849 W	2 022 W	2159 W	2 719 W

Q[W] 55/45/20 °C (ΔT=30 °C)

H×W [mm]	0110 0175	0110 0200	0110 0250	0110 0300	0110 0350	0110 0425
L [mm]	n=1,479	n=1,479	n=1,46	n=1,468	n=1,458	n=1,403
700	48 W	52 W	79 W	86 W	92 W	120 W
800	61 W	64 W	98 W	107 W	115 W	149 W
900	73 W	77 W	118 W	129 W	138 W	178 W
1000	85 W	90 W	137 W	149 W	160 W	208 W
1100	97 W	102 W	157 W	171 W	183 W	237 W
1200	109 W	116 W	176 W	192 W	206 W	267 W
1300	121 W	128 W	196 W	213 W	229 W	297 W
1400	133 W	141 W	215 W	234 W	252 W	326 W
1500	145 W	154 W	235 W	256 W	274 W	355 W
1600	157 W	166 W	254 W	277 W	297 W	385 W
1700	169 W	179 W	274 W	298 W	320 W	414 W
1800	181 W	192 W	293 W	319 W	342 W	444 W
1900	193 W	204 W	313 W	340 W	365 W	473 W
2000	205 W	217 W	332 W	361 W	388 W	503 W
2100	217 W	230 W	351 W	383 W	411 W	532 W
2200	229 W	243 W	371 W	404 W	434 W	562 W
2300	241 W	256 W	390 W	425 W	456 W	591 W
2400	253 W	268 W	410 W	446 W	479 W	620 W
2500	265 W	281 W	429 W	468 W	502 W	650 W
2600	277 W	294 W	449 W	489 W	525 W	679 W
2700	289 W	307 W	468 W	510 W	547 W	709 W
2800	301 W	319 W	488 W	531 W	570 W	739 W
2900	313 W	332 W	507 W	552 W	593 W	768 W
3000	325 W	345 W	526 W	574 W	616 W	797 W
3200	349 W	370 W	565 W	616 W	661 W	856 W
3400	373 W	395 W	605 W	659 W	707 W	915 W
3600	398 W	421 W	644 W	701 W	752 W	975 W
3800	421 W	447 W	683 W	743 W	798 W	1 033 W
4000	445 W	472 W	721 W	786 W	843 W	1 092 W
4200	469 W	498 W	760 W	828 W	889 W	1 151 W
4400	493 W	523 W	799 W	871 W	934 W	1 210 W
4600	517 W	549 W	838 W	913 W	980 W	1 269 W
4800	542 W	574 W	877 W	955 W	1025 W	1 328 W

75/65/20 °C → 75 °C inlet temperature, 65 °C outlet temp., 20 °C room temp. / Output 90/70/20 °C = ~ 1,29 x 75/65/20 °C / Output 70/55/20 °C = ~ 0,80 x 75/65/20 °C / Heating outputs in accordance with EN 16430 / Not listed heating outputs for lengths per 100 mm steps calculate linearly. Exact values can be found at www.isan.cz

/0425



Technical drawing

FRK 0110 0175

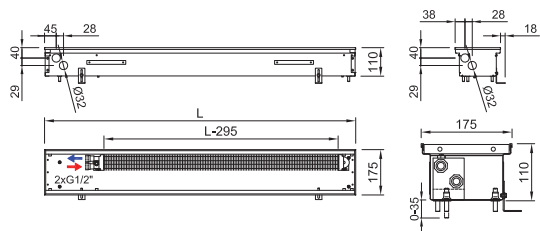

FRK 0110 0200

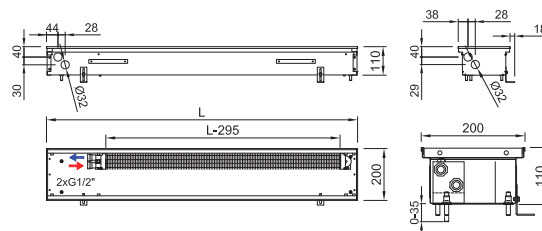

FRK 0110 0250

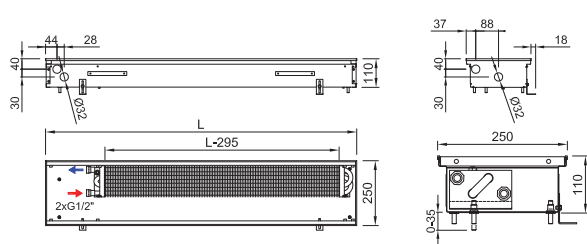

FRK 0110 0300

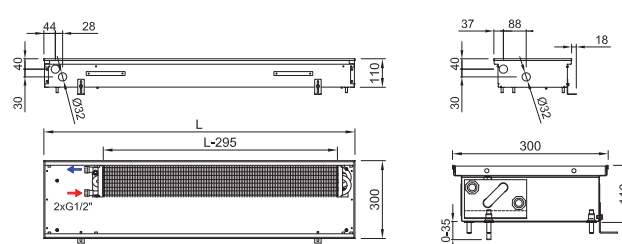

FRK 0110 0350

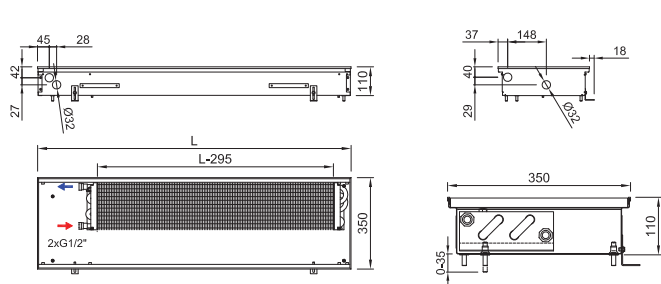

FRK 0110 0425

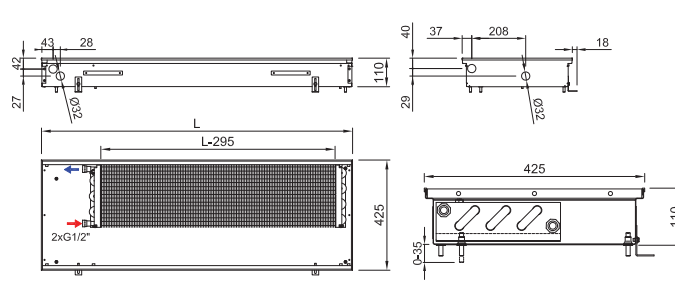

Trench heater standard equipment

Trough	Galvanized steel trough with surface finish and black spray layer inside, black cover plates of connection
Heat exchanger	Al-Cu lamellar exchanger with air vent valve, black painted
Grille	Design walkable grille according to the customer's choice (stainless grilles surcharge)
Ledge	Made of anodized aluminium, type and colour according to the customer's choice
Assembly elements	Leveling screws for setting up the trough, mounting brackets
Manual	Manual for the progress of work during installation and user manual
Wiring	Electrical wiring diagram of the trench heaters
Mounting board	Cover and the spacer particle board for easy installation
Package	Transport package for protection against damage during transportation and handling

Ⓜ Grilles → 6 Ⓜ Ledges → 8 Ⓜ Accessories → 14 Ⓜ Hydraulic parameters → 126

Connection to heating system

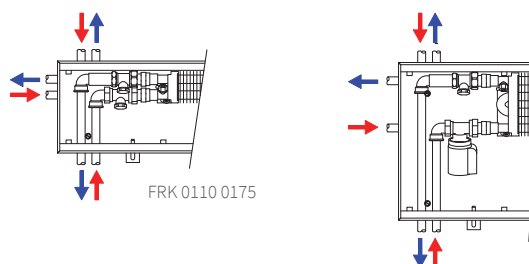

FRK 0110 0175

Code example: FRK 0110 0175 2200 C 21 J2 R - 0 / Trench heater **FRK** H=110 mm, W=175 mm, L=2 200 mm, „C“ Galvanized steel trough with black inside, heat exchanger and inner parts painted black, „21“ bronze anodized aluminium grille, transverse, roll-up, „J2“ peripheral ledge „J“, bronze anodized aluminium, „R“ water connection at the right side (when installing the heat exchanger closer to the window, fans to the room), „0“ trench heater with natural convection

FRK 0125 175/0200/0250/0300/0350

TRENCH HEATERS WITH NATURAL CONVECTION



- Offices, corridors, halls, flats, winter garden
- High heating output of natural convection
- Suitable for combining with other heating systems
- Using in dry environment
- 2pipe system

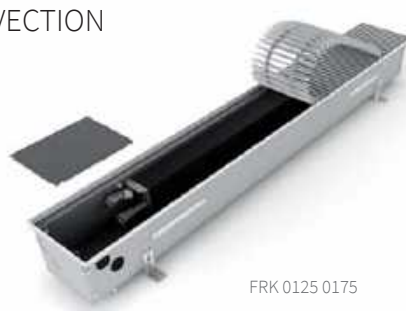

FRK 0125 0175



FRK 0125 0200

Technical data

Trench heater

Height [H]	125 mm
Width [W]	175, 200, 250, 300, 350, 425 mm
Length [L]	700-4800 mm in step 100 mm

Heat exchanger

Type	Al-Cu lamellar
Length	L-295 mm
Connection thread	2×G1/2" inner

Working conditions

Max. temperature	110 °C
Max. overpressure	1 MPa (10 bar)
Protection	IP 20
Ambient conditions	Temp. T = +2 to +40 °C Humidity Rh = 20 to 70%

Accessories per order



Manual thermostat



Room thermostat with a capillary



Electrothermal actuator



Thermostatic valve



Lockshield valve

Variants

Grilles

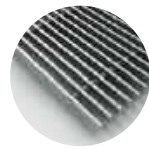

Transverse roll-up

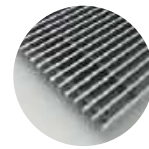

Linear

Peripheral ledges



Trench heater heating output FRK 0125 0175/0200/0250/0300/0350/0425

Q[W] 75/65/20 °C (ΔT=50 °C)

H×W [mm]	0125 0175	0125 0200	0125 0250	0125 0300	0125 0350	0125 0425
L [mm]	n=1,483	n=1,485	n=1,457	n=1,369	n=1,421	n=1,403
700	107 W	112 W	188 W	213 W	266 W	319 W
800	134 W	140 W	235 W	266 W	332 W	398 W
900	161 W	168 W	281 W	319 W	398 W	477 W
1000	187 W	196 W	328 W	372 W	464 W	556 W
1100	214 W	224 W	374 W	424 W	530 W	635 W
1200	240 W	251 W	421 W	477 W	596 W	714 W
1300	267 W	279 W	467 W	530 W	661 W	793 W
1400	293 W	307 W	514 W	583 W	727 W	872 W
1500	320 W	335 W	560 W	635 W	793 W	951 W
1600	346 W	363 W	607 W	688 W	859 W	1 030 W
1700	373 W	390 W	653 W	741 W	925 W	1 109 W
1800	399 W	418 W	700 W	793 W	990 W	1 187 W
1900	426 W	446 W	746 W	846 W	1056 W	1 266 W
2000	452 W	474 W	793 W	899 W	1122 W	1 345 W
2100	479 W	501 W	839 W	952 W	1188 W	1 424 W
2200	505 W	529 W	886 W	1 004 W	1254 W	1 503 W
2300	532 W	557 W	932 W	1 057 W	1320 W	1 582 W
2400	559 W	585 W	978 W	1 110 W	1385 W	1 661 W
2500	585 W	613 W	1 025 W	1 162 W	1451 W	1 740 W
2600	612 W	640 W	1 071 W	1 215 W	1517 W	1 819 W
2700	638 W	668 W	1 118 W	1 268 W	1583 W	1 898 W
2800	665 W	696 W	1 164 W	1 321 W	1649 W	1 977 W
2900	691 W	724 W	1 211 W	1 373 W	1714 W	2 055 W
3000	718 W	751 W	1 257 W	1 426 W	1780 W	2 134 W
3200	771 W	807 W	1 350 W	1 531 W	1912 W	2 292 W
3400	824 W	863 W	1 443 W	1 637 W	2043 W	2 450 W
3600	877 W	918 W	1 536 W	1 742 W	2175 W	2 608 W
3800	930 W	974 W	1 629 W	1 848 W	2307 W	2 766 W
4000	983 W	1 029 W	1 722 W	1 953 W	2438 W	2 923 W
4200	1 036 W	1 085 W	1 815 W	2 059 W	2570 W	3 081 W
4400	1 089 W	1 140 W	1 908 W	2 164 W	2702 W	3 239 W
4600	1 142 W	1 196 W	2 001 W	2 270 W	2833 W	3 397 W
4800	1 195 W	1 252 W	2 094 W	2 375 W	2965 W	3 555 W

Q[W] 55/45/20 °C (ΔT=30 °C)

H×W [mm]	0125 0175	0125 0200	0125 0250	0125 0300	0125 0350	0125 0425
L [mm]	n=1,483	n=1,485	n=1,457	n=1,369	n=1,421	n=1,403
700	50 W	52 W	89 W	106 W	129 W	156 W
800	63 W	66 W	112 W	132 W	161 W	194 W
900	75 W	79 W	134 W	159 W	193 W	233 W
1000	88 W	92 W	156 W	185 W	225 W	272 W
1100	100 W	105 W	178 W	211 W	256 W	310 W
1200	112 W	118 W	200 W	237 W	288 W	349 W
1300	125 W	131 W	222 W	263 W	320 W	387 W
1400	137 W	144 W	244 W	290 W	352 W	426 W
1500	150 W	157 W	266 W	316 W	384 W	464 W
1600	162 W	170 W	288 W	342 W	416 W	503 W
1700	175 W	183 W	310 W	368 W	448 W	542 W
1800	187 W	196 W	333 W	394 W	479 W	580 W
1900	200 W	209 W	354 W	420 W	511 W	618 W
2000	212 W	222 W	377 W	447 W	543 W	657 W
2100	225 W	235 W	399 W	473 W	575 W	695 W
2200	237 W	248 W	421 W	499 W	607 W	734 W
2300	249 W	261 W	443 W	525 W	639 W	773 W
2400	262 W	274 W	465 W	552 W	670 W	811 W
2500	274 W	287 W	487 W	577 W	702 W	850 W
2600	287 W	300 W	509 W	604 W	734 W	888 W
2700	299 W	313 W	531 W	630 W	766 W	927 W
2800	312 W	326 W	553 W	656 W	798 W	966 W
2900	324 W	339 W	575 W	682 W	829 W	1 004 W
3000	337 W	352 W	597 W	709 W	861 W	1 042 W
3200	361 W	378 W	641 W	761 W	925 W	1 119 W
3400	386 W	404 W	686 W	814 W	989 W	1 197 W
3600	411 W	430 W	730 W	866 W	1052 W	1 274 W
3800	436 W	456 W	774 W	918 W	1116 W	1 351 W
4000	461 W	482 W	818 W	971 W	1180 W	1 428 W
4200	486 W	508 W	862 W	1 023 W	1244 W	1 505 W
4400	510 W	534 W	907 W	1 075 W	1307 W	1 582 W
4600	535 W	560 W	951 W	1 128 W	1371 W	1 659 W
4800	560 W	586 W	995 W	1 180 W	1435 W	1 736 W

75/65/20 °C → 75 °C inlet temperature, 65 °C outlet temp., 20 °C room temp. / Output 90/70/20 °C = ~ 1,29 x 75/65/20 °C / Output 70/55/20 °C = ~ 0,80 x 75/65/20 °C / Heating outputs in accordance with EN 16430 / Not listed heating output for lengths per 100 mm steps calculate linearly. Exact values can be found at www.isan.cz

/0425



Technical drawing

FRK 0125 0175

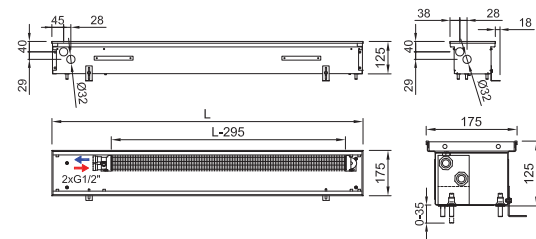

FRK 0125 0200

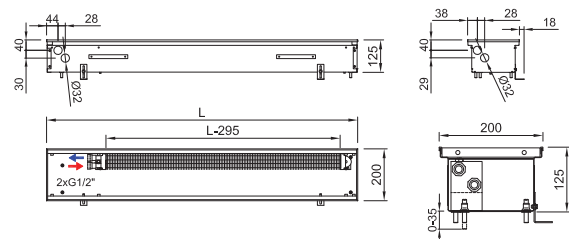

FRK 0125 0250

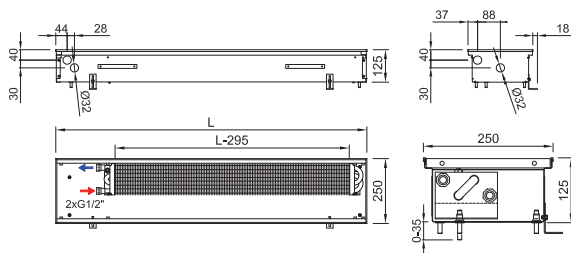

FRK 0125 0300

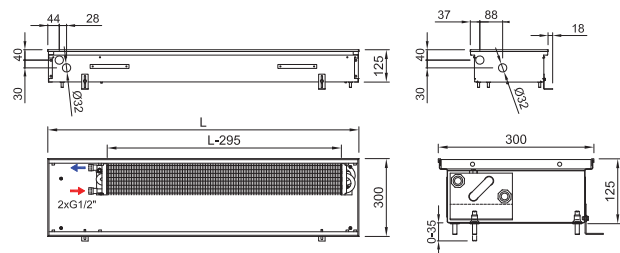

FRK 0125 0350

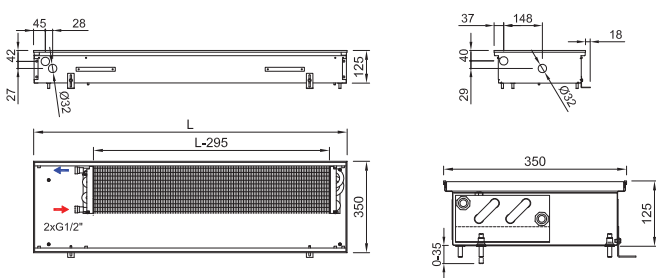

FRK 0125 0425

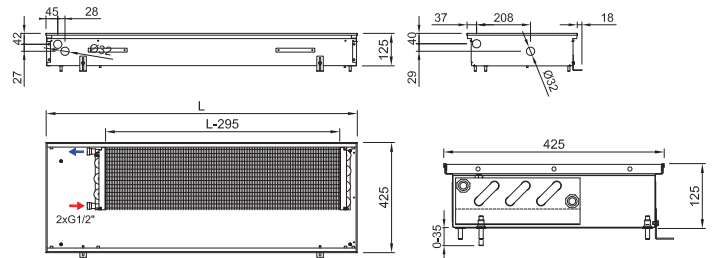

Trench heater standard equipment

- Trough** Galvanized steel trough with surface finish and black spray layer inside, black cover plates of connection
- Heat exchanger** Al-Cu lamellar exchanger with air vent valve, black painted
- Grille** Design walkable grille according to the customer's choice (stainless grilles surcharge)
- Ledge** Made of anodized aluminium, type and colour according to the customer's choice
- Assembly elements** Leveling screws for setting up the trough, mounting brackets
- Manual** Manual for the progress of work during installation and user manual
- Wiring** Electrical wiring diagram of the trench heaters
- Mounting board** Cover and the spacer particle board for easy installation
- Package** Transport package for protection against damage during transportation and handling

- Ⓜ Grilles → 6
- Ⓛ Ledges → 8
- ⊕ Accessories → 14
- Ⓞ Hydraulic parameters → 126

Connection to heating system

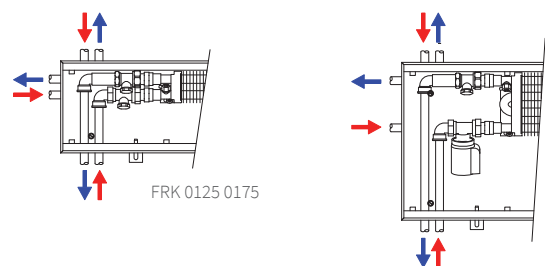

Code example: FRK 0125 0250 1500 C 62 L2 L - 0 / Trench heater FRK H=125 mm, W=250 mm, L=1 500 mm, „C“ Galvanized steel trough with black inside, heat exchanger and inner parts painted black, „62“ stained beech grille, transverse, roll-up, „L2“ peripheral ledge „L“ with an overlap, bronze anodized aluminium, „L“ water connection at the left side (when installing the heat exchanger closer to the window, fans to the room), „0“ trench heater with natural convection

FRK 0140 0175/0200/0250/0300/0350

TRENCH HEATERS WITH NATURAL CONVECTION



- Offices, corridors, halls, flats, winter garden
- High heating output of natural convection
- Suitable for combining with other heating systems
- Using in dry environment
- 2 pipe system



FRK 0140 0175



FRK 0140 0200

Technical data

Trench heater

Height [H] **140 mm**
 Width [W] **175, 200, 250, 300, 350, 425 mm**
 Length [L] **L = 700–4 800 mm**
in step 100 mm

Heat exchanger

Type **Al-Cu lamellar**
 Length **L–295 mm**
 Connection thread **2×G1/2" inner**

Working conditions

Max. temperature **110 °C**
 Max. overpressure **1 MPa (10 bar)**
 Protection **IP 20**
 Ambient conditions **Temp. T = +2 to +40 °C**
Humidity Rh = 20 to 70%

Accessories per order



Manual thermostat



Room thermostat with a capillary



Electrothermal actuator



Thermostatic valve



Lockshield valve

Variants

Grilles

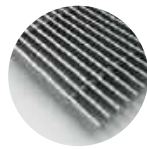

Transverse roll-up

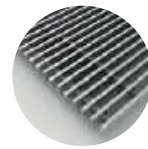

Linear

Peripheral ledges



Trench heater heating output FRK 0140 0175/0200/0250/0300/0350/0425

Q[W] 75/65/20 °C (ΔT=50 °C)

H×W [mm]	0140 0175	0140 0200	0140 0250	0140 0300	0140 0350	0140 0425
L [mm]	n=1,495	n=1,496	n=1,443	n=1,453	n=1,452	n=1,403
700	111 W	116 W	200 W	223 W	276 W	354 W
800	138 W	145 W	249 W	278 W	344 W	441 W
900	165 W	174 W	298 W	333 W	412 W	528 W
1000	192 W	203 W	347 W	389 W	481 W	615 W
1100	220 W	231 W	396 W	444 W	549 W	703 W
1200	247 W	260 W	446 W	499 W	617 W	790 W
1300	274 W	289 W	495 W	554 W	685 W	877 W
1400	301 W	317 W	544 W	609 W	753 W	964 W
1500	329 W	346 W	593 W	664 W	822 W	1 052 W
1600	356 W	375 W	642 W	719 W	890 W	1 139 W
1700	383 W	404 W	692 W	774 W	958 W	1 226 W
1800	411 W	432 W	741 W	829 W	1026 W	1 314 W
1900	438 W	461 W	790 W	885 W	1094 W	1 401 W
2000	465 W	490 W	839 W	940 W	1162 W	1 488 W
2100	492 W	519 W	889 W	995 W	1231 W	1 575 W
2200	520 W	547 W	938 W	1 050 W	1299 W	1 663 W
2300	547 W	576 W	987 W	1 105 W	1367 W	1 750 W
2400	574 W	605 W	1 036 W	1 160 W	1435 W	1 837 W
2500	602 W	633 W	1 085 W	1 215 W	1503 W	1 925 W
2600	629 W	662 W	1 135 W	1 270 W	1572 W	2 012 W
2700	656 W	691 W	1 184 W	1 325 W	1640 W	2 099 W
2800	683 W	720 W	1 233 W	1 381 W	1708 W	2 186 W
2900	711 W	748 W	1 282 W	1 436 W	1776 W	2 274 W
3000	738 W	777 W	1 332 W	1 491 W	1844 W	2 361 W
3200	793 W	835 W	1 430 W	1 601 W	1981 W	2 536 W
3400	847 W	892 W	1 528 W	1 711 W	2117 W	2 710 W
3600	902 W	949 W	1 627 W	1 821 W	2253 W	2 885 W
3800	956 W	1 007 W	1 725 W	1 932 W	2390 W	3 059 W
4000	1 011 W	1 064 W	1 824 W	2 042 W	2526 W	3 234 W
4200	1 065 W	1 122 W	1 922 W	2 152 W	2662 W	3 408 W
4400	1 120 W	1 179 W	2 021 W	2 262 W	2799 W	3 583 W
4600	1 174 W	1 237 W	2 119 W	2 373 W	2935 W	3 757 W
4800	1 229 W	1 294 W	2 218 W	2 483 W	3071 W	3 932 W

Q[W] 55/45/20 °C (ΔT=30 °C)

H×W [mm]	0140 0175	0140 0200	0140 0250	0140 0300	0140 0350	0140 0425
L [mm]	n=1,495	n=1,496	n=1,443	n=1,453	n=1,452	n=1,403
700	52 W	54 W	96 W	106 W	131	173 W
800	64 W	68 W	119 W	132 W	164	215 W
900	77 W	81 W	143 W	159 W	196	258 W
1000	89 W	95 W	166 W	185 W	229	300 W
1100	103 W	108 W	189 W	211 W	261	343 W
1200	115 W	121 W	213 W	238 W	294	386 W
1300	128 W	135 W	237 W	264 W	326	428 W
1400	140 W	148 W	260 W	290 W	359	471 W
1500	153 W	161 W	284 W	316 W	392	514 W
1600	166 W	175 W	307 W	342 W	424	556 W
1700	179 W	188 W	331 W	368 W	456	599 W
1800	192 W	201 W	355 W	395 W	489	642 W
1900	204 W	215 W	378 W	421 W	521	684 W
2000	217 W	228 W	401 W	447 W	553	727 W
2100	229 W	242 W	425 W	474 W	586	769 W
2200	242 W	255 W	449 W	500 W	619	812 W
2300	255 W	268 W	472 W	526 W	651	854 W
2400	268 W	282 W	496 W	552 W	683	897 W
2500	281 W	295 W	519 W	578 W	716	940 W
2600	293 W	308 W	543 W	604 W	749	982 W
2700	306 W	322 W	567 W	631 W	781	1 025 W
2800	318 W	335 W	590 W	657 W	814	1 067 W
2900	331 W	348 W	613 W	684 W	846	1 110 W
3000	344 W	362 W	637 W	710 W	878	1 153 W
3200	370 W	389 W	684 W	762 W	944	1 238 W
3400	395 W	415 W	731 W	814 W	1008	1 323 W
3600	420 W	442 W	778 W	867 W	1073	1 409 W
3800	446 W	469 W	825 W	920 W	1138	1 494 W
4000	471 W	495 W	873 W	972 W	1203	1 579 W
4200	496 W	522 W	920 W	1 024 W	1268	1 664 W
4400	522 W	549 W	967 W	1 077 W	1333	1 749 W
4600	547 W	576 W	1 014 W	1 129 W	1398	1 834 W
4800	573 W	603 W	1 061 W	1 182 W	1463	1 920 W

75/65/20 °C → 75 °C inlet temperature, 65 °C outlet temp., 20 °C room temp. / Output 90/70/20 °C = ~ 1,29 x 75/65/20 °C / Output 70/55/20 °C = ~ 0,80 x 75/65/20 °C / Heating outputs in accordance with EN 16430 / Not listed heating output for lengths per 100 mm steps calculate linearly. Exact values can be found at www.isan.cz

/0425



Technical drawing

FRK 0140 0175

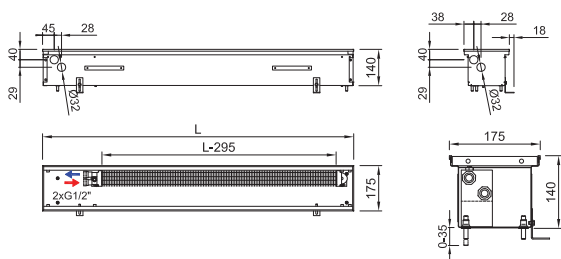

FRK 0140 0200

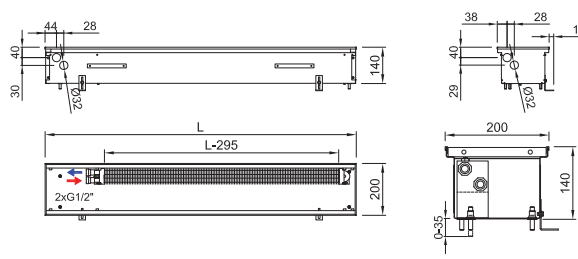

FRK 0140 0250

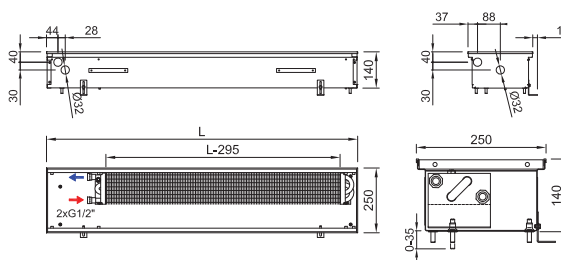

FRK 0140 0300

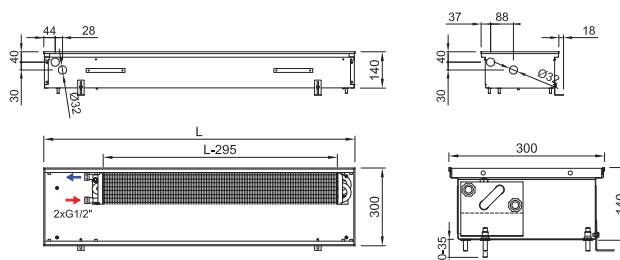

FRK 0140 0350

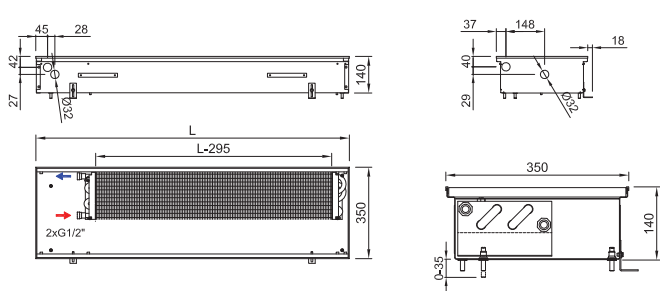

FRK 0140 0425

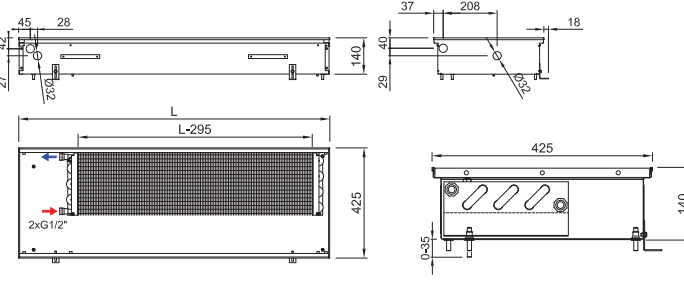

Trench heater standard equipment

- Trough** Galvanized steel trough with surface finish and black spray layer inside, black cover plates of connection
- Heat exchanger** Al-Cu lamellar exchanger with air vent valve, black painted
- Grille** Design walkable grille according the customer's choice (stainless grilles surcharge)
- Ledge** Made of anodized aluminium, type and colour according the customer's choice
- Assembly elements** Leveling screws for setting up the trough, mounting brackets
- Manual** Manual for the progress of work during installation and user manual
- Wiring** Electrical wiring diagram of the trench heaters
- Mounting board** Cover and the spacer particle board for easy installation
- Package** Transport package for protection against damage during transportation and handling

- Ⓜ Grilles → 6
- Ⓛ Ledges → 8
- ⊕ Accessories → 14
- Ⓞ Hydraulic parameters → 126

Connection to heating system

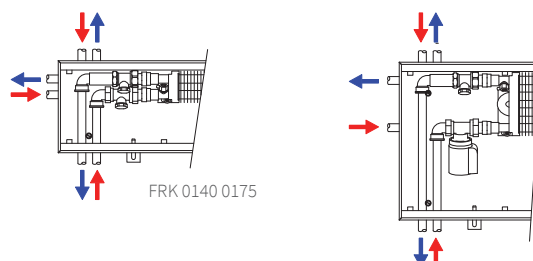

Code example: FRK 0140 0425 1400 C 63 L1 L - 0 / Trench heater FRK H=140 mm, W=425 mm, L= 1 400 mm, „C“ Galvanized steel trough with black inside, heat exchanger and inner parts painted black, „63“ natural oak grille, transverse, roll-up, „L1“ peripheral ledge „L“ with an overlap, natur anodized aluminium „L“ water connection at the left side (when installing the heat exchanger closer to the window, fans to the room), „0“ trench heater with natural convection

FRK 0165 0300/0350/0425

TRENCH HEATERS WITH NATURAL CONVECTION



FRK 0165 0300



- Offices, corridors, halls, flats, winter garden
- High heating output of natural convection
- Suitable for combining with other heating systems
- Using in dry environment
- 2pipe system

Technical data

Trench heater

Height [H]	165 mm
Width [W]	300, 350, 425 mm
Length [L]	700-4800 mm in step 100 mm

Heat exchanger

Type	Al-Cu lamellar
Length	L-295 mm
Connection thread	2xG1/2" inner

Working conditions

Max. temperature	110 °C
Max. overpressure	1 MPa (10 bar)
Protection	IP 20
Ambient conditions	Temp. T = +2 to +40 °C Humidity Rh = 20 to 70%

Accessories per order



Manual thermostat



Room thermostat with a capillary



Electrothermal actuator



Thermostatic valve



Lockshield valve

Variants

Grilles

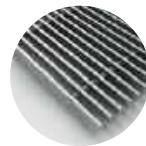

Transverse roll-up

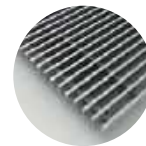

Linear

Peripheral ledges



Trench heater heating output FRK 0165 0300/0350/0425

Q[W] 75/65/20 °C (ΔT=50 °C)

HxW [mm] L [mm]	0165 0300 n=1,457	0165 0350 n=1,449	0165 0425 n=1,442	0140 0300 n=1,453
700	233 W	292 W	401 W	223 W
800	291 W	365 W	500 W	278 W
900	349 W	437 W	599 W	333 W
1000	406 W	509 W	698 W	389 W
1100	464 W	581 W	797 W	444 W
1200	521 W	654 W	896 W	499 W
1300	579 W	726 W	995 W	554 W
1400	637 W	798 W	1 094 W	609 W
1500	694 W	870 W	1 193 W	664 W
1600	752 W	942 W	1 292 W	719 W
1700	809 W	1 015 W	1 391 W	774 W
1800	867 W	1 087 W	1 490 W	829 W
1900	925 W	1 159 W	1 589 W	885 W
2000	982 W	1 231 W	1 688 W	940 W
2100	1 040 W	1 304 W	1 787 W	995 W
2200	1 097 W	1 376 W	1 886 W	1 050 W
2300	1 155 W	1 448 W	1 985 W	1 105 W
2400	1 213 W	1 520 W	2 084 W	1 160 W
2500	1 270 W	1 592 W	2 183 W	1 215 W
2600	1 328 W	1 665 W	2 282 W	1 270 W
2700	1 385 W	1 737 W	2 381 W	1 325 W
2800	1 443 W	1 809 W	2 480 W	1 381 W
2900	1 501 W	1 881 W	2 579 W	1 436 W
3000	1 558 W	1 954 W	2 678 W	1 491 W
3200	1 673 W	2 098 W	2 876 W	1 601 W
3400	1 789 W	2 242 W	3 074 W	1 711 W
3600	1 904 W	2 387 W	3 272 W	1 821 W
3800	2 019 W	2 531 W	3 470 W	1 932 W
4000	2 134 W	2 676 W	3 668 W	2 042 W
4200	2 250 W	2 820 W	3 866 W	2 152 W
4400	2 365 W	2 965 W	4 064 W	2 262 W
4600	2 480 W	3 109 W	4 262 W	2 373 W
4800	2 595 W	3 253 W	4 460 W	2 483 W

Q[W] 55/45/20 °C (ΔT=30 °C)

HxW [mm] L [mm]	0165 0300 n=1,457	0165 0350 n=1,449	0165 0425 n=1,442
700	111 W	139 W	192 W
800	138 W	174 W	239 W
900	166 W	208 W	287 W
1000	193 W	243 W	334 W
1100	220 W	277 W	382 W
1200	248 W	312 W	429 W
1300	275 W	346 W	476 W
1400	303 W	381 W	524 W
1500	330 W	415 W	571 W
1600	357 W	449 W	619 W
1700	384 W	484 W	666 W
1800	412 W	519 W	713 W
1900	440 W	553 W	761 W
2000	467 W	587 W	808 W
2100	494 W	622 W	856 W
2200	521 W	656 W	903 W
2300	549 W	691 W	950 W
2400	576 W	725 W	998 W
2500	603 W	759 W	1 045 W
2600	631 W	794 W	1 093 W
2700	658 W	829 W	1 140 W
2800	686 W	863 W	1 187 W
2900	713 W	897 W	1 235 W
3000	740 W	932 W	1 282 W
3200	795 W	1 001 W	1 377 W
3400	850 W	1 069 W	1 472 W
3600	905 W	1 139 W	1 567 W
3800	959 W	1 207 W	1 661 W
4000	1 014 W	1 277 W	1 756 W
4200	1 069 W	1 345 W	1 851 W
4400	1 124 W	1 414 W	1 946 W
4600	1 178 W	1 483 W	2 041 W
4800	1 233 W	1 552 W	2 135 W

75/65/20 °C → 75 °C inlet temperature, 65 °C outlet temp., 20 °C room temp. / Output 90/70/20 °C = ~ 1,29 x 75/65/20 °C / Output 70/55/20 °C = ~ 0,80 x 75/65/20 °C / Heating outputs in accordance with EN 16430 / Not listed heating outputs for lengths per 100 mm steps calculate linearly. Exact values can be found at www.isan.cz



FRK 0165 0350



FRK 0165 0425

Technical drawing

FRK 0165 0300

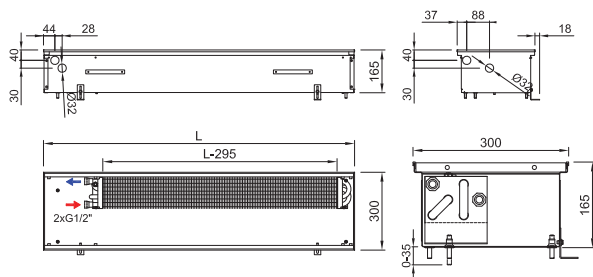

FRK 0165 0350

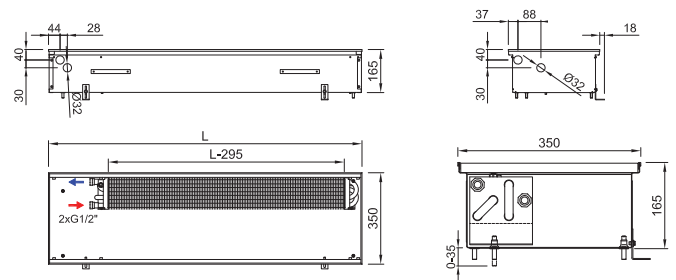

FRK 0165 0425

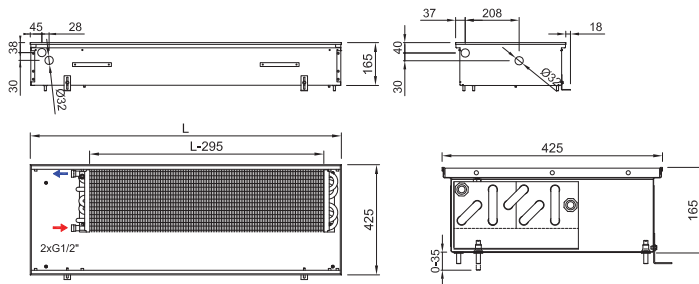

Trench heater standard equipment

Trough	Galvanized steel trough with surface finish and black spray layer inside, black cover plates of connection
Heat exchanger	Al-Cu lamellar exchanger with air vent valve, black painted
Grille	Design walkable grille according to the customer's choice (stainless grilles surcharge)
Ledge	Made of anodized aluminium, type and colour according to the customer's choice
Assembly elements	Leveling screws for setting up the trough, mounting brackets
Manual	Manual for the progress of work during installation and user manual
Wiring	Electrical wiring diagram of the trench heaters
Mounting board	Cover and the spacer particle board for easy installation
Package	Transport package for protection against damage during transportation and handling

Connection to heating system

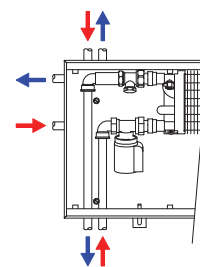

ⓘ Grilles → 6 ⓘ Ledges → 8 ⓘ Accessories → 14 ⓘ Hydraulic parameters → 126

Code example: FRK 0165 0300 1900 C 52 J1 R - 0 / Trench heater FRK H=165 mm, W= 300 mm, L= 1900 mm, „C“ Galvanized steel trough with black inside, heat exchanger and inner parts painted black, „52“ stainless grille, transverse, roll-up, „J1“ peripheral ledge „J“, natur anodized aluminium, „R“ water connection at the right side (when installing the heat exchanger closer to the window, fans to the room), „0“ trench heater with natural convection

FRK 0200 0300/0350/0425

TRENCH HEATERS WITH NATURAL CONVECTION



FRK 0200 0300



- Offices, corridors, halls, flats, winter garden
- High heating output of natural convection
- Suitable for combining with other heating systems
- Using in dry environment
- 2pipe system

Technical data

Trench heater

Height [H] **200 mm**
 Width [W] **300, 350, 425 mm**
 Length [L] **700-4800 mm**
in step 100 mm

Heat exchanger

Type **Al-Cu lamellar**
 Length **L-295 mm**
 Connection thread **2xG1/2" inner**

Working conditions

Max. temperature **110 °C**
 Max. overpressure **1 MPa (10 bar)**
 Protection **IP 20**
 Ambient conditions **Temp. T = +2 to +40 °C**
Humidity Rh = 20 to 70%

Accessories per order



Variants

Grilles

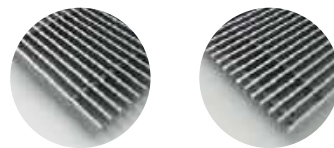

Transverse roll-up

Linear

Peripheral ledges



Trench heater heating output FRK 0200 0300/0350/0425

Q[W] 75/65/20 °C (ΔT=50 °C)

H×W [mm] L [mm]	0200 0300 n=1,462	0200 0350 n=1,457	0200 0425 n=1,461	0140 0300 n=1,453
700	237 W	319 W	435 W	223 W
800	296 W	397 W	542 W	278 W
900	354 W	476 W	649 W	333 W
1000	413 W	554 W	756 W	389 W
1100	471 W	633 W	864 W	444 W
1200	530 W	711 W	971 W	499 W
1300	588 W	790 W	1 078 W	554 W
1400	647 W	869 W	1 185 W	609 W
1500	706 W	947 W	1 293 W	664 W
1600	764 W	1026 W	1 400 W	719 W
1700	823 W	1104 W	1 507 W	774 W
1800	881 W	1183 W	1 615 W	829 W
1900	940 W	1262 W	1 722 W	885 W
2000	998 W	1340 W	1 829 W	940 W
2100	1 057 W	1419 W	1 936 W	995 W
2200	1 115 W	1497 W	2 044 W	1 050 W
2300	1 174 W	1576 W	2 151 W	1 105 W
2400	1 233 W	1655 W	2 258 W	1 160 W
2500	1 291 W	1733 W	2 366 W	1 215 W
2600	1 350 W	1812 W	2 473 W	1 270 W
2700	1 408 W	1890 W	2 580 W	1 325 W
2800	1 467 W	1969 W	2 687 W	1 381 W
2900	1 525 W	2048 W	2 795 W	1 436 W
3000	1 584 W	2126 W	2 902 W	1 491 W
3200	1 701 W	2283 W	3 117 W	1 601 W
3400	1 818 W	2441 W	3 331 W	1 711 W
3600	1 935 W	2598 W	3 546 W	1 821 W
3800	2 052 W	2755 W	3 760 W	1 932 W
4000	2 169 W	2912 W	3 975 W	2 042 W
4200	2 287 W	3069 W	4 189 W	2 152 W
4400	2 404 W	3227 W	4 404 W	2 262 W
4600	2 521 W	3384 W	4 618 W	2 373 W
4800	2 638 W	3541 W	4 833 W	2 483 W

Q[W] 55/45/20 °C (ΔT=30 °C)

H×W [mm] L [mm]	0200 0300 n=1,462	0200 0350 n=1,457	0200 0425 n=1,461
700	112 W	152 W	206 W
800	140 W	189 W	257 W
900	168 W	226 W	308 W
1000	196 W	263 W	358 W
1100	223 W	301 W	410 W
1200	251 W	338 W	460 W
1300	279 W	375 W	511 W
1400	307 W	413 W	562 W
1500	335 W	450 W	613 W
1600	362 W	487 W	664 W
1700	390 W	524 W	715 W
1800	417 W	562 W	766 W
1900	445 W	600 W	816 W
2000	473 W	637 W	867 W
2100	501 W	674 W	918 W
2200	528 W	711 W	969 W
2300	556 W	749 W	1 020 W
2400	584 W	786 W	1 071 W
2500	612 W	823 W	1 122 W
2600	640 W	861 W	1 173 W
2700	667 W	898 W	1 223 W
2800	695 W	935 W	1 274 W
2900	723 W	973 W	1 325 W
3000	751 W	1010 W	1 376 W
3200	806 W	1085 W	1 478 W
3400	861 W	1160 W	1 579 W
3600	917 W	1234 W	1 681 W
3800	972 W	1309 W	1 783 W
4000	1 028 W	1383 W	1 885 W
4200	1 084 W	1458 W	1 986 W
4400	1 139 W	1533 W	2 088 W
4600	1 194 W	1608 W	2 190 W
4800	1 250 W	1682 W	2 291 W

75/65/20 °C → 75 °C inlet temperature, 65 °C outlet temp., 20 °C room temp. / Output 90/70/20 °C = ~ 1,29 x 75/65/20 °C / Output 70/55/20 °C = ~ 0,80 x 75/65/20 °C / Heating outputs in accordance with EN 16430 / Not listed heating outputs for lengths per 100 mm steps calculate linearly. Exact values can be found at www.isan.cz



FRK 0200 0350



FRK 0200 0425

Technical drawing

FRK 0200 0300

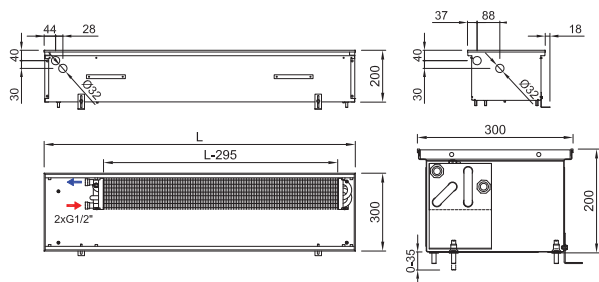

FRK 0200 0350

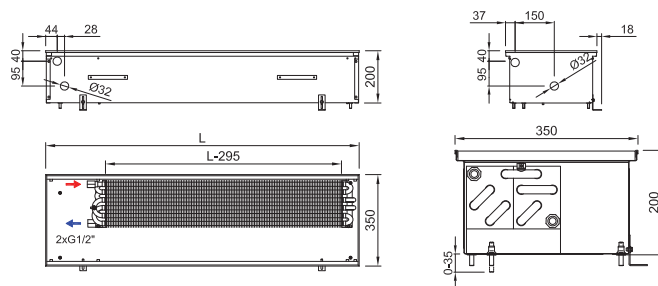

FRK 0200 0425

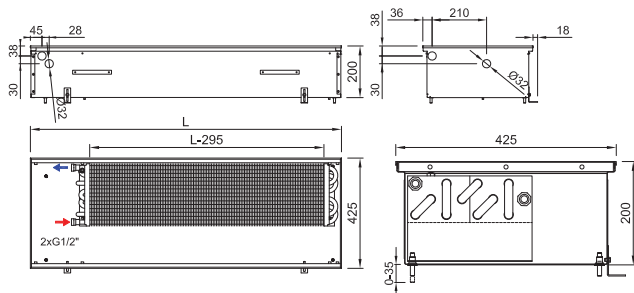

Trench heater standard equipment

Trough	Galvanized steel trough with surface finish and black spray layer inside, black cover plates of connection
Heat exchanger	Al-Cu lamellar exchanger with air vent valve, black painted
Grille	Design walkable grille according the customer's choice (stainless grilles surcharge)
Ledge	Made of anodized aluminium, type and colour according the customer's choice
Assembly elements	Leveling screws for setting up the trough, mounting brackets
Manual	Manual for the progress of work during installation and user manual
Wiring	Electrical wiring diagram of the trench heaters
Mounting board	Cover and the spacer particle board for easy installation
Package	Transport package for protection against damage during transportation and handling

Connection to heating system

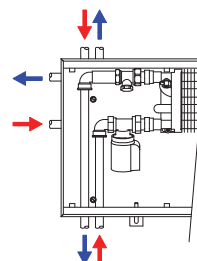

ⓘ Grilles → 6 ⓘ Ledges → 8 ⓘ Accessories → 14 ⓘ Hydraulic parameters → 126

Code example: FRK 0200 0425 1500 C 62 L2 L - 0 / Trench heater **FRK** H=200 mm, W= 425 mm, L= 1 500 mm, „C“ Galvanized steel trough with black inside, heat exchanger and inner parts painted black, „62“ stained beech grille, transverse, roll-up, „L2“ peripheral ledge „L“ with an overlap, bronze anodized aluminium, „L“ water connection at the left side (when installing the heat exchanger closer to the window, fans to the room), „0“ trench heater with natural convection

FRM

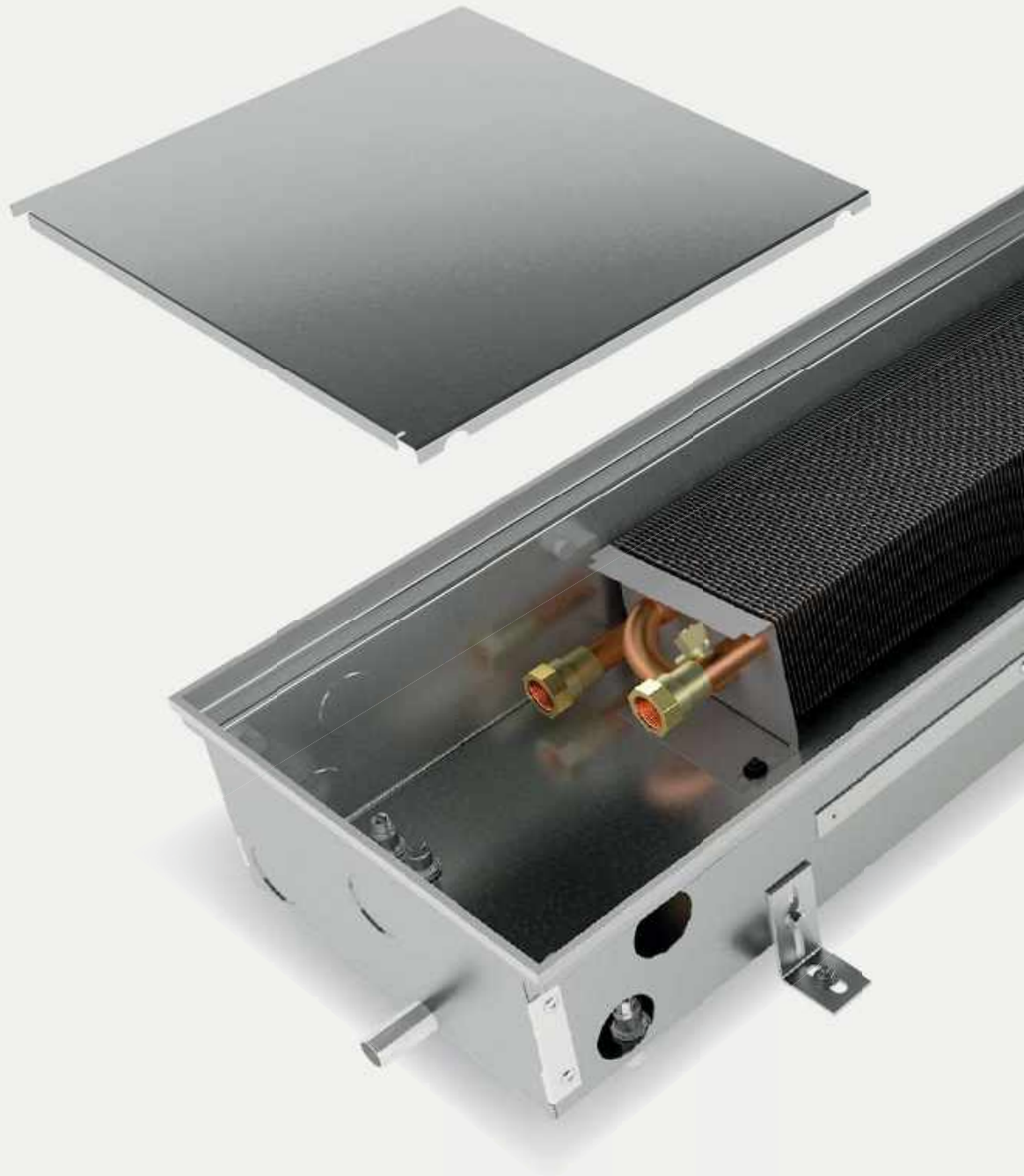



Trench heaters with **natural convection and lamellar exchanger, humid environment, heating**

TERMO - FRM



Heaters with natural convection for a humid environment

Advantages

- Conservatories, greenhouses, bathrooms, saunas
- Garage, warehouses, halls, stadiums
- Not intended for swimming pools to be submerged
- High heater output
- Suitable combination with other types of heating
- Humid environment
- 2 pipe system
- Length **700-4 800 mm** (in step 100 mm)



FRM trench heaters are constructed to be used in conditions with higher moisture and possible water condensation. The heater structure is made of stainless steel resistant even to an aggressive environment and fitted with small drainage tubes along its sides.

The heater is not designed to be used in aggressive environments of pools where it can become submerged, aggressive environments with a higher concentration of chlorine or environments containing salts.

The range of FRM models with natural convection for a humid environment

Height	80 mm	90 mm	110 mm	125 mm	140 mm	165 mm	200 mm
Width	-	175 mm	175 mm	175 mm	175 mm	-	-
	-	200 mm	200 mm	200 mm	200 mm	-	-
	250 mm	250 mm	250 mm	250 mm	250 mm	-	-
	300 mm	300 mm	300 mm	300 mm	300 mm	300 mm	300 mm
	-	325 mm	325 mm	325 mm	325 mm	325 mm	325 mm
	-	425 mm	425 mm	425 mm	425 mm	425 mm	425 mm

Trench heater standard equipment

Trough	Trough of stainless steel DIN 1,4404, unpainted
Heat exchanger	Al-Cu lamellar exchanger with air vent valve, unpainted
Grille	Design walkable grille according to the customer's choice (stainless grilles surcharge); wooden grilles must be provided with appropriate surface finish
Ledge	Made of anodized aluminium, type and colour according to the customer's choice
Fan	Fans 24 V DC with EC motors with higher protection grade, suitable for humid environments
Assembly elements	Leveling screws for setting up the trough, mounting brackets
Manual	Manual for the progress of work during installation and user manual
Wiring	Electrical wiring diagram of the trench heaters
Mounting board	Cover and the spacer particle board for easy installation
Package	Transport package for protection against damage during transportation and handling

Accessories per order



Grilles

Non-corroding metal grilles are most frequently used in a damp environment. If a wooden grille is chosen, its surface must be treated accordingly.

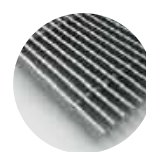

FRM an overview of trench heaters with natural convection

175

200

250

300

350

425

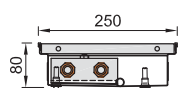

FRM 0080 0250

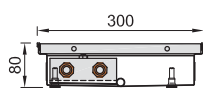

FRM 0080 0300

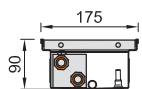

FRM 0090 0175

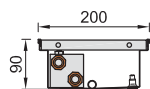

FRM 0090 0200

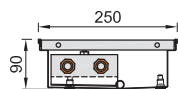

FRM 0090 0250

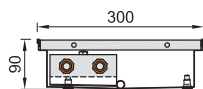

FRM 0090 0300

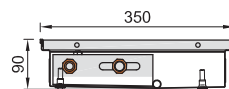

FRM 0090 0350

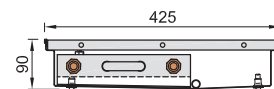

FRM 0090 0425

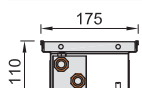

FRM 0110 00175

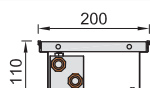

FRM 0110 0200

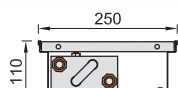

FRM 0110 0250

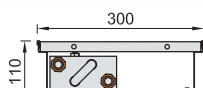

FRM 0110 0300

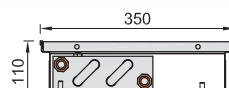

FRM 0110 0350



FRM 0110 0425

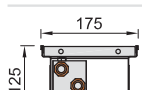

FRM 0125 0175

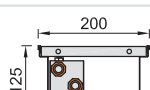

FRM 0125 0200

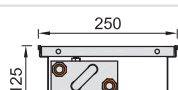

FRM 0125 0250

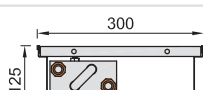

FRM 0125 0300

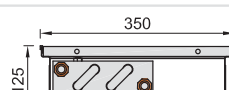

FRM 0125 0350



FRM 0125 0425

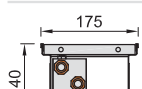

FRM 0140 0175

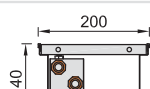

FRM 0140 0200

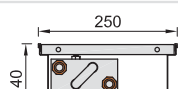

FRM 0140 0250

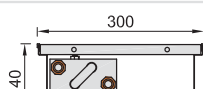

FRM 0140 0300

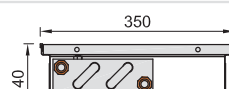

FRM 0140 0350

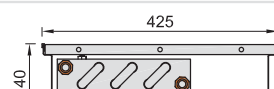

FRM 0140 0425

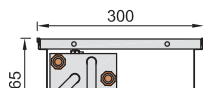

FRM 0165 0300

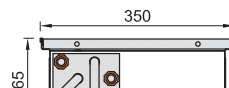

FRM 0165 0350



FRM 0165 0425

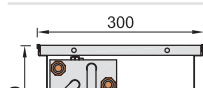

FRM 0200 0300



FRM 0200 0350

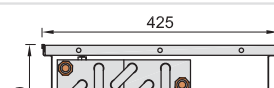

FRM 0200 0425

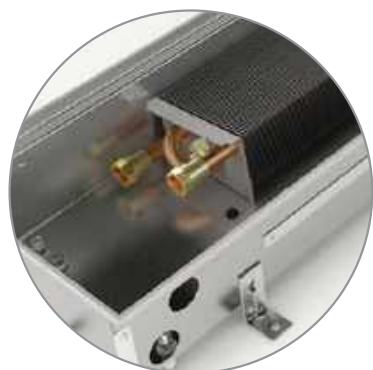

Trench heater heating output FRM

FRM trench heaters have an identical internal arrangement of components as FRK heaters. Their thermal output and other specifications may be found at the dimensionally similar FRK model.

Example:

Heating output FRM 110x250x1600, temperature gradient 75/65/20°C

FRM 0110 0250 1600 = FRK 0110 0250 1600 (str. 112)

Temperature gradient: 75/65/20°C

Output: Q = 536 W

Q[W] 75/65/20°C (ΔT=50°C)

H×W [mm]	0110 0175	0110 0200	0110 0250	0110 0300	0110 0350	0110 0425
L [mm]	n=1,479	n=1,479	n=1,46	n=1,468	n=1,458	n=1,403
700	103 W	110 W	166 W	182 W	194 W	245 W
800	129 W	137 W	207 W	227 W	242 W	305 W
900	155 W	164 W	248 W	272 W	290 W	365 W
1000	180 W	191 W	289 W	316 W	338 W	425 W
1100	206 W	218 W	330 W	361 W	386 W	486 W
1200	232 W	246 W	371 W	406 W	434 W	546 W
1300	257 W	273 W	413 W	451 W	482 W	607 W
1400	282 W	299 W	454 W	496 W	530 W	667 W

Heater for swimming pools exposed to submersion

An atypical body is offered for the installation of trench heaters for pools. The use of the body which may be submerged in pool water is discussed with the customer and the specific conditions of use.

For more information contact the Technical Department of ISAN Radiatory s.r.o.

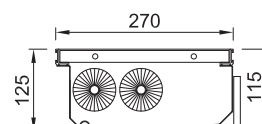

Heat exchanger – Hydraulic resistance

FRT: 65x175, 65x200, 65x250, 80x175, 80x200, 80x250, 90x175, 90x200, 110x175, 110x200

FRK: 80x250, 80x300, 90x175, 90x200, 90x250, 90x300, 110x175, 110x200, 125x175, 125x200, 140x175, 140x200

Length [mm]	Volume [l]	M – mass rate of flow in piping (kg/h) / R – hydraulic loss in exchanger (kPa)									
		M=40	60	80	100	150	200	250	300	350	400
800	0,2	0,01	0,01	0,03	0,05	0,11	0,22	0,36	0,53	0,75	1,00
1000	0,3	0,01	0,02	0,04	0,06	0,14	0,26	0,42	0,61	0,85	1,14
1500	0,5	0,01	0,03	0,06	0,09	0,20	0,36	0,57	0,82	1,12	1,47
2000	0,6	0,02	0,05	0,08	0,12	0,27	0,47	0,72	1,03	1,40	1,81
2500	0,8	0,03	0,06	0,10	0,15	0,33	0,57	0,87	1,24	1,67	2,15
3000	1,0	0,03	0,07	0,12	0,18	0,39	0,68	1,03	1,45	1,94	2,49
3500	1,2	0,04	0,08	0,14	0,22	0,46	0,78	1,18	1,66	2,21	2,83
4000	1,4	0,05	0,10	0,16	0,25	0,52	0,88	1,33	1,86	2,48	3,17
4500	1,6	0,05	0,11	0,19	0,28	0,59	0,99	1,49	2,07	2,75	3,50
4800	1,7	0,06	0,12	0,20	0,30	0,62	1,05	1,58	2,20	2,91	3,71

FRT: 65x300, 80x300

FRK: 90x350

Length [mm]	Volume [l]	M – mass rate of flow in piping (kg/h) / R – hydraulic loss in exchanger (kPa)									
		M=40	60	80	100	150	200	250	300	350	400
800	0,3	0,00	0,01	0,02	0,03	0,09	0,16	0,27	0,40	0,56	0,75
1000	0,4	0,01	0,01	0,03	0,04	0,10	0,19	0,31	0,46	0,64	0,85
1500	0,7	0,01	0,02	0,04	0,07	0,15	0,27	0,43	0,62	0,84	1,11
2000	1,0	0,02	0,03	0,06	0,09	0,20	0,35	0,54	0,77	1,05	1,36
2500	1,3	0,02	0,04	0,08	0,11	0,25	0,43	0,66	0,93	1,25	1,61
3000	1,6	0,03	0,05	0,09	0,14	0,30	0,51	0,77	1,09	1,45	1,87
3500	1,9	0,03	0,06	0,11	0,16	0,34	0,59	0,89	1,24	1,65	2,12
4000	2,2	0,04	0,07	0,12	0,19	0,39	0,66	1,00	1,40	1,86	2,37
4500	2,5	0,04	0,08	0,14	0,21	0,44	0,74	1,11	1,55	2,06	2,63
4800	2,7	0,04	0,09	0,15	0,22	0,47	0,79	1,18	1,65	2,18	2,78

FRT: 90x250, 110x250, 125x250, 125x300, 140x250, 140x300

FRK: 90x425, 110x250, 110x300, 125x250, 125x300, 140x250, 140x300

Length [mm]	Volume [l]	M – mass rate of flow in piping (kg/h) / R – hydraulic loss in exchanger (kPa)									
		M=40	60	80	100	150	200	250	300	350	400
800	0,4	0,02	0,04	0,07	0,10	0,23	0,40	0,62	0,88	1,20	1,55
1000	0,5	0,02	0,05	0,08	0,12	0,27	0,47	0,73	1,04	1,40	1,81
1500	0,9	0,03	0,07	0,12	0,18	0,38	0,66	1,01	1,43	1,91	2,46
2000	1,3	0,04	0,09	0,15	0,23	0,49	0,85	1,29	1,81	2,42	3,11
2500	1,7	0,05	0,11	0,19	0,29	0,61	1,03	1,57	2,20	2,93	3,76
3000	2,1	0,06	0,13	0,22	0,34	0,72	1,22	1,85	2,59	3,44	4,40
3500	2,5	0,07	0,15	0,26	0,39	0,83	1,41	2,12	2,97	3,95	5,05
4000	2,9	0,08	0,17	0,30	0,45	0,94	1,59	2,40	3,36	4,46	5,70
4500	3,3	0,09	0,20	0,33	0,50	1,05	1,78	2,68	3,75	4,97	6,35
4800	3,5	0,10	0,21	0,35	0,53	1,12	1,89	2,85	3,98	5,28	6,74

FRT: 90x300, 110x300

FRK: 165x300, 200x300, 110x350, 125x350, 140x350

Length [mm]	Volume [l]	M – mass rate of flow in piping (kg/h) / R – hydraulic loss in exchanger (kPa)									
		M=40	60	80	100	150	200	250	300	350	400
800	0,6	0,03	0,06	0,11	0,17	0,35	0,61	0,92	1,29	1,72	2,21
1000	0,8	0,04	0,08	0,13	0,20	0,43	0,72	1,09	1,53	2,03	2,59
1500	1,4	0,06	0,12	0,20	0,29	0,61	1,02	1,53	2,12	2,79	3,55
2000	2,0	0,08	0,16	0,26	0,39	0,79	1,32	1,96	2,71	3,56	4,51
2500	2,6	0,10	0,20	0,32	0,48	0,98	1,62	2,39	3,30	4,32	5,46
3000	3,1	0,12	0,23	0,39	0,57	1,16	1,91	2,83	3,89	5,09	6,42
3500	3,7	0,14	0,27	0,45	0,66	1,34	2,21	3,26	4,48	5,85	7,38
4000	4,3	0,15	0,31	0,51	0,76	1,52	2,51	3,69	5,07	6,62	8,34
4500	4,9	0,17	0,35	0,58	0,85	1,71	2,81	4,13	5,66	7,38	9,30
4800	5,2	0,19	0,37	0,61	0,90	1,82	2,99	4,39	6,01	7,84	9,87

FRT: 90x425, 110x425, 125x425, 140x425

FRK: 110x425, 125x425, 140x425

Length [mm]	Volume [l]	M – mass rate of flow in piping (kg/h) / R – hydraulic loss in exchanger (kPa)									
		M=40	60	80	100	150	200	250	300	350	400
800	0,8	0,04	0,09	0,15	0,23	0,48	0,81	1,21	1,68	2,23	2,84
1000	1,1	0,05	0,11	0,19	0,28	0,58	0,97	1,44	2,00	2,63	3,34
1500	1,9	0,08	0,17	0,27	0,41	0,83	1,37	2,02	2,78	3,65	4,61
2000	2,6	0,11	0,22	0,36	0,53	1,07	1,77	2,60	3,57	4,66	5,88
2500	3,4	0,14	0,27	0,45	0,66	1,32	2,17	3,18	4,36	5,68	7,15
3000	4,2	0,16	0,33	0,54	0,79	1,57	2,57	3,77	5,14	6,70	8,41
3500	5,0	0,19	0,38	0,62	0,91	1,82	2,97	4,35	5,93	7,71	9,68
4000	5,7	0,22	0,44	0,71	1,04	2,07	3,37	4,93	6,72	8,73	10,95
4500	6,5	0,25	0,49	0,80	1,17	2,32	3,77	5,51	7,50	9,74	12,22
4800	7,0	0,26	0,52	0,85	1,24	2,47	4,02	5,86	7,98	10,35	12,98

FRT: -

FRK: 165x425, 200 x 350, 200x425

Length [mm]	Volume [l]	M – mass rate of flow in piping (kg/h) / R – hydraulic loss in exchanger (kPa)									
		M=40	60	80	100	150	200	250	300	350	400
800	1,2	0,07	0,14	0,24	0,35	0,72	1,20	1,77	2,44	3,21	4,06
1000	1,6	0,09	0,18	0,29	0,43	0,87	1,44	2,12	2,91	3,81	4,81
1500	2,8	0,13	0,26	0,42	0,62	1,24	2,03	2,99	4,09	5,32	6,70
2000	4,0	0,17	0,34	0,55	0,81	1,61	2,63	3,85	5,26	6,84	8,59
2500	5,1	0,21	0,42	0,68	1,00	1,98	3,23	4,72	6,43	8,35	10,47
3000	6,3	0,25	0,50	0,81	1,19	2,35	3,83	5,58	7,60	9,86	12,36
3500	7,5	0,29	0,58	0,94	1,38	2,72	4,43	6,45	8,77	11,38	14,25
4000	8,7	0,34	0,66	1,07	1,56	3,10	5,02	7,31	9,94	12,89	16,14
4500	9,8	0,38	0,74	1,21	1,75	3,47	5,62	8,18	11,11	14,40	18,02
4800	10,5	0,40	0,79	1,28	1,87	3,69	5,98	8,70	11,82	15,31	19,16

Heat exchanger – Hydraulic resistance

FRC 0100 0175, 2 pipe

Length [mm]	Volume [l]	M – mass rate of flow in piping (kg/h) / R – hydraulic loss in exchanger (kPa)									
		M=40	60	80	100	150	200	250	300	350	400
800	0,3	0,45	0,91	1,51	2,23	4,54	7,50	11,08	15,24	19,96	25,21
1200	0,4	0,72	1,46	2,41	3,57	7,26	12,02	17,76	24,45	32,02	40,46
1600	0,5	0,98	2,00	3,32	4,90	9,98	16,53	24,44	33,65	44,09	55,72
2000	0,7	1,25	2,55	4,22	6,24	12,71	21,04	31,13	42,85	56,16	70,98
2400	0,8	1,52	3,09	5,12	7,58	15,43	25,56	37,81	52,06	68,23	86,24
2800	1,0	1,78	3,64	6,02	8,91	18,15	30,07	44,49	61,26	80,29	101,49

FRC 0135 0325, 2 pipe

Length [mm]	Volume [l]	M – mass rate of flow in piping (kg/h) / R – hydraulic loss in exchanger (kPa)									
		M=40	60	80	100	150	200	250	300	350	400
800	0,8	0,07	0,14	0,23	0,34	0,67	1,10	1,61	2,20	2,87	3,60
1200	1,2	0,11	0,23	0,38	0,56	1,13	1,86	2,74	3,75	4,90	6,18
1600	1,7	0,16	0,32	0,53	0,78	1,59	2,62	3,86	5,31	6,94	8,76
2000	2,1	0,20	0,41	0,68	1,01	2,05	3,38	4,99	6,86	8,98	11,34
2400	2,5	0,25	0,50	0,83	1,23	2,50	4,14	6,12	8,42	11,02	13,92
2800	2,9	0,29	0,59	0,98	1,46	2,96	4,90	7,24	9,97	13,06	16,50

FRD 0135 0325, 4 pipe, Heating-circuit

Length [mm]	Volume [l]	M – mass rate of flow in piping (kg/h) / R – hydraulic loss in exchanger (kPa)									
		M=40	60	80	100	150	200	250	300	350	400
800	0,3	0,38	0,74	1,21	1,77	3,51	5,70	8,31	11,31	14,68	18,40
1200	0,4	0,75	1,42	2,24	3,19	6,08	9,62	13,74	18,38	23,52	29,13
1600	0,6	1,12	2,09	3,27	4,62	8,66	13,54	19,16	25,45	32,36	39,85
2000	0,7	1,49	2,77	4,29	6,04	11,24	17,46	24,59	32,52	41,20	50,57
2400	0,8	1,86	3,44	5,32	7,47	13,82	21,38	30,01	39,59	50,04	61,29
2800	1,0	2,23	4,11	6,35	8,89	16,39	25,31	35,44	46,66	58,88	72,02

FRD 0135 0325, 4 pipe, Cooling-circuit

Length [mm]	Volume [l]	M – mass rate of flow in piping (kg/h) / R – hydraulic loss in exchanger (kPa)									
		M=40	60	80	100	150	200	250	300	350	400
800	0,6	0,13	0,26	0,43	0,65	1,32	2,20	3,26	4,51	5,92	7,50
1200	0,8	0,22	0,45	0,75	1,11	2,26	3,76	5,57	7,69	10,10	12,78
1600	1,1	0,31	0,64	1,06	1,57	3,20	5,32	7,89	10,88	14,27	18,06
2000	1,4	0,40	0,82	1,37	2,03	4,14	6,88	10,20	14,06	18,45	23,34
2400	1,7	0,50	1,01	1,68	2,49	5,08	8,44	12,51	17,24	22,62	28,62
2800	1,9	0,59	1,20	1,99	2,95	6,03	10,00	14,82	20,43	26,80	33,90

Electric connection of trench heaters with fan, heating

The trench heaters and their components are powered with safe direct current voltage of 24 V DC. The low voltage requires specific sizing of the network. Based on the number of installed units it is necessary to assess the total input of the circuit and size the capacity of the power source and the cross sections of the conductors in the circuit shall be correctly sized with respect to the distances between individual heating bodies and the switched source of the voltage of 24 V DC. The total input of the bodies is considered for maximal speed (i.e. speed no. 4), if the electrothermal actuator is used we will add its operating input. The voltage in the circuit may not, in any point, drop below the value of 22 V DC.

Procedure of the network sizing

1. Consider the trench heater's input for maximal speed from the table.
2. If the electrothermal actuator is considered, add its input.
3. Determine the position for the installation of the switched power supply for the voltage of 24 V DC, this position shall be as close to installed trench heaters as possible.
4. Record the distances between the bodies and the source from the project.
5. Determine the lines of the electric network.
6. Calculate the decline of voltage in individual bodies.
7. If the voltage at all heating bodies is >22 V DC, determine the power supply's capacity, consider the output reserve of 5% (see SCHEME 1 on page 130).
8. If the voltage along the network lines drops below 22 V DC, size a large cross section of conductors or install additional power supply on the lines (see SCHEME 3 on page 131).
9. When installing more than 10 trench heaters it is necessary to incorporate a switching relay RL10 in the circuit, (see SCHEME 2 on page 130).

The sizing of the network is easier with the use of the computer program that can be downloaded at website www.isan.cz

Setting the thermostat RTD201, heating

It is necessary to carry out basic presetting before the first start-up to secure the correct function of the thermostat:

DIP SWITCH

Switch the switch 1 on the back side of the thermostat to position ON. The other switches will remain in the OFF position. With this the 2pipe heating system has been preset.

SERVICE LEVEL - PARAMETERS

The „service level“ contains a small set of parameters for the adjustment of the regulator to the HVAC system and for the setting of the user's interface. These parameters may usually be set at any time.

SET

P01 = 0 the setting of the heating mode

EXPERT LEVEL - PARAMETERS

The parameters in the “Expert level” shall be adjusted with great care because they influence the regulation process and the regulator's function.

SETTING

P55 = 100% maximal speed, in the case of need the maximal speed may be limited with this parameter (e.g. P55 = 60%)

P56 = 20% minimal speed

P72 = 2 setting the opening of the thermal actuator to the thermostat's terminal Q1

If the speed blocking sensor TE30 is to be used it is necessary to change the inner setting of the thermostat. Consult the setting with the technical department of ISAN Radiatory.



Electrical diagram, heating

SCHEME 1 - basic connection

Note

- The voltage must not drop below 22 V DC, it is necessary to size the cross section of conductors correctly according to the calculation SW.
- If more than 10 electrothermal actuators are used it is necessary to use the switching relay (see SCHEME 2).
- If the capacity of the switching source is insufficient use more power supplies (see SCHEME 3).

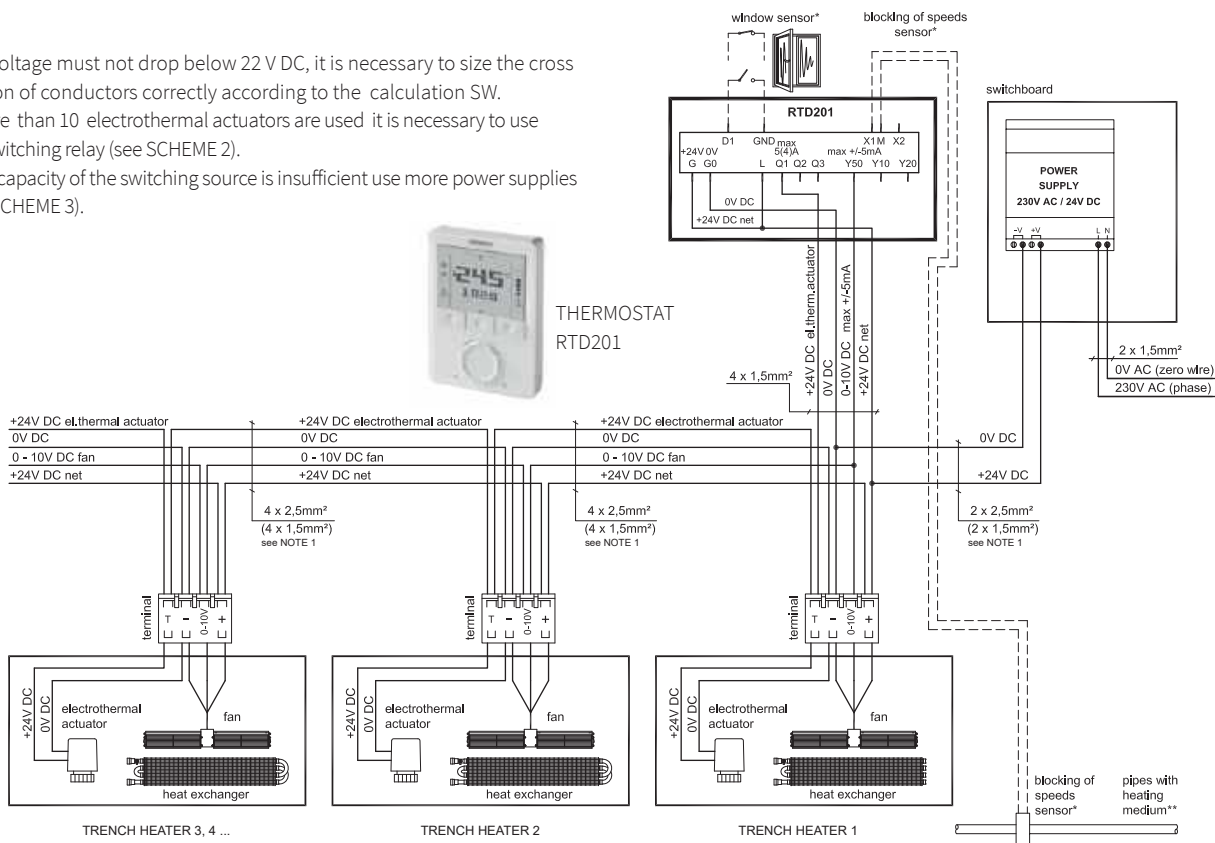

*accessories / ** The temperature sensor (block of revs) must be fixed on the tube, through which the heating medium freely flows and which is not closed by the actuator.

SCHEME 2 - connection with more than 10pcs of electrothermal actuator

Note

- The voltage must not drop below 22 V DC, it is necessary to size the cross section of conductors correctly according to the calculation SW.
- If the capacity of the switching source is insufficient use more power supplies (see SCHEME 3).

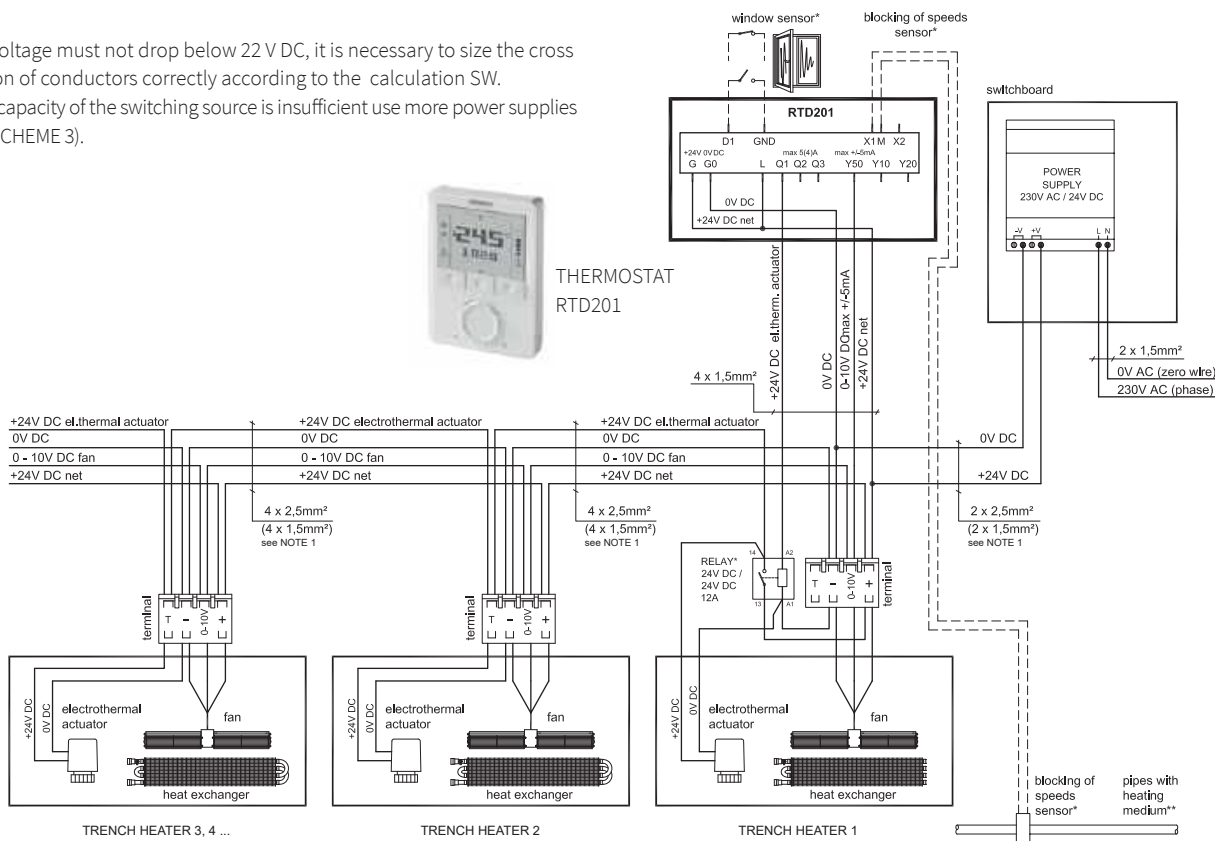

*accessories / ** The temperature sensor (block of revs) must be fixed on the tube, through which the heating medium freely flows and which is not closed by the actuator.

Electrical diagrams, heating

SCHEME 3 - connection with more supplies

Note

- The voltage must not drop below 22 V DC, it is necessary to size the cross section of conductors correctly according to the calculation SW.
- If more than 10 electrothermal actuators are used it is necessary to use the switching relay (see DIAGRAM 2).
- All sources shall be powered from a single circuit breaker.

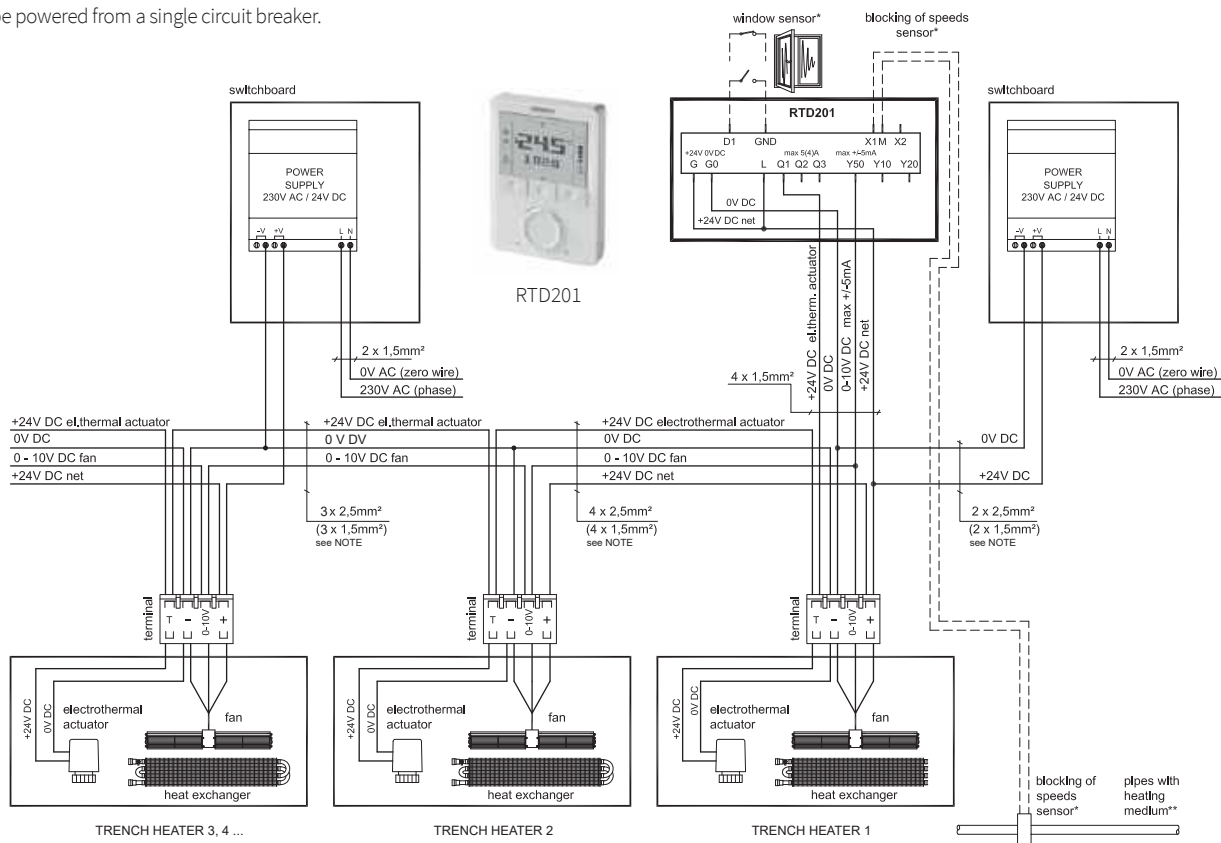

*accessories / ** The temperature sensor (block of revs) must be fixed on the tube, through which the heating medium freely flows and which is not closed by the actuator.

RTM201 thermostat connection

- The RTM201 thermostat is to be installed in accordance with RTD201 digital thermostat wiring diagrams, including the required parameters.
- Wiring connection to the RTM201 thermostat terminals.

Jumpers setting for the mode Only heating

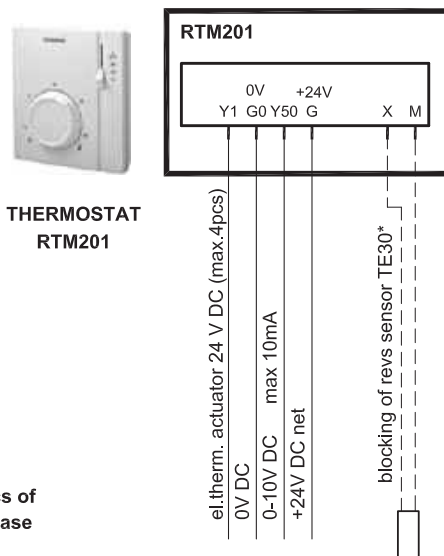
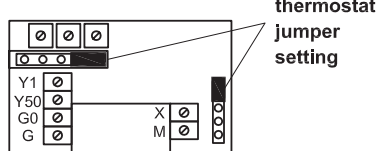

Note: Thermostat RTM201 can controll only 4 pcs of electrothermal actuator, for more peaces use please relay RL10, connection by Scheme 2

*accessories

The coding of trench heaters TERMO

1	2	3	4	5	6	7	8	9	10	11	12	13	14	15	16	17	18	19	20	21	22	23	24
F	R	T	0	1	1	0	0	2	5	0	1	2	0	0	C	1	2	J	1	L	B	5	
PRODUCT	LINE	TYPE	HEIGHT [mm]	WIDTH [mm]	LENGTH [mm]	TROUGH & COMPONENTS	grille, TYPE AND colour	LEDGE Colour OF LEDGE	WATER CONNECTION LEFT / RIGHT	SELFSTANDING	REGULATION	ATYPICAL / STANDARD											

Code description

Trench heater **FRT** H = 110 mm, W = 250 mm, L = 1 200 mm, „C“ Galvanized steel trough with black inside, heat exchanger and inner parts painted black, „12“ natur anodized aluminium grille, linear, rigid „J1“ peripheral ledge „J“, natur anodized aluminium, „L“ water connection at the left side (when installing the heat exchanger closer to the window, fans to the room), „B“ selfstanding 0-35 mm „5“ 24 V DC fans without controller (controller is not needed)

1-3	PRODUCT	for examp. FRT	<p>Fan-assisted FET - with electric heating unit FRT - with lamellar heat exchanger, heating FRC - with lamellar heat exchanger, heating / cooling, 2 pipe FRD - with lamellar heat exchanger, heating / cooling, 4 pipe FRB - with lamellar heat exchanger, heating, humid environment FRZ - trench heater FRT with installed power supply FZC - trench heater FRC with installed power supply FZD - trench heater FRD with installed power supply</p> <p>Fan-assisted FEK - with electric heating unit FRK - trench heater with lamellar heat exchanger FRM - trench heater with lamellar heat exchanger, humid environment</p>
4-7	HEIGHT [mm]	for examp. 0090	<p>FET 0110 FRT 0065, 0080, 0110, 0125, 0140 FRC, FRD, FZC, FRD 0100, 0325 FRB 0090, 0110, 0125, 0140 FEK 0140 FRK, FRM 0080, 0090, 0110, 0125, 0140, 0200</p>
8-11	WIDTH [mm]	for examp. 0175	<p>FET, FEK 0225 FRT, FRZ 0175, 0200, 0250, 0300, 0425 mm FRC, FZC 0175, 0325 mm FRD, FZD 0325 mm FRB 0200, 0250, 0300, 0425 mm FRK, FRM 0175, 0200, 0250, 0300, 0350, 0425 mm</p>
12-15	LENGTH [mm]	700 to 4800	<p>FET, FEK 800, 1200, 1600, 2000 mm</p> <p>FRT, FRB, FRK, FRM 0700, 0800, 0900, 1000, 1100, 1200, 1300, 1400, 1500, 1600, 1700, 1800, 1900, 2000, 2100, 2200, 2300, 2400, 2500, 2600, 2700, 2800, 2900, 3000, 3100, 3200, 3300, 3400, 3500, 3600, 3700, 3800, 3900, 4000, 4100, 4200, 4300, 4400, 4500, 4600, 4700, 4800 mm</p> <p>FRZ, FDZ - the length of the trench heater is 200 mm longer than FRT and FDT</p> <p>FRC, FRD 0800, 1200, 1600, 2000, 2400, 2800 mm</p> <p>FZC, FZD model 0100 0175 longer 200 mm, 0135 0325 the same length as FRC, FRD</p>
16	TROUGH & INNER COMPONENTS	C	Galvanized steel trough with surface finish and black spray layer inside
		N	Trough made of stainless steel

17-18	GRILLES	00	WITHOUT THE GRILLE, the trench heater without the grille (the customer will supply their own grille or buy one later)
		11	NATUR aluminium roll-up transverse grille
		12	NATUR aluminium linear non-rolling grille
		15	NATUR aluminium low transverse grille
		17	NATUR for electric heaters, transverse aluminium non-roll grille
		21	BRONZE aluminium roll-up transverse grille
		22	BRONZE aluminium linear non-rolling grille
		25	BRONZE aluminium low transverse grille
		27	BRONZE for electric heaters, transverse aluminium non-roll grille
		31	BLACK aluminium roll-up transverse grille
		32	BLACK aluminium linear non-rolling grille
		35	BLACK aluminium low transverse grille
		37	BLACK for electric heaters, transverse aluminium non-roll grille
		41	STAINLESS aluminium roll-up transverse grille
		42	STAINLESS aluminium linear non-rolling grille
		47	STAINLESS for electric heaters, transverse aluminium non-roll grille
		51	STAINLESS non-rolling transverse grille of stainless steel profiles 20×10 mm (for car saloons)
		52	STAINLESS roll-up transverse grille of stainless steel profiles 20×10 mm
		61	BEECH NATUR wooden roll-up transverse grille without surface finish
		62	STAINED BEECH wooden roll-up transverse grille with stained surface finish
63	OAK NATUR wooden roll-up transverse grille without surface finish		
64	STAINED OAK wooden roll-up transverse grille with stained surface finish		
95	STAINLESS highly resistant grille		
99	ATYP - material, spacing of lamellas, surface finish according to RAL, after consultation with ISAN		
19	LEDGE	-	WITHOUT LEDGE - in the case of additional order (if the trench heater is embedded without the ledge, say so in the note, in such case the grille's width is different)
		L	L - peripheral ledge 15×15×1,5 mm to cover expansion gaps, the position of the code 20 determines the surface finish
		J	J - peripheral ledge that forms a peripheral rectangle with the width of 4 mm
20	COLOUR OF LEDGE	-	in the case when the ledge is not installed
		1	NATUR anodized aluminium ledge
		2	BRONZE anodized aluminium ledge
		3	BLACK anodized aluminium ledge
		9	other colour, i.e surface finish of sprayed powder colour according to the RAL sample list
21	CONNECTION RIGHT/LEFT	L	Connection of the heating medium ON THE LEFT side when installing the heat exchanger at the window, the fan towards the room's centre (standard)
		R	Connection of the heating medium ON THE RIGHT side when installing the heat exchanger at the window, the fan towards the room's centre (Version R electric heaters only)
		A	OTHER, e.g. the left/right connection into the bottom, with combined trench heaters connection in the middle etc.
22	SELF STANDING	-	STANDARD adjusting components are not load bearing and should be used for height adjustment only
		B	ADJUSTING SCREWS 0-35 mm, closely spaced screws on the bottom of the heater casing, load-bearing
		D	HEIGHT-ADJUSTING LEGS 10-70 mm, a sliding metal box fitted with a leveling screw
		V	BRACKETS 60-300 mm, special „leg“ mounting
23	REGULATION	0	FRK, trench heater without fans (with natural convection)
		1	FEK - trench heater without fan with installed regulator
		5	FRT, 24 V DC fans installed
		6	FET - 24 V DC fans and regulators installed
		P	FRC, FRD, FZC, FZD - 24 V DC fans installed + condensate pump CP10
24	ATYPICAL		Empty field, standard version of the trench heater
		A	Atypical version of the trench heater



ISAN Radiátory s.r.o | Poříčí 26, 678 01 Blansko, CZ

CZ | Tel.: +420 516 489 138 | Fax: +420 516 489 605 | obchod@isan.cz | www.isan.cz
SK | Tel.: +421 905 759 388 | obchod@isan.sk | www.isan.sk
Export | Tel.: +420 516 489 190 | Fax: +420 516 489 605 | sales@isan.cz | www.isan.cz