

Hauptkatalog
Industrieller Kabelschutz
Main catalogue
Industrial cable protection

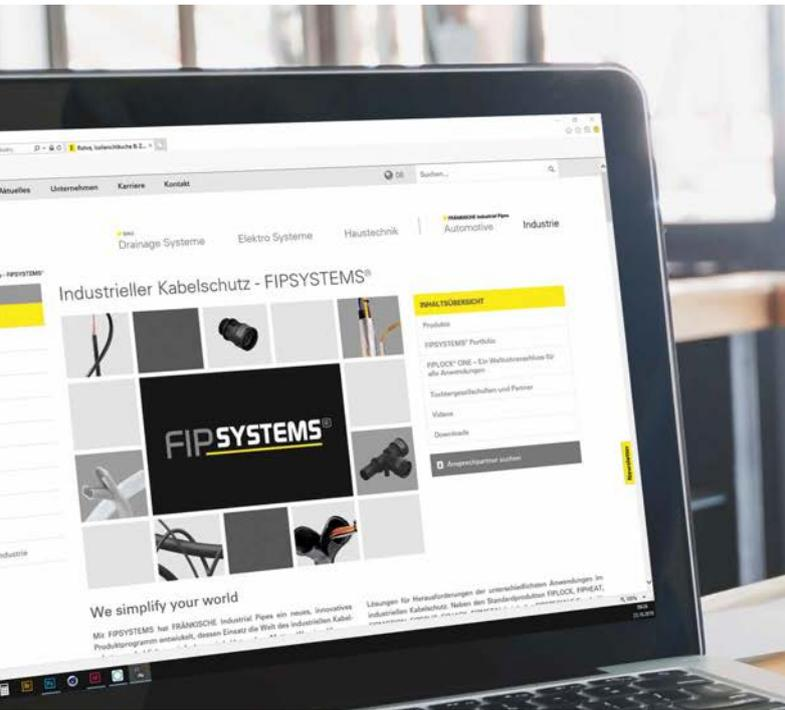

FIPSYSTEMS® We simplify your world

Stand: Oktober 2019

Last modified: October 2019



Inhalt

Table of contents

1	Produktionsstandorte und Kontakt <i>Production sites and contacts</i>	4
2	Wer wir sind <i>Who we are</i>	5
3	FIPSYSTEMS® Produktlinien <i>FIPSYSTEMS® product lines</i>	6
4	Anwendungsbereiche <i>Applications</i>	7
5	Zulassungen und Zertifikate <i>Certificates and approvals</i>	8
6	Zertifizierungen <i>Certifications</i>	9 – 11
7	Innovation bei FRÄNKISCHE Industrial Pipes <i>Innovation at FRÄNKISCHE Industrial Pipes</i>	12 – 13

9	FIPLOCK®	Standardwellrohre <i>Standard corrugated conduits</i>	14–26
10	FIPLOCK® ONE	Wellrohranschlüsse <i>Fittings</i>	28–61
11	FIPLOCK®	Zubehör <i>Accessories</i>	62–84
12	FIPHEAT®	Hochtemperaturwellrohre <i>High temperature corrugated conduits</i>	86–92
13	FIPMOTION®	Hochdynamische Wellrohre <i>High flexible corrugated conduits</i>	94–98
14	FIPSPLIT®	Teilbare Wellrohre <i>Divisible corrugated conduits</i>	100–111
15	FIPSPLIT®	Verschraubungen und Zubehör <i>Fittings and accessories</i>	112–120
16	FIPSPECIALS®	Speziallösungen <i>Special solutions</i>	122–134
17	FIPJACK®	Textile Schutzschläuche <i>Textile protection sleeves</i>	136–144
18	FIPMETAL®	Metallschutzschläuche <i>Metal conduits</i>	146–152
19	FIPMETAL®	Zubehör <i>Accessories</i>	154–159

Produktionsstandorte

Production sites



Amerika / America

- Anderson, USA
Anderson, USA



+1 864 328-0021

fipsystems@fraenkische-usa.com

Europa / Europe

- Königsberg, Deutschland
Königsberg, Germany
- Okříšky, Tschechien
Okříšky, Czech Republic



+49 9525 88-0

sales@fraenkische-ip.com

China / China

- Anting/Shanghai, China
Anting/Shanghai, China
- Changshu, China
Changshu, China



+86 21 6957 3800

sales@fraenkische-cn.com

Detallierte Kontaktdaten unserer Partner finden Sie unter
You can find detailed contact data of our partners at

www.fipsystems.com

FRÄNKISCHE Industrial Pipes: A world full of solutions

FRÄNKISCHE Industrial Pipes ist eine 100%ige Tochtergesellschaft von FRÄNKISCHE Rohrwerke, dem weltweit ersten Hersteller von Wellrohren. Wir entwickeln und fertigen weltweit auf über 280.000 qm Produktionsfläche Produkte, die sich an den Bedürfnissen unserer Kunden orientieren. So vielfältig die Fähigkeiten unseres internationalen Fachkräfteteams sind, so konzentriert arbeiten wir gemeinschaftlich am gleichen Ziel: das Leben unserer Kunden zu erleichtern.

Die vielfältigen Kompetenzen unserer internationalen Experten vernetzen wir weltweit miteinander und sind so immer nah am Kunden. Mit unseren breit aufgestellten Spezialistenteams sind wir in der Lage, uns in unsere Kunden und deren Anforderungen hineinzuversetzen. So kombinieren wir unsere persönliche Erfahrungen mit den Anwendern, um neue Produkte und innovative Lösungen zu entwickeln.

FRÄNKISCHE Industrial Pipes is a wholly-owned subsidiary of FRÄNKISCHE Rohrwerke, the world's first manufacturer of corrugated tubes. We develop products for the industrial and automotive sector in production facilities of more than 280,000 square meters worldwide with close focus on our customers desires. Our international team of experts with their versatile skills strives to achieve the common goal: Making our customers' lives easier.

The broad competences of our experts are globally linked in order to stay close to the customer. With our broadly based teams of professionals we always try to see through the eyes of our customers and to perceive their needs. This is how we combine our and our customers experiences in order to develop brand-new products an innovative solutions.

FIPSYSTEMS® – We simplify your world

Mit FIPSYSTEMS® hat FRÄNKISCHE Industrial Pipes ein neues, innovatives Produktprogramm entwickelt, dessen Einsatz die Welt des industriellen Kabelschutzes erheblich vereinfachen wird. Unter dem Motto „We simplify your world“ bietet FRÄNKISCHE Industrial Pipes mit dem FIPSYSTEMS® Sortiment Lösungen für Herausforderungen der unterschiedlichsten Anwendungen im industriellen Kabelschutz.

Der Vertrieb von FIPSYSTEMS® funktioniert über ein weltweit vernetztes Partnersystem. Wir arbeiten mit qualifizierten Unternehmen in nahezu jeder, für die Industrie bedeutender Region zusammen und stellen so schnelle und einfache Kommunikationswege zwischen Ihnen als Kunde und uns als Lieferant sicher. Unsere eigenen Standorte in Europa, den Vereinigten Staaten und China beliefern die regionalen Partner direkt mit den entsprechenden Produkten was uns Lieferzeiten in alle Welt flexibler gestalten lässt.

FIPSYSTEMS® a new developed innovative product range from FRÄNKISCHE Industrial Pipes, significantly simplifies the world of industrial cable protection. True to the motto "We simplify your world", FRÄNKISCHE Industrial Pipes and its FIPSYSTEMS® product line provide solutions to various challenges in the versatile field of industrial cable protection.

The sales and distribution of FIPSYSTEMS® is strongly supported by a global partner network. We work with qualified companies in virtually every country with industrial relevance to ensure fast and easy communication between you as a customer and us as a supplier. Our own locations in Europe, the United States and China supply the regional partners directly with the corresponding products which allow us to be more flexible regarding the delivery services all around the world.

FIPSYSTEMS® Produktlinien

FIPSYSTEMS® product lines

FIPLOCK®

Standardwellrohre und Zubehör

*Standard corrugated conduits
and accessories*

FIPLOCK® ONE

Wellrohranschlüsse

Fittings

FIPHEAT®

Hochtemperaturwellrohre

High temperature corrugated conduits

FIPMOTION®

Hochdynamische Wellrohre

Highly flexible corrugated conduits

FIPSPLIT®

Teilbare Wellrohre,
Verschraubungen und Zubehör

*Divisible corrugated conduits,
fittings and accessories*

FIPSPECIALS®

Speziallösungen

Special solutions

FIPJACK®

Textile Schutzschläuche

Textile protection sleeves

FIPMETAL®

Metallschutzschläuche und Zubehör

Metal conduits and accessories

Anwendungsbereiche

Applications



Industrie
Industry



Solarindustrie
Solar industry



Windenergie
Wind energy



Bahn/Transport
Railway/transport



Gleisnebenanwendungen
Track side applications



Robotik
Robotics



Schiffbau
Ship building



Chemie
Chemical industry



Telekommunikation
Telecommunications



Sonstiges
Miscellaneous

Anwendungshinweis

Application note

Auf den nachfolgenden Seiten dieses Hauptkataloges finden Sie eine Vielzahl an Kabelbündelungs- und Schutzprodukten für industrielle Anwendungen.

Sollte Ihr vorgesehener Einsatz hiervon abweichen und/oder Sie benötigen z. B. Produkte für Fluid-Systeme, so kontaktieren Sie bitte Ihren Ansprechpartner. Gerne prüft unser Produktmanagement Ihre Anforderung und leitet diese gegebenenfalls an die entsprechende Abteilung weiter.

Vielen Dank!

FIPSYSTEMS® Produktmanagement

The following pages in our catalogue contain various products and solutions for cable/wire protection and bundling in industrial applications.

If your applications deviate from this and/or you need e.g. products for fluid systems, please contact our product management. We will gladly check your inquiry and forward it in-house accordingly.

Thanks a lot!

FIPSYSTEMS® product management

Zulassungen und Zertifikate

Certificates and approvals



Wir erfüllen alle Anforderungen der **DIN EN ISO 9001, ISO/TS 16949, ISO 50001** und **DIN EN ISO 14001**

*We fulfill all requirements of **DIN EN ISO 9001, ISO/TS 16949, ISO 50001** and **DIN EN ISO 14001***



International **R**ailway
Industry **S**tandard
ISO TS 22163



Communautés
Européennes
(IEC EN61386)



Registration,
Evaluation,
Authorization and
restriction of **CH**emicals.



Recognized component
mark for Canada and
United States



Restriction of
Hazardous
Substances Directive



Norm für Schienenverkehrs-
technik **EN 45545-2**

*Standards for rolling stock
EN 45545-2*



Zulassung für Gefahrgut-
transport

*License for transport
of hazardous goods*



American **S**ociety for
Testing and **M**aterials



Halogenfrei
Halogen free



National **F**ire **P**rotection
Association

Zertifizierungen

Certifications



UL: Zugelassene Wellrohre FIPLOCK®

UL: *Approved corrugated conduits FIPLOCK®*

Folgende FIPLOCK® Wellrohre sind in Verbindung mit FIPLOCK® ONE Wellrohranschlüssen nach UL 1696 zugelassen.

Following FIPLOCK® corrugated conduits are approved according to UL 1696 in combination with FIPLOCK® ONE fittings.

					
FPANF schwarz / black NW 07-48	FPANF grau / grey NW 07-48	FPANC schwarz / black NW 17-48	FPANC grau / grey NW 17-48	FPASF schwarz / black NW 07-48	FPASF grau / grey NW 07-48
					
FPASC schwarz / black NW 17-48	FPASC grau / grey NW 17-48	FPACF schwarz / black NW 07-48	FPACF grau / grey NW 07-48	FPACC schwarz / black NW 17-48	FPACC grau / grey NW 17-48
					
FPDSF schwarz / black NW 07-48	FPDSF grau / grey NW 07-48	FPDSC schwarz / black NW 17-48	FPDSC grau / grey NW 17-48	HPACF schwarz / black NW 07-12	HPACC schwarz / black NW 17-48
					
HPDFF schwarz / black NW 07-12	HPDFC schwarz / black NW 17-48	HPDSF schwarz / black NW 07-12	HPDSC schwarz / black NW 17-48		

Zertifizierungen

Certifications



UL: Zugelassene Wellrohranschlüsse FIPLOCK® ONE

UL: Approved fittings FIPLOCK® ONE

Folgende FIPLOCK® ONE Wellrohranschlüsse sind in Verbindung mit FIPLOCK® Wellrohren nach UL 1696 zugelassen (schwarz und grau): / Following FIPLOCK® ONE fittings are approved according to UL 1696 in combination with FIPLOCK® corrugated conduits (black and grey):

					
ASPA-M	ASPA-MMK	ASPA-MML	ASPA-PG	ASPA-PGM	ASPA-NPT
					
AWPA/AEPA-M	AWPA/AEPA-MMK	AWPA/AEPA-MML	AWPA/AEPA-PG	AWPA/AEPA-PGM	AWPA/AEPA-NPT
					
AAPA-M	AAPA-MMK	AAPA-MML	AAPA-PG	AAPA-PGM	AAPA-NPT
					
AFPA-M	AFPA-MM	AFPA-PG	AFPA-PGM	AFPA-U-M	AFPA-U-A
					
AFPA-U-B	ATPA	ATPA-CP	AYPA	ARPA	AIPA-M
					
AIPA-PG	ACPA	ACPA-SH	APPA-EPDM	APPA-NBR	ASPA-HV



EN 45545-2: Zugelassene Wellrohre und -anschlüsse

EN 45545-2: Approved corrugated conduits and fittings

Folgende unserer Produkte sind nach der Norm EN45545-2 zertifiziert:

The following of our products are certified according to the standard EN45545-2:



FIPLOCK®

FPAS, FPAF, FPDS, FPDF,
HPAF, HPDS, HPDF



FIPLOCK® ONE

alle Wellrohranschlüsse
all fittings



FIPSPLIT®

2PAS, 2PAF, 2PDS,
2PDF, 1PAS



FIPSPECIALS®

FPASH, FPASS, IPAT,
OPAS, OPAF,
OPDS, OPDF

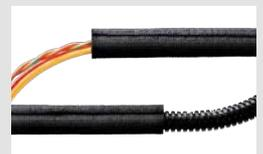

FIPJACK®

BPET-V0*
WPET-SCF

*gültig für schwarz und grau
valid for black and grey



**NFPA
130**

ASTM + NFPA 130: Zugelassene Wellrohre und -anschlüsse

ASTM + NFPA 130: Approved corrugated conduits and fittings

Folgende unserer Produkte sind nach der Norm ASTM sowie NFPA 130 zertifiziert:

The following of our products are certified according to the norm ASTM as well as NFPA 130:



FIPLOCK®

FPAS, FPDS, FPDF,
HPDS, HPDF

gültig für schwarz und grau
valid for black and grey



FIPLOCK® ONE

alle Wellrohranschlüsse
all fittings

gültig für schwarz und grau
valid for black and grey



FIPSPLIT®

2PAS, 2PDS,
2PDF, 1PAS

gültig für schwarz und grau
valid for black and grey



FIPSPECIALS®

FPASH, FPASS, IPAT,
OPAS, OPDS, OPDF

„Wer nicht mit der Zeit geht, geht mit der Zeit.“

“Who does not move with time, will be removed with time.”

Dem deutschen Arzt, Dichter, Philosoph und Historiker Friedrich Schiller war das bereits im 18. Jahrhundert klar. Nötiger Fortschritt ist ohne Veränderungen unmöglich! Nicht nur die Anforderungen an unsere Produkte unterliegen Veränderungen, auch die Art der Darstellung und Vermarktung.

Um dem Trend der Digitalisierung in allen Bereichen entgegenzukommen gehen wir in diesem Katalog einen neuen Weg unsere Produkte darzustellen und Ihnen alle nötigen Informationen schnell, top-aktuell und einfach zu liefern. Ein gedruckter Katalog wird wohl nie ganz seine Bedeutung verlieren und hat doch seinen ganz eigenen Charme. Dennoch wollen wir Ihnen die Möglichkeit geben sich schnell und unkompliziert mit Hilfe von mobilen Endgeräten über unsere Produkte zu informieren. Zu diesem Zweck finden Sie QR Codes auf jeder Produktseite über die Sie das zugehörige Datenblatt herunterladen können. In diesem finden Sie alle notwendigen technischen Informationen.

Die QR-Codes (Abkürzung für Quick Responses, dt. „schnelle Antwort“) lassen sich mit Smartphone oder Tablet und einer kostenlosen App lesen. Dazu muss nur die App gestartet und die Kamera des mobilen Endgerätes auf den QR-Code gerichtet werden. Sobald der Code erkannt wurde, können Sie das Datenblatt als PDF ansehen, herunterladen und speichern. Bei manchen Smartphones, vor allem der neueren Generation, ist ein solcher QR Code Scanner bereits automatisch in der Kamera eingebaut. Eine separate App ist dann nicht notwendig.

The German physician, poet, philosopher and historian Friedrich Schiller already realized this in the 18th century. Necessary progress is impossible without changes! Not only are the requirements in regard to our products subjected to changes, but also the way of presentation and marketing.

In order to meet the trend of digitization in all areas, we are going to go in a new direction in this catalog in how we represent our products quick, up to date and easy and provide you with all the information you need. A printed catalog will probably never lose its meaning and yet has its very own charm. Nevertheless, we want to give you the opportunity to inform yourself about our products quick and easy by using mobile devices.

For this purpose, you will find QR codes on each product page where you can download the related datasheet. This contains all the necessary technical information.

The QR codes (abbreviation for Quick Responses) can be read with a smartphone or tablet and a complimentary app. All you have to do is to start the app and point the camera of the mobile device to the QR code. Once the code has been detected, you can view, download and save the datasheet as a PDF. In some smartphones, especially the ones of the newer generation, such a QR code scanner is already installed in the camera automatically. A separate app is not necessary.



eCATALOGsolutions
elektronischer CAD Katalog
electronic CAD catalog

3D Visualisierung und 2D Zeichnungsdarstellung unserer Produkte finden Sie hier:

3D visualization and 2D drawings of our products can be found here:

<http://fraenkische-ip.partcommunity.com>



Standardwellrohre

Standard corrugated conduits

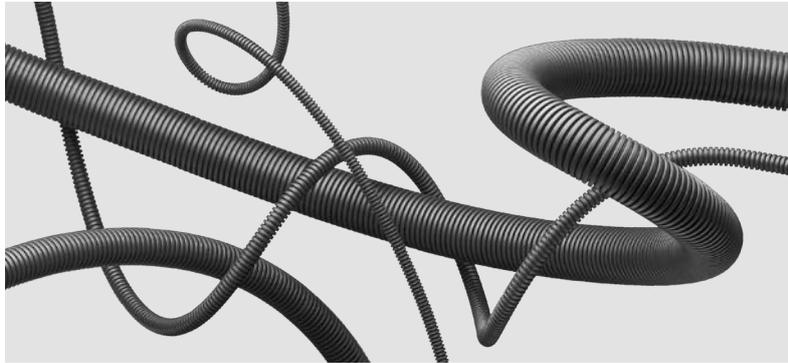

Produktübersicht / *Product overview*

Produkt <i>Product</i>	Material <i>Material</i>	Profil <i>Profile</i>	Zubehör <i>Accessories</i>	Seite <i>Page</i>
FPAS	PA6 MOD BS	F, C	✓	18
FPAC	PA6 MOD BS C	F, C	✓	19
HPAC	PA6 MOD BS C	F, C	✓	19
FPAF	PA6 MOD V0	F, C	✓	20
HPAF	PA6 MOD V0	F, C	✓	20
FPAN	PA6 MOD	F, C	✓	21
FPAN-0	PA6 MOD Orange**	F, C	✓	21
FPDS	PA12 MOD BS	F, C	✓	22
HPDS	PA12 MOD BS	F, C	✓	22
FPDF	PA12 MOD V0	F, C	✓	23
HPDF	PA12 MOD V0	F, C	✓	23
FPDA	PA12 MOD ESD	F, C	✓	24
FPPS-U	PP MOD BS UV	F, C	✓	25
FPPS-0	PP MOD BS Orange*	F	✓	25
FPP0	PP MOD	F, C	✓	26

* ähnlich RAL2003/ *similar to RAL2003*

** ähnlich RAL2003 oder 2009/ *similar to RAL2003 or 2009*



Sie interessieren sich für unsere Produkte?
 Klicken Sie hier zur **Direktanfrage**.
 You are interested in our products?
 Please click here for **direct inquiry**.

Empfohlene Anwendungsbereiche / Recommended areas of application

Produkt Product										
FPAS	✓		✓	✓			✓	✓		✓
FPAC	✓		✓				✓			✓
HPAC	✓		✓				✓			✓
FPAF	✓			✓			✓			✓
HPAF	✓			✓			✓			✓
FPAN	✓									✓
FPAN-0	✓									✓
FPDS	✓	✓	✓	✓	✓	✓	✓	✓	✓	✓
HPDS	✓	✓	✓	✓	✓	✓	✓	✓	✓	✓
FPDF	✓	✓	✓	✓	✓	✓	✓	✓		✓
HPDF	✓	✓	✓	✓	✓	✓	✓	✓		✓
FPDA	✓	✓	✓			✓		✓		✓
FPPS-U	✓	✓	✓		✓			✓	✓	✓
FPPS-0	✓		✓					✓	✓	✓
FPPO	✓		✓			✓		✓		✓

Nummernschlüssel FIPLOCK® Wellrohre

Part numbering key FIPLOCK® corrugated conduits



1 Ausführung / Model

- F** = FIPLOCK® Standardgewicht
FIPLOCK® standard weight
- H** = FIPLOCK® Mittel- bis Schwergewicht
FIPLOCK® medium to heavy weight
- L** = FIPLOCK® Leichtgewicht
FIPLOCK® light weight

2 Material / Material type

- PAN** = PA6 MOD
- PAS** = PA6 MOD BS
- PAF** = PA6 MOD V0
- PAC** = PA6 MOD BS C
- PDA** = PA12 MOD ESD
- PDS** = PA12 MOD BS
- PDF** = PA12 MOD V0
- PDR** = PA12 MOD R
- PPO** = PP MOD
- PPS** = PP MOD BS
- PPS-U** = PP MOD BS UV
- PES** = PE LD BS
- EVS** = EVA

3 Rohrprofil / Profile

- F** = Feinprofil (kompatibel mit FIPLOCK® ONE)
Fine profile (compatible with FIPLOCK® ONE)
- C** = Grobprofil (kompatibel mit FIPLOCK® ONE)
Coarse profile (compatible with FIPLOCK® ONE)

5 Nennweite / Nominal width (NW)

- 07 – 48** = NW Standard
- 56 – 170** = NW XL

5 Farbe / Colour

- B** = Standard-Schwarz / *Standard black*
- G** = Standard-Grau / *Standard grey*
- U** = UV-Schwarz / *UV black*
- O2** = Spezialfarbe / *Special colour*
z. B. / e.g. O2 = ähnlich / *similar to RAL2003 (Orange)*

6 Verpackungseinheit (VE) / Packing units (PU)

- 50** = Rollen- oder Stücklänge
Coil length or length of pieces
- A** = Individuelle Verpackungseinheit
Individual packing units

F Feinprofil / *F fine profile*

Anwendungsbereiche:

für engere Biegeradien und geringere Biegesteifigkeit

Application areas:

for tighter bending radii and lower bending stiffness

Charakteristik Rohrprofil:

feinere Profilteilung über Wellenberg und Wellental

Characteristics profile:

fine profile pitch over convolution top and convolution bottom

Durch mehr Wellen pro Längeneinheit werden Biegespannungen optimal verteilt.

More convolutions per length provide an optimized distribution of bending stress to the material.

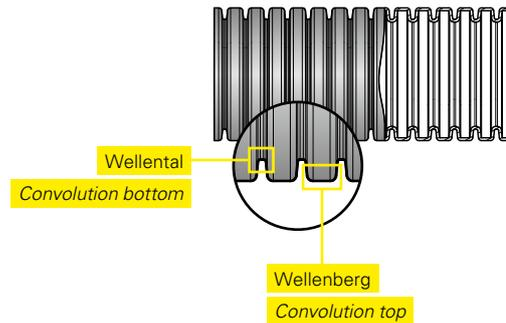

Kompatibel mit unseren FIPLOCK® ONE Wellrohranschlüssen

Compatible with our FIPLOCK® ONE fittings

C Grobprofil / *C coarse profile*

Anwendungsbereiche:

für erhöhte Ausreißkräfte bei hohen Belastungen

Application areas:

increased pull out forces at heavy loads

Charakteristik Rohrprofil:

grobe Profilteilung über Wellenberg und Wellental

Characteristics profile:

coarse profile pitch over convolution top and convolution bottom

Durch weniger Wellen pro Längeneinheit wird die Streckung des Wellrohres unter Zugbelastung reduziert.

Less convolutions per length reduces the conduit elongation under pulling forces.

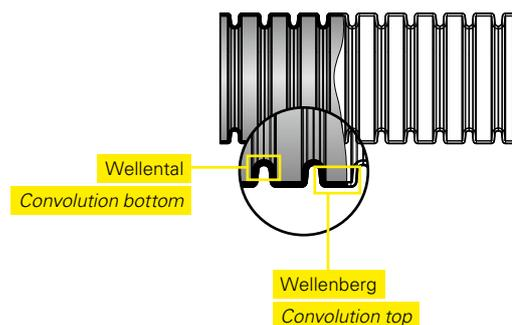

Kompatibel mit unseren FIPLOCK® ONE Wellrohranschlüssen

Compatible with our FIPLOCK® ONE fittings

FPAS

+120 °C +248 °F
-45 °C -49 °F



Allrounder für vielseitige Kabelschutzanwendungen
Allrounder for various cable protection applications

Material: PA6 MOD BS



- selbstverlöschend, halogen- und cadmiumfrei
- ausgezeichnete Schlagzähigkeit, Druckfestigkeit
- gute Flexibilität
- sehr gute chemische Beständigkeit
- gute Witterungseigenschaften und UV-Beständigkeit
- einsetzbar im Maschinen-, Apparate und Installationsbau sowie in der Bahntechnik
- *self-extinguishing, free of halogen and cadmium*
- *excellent impact resistance, compression strength*
- *good flexibility quality*
- *very good chemical resistance*
- *good weathering performances and UV-resistance*
- *suitable for machine building, installation and construction industries, as well as railway technology*

Download
FPAS

Das Datenblatt zu unserem Wellrohr FPAS finden Sie hier.

The datasheet of our corrugated conduit FPAS can be found here.



Sie interessieren sich für unsere FIPLOCK® Produkte? Klicken Sie hier zur **Direktanfrage**.
*You are interested in our FIPLOCK® products? Please click here for **direct inquiry**.*

FPAC

+105 °C +221 °F
-50 °C -58 °F

Wellrohr einsetzbar auch bei tiefen Temperaturen
Corrugated conduit suitable also at low temperatures

Material: PA6 MOD BS C



- selbstverlöschend, halogen- und cadmiumfrei
- gute Flexibilität
- gute chemische Beständigkeit
- hervorragende dynamische und mechanische Eigenschaften auch bei tiefen Temperaturen

- self-extinguishing, free of halogen and cadmium
- good flexibility quality
- good chemical resistance
- very good dynamic and mechanical characteristics also at very low temperature

Download
FPAC

Das Datenblatt zu unserem Wellrohr FPAC finden Sie hier.

The datasheet of our corrugated conduit FPAC can be found here.



Sie interessieren sich für unsere FIPLOCK® Produkte? Klicken Sie hier zur **Direktanfrage**.

*You are interested in our FIPLOCK® products? Please click here for **direct inquiry**.*

HPAC

+105 °C +221 °F
-50 °C -58 °F

Wellrohr einsetzbar auch bei tiefen Temperaturen
in schwerer Ausführung
*Corrugated conduit suitable also at low temperatures
in heavy version*

Material: PA6 MOD BS C



- selbstverlöschend, halogen- und cadmiumfrei
- mit erhöhter Wandstärke
- für statische Anwendungen
- gute chemische Beständigkeit
- exzellente Schlag- und Druckfestigkeit
- hervorragende mechanische Eigenschaften bei tiefen Temperaturen

- self-extinguishing, free of halogen and cadmium
- with increased wall thickness
- for static applications
- excellent impact resistance and compression strength
- good chemical resistance
- very good mechanical characteristics at very low temperature

Download
HPAC

Das Datenblatt zu unserem Wellrohr HPAC finden Sie hier.

The datasheet of our corrugated conduit HPAC can be found here.



FPAF

+120 °C +248 °F
-45 °C -49 °F



Wellrohr mit ausgezeichneten Brandschutzeigenschaften

Corrugated conduit with excellent fire protection characteristics

Material: PA6 MOD V0



- halogen- und cadmiumfrei
- flexibel
- geringe Rauchgasentwicklung
- gute chemische Beständigkeit
- für Anwendungen mit höchsten brandschutztechnischen Anforderungen im Personentransportwesen, Bahntechnik
- free of halogen and cadmium
- flexible
- low fire hazard characteristics
- good chemical resistance
- for applications with a high demanded for fire safety performances like public transports and rolling stock applications



Download
FPAF

Das Datenblatt zu unserem Wellrohr FPAF finden Sie hier.

The datasheet of our corrugated conduit FPAF can be found here.

Sie interessieren sich für unsere FIPLOCK® Produkte? Klicken Sie hier zur **Direktanfrage**.
*You are interested in our FIPLOCK® products? Please click here for **direct inquiry**.*

HPAF

+120 °C +248 °F
-45 °C -49 °F



Wellrohr mit ausgezeichneten Brandschutzeigenschaften in schwerer Ausführung

Corrugated conduit with excellent fire protection characteristics in heavy version

Material: PA6 MOD V0



- halogen- und cadmiumfrei
- mit erhöhter Wandstärke
- geringe bis gute Flexibilität
- geringe Rauchgasentwicklung
- gute chemische Beständigkeit
- für Anwendungen mit höchsten brandschutztechnischen Anforderungen im Personentransportwesen, Bahntechnik
- free of halogen and cadmium
- with increased wall thickness
- marginal to low flexibility
- low fire hazard characteristics
- good chemical resistance
- for applications with a high demanded for fire safety performances like public transports and rolling stock applications



Download
HPAF

Das Datenblatt zu unserem Wellrohr HPAF finden Sie hier.

The datasheet of our corrugated conduit HPAF can be found here.

FPAN

+120 °C +248 °F
-45 °C -49 °F

Wellrohr für den industriellen Maschinenbau
Corrugated conduit for industrial machine building

Material: PA6 MOD



- selbstverlöschend, halogen- und cadmiumfrei
- ausgezeichnete Schlagzähigkeit, Druckfestigkeit
- gute Flexibilität
- sehr gute chemische Beständigkeit
- gute Witterungseigenschaften
- einsetzbar im Maschinen-, Apparate und Installationsbau
- *self-extinguishing, free of halogen and cadmium*
- *excellent impact resistance, compression strength*
- *good flexibility quality*
- *very good chemical resistance*
- *good weathering performances*
- *suitable for machine building, installation and construction industries*



Download
FPAN

Das Datenblatt zu unserem Wellrohr FPAN finden Sie hier.

The datasheet of our corrugated conduit FPAN can be found here.

Sie interessieren sich für unsere FIPLOCK® Produkte? Klicken Sie hier zur **Direktanfrage**.
*You are interested in our FIPLOCK® products? Please click here for **direct inquiry**.*

FPAN-O

+120 °C +248 °F
-45 °C -49 °F

Wellrohr in Orange für Kabelschutzanwendungen
Corrugated conduit in orange colour for cable protection applications

Material: PA6 MOD Orange ähnlich RAL2003 or 2009 / PA6 MOD orange similar to RAL2003 or 2009



- selbstverlöschend, halogen- und cadmiumfrei
- ausgezeichnete Schlagzähigkeit, Druckfestigkeit
- gute Flexibilität
- sehr gute chemische Beständigkeit
- gute Witterungseigenschaften
- *self-extinguishing, free of halogen and cadmium*
- *excellent impact resistance, compression strength*
- *good flexibility quality*
- *very good chemical resistance*
- *good weathering performances*



Download
FPAN-O

Das Datenblatt zu unserem Wellrohr FPAN-O finden Sie hier.

The datasheet of our corrugated conduit FPAN-O can be found here.

FPDS

+110 °C +230 °F
-50 °C -58 °F

Wellrohr mit ausgezeichneter Wechselbiegefestigkeit und Witterungsbeständigkeit

Corrugated conduit with excellent fatigue strength and weathering resistance

Material: PA12 MOD BS



- selbstverlöschend, halogen- und cadmiumfrei
- ausgezeichnete Wechselbiegefestigkeit
- hervorragende mechanische Eigenschaften auch bei tiefen Temperaturen und extremer Trockenheit
- exzellente UV-/Witterungs- und chemische Beständigkeit
- für dauernd bewegte Anwendungen geeignet
- *self-extinguishing, free of halogen and cadmium*
- *excellent fatigue strength*
- *magnificent mechanical strength regarding physical impacts also in cold and dry environments*
- *excellent UV/weather and chemical resistance*
- *suitable for continuous dynamic flexing movements*



Download
FPDS

Das Datenblatt zu unserem Wellrohr FPDS finden Sie hier.

The datasheet of our corrugated conduit FPDS can be found here.

Sie interessieren sich für unsere FIPLOCK® Produkte? Klicken Sie hier zur **Direktanfrage**.

*You are interested in our FIPLOCK® products? Please click here for **direct inquiry**.*

HPDS

+110 °C +230 °F
-50 °C -58 °F

Wellrohr mit ausgezeichneter Wechselbiegefestigkeit und Witterungsbeständigkeit in schwerer Ausführung

Corrugated conduit with excellent fatigue strength and weathering resistance in heavy version

Material: PA12 MOD BS



- halogen- und cadmiumfrei
- mit erhöhter Wandstärke
- hohe mechanische Festigkeit auch bei tiefen Temperaturen
- hohe dynamische Wechselbiegefestigkeit
- gute Brandschutzeigenschaften
- für erhöhte Kabelschutzanforderungen unter widrigsten Umgebungsbedingungen geeignet
- *free of halogen and cadmium*
- *with increased wall thickness*
- *high mechanical strength also at low temperatures*
- *high dynamic fatigue strength*
- *good fire precaution performance*
- *suitable for technically most demanding applications*



Download
HPDS

Das Datenblatt zu unserem Wellrohr HPDS finden Sie hier.

The datasheet of our corrugated conduit HPDS can be found here.

FPDF

+110 °C +230 °F
-50 °C -58 °F

Wellrohr mit hervorragenden Flammeigenschaften
Corrugated conduit with magnificent flame properties

Material: PA12 MOD V0



- selbstverlöschend, halogen- und cadmiumfrei
- höchste Brandschutzeigenschaften
- hervorragende dynamische Wechselbiegefestigkeit
- hervorragende mechanische Eigenschaften auch bei tiefen Temperaturen oder extremer Trockenheit
- exzellente UV-/Witterungs- und chemische Beständigkeit
- besonders für dauerhaft bewegte Verbindungen geeignet
- *self-extinguishing, free of halogen and cadmium*
- *highest fire precaution performance*
- *excellent dynamic fatigue strength*
- *magnificent mechanical strength regarding physical impacts also in cold or dry environments*
- *excellent UV/weather and chemical resistance*
- *suitable for continuously moving applications*



Download
FPDF

Das Datenblatt zu unserem Wellrohr FPDF finden Sie hier.

The datasheet of our corrugated conduit FPDF can be found here.

Sie interessieren sich für unsere FIPLOCK® Produkte? Klicken Sie hier zur **Direktanfrage**.
*You are interested in our FIPLOCK® products? Please click here for **direct inquiry**.*

HPDF

+110 °C +230 °F
-50 °C -58 °F

Wellrohr mit hervorragenden Flammeigenschaften
in schwerer Ausführung
*Corrugated conduit with magnificent flame properties
in heavy version*

Material: PA12 MOD V0



- selbstverlöschend, halogen- und cadmiumfrei
- exzellente UV-/Witterungs- und chemische Beständigkeit
- höchste Brandschutzeigenschaften
- äußerst geringe Rauchgasentwicklung
- hohe dynamische Wechselbiegefestigkeit
- sehr gute mechanische Eigenschaften
- für anspruchsvolle technische Anforderungen geeignet
- *self-extinguishing, free of halogen and cadmium*
- *excellent UV/weather and chemical resistance*
- *highest fire protection characteristics*
- *extremely low smoke production*
- *high dynamic fatigue strength*
- *very good complementary mechanical performances*
- *suitable for cable protection applications where low fire hazard is mandatory*



Download
HPDF

Das Datenblatt zu unserem Wellrohr HPDF finden Sie hier.

The datasheet of our corrugated conduit HPDF can be found here.

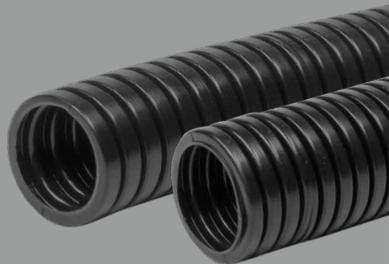

FPDA

Antistatisches Wellrohr für ESD-Anwendungen
Antistatic conduit for ESD applications

+90 °C +194 °F
 -45 °C -49 °F



Material: PA12 MOD ESD



- selbstverlöschend, halogen- und cadmiumfrei
- sehr hohe dynamische Wechselbiegefestigkeit
- gute mechanische Eigenschaften auch bei tiefen Temperaturen und extremer Trockenheit
- hervorragende UV-/Witterungsbeständigkeit
- für anspruchsvolle Anwendungen in denen elektrostatische Aufladungen und unkontrollierte Entladungen vermieden werden müssen

- *self-extinguishing, free of halogen and cadmium*
- *very good dynamic fatigue strength*
- *good mechanical strenght regarding physical impacts also in cold or dry environments*
- *excellent UV/weathering performances*
- *for demanding applications where electro static charge and uncontrolled discharge have to be avoided*

Download
FPDA

Das Datenblatt zu unserem Wellrohr FPDA finden Sie hier.

The datasheet of our corrugated conduit FPDA can be found here.



Sie interessieren sich für unsere FIPLOCK® Produkte? Klicken Sie hier zur **Direktanfrage**.
*You are interested in our FIPLOCK® products? Please click here for **direct inquiry**.*

FPPS-U

+105 °C +221 °F
-40 °C -40 °F

Wellrohr für vielseitige Außenanwendungen
Corrugated conduit for versatile outdoor applications

Material: PP MOD BS UV



- selbstverlöschend, halogen- und cadmiumfrei
- sehr gute dynamische Wechselbiegefestigkeit
- sehr gute chemische Beständigkeit
- sehr gute Witterungseigenschaften und UV-Beständigkeit
- self-extinguishing, free of halogen and cadmium
- very good dynamic fatigue strength
- good chemical resistance
- good weathering performances and UV-resistance

Download
FPPS-U

Das Datenblatt zu unserem Wellrohr FPPS-U finden Sie hier.

The datasheet of our corrugated conduit FPPS-U can be found here.



Sie interessieren sich für unsere FIPLOCK® Produkte? Klicken Sie hier zur **Direktanfrage**.
*You are interested in our FIPLOCK® products? Please click here for **direct inquiry**.*

FPPS-O

+105 °C +221 °F
-40 °C -40 °F

Wellrohr in Orange zum Kennzeichnen von Leitungen
Corrugated conduit in orange for marking wiring

Material: PP MOD BS Orange ähnl. RAL2003 / PP MOD BS orange similar to RAL2003



- selbstverlöschend, halogen- und cadmiumfrei
- gute dynamische Wechselbiegefestigkeit
- sehr gute chemische Beständigkeit
- gute Witterungseigenschaften
- self-extinguishing, free of halogen and cadmium
- good dynamic fatigue strength
- good chemical resistance
- good weathering performances

Download
FPPS-O

Das Datenblatt zu unserem Wellrohr FPPS-O finden Sie hier.

The datasheet of our corrugated conduit FPPS-O can be found here.



FPPO

+105 °C +221 °F
-40 °C -40 °F



Wellrohr für leichte dynamische Anwendungen
Corrugated conduit for light dynamic applications

Material: PP MOD



- selbstverlöschend, halogen- und cadmiumfrei
- gute dynamische Wechselbiegefestigkeit
- sehr gute chemische Beständigkeit
- gute Witterungseigenschaften

- *self-extinguishing, free of halogen and cadmium*
- *good dynamic fatigue*
- *good chemical resistance*
- *good weathering performances*

Download
FPPO

Das Datenblatt zu unserem Wellrohr FPPO finden Sie hier.

The datasheet of our corrugated conduit FPPO can be found here.



Sie interessieren sich für unsere FIPLOCK® Produkte? Klicken Sie hier zur **Direktanfrage**.
*You are interested in our FIPLOCK® products? Please click here for **direct inquiry**.*

EN45545-2 APPROVED

Flexibles PA12-Wellrohr mit HL3-Zulassung gesucht?

Searching for a flexible PA12 corrugated conduit with HL3 approval?

Wir haben die Lösung: FIPLOCK® HPDF
We have the solution: FIPLOCK® HPDF

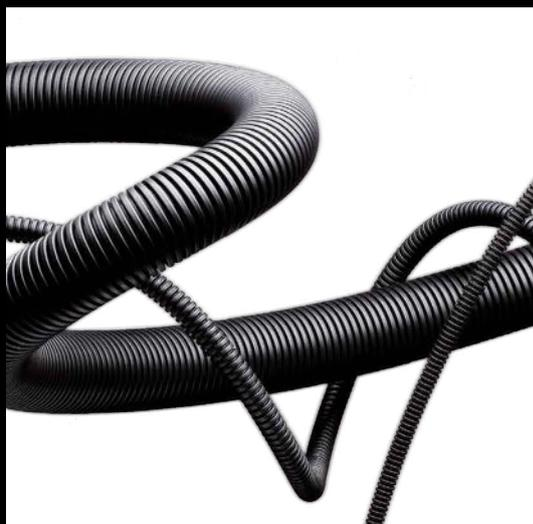

- höchste Brandschutzwerte kompatibel zur höchsten Gefährdungsstufe HL3 gemäß EN45545-2
highest fires safety performances compatible to the highest hazard level HL3 according to EN45545-2
- halogen- und cadmiumfrei
free from halogens and cadmium
- 40 Jahre UV-beständig
UV-resistant for 40 years
- hochflexibles PA12
flexible PA12
- sehr gute chemische Beständigkeit
very good chemical resistance

FIPLOCK®



Wellrohranschlüsse

Fittings

zum FIPLOCK® Produktprogramm / for FIPLOCK® product range



Produktübersicht / Product overview

Produkt Product	Ausführung Version	Material Grundkörper Material body	Material Gewinde Material thread	Rohrprofil Profile	Seite Page
ASPA	M	PA6 MOD V0 SGA	Kunststoff / Plastic	F/C	34
	MMK	PA6 MOD V0 SGA	Metall kurz / Metal short	F/C	35
	MML	PA6 MOD V0 SGA	Metall lang / Metal long	F/C	35
	PG	PA6 MOD V0 SGA	Kunststoff / Plastic	F/C	36
	PGM	PA6 MOD V0 SGA	Metall / Metal	F/C	36
	NPT	PA6 MOD V0 SGA	Kunststoff / Plastic	F/C	37
AWPA/AEPA	M	PA6 MOD V0 SGA	Kunststoff / Plastic	F/C	38
	MMK	PA6 MOD V0 SGA	Metall kurz / Metal short	F/C	39
	MML	PA6 MOD V0 SGA	Metall lang / Metal long	F/C	39
	PG	PA6 MOD V0 SGA	Kunststoff / Plastic	F/C	40
	PGM	PA6 MOD V0 SGA	Metall / Metal	F/C	40
	NPT	PA6 MOD V0 SGA	Kunststoff / Plastic	F/C	41
AAPA	M	PA6 MOD V0 SGA	Kunststoff / Plastic	F/C	42
	MMK	PA6 MOD V0 SGA	Metall kurz / Metal short	F/C	43
	MML	PA6 MOD V0 SGA	Metall lang / Metal long	F/C	43
	PG	PA6 MOD V0 SGA	Kunststoff / Plastic	F/C	44
	PGM	PA6 MOD V0 SGA	Metall / Metal	F/C	44
	NPT	PA6 MOD V0 SGA	Kunststoff / Plastic	F/C	45
AFPA	M	PA6 MOD V0 SGA	Kunststoff / Plastic	F/C	46
	MM	PA6 MOD V0 SGA	Metall / Metal	F/C	46
	PG	PA6 MOD V0 SGA	Kunststoff / Plastic	F/C	47
	PGM	PA6 MOD V0 SGA	Metall / Metal	F/C	47



FIPLOCK[®] ONE

Sie interessieren sich für unsere Produkte?
 Klicken Sie hier zur **Direktanfrage**.
 You are interested in our products?
 Please click here for **direct inquiry**.

Produkt Product	Ausführung Version	Material Grundkörper Material bodypart	Material Gewinde Material thread	Rohrprofil Profile	Seite Page
AFPA	U-M	PA6 MOD V0 SGA	Kunststoff / Plastic	F/C	48
	U-A	PA6 MOD V0 SGA	Kunststoff / Plastic	F/C	49
	U-B	PA6 MOD V0 SGA	Kunststoff / Plastic	F/C	49
AZPA	M	PA6 MOD V0 SGA	Kunststoff / Plastic	F/C	50
	C	PA6 MOD V0 SGA	Kunststoff / Plastic	F/C	50
	MMK	PA6 MOD V0 SGA	Metall kurz / Metal short	F/C	51
	MML	PA6 MOD V0 SGA	Metall lang / Metal long	F/C	51
	PG	PA6 MOD V0 SGA	Kunststoff / Plastic	F/C	52
	PGM	PA6 MOD V0 SGA	Metall / Metal	F/C	52
	NPT	PA6 MOD V0 SGA	Kunststoff / Plastic	F/C	53
	NPTM	PA6 MOD V0 SGA	Metall / Metal	F/C	53
ATPA	–	PA6 MOD V0 SGA	–	F/C	54
ATPA-CA	–	PA6 MOD V0 SGA	–	F/C	54
AYPA	–	PA6 MOD V0 SGA	–	F/C	55
ARPA	–	PA6 MOD V0 SGA	–	F/C	55
AIPA	M	PA6 MOD V0 SGA	–	F/C	56
	PG	PA6 MOD V0 SGA	–	F/C	56
ACPA	–	PA6 MOD V0 SGA	–	F/C	57
ACPA-SH	–	PA6 MOD V0 SGA	–	F/C	57
APPA	EPDM	PA6 MOD V0 SGA	Kunststoff / Plastic	F/C	58
	NBR	PA6 MOD V0 SGA	Kunststoff / Plastic	F/C	58
ASPA-HV	–	PA6 MOD V0 SGA	Kunststoff / Plastic	F/C	59

Nummernschlüssel FIPLOCK® ONE Wellrohranschlüsse

Part numbering key FIPLOCK® ONE fittings

1 2 3 4 5 6 7 8 9
A **S** **PA** – **23** **M** **32** **P** **B** – **08**

1 Wellrohranschluss-Linie / Fitting line

A = FIPLOCK® ONE Wellrohranschluss
FIPLOCK® ONE fitting

2 Wellrohranschluss-Typ / Fitting type

S = gerade / straight
E = 90° Bogenwinkel / 90° curved elbow
W = 90° Winkel / 90° elbow
A = 45° Winkel / 45° elbow
F = mit Innengewinde, gerade
with female thread, straight
Z = Zugentlastung, gerade
Strain relief, straight
C = Rohrverbinder, gerade
Conduit splice fitting, straight
R = Wellrohrreduktion / Conduit reducer, straight
I = Verbinder zu Glattrohr, gerade
Interconnection to rigid pipes, straight
T = T-Verteiler / T-distributor
Y = Y-Verteiler / Y-distributor

3 Material / Material type

PA = PA6 MOD V0 SGA (FIPLOCK® ONE)

4 Nennweite / Nominal width (NW)

07 = kleinste NW / smallest NW
bis / to
48 = größte NW / largest NW
Verteiler / Distributors
231717 = NW 23 / NW 17 / NW 17

5 Gewindeart / Thread type

M = metrisch / metric
F = metrisch fein / metric fine
P = PG
N = NPT
U = UNEF / UNS / UN

6 Gewindegröße / Thread size

siehe Gewindeübersicht auf Seite 31
see thread table on page 31

7 Gewindematerial / Thread material

P = Kunststoff / Plastic
M = Metall / Metal

8 Farbe / Colour

B = Standard-Schwarz / Standard black
G = Standard-Grau / Standard grey

9 Gewindelänge oder Modifikationscode Thread length or modification code

Gewindeübersicht

Thread codes

Typ Type	Gewindegröße Thread size	Nummernschlüssel Part numbering key
M = metrisch metric EN 60423	M12x1,5	M12
	M16x1,5	M16
	M20x1,5	M20
	M25x1,5	M25
	M32x1,5	M32
	M40x1,5	M40
	M50x1,5	M50
	M63x1,5	M63
F = fein metrisch fine metric DIN 13-5	M08x1	F08
	M12x1	F12
	M18x1	F18
	M30x1	F30
P = PG DIN 40430	PG7	P07
	PG9	P09
	PG11	P11
	PG13,5	P13
	PG16	P16
	PG21	P21
	PG29	P29
	PG36	P36
	PG42	P42
PG48	P48	
U = UNEF ANSI/ASME B1.1 female	1/4"-32 UNEF	U06
	5/16"-32 UNEF	U08
	3/8"-32 UNEF	U09
	7/16"-28 UNEF	U11
	1/2"-28 UNEF	U12
	9/16"-24 UNEF	U13
	5/8"-24 UNEF	U15
	11/16" UNEF	U16
	3/4"-20 UNEF	U18
	13/16"-20 UNEF	U20
	7/8"-20 UNEF	U21
	15/16"-20 UNEF	U23
	1"-20 UNEF	U24

Typ Type	Gewindegröße Thread size	Nummernschlüssel Part numbering key
U = UNEF ANSI/ASME B1.1 female	1-1/16"-18 UNEF	U26
	1-1/8"-18 UNEF	U28
	1-3/16"-18 UNEF	U29
	1-1/4"-18 UNEF	U30
	1-5/16"-18 UNEF	U32
	1-3/8"-18 UNEF	U34
	1-7/16"-18 UNEF	U35
	1-1/2"-18 UNEF	U36
	1-9/16"-18 UNEF	U39
	1-5/8"-18 UNEF	U40
	1-11/16"-18 UNEF	U41
	1-3/4"-18 UNS	U43
	2"-18 UNS	U50
	2-1/4"-16 UN	U56
	2-1/2"-16UN	U62
G = Gas DIN ISO 228 (DIN 259)	Gas 1/4"	G00
	Gas 3/8"	G01
	Gas 1/2"	G02
	Gas 3/4"	G04
	Gas 1"	G06
	Gas 1-1/4"	G07
	Gas 1-1/2"	G08
	Gas 2"	G09
	Gas 2-1/4"	G10
Gas 2-1/2"	G11	
N = NPT ANSI/ASME B1.20.1	NPT 3/8"	N01
	NPT 1/2"	N02
	NPT 3/4"	N04
	NPT 1"	N06
	NPT 1-1/4"	N07
	NPT 1-1/2"	N08
	NPT 2"	N09

IP-Schutzarten nach EN60529

Ingress protection (IP) according to EN60529

Beispiel IP69 / *Example IP69*

IP 6 9

Erste Ziffer: staubdicht _____

First digit: protected against penetration of dust

Zweite Ziffer: Hochdruck, Dampfstrahl-Reinigung

Second digit: high pressure steam cleaner

Erste Ziffer / <i>First digit</i>		Zweite Ziffer / <i>Second digit</i>	
0	nicht geschützt <i>not protected</i>	0	nicht geschützt <i>not protected</i>
1	mit Durchmesser ≥ 50 mm <i>with diameter ≥ 50 mm</i>	1	senkrecht Tropfen <i>vertical water drips</i>
2	mit Durchmesser $\geq 12,5$ mm <i>with diameter $\geq 12,5$ mm</i>	2	Tropfen (15° Neigung des Prüflings) <i>drips (up to 15° angle)</i>
3	mit Durchmesser $\geq 2,5$ mm <i>with diameter $\geq 2,5$ mm</i>	3	Sprühwasser (schräg bis 60°) <i>spray water (up to 60° angle)</i>
4	mit Durchmesser $\geq 1,0$ mm <i>with diameter $\geq 1,0$ mm</i>	4	Spritzwasser <i>splashed water</i>
5	staubgeschützt <i>protected against dust</i>	5	Strahlwasser <i>strong water jet</i>
6	staubdicht <i>protected against penetration of dust</i>	6	starkes Strahlwasser mit erhöhtem Druck <i>strong water jet with pressure</i>
		7	zeitweiliges Eintauchen <i>temporary immersion</i>
		8	dauerndes Untertauchen <i>continuous immersion</i>
		9	Hochdruck, Dampfstrahl-Reinigung <i>high pressure steam cleaner</i>

Anwendungsbereiche / *Applications*

Unsere FIPLOCK® ONE Wellrohranschlüsse sind für eine Vielzahl individueller Anschlusslösungen mit unseren FIPLOCK® Wellrohren geeignet:

Our FIPLOCK® ONE fittings are suitable for a wide range of individual adaptation solutions with our FIPLOCK® corrugated conduits:



FRÄNKISCHE

INDUSTRIAL PIPES

Hervorragende Auszugskräfte
Excellent pull out strength

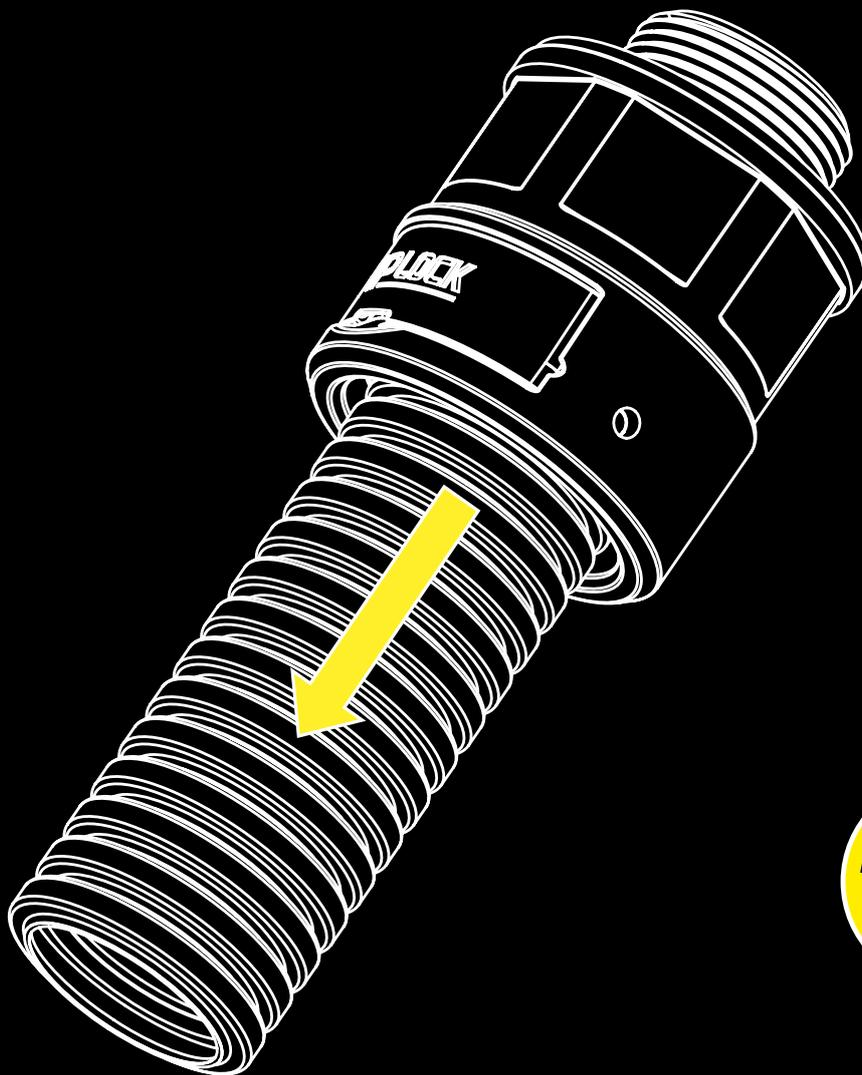

FIPLock[®] ONE





ASPA-M

+120 °C +248 °F
-50 °C -58 °F

Anschlussverschraubung gerade metrisch, Kunststoffgewinde

Fitting straight metric, plastic thread

Material: PA6 MOD V0 SGA



Download
ASPA-M

Das Datenblatt zu unserer Anschlussverschraubung ASPA-M finden Sie hier.

The datasheet of our fitting ASPA-M can be found here.

- gerade Verschraubung passend für FIPLOCK® Wellrohre mit Fein- und Grobprofil
- metrisches Kunststoffgewinde
- selbstverlöschend und beständig gegen die meisten gebräuchlichen Medien
- ausgezeichnete UV-Beständigkeit
- fertig konfektioniert in kleinen Verpackungseinheiten
- *straight fitting suitable for FIPLOCK® corrugated conduits with fine and coarse profile*
- *metric plastic thread*
- *self-extinguishing and resistant against most chemical media commonly used*
- *excellent UV-resistance*
- *pre-assembled in small packing units*



Sie interessieren sich für unsere FIPLOCK® ONE Produkte? Klicken Sie hier zur **Direktanfrage**.
*You are interested in our FIPLOCK® ONE products? Please click here for **direct inquiry**.*



ASP A-MMK

+120 °C +248 °F
-50 °C -58 °F

Anschlussverschraubung gerade metrisch, Metallgewinde, kurz

Fitting straight metric, metal thread, short

Material: PA6 MOD V0 SGA



- gerade Verschraubung passend für FIPLOCK® Wellrohre mit Fein- und Grobprofil
- metrisches Metallgewinde kurz
- selbstverlöschend und beständig gegen die meisten gebräuchlichen Medien
- ausgezeichnete UV-Beständigkeit
- fertig konfektioniert in kleinen Verpackungseinheiten
- *straight fitting suitable for FIPLOCK® corrugated conduits with fine and coarse profile*
- *metric short metal thread*
- *self-extinguishing and resistant against most chemical media commonly used*
- *excellent UV-resistance*
- *pre-assembled in small packing units*

Download
ASP A-MMK

Das Datenblatt zu unserer Anschlussverschraubung ASP A-MMK finden Sie hier.

The datasheet of our fitting ASP A-MMK can be found here.



Sie interessieren sich für unsere FIPLOCK® ONE Produkte? Klicken Sie hier zur **Direktanfrage**.

*You are interested in our FIPLOCK® ONE products? Please click here for **direct inquiry**.*



ASP A-MML

+120 °C +248 °F
-50 °C -58 °F

Anschlussverschraubung gerade metrisch, Metallgewinde, lang

Fitting straight metric, metal thread, long

Material: PA6 MOD V0 SGA



- gerade Verschraubung passend für FIPLOCK® Wellrohre mit Fein- und Grobprofil
- metrisches Metallgewinde lang
- selbstverlöschend und beständig gegen die meisten gebräuchlichen Medien
- ausgezeichnete UV-Beständigkeit
- fertig konfektioniert in kleinen Verpackungseinheiten
- *straight fitting suitable for FIPLOCK® corrugated conduits with fine and coarse profile*
- *metric long metal thread*
- *self-extinguishing and resistant against most chemical media commonly used*
- *excellent UV-resistance*
- *pre-assembled in small packing units*

Download
ASP A-MML

Das Datenblatt zu unserer Anschlussverschraubung ASP A-MML finden Sie hier.

The datasheet of our fitting ASP A-MML can be found here.





ASPA-PG

+120 °C +248 °F
-50 °C -58 °F

Anschlussverschraubung gerade
PG, Kunststoffgewinde
*Fitting straight
PG, plastic thread*

Material: PA6 MOD V0 SGA

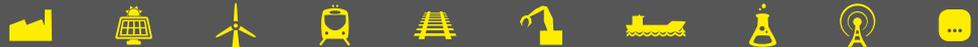

- gerade Verschraubung passend für FIPLOCK® Wellrohre mit Fein- und Grobprofil
- PG-Kunststoffgewinde
- selbstverlöschend und beständig gegen die meisten gebräuchlichen Medien
- ausgezeichnete UV-Beständigkeit
- fertig konfektioniert in kleinen Verpackungseinheiten
- *straight fitting suitable for FIPLOCK® corrugated conduits with fine and coarse profile*
- *PG plastic thread*
- *self-extinguishing and resistant against most chemical media commonly used*
- *excellent UV-resistance*
- *pre-assembled in small packing units*

Download
ASPA-PG

Das Datenblatt zu unserer Anschlussverschraubung ASPA-PG finden Sie hier.

The datasheet of our fitting ASPA-PG can be found here.



Sie interessieren sich für unsere FIPLOCK® ONE Produkte? Klicken Sie hier zur **Direktanfrage**.
*You are interested in our FIPLOCK® ONE products? Please click here for **direct inquiry**.*



ASPA-PGM

+120 °C +248 °F
-50 °C -58 °F

Anschlussverschraubung gerade
PG, Metallgewinde
*Fitting straight
PG, metal thread*

Material: PA6 MOD V0 SGA



- gerade Verschraubung passend für FIPLOCK® Wellrohre mit Fein- und Grobprofil
- PG-Metallgewinde
- selbstverlöschend und beständig gegen die meisten gebräuchlichen Medien
- ausgezeichnete UV-Beständigkeit
- fertig konfektioniert in kleinen Verpackungseinheiten
- *straight fitting suitable for FIPLOCK® corrugated conduits with fine and coarse profile*
- *PG metal thread*
- *self-extinguishing and resistant against most chemical media commonly used*
- *excellent UV-resistance*
- *pre-assembled in small packing units*

Download
ASPA-PGM

Das Datenblatt zu unserer Anschlussverschraubung ASPA-PGM finden Sie hier.

The datasheet of our fitting ASPA-PGM can be found here.





ASPA-NPT

Anschlussverschraubung gerade
NPT, Kunststoffgewinde

*Fitting straight
NPT, plastic thread*

Material: PA6 MOD V0 SGA

+120 °C +248 °F
-50 °C -58 °F



Download
ASPA-NPT

Das Datenblatt zu unserer Anschlussverschraubung ASPA-NPT finden Sie hier.

The datasheet of our fitting ASPA-NPT can be found here.

- gerade Verschraubung passend für FIPLOCK® Wellrohre mit Fein- und Grobprofil
- NPT-Kunststoffgewinde
- selbstverlöschend und beständig gegen die meisten gebräuchlichen Medien
- ausgezeichnete UV-Beständigkeit
- fertig konfektioniert in kleinen Verpackungseinheiten
- *straight fitting suitable for FIPLOCK® corrugated conduits with fine and coarse profile*
- *NPT plastic thread*
- *self-extinguishing and resistant against most chemical media commonly used*
- *excellent UV-resistance*
- *pre-assembled in small packing units*



Sie interessieren sich für unsere FIPLOCK® ONE Produkte? Klicken Sie hier zur **Direktanfrage**.
*You are interested in our FIPLOCK® ONE products? Please click here for **direct inquiry**.*

AWPA-M / AEPA-M

+120 °C +248 °F
-50 °C -58 °F

Anschlussverschraubung Bogenwinkel 90°
metrisch, Kunststoffgewinde

*Fitting 90° curved elbow
metric, plastic thread*

Material: PA6 MOD V0 SGA



- Verschraubung Bogenwinkel 90° passend für FIPLOCK® Wellrohre mit Fein- und Grobprofil
- metrisches Kunststoffgewinde
- selbstverlöschend und beständig gegen die meisten gebräuchlichen Medien
- ausgezeichnete UV-Beständigkeit
- fertig konfektioniert in kleinen Verpackungseinheiten
- *fitting 90° curved elbow suitable for FIPLOCK® corrugated conduits with fine and coarse profile*
- *metric plastic thread*
- *self-extinguishing and resistant against most chemical media commonly used*
- *excellent UV-resistance*
- *pre-assembled in small packing units*



Download
AWPA-/AEPA-M

Das Datenblatt zu unsere Anschlussverschraubung AWPA-/AEPA-M finden Sie hier.

The datasheet of our fitting AWPA-/AEPA-M can be found here.

Sie interessieren sich für unsere FIPLOCK® ONE Produkte? Klicken Sie hier zur **Direktanfrage**.
*You are interested in our FIPLOCK® ONE products? Please click here for **direct inquiry**.*

AWPA-MMK / AEPA-MMK

+120 °C +248 °F
-50 °C -58 °F

Anschlussverschraubung Bogenwinkel 90°
metrisch, Metallgewinde, kurz

*Fitting 90° curved elbow
metric, metal thread, short*

Material: PA6 MOD V0 SGA



- Verschraubung Bogenwinkel 90° passend für FIPLOCK® Wellrohre mit Fein- und Grobprofil
- metrisches Metallgewinde kurz
- selbstverlöschend und beständig gegen die meisten gebräuchlichen Medien
- ausgezeichnete UV-Beständigkeit
- fertig konfektioniert in kleinen Verpackungseinheiten
- *fitting 90° curved elbow suitable for FIPLOCK® corrugated conduits with fine and coarse profile*
- *metric short metal thread*
- *self-extinguishing and resistant against most chemical media commonly used*
- *excellent UV-resistance*
- *pre-assembled in small packing units*



Download
AWPA-/AEPA-MMK

Das Datenblatt zu unsere Anschlussverschraubung AWPA-/AEPA-MMK finden Sie hier.

The datasheet of our fitting AWPA-/AEPA-MMK can be found here.

Sie interessieren sich für unsere FIPLOCK® ONE Produkte? Klicken Sie hier zur **Direktanfrage**.

*You are interested in our FIPLOCK® ONE products? Please click here for **direct inquiry**.*

AWPA-MML / AEPA-MML

+120 °C +248 °F
-50 °C -58 °F

Anschlussverschraubung Bogenwinkel 90°
metrisch, Metallgewinde, lang

*Fitting 90° curved elbow
metric, metal thread, long*

Material: PA6 MOD V0 SGA



- Verschraubung Bogenwinkel 90° passend für FIPLOCK® Wellrohre mit Fein- und Grobprofil
- metrisches Metallgewinde lang
- selbstverlöschend und beständig gegen die meisten gebräuchlichen Medien
- ausgezeichnete UV-Beständigkeit
- fertig konfektioniert in kleinen Verpackungseinheiten
- *fitting 90° curved elbow suitable for FIPLOCK® corrugated conduits with fine and coarse profile*
- *metric long metal thread*
- *self-extinguishing and resistant against most chemical media commonly used*
- *excellent UV-resistance*
- *pre-assembled in small packing units*



Download
AWPA-/AEPA-MML

Das Datenblatt zu unsere Anschlussverschraubung AWPA-/AEPA-MML finden Sie hier.

The datasheet of our fitting AWPA-/AEPA-MML can be found here.

AWPA-PG / AEPA-PG

+120 °C +248 °F
-50 °C -58 °F

Anschlussverschraubung Bogenwinkel 90°
PG, Kunststoffgewinde
*Fitting 90° curved elbow
PG, plastic thread*

Material: PA6 MOD V0 SGA

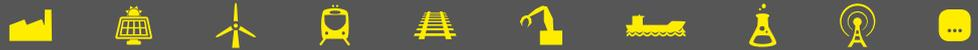

- Verschraubung Bogenwinkel 90° passend für FIPLOCK® Wellrohre mit Fein- und Grobprofil
- PG-Kunststoffgewinde
- selbstverlöschend und beständig gegen die meisten gebräuchlichen Medien
- ausgezeichnete UV-Beständigkeit
- fertig konfektioniert in kleinen Verpackungseinheiten
- *fitting 90° curved elbow suitable for FIPLOCK® corrugated conduits with fine and coarse profile*
- *PG plastic thread*
- *self-extinguishing and resistant against most chemical media commonly used*
- *excellent UV-resistance*
- *pre-assembled in small packing units*



Download
AWPA-/AEPA-PG

Das Datenblatt zu unsere Anschlussverschraubung AWPA-/AEPA-PG finden Sie hier.

The datasheet of our fitting AWPA-/AEPA-PG can be found here.

Sie interessieren sich für unsere FIPLOCK® ONE Produkte? Klicken Sie hier zur **Direktanfrage**.
*You are interested in our FIPLOCK® ONE products? Please click here for **direct inquiry**.*

AWPA-PGM / AEPA-PGM

+120 °C +248 °F
-50 °C -58 °F

Anschlussverschraubung Bogenwinkel 90°
PG, Metallgewinde
*Fitting 90° curved elbow
PG, metal thread*

Material: PA6 MOD V0 SGA



- Verschraubung Bogenwinkel 90° passend für FIPLOCK® Wellrohre mit Fein- und Grobprofil
- PG-Metallgewinde
- selbstverlöschend und beständig gegen die meisten gebräuchlichen Medien
- ausgezeichnete UV-Beständigkeit
- fertig konfektioniert in kleinen Verpackungseinheiten
- *fitting 90° curved elbow suitable for FIPLOCK® corrugated conduits with fine and coarse profile*
- *PG metal thread*
- *self-extinguishing and resistant against most chemical media commonly used*
- *excellent UV-resistance*
- *pre-assembled in small packing units*



Download
AWPA-/AEPA-PGM

Das Datenblatt zu unsere Anschlussverschraubung AWPA-/AEPA-PGM finden Sie hier.

The datasheet of our fitting AWPA-/AEPA-PGM can be found here.

AWPA-NPT / AEPA-NPT

+120 °C +248 °F
-50 °C -58 °F

Anschlussverschraubung Bogenwinkel 90°
NPT, Kunststoffgewinde
Fitting 90° curved elbow
NPT, plastic thread

Material: PA6 MOD V0 SGA



- Verschraubung Bogenwinkel 90° passend für FIPLOCK® Wellrohre mit Fein- und Grobprofil
- NPT-Kunststoffgewinde
- selbstverlöschend und beständig gegen die meisten gebräuchlichen Medien
- ausgezeichnete UV-Beständigkeit
- fertig konfektioniert in kleinen Verpackungseinheiten
- *fitting 90° curved elbow suitable for FIPLOCK® corrugated conduits with fine and coarse profile*
- *NPT plastic thread*
- *self-extinguishing and resistant against most chemical media commonly used*
- *excellent UV-resistance*
- *pre-assembled in small packing units*



Download
AWPA-/AEPA-NPT

Das Datenblatt zu unsere Anschlussverschraubung AWPA-/AEPA-NPT finden Sie hier.

The datasheet of our fitting AWPA-/AEPA-NPT can be found here.

Sie interessieren sich für unsere FIPLOCK® ONE Produkte? Klicken Sie hier zur **Direktanfrage**.
*You are interested in our FIPLOCK® ONE products? Please click here for **direct inquiry**.*



AAPA-M

Anschlussverschraubung Winkel 45°
metrisch, Kunststoffgewinde
*Fitting 45° elbow
metric, plastic thread*

Material: PA6 MOD V0 SGA

+120 °C +248 °F
-50 °C -58 °F



Download
AAPA-M

Das Datenblatt zu unsere Anschlussverschraubung AAPA-M finden Sie hier.

The datasheet of our fitting AAPA-M can be found here.

- Verschraubung Winkel 45° passend für FIPLOCK® Wellrohre mit Fein- und Grobprofil
- metrisches Kunststoffgewinde
- selbstverlöschend und beständig gegen die meisten gebräuchlichen Medien
- ausgezeichnete UV-Beständigkeit
- fertig konfektioniert in kleinen Verpackungseinheiten
- *fitting 45° elbow suitable for FIPLOCK® corrugated conduits with fine and coarse profile*
- *metric plastic thread*
- *self-extinguishing and resistant against most chemical media commonly used*
- *excellent UV-resistance*
- *pre-assembled in small packing units*



Sie interessieren sich für unsere FIPLOCK® ONE Produkte? Klicken Sie hier zur **Direktanfrage**.
*You are interested in our FIPLOCK® ONE products? Please click here for **direct inquiry**.*



AAPA-MMK

+120 °C +248 °F
-50 °C -58 °F

Anschlussverschraubung Winkel 45°
metrisch, Metallgewinde, kurz
*Fitting 45° elbow
metric, metal thread, short*

Material: PA6 MOD V0 SGA



- Verschraubung Winkel 45° passend für FIPLOCK® Wellrohre mit Fein- und Grobprofil
- metrisches Metallgewinde kurz
- selbstverlöschend und beständig gegen die meisten gebräuchlichen Medien
- ausgezeichnete UV-Beständigkeit
- fertig konfektioniert in kleinen Verpackungseinheiten
- fitting 45° elbow suitable for FIPLOCK® corrugated conduits with fine and coarse profile
- metric short metal thread
- self-extinguishing and resistant against most chemical media commonly used
- excellent UV-resistance
- pre-assembled in small packing units

Download
AAPA-MMK

Das Datenblatt zu unsere Anschlussverschraubung AAPA-MMK finden Sie hier.

The datasheet of our fitting AAPA-MMK can be found here.



Sie interessieren sich für unsere FIPLOCK® ONE Produkte? Klicken Sie hier zur **Direktanfrage**.
*You are interested in our FIPLOCK® ONE products? Please click here for **direct inquiry**.*



AAPA-MML

+120 °C +248 °F
-50 °C -58 °F

Anschlussverschraubung Winkel 45°
metrisch, Metallgewinde, lang
*Fitting 45° elbow
metric, metal thread, long*

Material: PA6 MOD V0 SGA



- Verschraubung Winkel 45° passend für FIPLOCK® Wellrohre mit Fein- und Grobprofil
- metrisches Metallgewinde lang
- selbstverlöschend und beständig gegen die meisten gebräuchlichen Medien
- ausgezeichnete UV-Beständigkeit
- fertig konfektioniert in kleinen Verpackungseinheiten
- fitting 45° elbow suitable for FIPLOCK® corrugated conduits with fine and coarse profile
- metric long metal thread
- self-extinguishing and resistant against most chemical media commonly used
- excellent UV-resistance
- pre-assembled in small packing units

Download
AAPA-MML

Das Datenblatt zu unsere Anschlussverschraubung AAPA-MML finden Sie hier.

The datasheet of our fitting AAPA-MML can be found here.





AAPA-PG

+120 °C +248 °F
-50 °C -58 °F

Anschlussverschraubung Winkel 45°
PG, Kunststoffgewinde
*Fitting 45° elbow
PG, plastic thread*

Material: PA6 MOD V0 SGA

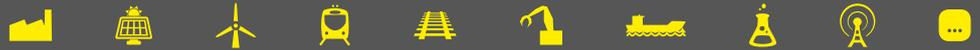

- Verschraubung Winkel 45° passend für FIPLOCK® Wellrohre mit Fein- und Grobprofil
- PG-Kunststoffgewinde
- selbstverlöschend und beständig gegen die meisten gebräuchlichen Medien
- ausgezeichnete UV-Beständigkeit
- fertig konfektioniert in kleinen Verpackungseinheiten
- *fitting 45° elbow suitable for FIPLOCK® corrugated conduits with fine and coarse profile*
- *PG plastic thread*
- *self-extinguishing and resistant against most chemical media commonly used*
- *excellent UV-resistance*
- *pre-assembled in small packing units*

Download
AAPA-PG

Das Datenblatt zu unsere Anschlussverschraubung AAPA-PG finden Sie hier.

The datasheet of our fitting AAPA-PG can be found here.



Sie interessieren sich für unsere FIPLOCK® ONE Produkte? Klicken Sie hier zur **Direktanfrage**.
*You are interested in our FIPLOCK® ONE products? Please click here for **direct inquiry**.*



AAPA-PGM

+120 °C +248 °F
-50 °C -58 °F

Anschlussverschraubung Winkel 45°
PG, Metallgewinde
*Fitting 45° elbow
PG, metal thread*

Material: PA6 MOD V0 SGA

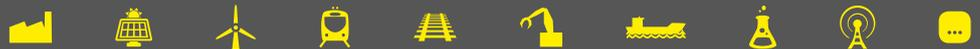

- Verschraubung Winkel 45° passend für FIPLOCK® Wellrohre mit Fein- und Grobprofil
- PG-Metallgewinde
- selbstverlöschend und beständig gegen die meisten gebräuchlichen Medien
- ausgezeichnete UV-Beständigkeit
- fertig konfektioniert in kleinen Verpackungseinheiten
- *fitting 45° elbow suitable for FIPLOCK® corrugated conduits with fine and coarse profile*
- *PG metal thread*
- *self-extinguishing and resistant against most chemical media commonly used*
- *excellent UV-resistance*
- *pre-assembled in small packing units*

Download
AAPA-PGM

Das Datenblatt zu unsere Anschlussverschraubung AAPA-PGM finden Sie hier.

The datasheet of our fitting AAPA-PGM can be found here.



AAPA-NPT

+120 °C +248 °F
-50 °C -58 °F

Anschlussverschraubung Winkel 45°
NPT, Kunststoffgewinde

*Fitting 45° elbow
NPT, plastic thread*

Material: PA6 MOD V0 SGA



- Verschraubung Winkel 45° passend für FIPLOCK® Wellrohre mit Fein- und Grobprofil
- NPT-Kunststoffgewinde
- selbstverlöschend und beständig gegen die meisten gebräuchlichen Medien
- ausgezeichnete UV-Beständigkeit
- fertig konfektioniert in kleinen Verpackungseinheiten
- fitting 45° elbow suitable for FIPLOCK® corrugated conduits with fine and coarse profile
- NPT plastic thread
- self-extinguishing and resistant against most chemical media commonly used
- excellent UV-resistance
- pre-assembled in small packing units



Download
AAPA-NPT

Das Datenblatt zu unsere Anschlussverschraubung AAPA-NPT finden Sie hier.

The datasheet of our fitting AAPA-NPT can be found here.

Sie interessieren sich für unsere FIPLOCK® ONE Produkte? Klicken Sie hier zur **Direktanfrage**.
*You are interested in our FIPLOCK® ONE products? Please click here for **direct inquiry**.*



AFPA-M

+120 °C +248 °F
-50 °C -58 °F

Verschraubung Innengewinde
gerade, metrisch, Kunststoffgewinde
*Fitting female thread
straight, metric, plastic thread*

Material: PA6 MOD V0 SGA



- Verschraubung Innengewinde passend für FIPLOCK® Wellrohre mit Fein- und Grobprofil
- metrisches Kunststoffgewinde
- selbstverlöschend und beständig gegen die meisten gebräuchlichen Medien
- ausgezeichnete UV-Beständigkeit
- fertig konfektioniert in kleinen Verpackungseinheiten
- *fitting female thread suitable for FIPLOCK® corrugated conduits with fine and coarse profile*
- *metric plastic thread*
- *self-extinguishing and resistant against most chemical media commonly used*
- *excellent UV-resistance*
- *pre-assembled in small packing units*

Download
AFPA-M

Das Datenblatt zu unsere Anschlussverschraubung AFPA-M finden Sie hier.

The datasheet of our fitting AFPA-M can be found here.



Sie interessieren sich für unsere FIPLOCK® ONE Produkte? Klicken Sie hier zur **Direktanfrage**.
*You are interested in our FIPLOCK® ONE products? Please click here for **direct inquiry**.*



AFPA-MM

+120 °C +248 °F
-50 °C -58 °F

Verschraubung Innengewinde
gerade, metrisch, Metallgewinde
*Fitting female thread
straight, metric, metal thread*

Material: PA6 MOD V0 SGA



- Verschraubung Innengewinde passend für FIPLOCK® Wellrohre mit Fein- und Grobprofil
- metrisches Metallgewinde
- selbstverlöschend und beständig gegen die meisten gebräuchlichen Medien
- ausgezeichnete UV-Beständigkeit
- fertig konfektioniert in kleinen Verpackungseinheiten
- *fitting female thread suitable for FIPLOCK® corrugated conduits with fine and coarse profile*
- *metric metal thread*
- *self-extinguishing and resistant against most chemical media commonly used*
- *excellent UV-resistance*
- *pre-assembled in small packing units*

Download
AFPA-MM

Das Datenblatt zu unsere Anschlussverschraubung AFPA-MM finden Sie hier.

The datasheet of our fitting AFPA-MM can be found here.





AFPA-PG

+120 °C +248 °F
-50 °C -58 °F

Anschlussverschraubung Innengewinde
gerade, PG, Kunststoffgewinde

*Fitting female thread
straight, PG, plastic thread*

Material: PA6 MOD V0 SGA



- Verschraubung Innengewinde passend für FIPLOCK® Wellrohre mit Fein- und Grobprofil
- PG-Kunststoffgewinde
- selbstverlöschend und beständig gegen die meisten gebräuchlichen Medien
- ausgezeichnete UV-Beständigkeit
- fertig konfektioniert in kleinen Verpackungseinheiten
- *fitting female thread suitable for FIPLOCK® corrugated conduits with fine and coarse profile*
- *PG plastic thread*
- *self-extinguishing and resistant against most chemical media commonly used*
- *excellent UV-resistance*
- *pre-assembled in small packing units*

Download
AFPA-PG

Das Datenblatt zu unsere Anschlussverschraubung AFPA-PG finden Sie hier.

The datasheet of our fitting AFPA-PG can be found here.



Sie interessieren sich für unsere FIPLOCK® ONE Produkte? Klicken Sie hier zur **Direktanfrage**.
*You are interested in our FIPLOCK® ONE products? Please click here for **direct inquiry**.*



AFPA-PGM

+120 °C +248 °F
-50 °C -58 °F

Anschlussverschraubung Innengewinde
gerade, PG, Metallgewinde

*Fitting female thread
straight, PG, metal thread*

Material: PA6 MOD V0 SGA



- Verschraubung Innengewinde passend für FIPLOCK® Wellrohre mit Fein- und Grobprofil
- PG-Metallgewinde
- selbstverlöschend und beständig gegen die meisten gebräuchlichen Medien
- ausgezeichnete UV-Beständigkeit
- fertig konfektioniert in kleinen Verpackungseinheiten
- *fitting female thread suitable for FIPLOCK® corrugated conduits with fine and coarse profile*
- *PG metal thread*
- *self-extinguishing and resistant against most chemical media commonly used*
- *excellent UV-resistance*
- *pre-assembled in small packing units*

Download
AFPA-PGM

Das Datenblatt zu unsere Anschlussverschraubung AFPA-PGM finden Sie hier.

The datasheet of our fitting AFPA-PGM can be found here.





AFPA-U-M

+120 °C +248 °F
-50 °C -58 °F

Anschlussverschraubung Innengewinde
gerade, UNEF/UNS, Kunststoffgewinde, MIL DTL 5015

*Fitting female thread
straight, UNEF/UNS, plastic thread, MIL DTL 5015*

Material: PA6 MOD V0 SGA



Download
AFPA-U-M

Das Datenblatt zu unsere Anschlussverschraubung AFPA-U-M finden Sie hier.

The datasheet of our fitting AFPA-U-M can be found here.

- Verschraubung Innengewinde passend für FIPLOCK® Wellrohre mit Fein- und Grobprofil
- UNEF-Kunststoffgewinde für MIL DTL 5015 Steckverbinder
- selbstverlöschend und beständig gegen die meisten gebräuchlichen Medien
- ausgezeichnete UV-Beständigkeit
- fertig konfektioniert in kleinen Verpackungseinheiten
- *fitting female thread suitable for FIPLOCK® corrugated conduits with fine and coarse profile*
- *UNEF plastic thread for MIL DTL 5015 connector series*
- *self-extinguishing and resistant against most chemical media commonly used*
- *excellent UV-resistance*
- *pre-assembled in small packing units*



Sie interessieren sich für unsere FIPLOCK® ONE Produkte? Klicken Sie hier zur **Direktanfrage**.
*You are interested in our FIPLOCK® ONE products? Please click here for **direct inquiry**.*



AFPA-U-A

+120 °C +248 °F
-50 °C -58 °F

Anschlussverschraubung Innengewinde
gerade, UNEF, Kunststoffgewinde, Souriau UTG-6

*Fitting female thread
straight, UNEF, plastic thread, Souriau UTG-6*

Material: PA6 MOD V0 SGA



- Verschraubung Innengewinde passend für FIPLOCK® Wellrohre mit Fein- und Grobprofil
- UNEF-Kunststoffgewinde für Souriau Steckerserie UTG-6/UTO/UTS und ITT Cannon Trident
- selbstverlöschend und beständig gegen die meisten gebräuchlichen Medien
- ausgezeichnete UV-Beständigkeit
- fertig konfektioniert in kleinen Verpackungseinheiten
- *fitting female thread suitable for FIPLOCK® corrugated conduits with fine and coarse profile*
- *UNEF plastic thread for Souriau connector series UTG-6/UTO/UTS and ITT Cannon Trident*
- *self-extinguishing and resistant against most chemical media commonly used*
- *excellent UV-resistance*
- *pre-assembled in small packing units*

Download
AFPA-U-A

Das Datenblatt zu unsere Anschlussverschraubung AFPA-U-A finden Sie hier.

The datasheet of our fitting AFPA-U-A can be found here.



Sie interessieren sich für unsere FIPLOCK® ONE Produkte? Klicken Sie hier zur **Direktanfrage**.
*You are interested in our FIPLOCK® ONE products? Please click here for **direct inquiry**.*



AFPA-U-B

+120 °C +248 °F
-50 °C -58 °F

Anschlussverschraubung Innengewinde
gerade, UNEF, Kunststoffgewinde, AMP CPC

*Fitting female thread
straight, UNEF, plastic thread, AMP CPC*

Material: PA6 MOD V0 SGA



- Verschraubung Innengewinde passend für FIPLOCK® Wellrohre mit Fein- und Grobprofil
- UNEF-Kunststoffgewinde für AMP Steckerserie CPC
- selbstverlöschend und beständig gegen die meisten gebräuchlichen Medien
- ausgezeichnete UV-Beständigkeit
- fertig konfektioniert in kleinen Verpackungseinheiten
- *fitting female thread suitable for FIPLOCK® corrugated conduits with fine and coarse profile*
- *UNEF plastic thread for AMP- CPC series connectors*
- *self-extinguishing and resistant against most chemical media commonly used*
- *excellent UV-resistance*
- *pre-assembled in small packing units*

Download
AFPA-U-B

Das Datenblatt zu unsere Anschlussverschraubung AFPA-U-B finden Sie hier.

The datasheet of our fitting AFPA-U-B can be found here.





AZPA-M

+120 °C +248 °F
-50 °C -58 °F

Anschlussverschraubung Zugentlastung
gerade, metrisch, Kunststoffgewinde
*Fitting strain relief
straight, metric, plastic thread*

Material: PA6 MOD V0 SGA



- Verschraubung Zugentlastung passend für FIPLOCK® Wellrohre mit Fein- und Grobprofil
- metrisches Kunststoffgewinde
- selbstverlöschend und beständig gegen die meisten gebräuchlichen Medien
- ausgezeichnete UV-Beständigkeit
- fertig konfektioniert in kleinen Verpackungseinheiten
- fitting strain relief suitable for FIPLOCK® corrugated conduits with fine and coarse profile
- metric plastic thread
- self-extinguishing and resistant against most chemical media commonly used
- excellent UV-resistance
- pre-assembled in small packing units

Download
AZPA-M

Das Datenblatt zu unsere Anschlussverschraubung AZPA-M finden Sie hier.

The datasheet of our fitting AZPA-M can be found here.



Sie interessieren sich für unsere FIPLOCK® ONE Produkte? Klicken Sie hier zur **Direktanfrage**.
*You are interested in our FIPLOCK® ONE products? Please click here for **direct inquiry**.*



AZPA-C

+120 °C +248 °F
-50 °C -58 °F

Anschlussverschraubung Zugentlastung
gerade, click, metrisch
*Fitting strain relief
straight, click, metric*

Material: PA6 MOD V0 SGA



- Verschraubung Zugentlastung passend für FIPLOCK® Wellrohre mit Fein- und Grobprofil
- Click-Anschluss aus Kunststoff für Blech-Durchgangslöcher, bei denen eine Gegenmuttermontage nicht möglich ist
- selbstverlöschend und beständig gegen die meisten gebräuchlichen Medien
- ausgezeichnete UV-Beständigkeit
- fertig konfektioniert in kleinen Verpackungseinheiten
- fitting strain relief suitable for FIPLOCK® corrugated conduits with fine and coarse profile
- click system made out of plastic adapted for metric panel holes where lock-nuts can not be applied from the backside
- self-extinguishing and resistant against most chemical media commonly used
- excellent UV-resistance
- pre-assembled in small packing units

Download
AZPA-C

Das Datenblatt zu unsere Anschlussverschraubung AZPA-C finden Sie hier.

The datasheet of our fitting AZPA-C can be found here.





AZPA-MMK

+120 °C +248 °F
-50 °C -58 °F

Anschlussverschraubung Zugentlastung
gerade, metrisch, Metallgewinde, kurz

*Fitting strain relief
straight, metric, metal thread, short*

Material: PA6 MOD V0 SGA



Download
AZPA-MMK

Das Datenblatt zu unsere Anschlussverschraubung AZPA-MMK finden Sie hier.

The datasheet of our fitting AZPA-MMK can be found here.

- Verschraubung Zugentlastung passend für FIPLOCK® Wellrohre mit Fein- und Grobprofil
- metrisches Metallgewinde kurz
- selbstverlöschend und beständig gegen die meisten gebräuchlichen Medien
- ausgezeichnete UV-Beständigkeit
- fertig konfektioniert in kleinen Verpackungseinheiten
- *fitting strain relief suitable for FIPLOCK® corrugated conduits with fine and coarse profile*
- *metric short metal thread*
- *self-extinguishing and resistant against most chemical media commonly used*
- *excellent UV-resistance*
- *pre-assembled in small packing units*



NFPA
130



Sie interessieren sich für unsere FIPLOCK® ONE Produkte? Klicken Sie hier zur **Direktanfrage**.

*You are interested in our FIPLOCK® ONE products? Please click here for **direct inquiry**.*



AZPA-MML

+120 °C +248 °F
-50 °C -58 °F

Anschlussverschraubung Zugentlastung
gerade, metrisch, Metallgewinde, lang

*Fitting strain relief
straight, metric, metal thread, long*

Material: PA6 MOD V0 SGA



Download
AZPA-MML

Das Datenblatt zu unsere Anschlussverschraubung AZPA-MML finden Sie hier.

The datasheet of our fitting AZPA-MML can be found here.

- Verschraubung Zugentlastung passend für FIPLOCK® Wellrohre mit Fein- und Grobprofil
- metrisches Metallgewinde lang
- selbstverlöschend und beständig gegen die meisten gebräuchlichen Medien
- ausgezeichnete UV-Beständigkeit
- fertig konfektioniert in kleinen Verpackungseinheiten
- *fitting strain relief suitable for FIPLOCK® corrugated conduits with fine and coarse profile*
- *metric long metal thread*
- *self-extinguishing and resistant against most chemical media commonly used*
- *excellent UV-resistance*
- *pre-assembled in small packing units*



NFPA
130





AZPA-PG

+120 °C +248 °F
-50 °C -58 °F

Anschlussverschraubung Zugentlastung
gerade, PG, Kunststoffgewinde

*Fitting strain relief
straight, PG, plastic thread*

Material: PA6 MOD V0 SGA

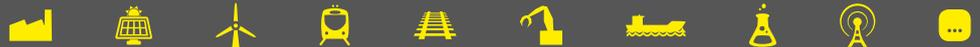

- Verschraubung Zugentlastung passend für FIPLOCK® Wellrohre mit Fein- und Grobprofil
- PG-Kunststoffgewinde
- selbstverlöschend und beständig gegen die meisten gebräuchlichen Medien
- ausgezeichnete UV-Beständigkeit
- fertig konfektioniert in kleinen Verpackungseinheiten
- *fitting strain relief suitable for FIPLOCK® corrugated conduits with fine and coarse profile*
- *PG plastic thread*
- *self-extinguishing and resistant against most chemical media commonly used*
- *excellent UV-resistance*
- *pre-assembled in small packing units*

Download
AZPA-PG

Das Datenblatt zu unsere Anschlussverschraubung AZPA-PG finden Sie hier.

The datasheet of our fitting AZPA-PG can be found here.



NFPA
130



Sie interessieren sich für unsere FIPLOCK® ONE Produkte? Klicken Sie hier zur **Direktanfrage**.

*You are interested in our FIPLOCK® ONE products? Please click here for **direct inquiry**.*



AZPA-PGM

+120 °C +248 °F
-50 °C -58 °F

Anschlussverschraubung Zugentlastung
gerade, PG, Metallgewinde

*Fitting strain relief
straight, PG, metal thread*

Material: PA6 MOD V0 SGA



- Verschraubung Zugentlastung passend für FIPLOCK® Wellrohre mit Fein- und Grobprofil
- PG-Metallgewinde
- selbstverlöschend und beständig gegen die meisten gebräuchlichen Medien
- ausgezeichnete UV-Beständigkeit
- fertig konfektioniert in kleinen Verpackungseinheiten
- *fitting strain relief suitable for FIPLOCK® corrugated conduits with fine and coarse profile*
- *PG metal thread*
- *self-extinguishing and resistant against most chemical media commonly used*
- *excellent UV-resistance*
- *pre-assembled in small packing units*

Download
AZPA-PGM

Das Datenblatt zu unsere Anschlussverschraubung AZPA-PGM finden Sie hier.

The datasheet of our fitting AZPA-PGM can be found here.



NFPA
130





Download
AZPA-NPT

Das Datenblatt zu unsere Anschlussverschraubung AZPA-NPT finden Sie hier.

The datasheet of our fitting AZPA-NPT can be found here.

AZPA-NPT

Anschlussverschraubung Zugentlastung
gerade, NPT, Kunststoffgewinde

*Fitting strain relief
straight, NPT, plastic thread*

Material: PA6 MOD V0 SGA



+120 °C +248 °F
-50 °C -58 °F



- Verschraubung Zugentlastung passend für FIPLOCK® Wellrohre mit Fein- und Grobprofil
- NPT-Kunststoffgewinde
- selbstverlöschend und beständig gegen die meisten gebräuchlichen Medien
- ausgezeichnete UV-Beständigkeit
- fertig konfektioniert in kleinen Verpackungseinheiten
- fitting strain relief suitable for FIPLOCK® corrugated conduits with fine and coarse profile
- NPT plastic thread
- self-extinguishing and resistant against most chemical media commonly used
- excellent UV-resistance
- pre-assembled in small packing units



NFPA
130



Sie interessieren sich für unsere FIPLOCK® ONE Produkte? Klicken Sie hier zur **Direktanfrage**.

You are interested in our FIPLOCK® ONE products? Please click here for **direct inquiry**.



Download
AZPA-NPTM

Das Datenblatt zu unsere Anschlussverschraubung AZPA-NPTM finden Sie hier.

The datasheet of our fitting AZPA-NPTM can be found here.

AZPA-NPTM

Anschlussverschraubung Zugentlastung
gerade, NPT, Metallgewinde

*Fitting strain relief
straight, NPT, metal thread*

Material: PA6 MOD V0 SGA



+120 °C +248 °F
-50 °C -58 °F



- Verschraubung Zugentlastung passend für FIPLOCK® Wellrohre mit Fein- und Grobprofil
- NPT-Metallgewinde
- selbstverlöschend und beständig gegen die meisten gebräuchlichen Medien
- ausgezeichnete UV-Beständigkeit
- fertig konfektioniert in kleinen Verpackungseinheiten
- fitting strain relief suitable for FIPLOCK® corrugated conduits with fine and coarse profile
- NPT metal thread
- self-extinguishing and resistant against most chemical media commonly used
- excellent UV-resistance
- pre-assembled in small packing units



NFPA
130





ATPA

T-Verteiler
T-distributor

+120 °C +248 °F
-50 °C -58 °F

Material: PA6 MOD V0 SGA



- T-Verteiler passend für FIPLOCK® Wellrohre mit Fein- und Grobprofil
- selbstverlöschend und beständig gegen die meisten gebräuchlichen Medien
- ausgezeichnete UV-Beständigkeit
- fertig konfektioniert in kleinen Verpackungseinheiten
- *T-distributor suitable for FIPLOCK® corrugated conduits with fine and coarse profile*
- *self-extinguishing and resistant against most chemical media commonly used*
- *excellent UV-resistance*
- *pre-assembled in small packing units*

Download
ATPA

Das Datenblatt zu unserem Verteiler ATPA finden Sie hier.

The datasheet of our distributor ATPA can be found here.



Sie interessieren sich für unsere FIPLOCK® ONE Produkte? Klicken Sie hier zur **Direktanfrage**.
*You are interested in our FIPLOCK® ONE products? Please click here for **direct inquiry**.*



ATPA-CA

T-Adapter
T-adapter

+120 °C +248 °F
-50 °C -58 °F

Material: PA6 MOD V0 SGA



- T-Adapter passend für FIPLOCK® Wellrohre mit Fein- und Grobprofil
- selbstverlöschend und beständig gegen die meisten gebräuchlichen Medien
- ausgezeichnete UV-Beständigkeit
- fertig konfektioniert in kleinen Verpackungseinheiten
- direkt in Serie montierbar
- *T-adapter suitable for FIPLOCK® corrugated conduits with fine and coarse profile*
- *self-extinguishing and resistant against most chemical media commonly used*
- *excellent UV-resistance*
- *pre-assembled in small packing units*
- *directly connectable in series*

Download
ATPA-CA

Das Datenblatt zu unserem Adapter ATPA-CA finden Sie hier.

The datasheet of our adapter ATPA-CA can be found here.





AYPA

Y-Verteiler
Y-distributor

+120 °C +248 °F
-50 °C -58 °F

Material: PA6 MOD V0 SGA



- Y-Verteiler passend für FIPOCK® Wellrohre mit Fein- und Grobprofil
- selbstverlöschend und beständig gegen die meisten gebräuchlichen Medien
- ausgezeichnete UV-Beständigkeit
- fertig konfektioniert in kleinen Verpackungseinheiten
- *Y-distributor suitable for FIPOCK® corrugated conduits with fine and coarse profile*
- *self-extinguishing and resistant against most chemical media commonly used*
- *excellent UV-resistance*
- *pre-assembled in small packing units*

Download
AYPA

Das Datenblatt zu unserem Verteiler AYP A finden Sie hier.

The datasheet of our distributor AYP A can be found here.



Sie interessieren sich für unsere FIPOCK® ONE Produkte? Klicken Sie hier zur **Direktanfrage**.
*You are interested in our FIPOCK® ONE products? Please click here for **direct inquiry**.*



ARPA

Rohrreduzierung
Conduit reducer

+120 °C +248 °F
-50 °C -58 °F

Material: PA6 MOD V0 SGA



- Reduzierung der Rohrenweiten bei einem Wellrohranschluss
- passend für FIPOCK® Wellrohre mit Fein- und Grobprofil
- selbstverlöschend und beständig gegen die meisten gebräuchlichen Medien
- ausgezeichnete UV-Beständigkeit
- fertig konfektioniert in kleinen Verpackungseinheiten
- *to reduce the conduit nominal width at a fitting conduit outlet*
- *suitable for FIPOCK® corrugated conduits with fine and coarse profile*
- *self-extinguishing and resistant against most chemical media commonly used*
- *excellent UV-resistance*
- *pre-assembled in small packing units*

Download
ARPA

Das Datenblatt zu unserer Rohrreduzierung ARPA finden Sie hier.

The datasheet of our conduit reducer ARPA can be found here.





AIPPA-M

+120 °C +248 °F
-50 °C -58 °F

Rohrverbinder Wellrohr/Glattrrohr
metrisch

*Conduit reducer corrugated to smooth tube
metric*

Material: PA6 MOD V0 SGA



- metrischer Glattrrohrverbinder mit Edelstahlschelle
- ermöglicht die Verbindung von FIPLOCK® Wellrohren mit Fein- und Grobprofil zu Glattrrohren
- selbstverlöschend und beständig gegen die meisten gebräuchlichen Medien
- ausgezeichnete UV-Beständigkeit
- fertig konfektioniert in kleinen Verpackungseinheiten
- mit Edelstahlschelle
- *metric smooth tube connector with stainless steel jubilee clamp*
- *allows the connection of FIPLOCK® corrugated conduits with fine and coarse profile with smooth tubes*
- *self-extinguishing and resistant against most chemical media commonly used*
- *excellent UV-resistance*
- *pre-assembled in small packing units*

Download
AIPPA-M

Das Datenblatt zu unserem Rohrverbinder AIPPA-M finden Sie hier.

The datasheet of our conduit connector AIPPA-M can be found here.



Sie interessieren sich für unsere FIPLOCK® ONE Produkte? Klicken Sie hier zur **Direktanfrage**.

*You are interested in our FIPLOCK® ONE products? Please click here for **direct inquiry**.*



AIPPA-PG

+120 °C +248 °F
-50 °C -58 °F

Rohrverbinder Wellrohr/Glattrrohr
PG

*Conduit reducer corrugated to smooth tube
PG*

Material: PA6 MOD V0 SGA



- PG-Glattrrohrverbinder mit Edelstahlschelle
- ermöglicht die Verbindung von FIPLOCK® Wellrohren mit Fein- und Grobprofil zu Glattrrohren
- selbstverlöschend und beständig gegen die meisten gebräuchlichen Medien
- ausgezeichnete UV-Beständigkeit
- fertig konfektioniert in kleinen Verpackungseinheiten
- *PG smooth tube connector with stainless steel jubilee clamp*
- *allows the connection of FIPLOCK® corrugated conduits with fine and coarse profile with smooth tubes*
- *self-extinguishing and resistant against most chemical media commonly used*
- *excellent UV-resistance*
- *pre-assembled in small packing units*

Download
AIPPA-PG

Das Datenblatt zu unserem Rohrverbinder AIPPA-PG finden Sie hier.

The datasheet of our conduit connector AIPPA-PG can be found here.





ACPA

Rohrverbinder
Conduit connector

+120 °C +248 °F
-50 °C -58 °F

Material: PA6 MOD V0 SGA



- Rohrverbinder passend für FIPLOCK® Wellrohre mit Fein- und Grobprofil
- selbstverlöschend und beständig gegen die meisten gebräuchlichen Medien
- ausgezeichnete UV-Beständigkeit
- fertig konfektioniert in kleinen Verpackungseinheiten
- conduit connector suitable for FIPLOCK® corrugated conduits with fine and coarse profile
- self-extinguishing and resistant against most chemical media commonly used
- excellent UV-resistance
- pre-assembled in small packing units

Download
ACPA

Das Datenblatt zu unserem Rohrverbinder ACPA finden Sie hier.

The datasheet of our conduit connector ACPA can be found here.



Sie interessieren sich für unsere FIPLOCK® ONE Produkte? Klicken Sie hier zur **Direktanfrage**.
You are interested in our FIPLOCK® ONE products? Please click here for **direct inquiry**.



ACPA-SH

Rohrverbinder mit Befestigungsmöglichkeit
Conduit connector with mounting option

+120 °C +248 °F
-50 °C -58 °F

Material: PA6 MOD V0 SGA



- Rohrverbinder mit Befestigungsmöglichkeit passend für FIPLOCK® Wellrohre mit Fein- und Grobprofil
- selbstverlöschend und beständig gegen die meisten gebräuchlichen Medien
- ausgezeichnete UV-Beständigkeit
- fertig konfektioniert in kleinen Verpackungseinheiten
- conduit connector with mounting option suitable for FIPLOCK® corrugated conduits with fine and coarse profile
- self-extinguishing and resistant against most chemical media commonly used
- excellent UV-resistance
- pre-assembled in small packing units

Download
ACPA-SH

Das Datenblatt zu unserem Rohrverbinder ACPA-SH finden Sie hier.

The datasheet of our conduit connector ACPA-SH can be found here.





APPA-EPDM

90°-Flansch, EPDM-Flanschdichtung
90°-flange, EPDM flange gasket

+120 °C +248 °F
 -50 °C -58 °F

Material: PA6 MOD V0 SGA



- 90°-Flansch passend für FIPLOCK® Wellrohre mit Fein- und Grobprofil
- EPDM-Flanschdichtung
- selbstverlöschend und beständig gegen die meisten gebräuchlichen Medien
- ausgezeichnete UV-Beständigkeit
- fertig konfektioniert in kleinen Verpackungseinheiten
- *90°-flange suitable for FIPLOCK® corrugated conduits with fine and coarse profile*
- *EPDM flange gasket*
- *self-extinguishing and resistant against most chemical media commonly used*
- *excellent UV-resistance*
- *pre-assembled in small packing units*

Download
APPA-EPDM

Das Datenblatt zu unserer Flanschdichtung APPA-EPDM finden Sie hier.

The datasheet of our flange gasket APPA-EPDM can be found here.



Sie interessieren sich für unsere FIPLOCK® ONE Produkte? Klicken Sie hier zur **Direktanfrage**.
*You are interested in our FIPLOCK® ONE products? Please click here for **direct inquiry**.*



APPA-NBR

90°-Flansch, NBR-Flanschdichtung
90°-flange, NBR flange gasket

+120 °C +248 °F
 -50 °C -58 °F

Material: PA6 MOD V0 SGA



- 90°-Flansch passend für FIPLOCK® Wellrohre mit Fein- und Grobprofil
- NBR-Flanschdichtung
- selbstverlöschend und beständig gegen die meisten gebräuchlichen Medien
- ausgezeichnete UV-Beständigkeit
- fertig konfektioniert in kleinen Verpackungseinheiten
- *90°-flange suitable for FIPLOCK® corrugated conduits with fine and coarse profile*
- *NBR flange gasket*
- *self-extinguishing and resistant against most chemical media commonly used*
- *excellent UV-resistance*
- *pre-assembled in small packing units*

Download
APPA-NBR

Das Datenblatt zu unserer Flanschdichtung APPA-NBR finden Sie hier.

The datasheet of our flange gasket APPA-NBR can be found here.





ASPA-HV

+120 °C +248 °F
-50 °C -58 °F

Abschluss-, Einzugs- und Aufhängungsadapter
Termination, draw-in and transport fitting

Material: PA6 MOD V0 SGA



Download
ASPA-HV

Das Datenblatt zu unserem Adapter ASPA-HV finden Sie hier.

The datasheet of our fitting ASPA-HV can be found here.

- wiederverwendbarer, geschlossener Adapter mit Einzugsloch bzw. Hebevorrichtung, passend für FIPLOCK® Wellrohre mit Fein- und Grobprofil
- selbstverlöschend und beständig gegen die meisten gebräuchlichen Medien
- ausgezeichnete UV-Beständigkeit
- fertig konfektioniert in kleinen Verpackungseinheiten
- geeignet als dichter Wellrohrverschluss oder als Aufhängungsvorrichtung für den Transportschutz
- *re-usable, termination fitting with lifting lug, suitable for FIPLOCK® corrugated conduits with fine and coarse profile*
- *self-extinguishing and resistant against most chemical media commonly used*
- *excellent UV-resistance*
- *pre-assembled in small packing units*
- *specially considerable for seal-tight conduit termination or as a lifting device during transportation*



Sie interessieren sich für unsere FIPLOCK® ONE Produkte? Klicken Sie hier zur **Direktanfrage**.

*You are interested in our FIPLOCK® ONE products? Please click here for **direct inquiry**.*



ASPAS-MMK

ASPAS- MMK + MML

Anschlussverschraubung,
gerade, drehbar, metrisch,
Metallgewinde kurz und lang

*Fitting, straight, revolving, metric,
metal thread, short and long*



ASPAS-MML

Bald erhältlich! / Coming soon!

ASPAS-PGM

Anschlussverschraubung,
gerade, drehbar, PG,
Metallgewinde

*Fitting, straight, revolving, PG,
metal thread*



ASPAS-PGM

ASPAS-NPTM

Anschlussverschraubung,
gerade, drehbar, NPT,
Metallgewinde

*Fitting, straight, revolving, NPT,
metal thread*



ASPAS-NPTM

FIPSYSTEMS®

AAPAS- MMK + MML

Anschlussverschraubung Winkel
45°, drehbar, metrisch, Metallge-
winde kurz und lang

*Fitting 45° elbow, revolving, metric,
metal thread, short and long*



AAPAS-MML

AWPA/AEPA-S- PGM

Anschlussverschraubung Bogen-
winkel 90°, drehbar, PG, Metall-
gewinde

*Fitting 90° curved elbow, revolving,
PG, metal thread*



AAPAS-MMK



AWPA/AEPA-S-PGM

FIPLOCK[®] ONE



AWPA/AEPA-S-MMK

AWPA/AEPA-S-MMK + MML

Anschlussverschraubung Bogenwinkel 90°, drehbar, metrisch, Metallgewinde kurz und lang

Fitting 90° curved elbow, revolving, metric, metal thread, short and long



AWPA/AEPA-S-MML

AAPA-S-PGM

Anschlussverschraubung Winkel 45°, drehbar, PG, Metallgewinde

Fitting 45° elbow, revolving, PG, metal thread

We simplify your world



AAPA-S-PGM



AAPA-S-NPTM

AAPA-S-NPTM

Anschlussverschraubung, gerade, drehbar, NPT, Metallgewinde

Fitting, straight, revolving, NPT, metal thread



AWPA/AEPA-S-NPTM

AWPA/AEPA-S-NPTM

Anschlussverschraubung Bogenwinkel 90°, drehbar, NPT, Metallgewinde

Fitting 90° curved elbow, revolving, NPT, metal thread

Zubehör

Accessories

zum FIPLOCK® Produktprogramm / for FIPLOCK® product range



Produktübersicht / Product overview

Produkt Product	Material Material	Seite Page
COPA-S	PA6 MOD V0 SGA	68
COPA-H	PA6 MOD V0 SGA	68
CRPA/CXPA	PA6 MOD V0 SGA	69
BSPA	PA6 MOD V0 SGA	70
BSPA-BJ	PA6 MOD V0 SGA	70
CPSZ	Galvanisch verzinkter Stahl und EPDM / Galvanized steel and EPDM	71
CUSZ	Galvanisch verzinkter Stahl und EPDM / Galvanized steel and EPDM	71
CPPA	PA6 MOD V0 SGA	72
CUPA	PA6 MOD V0 SGA	72
PETP	TPE	73
PTTP	TPE	73
NTPA-M	Polyamid (glasfaserverstärkt) / Polyamide (glass fiber reinforced)	74
NTBN-M	Messing vernickelt / Brass nickel-plated	74
NTBN-M-EMV	Messing vernickelt / Brass nickel-plated	75
NTPA-PG	Polyamid (glasfaserverstärkt) / Polyamide (glass fiber reinforced)	76
NTBN-PG	Messing vernickelt / Brass nickel-plated	76
NTBN-PG-EMV	Messing vernickelt / Brass nickel-plated	77
NEPA-M	Polyamid (glasfaserverstärkt) / Polyamide (glass fiber reinforced)	78
NEBN-M	Messing vernickelt / Brass nickel-plated	78



FIPLOCK®

Sie interessieren sich für unsere Produkte?
 Klicken Sie hier zur **Direktanfrage**.
 You are interested in our products?
 Please click here for **direct inquiry**.



Empfohlene Anwendungsbereiche / Recommended areas of application

Produkt Product										
COPA-S	✓	✓	✓	✓	✓	✓	✓	✓	✓	✓
COPA-H	✓	✓	✓	✓	✓	✓	✓	✓	✓	✓
CRPA/CXPA	✓	✓	✓	✓	✓	✓	✓	✓	✓	✓
BSPA	✓	✓	✓	✓	✓	✓	✓	✓	✓	✓
BSPA-BJ	✓	✓	✓	✓	✓	✓	✓	✓	✓	✓
CPSZ	✓	✓	✓	✓	✓	✓	✓	✓	✓	✓
CUSZ	✓	✓	✓	✓	✓	✓	✓	✓	✓	✓
CPPA	✓	✓	✓	✓	✓		✓	✓	✓	✓
CUPA	✓	✓	✓	✓	✓		✓	✓	✓	✓
PETP	✓	✓	✓	✓	✓	✓	✓	✓	✓	✓
PTTP	✓	✓	✓	✓	✓	✓	✓	✓	✓	✓
NTPA-M	✓	✓	✓	✓	✓	✓	✓	✓	✓	✓
NTBN-M	✓	✓	✓	✓	✓	✓	✓	✓	✓	✓
NTBN-M-EMV	✓	✓	✓	✓	✓	✓	✓	✓	✓	✓
NTPA-PG	✓	✓	✓	✓	✓	✓	✓	✓	✓	✓
NTBN-PG	✓	✓	✓	✓	✓	✓	✓	✓	✓	✓
NTBN-PG-EMV	✓	✓	✓	✓	✓	✓	✓	✓	✓	✓
NEPA-M	✓	✓	✓	✓	✓	✓	✓	✓	✓	✓
NEBN	✓	✓	✓	✓	✓	✓	✓	✓	✓	✓

Zubehör

Accessories

zum FIPLOCK® Produktprogramm / for FIPLOCK® product range



Produktübersicht / Product overview

Produkt Product	Material Material	Seite Page
NRPA-M	Polyamid (glasfaserverstärkt) / Polyamide (glass fiber reinforced)	79
NRBN-M	Messing vernickelt / Brass nickel-plated	79
NPPA-M	Polyamid (glasfaserverstärkt) / Polyamide (glass fiber reinforced)	80
NPPA-PG	Polyamid (glasfaserverstärkt) / Polyamide (glass fiber reinforced)	80
NKPA	PA6 MOD V0 SGA	81
PAPA	PA6 MOD V0 SGA	82
BHPA	PA6 MOD V0 SGA	82
TDPA	PA66	83
JSPA	PA6 MOD V0 SGA	84
JWPA	PA6 MOD V0 SGA	84



FIPLOCK®

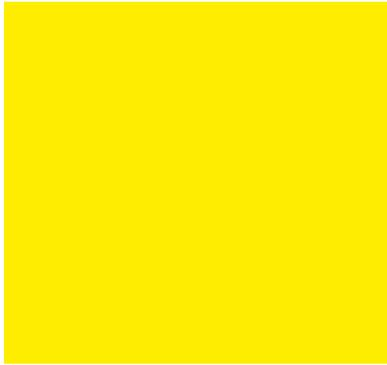

Empfohlene Anwendungsbereiche / *Recommended areas of application*

Produkt Product										
NRPA-M	✓	✓	✓	✓	✓	✓	✓	✓	✓	✓
NRBN-M	✓	✓	✓	✓	✓	✓	✓	✓	✓	✓
NPPA-M	✓	✓	✓				✓	✓	✓	✓
NPPA-PG	✓	✓	✓				✓	✓	✓	✓
NKPA	✓	✓	✓	✓	✓		✓	✓	✓	✓
PAPA	✓	✓	✓	✓	✓	✓	✓	✓	✓	✓
BHPA	✓	✓	✓	✓	✓	✓	✓	✓	✓	✓
TDPA	✓	✓	✓	✓	✓	✓	✓	✓	✓	✓
JSPA	✓	✓	✓	✓	✓	✓	✓	✓	✓	✓
JWPA	✓	✓	✓	✓	✓	✓	✓	✓	✓	✓

Nummernschlüssel FIPOCK® Zubehörteile

Part numbering key FIPOCK® accessories

1 2 3 4 5 6 7 8
CO **PA** - **17** **B** . **01**

1 Zubehörartikel / Material type

- CO** = Befestigungsclip mit Verschlusskappe
Mounting clip with cover
- CN** = Befestigungsclip ohne Verschlusskappe
Mounting clip without cover
- CU** = Rohrschelle Omega
Clamp Omega
- CP** = Rohrschelle
Clamp
- NT** = Gegenmutter
Locknut
- NE** = Gewindeerweiterung
Thread enlarger
- NR** = Gewindereduktion
Thread reducer
- PE** = Rohr-Kantenschutz
Conduit edge protection (FE-KA)
- PT** = Rohrendtülle
Conduit termination sleeve (FE-K)
- TD** = Kabel-Einzugswerkzeug
Cable-draw-in tool

2 Materialart / Material type

- BN** = Messing vernickelt / *Brass nickel plated*
- PA** = verschiedene PA6-Typen / *various PA6 types*
- SZ** = Edelstahl / *Stainless steel*
- TP** = TPE

entweder 3 oder 4+5 / *either 3 or 4+5*

3 Nennweite / Nominal width (NW)

- 07 – 48** = NW Standard
- 56 – 170** = NW XL

4 Gewindeart / Thread type

- M** = metrisch / *metric*
- P** = PG
- N** = NPT

5 Gewindegröße / Thread size

siehe Gewindeübersicht auf Seite 13
see thread table on page 13

6 Profil / Profile

- F** = Feinprofil / *Fine profile*
- C** = Grobprofil / *Coarse profile*

7 Farbe / Colour

- B** = Standard-Schwarz / *Standard black*
- G** = Standard-Grau / *Standard grey*

8 Modifikationscode

Modification code

ONE fits ALL – FIPLOCK® ONE

EIN Anschluss für ALLE Anwendungen

ONE fitting for ALL applications



- vormontiert und montagefertig
pre-assembled and ready-to-fit
- einfache Auswahl
easy selection
- verringerter Lageraufwand
lower storage effort
- geringer Handlingsaufwand
little handling necessary
- schnellere Montage
faster installation
- Kosteneinsparung
cost savings

FIPLOCK® ONE





COPA-S

Befestigungsclip
Mounting clip

+120 °C +248 °F
-50 °C -58 °F

Material: PA6 MOD V0 SGA



- Standard-Montagehalter für FIPLOCK® Wellrohre
- passend zu Standard-C-Montageschienen
- *standard mounting clip for FIPLOCK® corrugated conduits*
- *suitable for standard C-mounting rails*

Download
COPA-S

Das Datenblatt zu unserem Befestigungsclip COPA-S finden Sie hier.

The datasheet of our mounting clip COPA-S can be found here.



NFPA
130



Sie interessieren sich für unsere FIPLOCK® Zubehörteile? Klicken Sie hier zur **Direktanfrage**.

*You are interested in our FIPLOCK® accessories? Please click here for **direct inquiry**.*



COPA-H

Befestigungsclip
mit Sockel
Mounting clip
with base

+120 °C +248 °F
-50 °C -58 °F

Material: PA6 MOD V0 SGA



- Montagehalter für FIPLOCK® Wellrohre mit Sockel
- für ein verdrehsichere Montage
- *mounting clip with a base for FIPLOCK corrugated conduits*
- *for anti-twist applications*

Download
COPA-H

Das Datenblatt zu unserem Befestigungsclip COPA-H finden Sie hier.

The datasheet of our mounting clip COPA-H can be found here.



NFPA
130



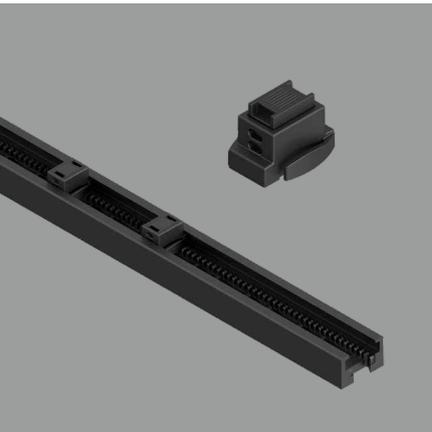

CRPA/CXPA

Montageschiene
mit Nutenstein
*Mounting rail
with slot nuts*

+120 °C +248 °F
-50 °C -58 °F

Material: PA6 MOD V0 SGA



- C-Schiene zur vereinfachten Montage der COPA-S Befestigungsclips
- Nutenstein ist von Hand schließbar und aus Sicherheitsgründen nur mit einem Schraubenzieher lösbar

- *C-rail for easy installation of COPA-S mounting clips*
- *slot nuts can be locked by hand and for safety reasons only released by screw driver*

Download
CRPA/CXPA

Das Datenblatt zu unserer Montage-schiene CRPA/PXPA finden Sie hier.

The datasheet of our mounting rail CRPA/PXPA can be found here.



**NFPA
130**



Sie interessieren sich für unsere FIPLOCK® Zubehörteile? Klicken Sie hier zur **Direktanfrage**.
*You are interested in our FIPLOCK® accessories? Please click here for **direct inquiry**.*



BSPA

Systemhalter
stapelbar

*System support
stackable*

Material: PA6 MOD V0 SGA

+120 °C +248 °F
-50 °C -58 °F



- stabiler und stapelbarer Systemhalter für FIPLOCK® Wellrohre
- zur festen Verschraubung vorgesehen
- robuste bauweise für hohe Belastungsanforderungen der montierten Wellrohre
- *stable and stackable system support for FIPLOCK® conduits*
- *considered for firm screw fastening*
- *rugged construction for high loads on installed corrugated conduits*

Download
BSPA

Das Datenblatt zu unserem Systemhalter BSPA finden Sie hier.

The datasheet of our system support BSPA can be found here.



Sie interessieren sich für unsere FIPLOCK® Zubehörteile? Klicken Sie hier zur **Direktanfrage**.
*You are interested in our FIPLOCK® accessories? Please click here for **direct inquiry**.*



BSPA-BJ

Systemhalter
stapelbar mit Gelenk

*System support stackable
with ball-joint*

Material: PA6 MOD V0 SGA

+120 °C +248 °F
-50 °C -58 °F



- stabiler und stapelbarer Systemhalter für FIPLOCK® Wellrohre
- erhöhte Bewegungsfreiheit der Wellrohre durch Gelenkeinsatz
- zur festen Verschraubung vorgesehen
- robuste bauweise für hohe Belastungsanforderungen der montierten Wellrohre
- *stable and stackable system support for FIPLOCK® conduits*
- *increased freedom of movement of the corrugated conduits due to a ball-joint insert*
- *considered for firm screw fastening*
- *rugged construction for high loads on installed corrugated conduits*

Download
BSPA-BJ

Das Datenblatt zu unserem Systemhalter BSPA-BJ finden Sie hier.

The datasheet of our system support BSPA-BJ can be found here.





CPSZ

Rohrschelle
mit Lasche
*Tube clamp
with lug*

+120 °C +248 °F
-50 °C -58 °F

Material: Galvanisch verzinkter Stahl und EPDM / Galvanized steel and EPDM



- Montageschelle für FIPLOCK® Wellrohre
- mit einer Befestigungsöse
- *mounting clamp for FIPLOCK® conduits*
- *with one fixation lug*

Download
CPSZ

Das Datenblatt zu unserer Rohrschelle CPSZ finden Sie hier.

The datasheet of our tube clamp CPSZ can be found here.



Sie interessieren sich für unsere FIPLOCK® Zubehörteile? Klicken Sie hier zur **Direktanfrage**.
*You are interested in our FIPLOCK® accessories? Please click here for **direct inquiry**.*



CUSZ

Rohrschelle
mit Doppellasje
*Tube clamp
with double lug*

+120 °C +248 °F
-50 °C -58 °F

Material: Galvanisch verzinkter Stahl und EPDM / Galvanized steel and EPDM



- Montageschelle für FIPLOCK® Wellrohre
- mit zwei Befestigungsösen für eine verdrehsichere Montage
- *mounting clamp for FIPLOCK® conduits*
- *with two fixation lug for anti-twist application*

Download
CUSZ

Das Datenblatt zu unserer Rohrschelle CUSZ finden Sie hier.

The datasheet of our tube clamp CUSZ can be found here.





CPPA

Wellrohrschelle
mit Lasche, Fixierungsrippe
*Corrugated conduit clamp
with lug, fixing rib*

+120 °C +248 °F
-50 °C -58 °F

Material: PA6 MOD V0 SGA



- Rohrschelle mit einer Befestigungsöse
- Fixierung der FIPLOCK® Wellrohre im Fein- und Grobprofil NW07-29
- Vollkunststoff – keine Korrosionsgefahr
- *conduit clamp with one fixation lug*
- *to fix FIPLOCK® conduits in fine and coarse profile for dimension NW07-29*
- *full plastic – no corrosion ability*

Download
CPPA

Das Datenblatt zu unserer Rohrschelle CPPA finden Sie hier.

The datasheet of our conduit clamp CPPA can be found here.



**NFPA
130**



Sie interessieren sich für unsere FIPLOCK® Zubehörteile? Klicken Sie hier zur **Direktanfrage**.
*You are interested in our FIPLOCK® accessories? Please click here for **direct inquiry**.*



CUPA

Wellrohrschelle
mit Doppelasche, Fixierungsrippe
*Corrugated conduit clamp
with double lug, fixing rib*

+120 °C +248 °F
-50 °C -58 °F

Material: PA6 MOD V0 SGA



- Rohrschelle mit Doppelasche
- Fixierung der FIPLOCK® Wellrohre im Fein- und Grobprofil NW23-95
- Vollkunststoff – keine Korrosionsgefahr
- *conduit lamp with double lug*
- *to fix FIPLOCK® conduits in fine and coarse profile for dimension NW23-95*
- *full plastic – no corrosion ability*

Download
CUPA

Das Datenblatt zu unserer Rohrschelle CUPA finden Sie hier.

The datasheet of our conduit clamp CUPA can be found here.



**NFPA
130**





PETP

Rohr-Kantenschutz Conduit edge protection

+120 °C +248 °F
-40 °C -40 °F

Material: TPE



- elastischer Rohr-Kantenschutz für FIPLOCK® Wellrohre
- zum Schutz von sensiblen Leitungen und Kabelisolationen beim Austritt am Wellrohrende unter Vibrationen
- *elastic conduit edge protection for FIPLOCK® corrugated conduits*
- *to protect sensitive cable and wire insulation at the conduit exit under vibrations*

Download
PETP

Das Datenblatt zu unserem Kantenschutz PETP finden Sie hier.

The datasheet of our edge protection PETP can be found here.



HALOGEN
FREE

Sie interessieren sich für unsere FIPLOCK® Zubehörteile? Klicken Sie hier zur **Direktanfrage**.
*You are interested in our FIPLOCK® accessories? Please click here for **direct inquiry**.*



PTTP

Rohr-Endtülle Conduit termination sleeve

+120 °C +248 °F
-40 °C -40 °F

Material: TPE



- elastische Rohr-Endtülle für FIPLOCK® Wellrohre
- schützt vor dem Eindringen von Schmutz und Staub ins Wellrohrende
- kann auf die gewünschten Kabeldurchmesser aufgeschnitten werden
- *elastic conduit termination sleeve for FIPLOCK® corrugated conduits*
- *protects from ingress of dirt and dust at the conduit end*
- *to be cut to fit tightly with applied cables or cable bundles*

Download
PTTP

Das Datenblatt zu unserem Wellrohr PTPP finden Sie hier.

The datasheet of our corrugated conduit PTPP can be found here.



HALOGEN
FREE



NTPA-M

Gegenmutter
sechskant, Kunststoff, metrisch
Locknut
hexagon, polyamide, metric

+100 °C +212 °F
-40 °C -40 °F

Material: Polyamid glasfaserverstärkt / Polyamide glass fiber reinforced



- Sechskant-Gegenmutter mit metrischem Gewinde
- passend zu FIPLOCK® ONE Verschraubungen mit metrischem Gewinde
- hexagon locknuts with metric threads
- suitable for FIPLOCK® ONE fittings with metric threads

Download
NTPA-M

Das Datenblatt zu unserer Gegenmutter NTPA-M finden Sie hier.

The datasheet of our locknut NTPA-M can be found here.



Sie interessieren sich für unsere FIPLOCK® Zubehörteile? Klicken Sie hier zur **Direktanfrage**.
*You are interested in our FIPLOCK® accessories? Please click here for **direct inquiry**.*



NTBN-M

Gegenmutter
sechskant, Messing vernickelt, metrisch
Locknut
hexagon, brass nickel-plated, metric

+200 °C +392 °F
-60 °C -76 °F

Material: Messing vernickelt / Brass nickel-plated



- Sechskant-Gegenmutter mit metrischem Gewinde
- passend zu FIPLOCK® ONE Verschraubungen mit metrischem Gewinde
- hexagon locknuts with metric threads
- suitable for FIPLOCK® ONE fittings with metric threads

Download
NTBN-M

Das Datenblatt zu unserer Gegenmutter NTBN-M finden Sie hier.

The datasheet of our locknut NTBN-M can be found here.





NTBN-M-EMV

+200 °C +392 °F
-60 °C -76 °F

Gegenmutter
sechskant, Messing vernickelt, metrisch, EMV

*Locknut
hexagon, brass nickel-plated, metric, EMV*

Material: Messing vernickelt / Brass nickel-plated



- Sechskant-Gegenmutter mit metrischem Gewinde
- passend zu FIPLOCK® ONE EMV-Verschraubungen mit metrischem Gewinde
- mit Oberflächen aufkratzenden Zacken
- hexagon locknuts with metric threads
- suitable for FIPLOCK® ONE EMC fittings with metric threads
- including surface scratching spikes

Download
NTBN-M-EMV

Das Datenblatt zu unserer Gegenmutter NTBN-M-EMV finden Sie hier.

The datasheet of our locknut NTBN-M-EMV can be found here.



Sie interessieren sich für unsere FIPLOCK® Zubehörteile? Klicken Sie hier zur **Direktanfrage**.
*You are interested in our FIPLOCK® accessories? Please click here for **direct inquiry**.*



NTPA-PG

Gegenmutter
sechskant, Kunststoff, PG
Locknut
hexagon, polyamide, PG

+100 °C +212 °F
-40 °C -40 °F

Material: Polyamid glasfaserverstärkt / Polyamide glass fiber reinforced



- Sechskant-Gegenmutter mit PG-Gewinde
- passend zu FIPLOCK® ONE Verschraubungen mit PG-Gewinde
- hexagon locknuts with PG threads
- suitable for FIPLOCK® ONE fittings with PG threads

Download
NTPA-PG

Das Datenblatt zu unserer Gegenmutter NTPA-PG finden Sie hier.

The datasheet of our locknut NTPA-PG can be found here.



Sie interessieren sich für unsere FIPLOCK® Zubehörteile? Klicken Sie hier zur **Direktanfrage**.
*You are interested in our FIPLOCK® accessories? Please click here for **direct inquiry**.*



NTBN-PG

Gegenmutter
sechskant, Messing vernickelt, PG
Locknut
hexagon, brass nickel-plated, PG

+200 °C +392 °F
-60 °C -76 °F

Material: Messing vernickelt / Brass nickel-plated



- Sechskant-Gegenmutter mit PG-Gewinde
- passend zu FIPLOCK® ONE Verschraubungen mit PG-Gewinde
- hexagon locknuts with PG threads
- suitable for FIPLOCK® ONE fittings with PG threads

Download
NTBN-PG

Das Datenblatt zu unserer Gegenmutter NTBN-PG finden Sie hier.

The datasheet of our locknut NTBN-PG can be found here.



NTBN-PG-EMV

+200 °C +392 °F
-60 °C -76 °F



Gegenmutter
sechskant, Messing vernickelt, PG, EMV

Locknut
hexagon, brass nickel-plated, PG, EMV

Material: Messing vernickelt / Brass nickel-plated



- Sechskant-Gegenmutter mit PG-Gewinde
- passend zu FIPLOCK® ONE EMV-Verschraubungen mit PG-Gewinde
- mit Oberflächen aufkratzenden Zacken
- hexagon locknuts with PG threads
- suitable for FIPLOCK® ONE EMC fittings with PG threads
- including surface scratching spikes

Download
NTBN-PG-EMV

Das Datenblatt zu unserer Gegenmutter NTBN-PG-EMV finden Sie hier.

The datasheet of our locknut NTBN-PG-EMV can be found here.



Sie interessieren sich für unsere FIPLOCK® Zubehörteile? Klicken Sie hier zur **Direktanfrage**.
*You are interested in our FIPLOCK® accessories? Please click here for **direct inquiry**.*



NEPA-M

+100 °C +212 °F
-40 °C -40 °F

Gewindeerweiterung
sechskant, Kunststoff, metrisch
*Thread enlarger
hexagon, plastic, metric*

Material: Polyamid glasfaserverstärkt / Polyamide glass fiber reinforced



- Gewindeerweiterung Kunststoff metrisch mit Sechskant für Gabelschlüssel
- *thread enlargers plastic with metric threads and hexagon for flat wrench*
- passend zu FIPOCK® ONE Verschraubungen mit metrischem Gewinde
- *suitable for FIPOCK® ONE fittings with metric threads*

Download
NEPA-M

Das Datenblatt zu unserer Gewindeerweiterung NEPA-M finden Sie hier.
The datasheet of our thread enlarger NEPA-M can be found here.



Sie interessieren sich für unsere FIPOCK® Zubehörteile? Klicken Sie hier zur **Direktanfrage**.
*You are interested in our FIPOCK® accessories? Please click here for **direct inquiry**.*



NEBN-M

+200 °C +392 °F
-60 °C -76 °F

Gewindeerweiterung
rund, Messing vernickelt, metrisch
*Thread enlarger
round, brass nickel-plated, metric*

Material: Messing vernickelt / Brass nickel-plated



- Gewindeerweiterung mit metrischem Gewinde
- *thread enlargers with metric threads*
- passend zu FIPOCK® ONE Verschraubungen mit metrischem Gewinde
- *suitable for FIPOCK® ONE fittings with metric threads*

Download
NEBN-M

Das Datenblatt zu unserer Gewindeerweiterung NEBN-M finden Sie hier.
The datasheet of our thread enlarger NEBN-M can be found here.





NRPA-M

Gewindereduktion
sechskant, Kunststoff, metrisch
*Thread reducer
hexagon, plastic, metric*

+100 °C +212 °F
-40 °C -40 °F

Material: Polyamid glasfaserverstärkt / Polyamide glass fiber reinforced.



Download
NRPA-M

Das Datenblatt zu unsere Gewinde-
reduktion NRPA-M finden Sie hier.

*The datasheet of our thread reducer
NRPA-M can be found here.*

- Gewindereduktion Kunststoff metrisch mit Sechskant für Gabelschlüssel
- *thread reducer plastic with metric threads and hexagon for flat wrench*
- passend zu FIPLOCK® ONE Verschraubungen mit metrischem Gewinde
- *suitable for FIPLOCK® ONE fittings with metric threads*



Sie interessieren sich für unsere FIPLOCK® Zubehörteile? Klicken Sie hier zur **Direktanfrage**.
*You are interested in our FIPLOCK® accessories? Please click here for **direct inquiry**.*



NRBN-M

Gewindereduktion
sechskant, Messing vernickelt, metrisch
*Thread reducer
hexagon, brass nickel-plated, metric*

+200 °C +392 °F
-60 °C -76 °F

Material: Messing vernickelt / Brass nickel-plated



- Gewindereduktion metrisch mit Sechskant für Gabelschlüssel
- *thread reducer with metric threads and hexagon for flat wrench*
- passend zu FIPLOCK® ONE Verschraubungen mit metrischem Gewinde
- *suitable for FIPLOCK® ONE fittings with metric threads*

Download
NRBN-M

Das Datenblatt zu unserer Gewinde-
reduktion NRBN-M finden Sie hier.

*The datasheet of our thread reducer
NRBN-M can be found here.*





NPPA-M

Verschluss-schraube
metrisch
*Screw plug
metric*

+100 °C +212 °F
-40 °C -40 °F

Material: Polyamid glasfaserverstärkt / Polyamide glass fiber reinforced



- Verschluss-schraube
- für metrische Gewindebohrungen, die verschlossen werden müssen
- *screw plug nut*
- *for metric thread holes which need to be closed*

Download
NPPA-M

Das Datenblatt zu unserer Verschluss-schraube NPPA-M finden Sie hier.

The datasheet of our screw plug NPPA-M can be found here.



Sie interessieren sich für unsere FIPLOCK® Zubehörteile? Klicken Sie hier zur **Direktanfrage**.
*You are interested in our FIPLOCK® accessories? Please click here for **direct inquiry**.*



NPPA-PG

Verschluss-schraube
PG
*Screw plug
PG*

+100 °C +212 °F
-40 °C -40 °F

Material: Polyamid glasfaserverstärkt / Polyamide glass fiber reinforced



- Verschluss-schraube
- für PG-Gewindebohrungen, die verschlossen werden müssen
- *screw plug nut*
- *for PG thread holes which need to be closed*

Download
NPPA-PG

Das Datenblatt zu unserer Verschluss-schraube NPPA-PG finden Sie hier.

The datasheet of our screw plug NPPA-PG can be found here.





NKPA

Kantenschutz-Mutter
Edge protection nut

+120 °C +248 °F
-50 °C -58 °F

Material: PA6 MOD V0 SGA



Download
NKPA

Das Datenblatt zu unserer Kantenschutz-Mutter NKPA finden Sie hier.

The datasheet of our edge protection nut NKPA can be found here.

- Kantenschutz-Mutter metrisch für FIPLOCK® ONE Anschlussverschraubungen
- bietet Schutz bei erhöhter Abriebgefahr der Kabelisolationen durch starke Vibrationen oder bei Verlegung von Leitungen mit engen Abbiegeradien
- *edge protection nut metric for FIPLOCK® ONE fittings*
- *offers protection at heavy vibrations regarding abrasion of conductor insulations as well as for application of wires with tight bend-off radius*



**NFPA
130**



Sie interessieren sich für unsere FIPLOCK® Zubehörteile? Klicken Sie hier zur **Direktanfrage**.
*You are interested in our FIPLOCK® accessories? Please click here for **direct inquiry**.*



PAPA

Abriebschutz- / Verbindungsmuffe
Abrasion protection / connecting sleeve

+120 °C +248 °F
-50 °C -58 °F

Material: PA6 MOD V0 SGA



- Montage über das Wellrohr zum Schutz vor übermäßigem Abrieb
- für den Einsatz in dynamischen, bewegten Wellrohrleitungen geeignet
- zur Verbindung von Wellrohren und Torsionsentlastung der Leitungen
- *applied onto the corrugated conduit to protect from extensive chafing/abrasion*
- *suitable for dynamic movements of corrugated conduits assemblies*
- *to connect conduits and release of occurring torsion forces to conduits*

Download
PAPA

Das Datenblatt zu unserer Muffe PAPA finden Sie hier.

The datasheet of our sleeve APPA-EPDM can be found here.



NFPA 130



Sie interessieren sich für unsere FIPLOCK® Zubehörteile? Klicken Sie hier zur **Direktanfrage**.
*You are interested in our FIPLOCK® accessories? Please click here for **direct inquiry**.*



BHPA

Halbschalen
achsial fix
*Half-shells
axial fix*

+120 °C +248 °F
-50 °C -58 °F

Material: PA6 MOD V0 SGA



- für die Montage über das Wellrohr bei Verwendung von individuellen Schellen (zum Schutz vor Quetschung und zur achsialen Fixierung)
- *to be applied onto the corrugated conduit if individual conduit clamps are used (to protect from crushing and for axial fixation)*

Download
BHPA

Das Datenblatt zu unseren Halbschalen BHPA finden Sie hier.

The datasheet of our half-shells BHPA can be found here.



NFPA 130



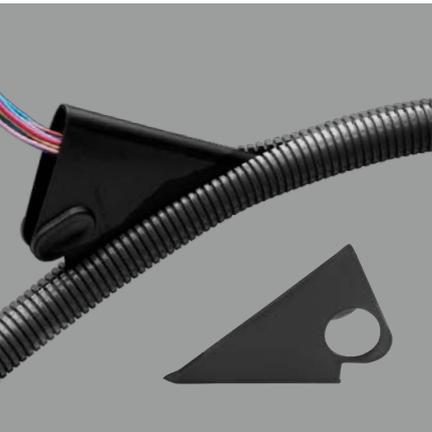

TDPA

Einzugswerkzeug
mit Loch / Griff

*Draw-in-tool
with hole / grip*

Material: PA66

+150 °C +302 °F
-40 °C -40 °F



■ Kabel- und Leiter-Einzugswerkzeug für längs-
geschlitzte FIPLOCK® Wellrohre

■ *draw-in tool for cables and conductors into slit
FIPLOCK® corrugated conduits*

Download
TDPA

Das Datenblatt zu unserem Einzugs-
werkzeug TDPA finden Sie hier.

*The datasheet of our draw-in-tool
TDPA can be found here.*



Sie interessieren sich für unsere FIPLOCK® Zubehörteile? Klicken Sie hier zur **Direktanfrage**.

*You are interested in our FIPLOCK® accessories? Please click here for **direct inquiry**.*

FIPLOCK®

Bald erhältlich! / *Coming soon!*



JSPA

Rohrflansch, gerade
FIPLOCK® XL

*Conduit flange, straight
FIPLOCK® XL*

FIPSYSTEMS®

We simplify **your world**



JWPA

Rohrflansch, 90°-Winkel
FIPLOCK® XL

*Conduit flange, 90° elbow
FIPLOCK® XL*

Kabelschutz / *Cable protection*

für erneuerbare Energiesysteme
for renewable energy systems



- flexibel, UV- und witterungsbeständig (bis zu 40 Jahre)
flexible, UV- and weather-resistant (up to 40 years)
- verlängern die Lebensdauer sensibler Verkabelungen sowie die Wartungsintervalle
extend the service life of sensitive cables while reducing maintenance
- Schutz vor mechanischen Einflüssen und Nagetierverbiss
protection from mechanical impacts and rodent bites



Hochtemperaturwellrohre

High temperature corrugated conduits

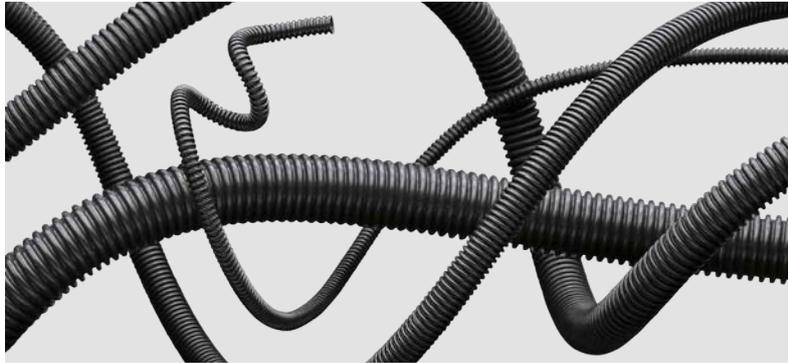

Produktübersicht / *Product overview*

Produkt <i>Product</i>	Material <i>Material</i>	Profil <i>Profile</i>	Zubehör <i>Accessories</i>	Seite <i>Page</i>
FPVS	PVDF	F	✓	90
FTPS	TPE	F	✓	90
FETS	ETFE	X		91
FETS-0	ETFE Orange*	X		91
FPFS	PFA	X		92
FPKS	PEEK	F	✓	92

* ähnlich RAL2003 / *similar to RAL2003*

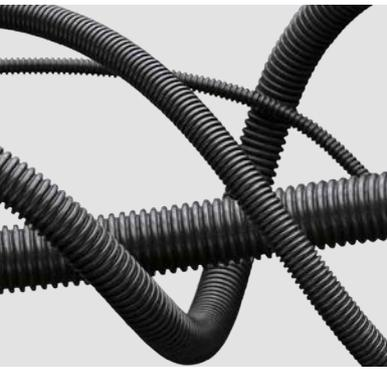

FIPHEAT®

Sie interessieren sich für unsere Produkte?
 Klicken Sie hier zur **Direktanfrage**.
 You are interested in our products?
 Please click here for **direct inquiry**.

Empfohlene Anwendungsbereiche / Recommended areas of application

Produkt Product										
FPVS	✓							✓		✓
FTPS	✓							✓		✓
FETS	✓							✓		✓
FETS-0	✓							✓		✓
FPFS	✓							✓		✓
FPKS	✓			✓				✓		✓

Nummernschlüssel FIPHEAT® Wellrohre

Part numbering key FIPHEAT® corrugated conduits



1 Ausführung / Model

F = FIPHEAT® Standardgewicht
FIPHEAT® standard weight

2 Material / Material type

ETS = **ETFE** (Ethylen-Tetrafluorethylen-Copolymer)
MFS = **MFA** (Modifiziertes Fluoralkoxy)
PFS = **PFA** (Perfluoralkoxy-Polymere)
PVS = **PVDF** (Polyvinylidenfluorid)
TPS = **TPE** (Thermoplastisches Elastomer)
PKS = **PEEK** (Polyetheretherketon)

3 Rohrprofil / Profile

F = Feinprofil
Fine profile
X = Sonderprofil
Special profile

4 Nennweite / Nominal width (NW)

07–48 = NW Standard

5 Farbe / Colour

B = Standard-Schwarz / *Standard black*
02 = Spezialfarbe / *Special colour*
z. B. / e.g. 02 = ähnlich / *similar to RAL2003 (Orange)*

6 Verpackungseinheit (VE) / Packing units (PU)

50 = Rollen- oder Stücklänge
Coil length or length of pieces
A = Individuelle Verpackungseinheit
Individual packing units

F Feinprofil / *F fine profile*

Anwendungsbereiche:

für engere Biegeradien und geringere Biegesteifigkeit

Application areas:

for tighter bending radii and lower bending stiffness

Charakteristik Rohrprofil:

feinere Profilteilung über Wellenberg und Wellental

Characteristics profile:

fine profile pitch over convolution top and convolution bottom

Durch mehr Wellen pro Längeneinheit werden Biegespannungen optimal verteilt.

More convolutions per length provide an optimized distribution of bending stress to the material.

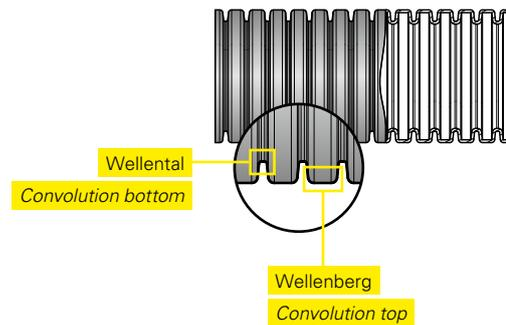

X Sonderprofil / *X special profile*

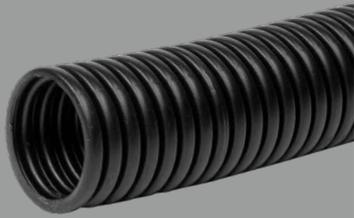

FPVS

+150 °C +302 °F
-60 °C -76 °F

Hochtemperaturwellrohr
mit erhöhter chemischen Beständigkeit
*High temperature corrugated conduit
with high chemical resistance*

Material: PVDF



- hightech Polymer-Werkstoff PVDF
- gute Wechselbiegefestigkeit
- höchste chemische Widerstandsfähigkeit
- sehr gute Witterungseigenschaften
- bestens geeignet für Anwendungen in der Prozesstechnik und in der chemischen Industrie

- *hightech polymer material PVDF*
- *good dynamic fatigue strength*
- *excellent chemical resistance characteristics*
- *very good weathering performances*
- *suitable for extensive applications areas and chemical process technology*

Download
FPVS

Das Datenblatt zu unserem Wellrohr FPVS finden Sie hier.

The datasheet of our corrugated conduit FPVS can be found here.

Sie interessieren sich für unsere FIPHEAT® Produkte? Klicken Sie hier zur **Direktanfrage**.
*You are interested in our FIPHEAT® products? Please click here for **direct inquiry**.*

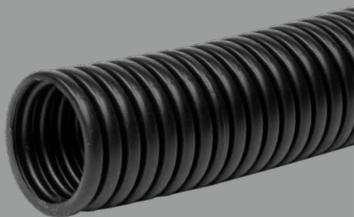

FTPS

+150 °C +302 °F
-40 °C -40 °F

Hochtemperaturwellrohr
für dynamische Anwendungen
*High-temperature corrugated conduit
for dynamic applications*

Material: TPE



- thermoplastisches Elastomer TPE
- exzellente Flexibilität
- mittel bis gute Witterungseigenschaften
- für Anwendungen mit erhöhten dynamischen Anforderungen

- *thermoplastic elastomer TPE*
- *excellent flexible quality*
- *average to good weathering performances*
- *for applications with highly flexing requirements*

Download
FTPS

Das Datenblatt zu unserem Wellrohr FTPS finden Sie hier.

The datasheet of our corrugated conduit FTPS can be found here.





FETS

+200 °C +392 °F
-80 °C -112 °F

Wellrohr
für hohe Dauertemperaturanforderungen
*Corrugated conduit
for high and continuous temperature applications*

Material: ETFE



- hightech Polymer-Werkstoff ETS
- gute Wechselbiegefestigkeit
- höchste chemische Widerstandsfähigkeit
- hervorragende Witterungseigenschaften
- bestens geeignet für hohe Dauertemperaturanforderungen
- *hightech polymer material ETS*
- *good dynamic fatigue strength*
- *excellent chemical resistance characteristics*
- *excellent weathering performances*
- *suits for extensive applications areas with high temperature requirements*

Download
FETS

Das Datenblatt zu unserem Wellrohr FETS finden Sie hier.

The datasheet of our corrugated conduit FETS can be found here.

Sie interessieren sich für unsere FIPHEAT® Produkte? Klicken Sie hier zur **Direktanfrage**.
*You are interested in our FIPHEAT® products? Please click here for **direct inquiry**.*

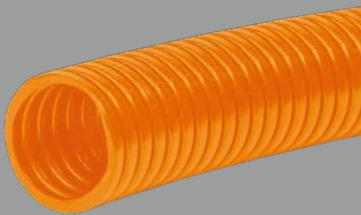

FETS-O

+200 °C +392 °F
-80 °C -112 °F

Wellrohr in Orange
für hohe Dauertemperaturanforderungen
*Corrugated conduit in orange colour
for high and continuous temperature applications*

Material: ETFE Orange ähnlich RAL2003 / ETFE orange similar to RAL2003



- hightech Polymer-Werkstoff ETS in Orange
- gute Wechselbiegefestigkeit
- höchste chemische Widerstandsfähigkeit
- hervorragende Witterungseigenschaften
- bestens geeignet für hohe Dauertemperaturanforderungen
- *hightech polymer material ETS in orange*
- *good dynamic fatigue strength*
- *excellent chemical resistance characteristics*
- *excellent weathering performances*
- *suits for extensive applications areas with high temperature requirements*

Download
FETS-O

Das Datenblatt zu unserem Wellrohr FETS-O finden Sie hier.

The datasheet of our corrugated conduit FETS-O can be found here.

FPFS

+260 °C +500 °F
-200 °C -328 °F

Wellrohr
für höchste Dauertemperaturanforderungen
*Corrugated conduit
for highest and continuous temperature applications*

Material: PFA



- hightech Polymer-Werkstoff PFA
- höchste chemische Widerstandsfähigkeit
- sehr gute Witterungseigenschaften
- bestens geeignet für höchste Dauertemperaturanforderungen und höchste chemische Widerstandsfähigkeit
- *hightech polymer material PFA*
- *highest chemical resistance characteristics*
- *very good weathering performances*
- *suits for extensive applications areas with highest temperature and chemical resistance requirements*

Download
FPFS

Das Datenblatt zu unserem Wellrohr FPFS finden Sie hier.

The datasheet of our corrugated conduit FPFS can be found here.

Sie interessieren sich für unsere FIPHEAT® Produkte? Klicken Sie hier zur **Direktanfrage**.
*You are interested in our FIPHEAT® products? Please click here for **direct inquiry**.*

FPKS

+300 °C +572 °F
-30 °C -22 °F

Hochtemperaturwellrohr
selbstverlöschend
*High-temperature corrugated conduit
self-extinguishing*

Material: PEEK (Polyetheretherketone)



- hightech Polymer-Werkstoff PEEK (Polyetheretherketone)
- selbstverlöschend, halogen- und cadmiumfrei
- hohe chemische Widerstandsfähigkeit
- gute Witterungseigenschaften
- für höchste Dauertemperatur- und Brandschutzanforderungen geeignet, speziell in der Bahntechnik und Personentransportwesen
- *hightech polymer material PEEK (Polyetheretherketone)*
- *self-extinguishing, free from halogens and cadmium*
- *high chemical resistance characteristics*
- *good weathering performances*
- *for extensive applications areas with highest temperature and and fire safety performances like rolling stock and public transport*

Download
FPKS

Das Datenblatt zu unserem Wellrohr FPKS finden Sie hier.

The datasheet of our corrugated conduit FPKS can be found here.



FRÄNKISCHE Meilensteine / *milestones*

Gründung und Umzug nach Königsberg

Foundation and relocation to Königsberg



zerstört durch Groß-
feuer am 11.04.1911
*destroyed by large fire
on 11.04.1911*

1911

1906

Gründung
Foundation

„Fränkische Isolier-
rohr- und Metallwaren-
Werke Gg. Schäfer
& Cie“

1912

Umzug nach
Königsberg in Franken
*Move to Königsberg
in Franconia*



Erste Produktionshalle in Königsberg / *First production hall in Königsberg*



Hochdynamische Wellrohre

High flexible corrugated conduits



Produktübersicht / *Product overview*

Produkt <i>Product</i>	Material <i>Material</i>	Profil <i>Profile</i>	Zubehör <i>Accessories</i>	Seite <i>Page</i>
FPDR	PA12 MOD R	F, C	✓	98

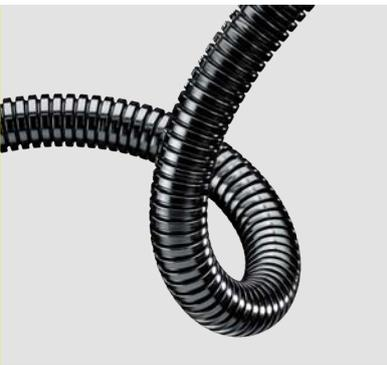

FIPMOTION®

Sie interessieren sich für unsere Produkte?
Klicken Sie hier zur **Direktanfrage**.
*You are interested in our products?
Please click here for **direct inquiry**.*

Empfohlene Anwendungsbereiche / *Recommended areas of application*

Produkt Product										
FPDR						✓				

Nummernschlüssel FIPMOTION® Wellrohre

Part numbering key FIPMOTION® corrugated conduits

1 2 3 4 5 6
F **PDR** **F** - **29** **B** . **50**

1 Ausführung / Model

F = FIPMOTION® Standardgewicht
FIPMOTION® standard weight

2 Material / Material type

PDR = PA12 MOD R

3 Rohrprofil / Profile

F = Feinprofil
Fine profile

C = Grobprofil
Coarse profile

4 Nennweite / Nominal width (NW)

07-95 = NW Standard

5 Farbe / Colour

B = Standard-Schwarz / *Standard black*

G = Standard-Grau / *Standard grey*

6 Verpackungseinheit (VE) / Packing units (PU)

50 = Rollen- oder Stücklänge
Coil length or length of pieces

A = Individuelle Verpackungseinheit
Individual packing units

F Feinprofil / F fine profile

Anwendungsbereiche:
für engere Biegeradien und geringere Biegesteifigkeit

Application areas:
for tighter bending radii and lower bending stiffness

Charakteristik Rohrprofil:
feinere Profilteilung über Wellenberg und Wellental

Characteristics profile:
fine profile pitch over convolution top and convolution bottom

Durch mehr Wellen pro Längeneinheit werden Biegespannungen optimal verteilt.
More convolutions per length provide an optimized distribution of bending stress to the material.

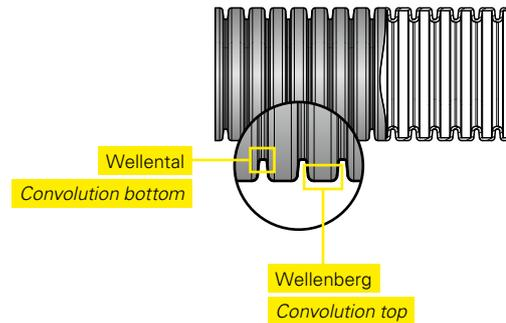

C Grobprofil / C coarse profile

Anwendungsbereiche:
für erhöhte Ausreißkräfte bei hohen Belastungen

Application areas:
increased pull out forces at heavy loads

Charakteristik Rohrprofil:
grobe Profilteilung über Wellenberg und Wellental

Characteristics profile:
coarse profile pitch over convolution top and convolution bottom

Durch weniger Wellen pro Längeneinheit wird die Streckung des Wellrohres unter Zugbelastung reduziert.
Less convolutions per length reduces the conduit elongation under pulling forces.

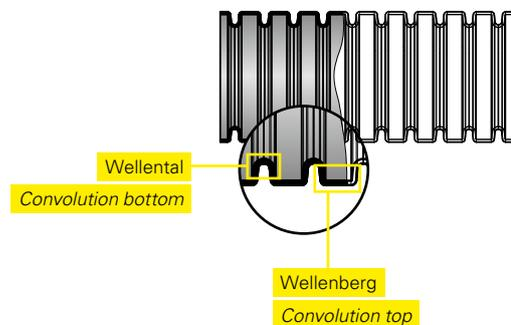

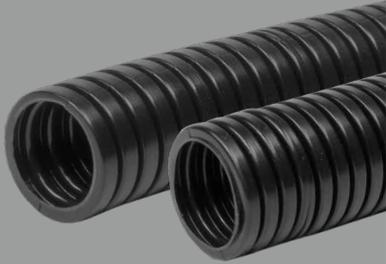

FPDR

+90 °C +194 °F
-50 °C -58 °F

Wellrohr für dauerhafte dynamische Wechselbiegeanforderungen

Corrugated conduit for high dynamic flexing movements

Material: PA12 MOD R



Download
FPDR

Das Datenblatt zu unserem Wellrohr FPDR finden Sie hier.

The datasheet of our corrugated conduit FPDR can be found here.

- selbstverlöschend, halogen- und cadmiumfrei
 - hervorragende dynamische Wechselbiegefestigkeit
 - für dauernd bewegte Verbindungen geeignet
 - ausgezeichnete mechanische Eigenschaften
 - hervorragende Witterungseigenschaften
 - für Robotikanwendungen geeignet
- *self-extinguishing, free of halogen and cadmium*
 - *excellent fatigue strength*
 - *suitable for continuous dynamic flexing movements*
 - *excellent mechanical strength characteristics*
 - *excellent weathering performances*
 - *suitable for heavy duty robotic applications*



Sie interessieren sich für unsere FIPMOTION® Produkte? Klicken Sie hier zur **Direktanfrage**.

*You are interested in our FIPMOTION® products? Please click here for **direct inquiry**.*

Hochflexibler Kabelschutz *Highly flexible cable protection*

dynamisch und belastbar
dynamic and resilient



- hohe dynamische Belastbarkeit
excellent abrasion properties
- hervorragende Abriebeigenschaften
excellent abrasion characteristics
- hält extremen Bewegungen Stand
keeps up with extreme movements
- für eine lange Einsatzdauer ausgelegt
designed for a long service life



Teilbare Wellrohre

Divisible corrugated conduits



Produktübersicht / *Product overview*

Produkt <i>Product</i>	Material <i>Material</i>	Profil <i>Profile</i>	Zubehör <i>Accessories</i>	Seite <i>Page</i>
2PPS	PP MOD BS	M	✓	106
2PPS-0	PP MOD BS Orange*	M	✓	106
2PPS-U	PP MOD BS UV	M	✓	107
2PAN	PA6 MOD	M	✓	107
2PAS	PA6 MOD BS	M	✓	108
2PAF	PA6 MOD V0	M	✓	108
2PDS	PA12 MOD BS	M	✓	109
2PDF	PA12 MOD V0	M	✓	109
2ETS	ETFE	M	✓	110
1PAS	PA6 MOD BS	M		111
1PPS-U	PP MOD BS UV	M		111

* ähnlich RAL2003 / *similar to RAL2003*



Sie interessieren sich für unsere Produkte?
 Klicken Sie hier zur **Direktanfrage**.
 You are interested in our products?
 Please click here for **direct inquiry**.

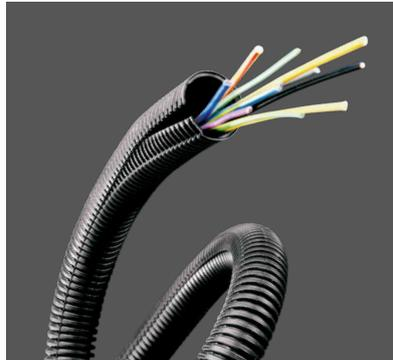

Empfohlene Anwendungsbereiche / Recommended areas of application

Produkt Product										
2PPS	✓		✓				✓	✓	✓	✓
2PPS-0	✓		✓					✓		✓
2PPS-U	✓	✓	✓	✓	✓		✓	✓	✓	✓
2PAN	✓		✓				✓	✓		✓
2PAS	✓		✓	✓			✓	✓		✓
2PAF	✓			✓			✓			✓
2PDS	✓	✓		✓	✓	✓	✓			✓
2PDF	✓	✓		✓		✓	✓	✓		✓
2ETS	✓							✓		✓
1PAS	✓		✓	✓			✓	✓		✓
1PPS-U	✓	✓	✓		✓		✓	✓	✓	✓

Nummernschlüssel FIPSPLIT® Wellrohre

Part numbering key FIPSPLIT® corrugated conduits



1 Ausführung / Model

- 2** = FIPSPLIT® Standardgewicht
FIPSPLIT® standard weight
- 1** = FIPSPLIT® Lockflex

2 Material / Material type

- PAN** = PA6 MOD
- PAS** = PA6 MOD BS
- PAF** = PA6 MOD V0
- PDS** = PA12 MOD BS
- PDF** = PA12 MOD V0
- PPS** = PP MOD BS
- PPS-U** = PP MOD BS UV
- ETS** = ETFE

3 Rohrprofil / Profile

- M** = Mittleres Profil
Intermediate profile

4 Nennweite / Nominal width (NW)

- 07–48** = NW Standard
- 56–170** = NW XL
- 17M20** = Thread-flex NW17 / Gewinde M20
NW17 / Thread M20

5 Farbe / Colour

- B** = Standard-Schwarz / *Standard black*
- G** = Standard-Grau / *Standard grey*
- U** = UV-Schwarz / *UV black*
- 02** = Spezialfarbe / *Special colour*
z. B. / e.g. 02 = ähnlich / *similar to RAL2003 (Orange)*

6 Verpackungseinheit (VE) / Packing units (PU)

- 50** = Rollen- oder Stücklänge
Coil length or length of pieces
- A** = Individuelle Verpackungseinheit
Individual packing units

M Mittleres Profil / *M intermediate profile*

Anwendungsbereiche:

FIPSPLIT® teilbare Wellrohre

Application areas:

FIPSPLIT® divisible corrugated conduits

Charakteristik Rohrprofil:

etwas breitere Profiltailung als beim Feinprofil für das saubere Umgreifen des Innenrohres durch das Außenrohr

Characteristics profile:

wider profile pitch as for the fine profile, for gripping the outer tube properly to the inner tube

Optimiertes Profil für vielfältige Anwendungsfälle welches die Wellrohre auch bei engen Biegeradien verschlossen hält.

Optimized profile for different applications where the corrugated conduits remain closed also at tight bending radii.

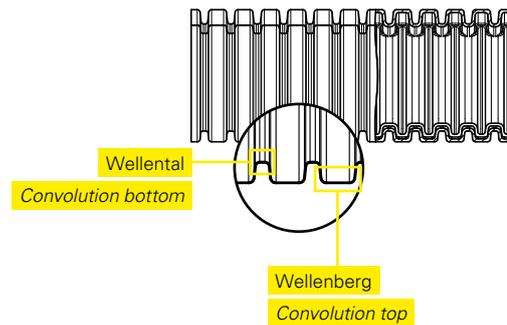

Für nachträglich zu montierenden Kabelschutz, auch für bereits fertig konfektionierte Kabelstränge, inkl. montierter Stecker geeignet.

Suitable for retrofit application of cable protection, also pre-assembled cable harnesses with already installed connectors.

IP-Schutzarten nach EN60529

Ingress protection (IP) according to EN60529

Beispiel IP43 / *Example IP43*

IP 4 3

Erste Ziffer: mit Durchmesser $\geq 1,0$ mm

First digit: with diameter $\geq 1,0$ mm

Zweite Ziffer: Sprühwasser (schräg bis 60°)

Second digit: spray water (up to 60° angle)

Erste Ziffer / <i>First digit</i>		Zweite Ziffer / <i>Second digit</i>	
0	nicht geschützt <i>not protected</i>	0	nicht geschützt <i>not protected</i>
1	mit Durchmesser ≥ 50 mm <i>with diameter ≥ 50 mm</i>	1	senkrechtes Tropfen <i>vertical water drips</i>
2	mit Durchmesser $\geq 12,5$ mm <i>with diameter $\geq 12,5$ mm</i>	2	Tropfen (15° Neigung des Prüflings) <i>drips (up to 15° angle)</i>
3	mit Durchmesser $\geq 2,5$ mm <i>with diameter $\geq 2,5$ mm</i>	3	Sprühwasser (schräg bis 60°) <i>spray water (up to 60° angle)</i>
4	mit Durchmesser $\geq 1,0$ mm <i>with diameter $\geq 1,0$ mm</i>	4	Spritzwasser <i>splashed water</i>
5	staubgeschützt <i>protected against dust</i>	5	Strahlwasser <i>strong water jet</i>
6	staubdicht <i>protected against penetration of dust</i>	6	starkes Strahlwasser mit erhöhtem Druck <i>strong water jet with pressure</i>
		7	zeitweiliges Eintauchen <i>temporary immersion</i>
		8	dauerndes Untertauchen <i>continuous immersion</i>
		9	Hochdruck, Dampfstrahl-Reinigung <i>high pressure steam cleaner</i>

FRÄNKISCHE Meilensteine / *milestones*

Grundlegende Produktentwicklungen

Fundamental product developments

1952

weltweit erstes
flexibles Elektro-
installationsrohr aus
Metall

*World's first flexible
metal conduit*



1961

Weltweit erstes
gewelltes, endlos
produziertes Dränrohr
aus Kunststoff

*World's first corru-
gated continuously
manufactured drain-
age pipe made of
plastic*



1959

Weltweit erstes
flexibles Elektro-
installationsrohr
aus Kunststoff

*World's first flexible
plastic conduit*

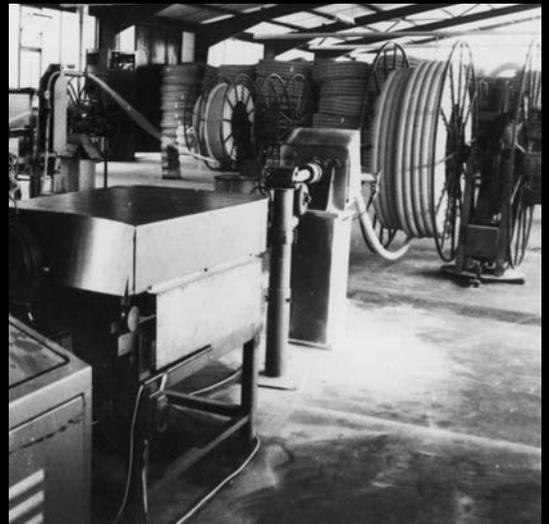

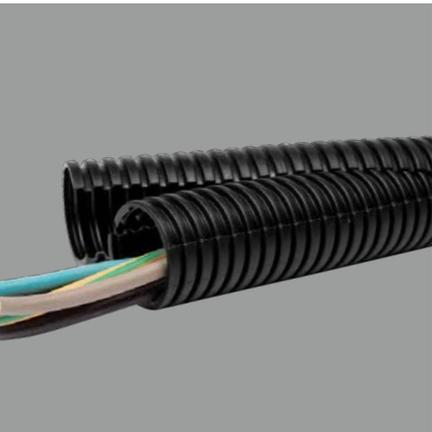

2PPS

Teilbares Wellrohr
Divisible corrugated conduit

+105 °C +221 °F
-40 °C -40 °F

Material: PP MOD BS



- selbstverlöschend, halogen- und cadmiumfrei
- gute Wechselbiegefestigkeit
- UV- und Witterungsbeständigkeit mittel bis gut
- Überlappung des verschleißbaren Doppelrohres schützt eingelegte Kabel vor äußeren Einflüssen

- *self-extinguishing, free of halogen and cadmium*
- *good fatigue strength*
- *average to good weathering performances*
- *double shell conduit properly overlaps and provides enhanced cable protection against external impacts*

Download
2PPS

Das Datenblatt zu unserem Wellrohr 2PPS finden Sie hier.

The datasheet of our corrugated conduit 2PPS can be found here.



Sie interessieren sich für unsere FIP SPLIT® Produkte? Klicken Sie hier zur **Direktanfrage**.
*You are interested in our FIP SPLIT® products? Please click here for **direct inquiry**.*

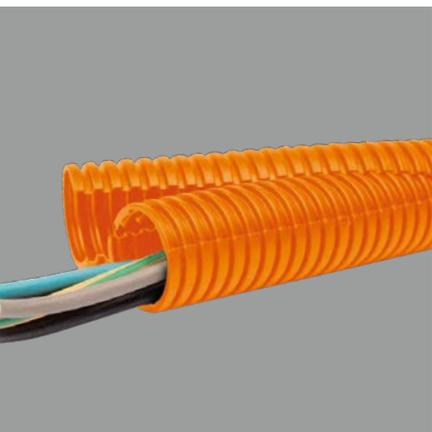

2PPS-O

Teilbares Wellrohr in Orange
Divisible corrugated conduit in orange

+105 °C +221 °F
-40 °C -40 °F

Material: PP MOD BS Orange ähnlich RAL2003 / PP MOD BS orange similar to RAL2003



- selbstverlöschend, halogen- und cadmiumfrei
- gute Wechselbiegefestigkeit
- UV- und Witterungsbeständigkeit mittel bis gut
- Überlappung des verschleißbaren Doppelrohres schützt eingelegte Kabel vor äußeren Einflüssen
- Farbe Orange eignet sich zur gesonderten Kennzeichnung von Anwendungen

- *self-extinguishing, free of halogen and cadmium*
- *good fatigue strength*
- *average to good weathering performances*
- *double shell conduit properly overlaps and provides enhanced cable protection against external impacts*
- *colour orange suitable for marking applications*

Download
2PPS-O

Das Datenblatt zu unserem Wellrohr 2PPS-O finden Sie hier.

The datasheet of our corrugated conduit 2PPS-O can be found here.



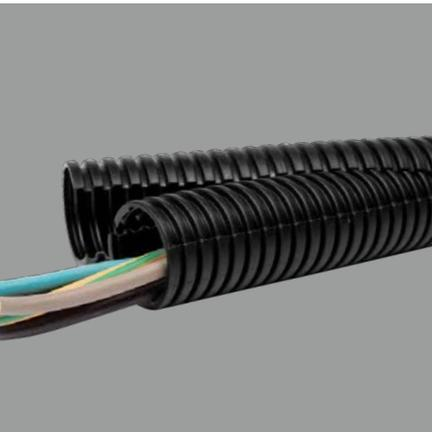

2PPS-U

Teilbares Wellrohr
Divisible corrugated conduit

+105 °C +221 °F
-40 °C -40 °F

Material: PP MOD BS – UV



- selbstverlöschend, halogen- und cadmiumfrei
- gute Wechselbiegefestigkeit
- sehr gute UV- und Witterungsbeständigkeit
- Überlappung des verschleißbaren Doppelrohres schützt eingelegte Kabel vor äußeren Einflüssen

- *self-extinguishing, free of halogen and cadmium*
- *good fatigue strength*
- *very good weathering performances*
- *double shell conduit properly overlaps and provides enhanced cable protection against external impacts*

Download
2PPS-U

Das Datenblatt zu unserem Wellrohr 2PPS-U finden Sie hier.

The datasheet of our corrugated conduit 2PPS-U can be found here.



Sie interessieren sich für unsere FIP SPLIT® Produkte? Klicken Sie hier zur **Direktanfrage**.
*You are interested in our FIP SPLIT® products? Please click here for **direct inquiry**.*

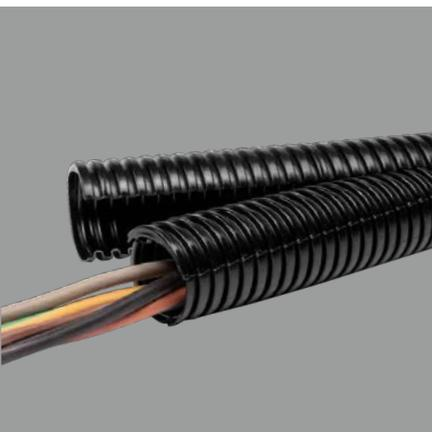

2PAN

Teilbares Wellrohr
Divisible corrugated conduit

+120 °C +248 °F
-45 °C -49 °F

Material: PA6 MOD



- selbstverlöschend, halogen- und cadmiumfrei
- gute Wechselbiegefestigkeit
- gute mechanische Eigenschaften
- mittel bis gute UV- und Witterungsbeständigkeit
- Überlappung des verschleißbaren Doppelrohres schützt eingelegte Kabel vor äußeren Einflüssen

- *self-extinguishing, free of halogen and cadmium*
- *good fatigue strength*
- *good mechanical performances*
- *average to good weathering performances*
- *double shell conduit properly overlaps and provides enhanced cable protection against external impacts*

Download
2PAN

Das Datenblatt zu unserem Wellrohr 2PAN finden Sie hier.

The datasheet of our corrugated conduit 2PAN can be found here.





2PAS

Teilbares Wellrohr
Divisible corrugated conduit

+120 °C +248 °F
-45 °C -49 °F

Material: PA6 MOD BS



- selbstverlöschend, halogen- und cadmiumfrei
- gute Wechselbiegefestigkeit
- gute mechanische Eigenschaften
- gute Brandschutzeigenschaften
- mittel bis gute UV- und Witterungsbeständigkeit
- Überlappung des verschleißbaren Doppelrohres schützt eingelegte Kabel vor äußeren Einflüssen
- *self-extinguishing, free of halogen and cadmium*
- *good fatigue strength*
- *good mechanical performances*
- *good fire safety performances*
- *average to good weathering performances*
- *double shell conduit properly overlaps and provides enhanced cable protection against external impacts*

Download
2PAS

Das Datenblatt zu unserem Wellrohr 2PAS finden Sie hier.

The datasheet of our corrugated conduit 2PAS can be found here.



NFPA 130



Sie interessieren sich für unsere FIPSPLIT® Produkte? Klicken Sie hier zur **Direktanfrage**.
*You are interested in our FIPSPLIT® products? Please click here for **direct inquiry**.*

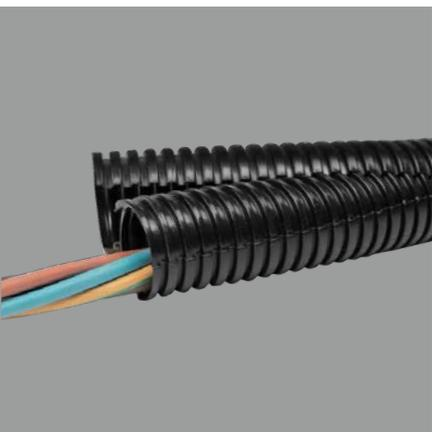

2PAF

Teilbares Wellrohr
mit hervorragender Selbstverlöschung
*Divisible corrugated conduit
with excellent self-extinguishing characters*

+120 °C +248 °F
-45 °C -49 °F

Material: PA6 MOD V0



- selbstverlöschend, halogen- und cadmiumfrei
- gute Wechselbiegefestigkeit
- gute mechanische Eigenschaften
- höchste Brandschutzeigenschaften
- mittel bis gute UV- und Witterungsbeständigkeit
- Überlappung des verschleißbaren Doppelrohres schützt eingelegte Kabel vor äußeren Einflüssen
- *self-extinguishing, free of halogen and cadmium*
- *good fatigue strength*
- *good mechanical performances*
- *excellent fire safety performances*
- *average to good weathering performances*
- *double shell conduit properly overlaps and provides enhanced cable protection against external impacts*

Download
2PAF

Das Datenblatt zu unserem Wellrohr 2PAF finden Sie hier.

The datasheet of our corrugated conduit 2PAF can be found here.



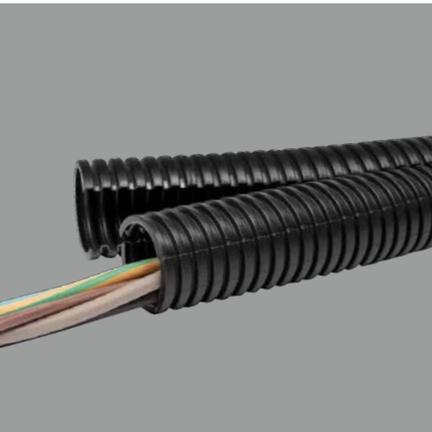

2PDS

Teilbares Wellrohr
Divisible corrugated conduit

+110 °C +230 °F
-50 °C -58 °F

Material: PA12 MOD BS



- selbstverlöschend, halogen- und cadmiumfrei
- sehr gute Wechselbiegefestigkeit
- gute mechanische Eigenschaften
- hohe Brandschutzeigenschaften
- hervorragende UV- und Witterungsbeständigkeit
- Überlappung des verschleißbaren Doppelrohres schützt eingelegte Kabel vor äußeren Einflüssen
- *self-extinguishing, free of halogen and cadmium*
- *very good fatigue strength*
- *good mechanical performances*
- *good fire safety performances*
- *excellent weathering performances*
- *double shell conduit properly overlaps and provides enhanced cable protection against external impacts*

Download
2PDS

Das Datenblatt zu unserem Wellrohr 2PDS finden Sie hier.

The datasheet of our corrugated conduit 2PDS can be found here.



**NFPA
130**



Sie interessieren sich für unsere FIPSPLIT® Produkte? Klicken Sie hier zur **Direktanfrage**.
*You are interested in our FIPSPLIT® products? Please click here for **direct inquiry**.*

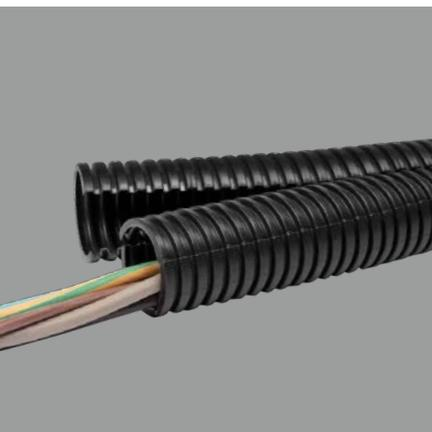

2PDF

Teilbares Wellrohr
mit hervorragenden mechanischen Eigenschaften
*Divisible corrugated conduit
with magnificent mechanical strenght*

+110 °C +230 °F
-50 °C -58 °F

Material: PA12 MOD BS V0



- selbstverlöschend, halogen- und cadmiumfrei
- sehr gute Wechselbiegefestigkeit
- gute mechanische Eigenschaften
- höchste Brandschutzeigenschaften
- hervorragende UV- und Witterungsbeständigkeit
- Überlappung des verschleißbaren Doppelrohres schützt eingelegte Kabel vor äußeren Einflüssen
- *self-extinguishing, free of halogen and cadmium*
- *very good fatigue strength*
- *good mechanical performances*
- *excellent fire safety performances*
- *excellent weathering performances*
- *double shell conduit properly overlaps and provides enhanced cable protection against external impacts*

Download
2PDF

Das Datenblatt zu unserem Wellrohr 2PDF finden Sie hier.

The datasheet of our corrugated conduit 2PDF can be found here.



**NFPA
130**





2ETS

Teilbares Hochtemperaturwellrohr
Divisible high temperature corrugated conduits

+200 °C +392 °F
 -80 °C -112 °F



Material: ETFE



- selbstverlöschend
- gute Wechselbiegefestigkeit
- gute mechanische Eigenschaften
- sehr gute chemische Beständigkeit
- hervorragende UV- und Witterungsbeständigkeit
- Überlappung des verschleißbaren Doppelrohres schützt eingelegte Kabel vor äußeren Einflüssen
- *self-extinguishing*
- *good fatigue strength*
- *good mechanical performances*
- *very good chemical resistance*
- *excellent weathering performances*
- *double shell conduit properly overlaps and provides enhanced cable protection against external impacts*

Download
2ETS

Das Datenblatt zu unserem Wellrohr 2ETS finden Sie hier.

The datasheet of our corrugated conduit 2ETS can be found here.

CE

Sie interessieren sich für unsere FIPSPLIT® Produkte? Klicken Sie hier zur **Direktanfrage**.
 You are interested in our FIPSPLIT® products? Please click here for **direct inquiry**.

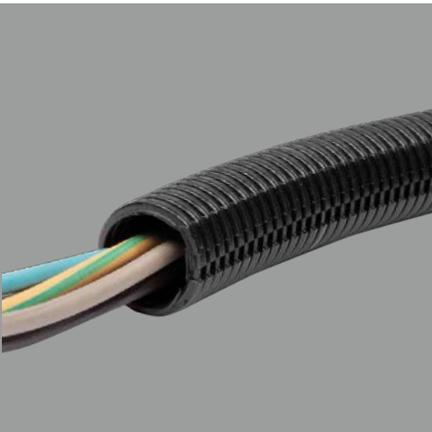

1PAS

Geschlitztes, überlappendes Wellrohr
Slit, overlapping corrugated conduit

+120 °C +248 °F
-45 °C -49 °F

Material: PA6 MOD BS



- selbstverlöschend, halogen- und cadmiumfrei
- gute Wechselbiegefestigkeit
- gute mechanische Eigenschaften
- gute Brandschutzeigenschaften
- durchschnittliche UV- und Witterungsbeständigkeit
- passgenaue Überlappung der Rohr-Längstrennung verhindert ein Aufklaffen des Wellrohres bei Biegungen
- *self-extinguishing, free of halogen and cadmium*
- *good fatigue strength*
- *good mechanical performances*
- *good fire safety performances*
- *average UV and weathering performances*
- *firmly shaped overlapping at the longitudinal slit, opening of the slitted area due to bending is therefore avoided*

Download
1PAS

Das Datenblatt zu unserem Wellrohr 1PAS finden Sie hier.

The datasheet of our corrugated conduit 1PAS can be found here.



**NFPA
130**



**HALOGEN
FREE**

Sie interessieren sich für unsere FIP SPLIT® Produkte? Klicken Sie hier zur **Direktanfrage**.
*You are interested in our FIP SPLIT® products? Please click here for **direct inquiry**.*



1PPS-U

Geschlitztes, überlappendes Wellrohr
Slit, overlapping corrugated conduit

+105 °C +221 °F
-40 °C -40 °F

Material: PP MOD BS – UV



- selbstverlöschend, halogen- und cadmiumfrei
- gute Wechselbiegefestigkeit
- gute mechanische Eigenschaften
- gute UV- und Witterungsbeständigkeit
- passgenaue Überlappung der Rohr-Längstrennung verhindert ein Aufklaffen des Wellrohres bei Biegungen
- *self-extinguishing, free of halogen and cadmium*
- *good fatigue strength*
- *good mechanical performances*
- *good UV and weathering performances*
- *firmly shaped overlapping at the longitudinal slit, opening of the slitted area due to bending is therefore avoided*

Download
1PPS-U

Das Datenblatt zu unserem Wellrohr 1PPS-U finden Sie hier.

The datasheet of our corrugated conduit 1PPS-U can be found here.



**HALOGEN
FREE**

Verschraubungen und Zubehör

Fittings and accessories

zum FIPSPLIT® Produktprogramm / for FIPSPLIT® product range



Produktübersicht / *Product overview*

Produkt Product	Material Material	Seite Page
2CNPA	PA6 SGA MOD BS	118
2CPA	PA6 SGA MOD	118
2SPA-M	PA6 SGA MOD BS	119
2NTPA-PG	PA6 SGA MOD BS	119
2SPA-PG	PA6 SGA MOD BS	120
2NTPA-M	PA6 SGA MOD BS	120

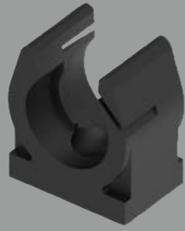

Sie interessieren sich für unsere Produkte?
 Klicken Sie hier zur **Direktanfrage**.
 You are interested in our products?
 Please click here for **direct inquiry**.

Empfohlene Anwendungsbereiche / Recommended areas of application

Produkt Product										
2CNPA	✓	✓	✓	✓	✓	✓	✓	✓	✓	✓
2CPA	✓	✓	✓	✓	✓	✓	✓	✓	✓	✓
2SPA-M	✓	✓	✓	✓	✓	✓	✓	✓	✓	✓
2NTPA-M	✓	✓	✓	✓	✓	✓	✓	✓	✓	✓
2SPA-PG	✓	✓	✓	✓	✓	✓	✓	✓	✓	✓
2NTPA-PG	✓	✓	✓	✓	✓	✓	✓	✓	✓	✓

Nummernschlüssel FIPSPLIT® Zubehörteile

Part numbering key FIPSPLIT® accessories

1 2 3 4 5 6 7 8 9
2 **CN** **PA** - **07** **B** . **10**

1 Zubehör / Accessory group

2 = FIPSPLIT® Zubehör / FIPSPLIT® accessories

2 Zubehörartikel / Material type

CO = Befestigungsclip mit Verschlusskappe
Mounting clip with cover

CN = Befestigungsclip ohne Verschlusskappe
Mounting clip without cover

CU = Rohrschelle Omega
Clamp Omega

CP = Rohrschelle
Clamp

NT = Gegenmutter
Locknut

NE = Gewindeerweiterung
Thread enlarger

NR = Gewindereduktion
Thread reducer

PE = Rohr-Kantenschutz
Conduit edge protection (FE-KA)

PT = Rohrendtülle
Conduit termination sleeve (FE-K)

TD = Kabel-Einzugswerkzeug
Cable-draw-in tool

3 Materialart / Material type

BN = Messing vernickelt / Brass nickel plated

PA = verschiedene PA6-Typen / various PA6 types

SZ = Edelstahl / Stainless steel

TP = TPE

entweder 4 oder 5+6 / either 4 or 5+6

4 Nennweite / Nominal width (NW)

07 – 48 = NW Standard

56 – 170 = NW XL

5 Gewindeart / Thread type

M = metrisch / metric

P = PG

N = NPT

6 Gewindegröße / Thread size

siehe Gewindeübersicht auf Seite 13
see thread table on page 13

7 Profil / Profile

F = Feinprofil / Fine profile

C = Grobprofil / Coarse profile

8 Farbe / Colour

B = Standard-Schwarz / Standard black

G = Standard-Grau / Standard grey

9 Modifikationscode

Modification code

Gewindeübersicht

Thread codes

Typ Type	Gewindegröße Thread size	Nummernschlüssel Part numbering key
M = metrisch metric EN 60423	M16x1,5	M16
	M20x1,5	M20
	M25x1,5	M25
	M32x1,5	M32
	M40x1,5	M40
	M50x1,5	M50

P = PG DIN 40430	PG9	P09
	PG13,5	P13
	PG21	P21
	PG29	P29

Typ Type	Gewindegröße Thread size	Nummernschlüssel Part numbering key
M = metrisch metric EN 60423	M16x1,5	M16
	M20x1,5	M20
	M25x1,5	M25
	M32x1,5	M32
	M40x1,5	M40
	M50x1,5	M50

P = PG DIN 40430	PG9	P09
	PG13,5	P13
	PG21	P21
	PG29	P29

IP-Schutzarten nach EN60529

Ingress protection (IP) according to EN60529

Beispiel IP43 / *Example IP43*

IP 4 3

Erste Ziffer: mit Durchmesser $\geq 1,0$ mm

First digit: with diameter $\geq 1,0$ mm

Zweite Ziffer: Sprühwasser (schräg bis 60°)

Second digit: spray water (up to 60° angle)

Erste Ziffer / <i>First digit</i>		Zweite Ziffer / <i>Second digit</i>	
0	nicht geschützt <i>not protected</i>	0	nicht geschützt <i>not protected</i>
1	mit Durchmesser ≥ 50 mm <i>with diameter ≥ 50 mm</i>	1	senkrechtes Tropfen <i>vertical water drips</i>
2	mit Durchmesser $\geq 12,5$ mm <i>with diameter $\geq 12,5$ mm</i>	2	Tropfen (15° Neigung des Prüflings) <i>drips (up to 15° angle)</i>
3	mit Durchmesser $\geq 2,5$ mm <i>with diameter $\geq 2,5$ mm</i>	3	Sprühwasser (schräg bis 60°) <i>spray water (up to 60° angle)</i>
4	mit Durchmesser $\geq 1,0$ mm <i>with diameter $\geq 1,0$ mm</i>	4	Spritzwasser <i>splashed water</i>
5	staubgeschützt <i>protected against dust</i>	5	Strahlwasser <i>strong water jet</i>
6	staubdicht <i>protected against penetration of dust</i>	6	starkes Strahlwasser mit erhöhtem Druck <i>strong water jet with pressure</i>
		7	zeitweiliges Eintauchen <i>temporary immersion</i>
		8	dauerndes Untertauchen <i>continuous immersion</i>
		9	Hochdruck, Dampfstrahl-Reinigung <i>high pressure steam cleaner</i>

Kabelschutz / *Cable protection*

für die Schienenverkehrstechnik
for rail transport technology



- zuverlässiger Schutz für sensible Verkabelungen und Leitungen
reliable protection of sensitive cables and wires
- Erfüllung internationaler Brandschutzvorschriften
compliance with international fire protection regulations
- Lösungen zur nachträglichen Installation
retrofit installation solutions
- hohe dynamische Belastbarkeit
high dynamic load capacity

- breites und tiefes Sortiment an Wellrohranschlüssen mit Metallgewinde und ONE for all IP-Lösung
broad and deep range of fittings with metal thread and ONE for all IP solution
- hohe Witterungsbeständigkeit
high level of weather resistance

FIP SYSTEMS®





2CNPA

Befestigungsclip
Mounting clip

+120 °C +248 °F
-45 °C -49 °F

Material: PA6 MOD BS SGA



- Standard-Montagehalter für FIPSPLIT® Wellrohre
- Schlitz zur Anbringung eines Kabelbinders bei erhöhter Belastung
- *standard mounting clip for FIPSPLIT® corrugated conduits*
- *slit for cable tie application for reinforced loads*

Download
2CNPA

Das Datenblatt zu unserem Befestigungsclip 2CNPA finden Sie hier.

The datasheet of our mounting clip 2CNPA can be found here.



HALOGEN
FREE

Sie interessieren sich für unsere FIPSPLIT® Zubehörteile? Klicken Sie hier zur **Direktanfrage**.
*You are interested in our FIPSPLIT® accessories? Please click here for **direct inquiry**.*



2CPA

Rohrverbinder
Conduit connector

+120 °C +248 °F
-45 °C -49 °F

Material: PA6 MOD BS SGA



- teilbarer Wellrohr-Verbinder für FIPSPLIT® Wellrohre
- zur Verbindung und Verlängerung von teilbaren Wellrohren
- geeignet für Nachinstallationen
- *divisible conduit fitting (splice) for FIPSPLIT® corrugated conduits*
- *to connect and extend divisible corrugated conduits*
- *suitable for retrofit application*

Download
2CPA

Das Datenblatt zu unserem Rohrverbinder 2CPA finden Sie hier.

The datasheet of our conduit connector 2CPA can be found here.



HALOGEN
FREE



2SPA-M

+120 °C +248 °F
-45 °C -49 °F

Teilbare Verschraubung
gerade, metrisch
*Divisible fitting
straight, metric*

Material: PA6 MOD BS SGA



- teilbare, gerade Anschlussverschraubung für FIPSPLIT® Wellrohre
- mit metrischem Gewinde
- *divisible straight fitting for FIPSPLIT® corrugated conduits*
- *with metric thread*

Download
2SPA-M

Das Datenblatt zu unserer Verschraubung 2SPA-M finden Sie hier.

The datasheet of our fitting 2SPA-M can be found here.



Sie interessieren sich für unsere FIPSPLIT® Zubehörteile? Klicken Sie hier zur **Direktanfrage**.
*You are interested in our FIPSPLIT® accessories? Please click here for **direct inquiry**.*



2NTPA-M

+120 °C +248 °F
-45 °C -49 °F

Teilbare Gegenmutter
metrisch
*Divisible locknut
metric*

Material: PA6 MOD BS SGA



- teilbare Sechskant-Gegenmutter metrisch
- passend zu FIPLOCK® ONE Verschraubungen mit metrischem Gewinde
- geeignet für Nachinstallationen
- *divisible hexagon locknuts with metric threads*
- *suitable for FIPLOCK® ONE fittings with metric threads*
- *suitable for retrofit application*

Download
2NTPA-M

Das Datenblatt zu unsere Gegenmutter 2NTPA-M finden Sie hier.

The datasheet of our locknut 2NTPA-M can be found here.





2SPA-PG

+120 °C +248 °F
-45 °C -49 °F

Teilbare Verschraubung
gerade, PG
*Divisible fitting
straight, PG*

Material: PA6 MOD BS SGA



- teilbare, gerade Anschlussverschraubung für FIPSPLIT® Wellrohre
- mit PG-Gewinde

- *divisible straight fitting for FIPSPLIT® corrugated conduits*
- *with PG thread*

Download
2SPA-PG

Das Datenblatt zu unserer Verschraubung 2SPA-PG finden Sie hier.

The datasheet of our fitting 2SPA-PG can be found here.



Sie interessieren sich für unsere FIPSPLIT® Zubehörteile? Klicken Sie hier zur **Direktanfrage**.
*You are interested in our FIPSPLIT® accessories? Please click here for **direct inquiry**.*



2NTPA-PG

+120 °C +248 °F
-45 °C -49 °F

Teilbare Gegenmutter
PG
*Divisible locknut
PG*

Material: PA6 MOD BS SGA



- teilbare Sechskant-Gegenmutter mit PG-Gewinde
- passend zu FIPLOCK® ONE Verschraubungen mit PG-Gewinde
- geeignet für Nachinstallationen

- *divisible hexagon locknut with PG thread*
- *suitable for FIPLOCK® ONE fittings with PG threads*
- *suitable for retrofit application*

Download
2NTPA-PG

Das Datenblatt zu unserer Gegenmutter 2NTPA-PG finden Sie hier.

The datasheet of our locknut 2NTPA-PG can be found here.



FRÄNKISCHE

INDUSTRIAL PIPES

FRÄNKISCHE Meilensteine / *milestones*

Umfirmierung und Generationswechsel

Renaming and generation change



1983



1977

Umfirmierung
Renaming

„FRÄNKISCHE
Rohrwerke Gebr.
Kirchner GmbH
& Co. KG“

Eintritt
von Otto Kirchner
*Joining
of Otto Kirchner*
(3. Generation)



Speziallösungen

Special solutions

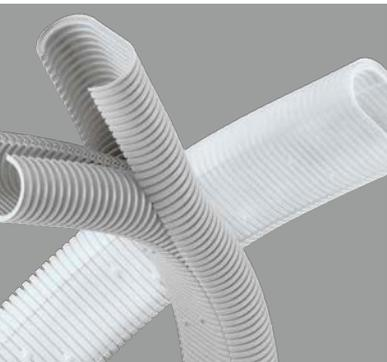

Produktübersicht / *Product overview*

Produkt <i>Product</i>	Material <i>Material</i>	Profil <i>Profile</i>	Zubehör <i>Accessories</i>	Seite <i>Page</i>
IPAT	PA6 MOD BS	F	✓	128
OPPS	PP MOD BS	F	✓	128
OPAS	PA6 MOD BS	F	✓	129
OPAF	PA6 MOD V0	F	✓	129
OPDS	PA12 MOD BS	F	✓	130
OPDF	PA12 MOD V0	F	✓	130
DPPS	PP MOD BS	X		131
DPPS-U	PP MOD BS UV	X		131
FEVS	EVA	F	✓	132
FPES	PE LD BS	F	✓	132
FPASH	PA6 MOD BS	H		133
FPANH	PA6 MOD	H		133
FPASS	PA6 MOD BS	S		134

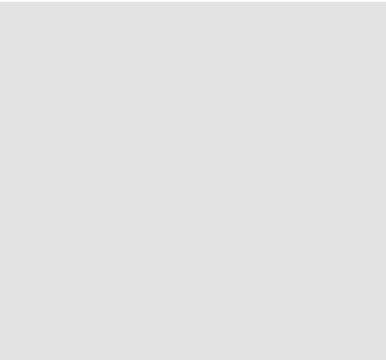
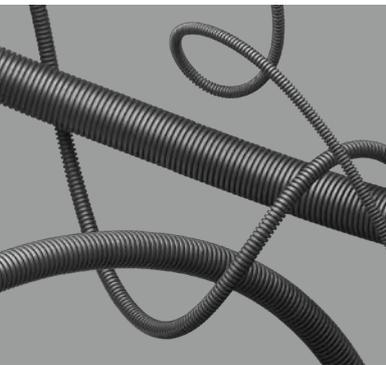

Sie interessieren sich für unsere Produkte?
 Klicken Sie hier zur **Direktanfrage**.
 You are interested in our products?
 Please click here for **direct inquiry**.

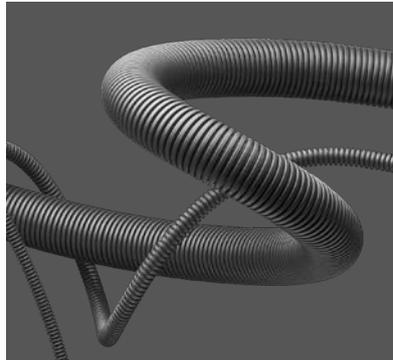

Empfohlene Anwendungsbereiche / Recommended areas of application

Produkt Product										
IPAT	✓		✓	✓			✓	✓		✓
OPPS	✓		✓				✓	✓		✓
OPAS	✓		✓	✓			✓	✓		✓
OPAF	✓			✓			✓			✓
OPDS	✓	✓	✓	✓	✓	✓	✓	✓		✓
OPDF	✓	✓	✓	✓		✓	✓	✓		✓
DPPS	✓		✓				✓	✓		✓
DPPS-U	✓	✓	✓	✓	✓			✓		✓
FEVS	✓									✓
FPES	✓							✓		✓
FPASH	✓			✓			✓			✓
FPASS	✓			✓			✓			✓
FPANH	✓									✓

Nummernschlüssel FIPSPECIALS® Wellrohre

Part numbering key FIPSPECIALS® corrugated conduits

1 2 3 4 4 4 5 6
I **PAT** **F** - **07** **M** **10** **B** . **10**

1 Ausführung / Model

- F** = FIPSPECIALS® Standardgewicht
FIPSPECIALS® standard weight
- D** = Teilbares Ovalrohr
Divisible oval
- I** = einzeln / segmentiert
individuel / segmented
- O** = Ovales Standardgewicht
Oval standard weight

2 Material / Material type

- PAN** = PA6 MOD
- PAS** = PA6 MOD BS
- PDS** = PA12 MOD BS
- PDF** = PA12 MOD V0
- PPS** = PP MOD BS
- PPS-U** = PP MOD BS UV
- PES** = PE LD BS
- EVS** = EVA
- PAT** = PA6 MOD BS

3 Profil / Profile

- F** = Feinprofil / *Fine profile*
- H** = Profil Hohe Welle / *High wave profile*
- S** = Profil Softwave / *Softwave profile*
- X** = Sonderprofil / *Special profile*

4 Nennweite / Nominal width (NW)

- 07 – 48** = NW Standard
- 10 – 29** = NW Hohe Welle / *High wave*
- 10 – 29** = NW Profil Softwave / *Softwave profile*
- 10 – 40** = NW Standard Ovalrohr / *Standard oval conduit*
- 4080** = NW Teilbares Ovalrohr / *Divisible oval conduit*
- 17M20** = Thread-flex NW17 / Gewinde M20
Thread-flex NW17 / Thread M20

5 Farbe / Colour

- B** = Standard-Schwarz / *Standard black*
- G** = Standard-Grau / *Standard grey*
- U** = UV-Schwarz / *UV black*
- W1** = Spezialfarbe / *Special colour*
z. B. / *e.g.* W1 = Weiß / *White*

6 Modifikationscode Modification code

F Feinprofil / *F fine profile*

Anwendungsbereiche:

für engere Biegeradien und geringere Biegesteifigkeit

Application areas:

for tighter bending radii and lower bending stiffness

Charakteristik Rohrprofil:

feinere Profilteilung über Wellenberg und Wellental

Characteristics profile:

fine profile pitch over convolution top and convolution bottom

Durch mehr Wellen pro Längeneinheit werden Biegespannungen optimal verteilt.

More convolutions per length provide an optimized distribution of bending stress to the material.

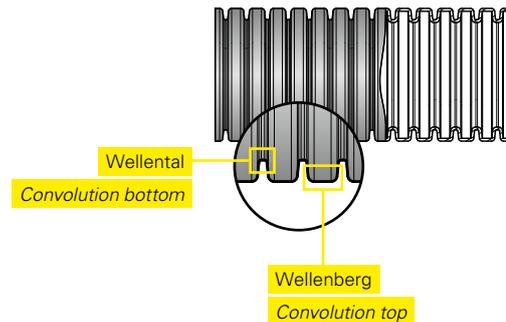

H Hohe Welle / *H high wave*

Anwendungsbereiche:

für engste Biegeradien und geringste Biegesteifigkeit

Application areas:

for tightest bending radii and lowest bending rigidity

Charakteristik Rohrprofil:

höheres Wellenprofil ermöglicht eine bessere Biegebarkeit des Wellrohres

Characteristics profile:

highwave profile enables a better bending behaviour of the corrugated conduit

Durch höheres Wellenprofil reduzieren sich die Biegekräfte spürbar.

Highwave profile reduces bending forces remarkably.

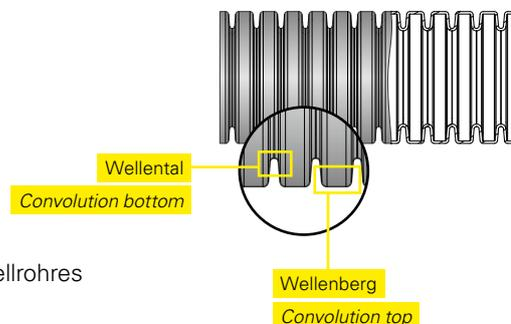

Rohrprofile

Profiles

S Softwave / S Softwave

Anwendungsbereiche:

reduziert Abrieb an innenliegenden Leitungen unter hohen Vibrationen

Application areas:

reduces chafing of applied cables/wires at high vibrations

Charakteristik Rohrprofil:

breites Wellental im Innern der Wellrohre ermöglicht höhere Auflageflächen der Leitungen

Characteristics profile:

wide convolution bottom inside the corrugated conduits for larger contact surface for cables/wires

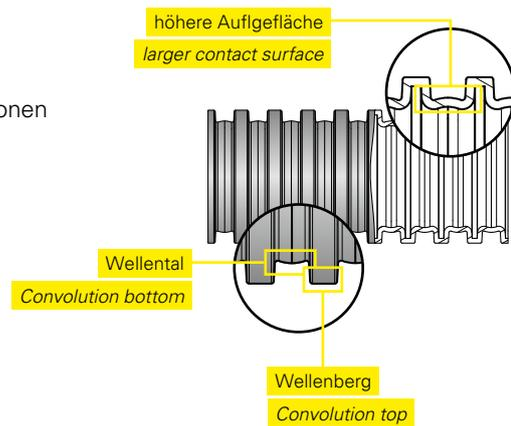

X Sonderprofil / X special profile

Kabelschutz / *Cable protection*

für den industriellen Einsatz
for industrial applications



- vielseitig einsetzbar
can be used in a wide range of applications
- Erfüllung internationaler Vorschriften
compliance with international regulations
- Lösungen zur nachträglichen Installation
retrofit installation solutions
- breites und tiefes Sortiment an Wellrohranschlüssen mit Kunststoffgewinde und ONE for all IP-Lösung
broad and deep range of fittings with plastic thread and ONE for all IP solution
- herausragende mechanische Beständigkeit
superb mechanical strength
- hohe dynamische Belastbarkeit
high dynamic load performance
- in unterschiedlichen Materialqualitäten erhältlich
available in various materials

FIP SYSTEMS®





IPAT

Gewinderohr
Threadflex

+120 °C +248 °F
-45 °C -49 °F

Material: PA6 MOD BS



- Wellrohr mit integrierten Gewindeanschlusssegmenten
- gute mechanische Eigenschaften
- hohe chemische Beständigkeit
- selbstverlöschend, halogen- und cadmiumfrei
- gute UV- und Witterungsbeständigkeit
- *corrugated conduit with incorporated repeating thread sections*
- *good mechanical performances*
- *high chemical resistance*
- *self-extinguishing, free from halogens and cadmium*
- *good UV and weathering performances*

Download
IPAT

Das Datenblatt zu unserem Gewinderohr IPAT finden Sie hier.

The datasheet of our threadflex IPAT can be found here.



NFPA
130



Sie interessieren sich für unsere FIP SPECIALS® Produkte? Klicken Sie hier zur **Direktanfrage**.
*You are interested in our FIP SPECIALS® products? Please click here for **direct inquiry**.*

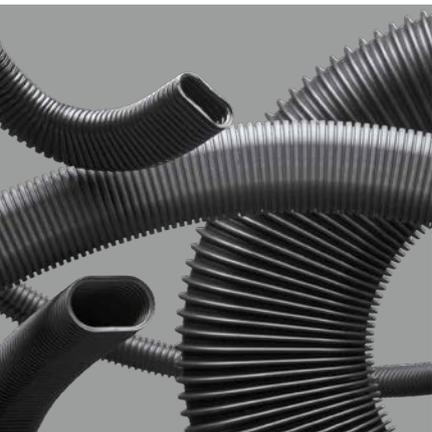

OPSS

Ovales Spezialwellrohr
Oval special corrugated conduit

+105 °C +221 °F
-30 °C -22 °F

Material: PP MOD BS



- oval geformtes Wellrohr
- geeignet für platzsparende Verlegung für Kabel und Leitungen
- hohe Biegebarkeit
- selbstverlöschend, halogen- und cadmiumfrei
- gute Witterungseigenschaften
- *corrugated conduit with oval cross sections*
- *suitable for space saving installations of cable and wires*
- *excellent pliability*
- *self-extinguishing, free from halogens and cadmium*
- *good UV and weathering performance*

Download
OPSS

Das Datenblatt zu unserem Spezialwellrohr OPSS finden Sie hier.

The datasheet of our special corrugated conduit OPSS can be found here.



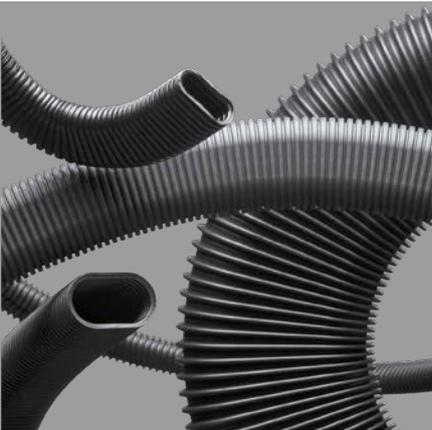

OPAS

Ovales Spezialwellrohr
Oval special corrugated conduit

+120 °C +248 °F
-45 °C -49 °F

Material: PA6 MOD BS



- oval geformtes Wellrohr
- geeignet für platzsparende Verlegung für Kabel und Leitungen
- hohe Biegebarkeit
- erhöhte Brandschutzeigenschaften
- selbstverlöschend, halogen- und cadmiumfrei
- gute Witterungseigenschaften
- *corrugated conduit with oval cross sections*
- *suitable for space saving installations of cable and wires*
- *excellent pliability*
- *very good fire safety performances*
- *self-extinguishing, free from halogens and cadmium*
- *good UV and weathering performance*

Download
OPAS

Das Datenblatt zu unserem Spezialwellrohr OPAS finden Sie hier.

The datasheet of our special corrugated conduit OPAS can be found here.



**NFPA
130**



Sie interessieren sich für unsere FIPSPECIALS® Produkte? Klicken Sie hier zur **Direktanfrage**.
*You are interested in our FIPSPECIALS® products? Please click here for **direct inquiry**.*

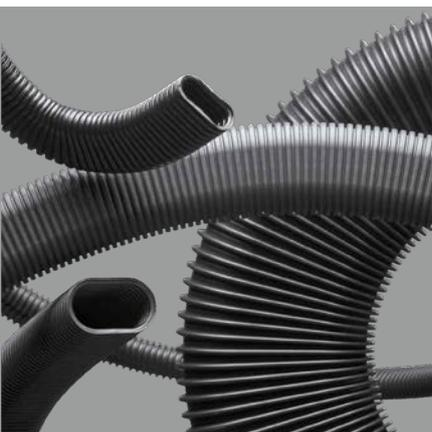

OPAF

Ovales Spezialwellrohr
mit hervorragender Selbstverlöschung
*Oval special corrugated conduit
with excellent self-extinguishing characters*

+120 °C +248 °F
-45 °C -49 °F

Material: PA6 MOD V0



- oval geformtes Wellrohr
- geeignet für platzsparende Verlegung für Kabel und Leitungen
- sehr hohe Biegebarkeit
- höchste Brandschutzeigenschaften
- selbstverlöschend, halogen- und cadmiumfrei
- gute Witterungseigenschaften
- *corrugated conduit with oval cross sections*
- *suitable for space saving installations of cable and wires*
- *excellent pliability*
- *excellent fire safety performances*
- *self-extinguishing, free from halogens and cadmium*
- *good UV and weathering performance*

Download
OPAF

Das Datenblatt zu unserem Spezialwellrohr OPAF finden Sie hier.

The datasheet of our special corrugated conduit OPAF can be found here.



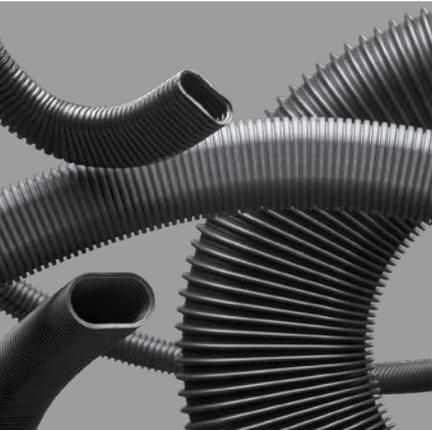

OPDS

Ovales Spezialwellrohr
Oval special corrugated conduit

+110 °C +230 °F
-50 °C -58 °F

Material: PA12 MOD BS



- oval geformtes Wellrohr
- geeignet für platzsparende Verlegung für Kabel und Leitungen
- ausgezeichnete Wechsellbiegefestigkeit
- höchste Brandschutzeigenschaften
- selbstverlöschend, halogen- und cadmiumfrei
- hervorragende Witterungseigenschaften
- *corrugated conduit with oval cross sections*
- *suitable for space saving installations of cable and wires*
- *excellent fatigue strength*
- *excellent fire safety performances*
- *self-extinguishing, free from halogens and cadmium*
- *excellent UV and weathering performance*



**NFPA
130**



Download
OPDS

Das Datenblatt zu unserem Spezialwellrohr OPDS finden Sie hier.

The datasheet of our special corrugated conduit OPDS can be found here.

Sie interessieren sich für unsere FIPSPECIALS® Produkte? Klicken Sie hier zur **Direktanfrage**.
*You are interested in our FIPSPECIALS® products? Please click here for **direct inquiry**.*

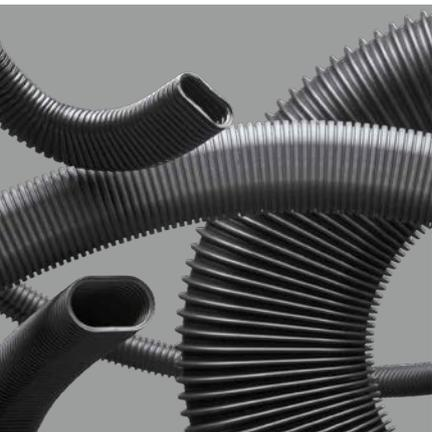

OPDF

Ovales Spezialwellrohr
mit hervorragenden mechanischen Eigenschaften
*Oval special corrugated conduit
with magnificent mechnaical strenght*

+110 °C +230 °F
-50 °C -58 °F

Material: PA12 MOD V0



- oval geformtes Wellrohr
- geeignet für platzsparende Verlegung für Kabel und Leitungen
- gute Wechsellbiegefestigkeit
- höchste Brandschutzeigenschaften
- selbstverlöschend, halogen- und cadmiumfrei
- hervorragende Witterungseigenschaften
- *corrugated conduit with oval cross sections*
- *suitable for space saving installations of cable and wires*
- *good fatigue strength*
- *excellent fire safety performances*
- *self-extinguishing, free from halogens and cadmium*
- *excellent UV and weathering performance*



**NFPA
130**



Download
OPDF

Das Datenblatt zu unserem Spezialwellrohr OPDF finden Sie hier.

The datasheet of our special corrugated conduit OPDF can be found here.

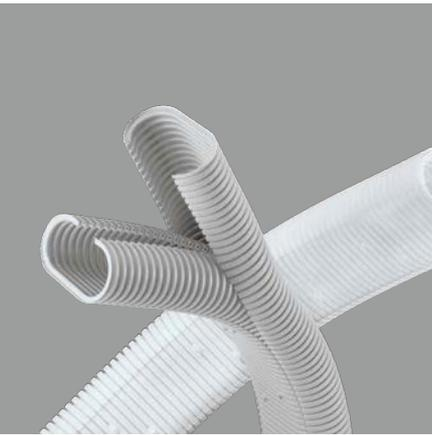

DPPS

Ovales teilbares Wellrohr
Oval divisible corrugated conduit

+105 °C +221 °F
-30 °C -22 °F

Material: PP MOD BS



- ovales, teilbares Wellrohr für nachträgliche Installationen bei geringen Einbauhöhen
- gute Wechselbiegefestigkeit
- sehr gute chemische Beständigkeit
- selbstverlöschend, halogen- und cadmiumfrei
- gute Witterungseigenschaften
- *oval, divisible corrugated conduit for retrofit applications for space saving installations*
- *good fatigue strength*
- *very good chemical resistance*
- *self-extinguishing, free from halogens and cadmium*
- *good UV and weathering performance*



Download
DPPS

Das Datenblatt zu unserem teilbaren Wellrohr DPPS finden Sie hier.

The datasheet of our divisible corrugated conduit DPPS can be found here.

Sie interessieren sich für unsere FIPSPECIALS® Produkte? Klicken Sie hier zur **Direktanfrage**.
*You are interested in our FIPSPECIALS® products? Please click here for **direct inquiry**.*

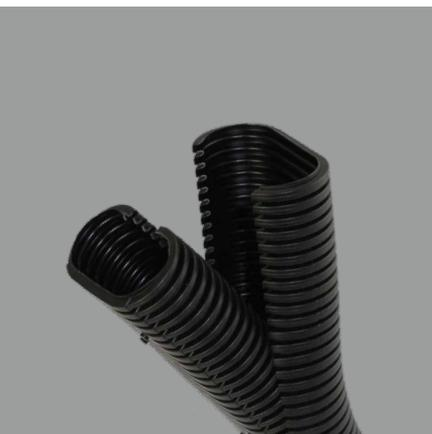

DPPS-U

Ovales teilbares Wellrohr
Oval divisible corrugated conduit

+105 °C +221 °F
-40 °C -40 °F

Material: PP MOD BS UV



- ovales, teilbares Wellrohr für nachträgliche Installationen bei geringen Einbauhöhen
- gute Wechselbiegefestigkeit
- sehr gute chemische Beständigkeit
- selbstverlöschend, halogen- und cadmiumfrei
- höchste Witterungseigenschaften
- *oval, divisible corrugated conduit for retrofit applications for space saving installations*
- *good fatigue strength*
- *very good chemical resistance*
- *self-extinguishing, free from halogens and cadmium*
- *excellent UV and weathering performance*



Download
DPPS-U

Das Datenblatt zu unserem teilbaren Wellrohr DPPS-U finden Sie hier.

The datasheet of our divisible corrugated conduit DPPS-U can be found here.

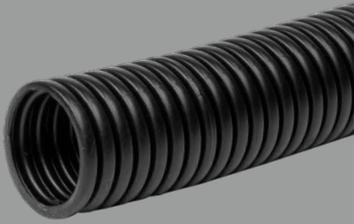

FEVS

Allrounder Wellrohr
zur Kabelbündelung
*Allrounder corrugated conduit
for cable bundling*

+55 °C +131 °F
-40 °C -40 °F

Material: EVA



- selbstverlöschend, halogen- und cadmiumfrei
- gute Flexibilität
- weiches, flexibles Wellrohr zur Kabelbündelung

- *self-extinguishing, free of halogen and cadmium*
- *good flexibility quality*
- *soft and flexible corrugated conduit for cable bundling purpose*

Download
FEVS

Das Datenblatt zu unserem Wellrohr
FEVS finden Sie hier.

*The datasheet of our corrugated conduit
FEVS can be found here.*



Sie interessieren sich für unsere FIPSPECIALS® Produkte? Klicken Sie hier zur **Direktanfrage**.
*You are interested in our FIPSPECIALS® products? Please click here for **direct inquiry**.*

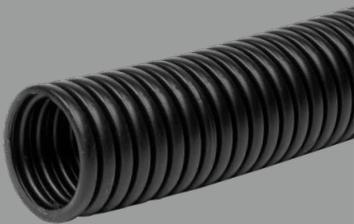

FPES

Wellrohr
zur Bündelung von Litzen und Leitern
*Corrugated conduit
for bundling and leading wires*

+70 °C +158 °F
-40 °C -40 °F

Material: PE LD BS



- selbstverlöschend, halogen- und cadmiumfrei
- leichte Biegsamkeit
- guter Abriebschutz im Schaltschrankbau
- geringe Witterungsbeständigkeit
- weiches, flexibles Wellrohr zur Kabelbündelung

- *self-extinguishing, free of halogen and cadmium*
- *very pliable*
- *good abrasion protection within switchboard applications*
- *marginal weathering performances*
- *soft and flexible corrugated conduit for cable bundling purpose*

Download
FPES

Das Datenblatt zu unserem Wellrohr
FPES finden Sie hier.

*The datasheet of our corrugated
conduit FPES can be found here.*





FPASH

Wellrohr
mit dem Profil Hohe Welle
*Corrugated conduit
with high wave profile*

+120 °C +248 °F
-45 °C -49 °F

Material: PA6 MOD BS



- selbstverlöschend, halogen- und cadmiumfrei
- ausgezeichnete Druckfestigkeit
- geringe Biegesteifigkeit
- gute Brandschutzeigenschaften
- sehr gute chemische Beständigkeit
- gute Witterungseigenschaften
- einsetzbar für dynamische Bewegungen und engen Platzverhältnissen
- *self-extinguishing, free of halogen and cadmium*
- *excellent compression strength*
- *good pliability characteristics*
- *good fire safety performances*
- *very good chemical resistance*
- *good weathering performances*
- *suitable for dynamic applications and applications with limited space availability*

Download
FPASH

Das Datenblatt zu unserem Wellrohr FPASH finden Sie hier.

The datasheet of our corrugated conduit FPASH can be found here.



**NFPA
130**



Sie interessieren sich für unsere FIPSPECIALS® Produkte? Klicken Sie hier zur **Direktanfrage**.
*You are interested in our FIPSPECIALS® products? Please click here for **direct inquiry**.*



FPANH

Wellrohr
mit dem Profil Hohe Welle
*Corrugated conduit
with high wave profile*

+120 °C +248 °F
-45 °C -49 °F

Material: PA6 MOD



- selbstverlöschend, halogen- und cadmiumfrei
- ausgezeichnete Druckfestigkeit
- geringe Biegesteifigkeit
- sehr gute chemische Beständigkeit
- gute Witterungseigenschaften
- einsetzbar für dynamische Bewegungen und engen Platzverhältnissen
- *self-extinguishing, free of halogen and cadmium*
- *excellent compression strength*
- *good pliability characteristics*
- *very good chemical resistance*
- *good weathering performances*
- *suitable for dynamic applications and applications with limited space availability*

Download
FPANH

Das Datenblatt zu unserem Wellrohr FPANH finden Sie hier.

The datasheet of our corrugated conduit FPANH can be found here.



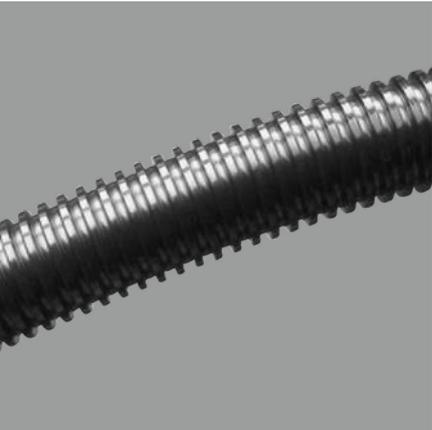

FPASS

Wellrohr
mit dem Profil Softwave
*Corrugated conduit
with softwave profile*

+120 °C +248 °F
-45 °C -49 °F

Material: PA6 MOD BS



Download
FPASS

Das Datenblatt zu unserem Wellrohr
FPASS finden Sie hier.

*The datasheet of our corrugated
conduit FPASS can be found here.*

- selbstverlöschend, halogen- und cadmiumfrei
- ausgezeichnete Druckfestigkeit
- gute Brandschutzeigenschaften
- geringe Biegesteifigkeit
- sehr gute chemische Beständigkeit
- gute Witterungseigenschaften
- abgeflachte Wellrohrgeometrie in der Innenfläche, daher für Anwendungen mit starken Vibrationen geeignet
- verhindert Scheuern von Kabel- und Leiterisolationen
- *self-extinguishing, free of halogen and cadmium*
- *excellent compression strength*
- *good fire safety performances*
- *good pliability characteristics*
- *very good chemical resistance*
- *good weathering performances*
- *reduced corrugated conduit geometry in inner surface, suitable for applications with heavy vibration*
- *avoids chafing of sensitive cables and wires*



**NFPA
130**



Sie interessieren sich für unsere FIPSPECIALS® Produkte? Klicken Sie hier zur **Direktanfrage**.
*You are interested in our FIPSPECIALS® products? Please click here for **direct inquiry**.*

FRÄNKISCHE Meilensteine / *milestones*

Ausgründung und weitere Produktentwicklungen

Spin-off and further product developments

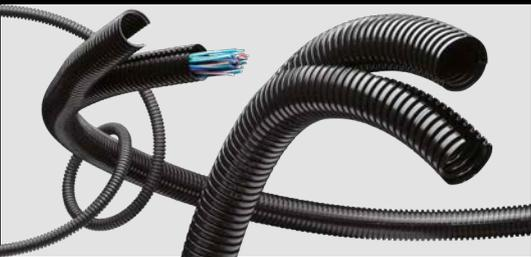
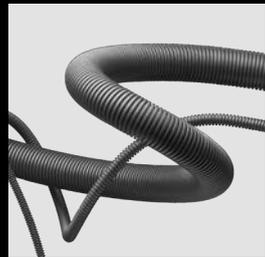
<p>Weltweit erstes zweiteiliges Wellrohr „Co-Flex“</p> <p><i>World's first two-piece corrugated pipe „Co-Flex“</i></p>	<p>1986</p>			<p>Industrie <i>Industry</i></p>
		<p>Ausgründung <i>Spin-off</i></p> <p>FRÄNKISCHE Industrial Pipes GmbH & Co. KG</p>		
	<p>2014</p>		<p>2008</p>	<p>Automotive</p>
<p>Projektstart / <i>Project start</i></p> <p>FIP SYSTEMS®</p>				



Textile Schutzschläuche

Textile protection sleeves



Produktübersicht / *Product overview*

Produkt <i>Product</i>	Material <i>Material</i>	Seite <i>Page</i>
BPET-CC	Polyester	140
BPET-V0	PET V0	140
BPA66-CC	Polyamid 6.6 / <i>Polyamide 6.6</i>	141
WPET-HS	PET	141
WPET-SC	PET	142
WPET-SCF	PET V0	142
KPA-PC	PA6/PET + PU-Lackierung / <i>PA6/PET + PU laquering</i>	143
WGF-LA	Glasfasergewebe mit Aluminium-Kaschierung <i>Woven glass with aluminium coating</i>	143
BCUTP	verzinnete Kupferlitzen / <i>tin-plated copper</i>	144

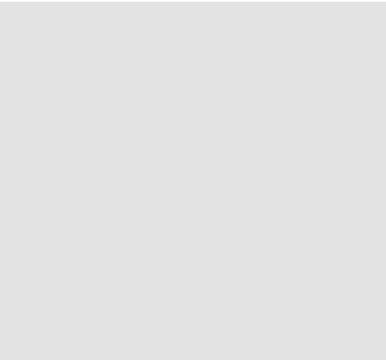
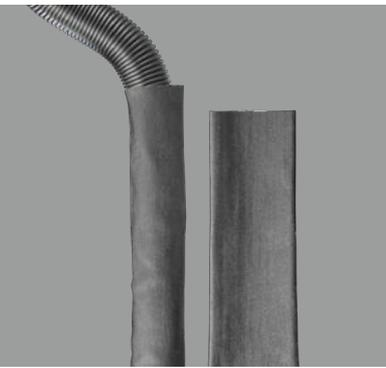

Sie interessieren sich für unsere Produkte?
 Klicken Sie hier zur **Direktanfrage**.
 You are interested in our products?
 Please click here for **direct inquiry**.

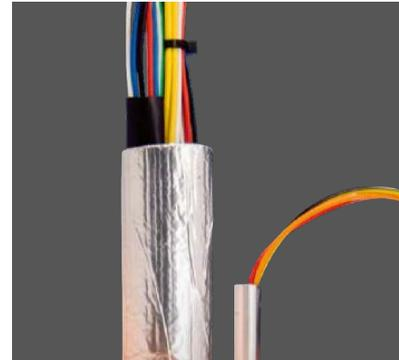

Empfohlene Anwendungsbereiche / Recommended areas of application

Produkt Product										
BPET-CC	✓	✓	✓			✓	✓	✓		✓
BPET-V0	✓	✓	✓	✓		✓	✓	✓		✓
BPA66-CC	✓	✓	✓			✓	✓	✓		✓
WPET-HS	✓		✓				✓	✓		✓
WPET-SC	✓	✓	✓			✓	✓	✓		✓
WPET-SCF	✓	✓	✓	✓		✓	✓	✓		✓
KPA-PC	✓	✓	✓			✓	✓	✓		✓
WGF-LA	✓		✓				✓	✓		✓
BCUTP	✓	✓	✓			✓	✓	✓		✓

Nummernschlüssel FIPJACK® Schutzschläuche

Part numbering key FIPJACK® protection sleeves

1 2 3 4 5 6
B **PET** **CC** - **23** **B** . **50**

1 Verarbeitung / Sleeves group

W = gewoben / woven
K = gestrickt / knitted
B = geflochten / braided

2 Materialart / Material type

GF = Glasfaser / Glass fiber
PET = Polyester
PA6 = Polyamide 6 / Polyamid 6
PA66 = Polyamide 6.6 / Polyamid 6.6
CUTP = Kupfer verzinkt / Copper tin plated

3 Qualität / Quality

LA = aluminiumkaschiert / laminated aluminium
SC = selbstverschließend / self closing
SCF = selbstverschließend UL 94 V0 / selfclosing UL 94 V0
CC = kalt schneidbar / cold cuttable
V0 = UL 94 V0

4 Nennweite / Nominal width (NW)

04 = kleinste NW / smallest NW
bis / to
XXX = größte NW / largest NW

5 Farbe / Colour

B = Standard-Schwarz / Standard black
G = Standard-Grau / Standard grey
S = Silber-Grau / Silver grey

6 Verpackungseinheit (VE) Packing units (PU)

50 = Rollenlänge oder Stück / Coil length or pieces

FRÄNKISCHE Industrial Pipes

Daten und Fakten (GJ 2017/2018)

Facts and figures (fy 2017/2018)

A world
full of solutions

4

Dampfverformungs-
anlagen
*Steam-molding
machines*

295

Montageplätze
Assembly stations

40

Spritzgussanlagen
Injection machines

22

Thermoöfen
Thermo ovens

18.909

Tonnen Kunststoff
Tonnes plastics





BPET-CC

PET-Geflechtschlauch
kaltschneidbar
*PET braided hose
cold cut version*

+150 °C +302 °F
-55 °C -67 °F

Material: Polyester



- sehr gute Schutzwirkung gegenüber Abrieb und gute chemische Beständigkeit
- Geflechtschlauch mit zusätzlicher Beschichtung, die Schneiden mit handelsüblichen Scheren (Kaltschnitt) ohne Ausfransen ermöglicht
- Bündelung und Schutz von Kabeln auch bei minimalen Platzverhältnissen
- *very good protection against chafing good resistance against chemical solvents*
- *braided hose that is specially coated for cold-cut capabilities, therefore it can be cut with normal scissors without intention for frizzling*
- *bundling and protection of cables and wires also at limited application space*

Download
BPET-CC

Das Datenblatt zu unserem Geflechtschlauch BPET-CC finden Sie hier.

The datasheet of our braided hose BPET-CC can be found here.



HALOGEN
FREE

Sie interessieren sich für unsere FIPJACK® Produkte? Klicken Sie hier zur **Direktanfrage**.
*You are interested in our FIPJACK® products? Please click here for **direct inquiry**.*



BPET-V0

PET-Geflechtschlauch
PET braided hose

+150 °C +302 °F
-55 °C -67 °F

Material: PET V0



- verfügt über ausgezeichnete Brandschutzigenschaften
- geeignet für Anwendungen bei denen Personenschutz an höchster Stelle steht und Anwendungen in Anlagen und Geräten von öffentlichen Gebäuden
- Bündelung und Schutz von Kabeln auch bei minimalen Platzverhältnissen
- *provides excellent self-extinguishing and fire performances*
- *suitable for protective applications of wires and cables in areas considering high personal safety requirements as well appliances and equipment's used in public buildings*
- *bundling and protection of cables and wires also at limited application space*

Download
BPET-V0

Das Datenblatt zu unserem Geflechtschlauch BPET-V0 finden Sie hier.

The datasheet of our braided hose BPET-V0 can be found here.



HALOGEN
FREE



BPA66-CC

Polyamid-Geflechtschlauch
kaltschneidbar

*Polyamide braided hose
cold cut version*

+125 °C +257 °F
-55 °C -67 °F

Material: Polyamid 6.6



- sehr gute Schutzwirkung gegenüber Abrieb und gute chemische Beständigkeit
- Geflechtschlauch mit zusätzlicher Beschichtung, die Schneiden mit handelsüblichen Scheren (Kaltschnitt) ohne Ausfransen ermöglicht
- Bündelung und Schutz von Kabeln auch bei minimalen Platzverhältnissen
- *very good protection against chafing good resistance against chemical solvents*
- *braided hose that is specially coated for cold-cut capabilities, therefore it can be cut with normal cissors without intention for frizzling*
- *bundling and protection of cables and wires also at limited application space*

Download
BPA66-CC

Das Datenblatt zu unserem Wellrohr BPA66-CC finden Sie hier.

The datasheet of our corrugated conduit BPA66-CC can be found here.



HALOGEN
FREE

Sie interessieren sich für unsere FIPJACK® Produkte? Klicken Sie hier zur **Direktanfrage**.
*You are interested in our FIPJACK® products? Please click here for **direct inquiry**.*



WPET-HS

Gewebeschlauch
heiß-schrumpfbar

*Woven hose
heat-shrinkable*

+150 °C +302 °F
-40 °C -40 °F

Material: PET



- deutlich erhöhte Abriebbeständigkeit durch PET Hochleistungs-Schutzfasern
- optimalen Schrumpfergebnissen, auch bei engen Radien
- extrem hohe Gewebestabilität bei gleichbleibend hoher Flexibilität auf den zu schützenden Bauteilen
- *made of extremely abrasion resistant PET warp fibers and shows an increased abrasion resistance*
- *optimal shrinking figures, also at small radii*
- *great textile stability and remaining flexibility on customers components*

Download
WPET-HS

Das Datenblatt zu unserem Gewebeschlauch WPET-HS finden Sie hier.

The datasheet of our woven hose WPET-HS can be found here.

HALOGEN
FREE

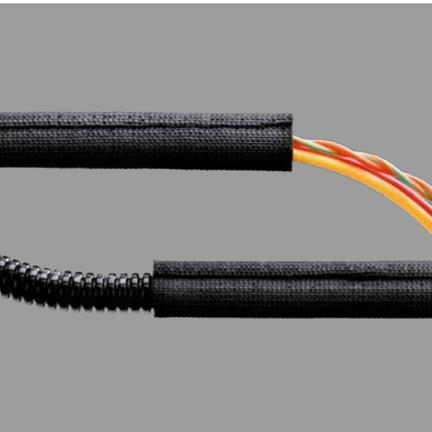

WPET-SC

Gewebeschlauch
selbstschließend

*Woven hose
selfclosing*

Material: PET



+150 °C +302 °F
-55 °C -67 °F

Download
WPET-SC

Das Datenblatt zu unserem Gewebeschlauch WPET-SC finden Sie hier.

The datasheet of our woven hose WPET-SC can be found here.

- hervorragende Schnitt- und Abriebfestigkeit
- selbsteinrollendes und überlappendes Gewebeband
- kann für kosteneffizienten und einfachen Bündelung von Kabeln und Leitern genutzt werden
- durch die seitliche Schlitzung selbst zur nachträglichen Kabelbündelung geeignet sowie zum individuellen Abgang von einzelnen Leitern
- *excellent cut and chafing resistance*
- *self-wrapping and overlapping fabric tape*
- *can be used for cost efficient easy bundling of cables and wires*
- *the wrapped sleeves can be reopened and allow cable and wire bundling with intermediate exits of individual conductors*



Sie interessieren sich für unsere FIPJACK® Produkte? Klicken Sie hier zur **Direktanfrage**.
*You are interested in our FIPJACK® products? Please click here for **direct inquiry**.*



WPET-SCF

Gewebeschlauch
selbstschließend, hochflammgeschützt

*Woven hose
selfclosing, high flame resistant*

Material: PET V0



+150 °C +302 °F
-55 °C -67 °F

Download
WPET-SCF

Das Datenblatt zu unserem Gewebeschlauch WPET-SCF finden Sie hier.

The datasheet of our woven hose WPET-SCF can be found here.

- verbesserte Brandeigenschaften, hervorragende Schnitt- und Abriebfestigkeit
- selbsteinrollendes und überlappendes Gewebeband
- kann für kosteneffizienten und einfachen Bündelung von Kabeln und Leitern genutzt werden
- durch die seitliche Schlitzung selbst zur nachträglichen Kabelbündelung geeignet sowie zum individuellen Abgang von einzelnen Leitern
- *improved fire characteristics, excellent cut and chafing resistance*
- *self-wrapping and overlapping fabric tape*
- *can be used for cost efficient easy bundling of cables and wires*
- *the wrapped sleeves can be reopened and allow cable and wire bundling with intermediate exits of individual conductors*



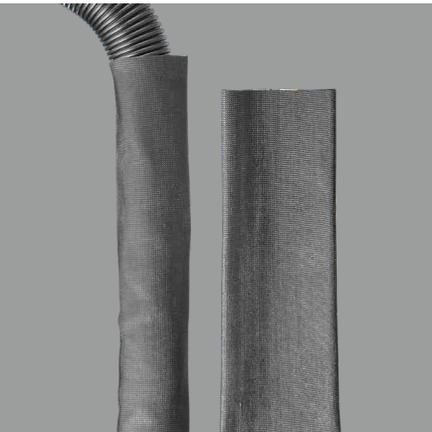

KPA-PC

Strickschlauch
extrem abriebfest

*Knitted hose
high abrasion resistant*

+160 °C +320 °F
-40 °C -40 °F

Material: PA6/PET + PU-Lackierung / PA6/PET + PU lacquering



- sehr hoher Abriebschutz, der die maximalen Anforderungen der LV-312-3 um das 50-fache übertrifft (2 Millionen Zyklen nach LV)
- temperaturbeständig bis 160 °C
- durch hohe Flexibilität in engen Bauräumen einsetzbar
- *very high abrasion resistance exceeding 50 times the maximum requirements of LV-312-3 (2 million cycles according to LV)*
- *temperature-resistant up to 160 °C*
- *because of a high flexibility usable in confined spaces*

Download
KPA-PC

Das Datenblatt zu unserem Strickschlauch KPA-PC finden Sie hier.

The datasheet of our knitted hose KPA-PC can be found here.



Sie interessieren sich für unsere FIPJACK® Produkte? Klicken Sie hier zur **Direktanfrage**.
*You are interested in our FIPJACK® products? Please click here for **direct inquiry**.*

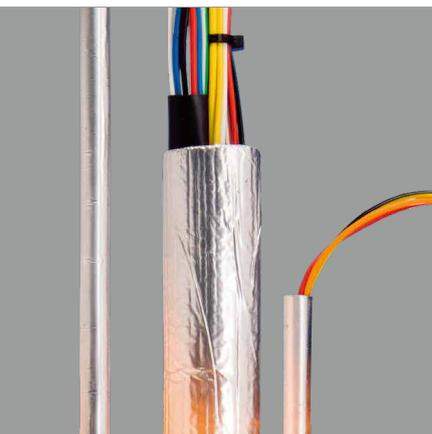

WGF-LA

Glasfasergewebeschlauch
Woven glass fiber hose

+220 °C +428 °F
-40 °C -40 °F

Material: Glasfaser mit Aluminium-Kaschierung / Glass fiber with aluminium coating



- hochtemperaturbeständig (Temperaturen bis zu 220° im Dauereinsatz) sowie hohe chemische Beständigkeit
- reflektiert Strahlungswärme bis 650°C und isoliert den innen liegenden Schlauch kurzzeitig
- Schneiden ohne Spezialwerkzeug möglich
- durch flexible Form und geringes Gewicht in unterschiedlichsten Bereichen einsetzbar
- *high-temperature resistant (withstands 220°C continuous) and high chemical resistance*
- *reflects radiant heat up to 650°C and insulates the hose inside for a limited time*
- *cuttable without special tools*
- *due to its flexible form and low weight it is usable for different areas*

Download
WGF-LA

Das Datenblatt zu unserem Glasfasergewebeschlauch WGF-LA finden Sie hier.

The datasheet of our woven glass fiber hose WGF-LA can be found here.





BCUTP

EMV-Abschirmgeflecht
EMV screening braid

+450 °C +842 °F
-75 °C -103 °F

Material: verzinnete Kupferlitzen / Tin-plated copper



- eignet sich besonders zur Abschirmung von Kabeln und Leitern hinsichtlich elektromagnetischer Verträglichkeit (EMV)
- bietet mit einer Überdeckung von 90 – 95% sehr gute Schirmwerte für industrielle Anlagen und Geräte
- Schirmwirkung bis zu 75 dB at 100MHz
- offers effective screening protection of cables and wires regarding electromagnetic compatibility (EMC)
- offers a coverage of 90 – 95% and is especially suited for very good screening effectiveness for industrial equipment and plant engineering
- screening effectiveness up to 75 dB at 100MHz

Download
BCUTP

Das Datenblatt zu unserem Abschirmgeflecht BCUTP finden Sie hier.

The datasheet of our screening braid BCUTP can be found here.



Sie interessieren sich für unsere FIPJACK® Produkte? Klicken Sie hier zur **Direktanfrage**.
*You are interested in our FIPJACK® products? Please click here for **direct inquiry**.*

FRÄNKISCHE Industrial Pipes

Daten und Fakten (GJ 2017/2018)

Facts and figures (fy 2017/2018)

A world
full of solutions

11

Standorte weltweit
Locations worldwide

335 Mio.

Meter Rohr pro Jahr
*Meters corrugated
tubing per year*

2.972

Mitarbeiter
Employees

164

Extrusionsanlagen
Extrusion lines

5

Blasform-
maschinen
*Blow-molding
machines*

74

Schutzschlauch-
anlagen
*Protection sleeve
lines*



Metallschläuche

Metal conduits



Produktübersicht / *Product overview*

Produkt <i>Product</i>	Material <i>Material</i>	Zubehör <i>Accessories</i>	Seite <i>Page</i>
GAAR	Stahl verzinkt <i>Galvanized steel</i>	✓	150
DMTN	Stahl verzinkt, mit verzinktem Stahldraht überflochten <i>Galvanized steel, overbraided with galvanized steel wires</i>	✓	150
DMA-PVC	Stahl verzinkt, PVC überzogen <i>Galvanized steel, PVC coated</i>	✓	151
DMC-PVC	Stahl verzinkt, PVC ummantelt <i>Galvanized steel, PVC fully coated</i>	✓	151
DMA-PU	Stahl verzinkt, TPU überzogen <i>Galvanized steel, TPU coated</i>	✓	152
DMC-PU	Stahl verzinkt, TPU ummantelt <i>Galvanized steel, TPU fully coated</i>	✓	152



Sie interessieren sich für unsere Produkte?
 Klicken Sie hier zur **Direktanfrage**.
 You are interested in our products?
 Please click here for **direct inquiry**.

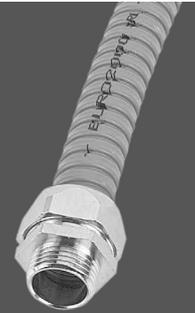

Empfohlene Anwendungsbereiche / *Recommended areas of application*

Produkt Product										
GAAR	✓	✓	✓	✓			✓			✓
DMTN	✓	✓	✓	✓			✓			✓
DMA-PVC	✓	✓					✓	✓		✓
DMC-PVC	✓	✓					✓	✓		✓
DMA-PU	✓	✓	✓	✓			✓			✓
DMC-PU	✓	✓	✓	✓			✓			✓

Nummernschlüssel FIPMETAL® Produkte

Part numbering key FIPMETAL® conduits



1 Bauausführung / Construction

- MC** = FIPMETAL® Rohre
FIPMETAL® conduits
- MJ** = FIPMETAL® Jolly-Verschraubung
FIPMETAL® fitting Jolly
- ME** = FIPMETAL® Standard Verschraubung
FIPMETAL® standard fitting
- ME-TR** = FIPMETAL® Verschraubung Winkelstück
FIPMETAL® fitting elbow

2 Metallrohrtyp / Typ of metal conduits (MC)

- DMA** = Metallschlauch Stahl verzinkt, normale Beschichtung
Galvanized steel conduit, standard coating
- DMC** = Metallschlauch Stahl verzinkt, verstärkte Beschichtung
Galvanized steel conduit, reinforced coating
- DMTN** = Metallschlauch Stahl verzinkt, überflochten
Galvanized steel conduit, overbraided
- DMT** = Metallschlauch Stahl verzinkt, normale Beschichtung, überflochten
Galvanized steel conduit, standard coating, overbraided
- GAAR** = Metallschlauch Stahl verzinkt
Galvanized steel conduit

3 Nennweite / Nominal width (NW)

- z. B. / e.g. **210** = NW10
- 212** = NW12
- 216** = NW16
- ...

4 Beschichtung für Metallrohre Coating for conduits (MC)

- PU** = Polyurethan-Beschichtung
Coating with Polyurethane
- PVC** = PVC-Beschichtung
Coating with PVC

5 Verschraubung Variante / Fitting version

- MJ** = FIPMETAL® Jolly-Verschraubung
FIPMETAL® fitting Jolly
- MS** = FIPMETAL® Standard Verschraubung
FIPMETAL® standard fitting
- ME-TR** = FIPMETAL® Verschraubung Winkelstück
FIPMETAL® fitting elbow

5 Verpackungseinheit (VE) Packing units (PU)

- 30** = Rollenlänge oder Stück
Coil length or pieces

FRÄNKISCHE Meilensteine / *milestones*

Produktlaunch FIPLOCK® ONE und Eintritt von Julius Kirchner

Product launch FIPLOCK® ONE and joining of Julius Kirchner



Eintritt
von Julius Kirchner
*Joining
of Julius Kirchner*
(4. Generation)

2019

Produktlaunch / *Product launch*

FIPLOCK® ONE

2018





GAAR

Metallschlauch
Metal conduit

+250 °C +482 °F
-45 °C -49 °F

Material: Stahl verzinkt / Galvanized steel



- verzinkter Stahl mit spezieller Verklammerung
- hohe Flexibilität
- guter mechanischer Schutz
- geeignet für industrielle Anwendungen
- selbstverlöschend, halogen- und cadmiumfrei

- *galvanized steel conduit with special seam*
- *good flexibility*
- *good mechanical performance*
- *suitable for industrial applications*
- *self-extinguishing, free of halogens and cadmium*

Download
GAAR

Das Datenblatt zu unserem Metallschlauch GAAR finden Sie hier.

The datasheet of our metal conduit GAAR can be found here.



Sie interessieren sich für unsere FIPMETAL® Produkte? Klicken Sie hier zur **Direktanfrage**.
*You are interested in our FIPMETAL® products? Please click here for **direct inquiry**.*



DMTN

Metallschlauch, umflochten
Metal conduit, overbraided

+250 °C +482 °F
-45 °C -49 °F

Material: Stahl verzinkt, mit verzinktem Stahldraht überflochten
Galvanized steel, overbraided with galvanized steel wires



- Stahl verzinkt mit spezieller Verklammerung und mit verzinktem Stahldraht überflochten
- hohe Flexibilität
- guter mechanischer Schutz
- selbstverlöschend, halogen- und cadmiumfrei
- sehr gute UV- und Witterungseigenschaften

- *galvanized steel with special seam and overbraided with galvanized steel wires*
- *good flexibility*
- *good mechanical performance*
- *self-extinguishing, free of halogens and cadmium*
- *very good UV and weathering performance*

Download
DMTN

Das Datenblatt zu unserem Metallschlauch DMTN finden Sie hier.

The datasheet of our metal conduit DMTN can be found here.



DMA-PVC

Metallschlauch, überzogen
Metal conduit, coated

+70 °C +158 °F
-15 °C -5 °F

Material: Stahl verzinkt, PVC überzogen / Galvanized steel, PVC coated



- Stahl verzinkt mit spezieller Verklammerung
- mit schwer brennbarer PVC-Schicht überzogen
- hoher Schutz gegen industrielle Öle und Säuren
- sehr alterungsbeständig
- galvanized steel with special seam
- surrounded by a thin layer made of slow burning PVC
- protection against oils and acids used in industries
- high aging resistant

Download
DMA-PVC

Das Datenblatt zu unserem Metallschlauch DMA-PVC finden Sie hier.
The datasheet of our metal conduit DMA-PVC can be found here.



Sie interessieren sich für unsere FIPMETAL® Produkte? Klicken Sie hier zur **Direktanfrage**.
*You are interested in our FIPMETAL® products? Please click here for **direct inquiry**.*

DMC-PVC

Metallschlauch, ummantelt
Metal conduit, fully coated

+70 °C +158 °F
-15 °C +5 °F

Material: Stahl verzinkt, PVC ummantelt / Galvanized steel, PVC fully coated



- Stahl verzinkt mit spezieller Verklammerung
- mit schwer brennbarer PVC-Schicht überzogen
- hoher Schutz gegen industrielle Öle und Säuren
- sehr alterungsbeständig
- galvanized steel with special seam
- surrounded by a thin layer made of slow burning PVC
- protection against oils and acids used in industries
- high aging resistant

Download
DMC-PVC

Das Datenblatt zu unserem Metallschlauch DMC-PVC finden Sie hier.
The datasheet of our metal conduit DMC-PVC can be found here.





DMA-PU

Metallschlauch, überzogen
Metal conduit, coated

+120 °C +248 °F
-45 °C -49 °F

Material: Stahl verzinkt, TPU überzogen / Galvanized steel, TPU coated



- Stahl verzinkt mit spezieller Verklammerung
- mit dünner Polyurethan-Schicht überzogen
- ausgezeichnete Brandschutzeigenschaften
- hoher Schutz gegen mechanische Abnutzung und Verformung
- sehr alterungsbeständig
- *galvanized steel mit special seam*
- *surrounded by a thin layer made of polyurethane*
- *excellent fire safety characteristics*
- *protection against mechanical abrasion and deformation*
- *high aging resistant*

Download
DMA-PU

Das Datenblatt zu unserem Metallschlauch DMA-PU finden Sie hier.

The datasheet of our metal conduit DMA-PU can be found here.



Sie interessieren sich für unsere FIPMETAL® Produkte? Klicken Sie hier zur **Direktanfrage**.
*You are interested in our FIPMETAL® products? Please click here for **direct inquiry**.*



DMC-PU

Metallschlauch, ummantelt
Metal conduit, fully coated

+120 °C +248 °F
-45 °C -49 °F

Material: Stahl verzinkt, TPU ummantelt / Galvanized steel, TPU fully coated



- Stahl verzinkt mit spezieller Verklammerung
- mit verstärkter glatten Polyurethan-Schicht ummantelt
- hoher Schutz gegen mechanische Abnutzung und Verformung
- sehr alterungsbeständig
- *galvanized steel mit special seam*
- *surrounded by a smooth polyurethane jacket*
- *protection against mechanical abrasion and deformation*
- *high aging resistant*

Download
DMC-PU

Das Datenblatt zu unserem Metallschlauch DMC-PU finden Sie hier.

The datasheet of our metal conduit DMC-PU can be found here.



Vormerken / Save the date

2020

sps

smart production solutions

24. – 26.
November 2020,
Nürnberg



22. – 25.
September 2020,
Berlin



Zubehör

Accessories

zum FIPMETAL® Produktprogramm / *for FIPMETAL® product range*



Produktübersicht / *Product overview*

Produkt Product	Material Material	Seite Page
MJ-2-M	Messing vernickelt <i>Brass nickel plated</i>	158
MJ-2-PG	Messing vernickelt <i>Brass nickel plated</i>	158
MS-2-M	Messing vernickelt <i>Brass nickel plated</i>	159
ME-2-TR-M	Messing vernickelt, Wellrohr aus Edelstahl AISI 304 <i>Brass nickel plated, conduit stainless steel AISI 304</i>	159



Sie interessieren sich für unsere Produkte?
 Klicken Sie hier zur **Direktanfrage**.
 You are interested in our products?
 Please click here for **direct inquiry**.



Empfohlene Anwendungsbereiche / *Recommended areas of application*

Produkt Product										
MJ-2-M	✓	✓	✓	✓			✓			✓
MJ-2-PG	✓	✓	✓	✓			✓			✓
MS-2-M	✓	✓	✓	✓				✓		✓
ME-2-TR-M	✓	✓	✓	✓						✓

Übersicht Ringtypen für FIPMETAL®

Overview FIPMETAL® ring types



Ringtyp AB
Ring type AB



Ringtyp AG
Ring type AG



Ringtyp AX
Ring type AX



Ringtyp OT
Ring type OT

Artikel-Nr. EURO 2000 Part No. EURO 2000	DMC DMC-PU	GAAR	DMA DMA-PU	DMT DMT-PU	DMTN
210	AB	AX	AG	AB	OT
212	AB	AX	AG	AB	OT
216	AB	AX	AG	AB	OT
221	AB	AX	AG	AB	OT
227	AB	AX	AG	AB	OT
235	AB	AX	AG	AB	OT
240	AB	AX	AG	AB	OT
250	AB	AX	AG	AB	OT

FIP SYSTEMS®

We simplify your world





MJ-2-M

Jolly-Fitting gerade, metrisch
Jolly fitting straight, metric

+120 °C +248 °F
-45 °C -49 °F

Material: Messing vernickelt / Brass nickel plated



- FIPMETAL® Anschlussverschraubung „Jolly“ für FIPMETAL® Metallrohre
- gerade Verschraubung mit metrischem Gewinde
- mit individuell aufsteckbaren Gewindeadptern
- Klemmring aus PA6

- FIPMETAL® fitting “Jolly” for FIPMETAL® metal conduits
- straight fitting with metric thread
- with individually applicable thread adaptors
- compression Ring made of PA6

Download
MJ-2-M

Das Datenblatt zu unserer Anschlussverschraubung MJ-2-M finden Sie hier.
The datasheet of our fitting MJ-2-M can be found here.



N° 1231385



D.A.T. N° CA02.01256



File: ELE308410CS

Sie interessieren sich für unsere FIPMETAL® Zubehörteile? Klicken Sie hier zur **Direktanfrage**.
*You are interested in our FIPMETAL® accessories? Please click here for **direct inquiry**.*



MJ-2-PG

Jolly-Fitting gerade, PG
Jolly fitting straight, PG

+120 °C +248 °F
-45 °C -49 °F

Material: Messing vernickelt / Brass nickel plated



- FIPMETAL® Anschlussverschraubung „Jolly“ für FIPMETAL® Metallrohre
- gerade Verschraubung mit PG-Gewinde
- mit individuell aufsteckbaren Gewindeadptern
- Klemmring aus PA6

- FIPMETAL® fitting “Jolly” for FIPMETAL® metal conduits
- straight fitting with PG thread
- with individually applicable thread adaptors
- compression ring made of PA6

Download
MJ-2-PG

Das Datenblatt zu unserer Anschlussverschraubung MJ-2-PG finden Sie hier.
The datasheet of our fitting MJ-2-PG can be found here.



N° 1231385



D.A.T. N° CA02.01256



File: ELE308410CS



MS-2-M

Verschraubung gerade, metrisch
Fitting straight, metric

+120 °C +248 °F
-45 °C -49 °F

Material: Messing vernickelt / Brass nickel plated



Download
MS-2-M

Das Datenblatt zu unserer Anschlussverschraubung ME-2-M finden Sie hier.
The datasheet of our fitting ME-2-M can be found here.

- FIPMETAL® Anschlussverschraubung für FIPMETAL® Metallrohre
- gerade Verschraubungen mit metrischen Gewinden
- Klemmring aus PA6
- FIPMETAL® fitting for FIPMETAL® metal conduits
- straight fittings with metric threads
- compression Ring made of PA6



Sie interessieren sich für unsere FIPMETAL® Zubehörteile? Klicken Sie hier zur **Direktanfrage**.
*You are interested in our FIPMETAL® accessories? Please click here for **direct inquiry**.*



ME-2-TR-M

Verschraubung Bogenwinkel flexibel, metrisch
Flexible curved elbow fitting, metric

+120 °C +428 °F
-45 °C -49 °F

Material: Messing vernickelt, Wellrohr aus Edelstahl AISI 304
Brass nickel plated, conduit stainless steel AISI 304



Download
ME-2-TR-M

Das Datenblatt zu unserer Anschlussverschraubung ME-2-TR-M finden Sie hier.
The datasheet of our fitting ME-2-TR-M can be found here.

- FIPMETAL® Anschlussverschraubung für FIPMETAL® Metallrohre
- Winkel-Verschraubung einstellbar, mit metrischem Gewinde
- flexibler Winkelteil aus Edelstahl
- Klemmring aus PA6
- FIPMETAL® fitting for FIPMETAL® metal conduits
- elbow fittings individually adjustable, with metric threads
- flexible elbow made of stainless steel
- compression Ring made of PA6

Rooted in Königsberg – globally successful!

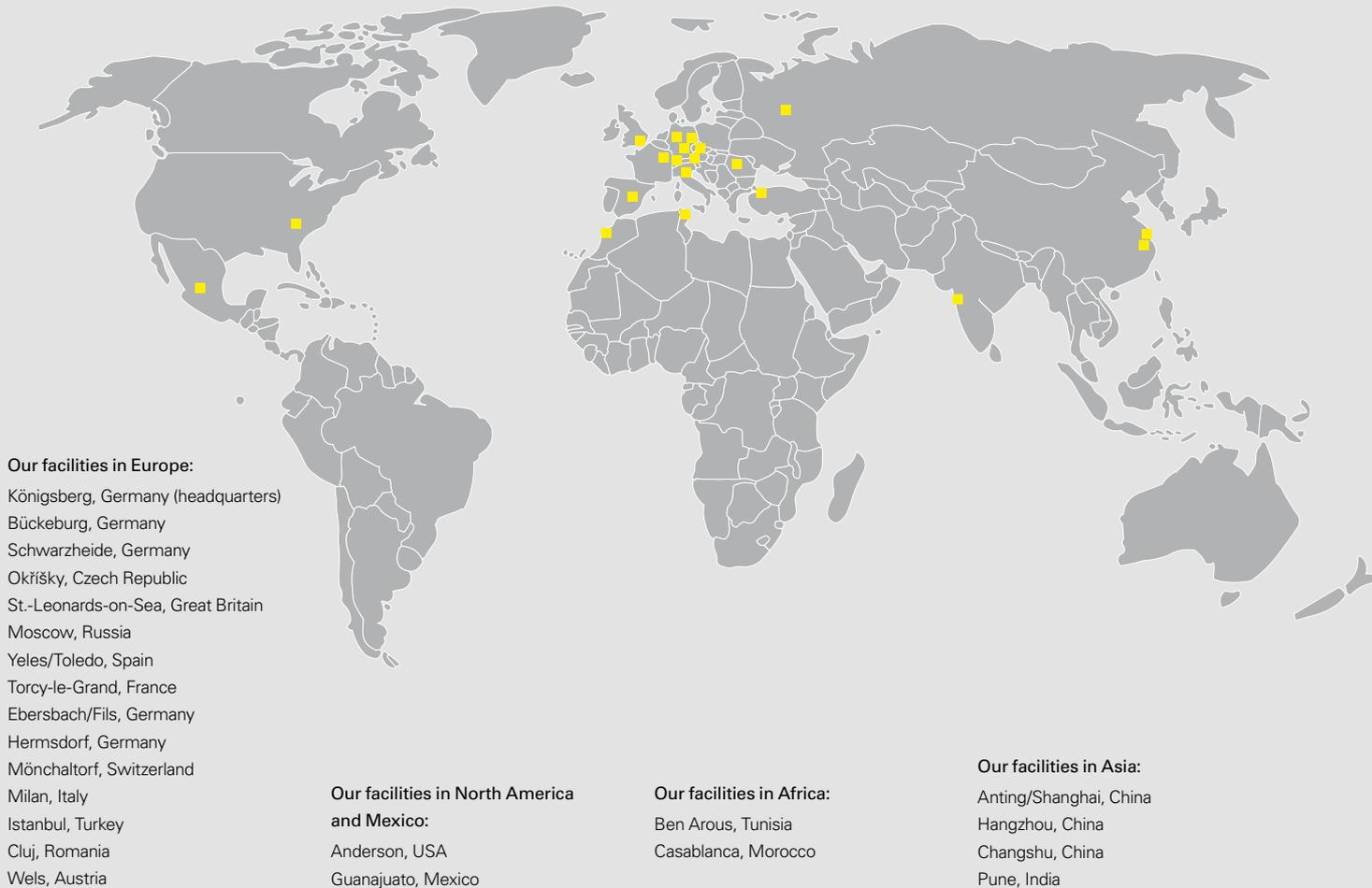

FRÄNKISCHE is an industry leader in the design, manufacturing and marketing of technically superior pipe systems, shafts and system components made of plastic and metal, and offers solutions for building construction, civil engineering, automotive and industrial applications.

Founded in 1906, the company is a third-generation family-owned business with around 4,200 employees working at production and sales facilities around the globe.