

Shinhoo[®]

GP AIII series

Energy-saving Pipeline Canned Motor Pump

Installation and Operation Manual



HEFEI XINHU CANNED MOTOR PUMP CO.,LTD.

Notes:

1. The installation manual should be read carefully before installation and use.
2. Any failure to comply with the content marked by safety warning marks may cause personal injury, pump damage and other property loss, for which, the manufacturer shall not assume any responsibility and compensation.
3. Installer, operator and user must comply with the local safety regulations.
4. The user must confirm that installation and maintenance of the product should be conducted by staff proficient in the instructions and having professional qualification certificates.
5. Pumps must not be installed in damp environment or places that may be splashed by water.
6. In order to facilitate maintenance, one stop valve should be installed on each side of the pump inlet and outlet respectively.
7. The power supply of pump should be cut off during installation and maintenance.
8. Pump with copper or stainless steel body should be adopted to the domestic hot water circulation.
9. The heat feed pipeline should not be supplemented with non-softened water frequently to avoid an increase in the calcium in the circulating water of pipeline so as not to clog impellers.
10. It is prohibited to start the pump when there is no pumping liquid.
11. Some models can not be used for diet water.
12. Pumping liquid may be of high temperature and pressure, therefore, liquid in the system should be drained off or stop valves on both sides of the pump must be switched off to avoid burns before moving and removing pump.
13. In the summer or when the ambient temperature is high, attention should be paid to ventilation so as to prevent moisture condensation and cause electrical fault.
14. In the winter, if the pump system does not operate or when the ambient temperature is below 0°C, liquid in the pipeline system should be emptied to avoid causing frost crack to the pump body.
15. If the pump does not use for a long time, please turn off the conduit valves on pump inlet and outlet ends and cut off the power of pump.
16. If the flexible cord is damaged, please connect service center to have it replaced together with the connector.
17. If it is found that the motor is burning hot and abnormal, immediately turn off the valve

on the pump inlet end and cut off the pump power, besides, immediately contact your local dealer or service center.

18. If the pump failure can not be cleared in accordance with the description in the instructions, immediately turn off the valve on the pump inlet end and cut off the pump power, besides, immediately contact your local dealer or service center
19. The product should be placed out of the reach of children, after installation, isolation measures should be taken to prevent children from touching.
20. The product should be placed in a dry, ventilated and cool place and stored at room temperature.
21. This appliance can be used by children aged from 8 years and above and persons with reduced physical, sensory or mental capabilities or lack of experience and knowledge if they have been given supervision or instruction concerning use of the appliance in a safe way and understand the hazards involved. Children shall not play with the appliance. Cleaning and user maintenance shall not be made by children without supervision.



Warning

Before starting installation, the Installation and Operating Instructions of device must be read carefully. Installation and use of the device must comply with local regulations and follow good operation specification.



Warning

Personnel with physical decline, dysesthesia or poor mental ability and lacking of experience and relevant knowledge (including children) should use the pump under the supervision and guidance of people who can take charge of their safety.

1. Symbol description



Warning

Failure to comply with this security declaration will likely result in personal injury!

Caution

Failure to comply with this security declaration will likely cause failure or damage to the equipment!

Note

Notes or instructions facilitating the work and ensuring operational safety.

2. Overview

2.1. GPA III series circulating pump (also called in abbreviation of "pump") is mainly used for the water circulation in home heating and domestic hot water system.

The pump is most suitable for the following

- Stable heating system with variable flow
- Heating system with variable pipeline temperature
- Industrial circulation system
- Home heating and domestic water supply system

The pump is equipped with a permanent magnet motor and differential pressure controller which can adjust the performance of electric pump automatically and continuously to meet the actual needs of the system.

The pump is equipped with control panel on the front, which is convenient for the operation of users.

2.2. Advantages of installation of the pump

Easy installation and start-up

- The pump has autoadaptation mode AUTO (factory settings). In most cases, you can start the pump without need to make any adjustments and automatically adjust it to meet the actual needs of the system.

High comfort

- The running noise of pump and the whole system is low.
- Low energy consumption
- Compared with the conventional circulating pump, its energy consumption is very low. The minimum energy consumption of the pump can reach 5W.



3. Service conditions

3.1. Ambient Temperature

Ambient temperature: 0 °C ~ +70 °C

3.2. Relative humidity (RH) :

Max. humidity: 95%

3.3. Media (conveying liquid) temperature

Temperature of liquid conveying +2 °C ~ 110 °C .

To prevent the control box and stator from appearing condensate water, the temperature of pump conveying liquid must be always higher than the ambient temperature.

3.4. System Pressure

The maximum is 1.0 MPa (10 bar).

3.5. Protection Level

IP 44

3.6. Inlet Pressure

To avoid damage to the pump bearing caused by cavitation noise, the following minimum pressure should be maintained in the pump inlet:

Liquid Temperature	< 75°C	90°C	110°C
Inlet Pressure	0.05bar	0.5bar	1.08bar
	0.5m head	5m head	10.8m head

3.7. Pumping Liquid

Thin, clean, non-corrosive and non-explosive liquid does not contain any solid particles, fibers or mineral oil; the pump should not be used for conveying flammable liquid such as vegetable oil and gasoline absolutely. If the circulating pump is used for the case of high viscosity, the pump performance will reduce, therefore, when selecting a pump, the viscosity of liquid must be considered.

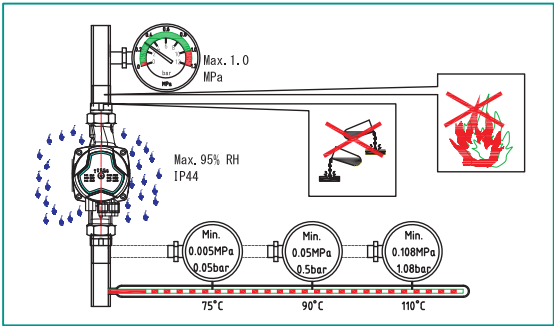

4. Installation

4.1 Installation

- Install the pump, arrows on the pump housing indicate the direction of liquid flowing through the pump body.
- When the pump is installed on the pipeline, its inlet and outlet must be installed with two leather packings provided.
- During installation, the pump shaft must be in the horizontal position.

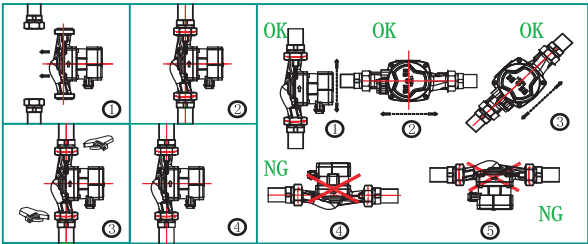

4.2 Position of Junction Box

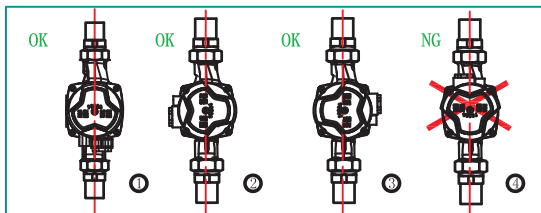

4.3 Position of junction box

The junction box can rotate in 90° . To change the position of junction box, follow the operating steps below:

1. Switch the valves of inlet and outlet and conduct decompression;
2. Loosen and remove the four socket head cap screws that fix the pump body;
3. Rotate the motor to the desired position and match the four screw holes;
4. Put the four socket head cap screws back and tighten them in the cross direction order;
5. Open the valve of inlet and outlet.

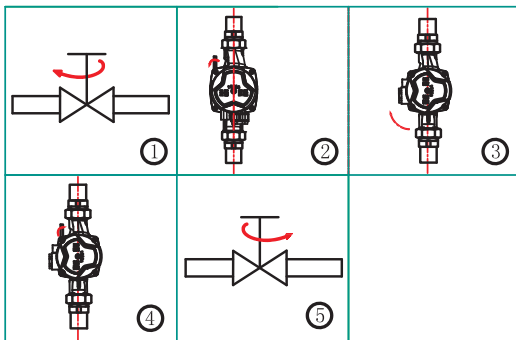

**Warning**

Pumping liquid may be of high temperature and pressure, therefore, liquid in the system should be drained off or valves on both sides of the pump must be switched off before removing socket head cap screws.

Caution

Change the position of junction box, the pump should not be started until the system has been filled with pumping liquid or valves on both sides of the pump are open.

4.4 Thermal insulation of the pump body

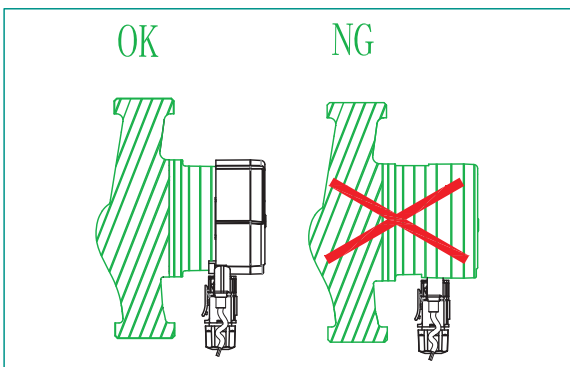
**Note**

Restrict the thermal losses of the pump body and pipeline. Conduct thermal insulation for the pump body and pipeline so as to reduce the thermal losses of pump and pipeline.

Caution

Isolating or covering junction box and control panel is not allowed.

5. Electrical Connection

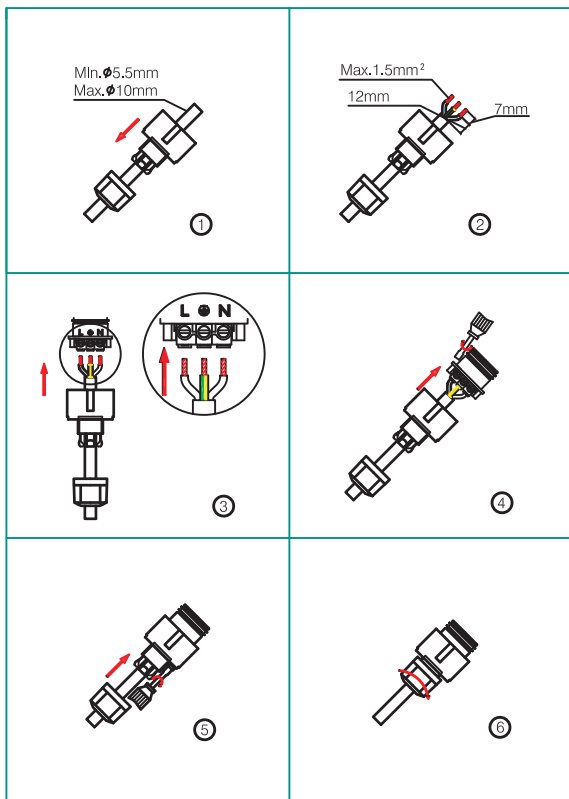

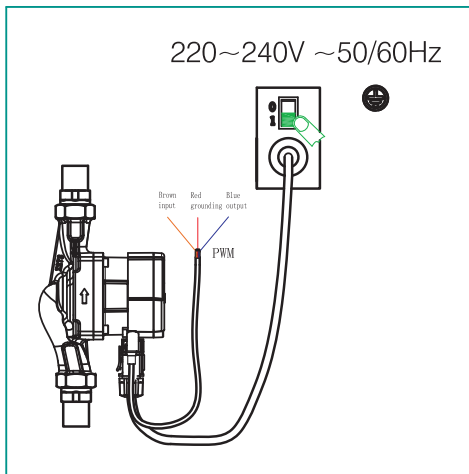

Electrical connection and protection should be carried out in accordance with local regulations.



Warning

The pump must be connected to earth wire 
 The pump must be connected with an external power switch;
 the minimum gap
 Between all the electrodes is 3mm.

- The pump does not need external motor protection.
- Check whether the voltage of power supply and frequency match with the parameters marked by pump nameplate.
- Use the pump associated plug to connect power supply.
- If the indicator lamp on the control panel lights, it indicates that the power supply is switched on.

6. Control Panel

6.1 Controls on Control Panel

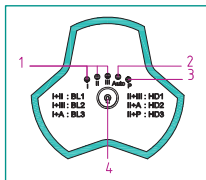

NO.	Explanation
1	The pump I,II,III gear display
2	The pump automatic gearshift display (AUTO)
3	The pump PWM gear display
4	The pump gear shifting button

Special Note:

- If I and II display at the same time, means BL1. If I and III display at the same time, means BL2. If I and Auto display at the same time, means BL3.
- If II and III display at the same time, means HD1. If II and Auto display at the same time, means HD2. If II and P display at the same time, means HD3.

6.2 Fault code display status

After the power is turned on, position 6 light area displays the status. During operation, the gear display light is on constantly. When the electric pump can not operate properly, the gear display light will flash continuously, the corresponding faults are as shown below:

Faultcode	Fault description
Gearlight1flickers	Over-voltage protection, restart after voltage returns to normal (low voltage protection value 270 +5V)
Gearlight2flickers	Under-voltage protection, restart after voltage returns to normal (low-voltage protection value 165 + 5V)
Gearlight3flickers	Over-current protection, restart after 5S
Gearlight4flickers	Under-load protection, restart after 5S
Gearlight5flickers	Over-Phase protection, restart after 5S
Gearlight1+2flickers	Locked-rotor protection, restart after 5S
Gearlight1+3flickers	Start failure (asymmetric motor parameters), restart after 5S
Gearlight1+4flickers	Over-heat protection, power reduced to half of the maximum power, ambient temperature restored to the range of use, power restored to the maximum.
Gearlight1+5flickers	Over-temperature protection, restart after environment temperature restores to 5S in use range

If the fault is displayed, the power supply must be disconnected to facilitate Trouble shooting. After trouble shooting, switch on the power supply again and re-start the electric pump.

6.3 Light area displaying the settings of the pump

The pump has 9 kinds of settings, which can be selected by buttons.

The setting of the pump is indicated by the light lit of 10 locations:

Key position	Number of times of key	Fixed light area	Explanation
4	0	AUTO	Auto adaptation
	1、2、3	BL1/BL2/BL3	Proportional pressure curve
	4、5、6	HD1/HD2/HD3	Constant pressure curve
	7、8、10	HS1/HS2/HS3	Constant speed curve

6.4 Button for selecting the pump settings

By pressing the button once at 2 seconds interval, the pump setting mode will change once.

A cycle is constituted of every nine presses on the button. For details, please refer to Section 6.3.

7. Setting of the pump

7.1 The pump should be set according to system type

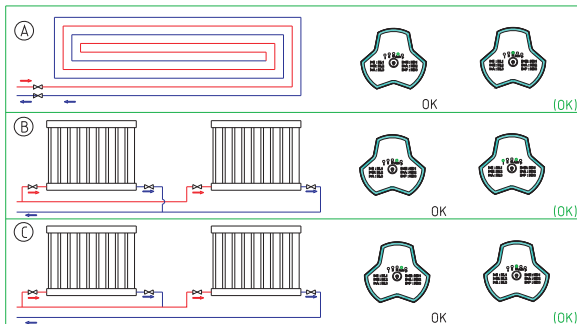

Factory settings= AUTO (auto adaptation mode)
Recommended and available settings of pump

Position	System Type	Settings of the pump	
		Optimal settings	Or other optional settings
A	Floor heating system	AUTO	HS3
B	Dual pipeline heating system	AUTO	BL3
C	Single pipeline heating system	AUTO	HS3

- AUTO (auto adaptation) mode shall adjust the pump performance automatically according to the actual heat demand of system. Since performance is adjusted gradually, it is recommended that leave it in the AUTO (auto adaptation) mode for at least a week before changing the settings of pump.

- If you choose to change back to AUTO (auto adaptation) mode, the pump can remember the set points of its previous AUTO mode and continue to adjust the performance automatically.

- Pump settings change from optimal settings to other optional settings, heating system is a slow system, it is impossible to achieve optimal operation mode within several minutes or hours. If the optimal settings of pump fail to achieve ideal heat distribution for each room, you should change the pump settings to other settings.

- For the relationship between pump settings and performance curve, please see Section

7.2 The control on the pump

During the operation of pump, control it according to "proportional pressure control" (BL) principle or "constant pressure control" (HD) principle.

In these two control modes, the performance of pump and corresponding power consumption should be adjusted according to the heat demand of system.

7.2.1 Proportional pressure control

In this control mode, the pressure difference on both ends of the pump shall be controlled by flow. Proportional pressure curve in Q / H diagram is represented by BL1/BL2 /BL3 (Section 11).

7.2.2 Constant pressure control

In this control mode, the pressure difference on both ends of the pump remains constant, having nothing to do with flow. In Q/H figure, constant pressure curve is a level performance curve, represented by HD1/HD2 (Section 11).

8.PWM Signal Control Mode

8.1 Control and Signal

1) Control Principle

The pump is controlled by modulated LV PWM (Pulse Width Modulation) digital signal, which means that the variance of velocity depends on the external input signal. The variance of velocity is one of the functions of input control.

2) Digital LV PWM (Pulse Width Modulation) Signal

Design frequency scope of square wave PWM signal: 40Hz~4000Hz;
 PWM input signal (PWM IN) is used to give velocity commands, and adjusts the velocity commands through adjusting PWM duty cycle.
 PWM output signal (PWM OUT) is the feedback signal of the pump, and the PWM frequency is fixed at 75Hz.

3) Duty Cycle (d%)

$$d\% = t/T$$

For example:

$$T = 2 \text{ ms (500Hz)}$$

$$t = 0.6 \text{ ms}$$

$$d\% = 100 \times 0.6/2 = 30\%$$

$$U_{IH} = 4 \sim 24V$$

$$U_{IL} \leq 1V$$

$$I_{IH} \leq 10mA$$

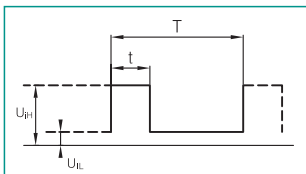

Code	Descriptions
T	Cycle
d	Duty Cycle
U_{IH}	Input High Voltage
U_{IL}	Input Low Voltage
I_{IH}	Input Current

8.2 Interface

The pump is controlled by external electrical elements and components through interfaces. The interfaces convert external signals into signals that can be recognized by microprocessor in the pump. In addition, when the pump is supplied with 230V voltage, the interfaces can ensure that users will not be at risk of high voltage electric shock when contacting the signal cable.

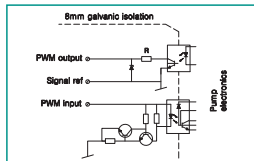

Note *Signal Ref* is a reference earthing, and it is not connected to protective earthing.

8.3 PWM Input Signal

- In area of high duty-cycle PWM signal, when the input signal fluctuates in the critical point, there will be a delay area to prevent frequent stop and start of the pump.
- In area of low duty-cycle PWM signal, the pump runs at high velocity for the sake of system safety. For instance, when the signal cable of gas boiler system is damaged, the pump will continue to run at the maximum rotational speed and transfer heat through main heat exchanger. This is also applicable to heat pump, ensuring continuous heat transfer in the case of signal cable of pump is damaged and system safety is guaranteed.
- When PWM input signal is 0% or 100%, the pump will switch to non-PWM mode (normal mode), and the default system will have no PWM signal input.

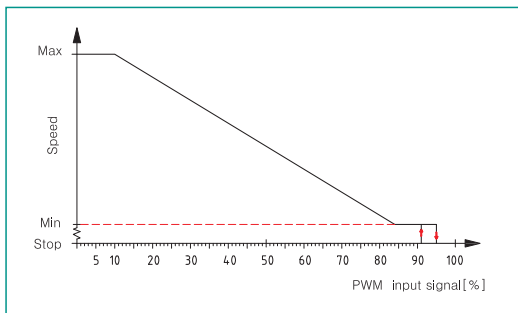

PWM Input Signal (%)	Pump Status
0	The pump switches to non-PWM mode (normal mode), and the default system will have no PWM signal input.
< 10	The pump runs at the highest velocity
10~84	The pump curve will drop from the highest to the lowest
85~91	The pump runs at the lowest velocity
91~95	If the velocity variance point of input signal fluctuates, then it will block the start and stop of the pump according to the principle of magnetic hysteresis
96~99	Stand-by, the pump stops
100	The pump switches to non-PWM mode (normal mode), and the default system will have no PWM signal input.

Note

This system is adaptive to the automatic switching of PWM and non-PWM mode. When there is PWM signal input, the system will enter PWM mode.

8.4 PWM Feedback Signal

PWM feedback signal can provide operation status of the pump, such as power loss or all kinds of alarm/warning modes.

PWM feedback signal will feed back exclusive alarming information. If the power voltage detects under voltage signal values, its output signal will be set to 75%. Provided sundries settlement exists in the hydraulic system and causes rotor being blocked, the duty cycle of output signal is set to 90%, the alarm will be given higher priority.

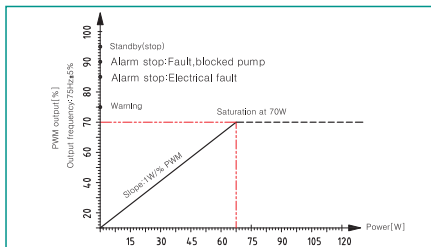

PWM Output Signal (%)	Pump Status	Descriptions
95	Standby (stop)	The pump stops
90	Alarm stops, malfunctions (pump blocked)	The pump does not work and will restarts only after trouble is addressed
85	Alarm stops, electrical malfunction/trouble	The pump does not work and will restarts only after trouble is addressed
75	Warning	The pump runs, trouble has been detected under this situation but it is not critical, and the pump can still work.
0-70	0-70W (slope 1 W/% PWM)	

8.5 How to use the signals

The signal can be used to measure power consumption of the pump. The pump signal can be used to detect the actual operating point of the system rather than measuring by the current controlled by the system. The signal is also applicable to comparing velocity setting value and feedback.

9.A bypass valve system is fitted between the inlet pipeline and return pipeline

9.1 Use of bypass valve

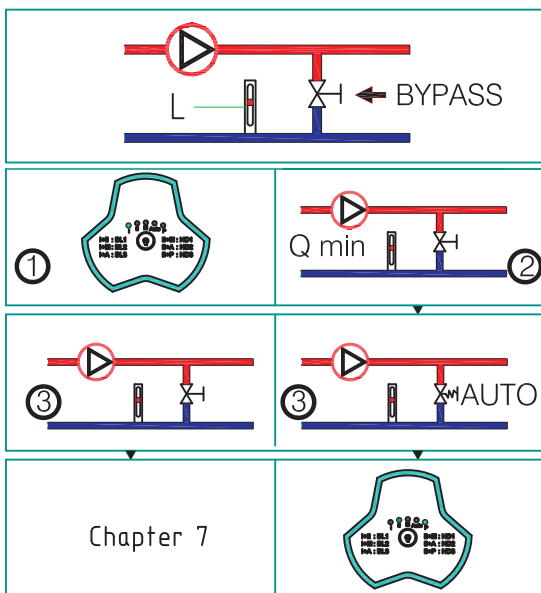

Bypass valve

The role of bypass valve is: when all the valves in the floor heating circuit or the temperature control valve of radiator are closed, it can be ensured that the heat from the boiler will be assigned.

Elements in the system:

- Bypass valve
- Flowmeter, position L.

The minimum flow must be ensured when all valves are closed.

The pump settings depend on the type of bypass valve it equipped with, i. e. manually-operated bypass valve or temperature-controlled bypass valve.

9.2 Manually-operated bypass valve

Follow the following steps:

1. When adjusting the bypass valve, the pump should be in setting HS1 (constant speed gear I mode).

The minimum flow of system (Q_{\min}) must always be ensured. See the manual of bypass valve manufacturer.

2. When the bypass valve has been adjusted, set the pump referring to Section 11 Pump Setting.

9.3 Automatic bypass valve (temperature control type)

Follow the following steps:

1. When adjusting the bypass valve, the pump should be in setting HS1 (constant speed gear I mode).

The minimum flow of system (Q_{\min}) must always be ensured. See the manual of bypass valve manufacturer.

2. When the bypass valve has been adjusted, set the pump to the constant pressure mode. For the relationship between pump settings and performance curve, please see Section 11. Settings and Performance of Pump.

10. Start up

10.1 Before Start Up

Before starting the pump, make sure that the system is filled with liquid, gas has been vented, and the pump inlet pressure must achieve the minimum inlet pressure as required (see Chapter 3).

10.2 Exhaust the Motor Pump

The pump has automatic gas-exhausting function. There is no need for gas-exhausting before startup. Gas in the pump may cause noise.

The noise will disappear after putting it into operation for a few minutes. Set the pump to be HS3 mode in a short time according to the size and structure of system, then gas in the pump will be vented quickly. After gas-exhausting of pump, that is, after the noise disappears, set the pump according to the recommended instructions. Please refer to Chapter 7

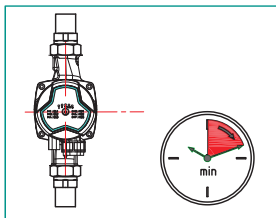

Caution The pump should not operate without water

10.3 Gas-exhausting of heating system

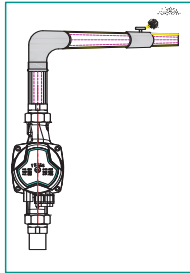

11. Settings and performance of pump

11.1 Relationship between pump settings and its performance

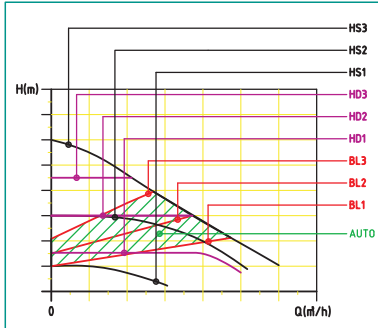

Setting	Pump Characteristics Curve	Functions
AUTO (factory settings)	Highest to Lowest Proportional Pressure Curve	"Autoadaptation" function will automatically control the pump performance within the specified range. <ul style="list-style-type: none"> Adjust the performance of the pump according to the size of system; Adjust the performance of the pump according to the load change of a period of time; In the "Autoadaptation" mode, the pump is set to proportional pressure control mode.
BL (1-3)	Proportional Pressure Curve	The pump working point will move up and down on the proportional pressure curve according to the flow needs of system, when the flow demand reduces, the pump pressure supply will drop while when the flow demand increases, it will rise.
HD (1-3)	Constant Pressure Curve	The pump working point will move back and forth on the constant pressure curve according to the flow needs of system. The pressure supply of pump remains constant, having nothing to do with the flow demand.
HS (1-3)	Constant speed curve	Run on the constant curve at a constant speed. In speed HS (1-3) mode, the pump is set to run on the maximum curve under all working conditions. Set the pump to HS3 mode in a short time, then gas in the pump will be vented quickly.

12. Performance Curve

12.1 Performance curve guide

Each setting of the pump will have a corresponding performance curve (Q/H curve). While AUTO autoadaptation mode covers a performance range. Input power curve (P1 curve) belongs to each Q/H curve. Power curve represents the power consumption (P1) of pump in watts on the given Q/H curve.

12.2 Curve conditions

The following description applies to the performance curves in GPA III series manual:

Testing liquid: gas-free water.

Applicable density of curve $\rho = 983.2$ kg/cubic meter, and the liquid temperature is $+60$ °C.

- All the values expressed by curves are averages, they can not be taken as the guaranteed curves. If a particular performance is required, measurement must be conducted separately.

Applicable kinematic viscosity of curve $\nu = 0.474$ mm² / s (0.474CcST)

12.3 Performance Curve

• GPAXX-4 III Performance curve

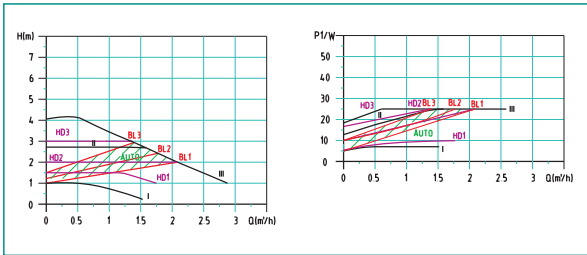

• GPAXX-5 III Performance curve

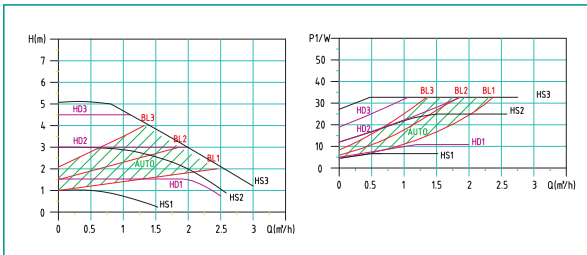

• GPAXX-6 III Performance curve

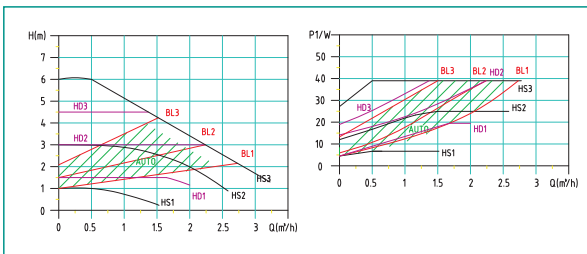

• GPAXX-7 III Performance curve

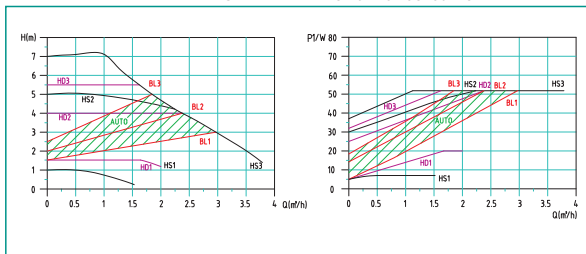

• GPAXX-7.5 III Performance curve

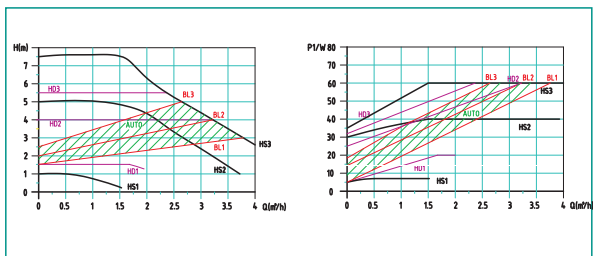

13.Characteristics

13.1 Description of nameplate

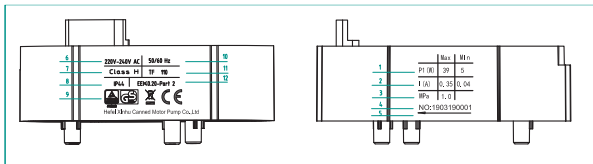

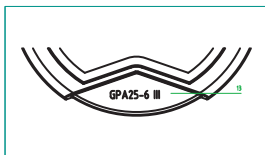

No.	Explanation	
1	Power	Maximum mode maximum power
		Minimum mode minimum power
2	Current	Maximum mode maximum current
		Minimum mode minimum current
3	Maximum pressure-bearing of system (Mpa)	
4	Product No.	
5	Motor steering	
6	Voltage (V)	
7	Insulation class	
8	Protection Lever	
9	Certification mark	
10	Frequency (Hz)	
11	Temperature grade	
12	Energy efficiency label	
13	Model	

13.2 Model explanation

Pump model is consisted of upper Latin letters and Arabic numerals etc. , whose meanings are as follows:

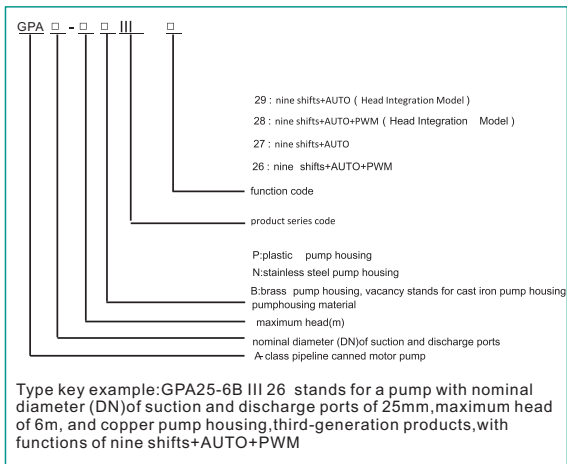

14. Technical Parameters and Installation Dimensions

14.1 Technical data

Supply Voltage	220~240V, 50/60Hz	
Motor Protection	Pump does not need external protection	
Protection Level	IP44	
Insulation Class	H	
Relative Humidity (RH)	Max95%	
System Load Bearing	1.0 MPa	
Suction Inlet Pressure	Liquid Temperature	Minimum Inlet Pressure
	≤+75℃	0.005 Mpa
	≤+90℃	0.05 Mpa
	≤+110℃	0.108 MPa
EMC Standard	EN61000-6-1 and EN61000-6-3	
Sound Pressure level	The sound pressure level of pump is lower than 42dB(A)	
Ambient Temperature	0~+70℃	
Temperature Grade	TF110	
Surface Temperature	Maximum surface temperature should not exceed +125℃	
Liquid Temperature	+2~+110℃	

To prevent the control box and stator from appearing condensate water, the temperature of pump conveying liquid must be always higher than the ambient temperature

Ambient Temperature(℃)	Liquid Temperature	
	Min.(℃)	Max.(℃)
0	2	110
10	10	110
20	20	110
30	30	110
35	35	90
40	40	70

In domestic hot water, it is recommended to keep the temperature of water below 65 ℃ so as to reduce scaling

14.2 Installation Dimensions

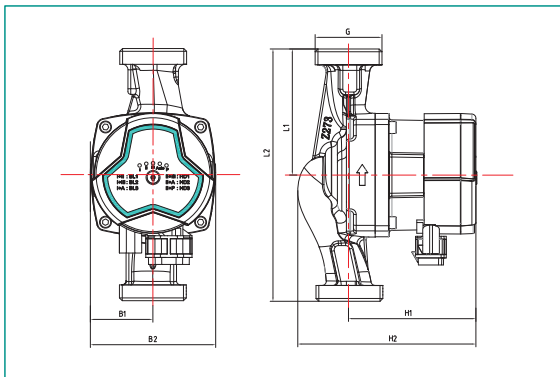

Power	Model	Max. Flow (m ³ /h)	Max Head (m)	Amps (A)	V/Hz	Material of pump body				Dimension(mm)						
(W)					220-240V 50/60Hz	Cast Iron	Plastic	Copper	Stainless Steel	L1	L2	B1	B2	H1	H2	G
25	GPA20-4 III	2.2	4	0.25		•	•	•	•	65	130	45	90	94	122	3"
	GPA25-4III	2.5				•	•	•	•	65	130	45	90	90	127	11/2"
	GPA32-4 III	2.8				•	•	•	•	90	180	45	90	90	127	2"
33	GPA20-5 III	2.3	5	0.3		•	•	•	•	65	130	45	90	94	122	1"
	GPA25-5III	2.8				•	•	•	•	65	130	45	90	90	127	11/2"
	GPA32-5 III	3.2				•	•	•	•	90	180	45	90	90	127	2"
39	GPA20-6 III	2.8	6	0.35		•	•	•	•	65	130	45	90	94	122	1"
	GPA25-6II	3.2				•	•	•	•	65	130	45	90	90	127	11/2"
	GPA32-6 III	3.6				•	•	•	•	90	180	45	90	90	127	2"
52	GPA20-7 III	2.8	7	0.45		•	•	•	•	65	130	45	90	94	122	1"
	GPA25-7 III	3.4				•	•	•	•	65	130	45	90	90	127	11/2"
	GPA32-7 III	3.8				•	•	•	•	90	180	45	90	90	127	2"
60	GPA20-7.5 III	2.8	7.5	0.5		•	•	•	•	65	130	45	90	94	122	1"
	GPA25-7.5III	3.4				•	•	•	•	65	130	45	90	90	127	11/2"
	GPA32-7.5III	3.8				•	•	•	•	90	180	45	90	90	127	2"

15. Fault checklist



Warning

Before carrying out any maintenance and repair to the electric pump, make sure the power is disconnected and will not be accidentally switched on.

Symptom	Control Panel	Cause	Corrective Action
Motor pump cannot be started	Indication lamp "Off"	Equipment fuse burned	Replace the fuse
		The circuit breaker of current control or voltage control opens	Connect the circuit breaker
		Failure of motor pump	Return to factory maintenance
	Gear light 1 flickers	High voltage	Inspect whether power supply is in specified range
	Gear light 2 flickers	Under voltage	Inspect whether power supply is in specified range
	Gear light 3 flickers	Over-current protection	Return to factory maintenance
	Gear light 4 flickers	No water in the pump	Open the valve and supply water to the pump
	Gear light 5 flickers	Over-Phase protection, the engine coils damaged or the engine is not connected properly.	Return to factory maintenance
	Gear light 1+2 flickers	Rotor stuck	Remove the pump house and take out the rotor cleaning
	Gear light 1+3 flickers	Motor resistance parameters do not match	Return to factory maintenance
Gear light 1+4 flickers	Over-heat protection	Reducing ambient temperature	
Gear light 1+5 flickers	Over-temperature protection	Reducing ambient temperature	
Noise in the system		Air exists in the system	Vent the system
		Excessively high flow rate	Lower inlet pressure of the motor pump
Noise in the motor pump		Air exists in the motor pump	Vent the system
		Excessively low inlet pressure	Raise inlet pressure
Insufficient heat		Poor performance of motor pump	Raise inlet pressure of motor pump



Meaning of crossed - out wheeled dustbin :

Do not dispose of electrical appliances as unsorted municipal waste, use separate collection facilities.

Contact your local government for information regarding the collection systems available.

If electrical appliances are disposed of in landfills or dumps, hazardous substances can leak into the groundwater and get into the food chain, damaging your health and well-being.

When replacing old appliances with new ones, the retailer is legally obligated to take back your old appliance for disposals at least free of charge.

Product warranty book of Hefei Xihu

Hefei Xihu Canned Motor Pump Co., Ltd offers 12 months of quality warranty for its products since the date of sales, and is responsible for product malfunctions or damaged due to manufacturing and material defects. This warranty is valid only when the product is installed strictly in accordance with Xihu installation and operation manual and certified operation practices.

This warranty is not applicable to product malfunctions or damage due to ① use in any other purpose other than that recommended by Xihu company; ② failure of compliance with Xihu installation and operation manual in the use of product; ③ inappropriate repair or moving of the product; ④ dismantling the product and/or replacing parts by themselves.

Any product supplied but not manufactured by Hefei Xihu Canned Motor Pump Co., Ltd shall comply with the quality warranty terms and conditions specified by its manufacturer.

During the warranty period, the user can have the product repaired with purchase invoice and warranty card. Please deliver or send the product to your vendor or designated repair center of Hefei Xihu Canned Motor Pump Co., Ltd for repair. Hefei Xihu Canned Motor Pump Co., Ltd can decide whether to offer free home repair according to the local repair policies. The repair of parts and components within warranty period is free of charges.

Hefei Xihu Canned Motor Pump Co., Ltd does not accept claims for damages due to third party liability or malfunctions caused by products of other companies.

Hefei Xihu Canned Motor Pump Co., Ltd will not be liable for product malfunctions or damage due to abnormal operation conditions, war, riot, wind (rain) storm, disaster or other force majeure.

Hefei Xihu Canned Motor Pump Co., Ltd reserves the right to interpret any matters unmentioned in this product warranty.