

User manual
NIBE™ F110
Hot water heat pump

UHB GB 1434-1
231975

Quick guide

Navigation

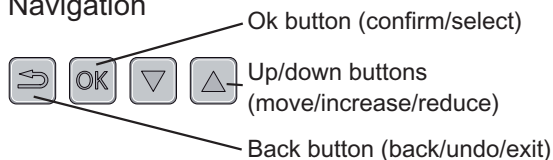

A detailed explanation of the button functions can be found on page 10.

How to scroll through menus and make different settings is described on page 14.

Increase hot water volume



To temporarily increase the amount of hot water, first press the down button to mark menu 2 (water droplet) and then press the OK button twice. Read more about the settings on page 21.

In event of disturbances in comfort

If a disturbance in comfort of any type occurs there are some measures that can be taken before you need to contact your installer. See page 34 for instructions.

Table of Contents

| | | |
|----------|---|-----------|
| 1 | <i>Important information</i> | 2 |
| | Installation data | 2 |
| | Safety information | 3 |
| | Serial number | 4 |
| | Contact information | 5 |
| | F110 – An excellent choice | 7 |
| 2 | <i>The heating installation – the heart of the house</i> | 8 |
| | Heat pump function | 9 |
| | Contact with F110 | 10 |
| | Maintenance of F110 | 17 |
| 3 | <i>F110 – at your service</i> | 20 |
| | Set the ventilation | 20 |
| | Set the hot water capacity | 21 |
| | Get information | 25 |
| | Adjust the heat pump | 28 |
| 4 | <i>Disturbances in comfort</i> | 32 |
| | Info-menu | 32 |
| | Manage alarm | 32 |
| | Troubleshooting | 34 |
| 5 | <i>Technical data</i> | 36 |
| 6 | <i>Glossary</i> | 37 |
| | <i>Index</i> | 39 |

1 Important information

Installation data

| | |
|-------------------|------|
| Product | F110 |
| Serial number | |
| Installation date | |
| Installer | |

| No. | Name | De- fault set- tings | Set | <input type="checkbox"/> | Accessories |
|-------|---|-------------------------------|-----|--------------------------|-------------|
| 5.1.5 | Fan (fan speed, normal mode) Exhaust air fan installation | 70% | | | |

Serial number must always be given

Certification that the installation is carried out according to instructions in NIBE's installer manual and applicable regulations.

Date _____ Signed _____

Safety information

This appliance can be used by children aged from 8 years and above and persons with reduced physical, sensory or mental capabilities or lack of experience and knowledge if they have been given supervision or instruction concerning use of the appliance in a safe way and understand the hazards involved. Children shall not play with the appliance. Cleaning and user maintenance shall not be made by children without supervision.

Rights to make any design or technical modifications are reserved.

©NIBE 2014.



NOTE

If the supply cable is damaged, only NIBE, its service representative or similar authorised person may replace it to prevent any danger and damage.

Symbols



NOTE

This symbol indicates danger to machine or person.



Caution

This symbol indicates important information about what you should observe when maintaining your installation.



TIP

This symbol indicates tips on how to facilitate using the product.

Marking

F110 is CE marked and fulfils IP21.

The CE marking means that NIBE ensures that the product meets all regulations that are placed on it based on relevant EU directives. The CE mark is obligatory for most products sold in the EU, regardless where they are made.

IP21 means that the product can be touched by hand, that objects with a diameter larger than or equivalent to 12.5 mm cannot penetrate and cause damage and that the product is protected against vertically falling drops.

Serial number

The serial number can be found at the bottom right of the front cover.

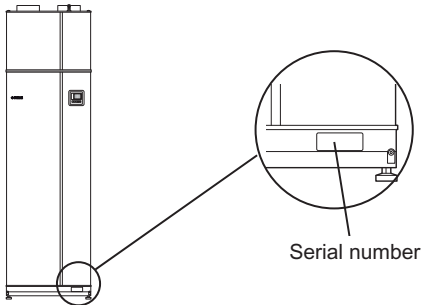

Caution

Always give the product's serial number (14 digits) when reporting a fault.

Contact information

- AT KNV Energietechnik GmbH**, Gahberggasse 11, 4861 Schörföling
Tel: +43 (0)7662 8963-0 Fax: +43 (0)7662 8963-44 E-mail: mail@knv.at
www.knv.at
- CH NIBE Wärmetechnik AG**, Winterthurerstrasse 710, CH-8247 Flurlingen
Tel: (52) 647 00 30 Fax: (52) 647 00 31 E-mail: info@nibe.ch
www.nibe.ch
- CZ Druzstevni zavody Drazice s.r.o.**, Drazice 69, CZ - 294 71 Benátky nad Jizerou
Tel: +420 326 373 801 Fax: +420 326 373 803 E-mail: nibe@nibe.cz
www.nibe.cz
- DE NIBE Systemtechnik GmbH**, Am Reiherpfahl 3, 29223 Celle
Tel: 05141/7546-0 Fax: 05141/7546-99 E-mail: info@nibe.de
www.nibe.de
- DK Vølund Varmeteknik A/S**, Member of the Nibe Group, Brogårdsvej 7, 6920 Videbæk
Tel: 97 17 20 33 Fax: 97 17 29 33 E-mail: info@volundvt.dk
www.volundvt.dk
- FI NIBE Energy Systems OY**, Juurakkotie 3, 01510 Vantaa
Puh: 09-274 697 0 Fax: 09-274 697 40 E-mail: info@nibe.fi www.nibe.fi
- FR NIBE Energy Systems France Sarl**, Zone industrielle RD 28, 01600 Reyrieux
Tel : 03 88 06 24 10 Fax : 03 88 06 24 11 E-mail: info@nibe.fr
www.nibe.fr
- GB NIBE Energy Systems Ltd**, 3C Broom Business Park, Bridge Way, Chesterfield S41 9QG
Tel: 0845 095 1200 Fax: 0845 095 1201 E-mail: info@nibe.co.uk
www.nibe.co.uk
- NL NIBE Energietechnik B.V.**, Postbus 634, NL 4900 AP Oosterhout
Tel: 0168 477722 Fax: 0168 476998 E-mail: info@nibenl.nl
www.nibenl.nl
- NO ABK AS**, Brobekkveien 80, 0582 Oslo, Postadresse: Postboks 64 Vollebakk, 0516 Oslo
Tel. sentralbord: +47 23 17 05 20 E-mail: post@abkklima.no www.nibeenergysystems.no

- PL NIBE-BIAWAR Sp. z o. o.** Aleja Jana Pawła II 57, 15-703 BIAŁYSTOK
Tel: 085 662 84 90 Fax: 085 662 84 14 E-mail: sekretariat@biawar.com.pl
www.biawar.com.pl
- RU © "EVAN"** 17, per. Boynovskiy, Nizhny Novgorod
Tel./fax +7 831 419 57 06 E-mail: info@evan.ru www.nibe-evan.ru
- SE NIBE AB Sweden**, Box 14, Hannabadsvägen 5, SE-285 21 Markaryd
Tel: +46-(0)433-73 000 Fax: +46-(0)433-73 190 E-mail: info@nibe.se
www.nibe.se

For countries not mention in this list, please contact Nibe Sweden or check www.nibe.eu for more information.

F110 – An excellent choice

F110 is part of a new generation of heat pumps, which have been introduced to supply your home with inexpensive and environmentally friendly hot water. Hot water production is safe and economical with integrated water heater, immersion heater and control system.

F110 is equipped with a control computer to give you good comfort, good economy and safe operation. Information about status, operating time and all temperatures in the heat pump are shown on the clear display.

Excellent properties for F110:

▪ ***EU directive***

Conventional incandescent bulbs were phased out of the market several years ago. This also now applies to electric water heaters.

Heat pump water heaters are one way of satisfying the new EU directive and F110 has been developed specifically to fulfil that directive.

F110 consumes approx. 1/3 of the power of an equivalent conventional electrical water heater. This gives great savings and therefore F110 pays for itself quickly.

▪ ***Integrated water heater***

There is a water heater integrated in the heat pump, which is insulated with environmentally friendly cellular plastic for minimal heat loss.

▪ ***Scheduling hot water and ventilation***

Hot water and ventilation can be scheduled for each day of the week or for longer periods (vacation).

▪ ***Display with user instructions***

The heat pump has a display with easy-to-understand menus that facilitate setting a comfortable hot water level.

▪ ***Simple troubleshooting***

In the event of a fault, the heat pump display shows what happened.

2 The heating installation – the heart of the house

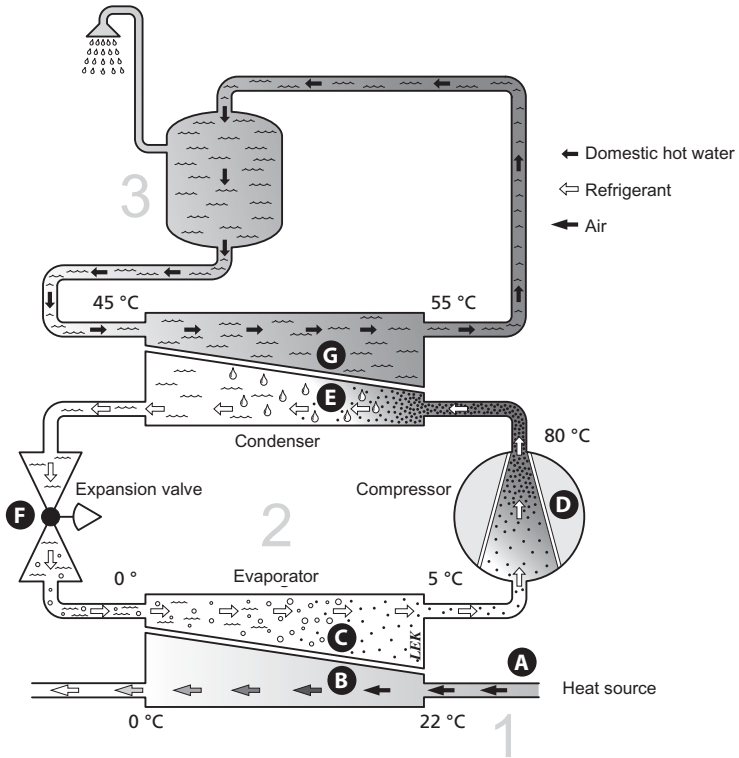

The temperatures are only examples and may vary between different installations and time of year.

Heat pump function

The heat pump uses the heat that is in the air to heat up the domestic hot water. The conversion of the air's energy to hot water occurs in three different circuits. From the outgoing exhaust air, surrounding air or indoor air, (1), free heat energy is retrieved and transported to the heat pump. In the refrigerant circuit, (2) the heat pump increases the retrieved heat's low temperature to a high temperature. In the heating medium circuit, (3) the heat is distributed to the water heater.

The air

- A** Air is transferred from outdoors or from the rooms via ducts to the heat pump.
- B** The fan then routes the air to the heat pump's evaporator. Here, the air releases the heating energy to the brine and the air's temperature drops significantly. The cold air is then blown out of the house or into a room in the house.

Refrigerant circuit

- C** A liquid, a refrigerant, circulates in a closed system in the heat pump which also passes the evaporator. The refrigerant has a very low boiling point. In the evaporator the refrigerant receives the heat energy from the air and starts to boil.
- D** The gas that is produced during boiling is routed into an electrically powered compressor. When the gas is compressed, the pressure increases and the gas's temperature increases considerably, from 5 °C to approx. 80 °C.
- E** From the compressor, gas is forced into a heat exchanger, condenser, where it releases heat energy to the domestic hot water, whereupon the gas is cooled and condenses to a liquid form again.
- F** As the pressure is still high, the refrigerant can pass an expansion valve, where the pressure drops so that the refrigerant returns to its original temperature. The refrigerant has now completed a full cycle. It is routed to the evaporator again and the process is repeated.

Domestic hot water

- G** The heat energy that the refrigerant produces in the condenser is retrieved by the domestic hot water which is heated to the set temperature.

The temperatures are only examples and may vary between different installations and time of year.

Contact with F110

Display unit

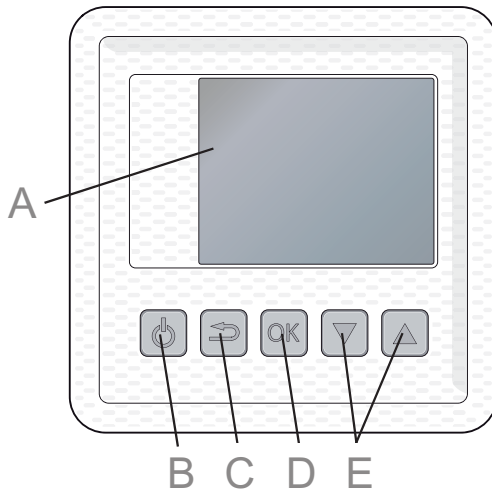

There is a display unit on F110, which is used to communicate with F110. Here you:

- set the hot water and ventilation, if any, as well as adjust the heat pump to your needs.
- receive information about settings, status and events.
- see different types of alarms.

A **Display**
Instructions, settings and operational information are shown on the display.

B **Stand-by button**
F110 can be switched to stand-by mode using the standby button. The compressor, immersion heater and fan are then switched off. Press the button for three seconds to activate/deactivate standby mode.

C **Back button**
The back button is used to:

- go back to the previous menu.
- change a setting that has not been confirmed.

D

OK button

The OK button is used to:

- confirm selections of sub menus/options/set values.

E

Up and down buttons

With the up and down buttons you can:

- scroll in menus and between options.
- increase and decrease the values.

Menu system

When F110 is started you come to the information menu. Basic information about the heat pump status is shown here.

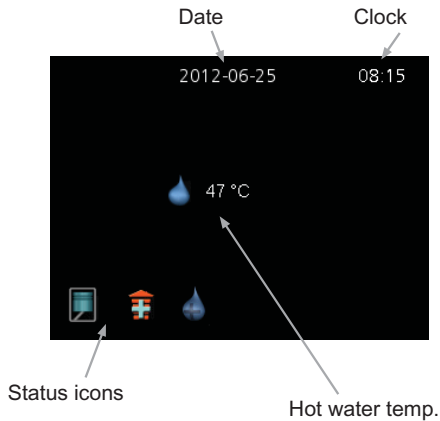

The information menu shows:

- on starting.
- when the back button in the main menu is pressed.
- after 15 minutes of inactivity.

Press any button to go to the main menu.

Main menu

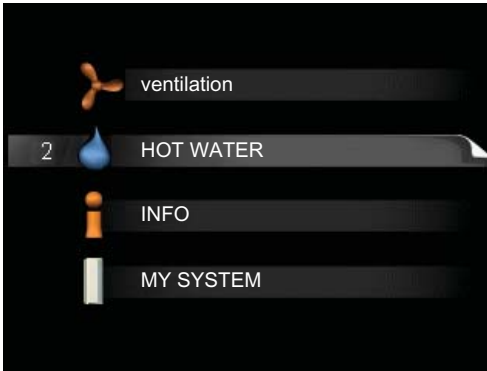

The menu system's main menus are shown here.

Menu 1

ventilation

Setting the ventilation. See page 20.

Menu 2

HOT WATER

Setting and scheduling hot water production. See page 21.

Menu 3

INFO

Display of temperatures and other operating information and access to the alarm log. See page 25.



Menu 4



MY SYSTEM

Setting time, date, language, operating mode etc. See page 28.
See page 28.

Symbols in the display

The following symbols can appear in the display during operation.

| Symbol | Description |
|---|---|
|  | This symbol is displayed when the compressor is operating. |
|  | This symbol is displayed when the additional heat is operating. |
|  | This symbol appears when the speed of the fan is changed from its normal setting. |

| Symbol | Description |
|---|---|
|  | <p>This symbol appears if lux mode for the hot water is activated.</p> |
|  | <p>This symbol appears when "scheduling" is activated in menu 2.3.</p> |
|  | <p>This symbol appears when "holiday setting" is activated in menu 4.7.</p> |

Operation

To move the cursor, press the up or down button. The marked position is brighter and/or has a turned up tab.

Selecting menu

To advance in the menu system select a sub-menu by marking it by using the up and down buttons and then pressing the OK button.

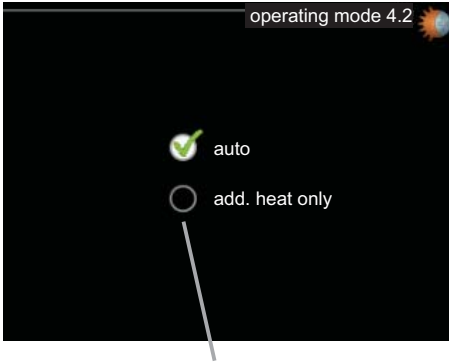

Selecting options



Selectable options

In an options menu the current selected option is indicated by a green tick. 

To select another option:



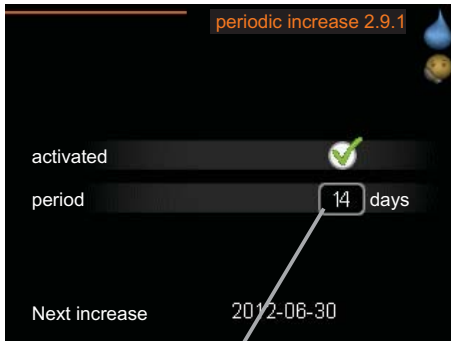

1. Mark the applicable option using the up or down button. One of the options is pre-selected (white). 
2. Press the OK button to confirm the selected option. The selected option has a green tick. 

Setting a value



Adjustable value

To set a value:

1. Mark the value you want to set using the up or down button. 
2. Press the OK button. The background of the value becomes green, which means that you have accessed the setting mode. 
3. Press the up button to increase the value or the down button to reduce the value. 
4. Press the OK button to confirm the value you have set. To undo and return to the original value, press the back button. 

Scroll through the windows

A menu can consist of several windows. Mark the page number, using the up and down keys, in the upper left corner and then press the OK button to switch between the windows.

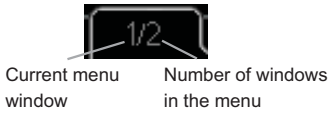

Scroll through the windows in the start guide



Arrows to scroll through windows in the start guide

1. Mark, using the up and down keys, one of the arrows in the top left corner (at the page number).
2. Press the OK button to scroll between the windows in the start guide.

Maintenance of F110

Regular checks

Your heat pump requires minimal maintenance after commissioning. On the other hand, it is recommended that you check your installation regularly.

If something unusual occurs, messages about the malfunction appear in the display in the form of different alarm texts. See alarm management on page 32.

Exhaust air installation

Cleaning the ventilation devices

The building's ventilation devices should be cleaned regularly with, for example, a small brush to maintain the correct ventilation.

The device settings must not be changed.

NOTE

If you take down more than one ventilation device for cleaning, do not mix them up.

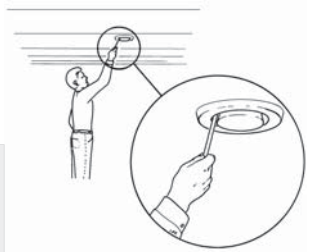

Cleaning the air filter

Clean the F110's air filter regularly, how often depends on the amount of dust in the ventilation air.

1. Switch off the fan in F110 by holding the standby button for 3 seconds. (Display turns off.)
2. Pull out the filter cassette.
3. Take out the filter and shake/vacuum off any dirt. Do not use water or other liquids for cleaning.
4. Check that the filter is not damaged.
5. Carry out assembly in reverse order.

Even if the filter appears clean, dirt collects in it and this affects the efficiency of the filter. Therefore, replace it after 2 years. New filters can be ordered via the installer.

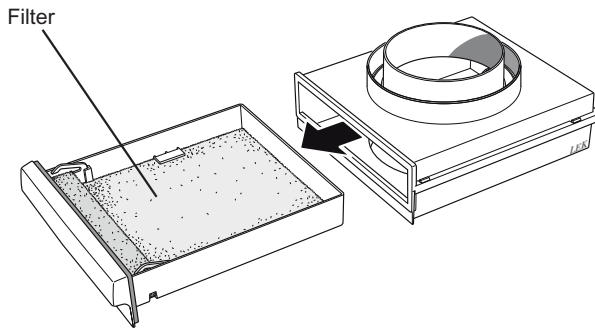

Safety valve

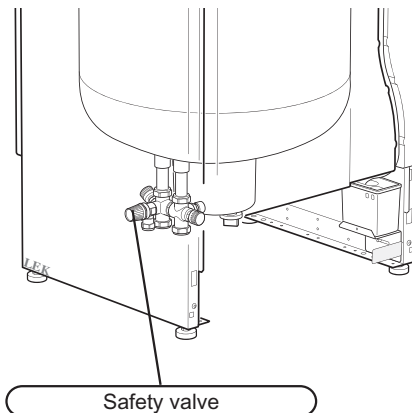

The safety valve must be checked about four times a year. The safety valve is reached by removing the main cover.

1. Open the valve by turning the knob anti-clockwise carefully.
2. Check that water flows through the overflow pipe. When water stops coming out of the overflow pipe the valve is defective and must be replaced.
3. Close the valve by releasing it. If it does not close automatically when released, turn it anti-clockwise slightly.

The safety valve sometimes releases a little water after hot water has been used. This discharge is caused by the expansion through heating of cold water entering the water heater, resulting in a pressure increase, whereby the safety valve opens.

Emptying

Drain the heat pump of water as follows:

1. Switch off the circuit fuse or pull out the plug.
2. Open the shut-off valve (turn anti-clockwise).
3. Open the safety/drain valve (turn the knob slowly anti-clockwise until it remains in the raised position).
4. Ensure air supply by opening all hot water taps.



Caution

The heat pump is started when the supply cable is connected to an earthed socket.

3 F110 – at your service

Set the ventilation

Menu 1

ventilation

This menu is only shown with exhaust air installation.

Setting range: normal and speed 1-4

Default value: normal

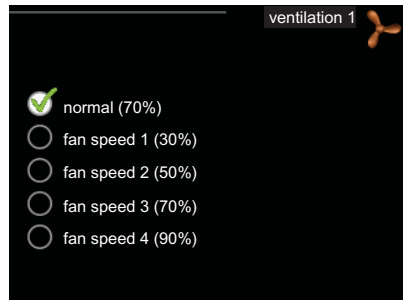

The ventilation in the accommodation can be temporarily increased or reduced here.

When a new speed has been selected a countdown is initiated. After 4 hours the ventilation speed returns to the normal setting.

The fan speed is shown in brackets (in percent) after each speed alternative.



TIP

If longer time changes are required use the holiday function.

Set the hot water capacity

Overview

Sub-menus

For the menu **HOT WATER** there are several sub-menus. Status information for the relevant menu can be found on the display to the right of the menus.

temporary lux Activation of temporary increase in the hot water temperature. Status information displays "off" or what length of time of the temporary temperature increase remains.

comfort mode Setting hot water comfort. The status information displays what mode is selected, "economy", "normal" or "luxury".

scheduling Scheduling hot water comfort. Status information "active" displays if the scheduling is active right now, the status information "set" displays if the scheduling is set but not active.

advanced Setting periodic increase in the hot water temperature.

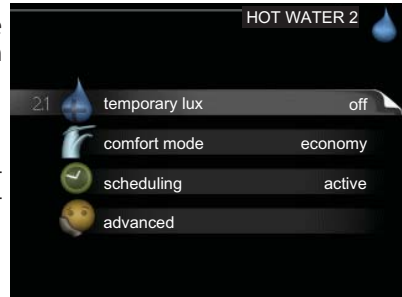

Menu
2.1

temporary lux

Setting range: 3, 6 and 12 hours and mode "off"

Default value: "off"



When hot water requirement has temporarily increased this menu can be used to select an increase in the hot water temperature to lux mode for a selectable time.



Caution

If comfort mode "luxury" is selected in menu 2.2 no further increase can be carried out.

The function is activated immediately when a time period is selected and confirmed using the OK button. The remaining time for the selected setting is shown to the right.

When the time has run out F110 returns to the mode set in menu 2.2.

Select "off" to switch off **temporary lux**.

Menu
2.2

comfort mode

Setting range: economy, normal,
luxury

Default value: normal

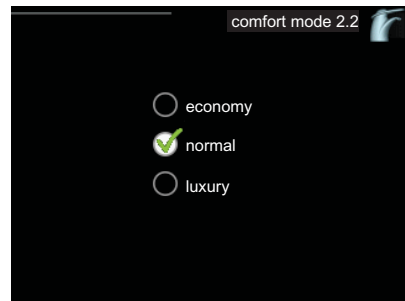

The difference between the selectable modes is the temperature of the hot tap water. Higher temperature means that the hot water lasts longer.

economy: This mode gives less hot water than the others, but is more economical.

normal: Normal mode gives a larger amount of hot water and is suitable for most households.

luxury: Lux mode gives the greatest possible amount of hot water. In this mode, the immersion heater, as well as the compressor, is used to heat hot water, which may increase operating costs.

Menu
2.3

scheduling

What hot water comfort the heat pump is to work with can be scheduled here.

Scheduling is activated/deactivated by ticking/unticking "activated". Set times are not affected at deactivation.



Activated: Scheduling for the selected period is activated here. Set times are not affected at deactivation.

Day: Select which day or days of the week the schedule is to apply to here. To remove the scheduling for a particular day, the time for that day must be reset by setting the start time to the same as the stop time. If the line "all" is used, all days in the period are set for these times.

Time period: The start and stop time for the selected day for scheduling are selected here.

Comfort mode: Set the hot water comfort that is to apply during scheduling here.



TIP

If you wish to set similar scheduling for every day of the week start by filling in "all" and then changing the desired days.



Caution

If the stop time is earlier in the day than the start time it means that the period extends past midnight.

Scheduling always starts on the date that the start time is set for.

If time periods overlap each other at midnight, the time period that starts after midnight is prioritised.

Menu
2.9

advanced

Menu **advanced** has orange text and is intended for the advanced user. This menu has a sub-menu.

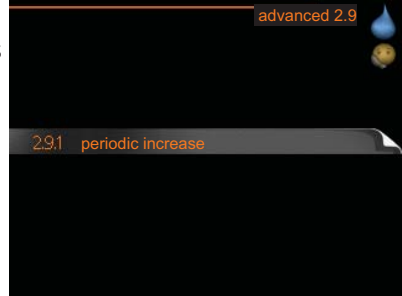

Menu
2.9.1

periodic increase

period

Setting range: 1 - 90 days

Factory setting: activated, 14 days

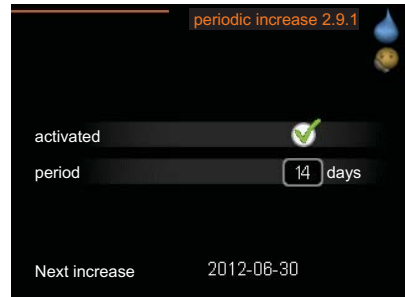

To prevent bacterial growth in the water heater, the compressor and the immersion heater can increase the hot water temperature for a short time at regular intervals.

The length of time between increases can be selected here. The time can be set between 1 and 90 days. Factory setting is 14 days. Untick "activated" to switch off the function.

Get information

Overview

Sub-menus

For the menu **INFO** there are several sub-menus. No settings can be made in these menus, they just display information.

service info shows temperature levels and software versions in the heat pump.

compressor info shows operating times, number of starts and status for the compressor.

add. heat info shows information about additional heat operating times and status.

alarm log shows the latest alarms.

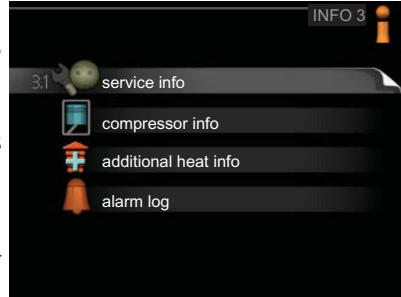

Menu
3.1

service info

Information about the heat pump's actual operating status (e.g. current temperatures etc.) can be obtained here. No changes can be made.

The information is on several pages. Push the up and down buttons to scroll between the pages.

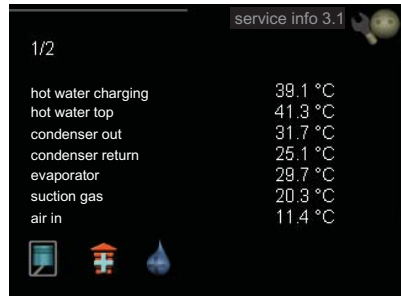

Symbols in this menu:



Compressor



Ventilation (only shown with exhaust air installation)



Scheduling



Addition



Lux mode for hot water



Holiday setting

Menu
3.2

compressor info

Information about the compressor's operating status and statistics can be obtained here. No changes can be made.

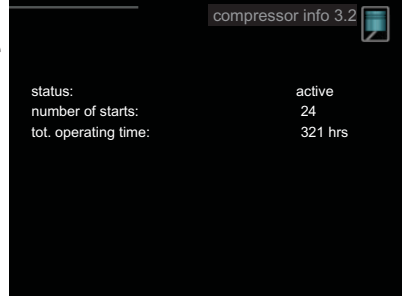

Menu
3.3

add. heat info

Information about the additional heat's operating status and statistics can be obtained here. No changes can be made.

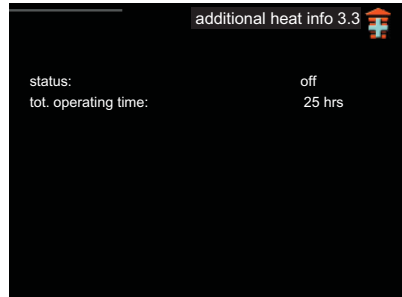

alarm log

To view the run status in the event of an alarm, mark the alarm and press the OK button.

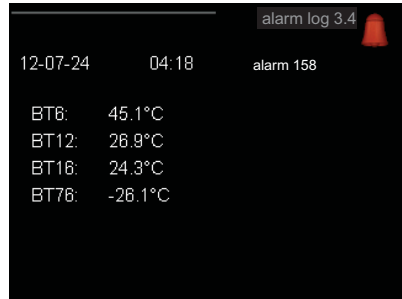
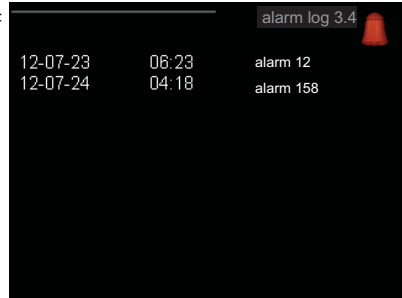

Information about an alarm.

Adjust the heat pump

Overview

Sub-menus

For the menu **MY SYSTEM** there are several sub-menus. Status information for the relevant menu can be found on the display to the right of the menu.

operating mode Activation of manual or automatic operating mode. The status information shows the selected operating mode.

time & date Setting current time and date. Status information displays the time.

language Select the language for the display here. The status information shows the selected language.

holiday setting Vacation scheduling hot water and ventilation. Status information "set" is displayed if you set a vacation schedule but it is not active at the moment, "active" is displayed if any part of the vacation schedule is active, otherwise it displays " off".

alarm Alarms can be reset here.

advanced Resetting all settings to factory default values.

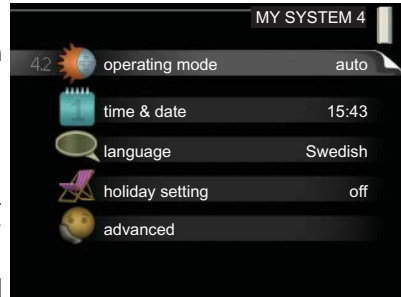

Menu
4.2

operating mode

operating mode

Setting range: auto, add. heat only

Default value: auto

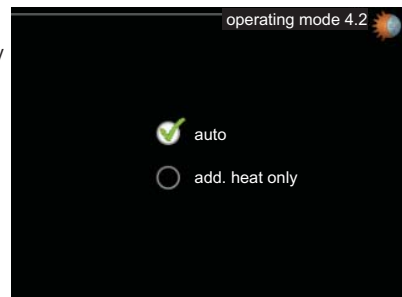

The heat pump operating mode is usually set to "auto". It is also possible to set the heat pump to "add. heat only", but only when additional heat is used.

Change the operating mode by marking the desired mode and pressing the OK button.

Operating mode auto

In this operating mode the heat pump automatically selects what functions are permitted.

Operating mode add. heat only

In this operating mode the compressor is not active and only additional heating is used.



Caution

If you choose mode "add. heat only" the compressor is deselected and there is a higher operating cost.

Menu
4.4

time & date

Set time and date and display mode here.

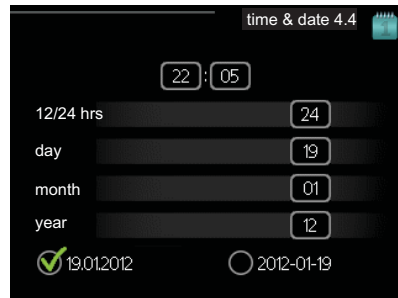

Menu
4.6

language

Choose the language that you want the information to be displayed in here.



Menu
4.7

holiday setting

To reduce energy consumption you can schedule a reduction in hot water temperature and any ventilation.

Vacation scheduling starts at 00:00 on the start date and stops at 23:59 on the stop date.



TIP

Complete holiday setting about a day before your return so that the hot water temperature has time to regain usual levels.



Caution

If you choose to switch off hot water production during the vacation "periodic increase" (preventing bacterial growth) are blocked during this time. "periodic increase" started in conjunction with the vacation setting being completed.

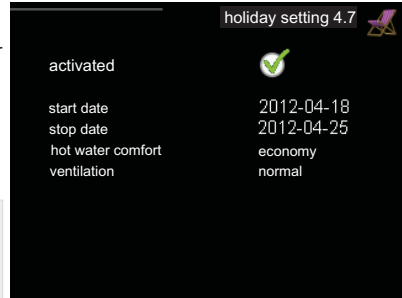

Menu
4.8

alarm

This menu is only available if an alarm has occurred.

Here you can reset any alarms that have occurred in F110.

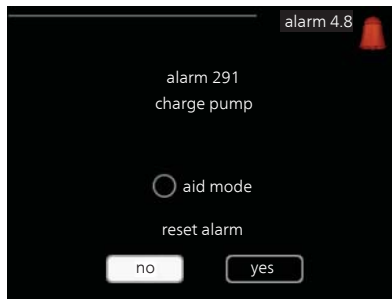

Menu
4.9

advanced

Menu **advanced** has orange text and is intended for the advanced user. This menu has a sub-menu.



Menu
4.9.4

factory setting

All settings that are available to the user (including advanced menus) can be reset to default values here.



Caution

After factory settings, user settings must be reset.

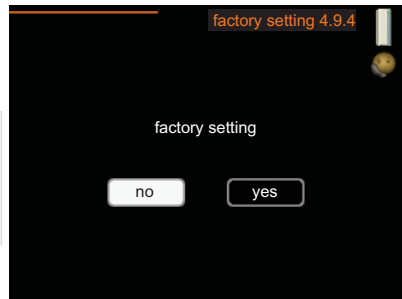

4 Disturbances in comfort

In most cases, the heat pump notes operational interference (operational interference can lead to disturbance in hot water comfort) and indicates this with an alarm in the display.

Info-menu

All these measurement values are stored under menu 3.1 in the heat pump menu system. Looking through the values in this menu can often simplify finding the fault source.

Manage alarm

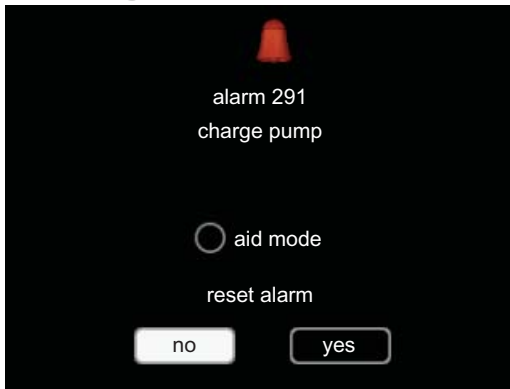

In the event of an alarm, a malfunction has occurred, which is indicated by an alarm symbol in the display.

Alarm

In the event of an alarm a malfunction has occurred that F110 cannot rectify itself. The display shows what type of alarm it is and lets you reset the alarm. You can also choose to set the heat pump to rescue mode

reset alarm In most cases it is enough to select "reset alarm" to correct the problem that caused the alarm. If the alarm recurs the problem that caused the alarm remains. If the alarm disappears and then returns, contact your installer.

aid mode "aid mode" is a type of emergency mode. This means that the heat pump produces hot water despite there being some kind of problem. This can mean that the heat pump's compressor is not running. In this case the immersion heater produces hot water.



Caution

Selecting "aid mode" is not the same as correcting the problem that caused the alarm. The alarm symbol will remain displayed.

If the alarm does not reset, contact your installer for suitable remedial action.



NOTE

Always give the heat pump's serial number when contacting your installer.

Alarm list

Sensor alarm for example BT6/BT13/BT77:

The sensor has lost contact with the accessory card or is broken. The alarm resets automatically after correct connection.

- Contact your installer!

Communication alarm display

The display has lost contact with the base card.

- Contact your installer!

Troubleshooting

If the operational interference is not shown in the display the following tips can be used.

Basic actions

Start by checking the following possible fault sources:

- That the display is lit or that the supply cable to F110 is connected.
- Group and main fuses of the accommodation.
- The property's earth circuit breaker.

Low hot water temperature or a lack of hot water

- Large hot water consumption.
 - Wait until the hot water has heated up. Temporarily increased hot water capacity (temporary lux) can be activated in menu 2.1.
- Too low hot water setting.
 - Enter menu 2.2 and select a higher comfort mode.
- Low or a lack of ventilation (exhaust air installation)
 - See section "Low or a lack of ventilation".
- Applies to incoming air blocked (outdoor air installation)
 - Clean the grille.
- Filter blocked (installation with ambient air)
 - Clean or replace filter (see page 18).
- Too low thermostat setting

Low or a lack of ventilation (exhaust air installation)

- The ventilation is not adjusted.
 - Order ventilation adjustment.
- Filter blocked.
 - Clean or replace filter (see page 18).
- Exhaust air device blocked or throttled down too much.
 - Check and clean the exhaust air devices.
- Fan speed in reduced mode.
 - Enter menu 1 and select "normal".

High or distracting ventilation (exhaust air installation)

- The ventilation is not adjusted.
 - Order ventilation adjustment.
- Fan speed in forced mode.
 - Enter menu 1 and select "normal".
- Filter blocked.

- Clean or replace filter (see page 18).

Gurgling sound

- Not enough water in the water seal.
 - Refill the water seal with water.
- Choked water seal.
 - Check and adjust the condensation water hose.

5 Technical data

Detailed technical specifications for this product can be found in the installation manual (www.nibe.eu).

6 Glossary

Additional heat:

Additional heat is the heat produced in addition to the heat supplied by the compressor in your heat pump. Additional heat can be an immersion heater for example.

Circulation pump

Pump that circulates liquid in a pipe system.

Compressor

Compresses the gas state refrigerant. When the refrigerant is compressed, the pressure and the temperature increase.

Condenser

Heat exchanger where the hot gas state refrigerant condenses (cools and becomes a liquid) and heats the hot water.

Disturbances in comfort

Disturbances in comfort means unwanted changes in hot water comfort, e.g. that the temperature of the hot water is too low.

A malfunction in the heat pump can sometimes be noticed in the form of a disturbance in comfort.

In most cases, the heat pump notes operational interference and indicates this with alarms and shows instructions in the display.

Evaporator

Heat exchanger where the refrigerant evaporates by retrieving heat energy from the air which then cools.

Expansion valve

Valve that reduces the pressure of the refrigerant, whereupon the temperature of the refrigerant drops.

Heat exchanger

Device that transfers heat energy from one medium to another without mixing mediums. Examples of different heat exchangers are evaporators and condensers.

Mixing valve

A valve that mixes the cold water with the hot water leaving the heater.

Refrigerant

Substance that circulates around a closed circuit in the heat pump and that, through pressure changes, evaporates and condenses. During evaporation, the refrigerant absorbs heating energy and during condensing, gives off heating energy.

Supply temperature

The temperature of the heated water that the heat pump sends out to the heating system. The colder the outdoor temperature, the higher the supply line temperature becomes.

7 Item register

A

Adjust the heat pump, 28

C

Contact information, 5

Contact with F110, 10

Menu system, 11

Room unit, 10

D

Disturbances in comfort

Manage alarm, 32

Troubleshooting, 34

F

F110 – An excellent choice, 7

F110 – at your service, 20

Adjust the heat pump, 28

Get information, 25

Set the hot water capacity, 21

Set the indoor climate, 20

G

Get information, 25

Glossary, 37

H

Heat pump function, 9

I

Important information, 2

Contact information, 5

F110 – An excellent choice, 7

Installation data, 2

Serial number, 4

Installation data, 2

M

Maintenance of F110, 17

Regular checks, 17

Manage alarm, 32

Menu system, 11

R

Regular checks, 17

Room unit, 10

S

Serial number, 4

Set the hot water capacity, 21

Set the indoor climate, 20

T

Technical data, 36

The heating installation – the heart of the house, 8

Troubleshooting, 34

NIBE AB Sweden
Hannabadsvägen 5
Box 14
SE-285 21 Markaryd
info@nibe.se
www.nibe.eu



231975