

LENNOX[®]

INSTALLATION OPERATING & MAINTENANCE MANUAL



PROVIDING **GLOBAL SYSTEM SOLUTIONS**

**ROOFTOP
FLEXY™**

**English
Sept 2001**

IOM MANUAL

Ref. IOM-RT F-0701-E

The present manual applies to the following ROOFTOP versions :

FCA 50 - FCA 60 - FCA 70 - FCA 85 - FCA 100 - FCA 120 - FCA 140 - FCA 160 - FCA 190
FCK 50 - FCK 60 - FCK 70 - FCK 85 - FCK 100 - FCK 120 - FCK 140 - FCK 160 - FCK 190
FHA 50 - FHA 60 - FHA 70 - FHA 85 - FHA 100 - FHA 120 - FHA 140 - FHA 160 - FHA 190
FHK 50 - FHK 60 - FHK 70 - FHK 85 - FHK 100 - FHK 120 - FHK 140 - FHK 160 - FHK 190
FDA 50 - FDA 60 - FDA 70 - FDA 85 - FDA 100 - FDA 120 - FDA 140 - FDA 160 - FDA 190
FDK 50 - FDK 60 - FDK 70 - FDK 85 - FDK 100 - FDK 120 - FDK 140 - FDK 160 - FDK 190
FGA 50 - FGA 60 - FGA 70 - FGA 85 - FGA 100 - FGA 120 - FGA 140 - FGA 160 - FGA 190
FGK 50 - FGK 60 - FGK 70 - FGK 85 - FGK 100 - FGK 120 - FGK 140 - FGK 160 - FGK 190

FXA 25 - FXA 30 - FXA 35 - FXA 40 - FXA 55 - FXA 70 - FXA 85 - FXA 100 - FXA 110 - FXA 140 - FXA 170
FXK 25 - FXK 30 - FXK 35 - FXK 40 - FXK 55 - FXK 70 - FXK 85 - FXK 100 - FXK 110 - FXK 140 - FXK 170

CONTENTS

INSTALLATION

TRANSPORT - HANDLING	3
INSTALLATION	10
INSTALLATION ON ROOF MOUNTING FRAME	11
INSTALLATION ON POSTS	13
COMMISSIONING	14

OPERATION

AIR FLOW BALANCING	15
AIRFLOW BALANCING - FXA/FXK	24
FILTERS	25
HOT WATER COILS	26
GAS BURNERS	27
BELT TENSIONING	34
PULLEYS	35

CONTROL FUNCTIONS

USING THE KP 17 COMFORT DISPLAY	36
USING THE KP02 MAINTENANCE DISPLAY	37
USING THE KP07 REMOTE GRAPHICAL DISPLAY	47
BMS CONTACTS KIT	56
CLIMATIC™ PARAMETERS	57

WIRING DIAGRAMS

ELECTRICAL WIRING DIAGRAMS	63
ELECTRICAL WIRING DIAGRAMS LIST OF ITEMS	74

TROUBLESHOOTING

SAFETY AND ERROR CODES	77
BEFORE CALLING FOR ASSISTANCE	82
PLANNED MAINTENANCE	84
WARRANTY	87

CERTIFICATES

AFAQ CERTIFICATION	88
CE CERTIFICATION OF CONFORMITY	89
FILTERS FIRE CLASS	90
33 KW GAS BURNER CE CERTIFICATION OF CONFORMITY	91
60 KW GAS BURNER CE CERTIFICATION OF CONFORMITY	92
120 KW GAS BURNER CE CERTIFICATION OF CONFORMITY	93
180 KW GAS BURNER CE CERTIFICATION OF CONFORMITY	94
INSULATION FIRE CLASS	95

DELIVERY CHECKS

The equipment is shipped at the customers risk, and whose responsibility it is to ensure that the products are in good working order on receipt by checking the following :

- The exterior has not been damaged in any way.
- The lifting and handling equipment are suitable for the equipment and comply with the specifications of the handling instructions enclosed herein.
- Accessories ordered for on site installation have been delivered and are in good working order.
- The equipment supplied corresponds with the order and matches the delivery note.

If the product is damaged, exact details must be confirmed in writing by registered post to the shipping company within 48 hours of delivery (working days). A copy of the letter must be addressed to Lennox and the supplier or distributor for information purposes. Failure to comply will invalidate any claim against the shipping company.

RATING PLATE

The rating plate provides a complete reference for the model and ensures that the unit corresponds to the model ordered. It states the electrical power consumption of the unit on start-up, its rated power and its supply voltage. The supply voltage must not deviate beyond +10/-15 %.

The start-up power is the maximum value likely to be achieved for the specified operational voltage. The customer must have a suitable electrical supply. It is therefore important to check whether the supply voltage stated on the unit's rating plate is compatible with that of the mains electrical supply.

The rating plate also states the year of manufacture as well as the type of refrigerant used with the required volume capacity of each compressor circuit.

STORAGE

When units are delivered on site they are not always required immediately and are sometimes put into storage. In the event of medium to long-term storage, we recommend the following procedures :

- Ensure that there is no water in the hydraulic systems.
- Keep the heat exchanger covers in position (AKILUX cover).
- Keep protective plastic film in position.
- Ensure the electrical panels are closed.
- Keep all items and options supplied in a dry and clean place for future assembly before using the equipment.

MAINTENANCE KEY

On delivery we recommend that you keep the key which is attached to an eyebolt in a safe and accesible place. This allows you to open the panels for maintenance and installation work.

The locks are ¼ turn + then tighter (figure 2).

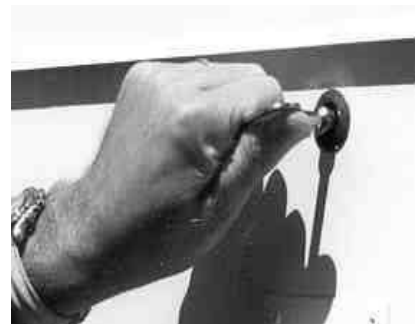

Figure 2

LENNOX		CE		Usine Dijon Z.I. LONGVIC 21600 LONGVIC FRANCE	
TYPE UNIT TYPE	FCK 190	ANNEE YEAR	2000		
N° SERIE SERIAL NUMBER	215 900-01/01				
ALIMENTATION ELEC. SUPPLY	400	V	3	50	Hz
A. MAXI MAX. AMP.	140	I. DEMARR. START UP AMP.	269	A	C. COMMANDE CONTROL CIR.
				24	V
REFRIGERANT FLUIDE	R407C	Kg/CIRC	11	11	11
			C1	C2	C3 C4

Figure 1



DIMENSIONS AND WEIGHTS

Model	Length mm	Rain Cover mm	Width mm	Height mm	Weight kg
FC*/FH* 050 downflow	2150	-	1780	1090	750
FC*/FH* 050 upflow	2150	-	1780	1120	750
FC*/FH* 050 horizontal flow	2150	-	1780	1120	750
FGA/FDA/FGK/FDK 050	2200	-	1900	1090	850
FC*/FH* 060 downflow	2821	629	2254	1410	1000
FC*/FH* 060 upflow	2821	629	2254	1410	1000
FC*/FH* 060 side discharge	2821	629	2254	1410	1000
FC*/FH* 060 centrif. condensing fan	2821	629	2254	2000	1100
FGA/FDA/FGK/FDK 060	2821	629	2254	1410	1100
FC*/FH* 070 downflow	2821	629	2254	1410	1000
FC*/FH* 070 upflow	2821	629	2254	1410	1000
FC*/FH* 070 side discharge	2821	629	2254	1410	1000
FC*/FH* 070 centrif. condensing fan	2821	629	2254	2000	1100
FGA/FDA/FGK/FDK 070	2821	629	2254	1410	1150
FC*/FH* 085 downflow	3781	629	2254	1495	1200
FC*/FH* 085 upflow	3781	629	2254	1495	1200
FC*/FH* 085 side discharge	3781	629	2254	1495	1200
FC*/FH* 085 centrif. condensing fan	3782	629	2254	2010	1430
FGA/FDA/FGK/FDK 085	2821	629	2254	1495	1300
FC*/FH* 100 downflow	3781	629	2254	1495	1200
FC*/FH* 100 upflow	3781	629	2254	1495	1200
FC*/FH* 100 side discharge	3781	629	2254	1495	1200
FC*/FH* 100 centrif. condensing fan	3782	629	2254	2010	1430
FGA/FDA/FGK/FDK 100	2821	629	2254	1495	1480
FC*/FH* 120 downflow	3582	629	2254	1410	1500
FC*/FH* 120 upflow	3582	629	2254	1410	1500
FC*/FH* 120 side discharge	3582	629	2254	1410	1500
FC*/FH* 120 centrif. condensing fan.	3582	629	2254	1910	1550
FGA/FDA/FGK/FDK 120	4030	629	2254	1410	1750
FC*/FH* 140 downflow	3582	629	2254	1410	1600
FC*/FH* 140 upflow	3582	629	2254	1410	1600
FC*/FH* 140 side discharge	3582	629	2254	1410	1600
FC*/FH* 140 centrif. condensing fan	3582	629	2254	1910	1650
FGA/FDA/FGK/FDK 140	4030	629	2254	1410	1950
FC*/FH* 160 downflow	3590	900	2254	2050	2000
FC*/FH* 160 upflow	3590	900	2254	2050	2000
FC*/FH* 160 side discharge	3590	900	2254	2050	2000
FC*/FH* 160 centrif. condensing fan	3590	900	2254	2050	2150
FGA/FDA/FGK/FDK 160	4040	900	2254	2050	2500
FC*/FH* 190 downflow	3590	900	2254	2050	2250
FC*/FH* 190 upflow	3590	900	2254	2050	2250
FC*/FH* 190 side discharge	3590	900	2254	2050	2250
FC*/FH* 190 centrif. condensing fan	3590	900	2254	2050	2350
FGA/FDA/FGK/FDK 190	4040	900	2254	2050	2750

Model	Length mm	Side louver mm	Ventil. louver mm	Width mm	Height mm	Weight kg
FX* 25	4070	490	600	1633	1055	950
FX* 30	4070	490	600	1633	1055	980
FX* 35	4750	490	600	2254	1290	1400
FX* 40	4750	490	600	2254	1290	1450
FX* 55	4750	490	600	2254	1290	1600
FX* 70	5050	890	600	2254	1725	1800
FX* 85	5050	890	600	2254	1725	1900
FX* 100	5050	890	600	2254	1725	2000
FX* 110	5650	860		2254	2000	2300
FX* 140	5650	860		2254	2000	2400
FX* 170	5650	860		2254	2000	2600

HANDLING

The equipment can be moved using the lifting holes on the top of the unit.
The "sling" length is the value that we recommend for safe handling of the equipment.

Some units can only be supported by four slings at right-angles. Others require different lengths (see figure 3).
It is essential that all lifting holes are used and that the slings are all of the same size to avoid damaging the equipment.

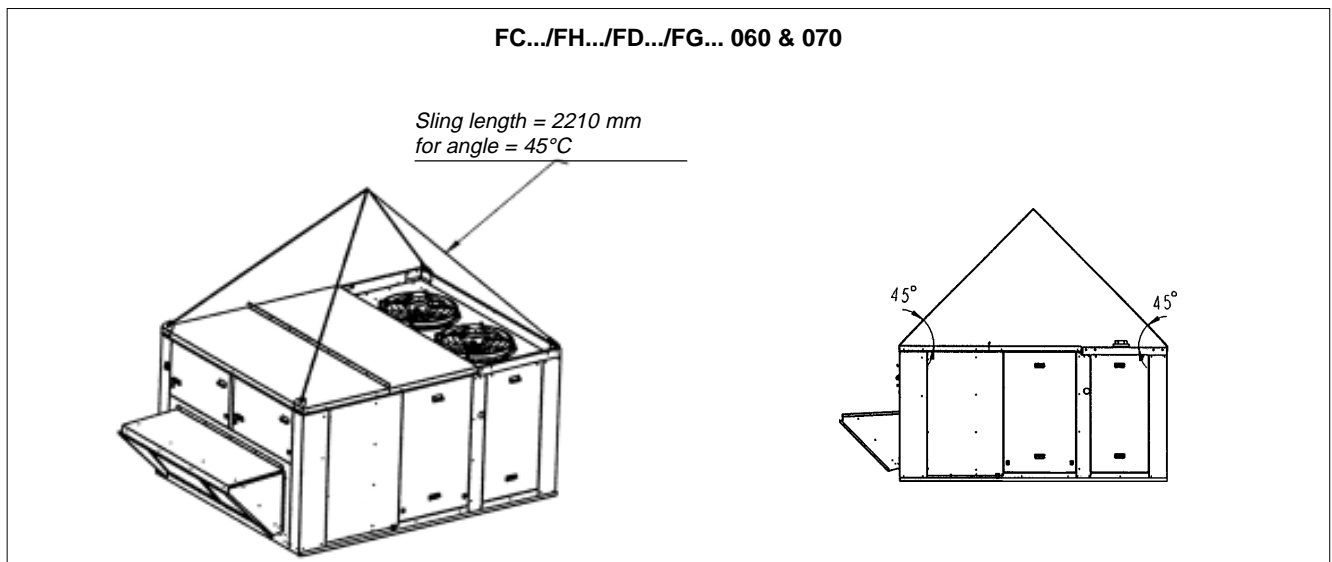
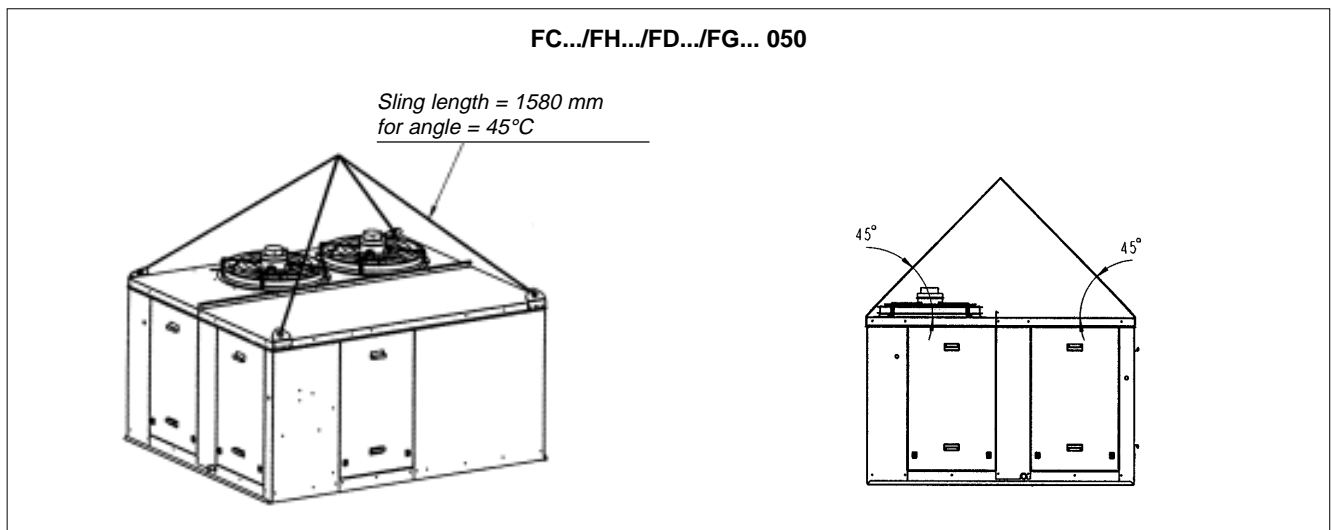

FC.../FH.../FD.../FG... 060 & 070 with centrifugal fans

Sling length = 2590 mm
for angle = 45°C

Sling length = 1855 mm
for angle = 45°C

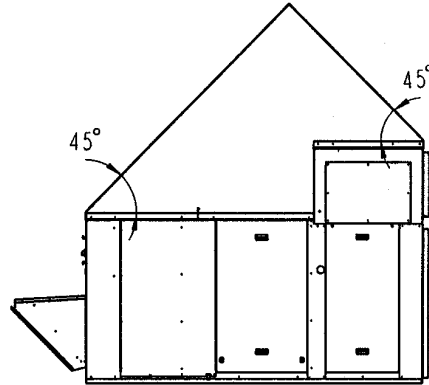
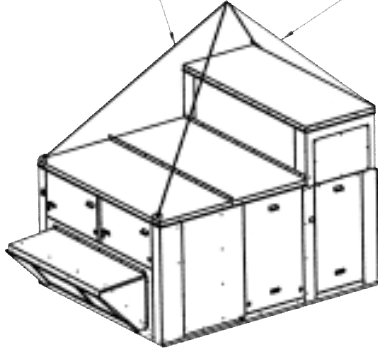

FC.../FH.../FD.../FG... 085 & 100

Sling length = 2830 mm
for angle = 45°C

Sling length = 2330 mm
for angle = 64,5°C

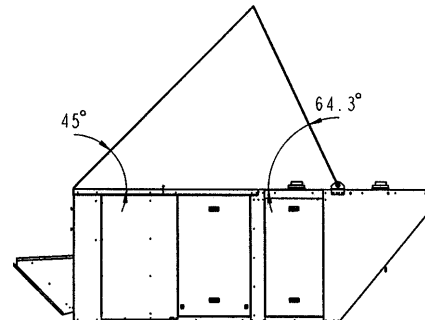
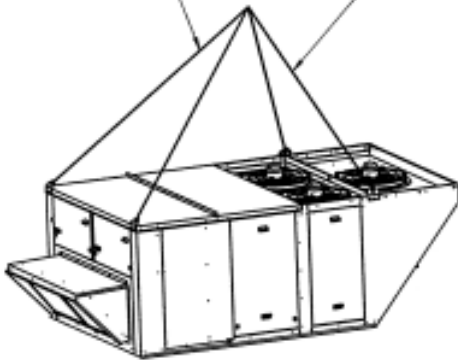

FC.../FH.../FD.../FG... 085 & 100 with centrifugal fans

Sling length = 3230 mm
for angle = 45°C

Sling length = 2430 mm
for angle = 45°C

Sling length = 1870 mm
for angle = 45°C

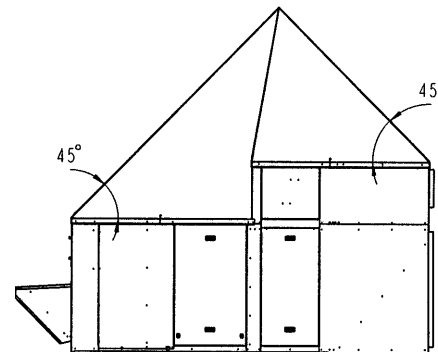
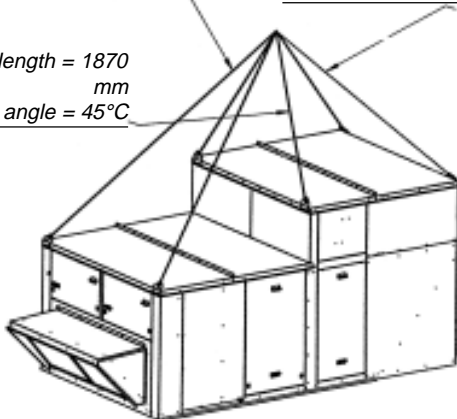

FC.../FH.../FD... 120 & 140

Sling length = 2700 mm
for angle = 45°C

Sling length = 2080 mm
for angle = 45°C

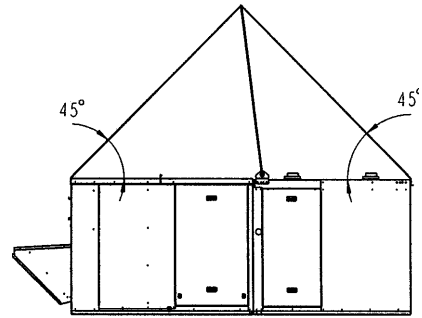
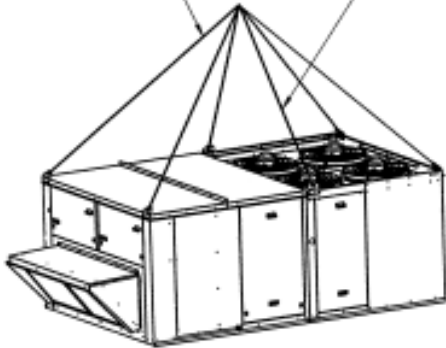

FC.../FH.../FD... 120 & 140 with centrifugal fans

Sling length = 3000 mm
for angle = 45°C

Sling length = 2410 mm
for angle = 45°C

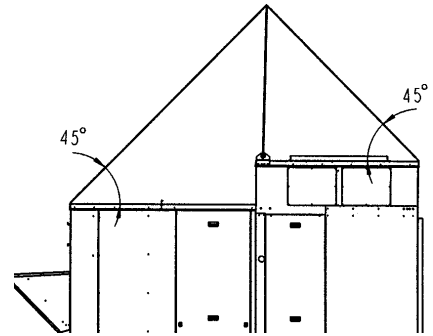
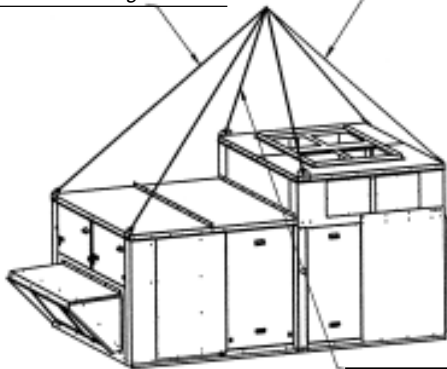

Sling length = 1880 mm
for angle = 45°C

FG... 120 & 140 with gas burner

Sling length = 2700 mm
for angle = 45°C

Sling length = 2080 mm
for angle = 45°C

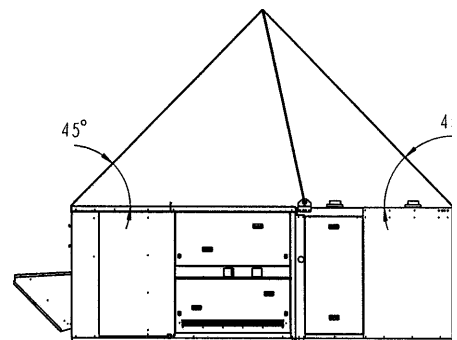
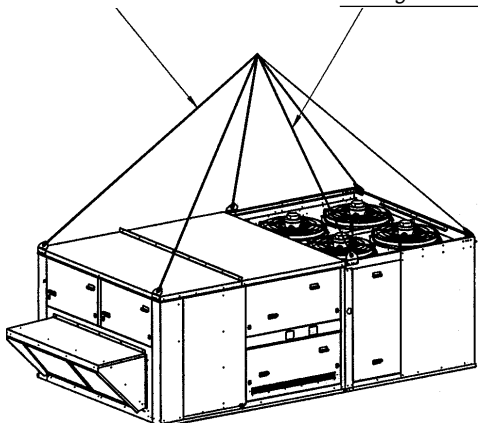

FG... 120 & 140 with gas burner and centrifugal fans

Sling length = 3300 mm
for angle = 45°C

Sling length = 2700 mm
for angle = 45°C

Sling length = 2080 mm
for angle = 45°C

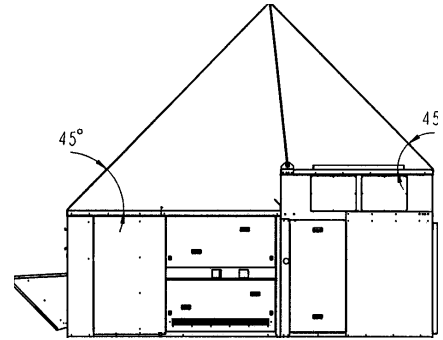
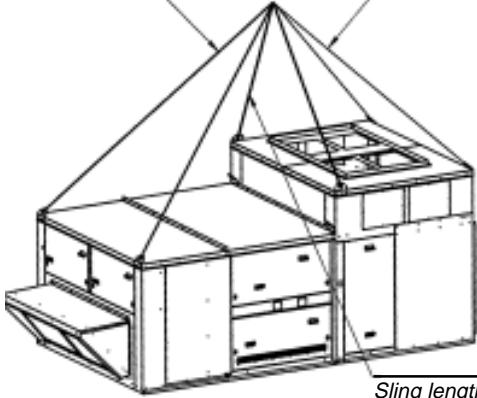

**FC.../FH.../FD... 160 & 190
FC.../FH.../FD... 160 & 190 with centrifugal fans**

Sling length = 2700 mm
for angle = 45°C

Sling length = 2090 mm
for angle = 45°C

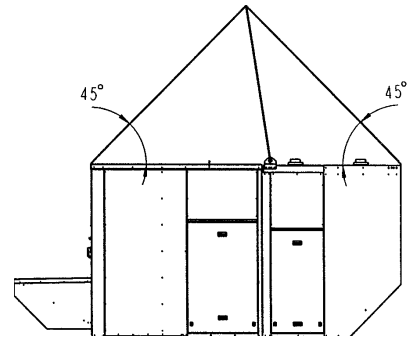
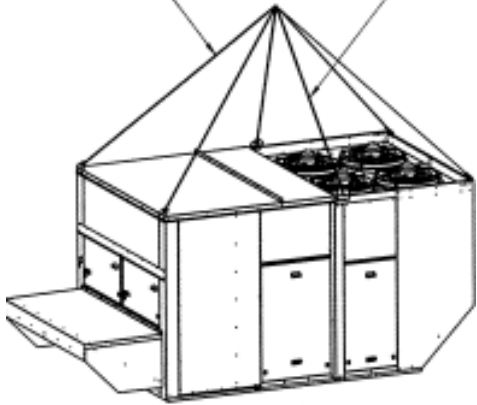

**FG... 160 & 190
FG... 160 & 190 with centrifugal fans**

Sling length = 3000 mm
for angle = 45°C

Sling length = 2320 mm
for angle = 45°C

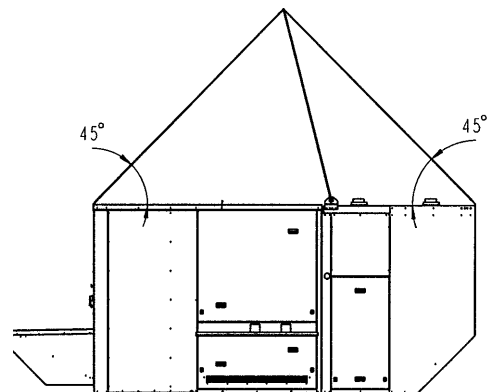
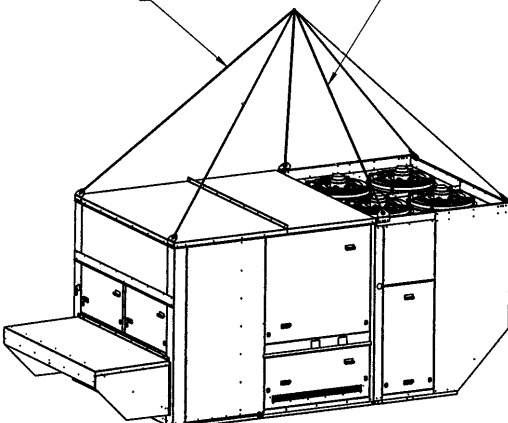

FX 25 & 30

Sling length = 3000 mm

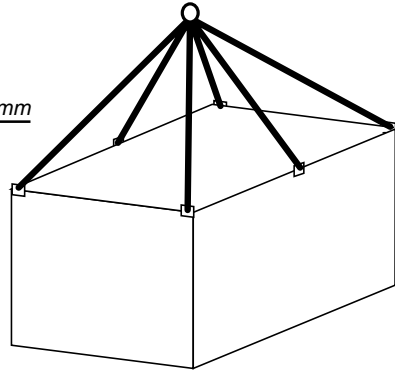

FX 35 - 40 - 55

Sling length = 3700 mm

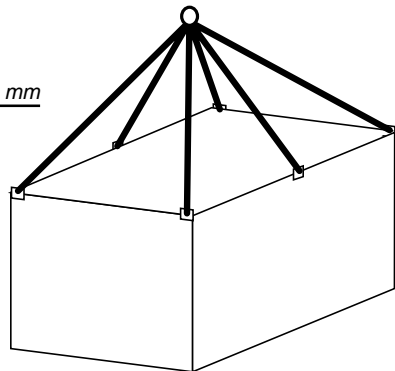

FX 70 - 85 - 100

Sling length = 3900 mm

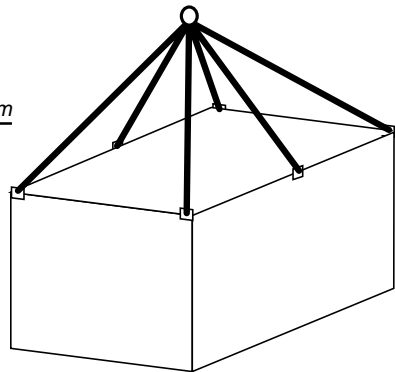

FX 110 - 140 - 170

Sling length = 4300 mm

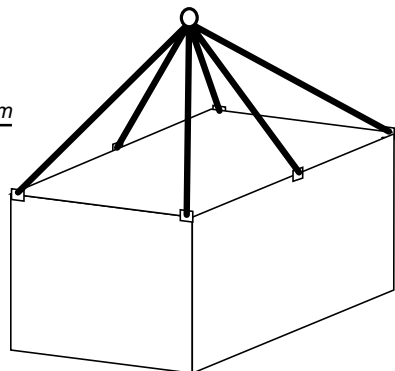

PRELIMINARY CHECK

Before installing the equipment, the following items **MUST** be checked :

- Is there sufficient space for the equipment?
- Is the surface on which the equipment will be placed sufficiently solid to withstand its weight? A detailed study of the frame must be made beforehand.
- Do the supply and return ductwork openings excessively weaken the structure?
- Are there any obstructing items which could hinder the operation of the equipment?
- Does the electrical power available correspond to the equipment's electrical specifications?
- Does the noise level of the equipment meet the specification ?
- Is drainage provided for the condensate?
- Is there sufficient access for maintenance?
- Installation of the equipment could require different lifting methods which may vary with each installation (helicopter or crane). Have these been evaluated ?
- Ensure that the unit is installed in accordance with the installation instructions and applicable codes.
- Check to ensure that the refrigerant lines do not rub against the cabinet or against other refrigerant lines.

In general, make sure no obstacles (walls, trees or roof ledges) are obstructing the duct connections or hindering assembly and maintenance access.

INSTALLATION DEVICE

The surface on which the equipment is to be installed must be clean and free of any obstacles which could hinder the flow of air to the condensers:

- Avoid uneven surfaces
- Avoid installing two units side by side or close to each other as this may restrict the airflow to the condensers.

Before installing a packaged rooftop unit it is important to understand :

- The direction and position of air flows.
- The external dimensions of the unit and the dimensions of the supply and return air connections.
- The arrangement of the doors and the space required to open them to access the various components.

Figure 4 shows the required clearances and dimensions.

CONNECTIONS DEVICE

- Ensure that all the pipework crossing walls or roofs are secured and insulated.
- To avoid condensation problems, be sure all pipes are insulated according to temperatures of fluids and type of rooms.

NOTE : The AQUILUX covers which protect the finned surfaces must be removed prior to unit commissioning.

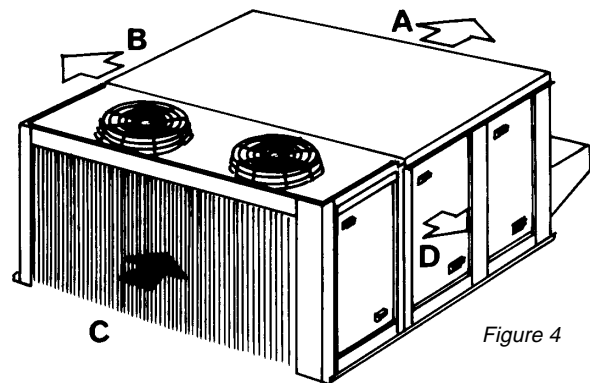

Figure 4

MODELS	A	B	C	D
FC/FH/FG/FD				
50	1000	1000	1000	2000
60 → 140	1400	1000	1400	2300
160 & 190	2000	1000	2000	2300
FX				
25 & 30	*	1100	*	1700
35 → 55	*	1300	*	2300
70 → 100	*	1700	*	2300
110 → 170	*	2000	*	2300

* : according to connection

As levels are adjustable, observe the following recommendations for correct installation of the equipment.

Above all, ensure that all the flaps are facing outward (1 - figure 5). They are sometimes stored inside for transport.

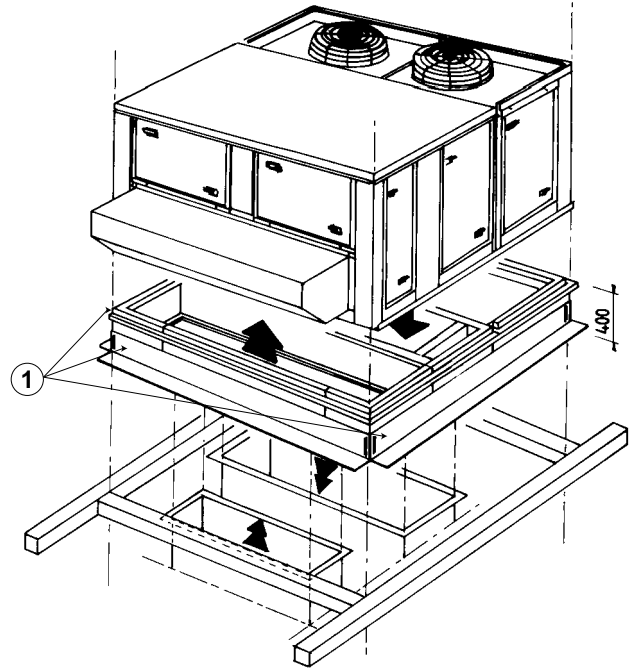

Figure 5

Place the roof mounting frame on the trimmer beam by first lining up the inlet and then the outlet. (2 - figure 6).

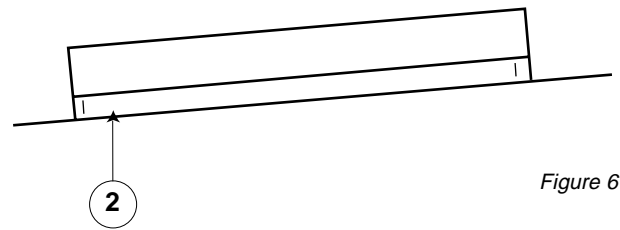

Figure 6

After levelling the frame, fix the surface flaps onto the trimmer.

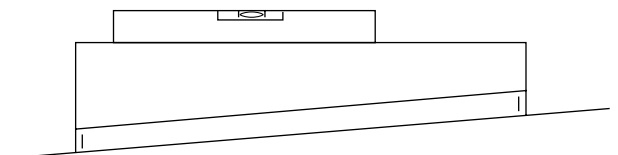

Figure 7

When the frame is correctly positioned, it is essential to secure the assembly with a disconnected welding seam (20 to 30 mm for every 200 mm) along the outside, or by using an alternative method (1 - figure 8).

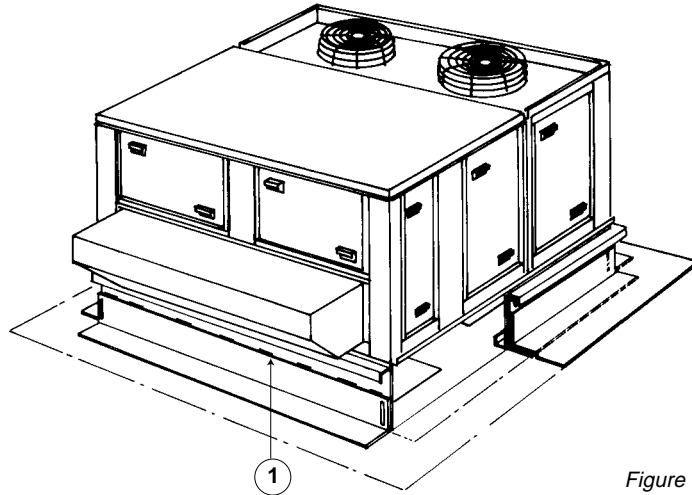

Figure 8

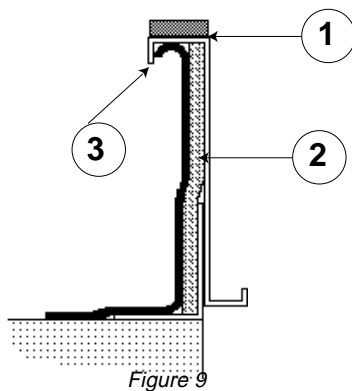

Figure 9

Assembly joint (1 - figure 9)

Insulate the frame before installation. We recommend the minimum application of 20 mm thick insulation. Check that the covering is continuous and apply a seal (2 - figure 9).

CAUTION : To be effective, the upstream must end below the drop edge (3 - figure 9)

Before installing the equipment, make sure that the assembly seal or the puttying is not damaged and check that the unit is fixed to the mounting frame so that it is resting flat on the frame. Once in position, the bottom of the equipment must be horizontal.

The installer must comply to local authority standards and specifications.

The unit can be fitted on corner posts using the frame provided. The minimum height of the posts should be 400mm.

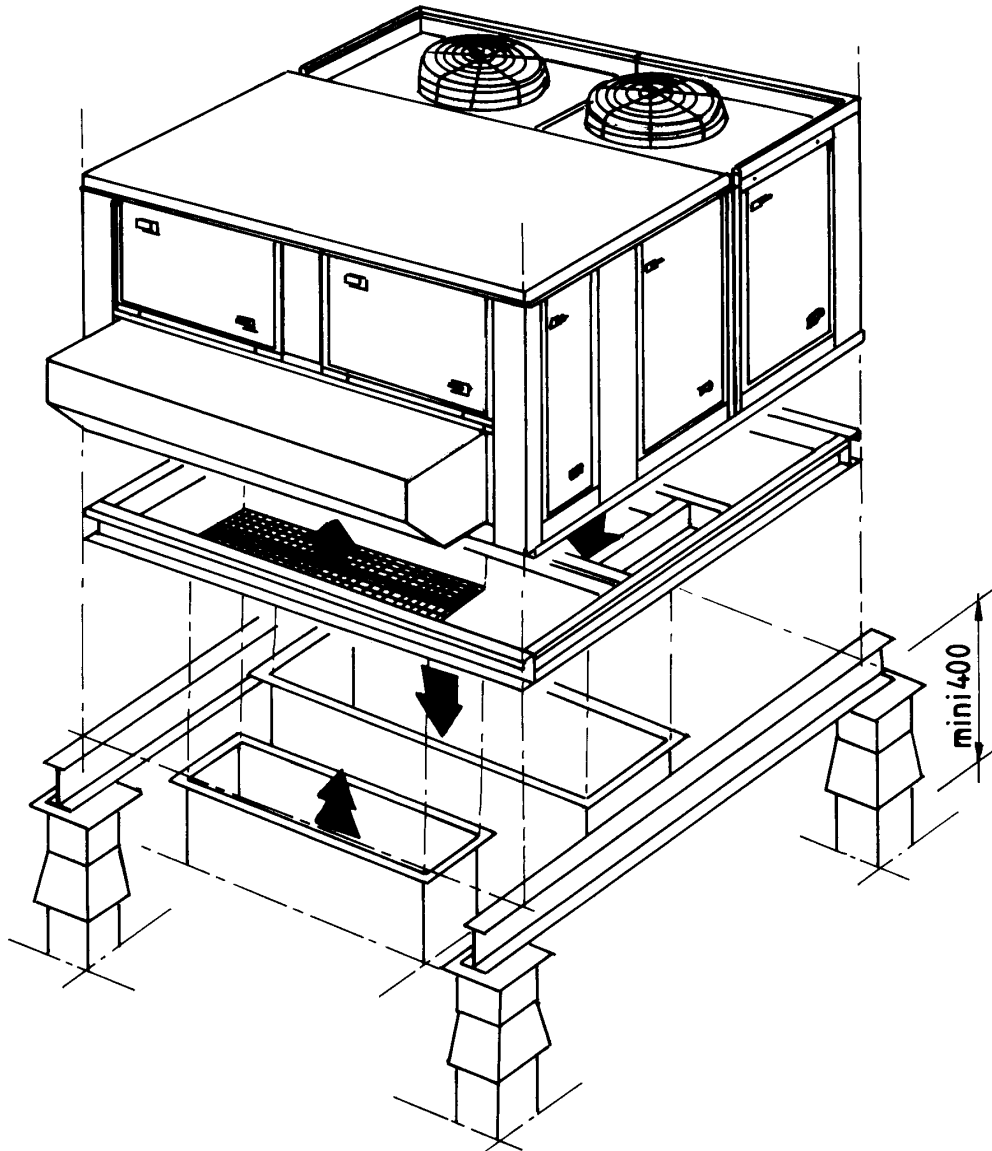

Figure 10

This work must only be carried out by trained refrigeration engineers

Before connecting to the power :

- Ensure that the power supply between the building and the unit meets local authority standards and that the cable specification satisfies the start-up and operating conditions.
- Ensure that the electrical connections in the control panel and on the motors are secure.
- Ensure that all drive motors are secure.
- Ensure that the adjustable pulley blocks are secure and that the belt is tensioned with the transmission correctly aligned.
- Using the electrical wiring diagram, check the conformity of the electrical safety devices (circuit breaker settings, presence and rating of fuses).

At this point attach the manometers to the refrigerant circuit

Powering up the system with the unit isolating switch

- Check the direction of rotation of the fans by pressing their contactors. Refer to the rotation arrows situated next to the coils or fans (NOTE: unlike a coil, a fan rotating in the wrong direction may fail).
- The fans' direction of rotation is checked during an end of production test. They should therefore all turn in either the right or wrong direction.
- If they turn in the opposite direction, disconnect the power supply to the machine at the building's mains switch, reverse two phases of the incoming supply to the machine and try again.
- If only one of the fans rotates in the wrong direction, disconnect the power supply at the machine's isolating switch and reverse two of the component initial phases on the terminal within the electrical panel.

Using CLIMATIC™

- Check the voltages recorded against the rated values, in particular on the system supply fans.
- If the readings on the fans are outside the limits, this indicates excessive air flow which will affect the thermodynamic performance. Refer to the "Air Flow Balancing" section.

Thermodynamic readings using manometers and prevailing environmental conditions

- No rated values are given here. These depend on the climatic conditions both outside and inside the building during operation. However, an experienced refrigeration engineer will be able to detect any abnormal machine operation.

Safety Test

- "Clogged filter" detection test : vary the setpoint value (KP02 setpoint 93) in respect to the air pressure value (KP02, variable 16). Observe the response of the CLIMATIC™.
- Same procedure for detecting "Missing Filter" (setpoint 94) or "Air Flow Detection" (setpoint 92).
- Check the smoke detection function.
- Check the Firestat by pressing the test button.
- Disconnect the circuit breakers of the capacitor fans and check the high pressure cut-out points on different refrigerant circuits.

Reverse Cycle Test

On reversible units this test is used to check the switching of the 4-way valves. Start the reverse cycle with reference to the cold or hot temperature threshold data according to the climatic conditions at the time of testing (setpoint 15 + setpoint 16).

Your machine is now operational.

You can now proceed to the setting stage. See the "Control" section.

The actual resistance of ductwork systems is not always the same as the calculated theoretical values. To rectify this, it may be necessary to modify the pulley and belt setting. To this effect, the motors are fitted with variable pulleys.

TEST

You should already have measured the + ve pressure experienced on fan discharge, as well as the pressure experienced in the return duct to the fan. Measure the motor absorbed power.

If the absorbed power is greater and the pressure lower than the rated values, your system has a lower pressure drop than anticipated. Reduce the flow. If the system resistance is significantly lower than design, there is a risk that the motor will overheat resulting in an emergency cut out.

If the absorbed power is lower and the pressure greater than the rated values, your system has a higher pressure drop than anticipated. Increase the flow. At the same time you will increase the absorbed power which may result in having to fit a larger motor.

To carry out the adjustment and to avoid a time-consuming re-start, stop the machine and if necessary lock the main switch.

First unscrew the 4 Allen screw(s) on the pulley (see figure 11).

Slacken the belts, then remove them (see § "BELT TENSION").

The flow can now be increased by turning the flange(s) to move them closer (or alternatively, move them apart to reduce the flow).

For two-groove pulleys, turn the flanges the same number of turns.

If necessary, check the pulley diameter by measuring the outer diameter of a belt positioned in the groove (figure 12).

Finally, replace and tension the belts before carrying out a test. Re-check the absorbed power levels. Repeat the operation until a satisfactory result has been achieved.

To minimise the number of operations, refer to the flow / pressure charts on the following pages for the type of fans used. With reference to the following example, you can estimate your flow and thus calculate the necessary adjustment.



Figure 12

ALLEN wrench 4



Figure 11



UNIT/FAN KIT REFERENCE TABLE

50	FCx or FHx FGx or FDx		1 1				
60	FCx or FHx Centrifugal condensor FGx or FDx		1 (*) 2		1		
70	FCx or FHx Centrifugal condensor FGx or FDx		1 (*) 2		1		
85	FCx or standard FHx FCx or side FHx Centrifugal condensor FGx or FDx		1 (*) 2	2	2		
100	FCx or standard FHx FCx or side FHx Centrifugal condensor FGx or FDx		1 (*) 2	2	2		
120	FCx or standard FHx FCx or side FHx Centrifugal condensor FGx or FDx		2 (*)	2	2	2	
140	FCx or standard FHx FCx or side FHx Centrifugal condensor FGx or FDx		2 (*)	2	2	2	
160	FCx or standard FHx Centrifugal condensor FGx or FDx		4		2		2
190	FCx or standard FHx Centrifugal condensor FGx or FDx		4		2		2

ROOF-TOP type FX*

25	Supply Extract	1 1					
30	Supply Extract	1 1					
35	Supply Extract		1 1				
40	Supply Extract		1 1				
55	Supply Extract		1 1				
70	Supply Extract				1 1		
85	Supply Extract				1 1		
100	Supply Extract			1 (*)	1		
110	Supply Extract				2 2		
140	Supply Extract				2 2		
170	Supply Extract				2 2		

The number indicated in the table refers to the number of fans.

1(*) : In this case the two fans are coupled to the same shaft.

2(*) : Indicates that there are 2 groups of 2 coupled fans.

EXAMPLE :

You may want to adjust a **FHK 120** set to 22 000 m³/h with a system resistance of 150Pa:
The machine has 2 fans (chart D).

For this operating point, the unit supplied is fitted with E kits comprising 112 mm - 131 mm variable pulleys on the motors and 250 mm pulleys on the fans.

In this case the pulley motor adjustment is 126 mm for a fan speed of 730 rpm.

On the chart, for 11 000 m³/h (2 fans), indicates 730 rpm (point A).

- Total pressure 500 Pa
(150 Pa system pressure + 230 Pa equipment loss + 120 Pa static pressure)
- Absorbed power 2.1 kW, which gives 5.7 A, calculated as follows:

$$I_n = (P.kw \times Ct / R_m) / (\sqrt{3} \times U \times \cos \phi) = (2100 \times 1.2 / 0.8) / (\sqrt{3} \times 400 \times 0.8) = 5.7A$$

R_m = Motor output

C_t = Transmission coefficient

On site you measure :

- System static pressure 70 Pa or total pressure 230 Pa
(the pressure must be measured after 1 m minimum on the return ductwork)
- Absorbed power 6.8A

The theoretical absorbed power will be : $P = (\sqrt{3} \times 400 \times 6.8 \times 0.8) / 0.8(R_m) \times 1.2(C_t) = 2,500 W$

With reference to the chart data, the operating point B has been highlighted as we note that: the system is exceeding design airflow rates. 12 700 m³/h and 25 400 m³/h can be read for the two fans instead of the 22,000 m³/h specified.

To return to the design flow, consider point C, which now gives a rotation speed of 650 rpm, i.e. a variable pulley adjustment of :

Adjustment = fan speed / motor speed * pulley diameter = 650 / 1450 * 250 = 112 mm.

Alternatively, where there is reduced airflow, i.e.caused by a greater system resistance than anticipated (items B' and C'), follow the same procedure, but in this case ensure that the absorbed power at C' is compatible with the motor fitted.

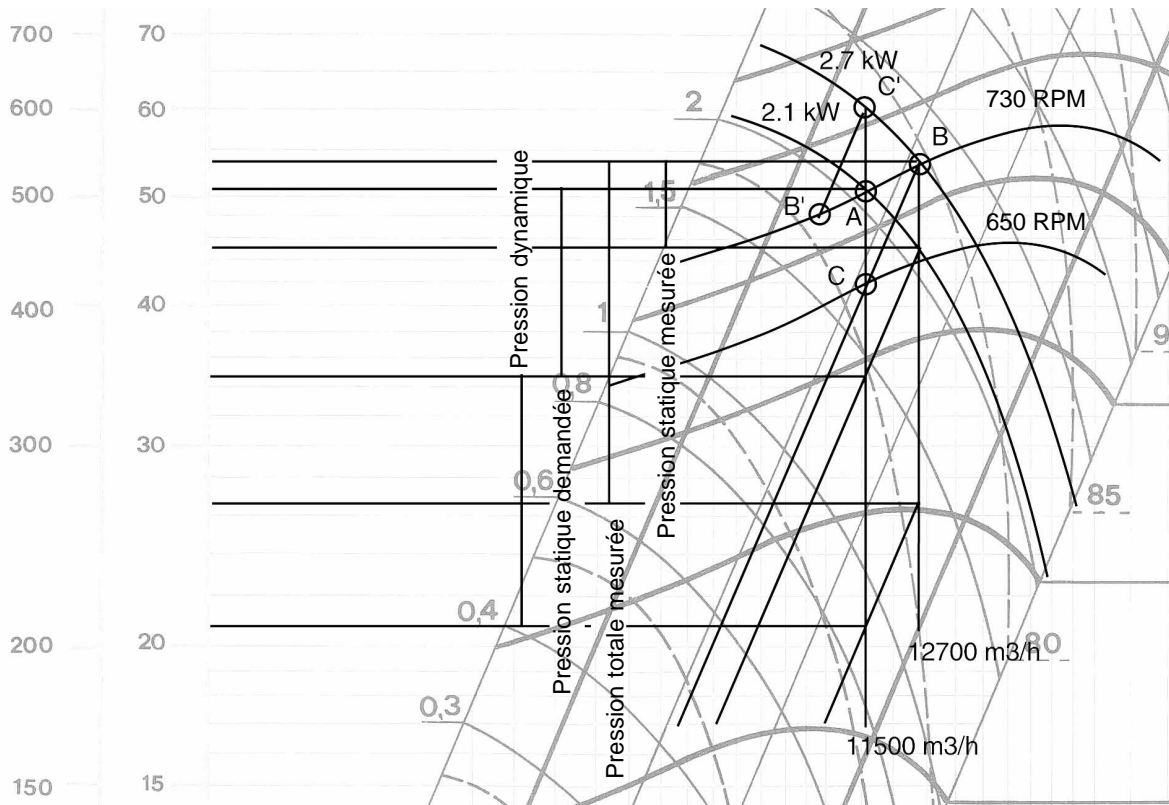

CHART A

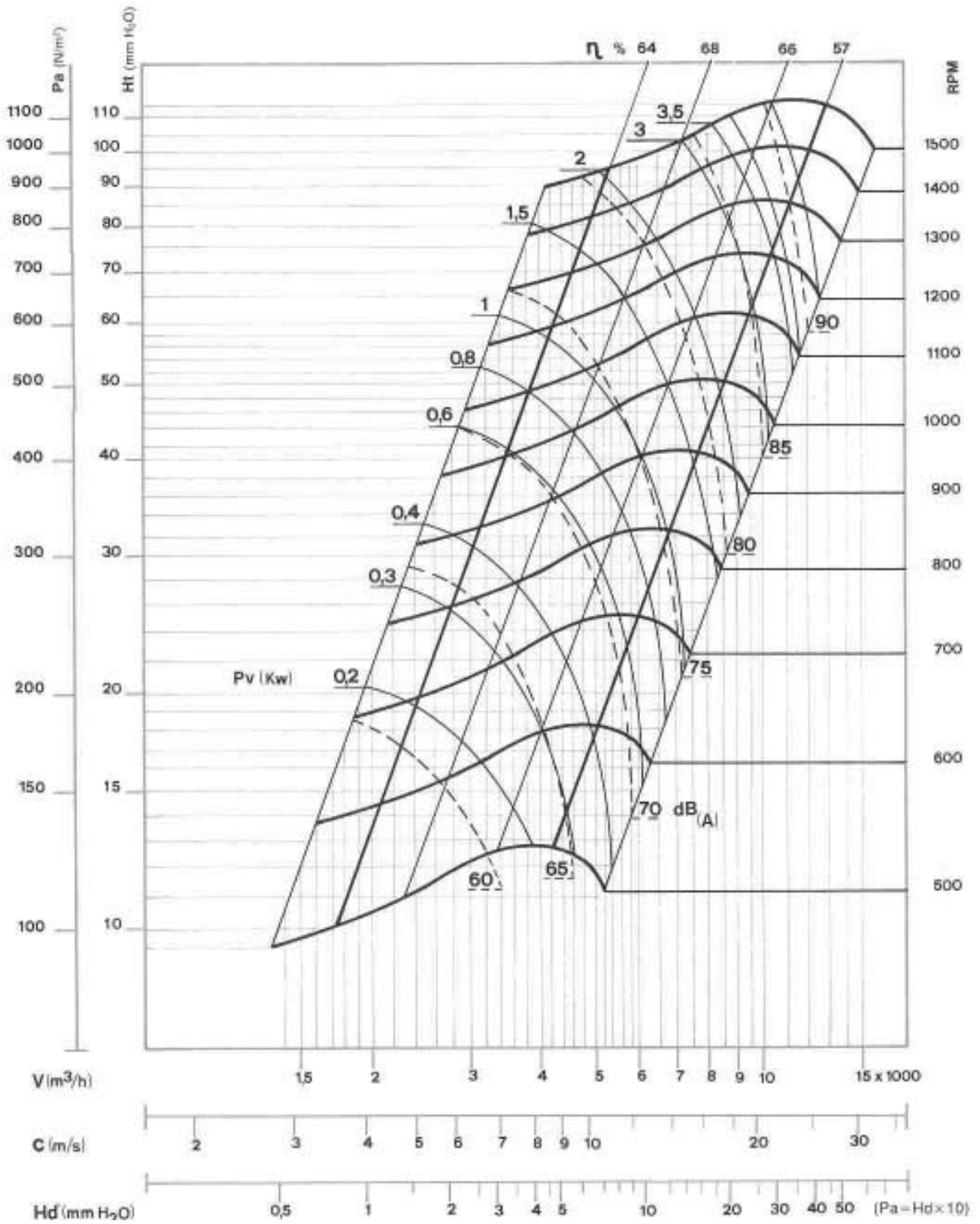

CHART B

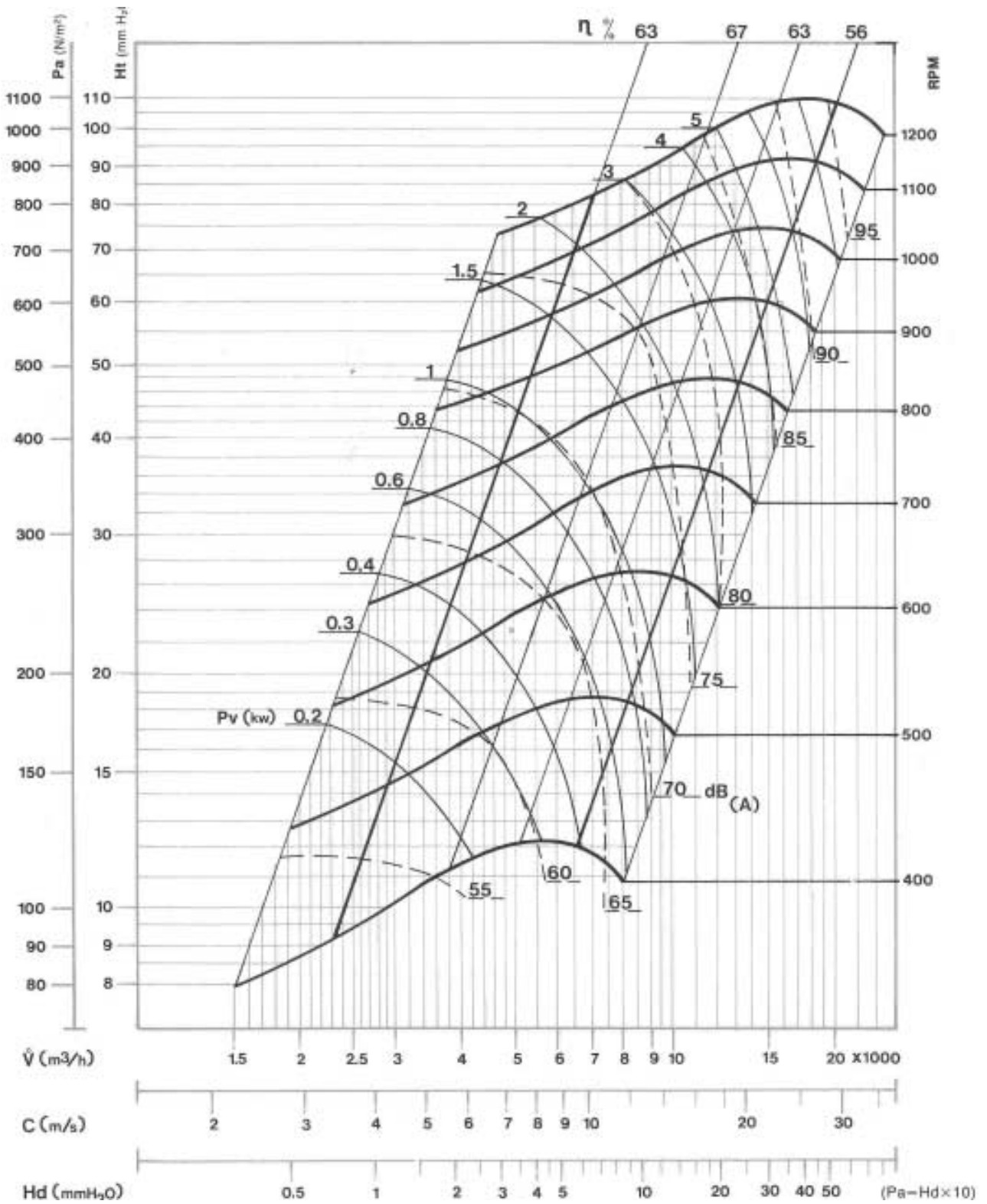

CHART C

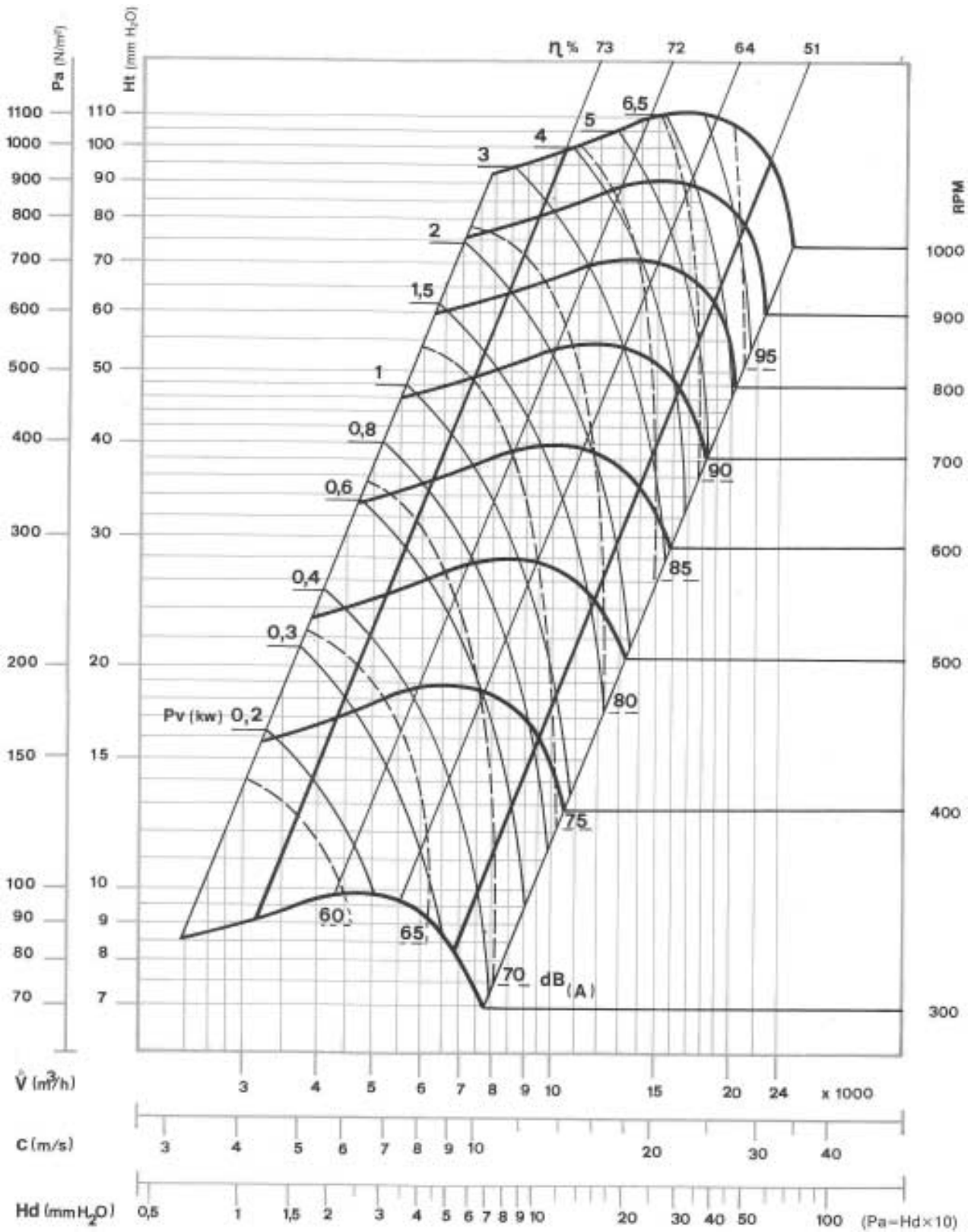

CHART D

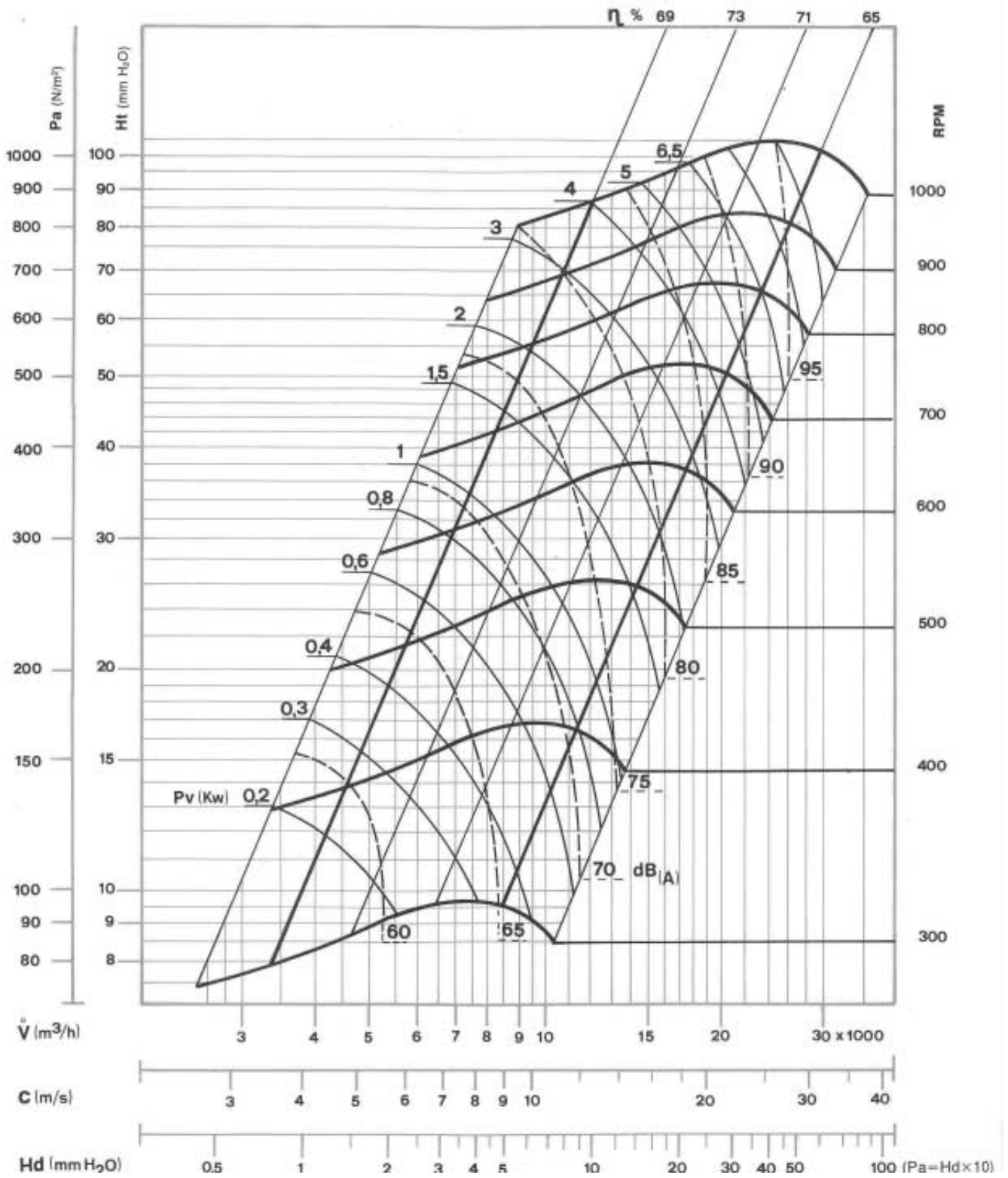

CHART E

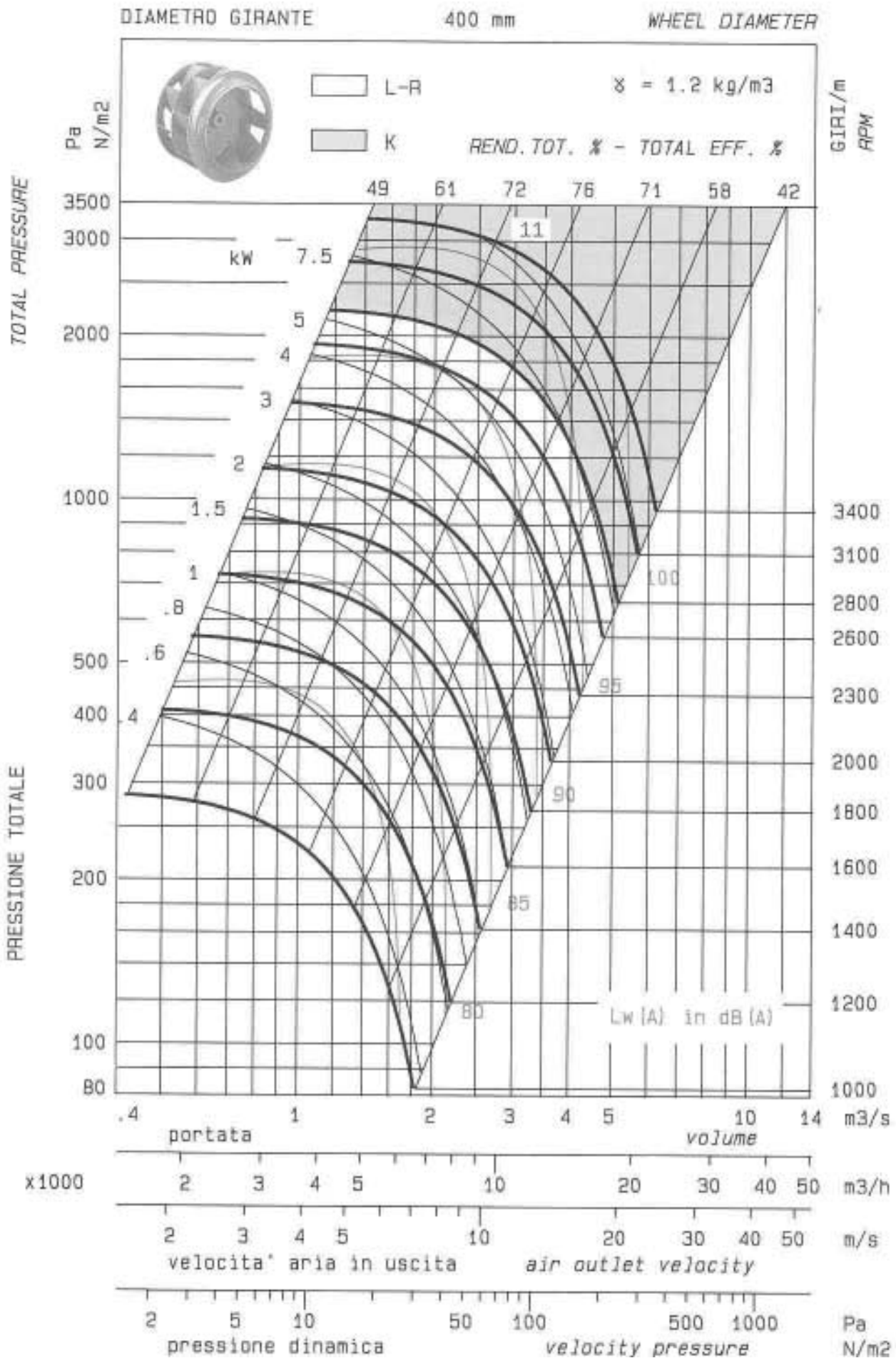
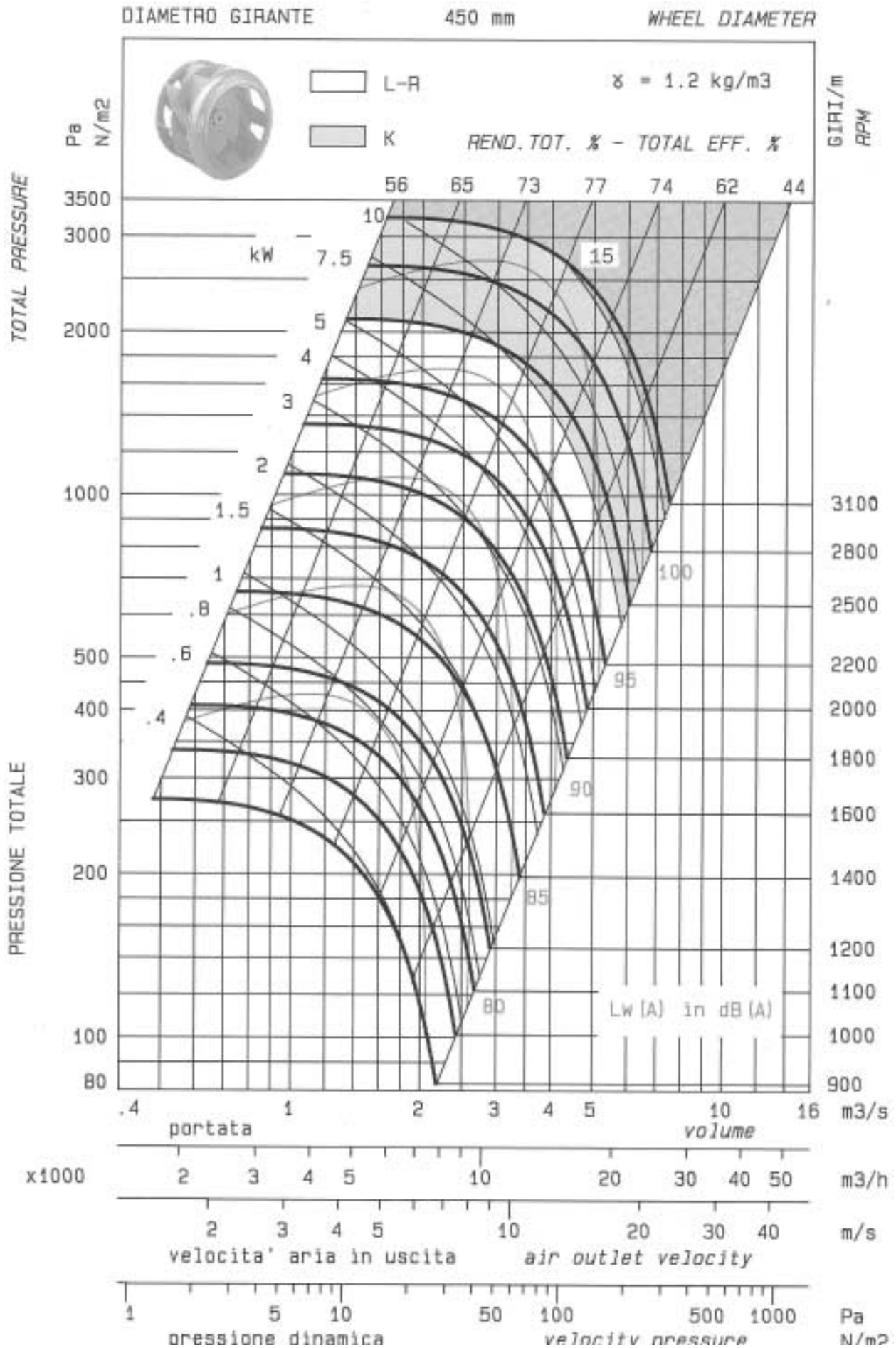



CHART F



The FX* models are designed to operate with more complex supply and extract ductwork systems. Without balancing there are numerous risks :

- Fan motor overvoltage
- Significant flow variations depending on the position of the dampers, which affects the building concerned, especially when applied to pressure balanced systems.

To rectify this we have fitted an equilibrating grill on the fresh air dampers. The grill can be moved after unscrewing the knurled nuts (1 - figure 14) and operates as an adjustable damper.

Before starting to adjust fully open the equilibrating grills.

To equilibrate, proceed as follows :

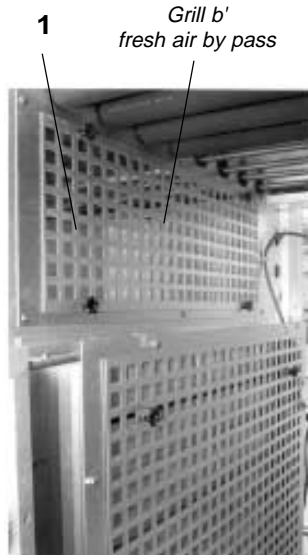

Figure 14

- A. Set the unit to the "recycle air" position (figure 15)
- B. Measure the static pressure in the areas indicated 1/2/3/4/5/6
- C. Before proceeding further, check that the pressure difference between zones 1 and 4 satisfies the static pressure required.

If this is not the case, refer to the "AIR FLOW BALANCING" section.

- D. If the flow and the pressure are correct :
On grills "b" and "b'", bring the pressure at 5 to the same level as 3 (the grills must be moved simultaneously by the same amount).
- E. Check that the power absorbed by the extract fan motor is less than its rated power.
If the values are not the same, refer to the "AIR FLOW BALANCING" section.
- F. Switch the unit to "fresh air" (figure 16), and measure the static pressure at 2/3/4/5/6.
- G. Adjust grill "a" so that the value measured at 3 is the same as the value at point B.
- H. Finally check that the pressure at 5 is the same as the pressure measured at point B. If not, slightly adjust the grill "b" setting of the fresh air by-pass.

Example :

Zone		1	2	3	4	5	6
Technical specification	Pa	200			-180		
Recycled air without setting	Pa	190	-230	-210	-190	-70	-120
Recycled air after setting b/b'	Pa	190	-230	-210	-190	-210	-240
Fresh air before setting	Pa	270	-80	-50	-200	-220	-250
Fresh air after setting grill a	Pa	190	-230	-210	-200	-220	-250
Fresh air after setting grill b'	Pa	190	-230	-210	-190	-210	-240

Figure 15
FX in "recycle air" position

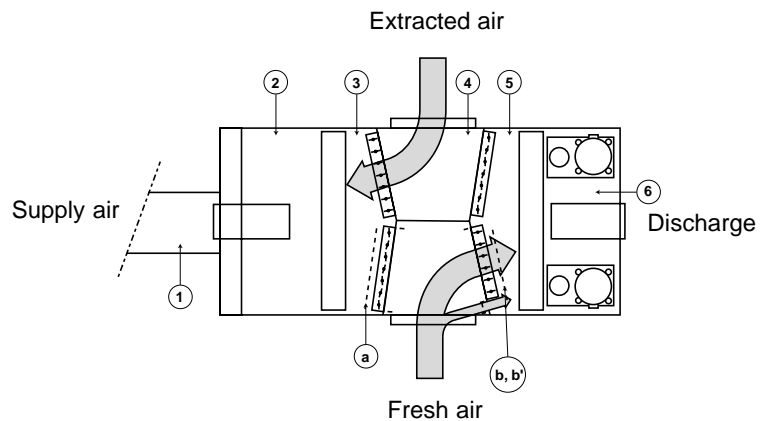
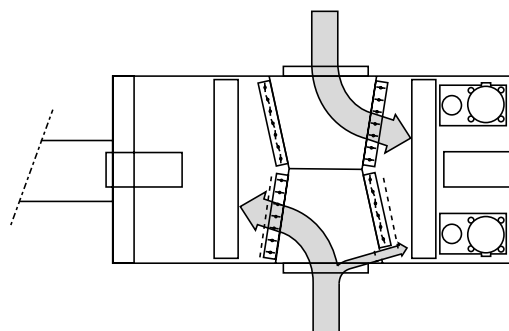



Figure 16
FX in "fresh air" position



The CLIMATIC™ controls the filters. Two types of problems may occur :

1 - **004** error code (lit LED “filter”) or the following icon (for a

graphics screen - KP07) : 

Item 8 on KP 17 indicates that the filters must be changed. The unit has not stopped but the airflow is likely to be reduced due to increased pressure drop across the filters.

2 - **005** error code or the following icon

(for a graphics screen - KP07) : 

Item 9 on KP17 indicates that the filters are out of position : either they have been damaged or not been replaced during maintenance. In the latter case, the unit has not stopped but the increased flowrate may result in the motor overheating. It is important to check the filter immediately.



KP 17 DISPLAY

Figure 17

FILTER REPLACEMENT :

After opening the filter access panel, unscrew the butterfly nuts maintaining the filter support and remove it (figure 18).

Remove the cells that are slide-mounted (figure 19). Use the rod in the lower filter section to remove the cells at the bottom of the sliders.

Install new filters inside the sliders.



Figure 18



Figure 19

HYDRAULIC CONNECTIONS

The heating coil is connected to the isolating valves. Two keys must be used to tighten the connections, one of the keys maintains the valve body. Failure to use two keys may damage the pipes and invalidates the warranty.

Proceed as follows :

- Open the stop valves and set the 3-way valve to the intermediate position (manual position and turn the thumbwheel to a mid position).
- Fill the hydraulic system and bleed the battery using the air vent (figure 20).
- Check the connections for possible leaks.
- Reset the 3-way valve to automatic.



Figure 20

PROTECTION AGAINST FREEZING

- 1) Use glycol water

GLYCOL IS THE ONLY EFFECTIVE PROTECTION AGAINST FREEZING

The antifreeze must protect the unit and avoid icing under winter conditions.

Warning : monoethylene glycol-based antifreeze may produce corrosive agents when mixed with air.

- 2) Drain the installation

You must ensure that the manual or automatic air vents have been installed on all high points in the system. In order to drain the system check that all the drain cocks have been installed on all low points of the system.

To drain, open all the valves and remember to place the unit in air.

A HEATING COIL FROZEN DUE TO LOW AMBIENT CONDITIONS IS NOT COVERED BY THE WARRANTY.



Figure 21

ELECTROLYTIC CORROSION

Attention is drawn to the corrosion problems resulting from electrolytic reaction created from unbalanced earth connections.

ANY COIL DAMAGED BY ELECTRONIC REACTION IS NOT COVERED BY THE WARRANTY.

CONDENSATE DRAINS

The traps are not assembled when delivered and are stored in the electrical panel with their clamping collars.

To assemble them, insert them on the condensate tray outlets and use a screwdriver to tighten the collars (Figure 22).



Figure 22

PRELIMINARY CHECKS ON COMMISSIONING

NOTE : Any work on the gas system must only be carried out by qualified personnel.

CAUTION :
Smoking is forbidden during any intervention on the gas components.

Make sure that the gas supply line installation conforms to the latest technology and the local safety regulations. Check that the gas supply line can provide the burners with the pressure and the gas flow rate necessary to provide the heating output duty.

Bleed the air in the gas delivery pipes by loosening the nuts of the copper tubes on the gas solenoid valve inlet by two turns. Tighten properly after bleeding.

Measure the pressure on the gas solenoid valve inlet (5 - figure 24), with the appliance at its rated value. The rated value must be 20 mbar \pm 2 for natural gas and 37 mbar \pm 3 for propane.

If this is not the case, consult the gaz supplier or see the following "Pressure reducing valve" section in the event of the appliance being powered by natural gas at 300 mbar.

Check that the supply voltage of the ignition control box(es) is between 220 and 240V.

Check that the air inlet combustion vents and the smoke extract vents are not blocked.

Check that the supply air flow is correct.

IGNITION DETAILS

Make sure that the gas line valves are open.

With the ROOF TOP working (Setpoint 06 to ON), adjust settings 59 and 60 to ON to start the priority. Increase setting 1 (threshold temperature) to a temperature greater than the ambient temperature (Var. 1) This in turn produces a heating demand and starts the burner.

The control box supply switch (KM21) closes and the burner fan (VIN1) starts. When the depression in the fan is reached, the pressostat (B21) tips.

After a pre-ventilation period (approx. 30 seconds) the gas valve (YV51) opens and the firing sequence (ignition electrode B6) is initiated.

Once the ionization probe detects the flame, the burners functions normally.

If, when the ignition sequence is over, the ionization sensor (B4) does not detect a flame, the burner disconnects and CLIMATIC™ indicates the fault after a six-minute time delay.

If the flame goes out during normal operating, the control restarts the firing sequence with pre-ventilation until a flame has been detected or there is disconnection.

When a burner has two gas tiers, the procedure for the second tier is similar but the references are as follows :

- KM22 for the supply switch
- VIN2 for the fan
- B22 for the gas exhaust pressure switch
- YV52 for the gas valve
- B7 for the ignition electrode and
- B5 for the ionization sensor.

PRESSURE REDUCING VALVE SETTING

- Connect the tube of the manometer to the power pressure inlet of a solenoid valve (5-figure 24) after loosening the screw.
- Remove the safety plug of the expansion valve setting.
- Use a screwdriver to pre-set by placing the screw at a depth of 34 mm.
- Place the burner(s) in operation at maximum power and set the output pressure. Turn (clockwise) to increase the pressure and (anticlockwise) to reduce it.
- When the pressure has been set, replace the safety plug.
- Disconnect the pressure gauge and retighten the screw.

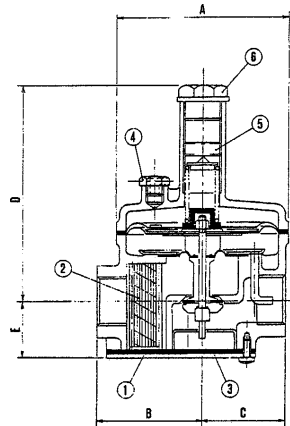

Figure 23

PRESSURE REGULATOR CONTROL OR SETTING

This is located on the burner tiers (1 – figure 24) of the gas control assembly.

- Increase the value of set point 1 (temperature set point to a temperature higher than room temperature) (variable 1).
- Wait until the operation of the burner(s) reaches maximum power.
- Connect the tube of the manometer to the injection pressure inlet after having loosened the screw (4-figure 24).
- Wait until a stable pressure is displayed on the pressure gauge.
- Use a 8 mm key to adjust the maximum pressure (3 – figure 24) – clockwise to increase it and anticlockwise to reduce it. The maximum pressure must always be set before setting the minimum pressure.
- The minimum pressure must be measured if the regulator is not supplied. By disconnecting the tracer wire 116 on card EF45 or EF46 for the one-ramp module or the upper ramp of the two-ramp module. It can be adjusted with a 3.5 mm screwdriver on the screw located inside the maximum pressure setting.
- For the setting of the second ramp, disconnect the tracer wire 116 or 126 in order to switch to low speed.

- Manipulate the regulator several times by connecting and disconnecting wire 116 or 126 in order to check the low and high speed settings.

Note : The maximum pressure setting affects the minimum pressure setting and may have to be changed.

- When the settings are correct, connect wires 116 and 126, making sure they are properly tightened, remove the pressure gauge and replace the safety cap.
- Restart the unit and watch the burner complete several full cycles to ensure that all the components are working properly.

NOTE : The minimum and maximum pressure settings corresponding to the various gas types are listed in the table at the end of this manual.

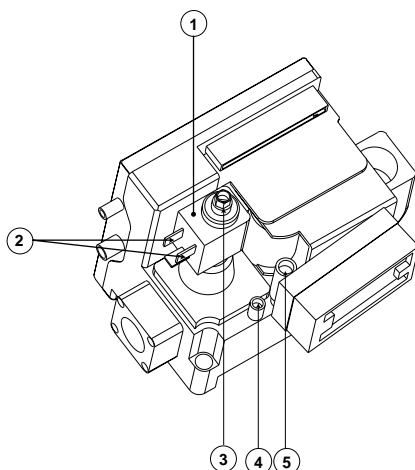

Pressure taps :
(4) : Injection
(5) : Supply

Figure 24

IGNITION ELECTRODE

The following two checks can be made :

- Ensure that the electrode tip (1 – figure 25) is always sharp and oxide-free. Use some sand paper to clean it, if necessary.
- The space between the tip and the air duct must be 3 mm approx. (2 – figure 26).

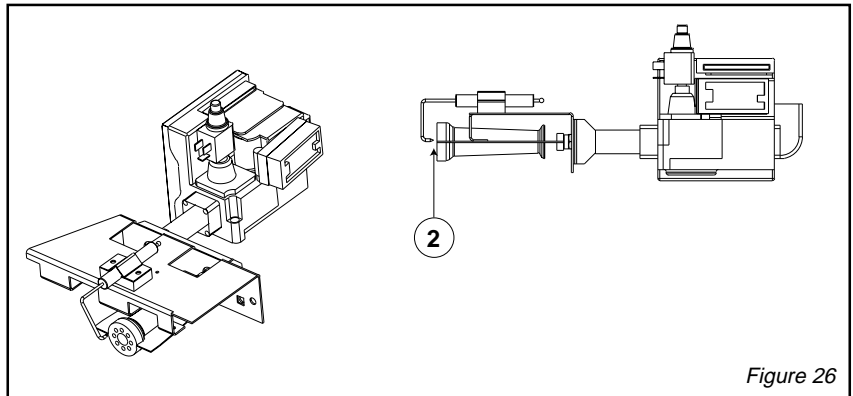
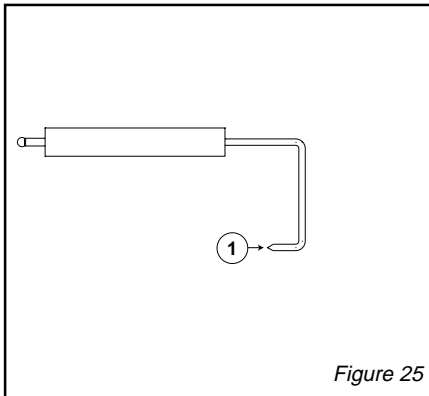

IONISATION SENSOR

- The sensor must be placed in the air duct at approximately 12.5 mm from the burner (3 – figure 27).

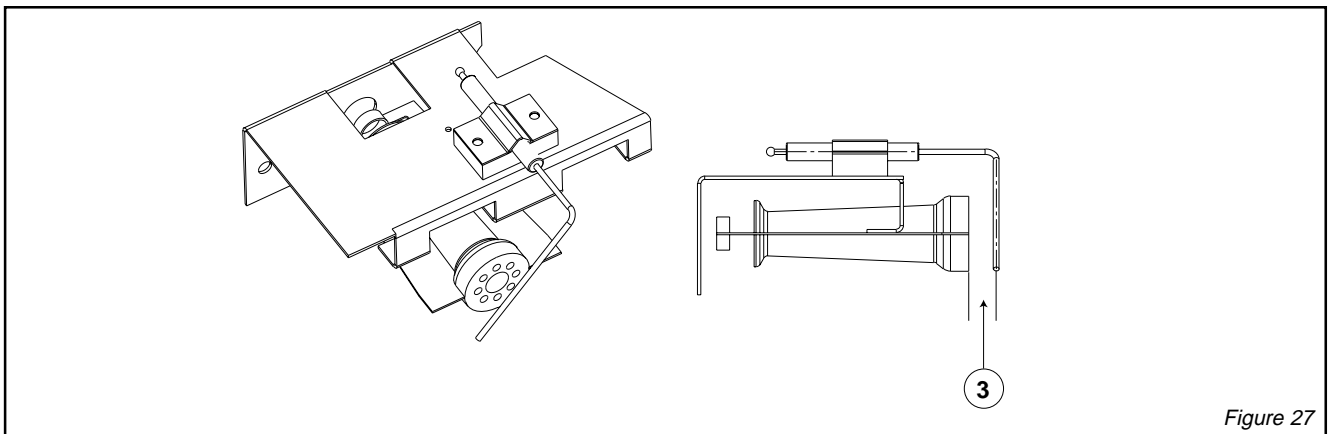

Check that the position is correct in the flame (see figure 28).
It must be placed just after the flame front.
There is no ionisation inside the blue cone. It reduces and reaches the end of the flame afterwards.

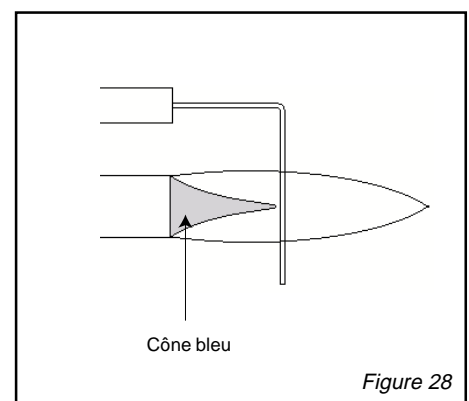

BURNER DISASSEMBLY FOR SERVICE AND MAINTENANCE PURPOSES

Please refer to the enlarged diagrams at the end of the section (figures 29 to 31) for further help.

- Stop the unit, switch off the main switch and disconnect the gas supply.
- Disconnect the PCB switches (figure 29).
- Remove the flared flange nuts either on the solenoid valves or on the supply float rails. Do not tamper with the joints.
- Remove the nozzle float rail and the control box. Be careful not to damage or change the setting of the ionisation sensors or ignition electrodes.
- Remove the limiters (2) and deflectors (3) (see figures 30 to 32).
- Déconnecter et déposer les ventilateurs d'extraction avec leur conduit d'évacuation des fumées.
- Release the pressure tap pipes from the pressure controllers.
- Loosen the screws on the fume box and remove the assembly with the fans by slightly raising to release the screws before pulling it towards you. Always make sure not to damage the PCB.
- Using a clamp, remove the turbines from the tubes on the fume box side.
- Use a 50 mm diameter nylon brush to sweep inside the upper and lower tubes. Extract the dust with a vacuum cleaner.



Figure 29

TROUBLESHOOTING

The fan does not work.

- Check the electrical supply as well as the CLIMATIC™ which should show a heat demand.
- Make sure that B17/18 minigas pressure controller is closed.
- Make sure that B45/46 klixon is neither damaged nor too hot.
- Check whether the fan motor is powered and whether it can turn freely.
- Check the supply and ensure it can rotate freely.

The fan starts without an ignition spark

- Check the operation of the air pressostat (B21/22)
- Check the ignition electrode position (see figures 25 & 26).
- Clean any oxide on the electrode.
- Check that the wire or electrode connections are not earthed.

The fan starts with an ignition spark but without a flame

- Check the gas supply pressure.
- Bleed the gas line.
- Check the injection gas pressure. Adjust the pressure on the solenoid regulator, if necessary.
- YV51/52 solenoid valve does not work : check the supply voltage. Replace it if necessary.

The fan rotates, the flame is lit but goes out without disconnecting

- Gas flow is too low, the pressure drops when the solenoid valve opens.

The fan rotates, the flame is lit but goes out with disconnecting (figure 20)

- Incorrect position of the ionisation sensors.
- Faulty connections of the ionisation electrode.

REASSEMBLY

Use the supplied rod in the compartment to reassemble the turbines. Place the pointed end of the rod inside the hole on the turbine end. Once inside the tube, push until the turbine contact the tube. Pull back the rod and withdraw 2 cm first before giving it ¼ turn. If the rod unhooks during the procedure, pull out the turbine with the hook and repeat all the aforementioned steps.

60 KW BURNER FOR FGX 60 AND 70 MODELS

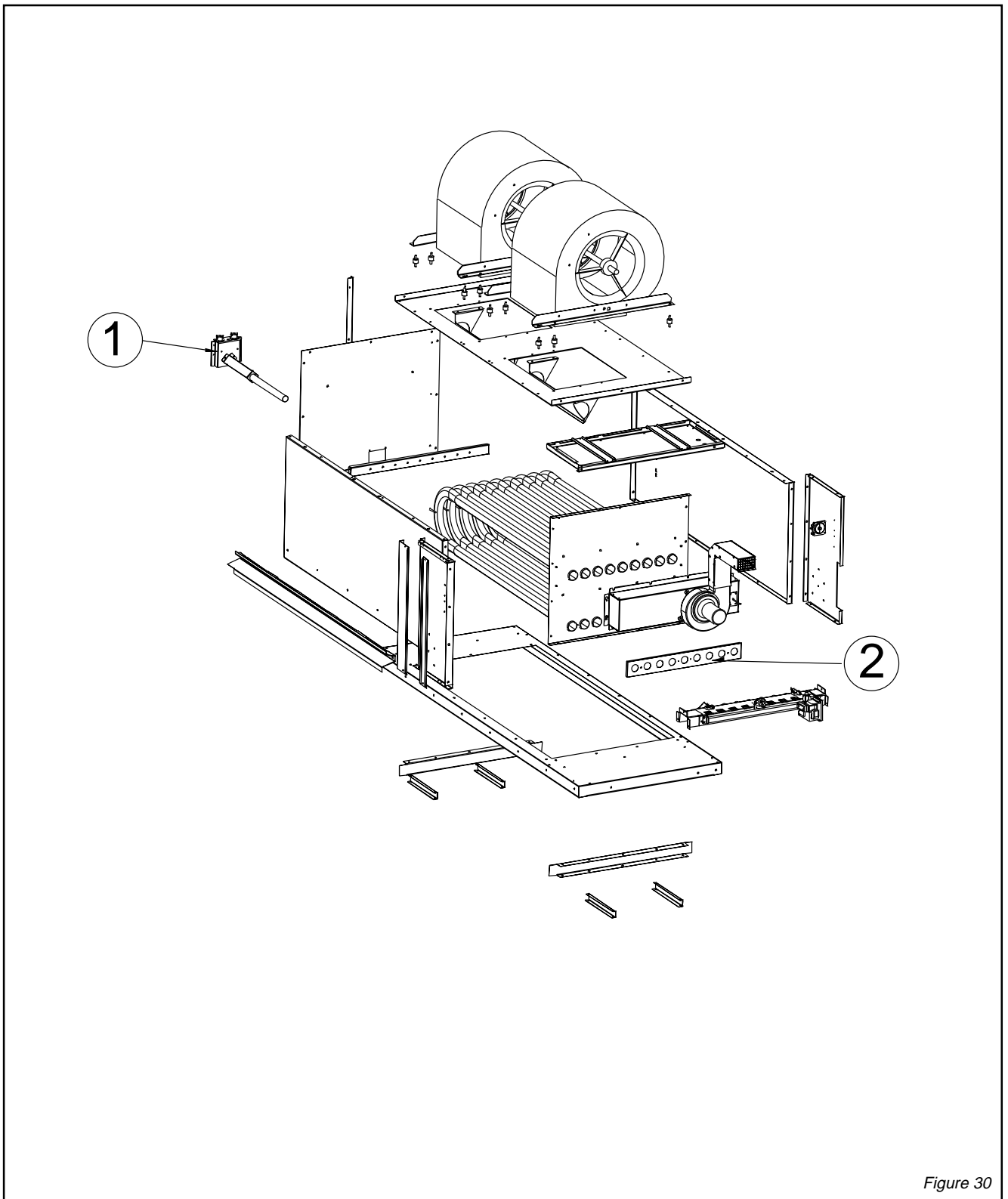

Figure 30

120 KW BURNER FOR FGX 60, 70 AND 100 MODELS

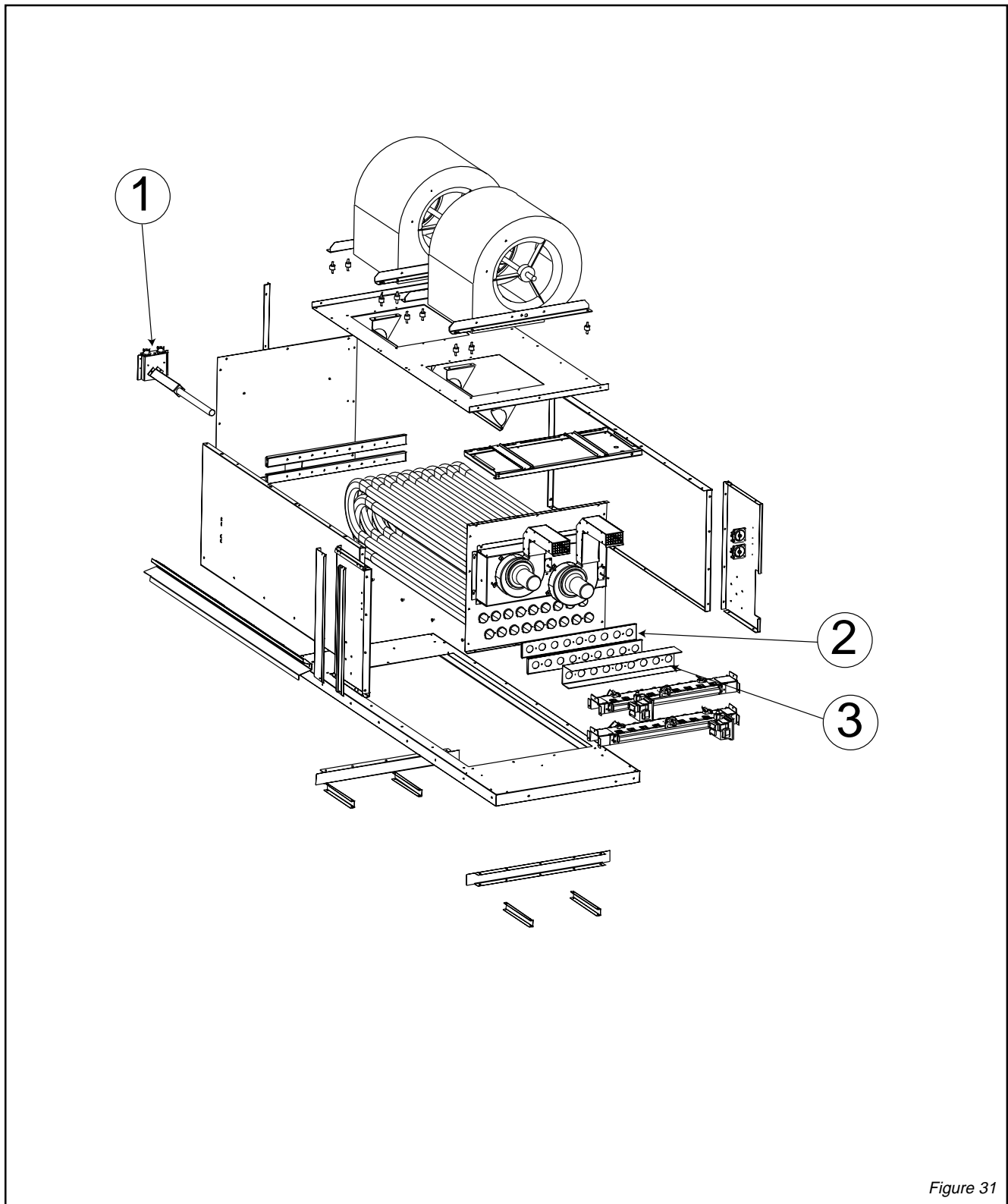

Figure 31

180 KW BURNER FOR FGX 120 AND 140 MODELS

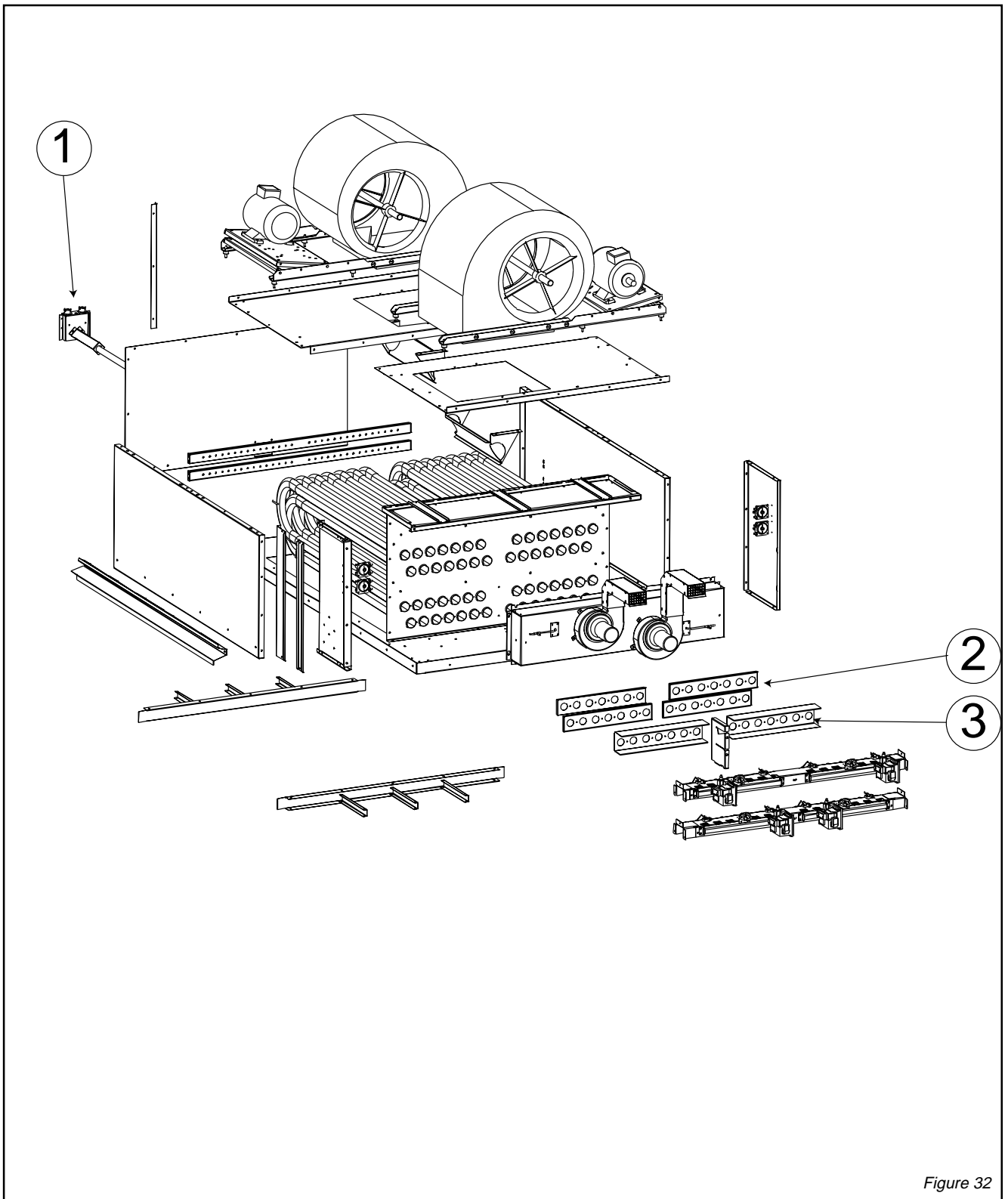

Figure 32

On delivery, the drive belts are new and correctly tensioned. After the first 50 operating hours check and adjust the tension. 80% of the total elongation of belts is generally produced during the first 15 hours of operation.

Before adjusting the tension, make sure that the pulleys are correctly aligned.

To tension, adjust the play of screw Mx.

The recommended deflection is 16 mm per metre from centre to centre.

Check that according to the diagram below (figure 34), the following ratio remains the same.

$$\frac{P \text{ (mm)}}{A \text{ (m)}} = 16$$



Figure 33

The belts should always be replaced when :

- the disk is set to maximum,
- the belt rubber is worn or the wire is visible.

Replacement belts must have the same rated size as the ones they are replacing. If a transmission system has several belts, they must all be from the same manufacturing batch (compare serial numbers).

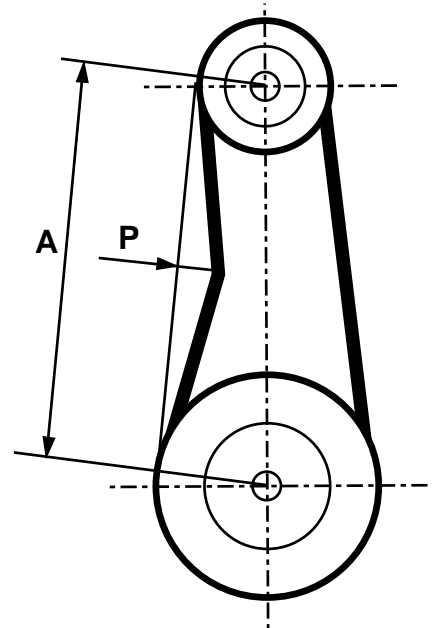
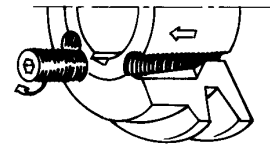

Figure 34

NOTE : An under-tensioned belt will slip, heat and wear prematurely. On the other hand, if a belt is over-tensioned, the pressure on the bearings will cause them to over-heat and wear prematurely. Incorrect alignment will also cause the belts to wear prematurely.

FAN PULLEY REMOVAL

Remove the 2 screws and put one of them in the extraction threaded screw.



Screw in fully. The hub and the pulley will separate from each other.

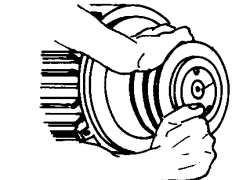

Remove the hub and the pulley by hand without damaging the machine.

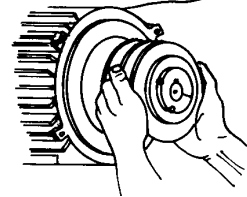
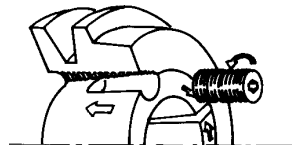

Figure 35

FAN PULLEY INSTALLATION

Clean and de-grease the shaft, hub and conical bore of the pulley. Lubricate the screws and install the hub and pulley. Position the screws without turning them.



Place the assembly on the shaft and screw in the screws alternatively and evenly. Using a mallet or a hammer with a wooden wedge, tap on the face of the hub to keep the assembly in place. Torque the screws to 30 Nm.

Take the pulley in both hands and shake it vigorously to make sure everything is in place.

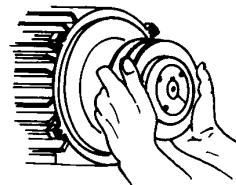

Fill the holes with grease for protection.

NOTE : During installation, the key should never protrude out of its groove.

After 50 operating hours, check that the screws are still in place.

PULLEY MOTOR INSTALLATION AND REMOVAL

The pulley is held in position by the key and a screw located in the groove. After unlocking, removing this screw by pulling against the shaft spindle (if necessary, use a mallet and tap uniformly on the hub to remove it). To assemble, proceed in the reverse order after having cleaned and de-greased the motor shaft and the pulley bore.

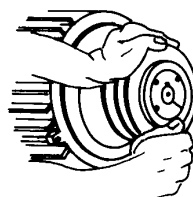

Figure 36

ALIGNMENT

After adjusting one or both of the pulleys, check the transmission alignment using a ruler placed on the inner face of the two pulleys.

NOTE: The warranty may be affected if any major modification is made to the transmission without obtaining our agreement beforehand.



Figure 37

The CLIMATIC™ 'Comfort' control Display allows an untrained person to easily operate a Lennox Roof-Top. This display connects to a single Rooftop and, through the use of the control keys, LED's and display the user can see how the connected Rooftop is operating, whether there are any faults, modify the comfort setpoint and override the Rooftop operation. If installed correctly the CLIMATIC™ "Comfort" control display can be installed up to 1000 m away from the Rooftop unit.

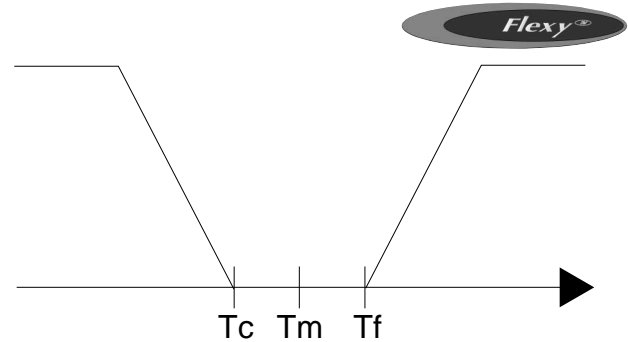

DISPLAY (1 - figure 39)

In 'Automatic' operation the comfort setpoint is displayed in the event of a fault detected on the unit an error code is automatically displayed.

The + / - keys (2) are used to change the heating/cooling/operating setpoints.

The LED (3) indicates the current operating mode :

- In 'Automatic' mode, i.e. in the programmed time schedules, the LED flashes,
- In forced occupied mode, the LED is permanently on
- In forced unoccupied mode, the LED is off.

Forced Occupied Key (4)

Pressing this key will override the Automatic control and force the unit to run in its "Occupied" mode. Whilst in this mode the LED (3) will remain permanently on. To return to "Automatic" mode press button (6) when the LED (3) will flash again.

Forced Unoccupied Key (5)

If, to save energy, the installations are not used within a period programmed for automatic use, it is possible, by pressing this key, to force the unit into its to "unoccupied" mode. The LED (3), which was previously flashing or lit, will now go out.

Automatic Operation Key (6)

If the system was previously set to forced occupied mode (LED (3) lit) or forced unoccupied mode (LED (3) off), this key allows you to return to the automatic programmed mode. The LED will flash.

NOTE : 'Forced' modes will automatically be re-set at 00:00h

LED (7) Indicates whether the unit is operating or not.

LED (8) Indicates that the filters are dirty.

LED (9) Indicates a general fault has been detected by the CLIMATIC™. Refer to the "Fault codes" section of this manual.

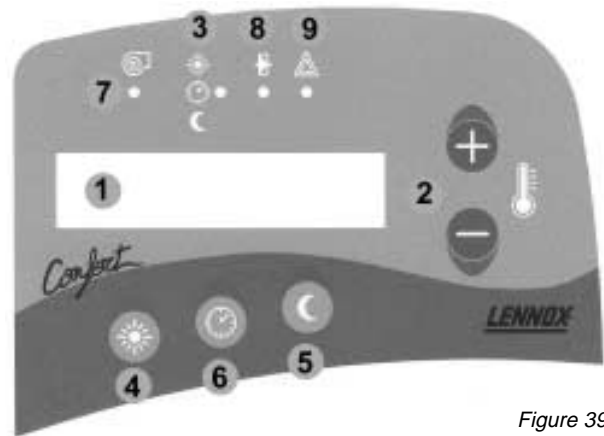

Figure 39

KP17 COMFORT CONTROL DISPLAY WIRING

Failure to install the Comfort control display with the recommended cable may cause the display to malfunction. The KP17 remote must be connected to the CLIMATIC™ using a 4 x 0.5 mm² braid-screened cable. This connection is provided through a remote interface card which is located within the Control panel section. Refer to the wiring section of this manual.

This display unit allows you to read and modify all the values of the variables or setpoints of the rooftop to which it is connected.

The dialogue with the controller is initiated by the CLIMATIC™. If, after 3 attempts, no communication is established, a message will be displayed signalling the problem. The unit will then try to re-connect at regular intervals.

NOTE : If your ROOFTOP already has a KP17 Comfort display connected (see previous section) simply disconnect it and connect this panel to the same location, once completed re-connect the KP17. It is not necessary to switch off the power to the CLIMATIC™ whilst the KP02/KP17 is being changed.

CALLOUT :

- 1 LIQUID CRYSTAL DISPLAY
- 2 RAISE/LOWER KEYS
- 3 "FILTER" LED (flashing red)
- 4 "ADDRESS" KEY
- 5 "MODE" KEY
- 6 "VALUE" KEY
- 7 "UNIT RUNNING" LED
- 8 "MODE" LED
- 9 "GENERAL ALARM" LED.

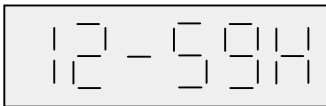

Figure 40

1 - DISPLAY FORMATS

Hour

Default display. If the display unit has been inactive for 5 minutes, this screen will automatically be displayed.



<--> 12 hours and 59 minutes

Date

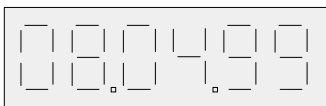

<--> 8 April 1999

Variable or setpoint address



Variable or setpoint value

Digital Values



1 <--> ON

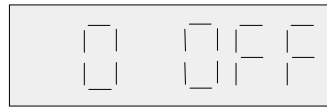

0 <--> OFF

Temperatures

Temperatures are displayed in °C, to an accuracy of 0.1 °C



<--> -21.6 °C



<--> + 105.8 °C

Pressures

Pressure is given in bars, to an accuracy of 0.1 bar.



<--> 18.3 bars

Other analog values

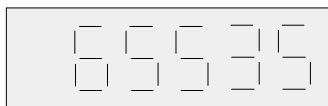

Valeurs displayed

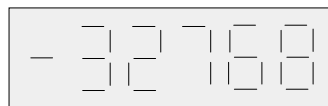

Values non displayed

Specific Displays

Software Version

When the unit is powered up, the KP02 software version number is displayed.

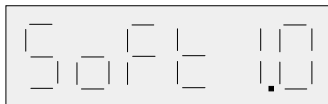

<--> version 1.0 (for example)

Display Test

The display can only be tested for correct operation when the unit is powered up and by pressing on the 3 keys "A", "M" and "-" simultaneously. If the display is working correctly, the following will be displayed :



All digits are properly displayed.

Communication Error

If there is no communication between the KP02 display unit and the CPU card, the following message is displayed :

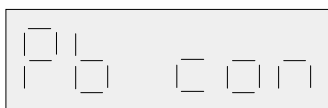

<--> "Communication problem"

2 - OPERATING MODES

The maintenance display allows for 4 modes of operation. Key **[M]** allows you to move successively and in a loop from one mode to the next.

The current mode is indicated by the status of LEDs **[V]** and **[C]** :

Status of LEDs associated with current mode :	[V]	[C]
A. The variable mode allows you to read the values of variables	lit	not lit
B. The setpoint mode allows you to change the settings	not lit	lit
C. The read date mode allows you to view the time and the date	not lit	not lit
D. The date setting mode allows you to change the time and the date	lit	lit

A : VARIABLES MODE

Pressing key **[A]** displays the address of the variable being read.

To go to a higher address, press **[A]** while simultaneously pressing on **[+]**.

The address will increase slowly by pressing **[+]** intermittently or more quickly by keeping your finger on the key.

To go to a lower address, proceed as above but with the **[-]** key.

When the required address appears, press **[V]** to display the variable value. If you do not press any key, the display will automatically return after a minute. The variables are updated every second.

B : SETPOINTS MODE

The setpoint address can be chosen in the same way as for the variable address (see above).

When the address of the required setpoint appears, pressing **[V]** will likewise display the current value.

To increase the setpoint press **[V]** while holding down the **[+]** key at the same time.

The address will increase slowly by pressing **[+]** intermittently or more quickly by keeping your finger on the key.

To go to a lower setpoint, proceed as above but with the **[-]** key as well as the **[V]** key.

The new value is applied when **[V]** is released.

PASSWORD

Access to all the setpoints is password-protected. Enter the password before making changes.

To do so, following the above procedure : go to address setting n° 0 and enter the number corresponding to your password.

If the password code is correct, the following message will appear when key **[V]** is released :



If the keypad has been inactive for 5 minutes, the password is reactivated. You must therefore enter it again to continue making changes to the setpoint values.

C : DATE READING MODE

One of the following modes

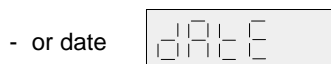

can be chosen by pressing **[A]** and briefly pressing on **[+]** or **[-]**.

Pressing **[V]** will display the value of the data selected, otherwise it will automatically be displayed after a minute.

D : DATE SETTING MODE

This mode allows the 6 date modes to be set :

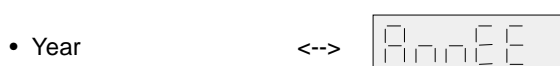
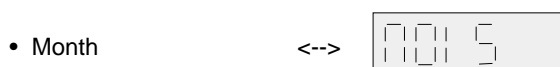
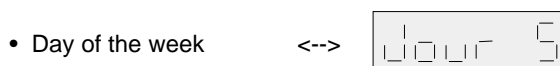
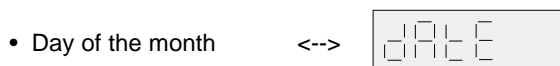
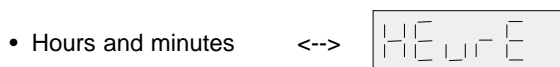

In the same way as for the setpoints, the value can be increased by simultaneously pressing on keys **[V]** and **[+]** and they can be decreased by simultaneously pressing on **[V]** and **[-]**.



For different types of data, the setting ranges are as follows :

Item	Minimum value	Maximum value
Hours and minutes	00-00H	23-59 H
Day of the month	1	31
Day of the week	1	7
Month	1	12
Year	0	99

Changes are only incorporated when key **[A]** is pressed.

NOTE : The compatibility of the value for the day of the month is not checked when it is entered. You might therefore enter February 31st but when you try to validate, it will be ignored and the preceding value stored.

3 - POWER SUPPLY (LED 7 - figure 40)

When lit, the LED indicates that the machine is powered up.

4 - MODE (LED 8 - figure 40)

This LED indicates the current operating mode.
 In normal mode, i.e. within the programmed schedules, the LED flashes.
 In forced day mode, the LED is permanently on and in forced night mode, the LED is off.

5 - FILTER DIRTY (LED 3 - figure 40)

This LED indicates that the CLIMATIC™ has detected that the filter is blocked.

6 - GENERAL FAULT (LED 9 - figure 40)

This LED indicates a general fault has been detected.
 Refer to the "Fault codes" section of this manual.



LIST OF SETPOINTS

1st Level

		Min.	Factory	Maxi.
0	Password to access level 2 setpoints and variables	0	#	255
1	Temperature, required setpoint for room, day mode	8.0	21.0	35.0
2	(Used by KP17 only) KP17 Remote control, override, occupied mode	Off	Off	On
3	(Used by KP17 only) KP17 Remote control, override, automatic mode	Off	Off	On
4	(Used by KP17 only) KP17 Remote control, override, unoccupied mode	Off	Off	On
5	Fault reset	Off	Off	On
6	Remote control, On / Off, unit	Off	Off	On
7	(Special software request) Remote control, On / Off, customer output KP12/2	Off	Off	On
8	(Used for setting up different time zones) Mode, Selection 0 = Day 1 = Week-end 2 = Night 3 = 4 = Morning 5 = Midday 6 = Evening 7 = BMS	0	0	7
9	Defines end of weekend/Start of week (1 = Sunday, 2 = Monday, etc) Mode, day of the week, start of mode	1	#	7
10	(Used with setpoint 8 - mode selection - to define the hour of the start time) Mode, hour, start of mode	0	#	23
11	Used with setpoint 8 - mode selection - to define the minute of the start time Mode, minute, start of mode	0	#	59
12	Defines end of week/Start of weekend (6 = Friday, 7 = Saturday, etc) Mode, day of the week, end of mode	1	#	7
13	Used with setpoint 8 - mode selection - to define the hour of the stop time Mode, hour, end of mode	0	#	23
14	Used with setpoint 8 - mode selection - to define the minute of the stop time Mode, minute, end of mode	0	#	59
15	Defines day mode deadzone, other time zones = cooling setpoint) Mode, temperature, room cooling setpoint	8.0	#	35.0
16	Defines day mode deadzone (other time zones = heating setpoint) Mode, temperature, room heating setpoint	8.0	#	35.0
17	(FLEXY™ only) On = Absolute humidity (g/kg) / Off = Relative humidity (%)	Off	Off	On
18	(FLEXY™ only) Mode, relative humidity (%), room minimum setpoint required	0	#	100
19	(FLEXY™ only) Room mode, Relative humidity (%), maximum setpoint required	0	#	100
20	(FLEXY™ only) Mode, Absolute humidity (g/kg), room minimum setpoint required	0.0	#	30.0
21	(FLEXY™ only) Mode, Absolute humidity (g/kg), room maximum setpoint required	0.0	#	30.0
22	Mode, Percentage, Minimum fresh air	0	#	100
23	Mode, Fan activity in control zone (cooling mode/heating mode)	Off	#	On
24	Mode, Fan activity in dead zone	Off	#	On
25	(Special application request only) Mode, Fan automation, dead zone	Off	#	On
26	(FLEXY™ only) Mode, Fan low speed, control zone	Off	#	On



		Min.	Factory	Maxi.
27	(FLEXY™ only) Mode, Fan low speed, dead zone	Off	#	On
28	(FLEXY™ only) Mode, Fan low speed automation	Off	#	On
29	(on = unit runs at maximum 50% during "night mode") Mode, Low noise	Off	#	On
30	(J-BUS only) Remote control, override, Mode	Off	Off	On
31	(J-BUS only) Remote control, Override, Low fan speed	Off	Off	On
32	(J-BUS only) Remote control, Override damper with recycled air	Off	Off	On
33	(J-BUS only) Remote control, Override damper with minimum fresh air	Off	Off	On
34	(J-BUS only) Remote control, Override damper with fresh air	Off	Off	On
35	(J-BUS only) Remote control, Override 50% load limit	Off	Off	On
36	(J-BUS only) Remote control, Override heating cancellation	Off	Off	On
37	(J-BUS only) Remote control, Override cooling cancellation	Off	Off	On
38	(J-BUS only) Remote control, Override electrical heaters cancellation	Off	Off	On
39	On = Electrical heaters during defrosting	Off	On	On
40	(Alarm only) Room temperature, low setpoint	5.0	10.0	20.0
41	(Alarm only) Room temperature, high setpoint	20.0	40.0	40.0
42	Room relative humidity (%), low setpoint	0	0	50
43	Room relative humidity (%), high setpoint	50	100	100
44	Room absolute humidity (g/kg), low setpoint	0.0	0.0	30.0
45	Room absolute humidity (g/kg), high setpoint	0.0	30.0	30.0
46	Temperature, Curved gradient of anticipated speed	0.0	10.0	20.0
47	(0 = Start at times set in "modes" only, no anticipation start Value, Gradient of anticipated speed	0	12	100
48	Quantity of CO2, Ppm, minimum fresh air	0	1000	2000
49	Quantity of CO2, Ppm, maximum fresh air	0	1500	2000
50	Percentage, Fresh air damper opening before fan will start	0	10	100

2nd Level

		Min.	Factory	Maxi.
51	Maximum temperature, required setpoint for room, day mode	21.0	27.0	35.0
52	Minimum temperature, required setpoint for room, day mode	8.0	17.0	21.0
53	(Compressor minimum run time in seconds)	25	180	1800
54	Differential temperature, engaged heat setting	0.0	1.0	10.0



		Min.	Factory	Maxi.
55	Differential temperature, heating setting between 2 steps	0.1	1.0	10.0
56	Differential temperature, engaged cooling setting	0.0	1.0	10.0
57	Differential temperature, cold setting between 2 steps	0.1	1.0	10.0
58	(Not used - special option only) On = Compressors then chilled water coil, room setting	Off	Off	On
59	On = Heat pump and/or sas then hot water coil or elec. heat, room setting	Off	On	On
60	On = Gas then heat pump, room setting	Off	Off	On
61	On = Supply setting on	Off	Off	On
62	Time, sampling of supply setting (integration delay)	1	10	120
63	On = Compressors then chilled water coil, supply setting	Off	Off	On
64	On = Heat pump and/or gas then hot water coil or elec. heat, supply setting	Off	Off	On
65	On = Gas then heat pump, supply setting	Off	Off	On
66	(Not used - Future facility) - Reserved On = constant supply air temperature via air damper modulation	Off	Off	On
67	(FLEXY™ only) Time, Sampling of humidity setting	1	10	120
68	(FLEXY™ only) Humidity range (%), humidity setting	1	5	50
69	(FLEXY™ only) Differential humidity (%), Engaged dehumidity setting	1	5	50
70	(FLEXY™ only) Differential humidity (%), Dehumidity setting between 2 steps	1	5	50
71	Supply temperature, low setpoint, 1st level	setpoint 72 +2.0	8.0	19.0
72	Supply temperature, low setpoint, 2nd level	setpoint 73 +2.0	6.0	17.0
73	Supply temperature, low setpoint, 3rd level	1.0	2.0	15.0
74	Supply temperature, high setpoint, 1st level	20.0	40.0	70.0
75	Supply temperature, high setpoint, 2nd level	setpoint 74	60.0	70.0
76	Temperature, Outside air minimum setpoint, (Outdoor air <Setpoint 76 = No free cooling, Min % fresh air)	0.0	5.0	30.0
77	Temperature, Outside air maximum setpoint, (Outdoor air >Setpoint 77 = 50 % compressors OFF in cooling)	0.0	26.0	60.0
78	(Not used - future facility) - Percentage, maximum fresh air, Damper modulation to provide constant supply air temperature	0	60	100
79	Outside air temperature, setpoint, 50% compressor (Outdoor air <Setpoint 79 = 50 % compressors stop)	10.0	12.0	30.0
80	Outside air temperature, setpoint, 100% compressor (Outdoor air <Setpoint 80 = ALL compressors stop)	10.0	12.0	30.0
81	Icing temperature setpoint, evaporator coil	-5.0	-1.0	3.0
82	Defrost temperature setpoint, evaporator coil	5.0	10.0	15.0
83	Delay, icing setpoint, evaporator coil	1	360	600
84	Outside air temperature, setpoint, 100% compressor heatpump (Outdoor air <Setpoint 84 = ALL compressor stop)	-50.0	-20.0	20.0
85	Outside temperature, setpoint, authorised defrosting, condenser coil	8.0	10.0	20.0
86	(on LINEA™ only)* - (R22 = -3, R407C = 1) Battery temperature, setpoint, authorised defrosting, condenser coil	-10.0	-3.0	6.0

* : LINEA is another range of LENNOX ROOFTOP. For more information, please consult your regional office



		Min.	Factory	Maxi.
87	Coefficient, icing time, condenser coil	0	3	12
88	Number, condenser restart, condenser coil	1	1	8
89	Low temperature, setpoint, air/water cooled heat exchanger (non standard)	4.0	5.0	20.0
90	High temperature, setpoint, air/water cooled heat exchanger (non standard)	20.0	45.0	46.0
91	Outside temperature, setpoint, 100% electrical heater discharge (Outdoor air > Setpoint 91 = electric heater stop)	-20.0	10.0	30.0
92	Sensing setpoint, air flow cutout	0.0	0.2	5.0
93	Sensing setpoint, clogged filters	0.0	2.5	5.0
94	Sensing setpoint, missing filters	0.0	0.5	5.0
95	KP17 = on = On/Off unit	Off	Off	On
96	Delay, closing, KP 12-2 "Day" input	4	60	65535
97	Delay, Opening, KP 12-2 "Day" input	2	300	65535
98	Unit type	0	0	65535
99	On = "LINEA™" series, Off = "FLEXY™" series	Off	#	On
100	On = Low ambient Option fitted (Disable setpoints 79 & 80) (Off = Enable setpoints 79 & 80)	Off	#	On
101	(FLEXY™ only) On = Advanced Control Pack option fitted	Off	#	On
102	Slave J-Bus, number	1	1	10
103	Link, number	0	0	7
104	All setpoint values override to factory default EPROM values (centre column)	Off	Off	On
105	Test stages (for factory test procedures only reduces all delay timers to 0)	0	0	65535

* : LINEA is another range of LENNOX ROOFTOP. For more information, please consult your regional office



VARIABLE LIST *(june 2001)*

1st Level

0	Error code
1	Temperature, room
2	Relative humidity (%),room
3	Temperature, outside air
4	Relative humidity (%), outside, air
5	Temperature, supply Air
6	Temperature, chilled water battery
7	Temperature, compressor, no. 1
8	Temperature, compressor, no. 2
9	Temperature, compressor, no. 3
10	Temperature, compressor, no. 4
11	Temperature, condenser, no. 1
12	Temperature, condenser, no. 2
13	Temperature, condenser, no. 3
14	Temperature, condenser, no. 4
15	Temperature, air/water cooled heat exchanger, water outlet
16	Pressure, air flow (mb)
17	Air quality sensor, CO ² (ppm)
18	Pressure, compressor, no. 1
19	Pressure, compressor, no. 2
20	Pressure, compressor, no. 3
21	Pressure, compressor, no. 4
22	Volt free contact, remote control, unit Off
23	Volt free contact, remote control, forced occupied mode
24	Volt free contact, remote control, forced unoccupied mode
25	Volt free contact, remote control, 50% load limit
26	Volt free contact, remote control, heating disable
27	Volt free contact, remote control, cooling disable
28	Volt free contact, remote control,low ventilation speed
29	Auxiliary contact, blower fan
30	Volt free contact, error, DAD board, detected smoke
31	Auxiliary contact, compressor, no. 1
32	Auxiliary contact, compressor, no. 2
33	Auxiliary contact, compressor, no. 3
34	Auxiliary contact, compressor, no. 4
35	Pressure switch, compressor, no. 1, low pressure
36	Pressure switch, compressor, no. 2, low pressure
37	Pressure switch, compressor, no. 3, low pressure
38	Pressure switch, compressor, no. 4, low pressure
39	Auxiliary contact, condenser fan, no. 1
40	Auxiliary contact, condenser fan, no. 2
41	Auxiliary contact, condenser fan, no. 3
42	Auxiliary contact, condenser fan, no. 4
43	Volt free contact, air/water cooled heat exchanger, water flow regulator
44	Auxiliary contact, pump (hot water coil - frost protection pump)
45	Auxiliary contact, electrical heater, no. 1
46	Auxiliary contact, electrical heater, no. 2
47	Auxiliary contact, gas grade, no. 1
48	Auxiliary contact, gas grade, no. 2
49	Volt free contact, humidifier, error, control & setting board
50	Volt free contact, leak water
51	Volt free contact, information, miscellaneous source
52	Output, supply fan



53	Output, low speed supply fan
54	Output, Extract fan
55	Output, compressor, no. 1
56	Output, compressor, no. 2
57	Output, compressor, no. 3
58	Output, compressor, no. 4
59	Output, compressor, no. 1, hot gas injection valve
60	Output, compressor, no. 1, cycle reversing valve
61	Output, compressor, no. 2, cycle reversing valve
62	Output, compressor, no. 3, cycle reversing valve
63	Output, compressor, no. 4, cycle reversing valve
64	Output, condenser fan, no. 1
65	Output, condenser fan, no. 2
66	Output, condenser fan, no. 3
67	Output, condenser fan, no. 4
68	(FLEXY™ only) - Output, pump
69	Output, electrical heater, no. 1, 1st level
70	Output, electrical heater, no. 1, 2nd level
71	Output, Electrical Heater, no. 2
72	Output gas grade, no. 1, 1st level
73	Output, gas grade, no. 1, 2nd level
74	Output, gas grade, no. 2
75	Output, humidifier
76	Output, miscellaneous
77	Proportional action, economiser
78	Proportional action, chilled water battery
79	Proportional action, hot water battery
80	Proportional action, electrical heaters, static relays
81	Proportional action, humidifier
82	Status, supply fan
83	Status, damper
84	Status, chilled water coil
85	Status, hot water coil
86	Status, compressor, no. 1
87	Status, compressor, no. 2
88	Status, compressor, no. 3
89	Status, compressor, no. 4
90	Status, condenser fans
91	Status, pump
92	Status, electrical heaters
93	Status, gas
94	Status, humidifier
95	Room setpoint, minimum setting, heating
96	Room setpoint, maximum setting, cooling
97	Room setpoint, minimum power point, heating
98	Room setpoint, maximum power point, cooling
99	Setpoint, supply setting
100	Setting, minimum power point, heating, supply
101	Setting, maximum power point, cooling, supply
102	Setting, minimum setpoint, humidification, room
103	Setting, maximum setpoint, dehumidification, room
104	Setting, minimum power point, humidification, room
105	Setting, maximum power point, dehumidification, room
106	Function, operational conditions
107	On = Special software
108	Version number, Software

This display unit allows you to operate 1 to 8 machines. The icon and schematic display provides a vivid and user-friendly interface. It uses a liquid crystal monochrome display, with background lighting, consisting of 240 x 128 pixels. It has 2 LEDs and 12 keys.

The remote console must be connected to the unit using a 4 x 0.5 mm² braid-screened cable (maxi length is 1000 m).

Plan the console electric supply in 230V/50Hz (500 mA)

On the unit, connection to the KP01 card J18 input will be done with connection items (screws...) delivered with the console.

ITEMS :

- 1 LCD SCREEN, 240x128 PIXELS, MONOCHROME, BACKGROUND LIGHTING
- 2 5 KEYS FOR FIXED FUNCTIONS
- 3 7 "SCREEN" KEYS FOR VARIOUS FUNCTIONS
- 4 "ON" LED
- 5 "GENERAL ALARM" LED.

The main display unit functions are as follows :

- Control of a range of interactive screens allowing access to all information and control data.
- Continual resetting of all dynamic parameters displayed in the various screens.
- Recording of successive status of pre-defined variables to create analog and event histories.

A KP07 unit can be attached to more than 8 LENNOX Rooftops, providing they have the same software.

The link between the controllers and the display is serial and uses the JBUS protocol. After being connected, the unit tries to establish communication with the specified machines. If, after 3 attempts, the unit cannot communicate with the Rooftop(s), the latter will be "disconnected". The connection failure is displayed on the screen and recorded in the event history. The display unit will then try to re-connect at regular intervals.

NOTE : To adjust the screen contrast, please consult the end of this part.

1 - SCREEN KEYS WITH VARIABLE FUNCTIONS (figure 41)



Figure 41

There are 7 keys located around the LCD screen :



The function of these keys may vary from one screen to another and is defined on the active screen by an icon. In the case of keys [1], [2], [3] and [4], the icon is displayed above the key. For the 3 other keys [A], [B] and [C], the icon appears to their left.

Each key allows you to :

- Proceed to another screen, or
- Write a value in a given variable.

2 - FIXED KEYS (FIGURE 41)

The functions of these 5 keys are fixed :



PAGE DOWN :

Moves to the next page of the same screen type.



PAGE UP :

Returns to the previous page of the same screen type.



STRUCTURE :

Returns to the first screen (showing the structure).



PREVIOUS SCREEN :

Returns to the screen previously displayed



MODIFICATION :

Pressing on this key activates the "modification" mode (see below).

3 - ON (LED 4 - figure 41)

When lit, it indicates that the machine is powered up.

4 - GENERAL FAULT (voyant 5 - figure 41)

This LED indicates a general fault has been detected.

5 - "MODIFICATION" MODE

This mode allows you to change the values of all the variables displayed on the active screen. It uses the 4 keys "1", "2", "3" and "4" by attributing preset functions to them :

KEY / ASSOCIATED ICON



Selects the variable to be changed



Selects the number to be changed

(By pressing successively on the key the cursor will move from digit to digit, from right to left, then the cursor remains on the last digit of the value to be changed.)



Increases the number from 0 to 9



Confirms the current change.

Through "MODIFICATION" mode, the user is able to :

- choose the number of the controller he wishes to see the variables of (if several LENNOX Rooftops are attached to the same KP07 display unit),
- control the setpoints.

To exit "MODIFICATION" mode and return to the active screen, press the "MODIFICATION" key.

Note :

- During modification, the screen is no longer updated.
- If a change is not confirmed, the variable will retain its previous value.

CONTRAST SETTING

The display contrast can be set in "MODIFICATION" mode :

- Pressing successively on key **[A]** increases the contrast.
- Pressing successively on key **[B]** decreases the contrast.
- Key **[C]** allows you to find the default contrast.

GENERAL SCREEN LAYOUT

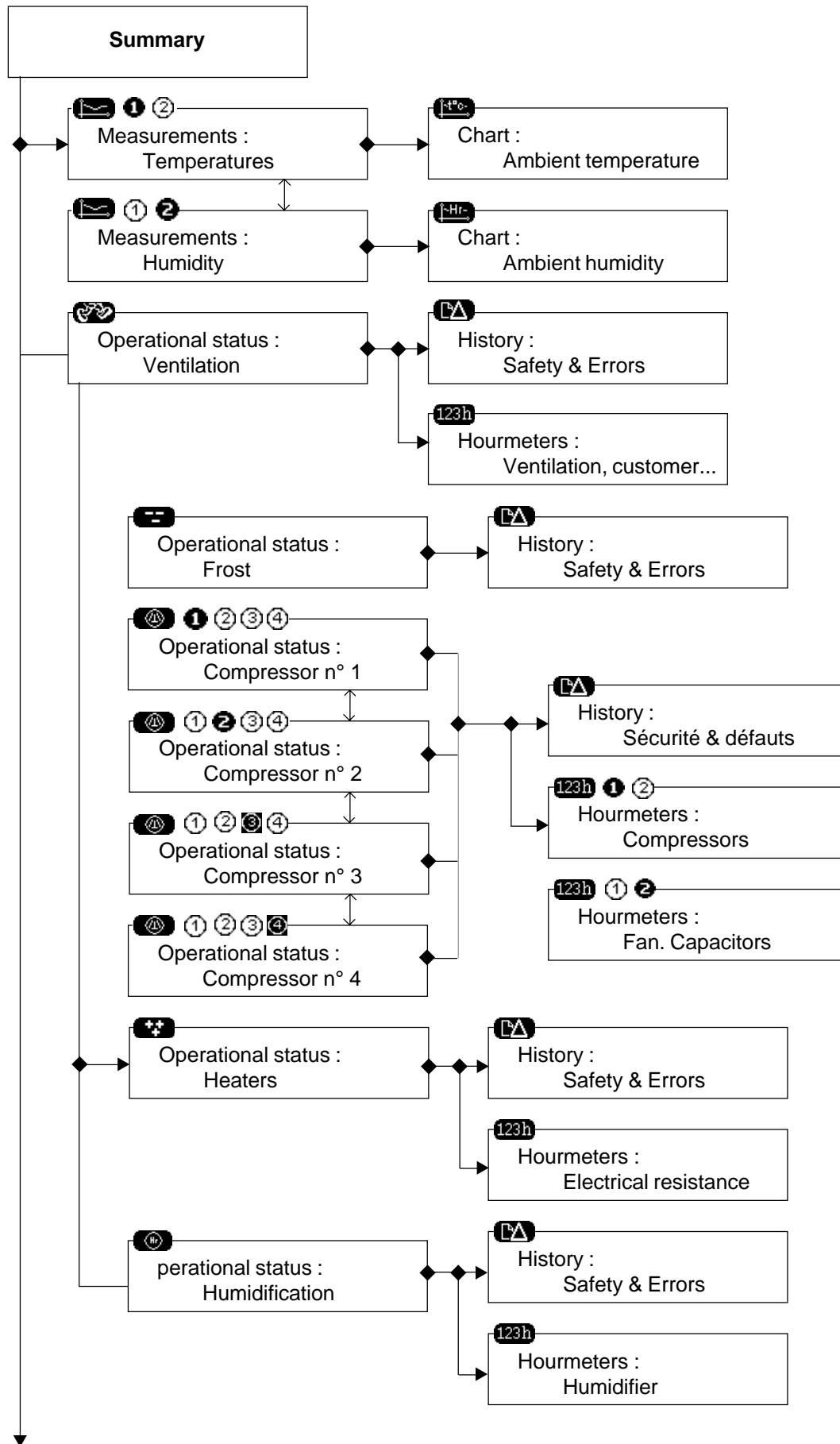

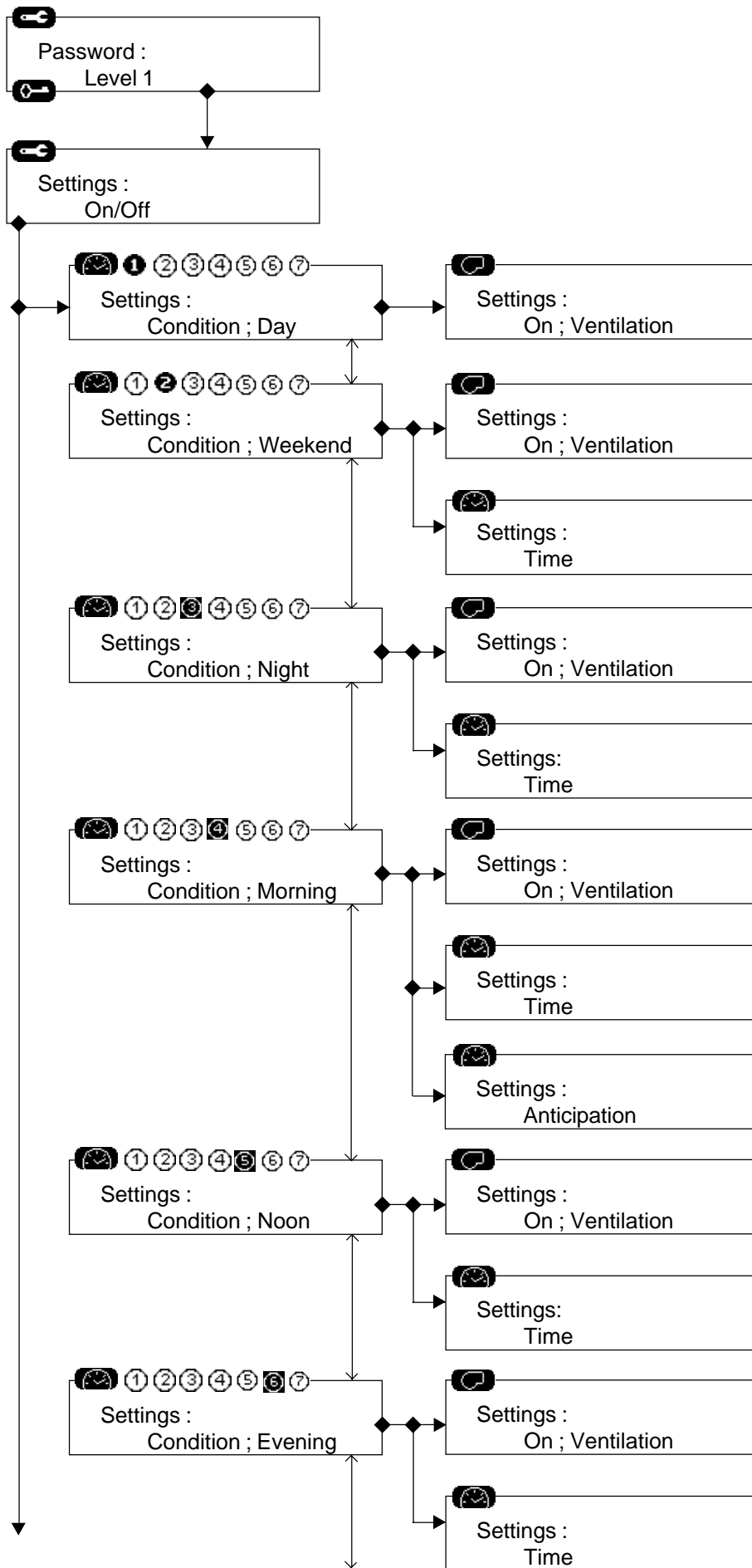

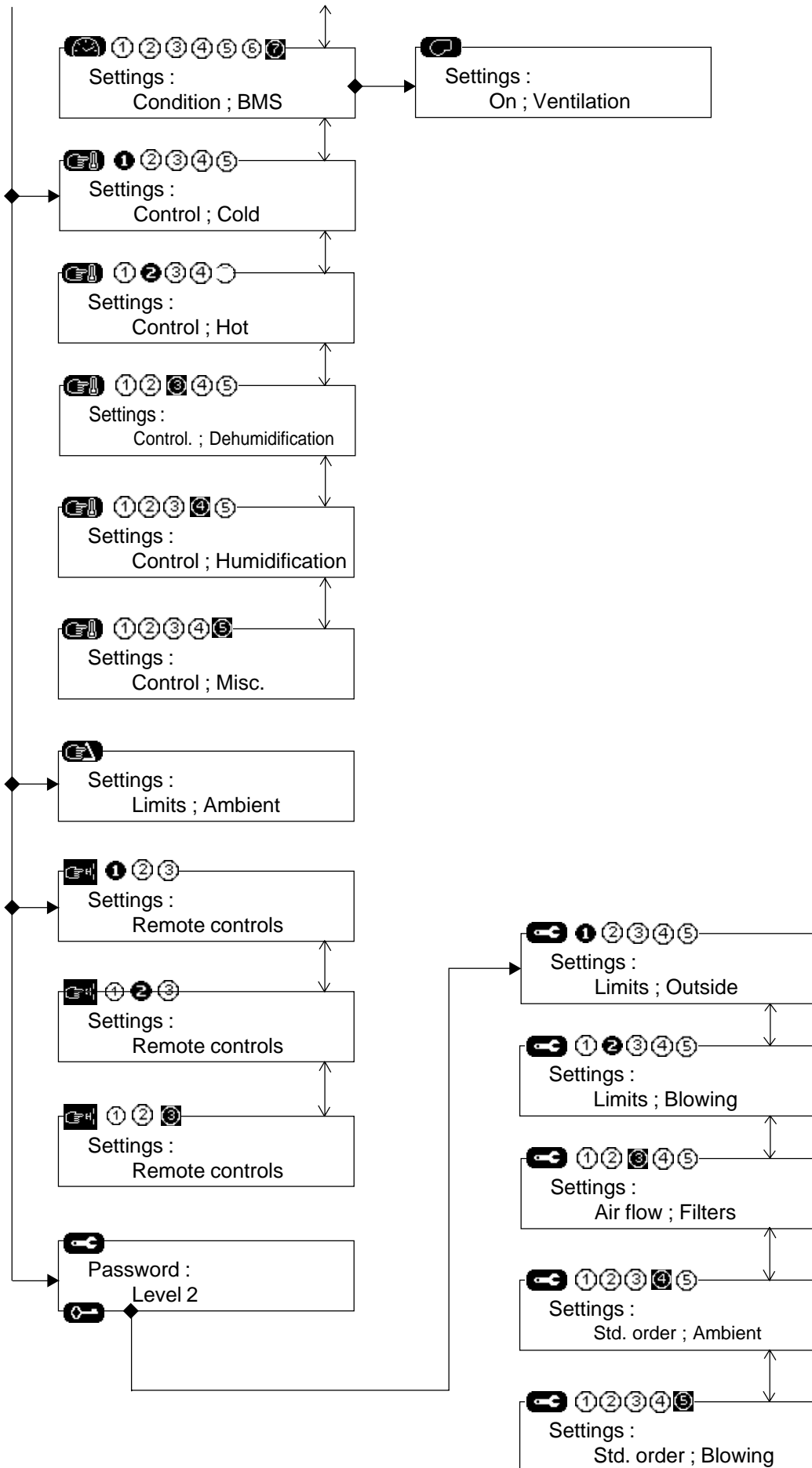

INDEX OF ICONS







Keys

	Select variable to change Select digit to change.
	Increase value
	Enter current change.
	Go to temperature and humidity values and charts.
	Go to the machine component status.
	Go to various notices.
	Go to room temperature chart.
	Go to room humidity chart (Flexy only)
	Reset errors and error meters.
	Go to error history.
	Go to operation hourmeters.
	Go to frosting component status.
	Go to compressor and condenser operational status.
	Go to heating devices operational status.
	Go to humidifier operational status (Flexy only)
	Enter password.
	Go to operational condition settings.
	Go to control settings.
	Go to safety settings.
	Go to On/Off and Discharge settings.
	Go to fan On/Off settings.
	Go to anticipation settings.







Logging on

	Log on password to go to settings.
	Log on date and time.











Sensors







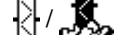

	Temperature sensor
	Humidity sensor
	Pressure sensor
	Return or room data
	Supply data
	Outside data

Operating conditions



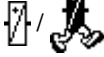





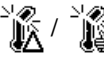

	Operating condition: Day
	Operating condition: Weekend
	Operating condition: Night
	Operating condition: Morning
	Operating condition: Noon
	Operating condition: Evening
	Operating condition: BMS

Operating status

	Cooling mode setting operation.
	Heating mode setting operation.
	Device in manual mode (prohibited under control)
	(On / Off) Customer option
	(On / Off) blower fan
	(High / Low) Ventilation speed (Flexy only)
	Filters
	(On / Off) Fresh air damper.
	(On / Off) Cold proportional valve, cold water battery
	(On / Off) Compressor

	Compressor defrosting.
	Compressor stopped in anti-short cycle.
	(On / Off) Condenser
	(On / Off) Gas grade.
	Half flow gas.
	(On / Off) Hot proportional valve, hot water valve.
	(On / Off) Electrical heaters.
	(On / Off) Humidifier
	(On / Off) Dehumidification
	(On / Off) Pump

Errors

	General alarm
	(Start / End) Communication interrupted between unit KP07 and a CPU board.
	(Start / End) [081][083][085][086][087][113] [123] [133] [143] Faulty temperature sensors.
	(Start / End) [082][084] Faulty humidity sensors (Flexy only)
	(Start / End) [112] [122] [132] [142] Faulty pressure transmitters (Flexy only)
	(Start / End) [013][022][096] Low temperature limit.
	(Start / End) [012][023][097] High temperature limit.
	(Start / End) [032] Low humidity limit (Flexy only)
	(Start / End) [033] High humidity limit. (Flexy only)
	(Start / End) [094] Error : only applicable to customer.



(Start / End) [091]
Faulty processing fan.



(Start / End) [001]
Wrong air flow.



(Start / End) [099]
Error smoke.

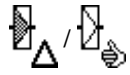

(Start / End) [004]
Dirty filters.



(Start / End) [005]
Missing filters.



(Start / End) [115][125][135][145]
Faulty high pressure or faulty electrical compressor.



(Start / End) [117][127][137][147]
Faulty low pressure compressor.



(Start / End) [092][093]
Faulty condensers.



(Start / End) [098]
Faulty water flow. (Flexy only)



(Start / End) [041]
Faulty pump. (Flexy only)

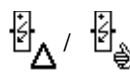

(Start / End) [011]
Faulty electrical batteries.



(Start / End) [014][015]
Faulty gas burner.

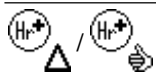

(Start / End) [031]
Faulty humidifier. (Flexy only)

This option is used for making a connection to the BMS only, by a set of hard contacts. It requires the addition of a KP05 card, if this is not already in place, and a KP12 card. Input connection must be by screened cable only.

Limits of relays :

- 10A – 250V with resistive load
- 4A – 250V with inductive load.

Input	Function
A	Instruction shift : A 0/20mA signal can be used to add a linear shift of 0 to 10 °C to the setpoint temperature (mid-point between air-conditioning and heating setpoint). If your command signal is a different type, our engineers can advise you on the type of interface to use before input to the CLIMATIC™
B	Unit on/off (ROOFTOP on when unit is off).
C	Contact - force night operation
D	Contact - force day operation
E	Contact - force operation at 50%.
F	Lock heating function
G	Lock air-conditioning function.
H	Feedback of information from an external client component

Output	Function
a	Signal filter fault
b	Signal fan fault
c	Signal compressor fault
d	Signal fault on gas burner or electric coil.
e	Signal supplying temperature greater than setpoint (Setpoint 74)
f	Signal supplying temperature less than setpoint (setpoint 71)
g	Command from an external client component

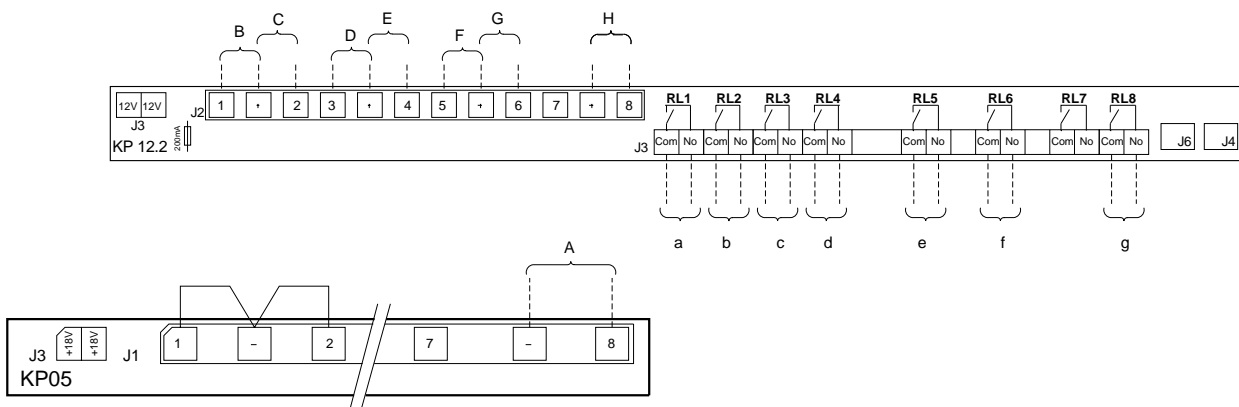

ON - OFF

The unit is declared On if setpoint 6 (C06) is ON.
 The unit can be stopped by a remote control command by hard contact.
 On KP12 extension card - see chapter on BMS contact kit.





For certain configurations a CLIMATIC™ system actuator can be used to control an external function (option: Client).
 The Client option is declared On if setpoint 7 (C07) is ON.

DEFINITION OF TIME SLOT PARAMETERS

The CLIMATIC™ allows you to programme 5 operating zones per day, in addition to an idle zone for the weekend.
 Slot activation is :

- automatically controlled by the CLIMATIC™, if you have defined these time parameters for each slot
- forced manually by action on the controller (instructions 02/03 and 04 for KP02).
- forced by the BMS contacts kit (see this chapter).
- forced by the computer connection.

The five available time slots are :

-  **WEEK-END**
-  **NIGHT**
-  **MORNING**
-  **NOON**
-  **EVENING**

If none of the time slots listed above is active, the active slot is :

-  **DAY**

A particular time slot :

-  **BMS** is activated if the unit is connected to a computer network.

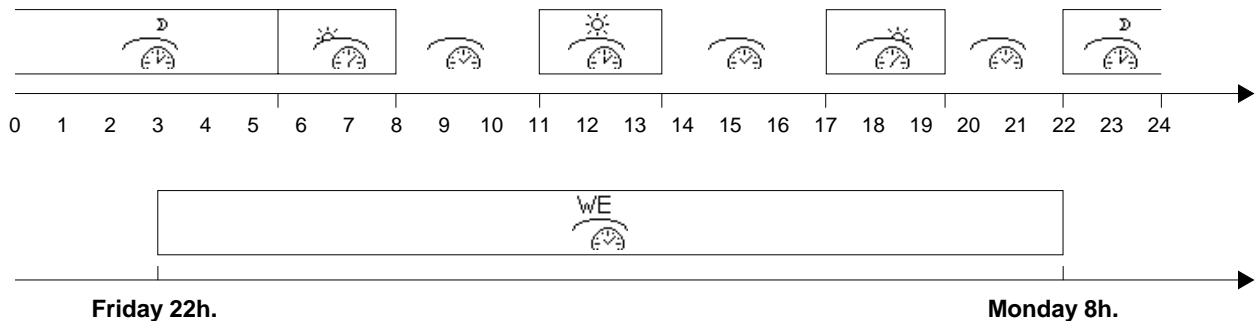

With the KP07 :

- Go directly to the screen concerning the time slot to be modified, enter the parameters described below on the screen (see organisation of screens in KP07chapter).

With the KP02 :

- The slot to be set up must first be defined by the 08 instruction. Enter the information below then return to the 08 instruction to go to the next slot.

DESCRIPTION OF PARAMETERS

Parameters are defined for the time slot. Select by instruction 08 setting.

0 = DAY / 1 = WEEKEND / 2 = NIGHT / 3 = unused / 4 = MORNING / 5 = MIDDAY / 6 = EVENING / 7 = BMS.

Instruction	Description
09	Day of the week of start of setting . From 1 to 7, 1 = Sunday.
10	Hour of start of setting
11	Minutes for start of setting
12	Day of the end of setting
13	Hour of end of setting
14	Minutes of end of setting
15	Setpoint in heating
16	Setpoint in air conditioning
17	Defined if the hygrometry values below are taken as absolute (ON) or relative (OFF).
18	Minimum relative humidity of ambient air (%)
19	Maximum relative humidity of ambient air (%)
20	Minimum absolute humidity of ambient air (g/kg of dry air)
21	Maximum absolute humidity of ambient air (g/kg of dry air)
22	Relative value of minimum flow of new air (%)
23	Fan operation in regulation zone *. ON on OFF off
24	Fan operation in neutral zone*. ON on OFF off
25	Automatic fan operation in neutral zone*. In this zone after operation in air-conditioning mode, the fan is off. If after one hour the ambient air is still in this zone the fan is started up again.
26	On ON, forces low speed fan operation in the regulation zone*.
27	On ON, forces low speed fan operation in the neutral zone*.
28	On ON, forces automatic low speed operation. If the unit is in air-conditioning or dehumidifying mode and less than 3 compressors are in use the fan then switches to low speed.
29	Low noise
30	Instruction used to force operation in the current setting

* The regulation zone is defined for a temperature less than the heating instruction or greater than the air-conditioning instruction. The neutral zone is between these 2 values.

NOTE : The end of the night slot night is defined by the start of the morning slot : this is why there is no need to define the end of the night slot in the table below

Setpoint value for KP02	DAY = 0	WEEK-END = 1	NIGHT = 2	MORNING = 4	MIDDAY = 5	EVENING = 6	BMS = 7
9	-	7	-	-	-	-	-
10	-	22	22	6	12	19	-
11	-	0	0	0	0	0	-
12	-	2	-	-	-	-	-
13	-	6	-	6	12	19	-
14	-	0	-	0	0	0	-
15	23.0	30.0	30.0	23.0	23.0	23.0	23.0
16	19.0	10.0	10.0	19.0	19.0	19.0	19.0
17	Off	Off	Off	Off	Off	Off	Off
18	0	0	0	0	0	0	0
19	100	100	100	100	100	100	100
20	0.0	0.0	0.0	0.0	0.0	0.0	0.0
21	30.0	30.0	30.0	30.0	30.0	30.0	30.0
22	20	0	0	0	20	20	20
23	On	On	On	On	On	On	On
24	Off	Off	Off	Off	Off	Off	Off
25	Off	Off	Off	Off	Off	Off	Off
26	Off	Off	Off	Off	Off	Off	Off
27	Off	Off	Off	Off	Off	Off	Off
28	Off	Off	Off	Off	Off	Off	Off
29	Off	Off	Off	Off	Off	Off	Off
30	Off	Off	Off	Off	Off	Off	Off

ADVANCE ACTIVATION OF THE MORNING SLOT

Depending on the thermal inertia of the building or the installation and external climatic conditions, it is possible to advance the switch from the NIGHT slot to the MORNING slot.

The time advanced, in minutes, is calculated using the following formula :

Time advanced = (gradient start temperature) x inertia coefficient

For example :

- Outside temperature 0 °C
- Gradient start temperature set to + 10 °C (i.e. below 10°C outside, you want to advance start-up)
- Inertia coefficient set to 12
- Start of Morning slot set to 8h30

In these conditions the switch to the morning slot will be advanced by: $(10 - 0) \times 12$ i.e. 120 min.

The installation will therefore start up at 6h30 instead of 8h30.

REGULATION OF AMBIENT AIR

Two power factors, one for cooling (variable 98), the other for heating (variable 97), are calculated according to the difference in temperature between the Setpoint and the reference temperature.

The progression of these cooling or heating power factors is limited by the temperature hysteresis and the activation differentials between 2 stages.

If the hysteresis value is 0, the power factor concerned is no longer limited.

See below for setting hysteresis and activation differentials.

The power factors are periodically recalculated by the CLIMATIC™. The integration time (setpoint 53) is adjustable. This parameter should depend on the air agitation ratio of the unit and temperature variations in the sector to be air conditioned.

ORDER OF COMPONENTS IN REGULATION

Cooling operation

Setpoint 58 = Off
Damper → Water coil → Compressors

Setpoint 58 = On
Damper → Compressors → Water coil

Heating operation

Setpoint 59 = Off
Water coil or electric coil → Compressors → Gas

Setpoint 59 = On
Compressors → Gas → Water coil or electric coil

Setpoint 60 = Off
Water coil or electric coil → Gas → Compressors

Setpoint 60 = On
Water coil or electric coil → Compressors → Gas

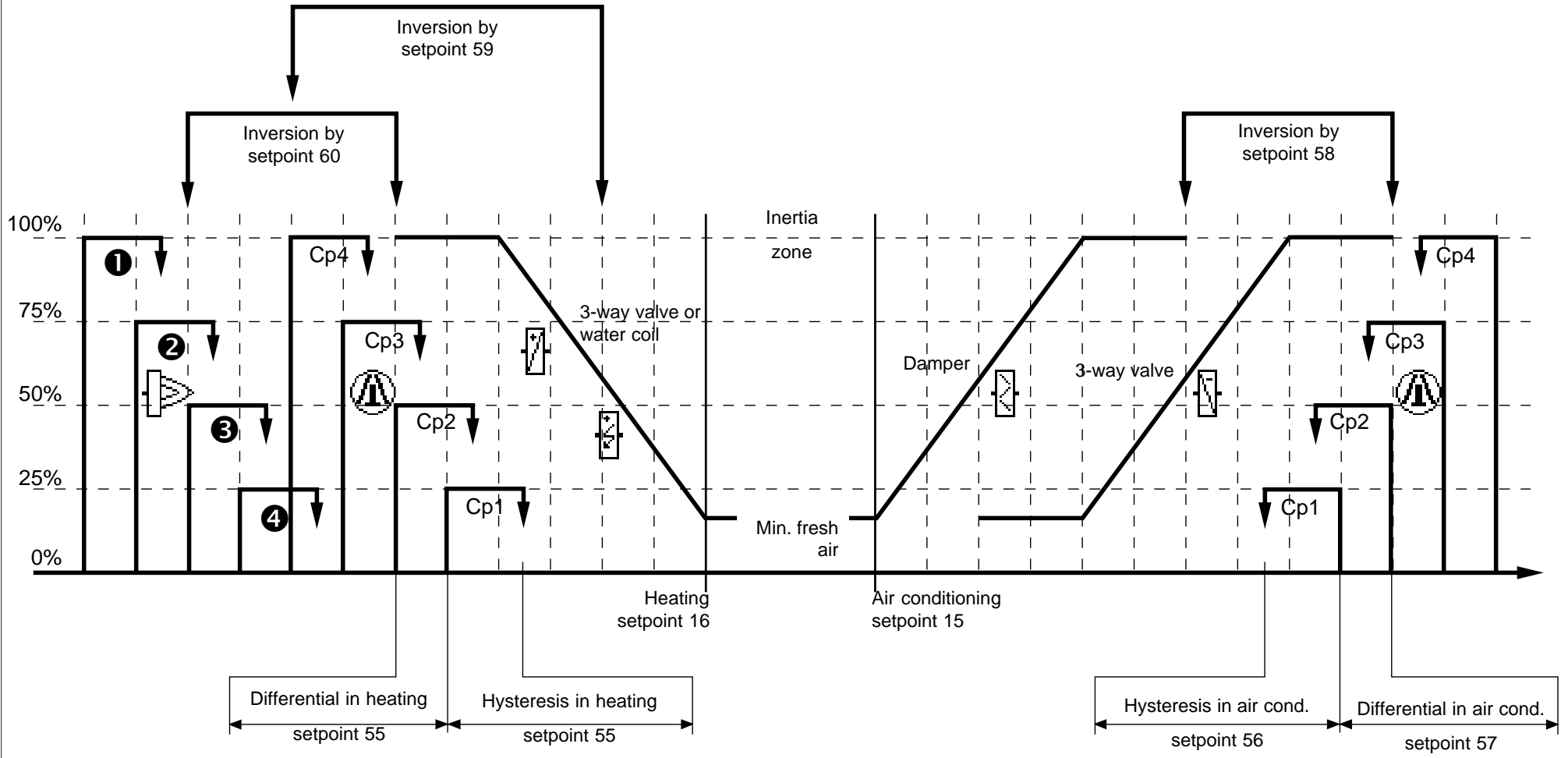

- ① : Gas 2 + Gas 1
- ② : Gas 2 + 1/2 Gas 1
- ③ : Gas 1
- ④ : 1/2 Gas 1

Cp1...Cp4 : Compressor no. 1...4

Figure 79



REGULATION OF SUPPLY AIR

Supplying air regulation should be activated by setting setpoint 61 to ON.

The main aim of supplying air regulation is to maintain the temperature of supplied air at a value close to the average of the neutral zone, if ambient air regulation is not active.

Two power factors, one for cooling (variable 101), and the other for heating (variable 100), are calculated according to the difference in temperature between the setpoint and the reference temperature.

The power factors are periodically recalculated by the CLIMATIC™. The integration time (setpoint 62) is adjustable

REGULATION IN HUMIDITY

Two power factors, one for dehumidifying (variable 105), the other for humidifying (variable 104), are calculated according to the difference in relative hygrometry between the setpoint and the reference relative hygrometry.

The power factors are recalculated periodically by the CLIMATIC™. The integration time is adjustable (setpoint 67).

ORDER OF COMPONENTS IN REGULATION

Cooling operation

Setpoint 63 = Off
Damper → Water coil → Compressors

Setpoint 63 = On
Damper → Compressors → Water coil

Heating operation

Setpoint 64 = Off
Water coil or electric coil → Compressors → Gas

Setpoint 64 = On
Compressors → Gas → Water coil or electric coil

Setpoint 65 = Off
Water coil or electric coil → Gas → Compressors

Setpoint 65 = On
Water coil or electric coil → Compressors → Gas

BLOWING REGULATION BY AIR DAMPER

Regulation of air supplying by the air damper must be activated by setting setpoint 66 to ON.

The aim of air supplying regulation by the air damper is to even out the temperature of supplied air to a value close to the average of the neutral zone.

This function is not taken into account if blowing regulation is active.

A power factor (variable 'R_Supply_Damper') is calculated according to difference in temperature between the setpoint and the ambient and outside temperatures.

The progression of the power factor is limited by the maximum percentage of fresh air (setpoint 78) if the outside temperature is less than the minimum outside air temperature (setpoint 76).

The power factor is recalculated periodically by the CLIMATIC™. The integration time is adjustable (setpoint 62).

REGULATION IN DEHUMIDIFYING

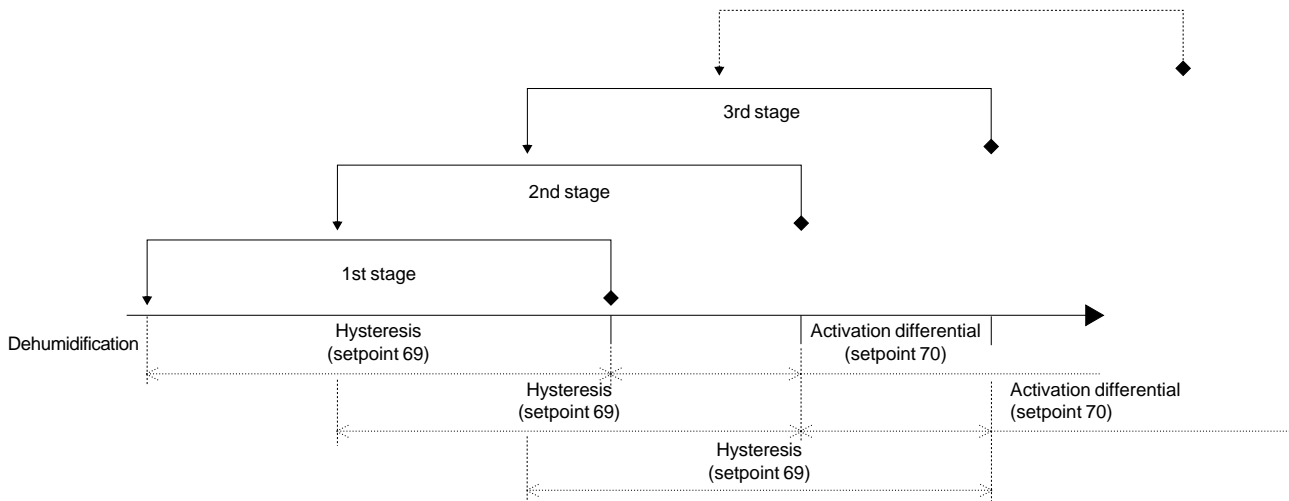

REGULATION IN HUMIDIFYING

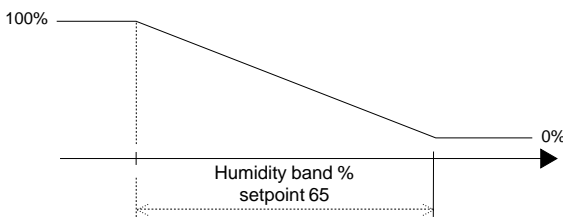

SETTING THE FRESH AIR MINIMUM

The minimum value for opening the damper to outside air can be set by instruction (see configuration of operating zones). This value is expressed directly as a percentage.

CO² SENSOR

Where a CO² sensor is connected to the unit, the value of the fresh air minimum is calculated according to the CO² ratio. The value measured by the sensor can be read in variable 17.

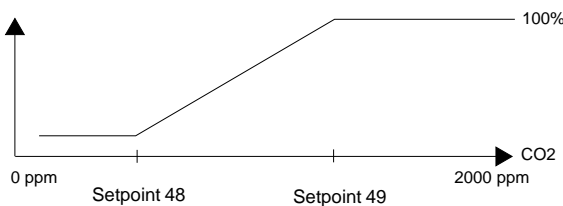

Setpoint 48 defines the number of ppm up to which the fresh air minimum is still achieved. Setpoint 49 defines the number of ppm from which 100% fresh air is used.

ENTHALPY FUNCTION

This function is used to control the use of the economiser register according to air enthalpy. If the outside hygrometry is greater than the inside hygrometry, the respective enthalpy values are then calculated. According to the result obtained, input of new air is optimised.

COMPRESSOR-RELATED FUNCTIONS

Anti-short cycle

The CLIMATIC™ provides protection of the compressors against frequent restarts. This is why the compressors cannot be started, even if requested to do so by regulation, unless the time since they were last put into operation is greater than six minutes.

Equalisation of compressor operating times (F series)

The CLIMATIC™ program is organised to equalise compressor operating times

Defrost function

For heat pump units and air condensation units, cycle inversion phases are programmed for defrosting the outside coil.

Defrosting is activated depending on :

- outside temperature (limit set by setpoint 85),
- coil temperature (limit set by setpoint 86),
- with overall weighting by an icing constant (setpoint 87).



The power cable should be connected to the main isolating switch and is fed from the underside of the unit into the electrical panel.

Refer to the general arrangement drawings in the documentation to locate the exact entry position.

The power cable sizes must be calculated with reference to the electrical characteristics of your machine.

We are unable to state the cross sectional area of the cable as it is directly related to the type of cable you are using, the distance separating the equipment from the source but also various factors relating to the cable fitting.

In the following pages you will find references to electrical diagrams which will allow you to select the wiring for your equipment.

As the diagrams are valid for the entire range, they will refer to items not included in your scope of supply.

Items	Mark	Page
Supply/ Transformers		64
Full fresh air damper activator	07	68
Economizer damper activator	05	67
Exhaust damper activator	06	67
Gas burner	4.1 4.2 4.3 4.4	
Supply		64
Control		67/69
Internal wiring		70/71
Electrical coil	02	
Power wiring		64
Control		67
Thermal safety		68
Water coil	03	
3-way valve		67
Antifreeze thermostat		68
Supply fans		64
Condensing fans/ Exhaust		65
Exhaust roofcurb	06	
Supply		64
Motors safety		68
Compressors		
Compressors		65
Crankcase heaters		65
Reversing valve	01	68
Air sock	14	64
FX drain pan electric heater		65
Displays		
KP02 maintenance	11	66
KP17 comfort	12	66
Sensors		
Room temperature	BT10	67
Outdoor temperature	BT11	67
Water coil temperature	BT13	67
Room humidity	BH10	67
Outdoor humidity	BH11	67
IAQ sensor	13	67
Compressor pressure sensor		67
Firestat	08	68/69
Smoke detector	09	
CLIMATIC™ Connexion		67/68/69
Smoke detector wiring		72
BMS contacts kit		72

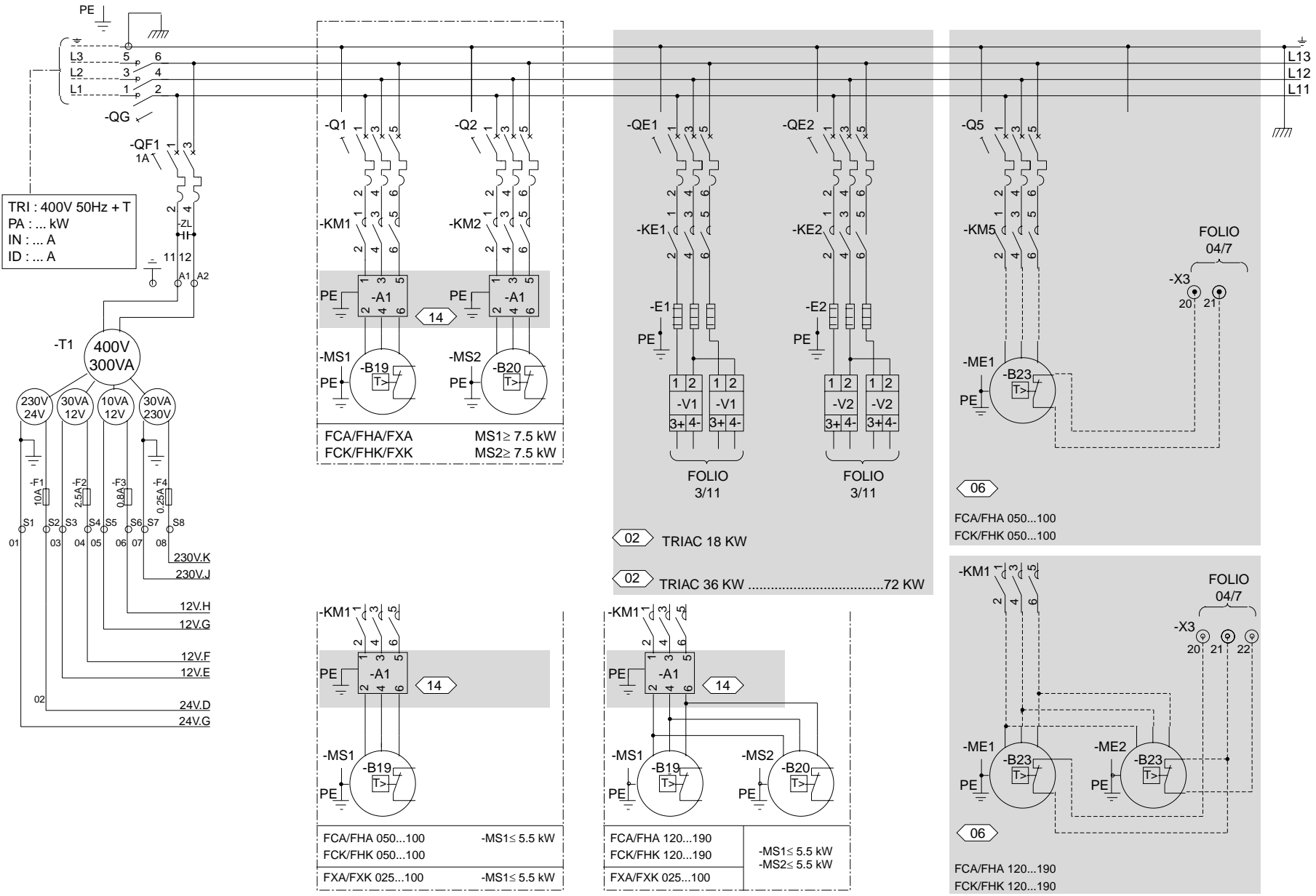

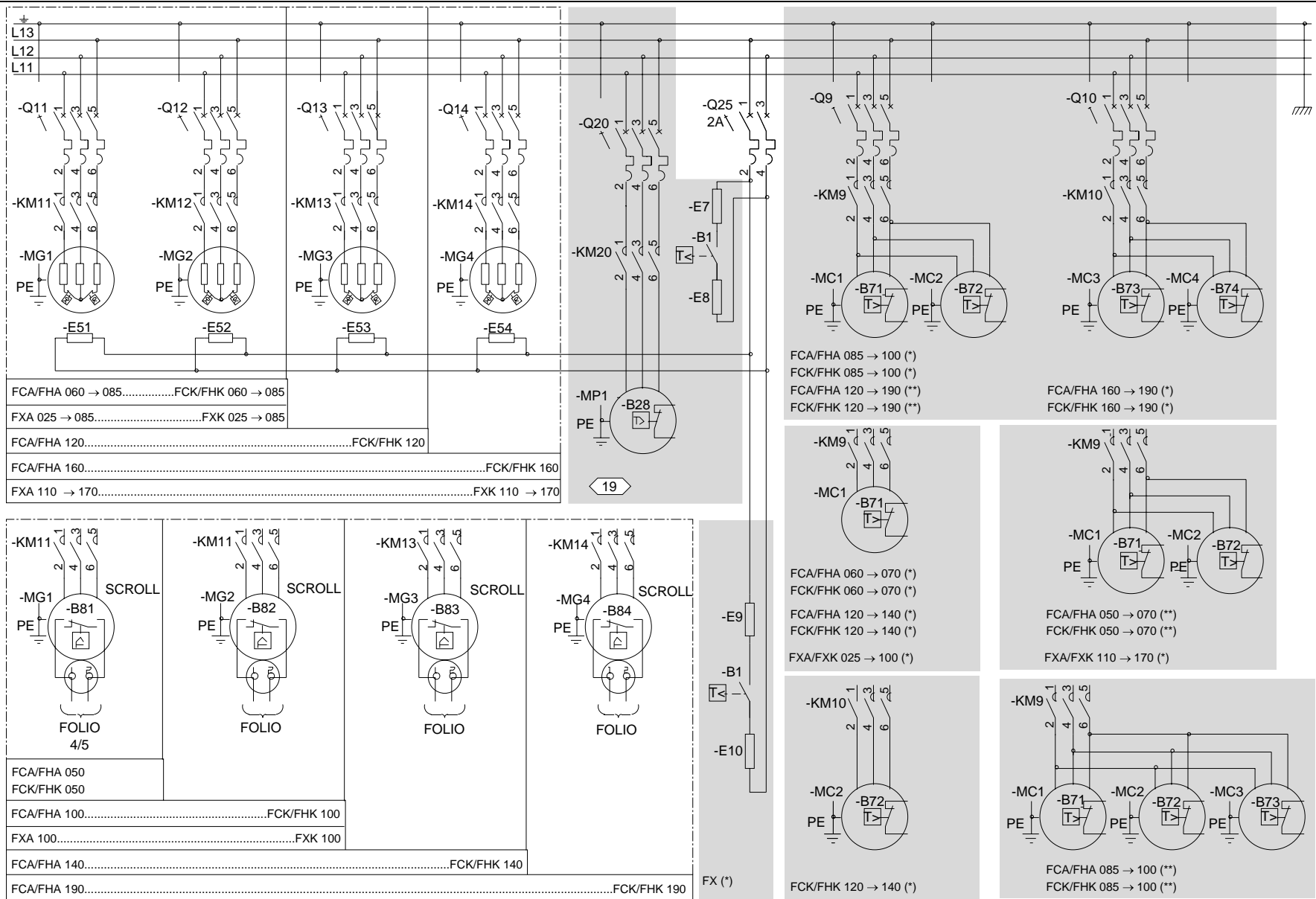

CLIMATIC™ CONTROLLER

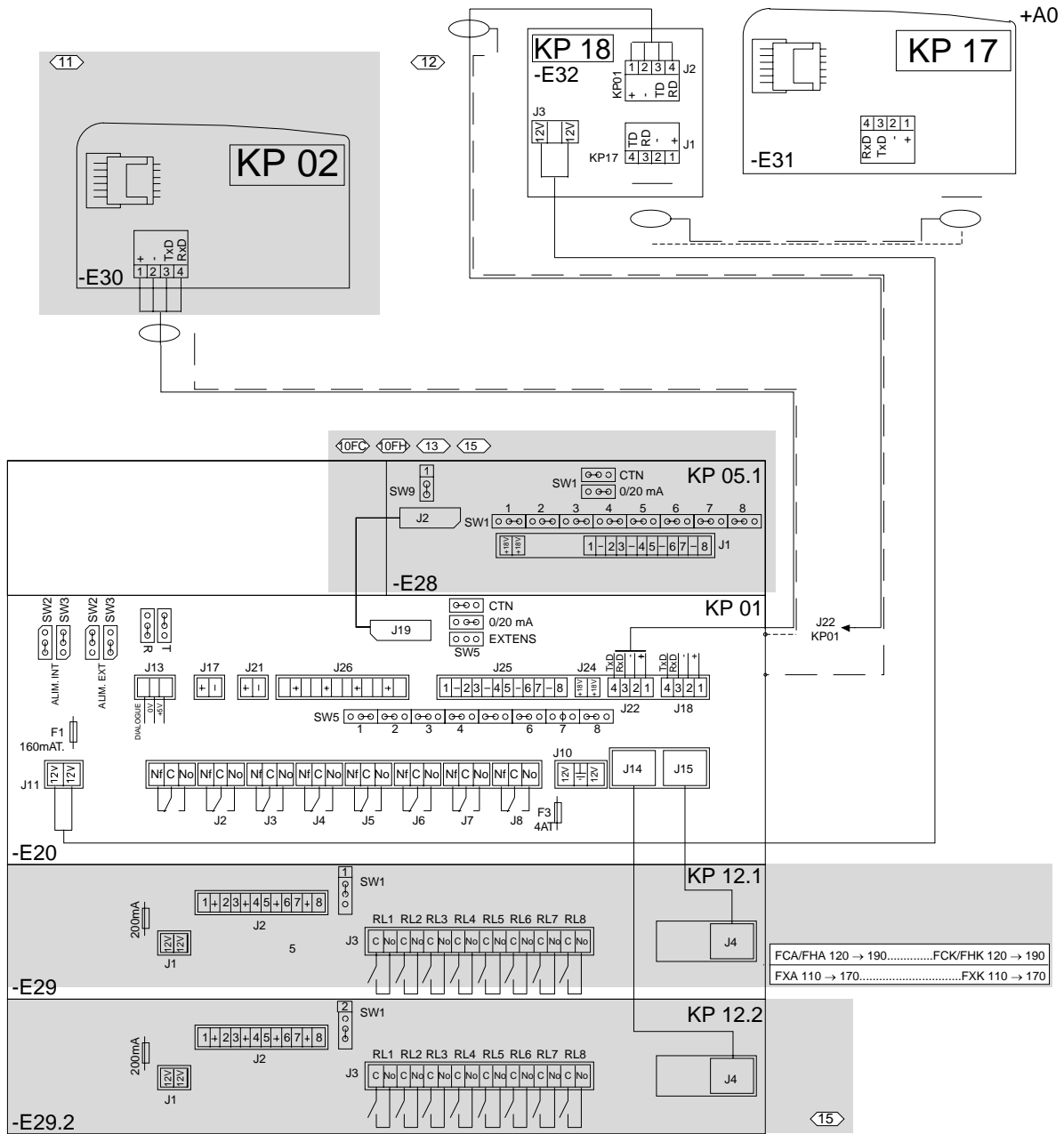

CLIMATIC™ CONTROLLER INPUTS

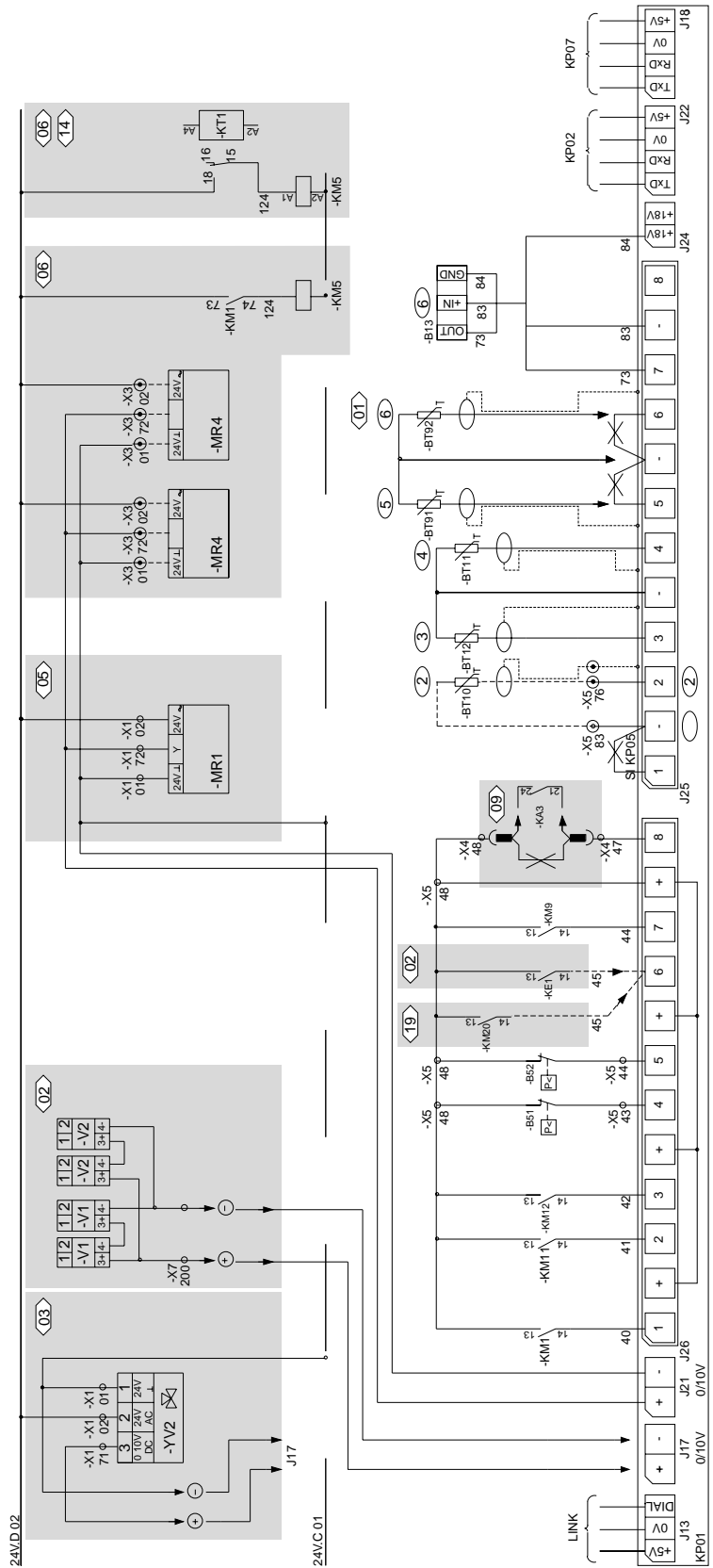
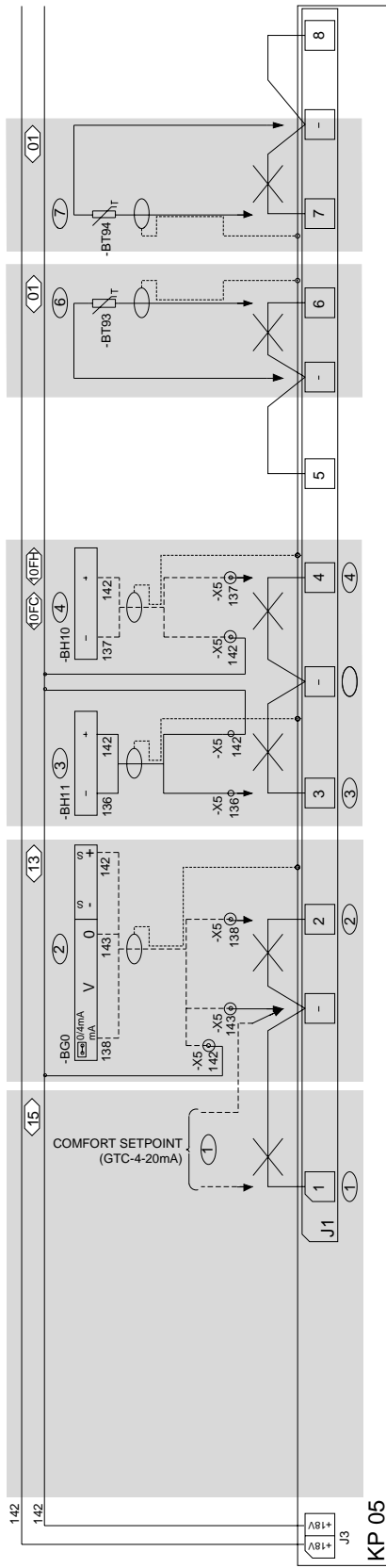

CLIMATIC™ CONTROLLER OUTPUTS

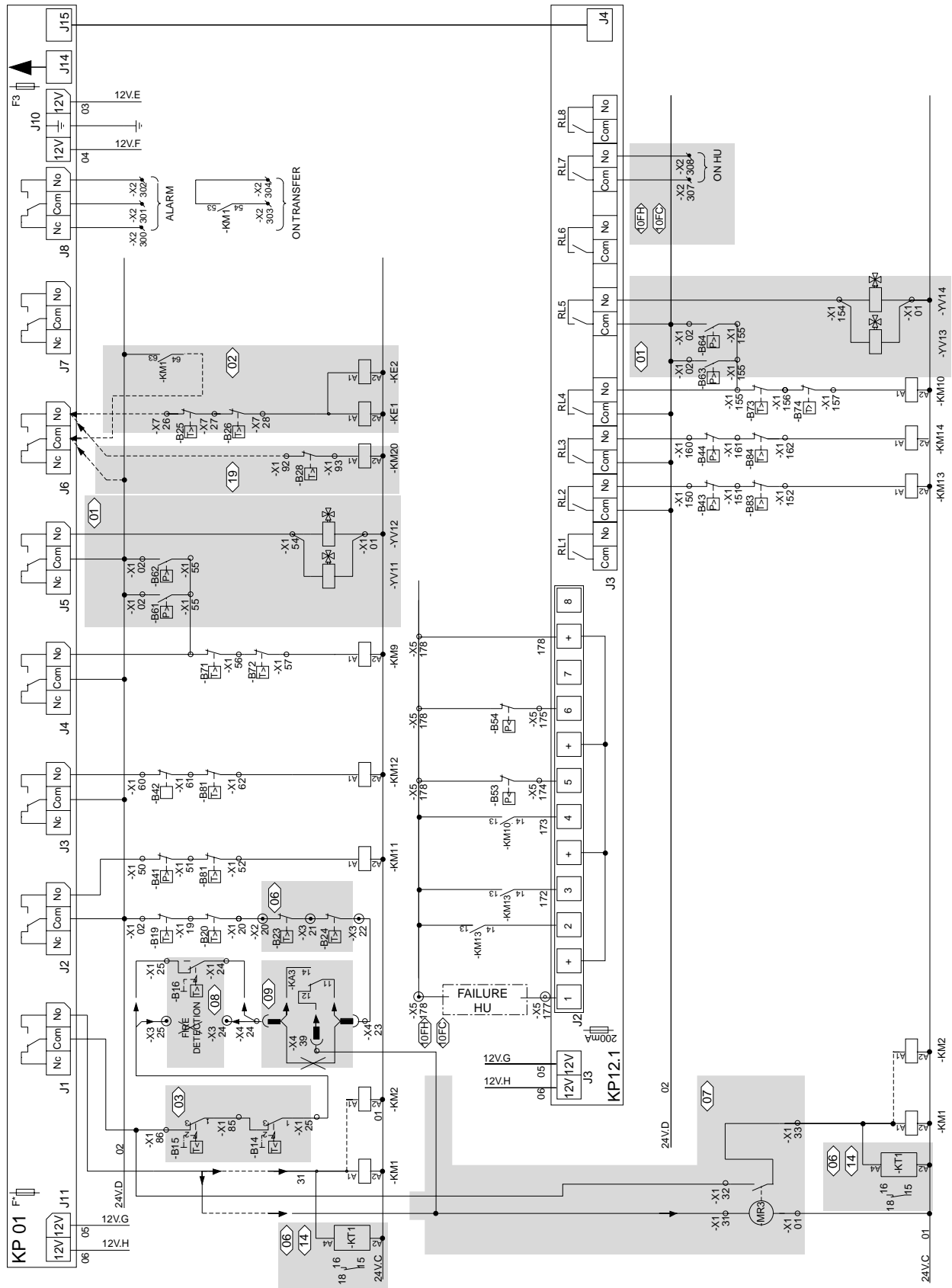

DAD

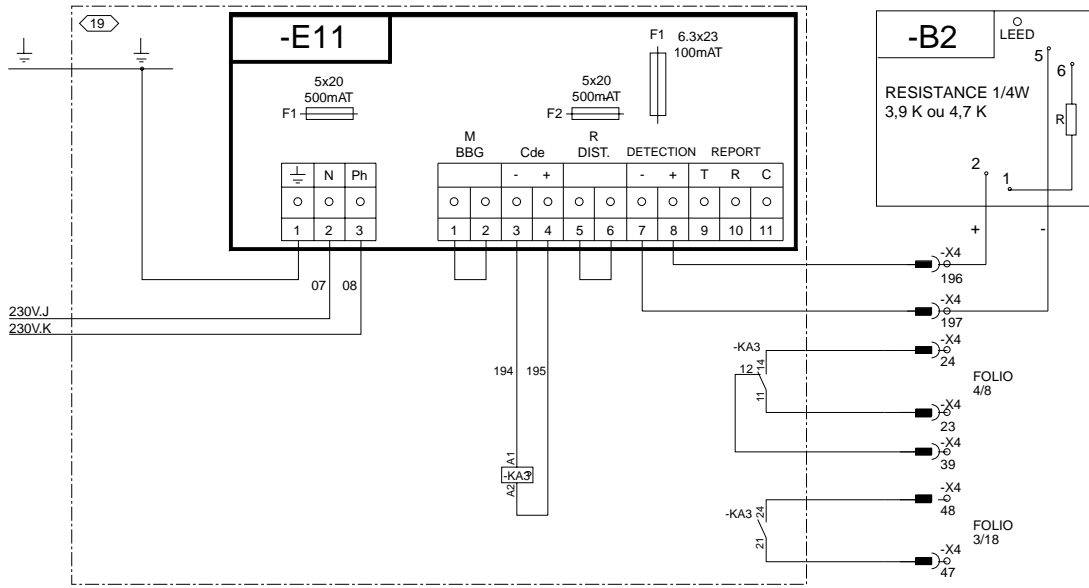

RS 232

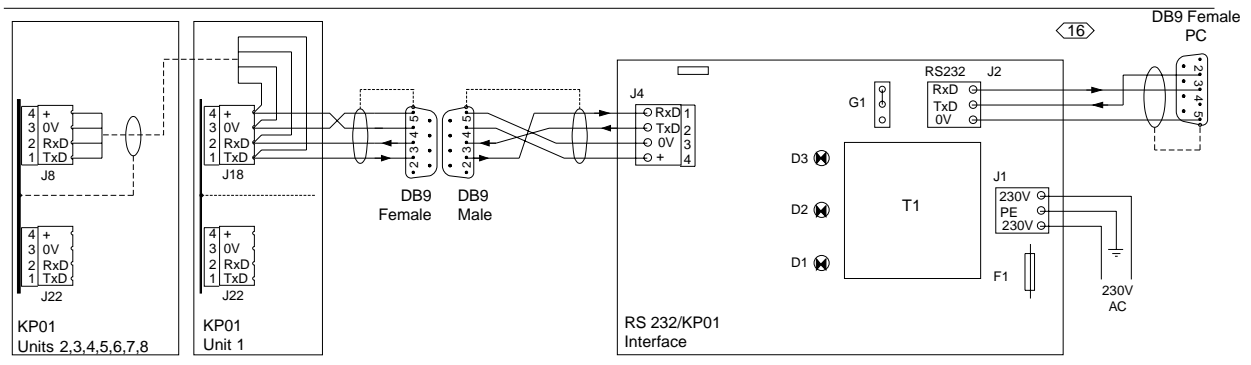

KP07

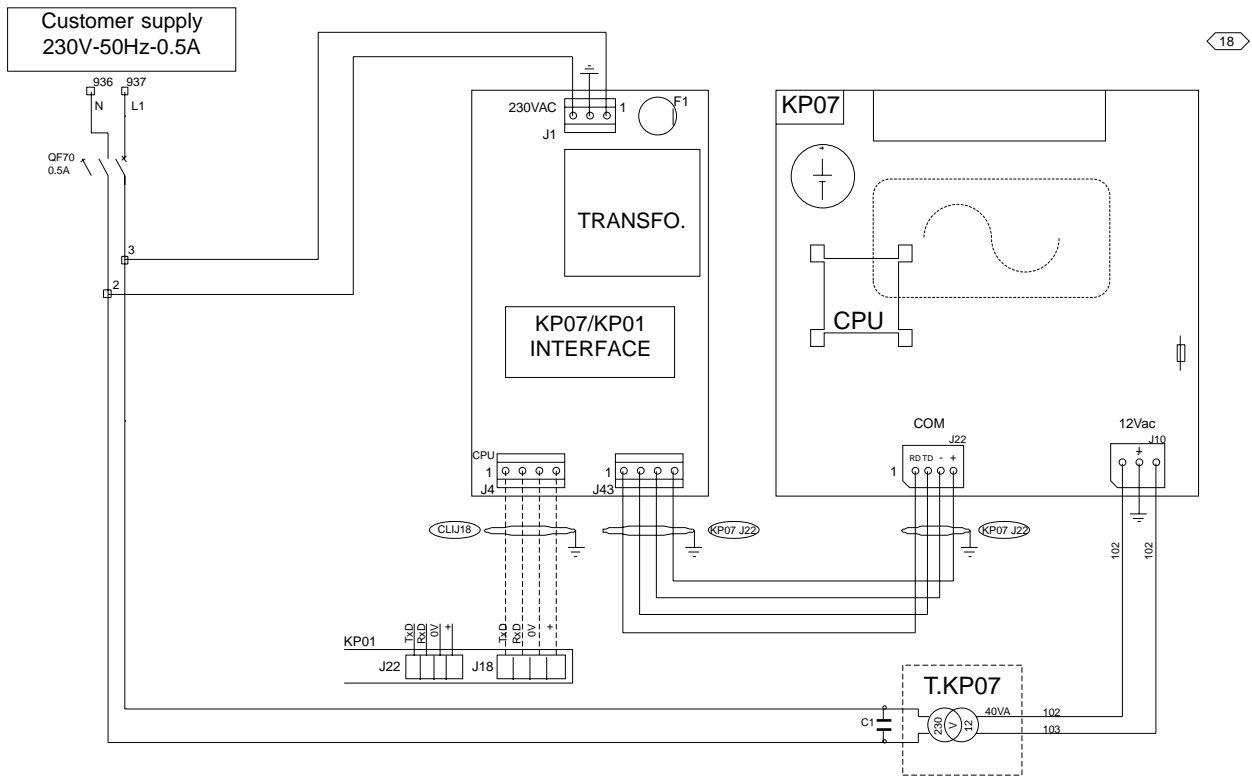

GTC

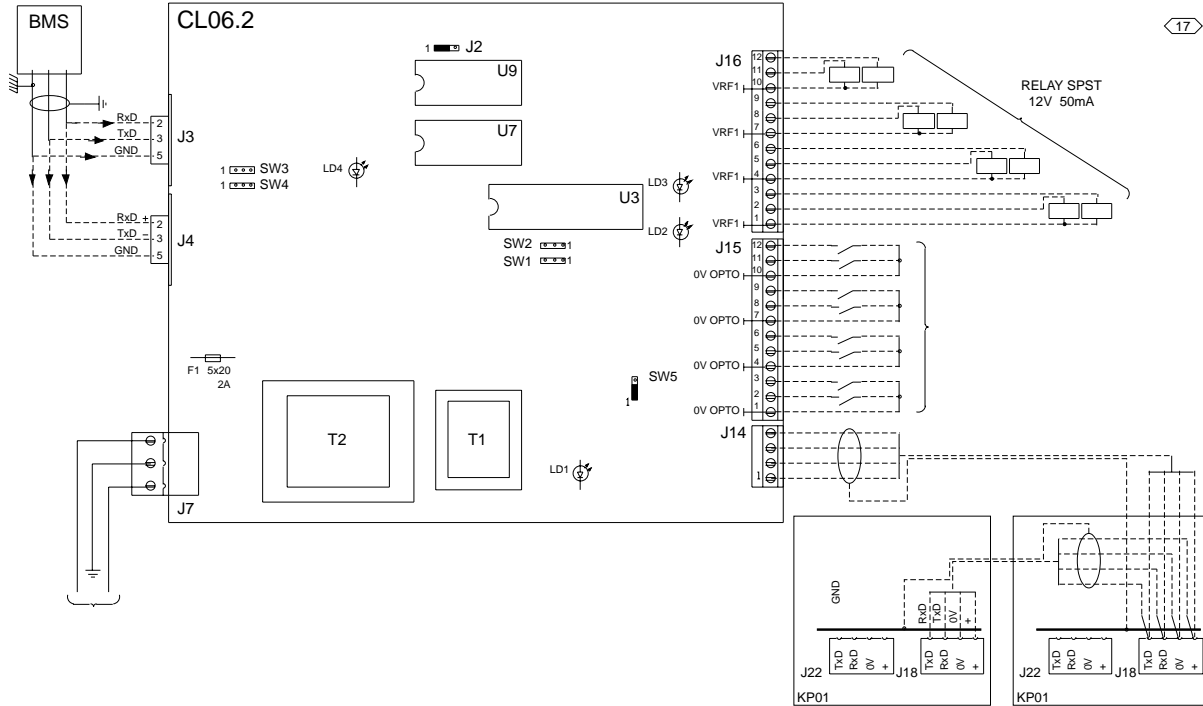

SPEED CONFIGURATION THROUGH SW-SW2				
SW1	2.3	2.3	1.2	1.2
SW2	2.3	1.2	2.3	1.2
SPEED	9600	4800	2400	1200

RS232 OR RS485 LINK CONFIGURATION		
SW3	1.2	2.3
SW4	1.2	2.3
SERIE	RS485	RS232

RS232 SERIAL LINK :

RS232 link used for short distances.
Only a master device may be connected to this link.

RS485 SERIAL LINK

Used for long distances (1000 meters maxi).
Until 31 devices may be connected (1 of them is the master)

F1	1A fuse
J2	Memory size : 8K (position 1.2) 32 K (position 2.3)
J3	SUBD 9 points plug in connector - RS232 link
J4	SUBD 9 points plug in connector - RS485 link
J7	Phoenix 3 point plug in connector - 230V supply
J14	4 point plug in connector - CLIMATIC™ link
J15	ON OFF input 12 point plug in connector
J16	ON OFF output 12 point plug in connector
LD1	link 6V supply monitoring LED
LD2	Dialogue monitoring LED
LD3	Power fell monitoring LED
LD4	5V supply monitoring LED
SW1	Configuration vitesse (9600, 4800n 2400 ou 1200 bauds)
SW2	Speed configuration (9600, 4800n 2400 or 1200 bauds)
SW3	TxD Signal (RS232 configuration (position 2-3)/ RS485 (position 1-2)
SW4	RxD Signal (RS232 configuration (position 2-3)/ RS485 (position 1-2)
SW5	+10C converter (position 1-2)
U7	CL06 program Eprom
U9	Configuration Eprom

GTC

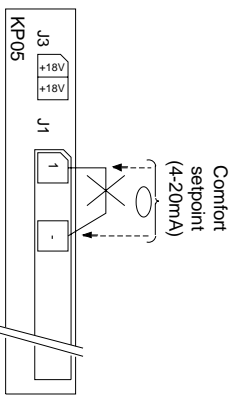
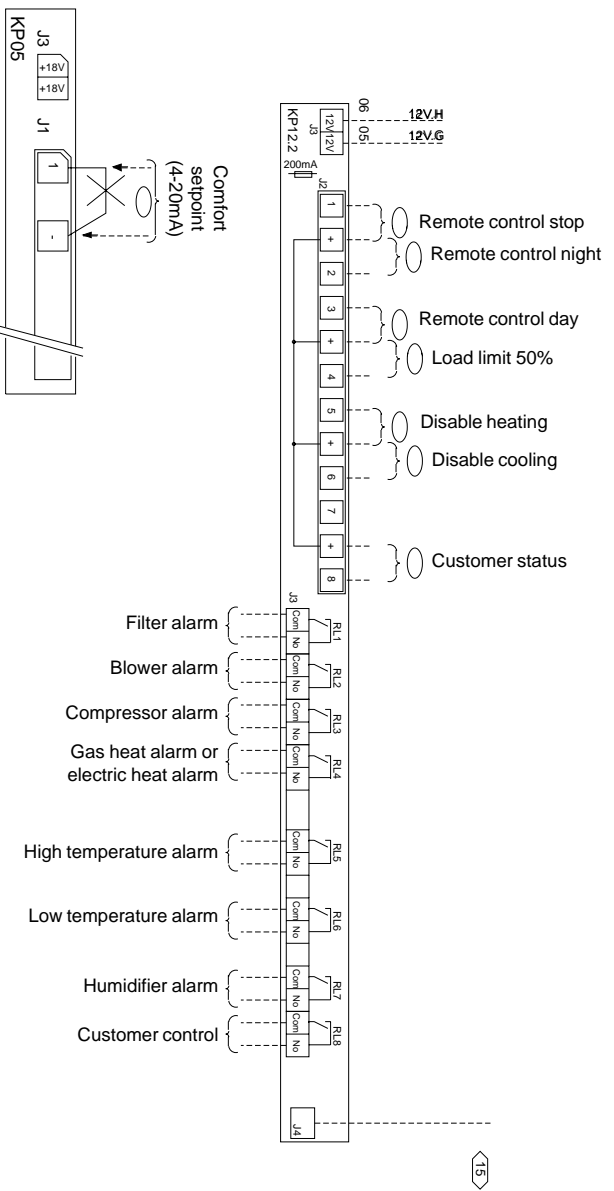

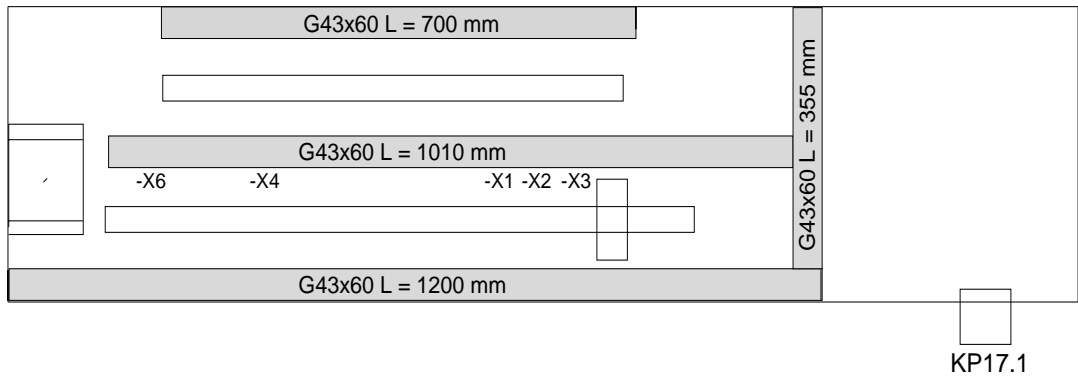

FCA/FHA 050
FCK/FHK 050

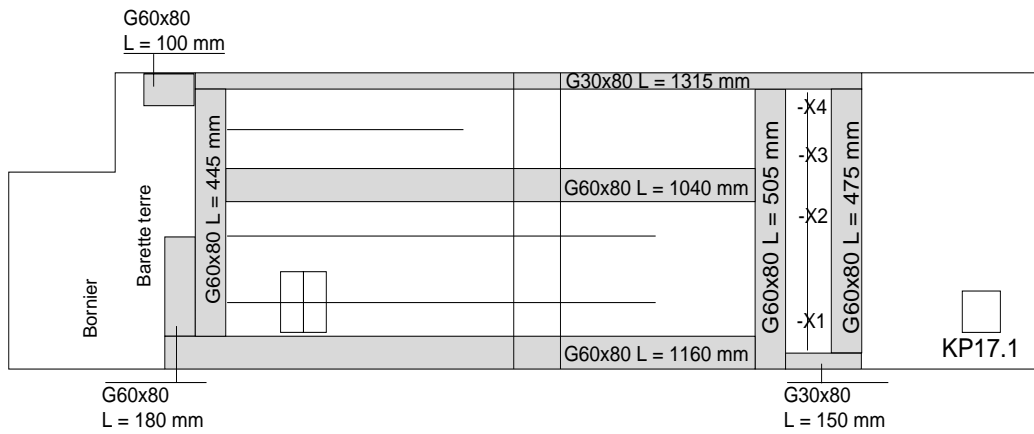

FCA/FHA 060.....190
FCK/FHK 060.....190
FXA/FXK 035.....170

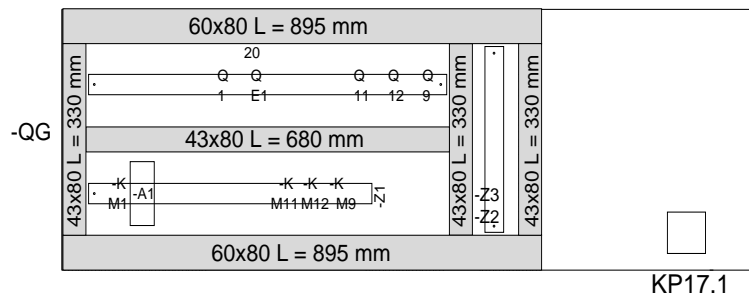

FXA/FXK 025.030

+A0	CLIMATIC™ controller	-E7/8	Hot water coil antifreeze radiant strip heater
+A1/+A2 ..	Condensing unit 1 / Condensing unit 2	-E9/10	Antifreeze heater
+A3/+A4 ..	Condenser 1 / Condenser 2	-E11	Smoke detector printed circuit
-A1	Démarrreur progressif	-E12	Humidifier -E4 electrodes
-B1	External air thermostat	-E13	Water leak electrode
-B2	Smoke detection head	-E14	Burner control box
-B3	RC circuit	-E15	Steam humidifier -E4 printed circuit
-B4/B5	Gas manifold ionisation sensor	-E16	Steam humidifier -E4 printed circuit 0/10V
-B6/-B7	Gas manifold ignition electrode	-E20	CPU card KP01
-B11	Water flow switch	-E21	On Off input card KP03
-B13	Clogged air filter pressure switch/air flow rate	-E22	On Off output card KP08.1
-B14	Hot water battery antifreeze thermostat	-E23	Analog output card KP04.1
-B15	Hot water battery antifreeze thermostat	-E24	Analog output card KP04.2
-B16	Fire thermostat	-E25	Analog output card KP04.3
-B17/18 ...	Gas manifold minimum gas pressure switch	-E26	Analog output card KP04.4
-B19/20 ...	Blower fan motor -MS1/-MS2 stoptherme	-E27	On Off output card KP08.2
-B21/22 ...	Gas manifold smoke extraction air pressure switch	-E28	Input card 4/20mA KP05.1
-B23/24 ...	Extraction fan motor -ME1/-ME2 stoptherme	-E29.1.2 ..	Input output card KP12
-B25/26 ...	Electric battery -E1/-E2 safety klixon	-E30	Digital console KP02
-B27	Electric battery -E3 safety klixon	-E31	Digital console KP17
-B28	Circulation pump -MP1 motor stoptherm	-E51/52 ...	Compressor -MG1/-MG2 crankcase heater
-B29/30 ...	Gas manifold air flow rate safety klixon	-E53/54 ...	Compressor -MG3/-MG4 crankcase heater
-B31	Water leak detection	FCO	Water circuit filter
-B32/33 ...	Gas manifold flashback safety klixon	FD	Drier filter
-B41/42 ...	Compressor -MG1/-MG2 high pressure safety switch	FDB	Receiver dehumidifier filter
-B43/44 ...	Compressor -MG3/-MG4 high pressure safety switch	FDW	Double flow dehumidifier filter
-B45/46 ...	Gas manifold 1 / gas manifold 2 regulation klixon	-F1	Secondary circuit -T1 128VA / 24V protection fuse
-B51/52 ...	Compressor -MG1/-MG2 low pressure safety switch	-F2	Secondary circuit -T1 30VA / 12V protection fuse
-B53/54 ...	Compressor -MG3/-MG4 low pressure safety switch	-F3	Secondary circuit -T1 6VA / 12V protection fuse
-B61/62 ...	Compressor -MG1/-MG2 high pressure control switch	-F4	Secondary circuit -T1 36VA / 24V protection fuse
-B63/64 ...	Compressor -MG3/-MG4 high pressure control switch	-KA31/32 .	Gas burner fault relay
-B71/72 ...	Condenser -MC1/-MC2 fan motor stoptherme	-KA41/42 .	Gas burner fault relay
-B73/74 ...	Condenser -MC3/-MC4 fan motor stoptherme	-KA3	Smoke fault relay
-B81/82 ...	Scroll compressor -MG1/-MG2 protection module	-KA4	Low speed/high speed relay
-B83/84 ...	Scroll compressor -MG3/-MG4 protection module	-KE1/2	Heater -E1/-E2 contactor
-B91/92 ...	Pressure switch 4 / 20ma compressor -MG1/-MG2	-KE3	Heater -E3 contactor
-B93/94 ...	Pressure switch 4 / 20ma compressor -MG3/-MG4	-KE4	Steam humidifier contactor E4
BCD	Condenser coil	-KM1/2	Blower fan motor -MS1/-MS2 contactor
BEC	Hot water coil	-KM3	Blower fan motor low speed contactor
BEG	Chilled water	-KM4	Star coupling contactor
BEV	Evaporator coil	-KM5/6	Extraction fan motor -ME1/-ME2 contactor
-BG10	Hygiene sensor	-KM7	Extraction fan motor low speed contactor
-BH10	Regulation hygrometry sensor	-KM8	Star coupling contactor
-BH11	External hygrometry sensor	-KM9/10 ..	Condenser 1 / condenser 2 fan motor contactor
-BT10	Regulation temperature sensor	-KM11/12 .	Compressor -MG1/-MG2 contactor
-BT11	External temperature sensor	-KM13/14 .	Compressor -MG3/-MG4 contactor
-BT12	Blower temperature sensor	-KM15	Condenser 2 fan motor contactor
-BT13	Chilled water temperature sensor	-KM20	-MP1 circulating pump contactor
-BT14	Condenser 1 speed regulation temperature sensor	-KM21/22 .	Gas manifold 1 - gas manifold 2 contactor
-BT15	Condenser 2 speed regulation temperature sensor	-KT1	Timing replay
-BT16	Water exchanger outlet antifreeze sensor	-MC1/2 ...	Condenser -MC1/-MC2 fan motor
-BT21/22 .	Compressor 1-2 antifrost temperature sensor	-MC3/4 ...	Condenser -MC3/-MC4 fan motor
-BT23/24 .	Compressor 3-4 antifrost temperature sensor	-ME1/2 ...	Extraction fan motor -ME1/-ME2
-BT91/92 .	Defrost temperature sensor compressor 1-2	-ME3/4 ...	Extraction fan motor -ME3/-ME4
-BT93/94 .	Defrost temperature sensor compressor 3-7	-MG1/2 ...	Compressor -MG1/-MG2
BTP1/2	-MG1/-MG2 compressor accumulator	-MG3/4 ...	Compressor MG3/MG4
BTP 3/4 ...	-MG3/-MG4 compressor accumulator	-MP1	Circulating pump motor
CL06.2	JBUS	-MR1	Economiser damper motor
DT	Thermostatic expansion valve	-MR2	Blower damper motor
EEH	Horizontal water heat exchanger	-MR3	Fresh air damper motor
EEV	Vertical water heat exchanger	-MR4	Extraction damper motor
-E1/2	Heater -E1/E2	-MR5	Recycled air damper motor
-E3	Heater -E3	-MR6	Distribution air damper motor
-E4	Humidificateur -E4	-MS1/2	Blower fan motor -MS1/-MS2

-Q1/2 Blower fan motor -MS1/-MS2 protection	-SB1 Emergency stop
-Q5 Extraction fan motor -ME1/-ME2 protection	-T1 Control circuit transformer 400V/24V/12V/12V/230V
-Q9 Condenser -MC1/-MC2 fan motor protection	-T3 Burner power supply transformer 400V / 230V
-Q10 Condenser -MC3/-MC4 fan motor protection	-TI4 Power supply transformer humidifier -E4
-Q11/12 ... Compressor -MG1/-MG2 protection	UF Cooling unit
-Q13/14 ... Compressor -MG3/-MG4 protection	UT Air handling unit
-Q15 Condenser -MC2 fan motor protection	U1 Interface
-Q20 Circulating pump protection -MP1	VAM Manual shut-off valve
-Q25 Crankcase heater protection	VL Liquid indicator
QCC Quick release coupling	VRM Manual control valve
-QF1 Primary circuit protection -T1	-V1 Electric battery static contactor
-QF2 Primary circuit protection -T3	-V2 Electric battery static contactor
-QF3 Secondary circuit protection -T3	-V2VP Pressure switched 2-way valve
-QF4 Primary circuit protection -T4	-V3VP Pressure switched 3-way valve
-QG Main switch	-Y1 Gas manifold N1 reset electromagnet
-QG1/2 Condenser 1 / condenser 2 main switch	-Y2 Gas manifold N2 reset electromagnet
-QE1/2 Heater -E1/-E2 protection	-YR Loading humidifier electrovalve -E4
-QE3 Heater -E3 protection	-YV Draining humidifier electrovalve -E4
-QE4 Steam humidifier protection -E4	-YV1 Chilled water 3-way valve
-RL Liquid receiver	-YV2 Hot water 3-way valve
-SAT Shut-off valve	-YV11/12 . Compressor -MG1/-MG2 cycle reversal valve
-SA1 Humidifier -E4 ON/OFF switch	-YV13/14 . Compressor -MG3/-MG4 cycle reversal valve
-SA2 Humidifier -E4 drain switch	-YV31/32 . Burner gas solenoid valve
	-YV41/42 . Gas manifold safety solenoid valve
	-YV51/52 . Gas manifold main solenoid valve
	-YV61 Compressor -MG1 hot gas injection solenoid valve
	-YV71/72 . Compressor -MG1/-MG2 liquid solenoid valve
	Z* Capacity resistance circuit

 Screened cable mark
-Fil 0.5 mm²

— — — — — Links to be made by installer

- X4 ○ Smoke detection terminal strip
- X5 ○ Auxiliary terminal strip
- X1 ○ Main terminal strip
- X2 ✎ } Terminal strip/customer connection
- X3 ⊙ }

CAUTION

All the contactors and coils contacted on site having a CLIMATIC™ input must be fitted with a RC circuit.

000	No error
001	Failure air flow
004	Dirty filters
005	Missing filters
011	Faulty electrical heater batteries
012	Supply air overtemperature
013	Temperature too low
014	Faulty gas burner no. 1
015	Faulty gas burner no. 2
022	Supply temperature too low
023	Room overtemperature
031	Faulty humidifier
032	Room humidity too low
033	Room overtemperature
041	Faulty pump
081	Faulty return air or room temperature sensor
082	Faulty return air or room relative humidity sensor
083	Faulty outside temperature sensor
084	Faulty outside relative humidity sensor
085	Faulty supply air temperature sensor
086	Faulty cold water loop temperature sensor
087	Faulty water condenser outlet temperature sensor
091	Faulty blower fan
092	Faulty condenser : system 1 or 2
093	Faulty condenser : system 3 or 4
094	Customer error
095	Water leak
096	Condenser water temperature too low
097	Condenser water overtemperature
098	Faulty water flow
099	Error : smoke
111	Faulty condensation temperature sensor no. 1
112	Faulty pressure transmitter no. 1
113	Faulty frost power temperature sensor no. 1
115	Faulty high pressure or faulty electrical compressor no. 1
117	Faulty low pressure compressor no. 1
121	Faulty condenser temperature sensor no. 2
122	Faulty pressure transmitter no. 2
123	Faulty frost temperature sensor no. 2
125	Faulty high pressure or faulty electrical power compressor no. 2
127	Faulty low pressure compressor no. 2
131	Faulty condenser temperature sensor no. 3
132	Faulty pressure transmitter no. 3
133	Faulty frost temperature sensor no. 3
135	Faulty high pressure or faulty electrical power compressor no. 3
137	Faulty low pressure compressor no. 3
141	Faulty condenser temperature sensor no. 4
142	Faulty pressure transmitter no. 4
143	Faulty frost temperature sensor no. 4
145	Faulty high pressure or faulty electrical power compressor no. 4
147	Faulty low pressure compressor no. 4

The following text includes references such as [C11] and [V25]. They relate to the threshold or variable numbers used with the KP02 unit.

Wrong Air Flow

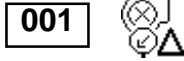

If the pressure differential obtained by the analog sensor [V16] is less than the setpoint value [C92] for more than 20 seconds, and if the blower fan has operated for more than 1 minute 30 seconds, the air flow safety system is activated and stops the ventilation.

The air flow safety system automatically stops after 1 minute 30 seconds and is automatically locked out after 3 cut-outs in the same day. In this case a manual reset is obligatory. The cut-out counter is reset to zero every evening at 20:00 if the value does not exceed 3 failures.

Dirty Filters



If the pressure differential obtained by the analog sensor [V16] is greater than the setpoint value [C93] for more than one minute, the CLIMATIC™ indicates that the filters are dirty. The unit is not stopped.

Missing Filters

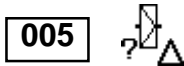

If the pressure differential obtained by the analog sensor [V16] is less than the setpoint value [C94] for more than one minute, the CLIMATIC™ indicates that the filters are missing. The unit is not stopped.

SUPPLY AIR TEMPERATURE SAFETY SYSTEM

Supply Air Overtemperature Limit

1st Safety Level

If the supply air temperature is greater than or equal to the setpoint [C74], the heat control system starts to reduce progressively. The control cycle will recommence normal operation for a temperature lower than 3°C below this setpoint.

2nd Safety Level

If the supply air temperature is greater than or equal to the setpoint [C75], the safety system is activated. The safety system automatically stops at a temperature lower than 3°C below this setpoint.



Supply Air Temperature Too Low

1st Safety Level

If the supply air temperature is greater than or equal to the setpoint [C71], the cold control system starts to reduce progressively. The control cycle will recommence normal operation for a temperature in excess of 3°C above this setpoint.

2nd Safety Level

If the supply air temperature is less than or equal to the setpoint [C72], the unit automatically positions its fresh air damper to the all air recycled position and cuts out cold production. This safety level automatically stops at a temperature in excess of 3°C above this setpoint.

3rd Safety Level

If the supply air temperature is less than or equal to the setpoint [C73] for more than 15 minutes and for 15 minutes after the fan has started, the "supply air temperature too low" safety system is activated. The unit shuts down completely.

This safety system cuts out if the supply air temperature is greater than 3°C above this setpoint. It is automatically maintained after 3 cut-outs in the same day, and in this case a manual reset is obligatory. The cut-out counter is reset to zero every evening at 20:00 if the value does not exceed 3 failures.



NOTE : If a unit has a hot water battery, the temperature setpoint value is fixed at +6°C and the

register time set to 5 seconds. In addition, if the antifreeze thermostat is opened, the 3rd safety level is immediately automatically maintained. In this case, manual resetting of the thermostat followed by the CLIMATIC™ is obligatory

Room Overtemperature Safety System



Upper Room Air Limit

If the room temperature is greater than or equal to the setpoint [C41], the safety system is activated. It automatically cuts out at a temperature lower than 3°C below this setpoint.



Lower Room Air Limit

If the room temperature is less than or equal to the setpoint [C40], the safety system is activate

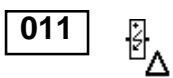

Faulty Electrical Heater Batteries

The electrical heater battery safety thermostats act directly on the heater stage contactors. This information is fed to the CLIMATIC™ via auxiliary contacts.

If the CLIMATIC™ gives the order to the heater to operate and if 5 seconds later the auxiliary contact is still open, the heat safety system is activated and stops the electrical heater assembly. This safety system is automatically locked-out. In this case a manual reset is obligatory.

Note: This fault is also displayed in the event of a contact "shunt".



Faulty Gas Burners

If there is a fault with the gas control boxes the heat safety system is activated and stops the respective burner.

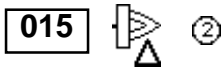

This safety system automatically cuts out on the CLIMATIC™ and the control unit must be manually reset.

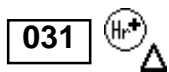

Faulty Humidifier (Flexy Only)

If there is a fault with the gas control unit for more than a minute, the safety system is activated and stops the humidifier.

This safety system is automatically locked-out. In this case a manual reset is obligatory.

Room Humidity Safety System



Lower Room Limit

If the room humidity is less than or equal to the setpoint [C42] or [C44], the safety system is activated. It automatically cuts out at a humidity of 3% above this setpoint.



Upper Room Limit

If the room humidity is greater than or equal to the setpoint [C43] or [C45], the safety system is activated. It automatically cuts out at a humidity of 3% below this setpoint.



Faulty Pump















The internal protection of the water pump motor acts directly on the pump contactor. This information is transmitted to the CLIMATIC™ via an auxiliary contact of the contactor.

If the CLIMATIC™ gives the pump the order to operate and if 5 seconds later the auxiliary contact remains open, the safety system is activated and stops the pump.

The safety system is immediately automatically locked out. In this case, manual resetting is obligatory.

Note: This error is also displayed in the event of a "shunt" of the auxiliary contact of the contactor.

Sensor Status

081			Room temperature sensor missing or faulty.
082			Room relative humidity sensor missing or faulty
083			Outside air temperature sensor faulty
084			Outside relative humidity sensor faulty
085			Supply Air temperature sensor faulty
086			Temperature sensor on cold water loop faulty
087			Temperature sensor on condenser water outlet faulty.

NOTE :

Missing or faulty room, supply air or outside air temperature sensors can affect the overall control system. A safety device will be activated and all equipment except for the ventilation will cut out. Failure of the other sensors will only stop the equipment involved.

089**Faulty inter card link**

The inter card link is faulty or missing.

Faulty blower fan

The fan contactor is not connected although the CLIMATIC™ requests it.

- The thermostat fire safety mechanism, or the fire insertion, is open.
- The internal protection of the blower fan motor is open.

The fire detector and the fan motor internal protection act directly on the fan motor contactor. This information is transmitted to the CLIMATIC™ via an auxiliary contact of the contactor. If the CLIMATIC™ gives the order to operate to the fan and if the auxiliary contact is still open 5 seconds later, the fan safety system is activated and stops the unit.

The safety system is immediately automatically locked out. In this case, manual resetting is obligatory.

If a unit is fitted with an all-or-nothing servomotor-powered damper, the detection time extends to 2 minutes (Flexy™ only).

Note : This error is also displayed in the event of a "shunt" of the auxiliary contact of the contactor.

091**Faulty ventilation, condenser circuit 1 or 2**

The fan contactor is not connected although the CLIMATIC™ requests it.

The fan motor internal protection acts directly on the fan motor contactor. This information is transmitted to the CLIMATIC™ via an auxiliary contact of the contactor.

If the CLIMATIC™ gives the order to operate to the fan and if the auxiliary contact is still open 5 seconds later, the fan safety system is activated and stops the condenser fan and the compressors concerned.

The safety system is immediately automatically locked out. In this case, manual resetting is obligatory.

092**Faulty ventilation, condenser circuit 3 or 4**

The fan contactor is not connected although the CLIMATIC™ requests it.

The fan motor internal protection acts directly on the fan motor contactor. This information is transmitted to the CLIMATIC™ via an auxiliary contact of the contactor.

If the CLIMATIC™ gives the order to operate to the fan and if the auxiliary contact is still open 5 seconds later, the fan safety system is activated and stops the condenser fan and the compressors concerned.

The safety system is immediately automatically setpoint. In this case, manual resetting is obligatory.

093

094

**Customer error**

A fault has been detected, external to the unit.

095

**Water leak**

If the contact of the water leak detection card is closed for more than 30 seconds, the safety system is activated.

WATER HEAT EXCHANGER OUTLET TEMPERATURE SAFETY SYSTEM.**Condenser Water Temperature Too Low**

If the temperature of the water loop is less than or equal to the preset setpoint [C89] during the operation of one of the compressors, the condenser safety mechanism is applied. The compressors are stopped.

This safety mechanism automatically cuts out if the loop temperature exceeds 4°C from this setpoint.

It is also automatically locked out after 3 failures within a day. In this case, manual resetting is obligatory. The counter is reset to zero every evening at 20:00 if its value does not exceed 3 failures.

096

**Condenser Water Temperature Too High**

The temperature of the water loop is greater than or equal to the preset setpoint [C90] during the operation of one of the compressors, the condenser safety mechanism is applied. The compressors are stopped.

This safety mechanism automatically cuts out if the loop temperature is less than 4°C from this setpoint.

It is also automatically locked out after 3 failures within a day. In this case, manual resetting is obligatory. The counter is reset to zero every evening at 20:00 if its value does not exceed 3 failures.

096

**Faulty Water Flow**

If the contact of the water flow controller is open for more than 20 seconds, the condenser safety mechanism is applied. The compressors are stopped.

This safety mechanism automatically cuts out if the loop temperature is less than 4°C from this setpoint.

It is also automatically locked out after 3 failures within a day. In this case, manual resetting is obligatory. The meter is reset to zero every evening at 20:00 if its value does not exceed 3 failures.

098

**Error : Smoke**

























If the contact closes due to the smoke detector card, the smoke safety mechanism is activated. The unit is completely shut down and the fresh air louver is set to the fresh air position.

This safety mechanism is automatically locked out. In this case, manual resetting is obligatory.









099











Refrigeration system faults

111			①	
121			②	Faulty condenser temperature sensor
131			③	
141			④	
112			①	
122			②	Faulty pressure transmitter sensor, refrigeration system
132			③	
142			④	
113			①	
123			②	Faulty refrigeration system, frost temperature sensor
133			③	
143			④	

High pressure switch safety or compressor electrical safety

115			①	<p>The compressor contactor is not connected although the CLIMATIC™ requests it.</p> <ul style="list-style-type: none"> - The high pressure pressostat is open. - The internal protection of the compressor motor is open.
125			②	The high pressure pressostat and the compressor motor thermal protection act directly on the compressor contactor. This information is transmitted to the CLIMATIC™ via an auxiliary contact of the contactor.
135			③	If the CLIMATIC™ gives the order to operate to the compressor and if the auxiliary contact is still open 5 seconds later, the fan safety system is activated and stops the compressor. The safety system automatically cuts out after 4 minutes.
145			④	It is also automatically locked out after 3 failures within a day. In this case, manual resetting is obligatory. The counter is reset to zero every evening at 20:00 if its value does not exceed 3 failures.

Faulty low pressure compressor

117			①	If the low pressure pressostat is open and the compressor has been operating for more than 2 minutes, the low pressure safety system is activated and stops the compressor. This safety system is not taken into account during the defrost cycle for the heat pump units.
127			②	The compressor is engaged when the pressostat contact closes.
137			③	It is also automatically locked out after 3 failures within a day. In this case, manual resetting is obligatory. The counter is reset to zero every evening at 20:00 if its value does not exceed 3 failures.
147			④	



- The network voltage should not vary from + or - 10 % of the supply required for the equipment,
- The supply variation between the phases should never exceed + or - 3 %.

1. Check that there is current in the electrical panel,
2. Check that the filters are not clogged,
3. Make sure the fans are in good working order (belts tensioned, etc...),
4. Test the operation of the compressor(s),
5. If the equipment is fitted with an electrical reset safety mechanism, reset it and test to see if the fault re-occurs. If so, have the following checks performed by trained personnel.

MAIN OPERATING FAULTS

No Air Flow (blower side)

Problem :

- Low performance.
- Danger of one or more compressors cutting out (low pressure switch cutout).
- Danger of evaporator freezing.
- Possible cutout of the electrical heaters safety thermostat.

Cause :

- The blow sleeve assemblies drop their load excessively (sleeves too small, closed valves, obstacle).
- Blocked filters or coils.
- Wrongly tensioned or broken belts.

Solution :

- Check the sleeve assemblies.
 - Check the filters, coils and service them, if necessary.
 - Check the belts, re-tension or replace them, if necessary.
-

No Air Flow (condenser side)

Problem :

- Compressor cutout (high pressure switches).

Cause :

- Dirty coils.
- One or more fans do not work properly.

Solution :

- Clean the coil.
 - Change one or more faulty fans.
-

Fan stops following thermal relay cutout (indicated via an error code)

Problem :

- The fan and the compressors are not working.

Cause :

- Drive absorbed power too high:
 - Air flow too high.
 - Belts over tensioned.
 - Bearing seized.
 - Phase Lost
 - Supply voltage too low or unbalanced phases (+/- 3%).

Solution :

- Reset the thermal relay.

If the error recurs:

- Check the thermal relay setting (it must correspond to the rated current shown on the drive plate).
 - Check the flow, belts and bearings.
 - Check the supply voltage.
-

Stopping compressor (indicated via an error code)

Problem :

- Thermal or freezing process drops or stops,

Causes :

- The compressor absorbs very high current (very hot air on the evaporator and condenser inlet, missing flow, voltage too low or unbalanced phases (+/- 3%).
- The compressor is manually out of action.
- The coil thermal safety is open.
- The compressor is powered by two phases instead of three.

Solution :

- Try to restart when the compressor is cold. If the fault recurs:
 - Check the air flows (see lack of air flow).
 - Check that the fans are working properly and the outer heat exchangers are clean.
 - Check the supply voltage.
 - If the compressor is manually out of action, replace it.
-

The unit no longer works**Cause :**

- No supply voltage.
- Ruptured remote control fuses.
- Wrong connections.

Solution :

- Check the supply voltage.
 - Check the fuses.
 - Check and tighten the connections.
-

The fan rotates but the compressor does not work**Problem :**

- The air rerun conditions are not followed.

Cause :

- The control does not engage the compressor(s), a pressure switch has tripped.
- The drive of the compressor(s) is out of action.

Solution :

- Check the control supply voltage.
 - Check the connections.
 - Reset the pressure switches (electrical control only).
 - Check the compressor supply voltage.
 - See previous sections.
-

Refrigerant fluid level too low**Problem :**

- Evaporator partly frozen.
- Low pressure switch cutout.

Cause:

- Refrigerant liquid leak.

Action:

- Search for leaks, repair if necessary and add some refrigerant liquid.
-

The electrical heater battery is not powered**Problem :**

- Variable temperatures,

Cause :

- One or more fuses are ruptured.
- The safety thermostat is open (temperature is too high due to insufficient air flow),

Solution :

- Check the electrical supply and fuses.
 - Check the ohmic values.
 - Reset the safety thermostat and check the air flow (first section)
-



Regular maintenance of your Rooftop will extend its operating life and reduce operating faults. We recommend that the unit is serviced by a trained refrigeration engineer.

A log book kept near the equipment detailing work carried out, by whom and when, is an excellent diagnostic tool.

The panel opening key is required for this work (see "TRANSPORT").

MOTOR-FAN ASSEMBLY

After 50 operating hours check the belt tension and the pulley screws for tightness. Repeat this check every two months. The fans contain bearings that are "lubricated for life", but we recommend replacing them every 10,000 operating hours. During this inspection, check the condition of the anti-vibration mounts, by looking for any cracks or signs of abnormal wear.

FILTERS

The filters fitted as standard are manufactured with a washable and recyclable material. The CLIMATIC™ indicates if they are blocked. The cleaning schedule is directly related to the environment in which the equipment is operated. However, monthly cleaning is recommended. A blocked filter will reduce the performance and reliability of the Rooftop.

After removing the filters, remove any dust and wash them in a tepid water solution with a little liquid detergent. After rinsing in fresh water, leave the filters to dry. Take all necessary precautions during operation to avoid damaging or piercing the media, as this would require the damaged cell to be replaced.

NOTE : The equipment must never be operated with the filters removed.

To avoid prolonged shutdown, always keep a spare filter set.

HEAT EXCHANGERS

The performance of your equipment is directly linked to the state of the heat exchangers, and it is therefore important to ensure that they are cleaned regularly.

EVAPORATOR COIL (INTERNAL)

The exchange area must be kept clean at all times. It is protected by the filters. If the filters are well maintained, the coil will only require occasional general cleaning.

A brief inspection should be carried out when servicing the filters.

CONDENSER COIL (EXTERNAL)

The condenser coil is not protected by the filters. The cleaning schedule is directly related to the environment in which the equipment is operated. A brief inspection should be carried out when servicing the machine. Cleaning can be performed using compressed air or a soft brush. Maximum caution is needed as the aluminium fins are relatively fragile.

However, this type of cleaning is sometimes difficult and relatively ineffective because the clogging is caused by a

mixture of grease vapour and powder. For this reason we would recommend cleaning with PRESTOSOL, a de-greasing agent with very low toxicity, non-flammable and which does not corrode standard metals.

As a rule, it is sufficient to apply the product to the fins, moving up and down and from left to right (as if you were painting it). If the coil is very blocked, it may be necessary to wait a few minutes after first applying the product and then continue.

This cleaning must be performed when the machine is switched off. In addition, prior to restarting the machine, we recommend waiting until the coil is fully drained and the solvent has totally evaporated.

HOT WATER COIL

At the start of the heating season, check the following :

- There is sufficient water in the system
- The coil has been correctly drained
- The percentage of antifreeze proportion is sufficient for the degree of protection required.

CONDENSATE TRAY AND DRAIN TRAP

The trap must be free of sediment and dirt which could block the movement of condensation. Check that the siphon is not obstructed. This inspection must be carried out at least once a year, preferably at the start of the air-conditioning season.

GAS BURNER

Once a year, before the heating season, clean the burners and the exchanger pipes using a nylon brush, the smoke box and the extraction fan.

Check that the air inlet pipe to the safety thermostats is not obstructed.

Check and adjust if necessary the min./max. pressure settings on the controllers.

Check the position of the ionisation sensors and check the ignition electrode.

To disassemble the burner, refer to the "GAS BURNER" section.

ELECTRICAL TERMINALS

At least once a year :

- Power down the machine, blow away any dust from inside the unit, and check and tighten if necessary the connections.
- Power up the machine, test the safety mechanisms.
- An analysis of the terminal in operating mode can throw light on any strange noises from the contactors or other units. Foreign bodies can disrupt the operation of the components and causes noisy vibration.

To avoid accidents, remember that this type of maintenance requires electrical expertise.



REFRIGERATION CIRCUITS

At least once a year, carry out an in-depth inspection of the refrigerant circuits.

In addition, before each season (or every 3 months if used permanently) the tasks listed in the maintenance contract must be performed, i.e. check the refrigerant charge, evaporation and condensing temperatures etc...

This work must be carried out by a trained refrigeration engineer. We shall therefore keep the details of the work and the type of checks to be performed to a minimum.

REFRIGERANT CHARGES valid for R407c and R22

Gamme FC/FH/FG/FD			Gamme FX		
Size	Nbr of circuits	kg	Size	Nbr of circuits	kg
50	1	9	25	2	2 x 4
60	2	7 + 7	30	2	2 x 4
70	2	8,5 + 8,5	35	2	2 x 5
85	2	13 + 13	40	2	2 x 6
100	2	13 + 13	55	2	2 x 6
120	2 + 1	(8 + 7,5) + 11	70	2	2 x 10
140	2 + 1	(9 + 9) + 11	85	2	2 x 11
160	4	4 x 11	100	2	2 x 12
190	4	4 x 11	110	4	4 x 7
			140	4	4 x 7,5
			170	4	4 x 8,5

**IN ACCORDANCE WITH THE LAW
REFRIGERATION FLUIDS MUST BE COLLECTED.
DEGASSING INTO THE ATMOSPHERE IS
FORBIDDEN.**



GENERAL

At least once a year after winter the equipment casing must be cleaned, inspected and if necessary treated for corrosion.

The equipment casing is made of aluminium-zinc plate, with a polyester finish and oven-treated powder, and is ultra-violet resistant. The assembly is fixed with stainless steel rivets. Any corrosion can only be caused by scratches incurred on assembly or during maintenance of the Rooftop.

MAINTENANCE SCHEDULE

NOTE :

6 monthly maintenance is performed when changing from the heating season to the air-conditioning season and vice-versa. Annual maintenance is performed just before the start of the air-conditioning season or the heating season, depending on the unit.

	After 50 hours	2 months	3 months	6 months	Annually
Fan motor assembly	X				
Gas burner					X
Terminal unit					X
Air-conditioning only					
Filters and internal coil		X			
External coil					X
Hot water coil					X
Condensate tray					X
Refrigerant system					X
Permanent operation					
Filters and internal coil		X			
External coil				X	
Condensate tray				X	
Refrigerant system				X	



TERMS AND CONDITIONS

In the absence of any other written agreement, the guarantee shall only apply to design faults which occur within a 12 month period (warranty period).

The warranty period starts on the date of commissioning and at the latest six months after the delivery of the Rooftop.

ANTI-CORROSION WARRANTY

10 year warranty terms and conditions for corrosion to the Rooftop casing :

Lennox shall guarantee the casing of its Rooftop units manufactured since May 1991 against corrosion for 10 years commencing from the date of delivery of the material.

The warranty shall not apply in the following cases :

1. If the corrosion of the casing is caused by external damage to the protective layer such as scratches, projections, abrasion, impacts etc...
2. If the casing is not kept continually clean in the course of maintenance work or by a specialist company,
3. If the casing is not cleaned and maintained in accordance with regulations,
4. If the Rooftop units are installed on a site or in an environment which is known to be corrosive, unless a special protective coating has been applied by the owner for these applications, which has been recommended by a competent body not linked to the owner and after carrying out a study of the site.

Note : With the exception of the casing, the rest of the machine is covered by the warranty of our general terms of sale.

DO NOT CONFUSE THE WARRANTY WITH MAINTENANCE

The warranty will only apply if a maintenance contract has been signed, starting from the date of commissioning, and if the maintenance contract has actually been performed.

The maintenance contract must be made with a specialist,

competent company.

The sole effect of any repair, modification or replacement of an item during the warranty period must be to extend the material's warranty period.

Maintenance must be carried out in accordance with regulations.

If a spare part is supplied after the expiry of the warranty period, it shall be guaranteed for a period equal to the initial warranty period and will be subject to the same conditions.

We recommend for a contract four inspections per year (every three months), before the start of each season, in order to check the operation of the equipment in the various operating modes.



CERTIFICATION



N° QUAL/2001/15834

Le Système Qualité adopté par :
The Quality System developed by :

LENNOX FRANCE DIVISION DE LGL FRANCE

pour les activités suivantes :
for the following activities :

**CONCEPTION, FABRICATION ET CESSION INTERNE DE ROOF TOP,
CENTRALES DE TRAITEMENT D'AIR ET ARMOIRES DE CLIMATISATION.**

**DESIGN, MANUFACTURING AND INTERNAL TRANSFER OF ROOF TOP,
AIR HANDLING UNIT AND CLOSED CONTROL UNITS.**

exercées sur le(s) site(s) suivant(s) :
carried out in the following location(s) :

2, rue Lavoisier ZI de Longvic BP 60 F-21602 LONGVIC CEDEX

a été évalué et jugé conforme aux exigences de la norme :
has been assessed and found to conform to the requirements of the standard :

ISO 9001 (1994)

Le certificat correspondant a été délivré dans les conditions d'application fixées par AFAQ le :
The corresponding certificate has been delivered under AFAQ application rules on :

2001-01-15

(année-mois-jour)

Il est valable jusqu'au*
It is valid until*

2003-12-14

(year-month-day)

DGI/0008 10 - 2000/06

LE PRÉSIDENT DU COMITÉ DE CERTIFICATION
THE PRESIDENT OF THE CERTIFICATION COMMITTEE

C. GUÉRIN

LE DIRECTEUR GÉNÉRAL D'AFAQ
THE MANAGING DIRECTOR OF AFAQ

O. PEYRAT

LE REPRÉSENTANT DE L'ENTREPRISE
ON BEHALF OF THE FIRM

E. MOUTON

*Sauf suspension notifiée entre temps par AFAQ à l'entreprise désignée ci-dessus. Le présent document n'a donc qu'une valeur indicative. Seule fait for la base de données des certificats AFAQ accessible à l'adresse internet : <http://www.afaq.org>
L'organisation AFAQ est conforme aux normes internationales en vigueur (guide ISO/IEC 62 - norme EN 45012). Les accréditations détenues par AFAQ et ses filiales sont disponibles à l'adresse internet : <http://www.afaq.org/accréditations>
The general information of AFAQ is available on the internet : <http://www.afaq.org>. The document is for information only. The only basis for the validity of the certificate is the AFAQ database accessible on the internet : <http://www.afaq.org>
The accreditation of AFAQ and its subsidiaries are available on the internet : <http://www.afaq.org/accréditations>

LENNOX® France

Site Industriel de LONGVIC
ZI de LONGVIC – BP 60
21602 LONGVIC – France

Téléphone : +33 (0)3 80 77 41 41
Fax : +33 (0)3 80 66 66 35

DECLARATION DE CONFORMITE DU CONSTRUCTEUR Conformément à la Directive européenne « Machines » 98/37/CE,

CE CONFORMITY DECLARATION As defined by « Machinery » European Directive 98/37/EC,

Nous, **LGL France SA, ZI Les Meurières – 69780 Mions - France**
We,

Déclarons par la présente et sous notre propre responsabilité que l'ensemble de nos fabrications de roof top désignés par les types suivants :
Hereby declare under our sole responsibility that the totality of the roof top we produce whose designations are :

FCA 50 / FCA 60 / FCA 70 / FCA 85 / FCA 100 / FCA 120 / FCA 140 / FCA 160 / FCA 190
FCK 50 / FCK 60 / FCK 70 / FCK 85 / FCK 100 / FCK 120 / FCK 140 / FCK 160 / FCK 190
FHA 50 / FHA 60 / FHA 70 / FHA 85 / FHA 100 / FHA 120 / FHA 140 / FHA 160 / FHA 190
FHK 50 / FHK 60 / FHK 70 / FHK 85 / FHK 100 / FHK 120 / FHK 140 / FHK 160 / FHK 190
FDA 50 / FDA 60 / FDA 70 / FDA 85 / FDA 100 / FDA 120 / FDA 140 / FDA 160 / FDA 190
FDK 50 / FDK 60 / FDK 70 / FDK 85 / FDK 100 / FDK 120 / FDK 140 / FDK 160 / FDK 190
FGA 50 / FGA 60 / FGA 70 / FGA 85 / FGA 100 / FGA 120 / FGA 140 / FGA 160 / FGA 190
FGK 50 / FGK 60 / FGK 70 / FGK 85 / FGK 100 / FGK 120 / FGK 140 / FGK 160 / FGK 190
FXA 25 / FXA 30 / FXA 35 / FXA 40 / FXA 55 / FXA 70 / FXA 85 / FXA 100
FXK 25 / FXK 30 / FXK 35 / FXK 40 / FXK 55 / FXK 70 / FXK 85 / FXK 100

Est conforme aux dispositions de la Directive « Machines », 98/37/CE
Is in compliance with the requirements of « Machinery », 98/37/EC

Est conforme aux dispositions de la Directive « Basse Tension », 78/23/CEE
Is in compliance with the requirements of « Low tension », 78/23/EEC

Est conforme aux dispositions de la Directive « CEM », 89/336/CEE
Is in compliance with the requirements of « EMC », 89/336/EEC

Est conforme aux dispositions de la Directive « Equipements sous pression », 97/23/CEE
Is in compliance with the requirements of « Under pressure equipments », 97/23/EEC

Est conforme aux dispositions de la Directive « Appareils à gaz », 90/396/CEE
Is in compliance with the requirements of « Gas machines », 90/396/EEC

Division LENNOX France
Z.I Les Meurières
69780 MIONS
TEL. 04.72.23.20.20
FAX 04.72.23.20.01



E. MOUTON
Directeur du site de Longvic

LENNOX France, Division climatisation de LGL France

Siège social : LGL France - 11, rue d'Alsace Lorraine - 69500 Bron - France
Société Anonyme au capital de 309.615.120F - RCS LYON B 309 528 115 - N° IDENTIFICATION TVA FR 59 309 528 115 - APE 292 F



PREFECTURE DE POLICE

CABINET DU PREFET

EU4

LABORATOIRE CENTRAL

39 bis, rue de Dantzig, 75015 PARIS

Téléphone : 01.55.76.20.00

Télécopie : 01.55.76.27.05

PROCES-VERBAL DE CLASSEMENT DE REACTION AU FEU D'UN MATERIAU

établi conformément à l'article 88 de l'arrêté du ministre de l'intérieur du 30 juin 1983
(J.O. du 1er décembre 1983) modifié par arrêté du 28 août 1991 (J.O. du 19 novembre 1991)

Valable 5 ans à partir de la date de délivrance

PROCES-VERBAL N° 610/97

et annexes de 6 pages

MATERIAU présenté par : S.A.D.I. S.A.
ROUTE NATIONALE 2
B.P. 24
59440 AVESNELLES

MARQUE COMMERCIALE : AR 300

DESCRIPTION SOMMAIRE : Média filtrant 100 % polyester ignifugé
Epaisseur apparente voisine de 19 millimètres
Masse au mètre carré : 210 grammes environ
Coloris blanc

RAPPORT D'ESSAI N° 610/97 DU 11 JUILLET 1997

NATURE DES ESSAIS : ESSAIS AU BRULEUR ELECTRIQUE ET ESSAIS DE PROPAGATION
DE FLAMME

CLASSEMENT

M1

DURABILITE du classement (annexe 22) : Non limitée a priori
compte tenu des critères résultant des essais décrits dans le rapport d'essai annexé.

Le classement indiqué ne préjuge pas de la conformité des matériaux commercialisés aux échantillons soumis aux essais et ne saurait en aucun cas être considéré comme un certificat de qualification tel que défini par la loi du 10 janvier 1978. Cette conformité peut être attestée par les certificats de qualification reconnus par le ministère chargé de l'industrie, et notamment par la marque NF-Réaction au feu.

A PARIS, le 11 juillet 1997

Responsable de l'Essai

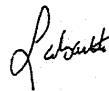

Jean-Claude LABARTHE

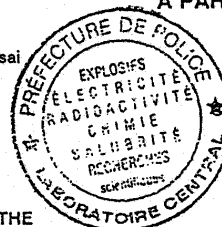

Pour le Directeur,
l'Ingénieur en Chef,
Chef du Service des Explosifs



Claude CALISTI

NOTA : Sont seules autorisées les reproductions intégrales et par photocopie du présent procès-verbal de classement ou de l'ensemble
procès-verbal de classement et rapport d'essai annexé.



AFNOR

CERTIFICAT D'EXAMEN CE DE TYPE

EC TYPE EXAMINATION CERTIFICATE

(Directive 90/396/CEE Appareils à gaz)
(Gas appliances directive 90/396/EEC)

Numéro : **49AR1674** (rév. 5)

L'AFNOR, après examen et vérifications, certifie que l'appareil :
AFNOR, after examination and verifications, certifies that the appliance:

- **Fabriqué par :**
Manufactured by **LENNOX FRANCE**
Z.I. LONGVIC
BP 60
F-21602 LONGVIC CEDEX
- **Marque commerciale et modèle(s) :**
Trade mark and model(s) : **LENNOX**
GM 033/2
- **Genre de l'appareil :**
Kind of the appliance : **MODULE DE CHAUFFAGE POUR**
CLIMATISEURS DE TOITURE
GAS AIR HEATER UNIT FOR ROOF TOP
- **Désignation du type :**
Type designation: **GM 033/2**

Pays de destination <i>Destination countries</i>	Pressions (mbar) <i>Pressures (mbar)</i>	Catégories <i>Categories</i>
FR	20/25 ; 37	I12Er3P
BE	20/25 ; 37	I2EB ; I3P
PT-CH-ES-GB	20 ; 37	I12H3P
DE	20 ; 50	I2E ; I3P
IT	20	I2H
NL	25 ; 37-50	I12L3P

est conforme aux exigences essentielles de la directive "Appareils à gaz" 90/396/CEE (29/06/1990).
is in conformity with the essential requirements of the "Gas appliances" directive 90/396/EEC (29/06/1990).

CE 0049

AFNOR

AFNOR CERTIFICATION
Le Directeur
Director

Rév. 5 : 49AR1674 du 96/09/02 Association Française de Normalisation
Tour Europe - 92049 Paris La Défense Cedex - France
Certification gaz : 58, rue du rocher - 75008 Paris
Tél. : +33 (0)1 47 54 32 95 - Télécopie : +33 (0)1 42 94 04 30

Jacques BESLIN

le : 2000/06/30

**AFNOR****CERTIFICAT D'EXAMEN CE DE TYPE****EC TYPE EXAMINATION CERTIFICATE****(Directive 90/396/CEE Appareils à gaz)
(Gas appliances directive 90/396/EEC)**Numéro : **49AR1675** (rév. 5)*L'AFNOR, après examen et vérifications, certifie que l'appareil ;
AFNOR, after examination and verifications, certifies that the appliance:*

- **Fabriqué par :**
Manufactured by **LENNOX FRANCE**
Z.I. LONGVIC
BP 60
F-21602 LONGVIC CEDEX
- **Marque commerciale et modèle(s) :**
Trade mark and model(s) : **LENNOX**
➤ **GM 060/2**
- **Genre de l'appareil :**
Kind of the appliance : **MODULE DE CHAUFFAGE POUR**
CLIMATISEURS DE TOITURE
GAS AIR HEATER UNIT FOR ROOF TOP
- **Désignation du type :**
Type designation: **GM 060/2**

Pays de destination <i>Destination countries</i>	Pressions (mbar) <i>Pressures (mbar)</i>	Catégories <i>Categories</i>
FR	20/25 ; 37	I12Er3P
BE	20/25 ; 37	I2EB ; I3P
PT-CH-ES-GB	20 ; 37	I12H3P
DE	20 ; 50	I2E ; I3P
IT	20	I2H
NL	25 ; 37-50	I12L3P

est conforme aux exigences essentielles de la directive "Appareils à gaz" 90/396/CEE (29/06/1990).
is in conformity with the essential requirements of the "Gas appliances" directive 90/396/EEC (29/06/1990).

CE 0049**AFNOR CERTIFICATION****Le Directeur**
*Director***AFNOR**
Jacques BESLIN**Association Française de Normalisation**

Rév. 5 : 49AR1675 du 96/09/02 pour Europe - 92049 Paris La Défense Cedex - France

Certification gaz : 58, rue du rocher - 75008 Paris

Tél. : +33 (0)1 47 54 32 95 - Télécopie : +33 (0)1 42 94 04 30

le : 2000/06/30

**AFNOR****CERTIFICAT D'EXAMEN CE DE TYPE****EC TYPE EXAMINATION CERTIFICATE****(Directive 90/396/CEE Appareils à gaz)
(Gas appliances directive 90/396/EEC)****Numéro : 49AR1860** (rév. 5)*L'AFNOR, après examen et vérifications, certifie que l'appareil :
AFNOR, after examination and verifications, certifies that the appliance:*

- **Fabriqué par :**
Manufactured by **LENNOX FRANCE**
Z.I. LONGVIC
BP 60
F-21602 LONGVIC CEDEX
- **Marque commerciale et modèle(s) :**
Trade mark and model(s) : **LENNOX**
➤ GM 120/2
- **Genre de l'appareil :**
Kind of the appliance : **MODULE DE CHAUFFAGE POUR
CLIMATISEURS DE TOITURE**
GAS AIR HEATER UNIT FOR ROOF TOP
- **Désignation du type :**
Type designation: **GM 120/2**

Pays de destination <i>Destination countries</i>	Pressions (mbar) <i>Pressures (mbar)</i>	Catégories <i>Categories</i>
FR	20/25 ; 37	I12Er3P
BE	20/25 ; 37	I2EB ; I3P
PT-CH-ES-GB	20 ; 37	I12H3P
DE	20 ; 50	I2E ; I3P
IT	20	I2H
NL	25 ; 37-50	I12L3P

est conforme aux exigences essentielles de la directive "Appareils à gaz" 90/396/CEE (29/06/1990).
is in conformity with the essential requirements of the "Gas appliances" directive 90/396/EEC (29/06/1990).

CE 0049**AFNOR****AFNOR CERTIFICATION****Le Directeur***Director***Jacques BESLIN**

Rév. 5 : 49AR1860 du 96/09/02

le : 2000/06/30

Association Française de Normalisation
Tour Europe - 92049 Paris La Défense Cedex - France
Certification gaz : 58, rue du rocher - 75008 Paris

Tél. : +33 (0)1 47 54 32 95 - Télécopie : +33 (0)1 42 94 04 30

**AFNOR****CERTIFICAT D'EXAMEN CE DE TYPE****EC TYPE EXAMINATION CERTIFICATE****(Directive 90/396/CEE Appareils à gaz)
(Gas appliances directive 90/396/EEC)****Numéro : 49BL3276***L'AFNOR, après examen et vérifications, certifie que l'appareil :
AFNOR, after examination and verifications, certifies that the appliance:*

- **Fabriqué par :**
Manufactured by **LENNOX FRANCE**
Z.I. LONGVIC
BP 60
F-21602 LONGVIC CEDEX
- **Marque commerciale et modèle(s) :**
Trade mark and model(s) : **LENNOX**
➤ **GM 180/4**
- **Genre de l'appareil :**
Kind of the appliance : **MODULE DE CHAUFFAGE POUR**
CLIMATISEURS DE TOITURE
GAS AIR HEATER UNIT FOR ROOF TOP
- **Désignation du type :**
Type designation: **GM 180/4**

Pays de destination <i>Destination countries</i>	Pressions (mbar) <i>Pressures (mbar)</i>	Catégories <i>Categories</i>
FR	20/25 ; 37	I12Er3P
BE	20/25 ; 37	I2EB ; I3P
PT-CH-ES-GB	20 ; 37	I12H3P
DE	20 ; 50	I2E ; I3P
IT	20	I2H
NL	25 ; 37-50	I12L3P

est conforme aux exigences essentielles de la directive "Appareils à gaz" 90/396/CEE (29/06/1990).
is in conformity with the essential requirements of the "Gas appliances" directive 90/396/EEC (29/06/1990).

CE 0049**AFNOR****AFNOR CERTIFICATION**
Le Directeur
Director

49BL3276

le : 2000/06/30

Association Française de Normalisation
 Tour Europe - 92049 Paris La Défense Cedex - France
 Certification gaz : 58, rue du rocher - 75008 Paris
 Tél. : +33 (0)1 47 54 32 95 - Télécopie : +33 (0)1 42 94 04 30

Jacques BESLIN



SÉCURITÉ FEU
Réaction au feu



Accréditation
n° 1-0300

PROCÈS-VERBAL DE CLASSEMENT DE RÉACTION AU FEU D'UN MATÉRIAU

Prévu à l'article 88 de l'Arrêté du Ministère de l'Intérieur du 30 juin 1983,
modifié par l'arrêté du 28 août 1991
Laboratoire pilote agréé du Ministère de l'Intérieur (arrêté du 05/02/59, modifié)

N° RA00-461

Valable 5 ans à compter du 17 octobre 2000

Matériau présenté par : La Société SAINT GOBAIN ISOVER FRANCE
Les Miroirs
18 avenue d'Alsace
92400 COURBEVOIE

Marque commerciale : CLIMAVER 202 - FIB-AIR ISOL

Description sommaire :
Feutre en laine de verre (fibres de verre liées par une résine thermodurcissable) revêtu sur une face d'une feuille d'aluminium renforcée d'une grille de verre. Le complexe aluminium est contrecollé à l'aide d'une colle polyéthylène.
Épaisseurs : 25 à 50 mm. Masse volumique nominale de la laine de verre : 30 kg/m³

Nature de l'essai : Essai par rayonnement avec joint simulé suivant avis CECMI en date du 08 avril 1993.
Mesure du Pouvoir Calorifique Supérieur

Classement :

MO

Durabilité du classement (Annexe 22) : Non limitée
compte tenu des critères résultant des essais décrits dans le rapport d'essais N° RA00-461 annexé.

Le classement indiqué ne préjuge pas de la conformité des matériaux commercialisés aux échantillons soumis aux essais et ne saurait en aucun cas être considéré comme un certificat de qualification tel que défini par la loi. Cette conformité peut être attestée par les certificats de qualification reconnus par le ministère chargé de l'Industrie, et notamment par la marque NF - Réaction au Feu.

Champs/Marne le : 17 octobre 2000

Le technicien vérificateur

Bruce LE MADEC

Le Chef du laboratoire Réaction feu
responsable de l'essai

Martial BONHOMME

Sont seules autorisées les reproductions intégrales du présent procès-verbal de classement ou de l'ensemble procès-verbal de classement et rapport d'essais annexé.

PARIS - MARNE-LA-VALLÉE - GRENOBLE - NANTES - SOPHIA ANTIPOLIS
CENTRE SCIENTIFIQUE ET TECHNIQUE DU BÂTIMENT

84, avenue Jean-Jaurès - Champs-sur-Marne - BP 2 - F-77421 Marne-la-Vallée Cedex 2



MARQUE NF
MATERIELS DE DETECTION INCENDIE



Organisme certificateur : **AFNOR CERTIFICATION**

Tour Europe - 92049 PARIS LA DEFENSE cedex

☎ (33)1 42 91 55 55 - Fax : (33)1 42 91 56 86

Organisme mandaté : **Comité National Malveillance Incendie Sécurité S.A.S**

C.N.M.I.S SAS - 16 avenue Hoche - 75008 PARIS

☎ (33)1 53 89 00 40 - Fax : (33)1 45 63 40 63

Site Internet <http://www.cnmis.org>

Email : cnmis@cnmis.org

ATTESTATION DE DROIT D'USAGE DE LA MARQUE NF
(LICENCE)

N° DROIT D'USAGE

DAD 013 H0

La Société :

LA COMPAGNIE DU SPHINX

Pour son usine de

15, rue du Général Négrier

78800 HOUILLES

Correspondant C.N.M.I.S SAS

José CAMPO

Té : 01 53 89 00 48

Fax : 01 45 63 40 63

Date de fin de validité :

31/01/2002

N° Dossier C.N.M.I.S SAS

99 03 23

Conformité aux normes :

NF S 61-950 de Novembre 1985

NF S 61-961 de Septembre 1989

MODIFICATIONS

Est autorisée à apposer la marque NF sur le matériel désigné ci-après :

Désignation technique du matériel	: Détecteur Autonome Déclencheur
Désignation commerciale	: LOTUS II
Caractéristiques certifiées	: Type II (Les autres caractéristiques sont reprises dans les rapports d'essai)
Ce matériel fonctionne avec	: Voir certificat d'association correspondant
Références et date du rapport d'essais	: DH 96 01 26 E du 17 Mars 1999
Fonctions supplémentaires	: Voir rapport d'essai

N.B : Cette décision dispense le titulaire de la présentation des Procès Verbaux d'essai de conformité aux normes du matériel ci-dessus.

PARIS, le 12 Février 2001
Pour AFNOR CERTIFICATION
Le C.N.M.I.S. SAS

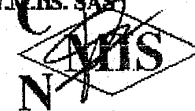

LA SÉCURITÉ CERTIFIÉE
Le Directeur Général
Denis CLUZEL



AGGREGATION N° 5-015/07

Cette décision annule et remplace toute attestation antérieure.

Le droit d'usage de la marque NF est accordé voir date de fin de validité à compter de la présente décision, sous réserve des contrôles effectués par AFNOR CERTIFICATION ou le C.N.M.I.S SAS qui peuvent prendre toute sanction conformément aux Règles générales de la marque NF et au règlement.



MARQUE NF
MATERIELS DE DETECTION INCENDIE



Organisme certificateur : **AFNOR CERTIFICATION**
Tour Europe - 92049 PARIS LA DEFENSE cedex
☎ (33)1 42 91 55 55 - Fax : (33)1 42 91 56 86
Organisme mandaté : **Comité National Malveillance Incendie Sécurité S.A.S**
C.N.M.I.S SAS - 16 avenue Hoche - 75008 PARIS
☎ (33)1 53 89 00 40 - Fax : (33)1 45 63 40 63
Site Internet <http://www.cnmis.org>
Email : cnmis@cnmis.org

ATTESTATION DE DROIT D'USAGE DE LA MARQUE NF
(LICENCE)

N° DROIT D'USAGE
DAD 020 B0

La Société : **ANELEC**
Pour son usine de : **37, place de Loire SILIC 139**
94523 RUNGIS CEDEX

Correspondant CNMIS
José CAMPO
Tél. : 01 53 89 00 48
Fax : 01 45 63 40 63

Date de fin de validité :
Le 31/01/2002

N° Dossier CNMIS
99 06 55
Conformité aux normes :
NF S 61-950 de Novembre 1985
NF S 61-961 de Septembre 1989

MODIFICATIONS

Est autorisée à apposer la marque NF sur le matériel désigné ci-après :

Désignation technique du matériel	:	Détecteur Autonome Déclencheur
Désignation commerciale	:	DAD 4480 CGDI
Caractéristiques certifiées	:	Type 2 <i>(Les autres caractéristiques sont reprises dans les rapports d'essai)</i>
Ce matériel fonctionne avec	:	Le détecteur SIJ-EF (E4 064 B0) <i>(Les autres produits associés sont repris dans les certificats d'association)</i>
Références et date du rapport d'essais	:	DH 95 01 11 du 14/03/96
Fonctions supplémentaires	:	Voir rapport d'essai

N.B : Cette décision dispense le titulaire de la présentation des Procès Verbaux d'essai de conformité aux normes du matériel ci-dessus.

PARIS, le 31 Janvier 2001
Pour AFNOR CERTIFICATION
Le C.N.M.I.S. S.A.S



LA SECURITE CERTIFIEE
Le Directeur Général
Denis CLUZEL



ACCREDITATION N° 5-0015

Cette décision annule et remplace toute attestation antérieure.
Le droit d'usage de la marque NF est accordé voir date de fin de validité à compter de la présente décision, sous réserve des contrôles effectués par AFNOR CERTIFICATION ou le C.N.M.I.S SAS qui peuvent prendre toute sanction conformément aux Règles générales de la marque NF et au règlement.



MARQUE NF
MATERIELS DE DETECTION INCENDIE



Organisme certificateur : **AFNOR CERTIFICATION**
Tour Europe - 92049 PARIS LA DEFENSE cedex
☎ (33)1 42 91 55 55 - Fax : (33)1 42 91 56 86

Organisme mandaté : **Comité National Malveillance Incendie Sécurité S.A.S**
C.N.M.I.S SAS - 16 avenue Hoche - 75008 PARIS
☎ (33)1 53 89 00 40 - Fax : (33)1 45 63 40 63
Site Internet <http://www.cnmis.org>
Email : cnmis@cnmis.org

ATTESTATION DE DROIT D'USAGE DE LA MARQUE NF
(LICENCE)

N° DROIT D'USAGE
E4 074 A0

La Société : **LA COMPAGNIE DU SPHINX**
Pour son usine de **15, rue du Général Négrier**
78800 HOUILLES

Correspondant C.N.M.I.S SAS
José CAMPO Tél : **01 53 89 00 48**
Fax : **01 45 63 40 63**

Date de fin de validité :
31/01/2002

N° Dossier C.N.M.I.S SAS
99 03 20

Conformité aux normes :
Pr EN 54-7 de Juillet 1997
NF S 61-950 de Novembre 1985

MODIFICATIONS

Est autorisée à apposer la marque NF sur le matériel désigné ci-après :

Désignation technique du matériel : **Détecteur ionique de Fumée**

Désignation commerciale : **ZI-100**

Caractéristiques certifiées : **Conventionnel, ponctuel et avec indicateur d'action**
(Les autres caractéristiques sont reprises dans les rapports d'essai)

Ce matériel fonctionne avec : **Voir liste des matériels associés**

Références et date du rapport d'essais : **DH 99 01 11 du 1^{er} Juillet 1999**

Fonctions supplémentaires : **Voir rapport d'essai**

N.B : Cette décision dispense le titulaire de la présentation des Procès Verbaux d'essai de conformité aux normes du matériel ci-dessus.

PARIS, le 12 Février 2001
Pour AFNOR CERTIFICATION
Le C.N.M.I.S. SAS



Le Directeur Général
Denis CLUZEL



Cette décision annule et remplace toute attestation antérieure.

Le droit d'usage de la marque NF est accordé voir date de fin de validité à compter de la présente décision, sous réserve des contrôles effectués par AFNOR CERTIFICATION ou le C.N.M.I.S SAS qui peuvent prendre toute sanction conformément aux Règles générales de la marque NF et au règlement.

ACCREDITATION N° 3-01567

**GREAT BRITAIN ,
IRELAND :**

LENNOX INDUSTRIES LTD

tél. : + 44 1604 599400
fax : + 44 1604 594200
e-mail : marketing@lennoxind.com

BELGIUM :

LENNOX BENELUX N.V./S.A.

tel. : + 32 3 633 30 45
fax : + 32 3 633 00 89
e-mail : info.be@lennoxbenelux.com

CZECH REPUBLIC :

JANKA RADOTIN AS

tel. : + 420 2 510 88 111
fax : + 420 2 579 10 393
e-mail : janka@janka.cz

FRANCE :

LENNOX FRANCE

tel. : + 33 4 72 23 20 20
fax : + 33 4 78 20 07 76
e-mail : accueil@lennoxfrance.com

GERMANY :

LENNOX DEUTSCHLAND GmbH

tel. : + 49 69 42 09 79 0
fax : + 49 69 42 09 79 40
e-mail : info.de@lennoxdeutschland.com

NETHERLANDS :

LENNOX BENELUX B.V.

tel. : + 31 33 2471 800
fax : + 31 33 2459 220
e-mail : info@lennoxbenelux.com

POLAND :

LENNOX POLSKA Sp. z o. o.

tel. : + 48 22 832 26 61
fax : + 48 22 832 26 62
e-mail : lennoxpolska@inetia.pl

PORTUGAL :

LENNOX CLIMATIZAÇÃO LDA.

tel. : +351 22 999 84 60
fax : +351 22 999 84 68
e-mail : info@lennoxportugal.com

RUSSIA :

LENNOX DISTRIBUTION MOSCOW

tel. : + 7 095 246 07 46
fax : + 7 502 933 29 55
e-mail : lennox.dist.moscow@mtu-net.ru

SLOVAKIA :

LENNOX SLOVAKIA

tel. : + 421 7 44 87 19 27
fax : + 421 7 44 88 64 72

SPAIN :

LENNOX REFAC S.A.

tel. : + 34 902 400 405
fax : + 34 91 542 84 04
e-mail : marketing@lennox-refac.com

UKRAINE :

LENNOX DISTRIBUTION KIEV

tel. : + 380 44 213 14 21
fax : + 380 44 213 14 21
e-mail : jankauk@uct.kiev.ua

**OTHER EUROPEAN COUNTRIES,
AFRICA,
MIDDLE-EAST :**

LENNOX DISTRIBUTION

tel. : + 33 4 72 23 20 14
fax : + 33 4 72 23 20 28
e-mail : marketing@lennoxdist.com



LENNOX[®]

www.Lennox.com