

# Service Manual

Split-Type Air Conditioner



**This manual is for professional  
maintenance personnel only**

## CONTENTS

<b>Part I : Technical Information.....</b>	<b>4</b>
<b>1. Summary.....</b>	<b>4</b>
1-1 Appearance.....	4
1-2 Model List.....	5
<b>2. Outline Dimension Diagram.....</b>	<b>6</b>
<b>3. Specification sheet.....</b>	<b>9</b>
<b>4. Function and Control.....</b>	<b>13</b>
4-1 T-Style.....	13
<b>5. Refrigerant System Diagram.....</b>	<b>20</b>
5-1 Cooling Only.....	20
5-2 Cooling & Heating.....	21
<b>6. Electrical Part.....</b>	<b>23</b>
6-1 Electrical Wiring Diagram.....	23
<b>Part II : Installation and Maintenance.....</b>	<b>25</b>
<b>7. Main Tools for Installation and Maintenance.....</b>	<b>25</b>
<b>8. Installation.....</b>	<b>26</b>
8-1 Notes for Installation.....	26
8-2 Installation of Indoor Unit.....	27
8-3 Installation of outdoor Unit.....	30
8-4 Check after installation and test operation.....	33
<b>9. Maintenance.....</b>	<b>35</b>
9-1 Troubleshooting Guide.....	35
9-2 Troubleshooting for Normal Malfunction.....	46
<b>10. Exploded Views and Parts List.....</b>	<b>53</b>
10-1 Indoor Unit.....	53
10-2 Outdoor Unit.....	55
<b>11. Removal Procedure.....</b>	<b>57</b>
11-1 Indoor Unit.....	57
11-2 Outdoor Unit.....	60
<b>Appendix.....</b>	<b>65</b>
AUX Common Sensor R-T Analysis Table.....	65

## **Part I : Technical Information**

### **1. Summary**

#### **1-1 Appearance**

➤ **Indoor Unit**

**JO**



➤ **Outdoor Unit**

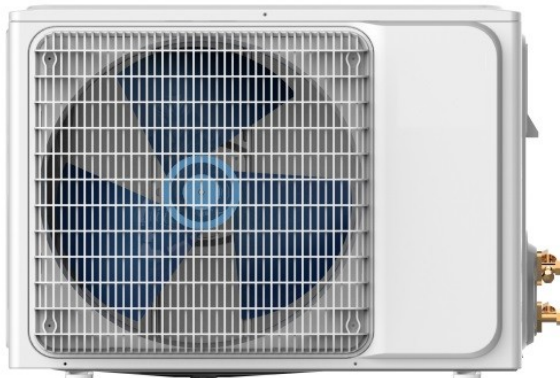

**Note:** The outdoor grille can be replaced.

## 1-2 Model List

NO.	MODEL
1	ASW-H09B5A4/JAR1-B7
2	ASW-H12C1A4/JAR1-C0
3	ASW-H18D8A4/JAR1-B8
4	ASW-H24F0D4/JAR1-B9

## 2. Outline Dimension Diagram

The following data is for reference only and the actual size may vary.)

### 2-1 Indoor Unit (Unit: mm)

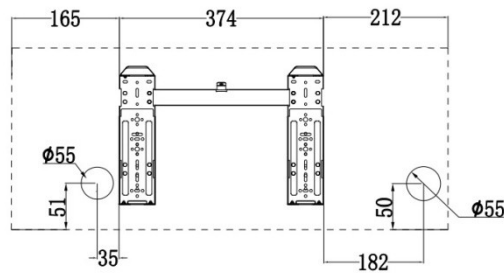
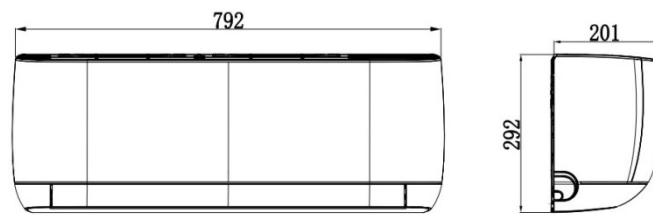

09、12K

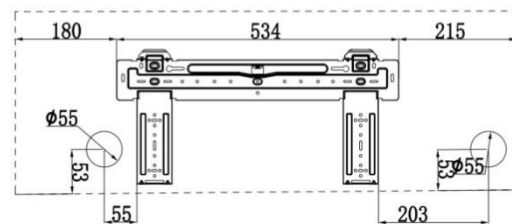
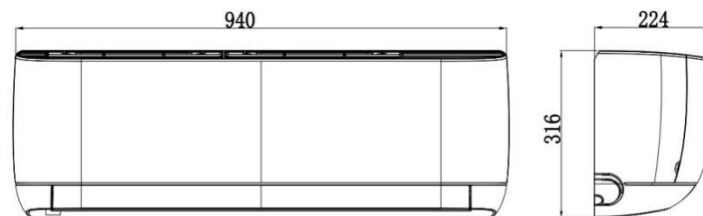

18K

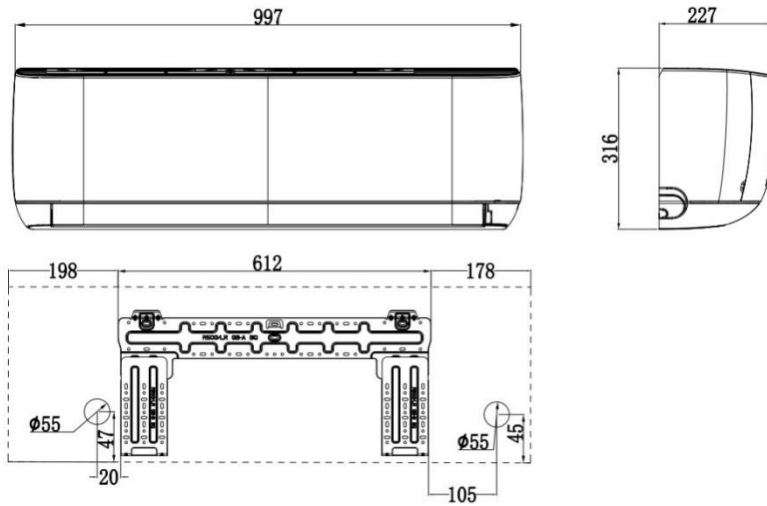

24K

**2-2 Outdoor Unit (Unit: mm)**

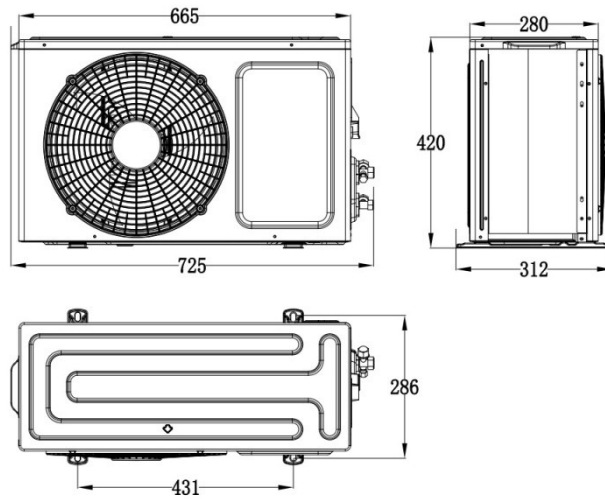

09K

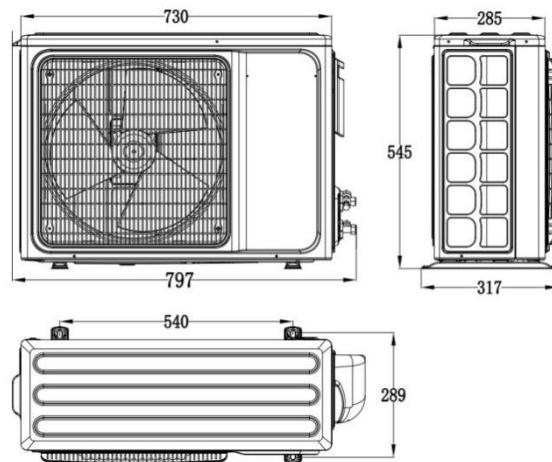

12K

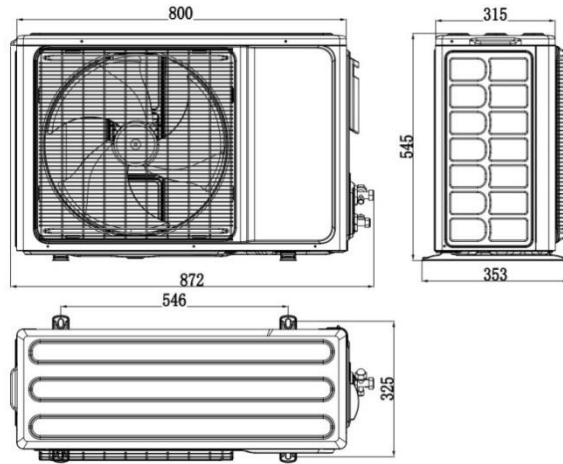

18K

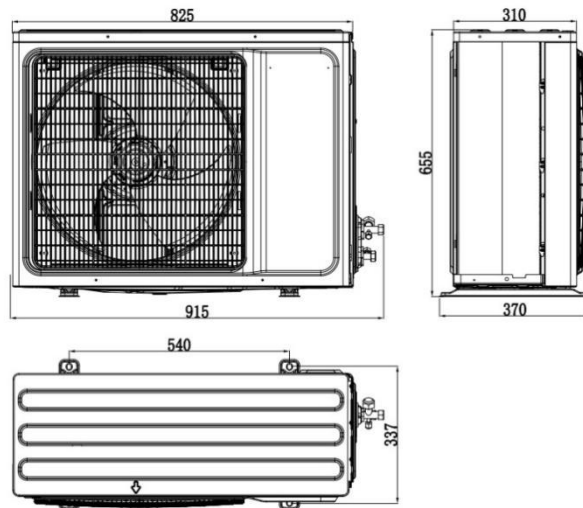

24K



### 3. Specification sheet

Product Model				ASW-H09B5A4/JAR1-B7	
Nameplate Parameter	Rated Capacity	Cooling		W	2600
		Heating		W	2500
		Dehumidifying		Kg/h	0.5
	Rated Power Consumption	Cooling		W	830
		Heating		W	720
	Rated Running Current	Cooling		A	3.25
		Heating		A	2.9
	Electric heating power			W	/
	Max. Input Power			W	1100
	Max. Input Current			A	5.9
	EER Cooling			W/W	3.13
	COP Heating			W/W	3.47
	Power supply source			V/Ph/Hz	220-240V-1-50Hz
	Refrigerant				R410A
	Refrigerant Charged			g	600
	Max. Discharge Pressure			Mpa	4.15
	Max. Suction Pressure			Mpa	1.15
	Air Flow Volume			m <sup>3</sup> /h	600
	Noise level			dB (A)	43
	Noise level			dB (A)	52
Indoor unit weight (Net)			Kg	7.5	
Outdoor unit weight (Net)			Kg	23.5	
Indoor unit configuration	evaporator	Tube	Length	mm	560
			Diameter	mm	7
	Motor system	Motor	Model	Pcs	YYK18-4B
	Dimension	Net Dimension(W*D*H)		mm	792×292×201
Packing Dimension(W*D*H)		mm	880×370×290		
Connection	Stop Valve		Liquid Valve		Dg4
			Gas Valve		Dg8
Outdoor unit configuration	Compressor Model				KSM95V13UDZK
	Compressor Parameter	Brand			GMCC
	Motor system	Motor	Model		YDK25-6
	Condenser	Tube	Length	mm	676
			Diameter	mm	7
	Dimension	Net Dimension (W*D*H)		mm	665×420×280
Packing Dimension (W*D*H)		mm	760×480×345		
Container Loading 20/40/40HC			Set		320

Product Model			ASW-H12C1A4/JAR1-C0		
Nameplate Parameter	Rated Capacity	Cooling	W	3550	
		Heating	W	3550	
		Dehumidifying	Kg/h	1	
	Rated Power Consumption	Cooling	W	1090	
		Heating	W	970	
	Rated Running Current	Cooling	A	4.7	
		Heating	A	4.2	
	Electric heating power		W	/	
	Max. Input Power		W	1300	
	Max. Input Current		A	7.0	
	EER Cooling		W/W	3.26	
	COP Heating		W/W	3.66	
	Power supply source		V/Ph/Hz	220-240V-1-50Hz	
	Refrigerant			R410A	
	Refrigerant Charged		g	880	
	Max. Discharge Pressure		Mpa	4.15	
	Max. Suction Pressure		Mpa	1.15	
	Air Flow Volume		m <sup>3</sup> /h	600	
	Noise level		dB (A)	44	
	Noise level		dB (A)	53	
Indoor unit weight (Net )		Kg	8.5		
Outdoor unit weight (Net )		Kg	29.0		
Indoor unit configuration	evaporator	Tube	Length	mm	560
			Diameter	mm	7
	Motor system	Motor	Model	Pcs	YYK18-4B
	Dimension	Net Dimension(W*D*H)		mm	792×292×201
Packing Dimension(W*D*H)		mm	880×370×290		
Connection	Stop Valve		Liquid Valve		Dg4
			Gas Valve		Dg10
Outdoor unit configuration	Compressor Model			ASM125V1VFT	
	Compressor Parameter	Brand		GMCC	
	Motor system	Motor	Model	YDK25-6	
	Condenser	Tube	Length	mm	702
			Diameter	mm	7
	Dimension	Net Dimension (W*D*H)		mm	730×545×285
Packing Dimension (W*D*H)		mm	850×620×370		
Container Loading 20/40/40HC			Set	239	

Product Model			ASW-H18D8A4/JAR1-B8		
Nameplate Parameter	Rated Capacity		Cooling	W	5000
			Heating	W	5280
			Dehumidifying	Kg/h	1.6
	Rated Power Consumption		Cooling	W	1560
			Heating	W	1460
	Rated Running Current		Cooling	A	7.5
			Heating	A	6.2
	Electric heating power			W	/
	Max. Input Power			W	2000
	Max. Input Current			A	11
	EER Cooling			W/W	3.21
	COP Heating			W/W	3.62
	Power supply source			V/Ph/Hz	220-240V-1-50Hz
	Refrigerant				R410A
	Refrigerant Charged			g	1080
	Max. Discharge Pressure			Mpa	4.15
	Max. Suction Pressure			Mpa	1.15
	Air Flow Volume			m <sup>3</sup> /h	850
	Noise level			dB (A)	47
	Noise level			dB (A)	55
Indoor unit weight (Net )			Kg	12	
Outdoor unit weight (Net )			Kg	36.5	
Indoor unit configuration	evaporator	Tube	Length	mm	670
			Diameter	mm	7
	Motor system	Motor	Model	Pcs	YYK25-4D
	Dimension	Net Dimension(W*D*H)		mm	940×316×224
Packing Dimension(W*D*H)		mm	1010×385×307		
Connection	Stop Valve		Liquid Valve		Dg4
			Gas Valve		Dg10
Outdoor unit configuration	Compressor Model				ASL190UY-C7EQD
	Compressor Parameter	Brand			HIGHLY
	Motor system	Motor	Model		YDK31-6A
	Condenser	Tube	Length	mm	869
			Diameter	mm	9.52
	Dimension	Net Dimension (W*D*H)		mm	800×545×315
Packing Dimension (W*D*H)		mm	920×620×400		
Container Loading 20/40/40HC			Set		194

Product Model				ASW-H24F0D4/JAR1-B9	
Nameplate Parameter	Rated Capacity	Cooling		W	7000
		Heating		W	7200
		Dehumidifying		Kg/h	3
	Rated Power Consumption	Cooling		W	2150
		Heating		W	1970
	Rated Running Current	Cooling		A	9
		Heating		A	8.8
	Electric heating power			W	/
	Max. Input Power			W	2600
	Max. Input Current			A	14.1
	EER Cooling			W/W	3.26
	COP Heating			W/W	3.65
	Power supply source			V/Ph/Hz	220-240V-1-50Hz
	Refrigerant				R410A
	Refrigerant Charged			g	1450
	Max. Discharge Pressure			Mpa	4.15
	Max. Suction Pressure			Mpa	1.15
	Air Flow Volume			m3/h	1020
	Noise level			dB (A)	50
	Noise level			dB (A)	58
Indoor unit weight (Net)			Kg	13.5	
Outdoor unit weight (Net)			Kg	36	
Indoor unit configuration	evaporator	Tube	Length	mm	722
			Diameter	mm	7
	Motor system	Motor	Model	Pcs	YYK50-4
	Dimension	Net Dimension(W*D*H)			mm
Packing Dimension(W*D*H)			mm	1070×385×312	
Connection	Stop Valve		Liquid Valve		Dg4
			Gas Valve		Dg13
Outdoor unit configuration	Compressor Model				ASG240V1VMU
	Compressor Parameter	Brand			GMCC
	Motor system	Motor	Model		YDK69-6A
	Condenser	Tube	Length	mm	791
			Diameter	mm	7
	Dimension	Net Dimension (W*D*H)			mm
Packing Dimension (W*D*H)			mm	945×725×435	

## 4. Function and Control

### 4-1 T-Style

#### 1) Remote Controller Introductions

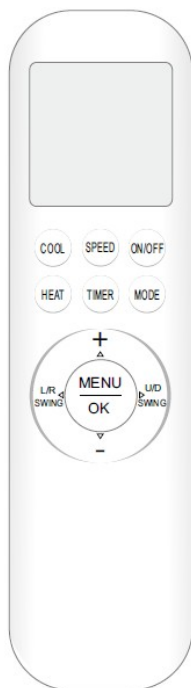

- Carefully read this “instructions” for safe and correct use of the air-conditioner.
- carefully keep the “instructions” manual as it can be referred to at any time.

#### ➤ Buttons description

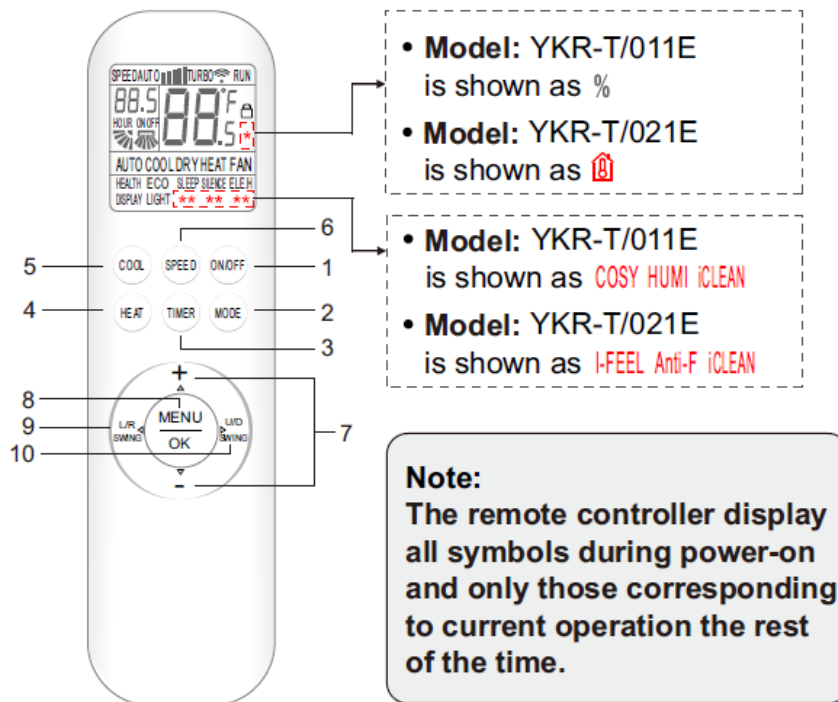

### 1. ON/OFF Button

- \* Press this button to turn on/off the unit.
- \* This will clear the existing timer and SLEEP settings.

### 2. MODE Button

- \* Press this button, you can select the running mode as follows:

Note: HEAT mode is not available for cool only units.

### 3. TIMER Button

- \* With the unit ON, press this button to set OFF timer or with it OFF to set ON timer.
- \* Press this button once, the “ON(OFF)” will flash. Press “ + ” or “ - ”to set the number of hours in which the unit will be turned ON/OFF, with an interval of 0.5 hour , and a range of 0.5-24 hours.
- \* Press it again to confirm the setting, the “ON (OFF)” will stop flashing.

### 4. HEAT Button

- \* Press this button to enter HEAT mode.

### 5. COOL Button

- \* Press this button to enter COOL mode.

### 6. SPEED Button

- \* Press this button, you can select the motor speed as follows:

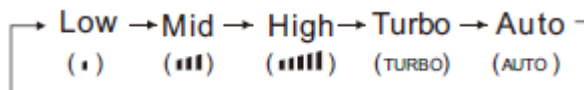

**Note:** AUTO air speed is not available in fan mode.

**This button is invalid in dry mode.**

### 7. + & - Button





- \* Each time the “ + ” is pressed, the temperature setting will increase by 1°C(1°F) and





each time the “ - ” is pressed, it will decrease by 1°C(1°F) .

\* The temperature setting ranges from 16°C (60°F)~32°C(90°F).

**Note:** The temperature cannot be set in AUTO or Fan mode.

### 8. MENU & OK Button

\* Press MENU button to enter the function selection mode. Then press , ,   
and  to choose the function which you want. After, press OK button, turn on this function.

\* In function selection mode, press , ,  and , the character in LCD will be flashing if the function can be selected.

### 9. L/R SWING Button

\* Press this button to activate left/right swing and press it again to fix the swing position.

### 10. U/D SWING Button





\* Press this button to activate up/down swing and press it again to fix the swing position.

### Note:

\* When the unit is on, press the “U/D SWING” button and hold for 3 seconds, the button will shift to be the functional button of “Rated swinging”, and then press the “U/D SWING” button to select the positions of Rated swinging.

\* Only by pressing the “U/D SWING” button again and hold for 3 seconds or reinstall the battery of the remote control, can the “U/D SWING” button resume its original function. The power on/off button of the remote control cannot enable the exit of the “Rated swinging” function.

### 11. HEALTH





\* When the unit is on, press MENU button ,then press , ,  and  to choose “HEALTH” character, when the “HEALTH” character will blink, and press the “OK” button to highlight (not highlight) the “HEALTH” character, which will activate (deactivate) the health function.

### 12. ECO

\* In COOL mode, the variable frequency air-conditioner will enter the ECO mode, which consumes the least electricity, and exit it automatically 8 hours after.





\* The ECO mode is not available on the fixed frequency air-conditioner.

\* Changing modes or turning off the remote controller will automatically cancel the ECO function.

\* In the cooling mode, press the “MENU” button, press , ,  and  to choose the “ECO” character, when the “ECO” character will blink, and press the “OK” button to highlight (not highlight) the “ECO” character , which will activate (deactivate) the ECO function.

**Note:** The electricity consumption is affected by the ambient temperature and the house structure etc., and when the ambient temperature is high or the house has a large area, be cautious to use the ECO mode.

### 13. SLEEP





\* When the unit is on, press MENU button ,then press  ,  ,  and  to choose the “SLEEP” character, when the “SLEEP” character will blink, and press the “OK” button to highlight (not highlight ) the “SLEEP” character , which will activate (deactivate) the function of sleep mode.

\* The unit will exit SLEEP mode after 10 hours of continuous operation and restore to the previous status.





**Note:** The SLEEP function cannot be activated in FAN and AUTO mode.

In the sleep mode, the screen of the air-conditioner is off.

### 14. SILENCE

\* When the unit is on, press the “MENU” button, then press  ,  ,  and  to choose the “SILENCE” character, when the “SILENCE” character will blink, and press the “OK” button to highlight (not highlight ) the “SILENCE” character , which will activate (deactivate) the function of silent wind.





### 15. ELE.H

\* When the unit is on, press the “MENU” button, then press  ,  ,  and  to choose the “SILENCE” character, when the “SILENCE” character will blink, and press the “OK” button to highlight (not highlight ) the “SILENCE” character , which will activate (deactivate) the function of silent wind.

\* The unit will activate the auxiliary heating function automatically according to the ambient temperature, so as to accelerate the heating.





\* This button is disabled on some models.

### 16.DISPLAY

\* Press the “MENU” button, then press  ,  ,  and  to choose the “DISPLAY” character, when the character “DISPLAY” will blink, and press the “OK” button to activate (deactivate) the function of screen display.

### 17.LIGHT

\* The unit will activate or deactivate automatically the function of display on the air-conditioner screen according to the indoor ambient brightness.





\* When the unit is on, press the “MENU” button, ,then press  ,  ,  and  to choose the “LIGHT” character, when the “LIGHT” character will blink, and press the “OK” button to highlight (not highlight) the character “LIGHT”, which will activate (deactivate) the function of light sensing.

### 22.Anti-F(Only YKR-T/021E)





\* Anti-F function: When the unit is closed under the modes of cooling, dry or auto (cooling), it will continue to operate for about 3 minutes to dry the moisture on the



evaporator, so as to prevent the accumulation of bacteria on the evaporator, which causes fungus and strange smell and is harmful to the health.

\* When the unit is off, press the “MENU” button, then press , ,  and  to choose the “Anti-F” character, when the “Anti-F” character will blink, and press the “OK” button to highlight (not highlight) the “Anti-F” character, which will activate (deactivate) the Anti-F function.





### **18. COSY(Only YKR-T/011E)**

\* When the air-conditioner is on under the modes of cooling, press the “MENU” button, then press , ,  and  to choose the “COSY” character, when the “COSY” character will blink, and press the “OK” button to highlight (not highlight) the character “COSY”, which will activate (deactivate) the function of cleaning.

\* When the “COSY” function is on, the motor speed is auto and it will cancel the swinging function.

When the “COSY” function is on, these operations that turn off the unit, change the mode, and set SLEEP, motor speed, swinging function will automatically exit the “COSY” function, then restore to the previous status.





### **19.HUMI(Only YKR-T/011E)**

\* Press the “MENU” button, then press , ,  and  to choose the “HUMI” character, when the “HUMI” character will blink, and press the “OK” button to highlight (not highlight) the “HUMI” character, which will activate(deactivate) the humidifying function.

Note: The humidifying function is not available under the dry mode.

### **20. Iclean**

\* The unit will clean automatically the dusts on the evaporator and dry or blow-dry the moisture.

\* When the air-conditioner is off, press the “MENU” button, then press , ,  and  to choose the “iCLEAN” character, when the “iCLEAN” character will blink, and press the “OK” button to highlight (not highlight) the character “iCLEAN”, which will activate (deactivate) the function of cleaning.

\* The cleaning function will close automatically after 30 minutes.

### **21. Child-lock**

\* Press the “HEAT” and “MODE” buttons at the same time and hold for at least 3 seconds to activate or deactivate the child-lock function.





\* When the child-lock function is activated, the remote control will indicate “”.

\* If the timer button is not pressed longer than 10 seconds after the “ON (OFF)” start flashing, the timer setting will be exited.





\* If a timer setting is confirmed, pressing this button again will cancel it.

## 22. Anti-F (Only YKR-T/021E)

\* Anti-F function: When the unit is closed under the modes of cooling, dry or auto (cooling), it will continue to operate for about 3 minutes to dry the moisture on the evaporator, so as to prevent the accumulation of bacteria on the evaporator, which causes fungus and strange smell and is harmful to the health.

\* When the unit is off, press the “MENU” button, then , ,  and  to choose the “Anti-F” character, when the “Anti-F” character will blink, and press the “OK” button to highlight (not highlight) the “Anti-F” character, which will activate (deactivate) the Anti-F function.

## 23. I-FEEL (Only YKR-T/021E)

\* When the unit is on, press the “MENU” button, then press , ,  and  to choose the “I-FEEL” character, when the “I-FEEL” character will blink, and press the “OK” button to highlight (not highlight) the “I-FEEL” and “” character, which will activate (deactivate) the I-FEEL function.

## 2) Usage

### ★ Fix batteries

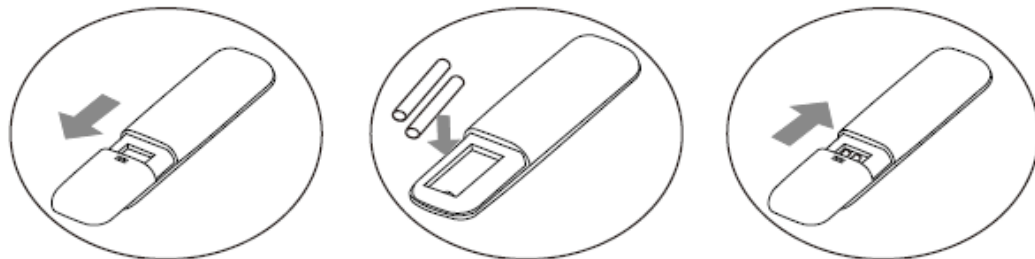

1. Slide to open the cover according to the direction indicated by the arrowhead.
2. Insert two brand new batteries (7#), and position the batteries to the right electric poles (+ & -).
3. Put back the cover.

### ★ Auto operation mode

1. Press the “MODE” button, select the auto operation mode.
2. By pressing the “SPEED” button, you can select the motor speed from LOW, MID, HIGH, AUTO.
3. Press the “ON/OFF” button, the air-conditioner starts to operate.
4. Press the “ON/OFF” button again, the air-conditioner stops.

### ★ Cooling/Heating operation mode

1. Press the “MODE” button, select the Cooling or Heating operation mode.
2. By pressing the “+” or “-” button, you can set the temperature range from 16°C

(60°F)~32°C(90°F), the display changes as you touch the button.

3. By pressing the “SPEED” button, you can select the motor speed from LOW, MID, HIGH, TURBO ,AUTO.

4. Press the “ON/OFF” button, the air-conditioner starts to operate.

5. Press the “ON/OFF” button again, the air-conditioner stops.

**Note: The cold wind type has no heating function.**

★ **Fan operation mode**

1. Press the “MODE” button, select the fan operation mode.

2. By pressing the “SPEED” button, you can select the motor speed from LOW, MID, HIGH.

3. Press the “ON/OFF” button, the air-conditioner starts to operate.

4. Press the “ON/OFF” button again, the air-conditioner stops.

Note: In the fan mode, the temperature settings is non-effective.

★ **Drying operation mode**

1. Press the “MODE” button, select the drying operation mode.

2. By pressing the “+” or “-” button, you can set the temperature range from 16°C (60°F)~32°C(90°F), the display changes as you touch the button.

4. Press the “ON/OFF” button, the air-conditioner starts to operate.

5. Press the “ON/OFF” button again, the air-conditioner stops.

**Note: In the dry mode, the speed settings is non-effective.**

### 3) Precautions

- Before first time use of the remote controller, install the batteries and ensure the “+” and “-” poles are correctly positioned.

- Ensure the remote controller is pointed to the signal receiving window, and that there is no obstruction in between and the distance is 8m at the maximum.

- Do not let the remote controller drop or fling it at will.

Do not let any liquid in the remote controller.

Do not expose the remote controller directly to the sunlight or excessive heat.

- If the remote controller does not function normally, remove the batteries for 30 second before reinstall them. If that doesn't work, replace the batteries.

- When replacing the batteries, do not mix the new batteries with old ones or mix batteries of different types, which could cause failure of the remote controller.

- If the remote controller is not to be used for a long period of time, remove the batteries first, lest the leakage from them may damage the remote controller.

- Properly dispose the discarded batteries.

Note:

1. This is a universal remote controller which provide all the function buttons. Please understand that some of the buttons may not function, depending on the specific air conditioner you have purchased. (If a specific function is not available on the air conditioner, pressing the corresponding button will simply have no respond.)

2. HEAT and ELE.H functions are not available for cool only models, thus these two buttons do not work correspondingly.

## 5. Refrigerant System Diagram

### 5-1 Cooling Only

#### ➤ Cooling Mode

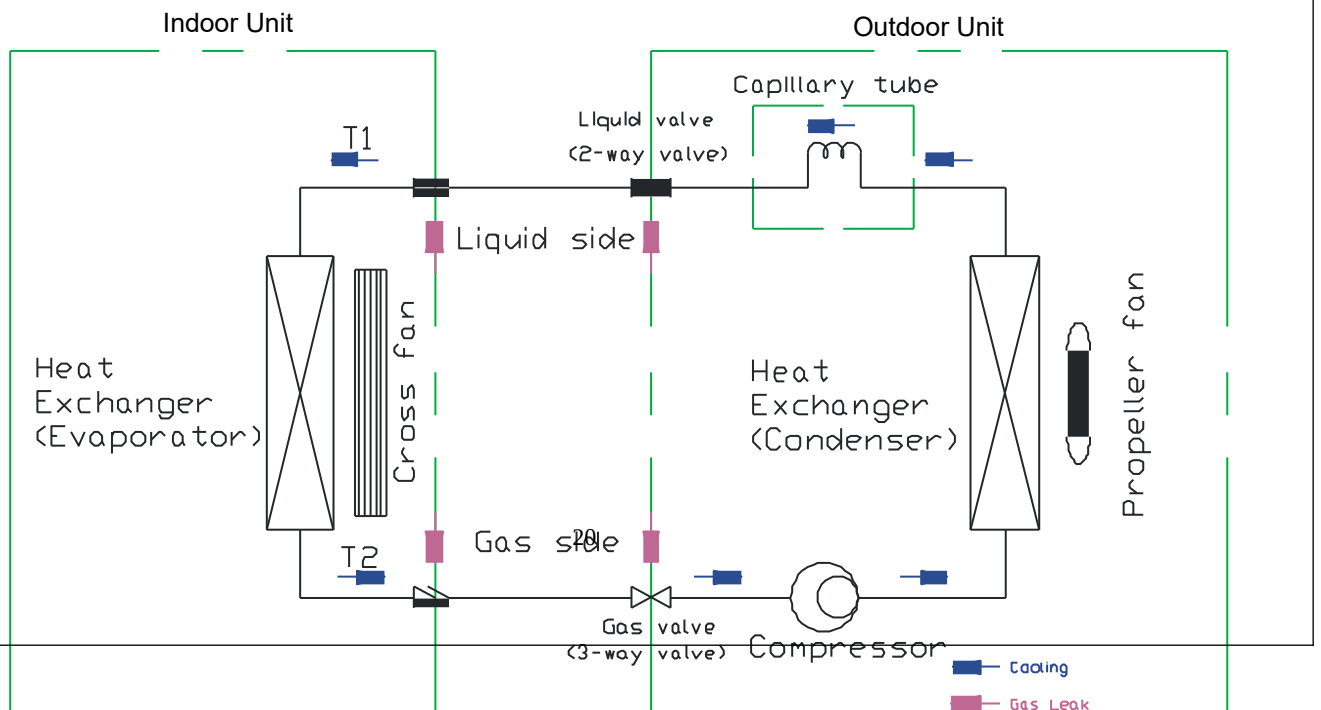

➤ **Cooling Cycle**

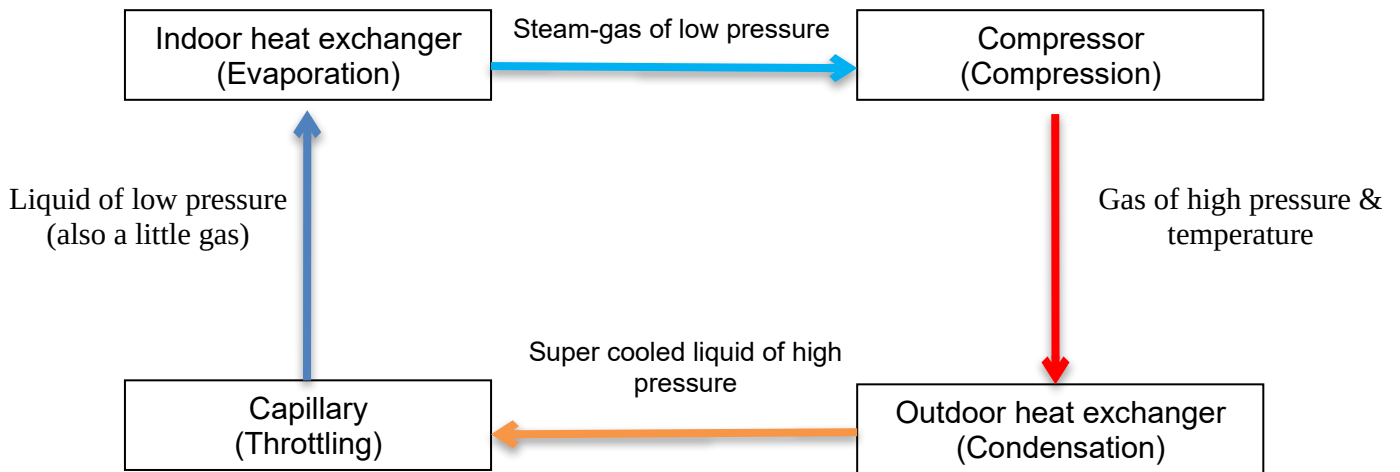

**5-2 Cooling & Heating**

➤ **Cooling Mode**

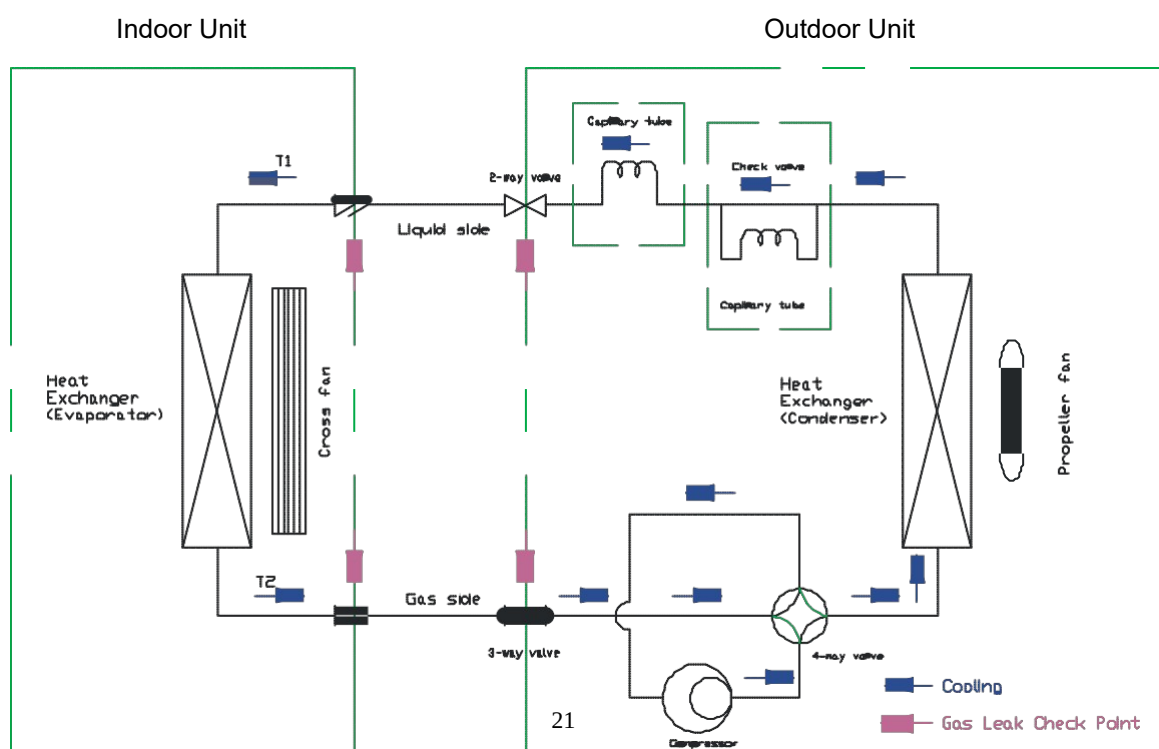

➤ **Cooling Cycle**

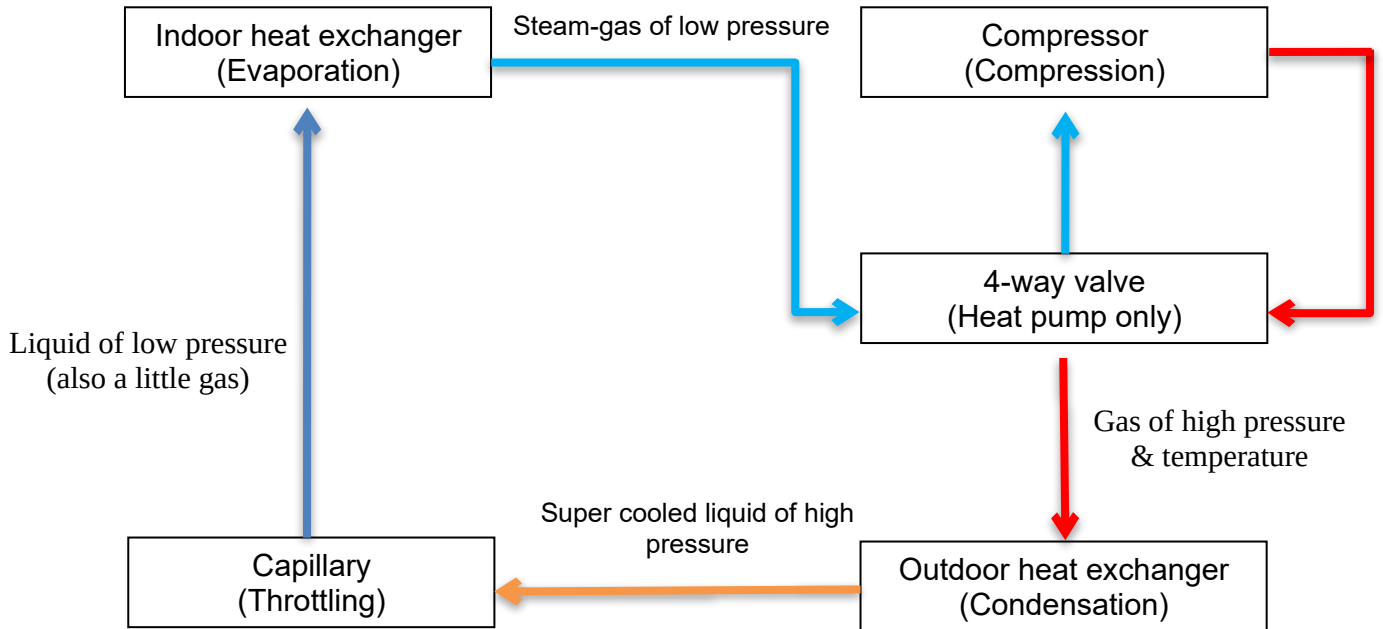

➤ **Heating Mode**

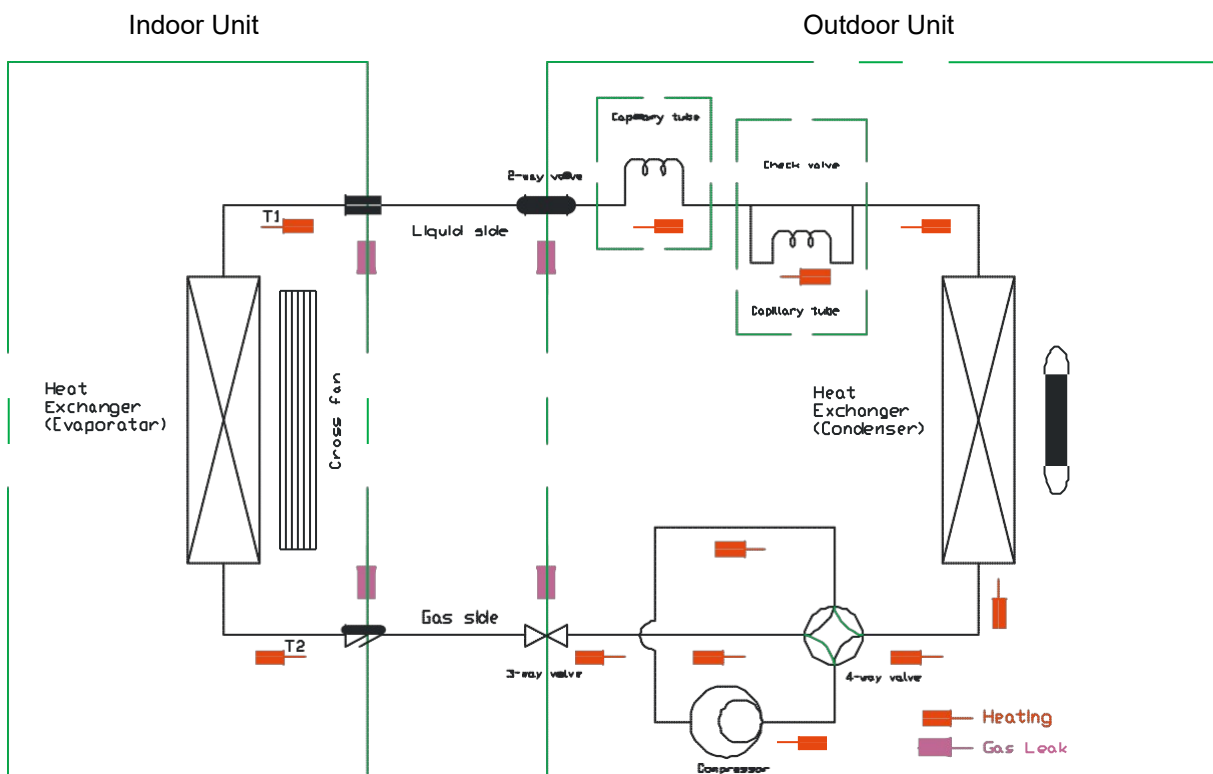

➤ **Heating Cycle**

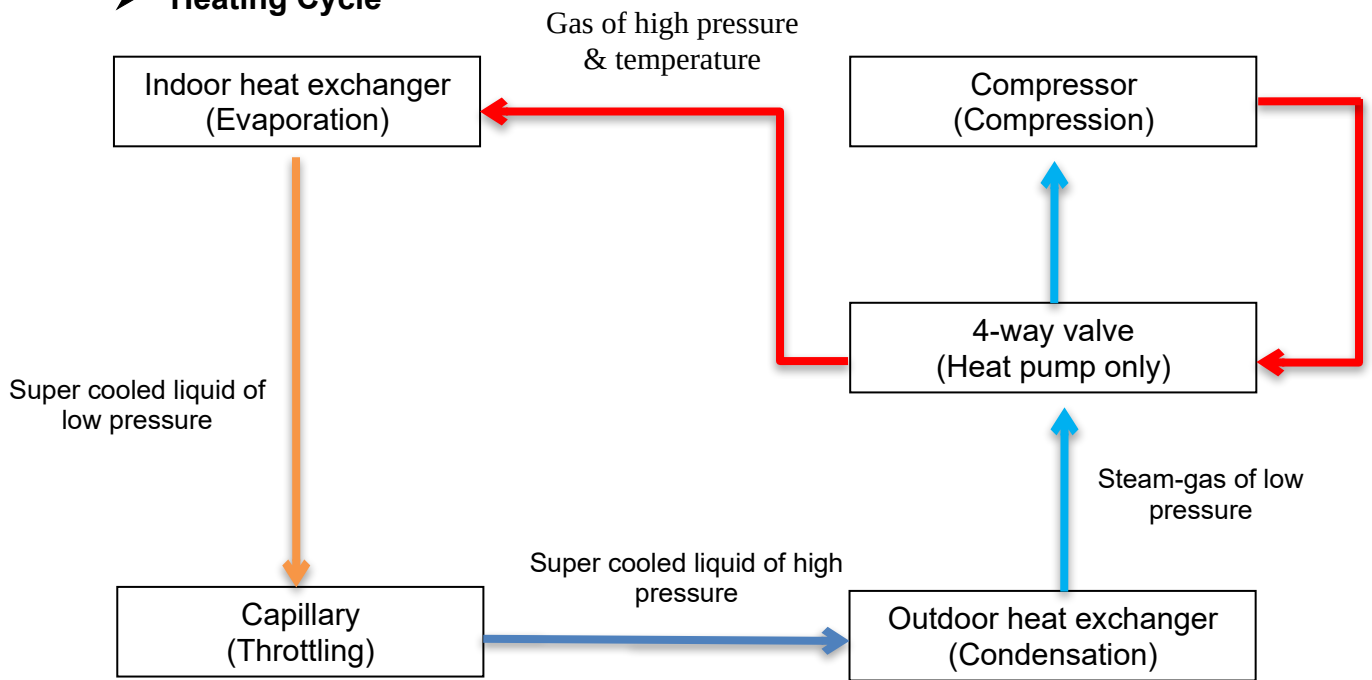

## 6. Electrical Part

The diagrams listed below for reference only, please refer to the actual product.

### 6-1 Electrical Wiring Diagram

#### ➤ Indoor Unit

09K、12K、18K

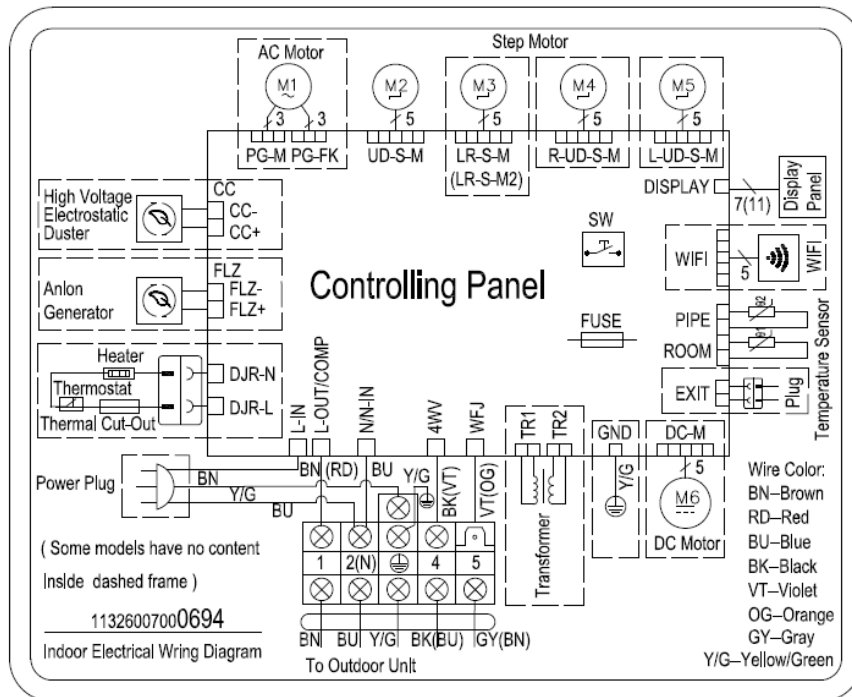

24K



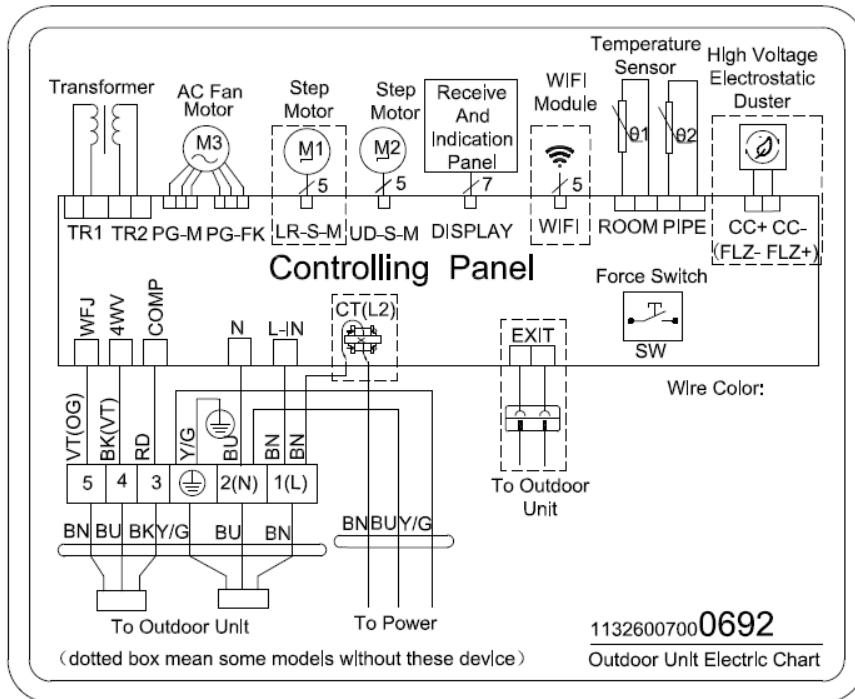

➤ **outdoor Unit**

09K、12K、18K

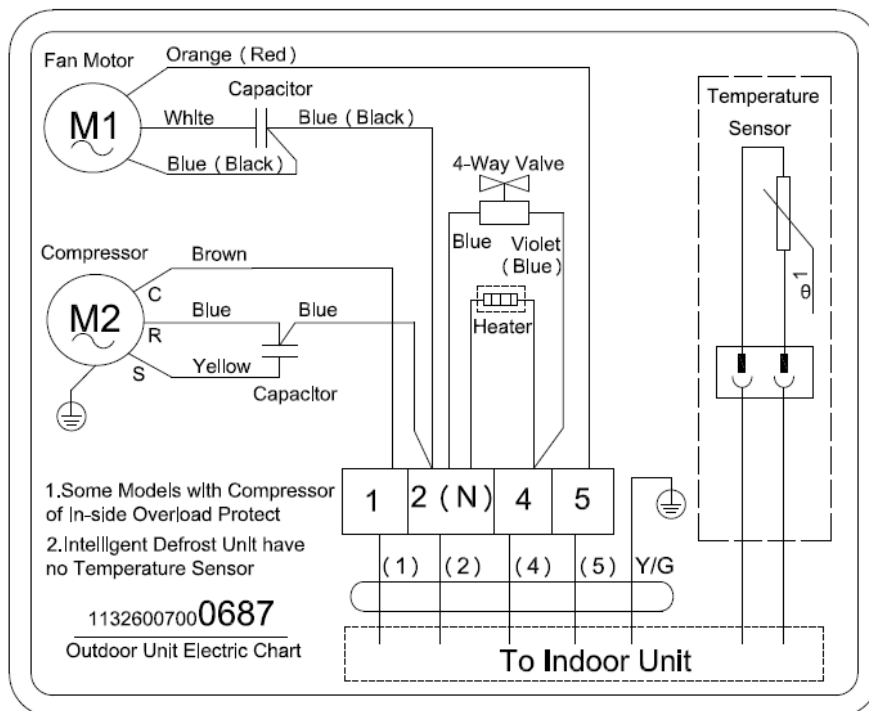

24K

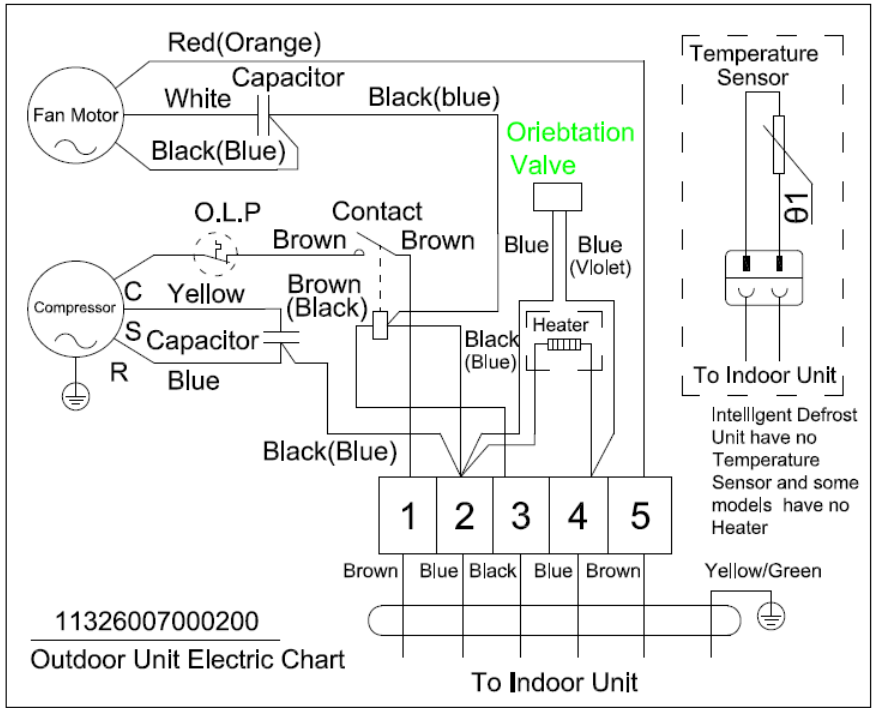

## Part II : Installation and Maintenance

### 7. Main Tools for Installation and Maintenance

Screwdriver , Wire stripper	Tapeline , Spirit level	Allen wrench , Wrench
		
Hammer , Electric hammer	Water drill punch , Drill	Forming Drill
		
Cutting Knife	Belling Expander	Thermometer , Electro Probe
		
Pressure Gage	Pliers , Clip-on Ammeter	Vacuum Pump
		
Soldering Set	Refrigerant	Safety Belt , Safety Rope
		

## 8. Installation

### 8-1 Notes for Installation

#### Important Notices

- Before installation, please contact with local authorized maintenance center, if unit is not installed by the authorized maintenance center, the malfunction may not solved, due to discommodious contact.
- The air conditioner must be installed by professionals according to the national wiring rules and this manual.
- To move and install air conditioner to another place, please contact our local special service center.

#### Requirements For Installation Position

- Avoid places of inflammable or explosive gas leakage or where there are strongly aggressive gases.
- Avoid places subject to strong artificial electric/magnetic fields.
- Avoid places subject to noise and resonance.
- Avoid severe natural conditions (e.g. heavy lampblack, strong sandy wind, direct sunshine or high temperature heat sources).
- Avoid places within the reach of children.
- Shorten the connection between the indoor and outdoor units.
- Select where it is easy to perform service and repair and where the ventilation good.
- The outdoor unit shall not be installed in any way that could occupy an aisle, stairway, exit, fire escape, catwalk or any other public area.
- The outdoor unit shall be installed as far as possible from the doors and windows of the neighbors as well as the green plants.

#### Requirements for operations at raised height

- When carrying out installation at 2m or higher above the base level, safety belts must be worn and ropes of sufficient strength be securely fasten to the outdoor unit, to prevent falling that could cause personal injury or death as well as property loss.

#### Requirements of the mounting structure

- The mounting rack must meet the relevant national or industrial standards in terms of strength with welding and connection areas rustproofed.
- The mounting rack and its load carry surface shall be able to withstand 4 times or above the weight of the unit, or 200kg, whichever is heavier.
- The mounting rack of the outdoor unit shall be fastened with expansion bolt.
- Ensure the secure installation regardless of what type of wall on which it is installed, to prevent potential dropping that could hurt people.

#### Electrical Safety Requirements

- Be sure to use the rated voltage and air conditioners dedicated circuit for the power supply, and the power cord diameter must meet the national requirements.
- Be sure to use the rated voltage and air conditioners dedicated
- When the maximum current of air conditioner is  $\geq 16A$ , it must use the air switch or leakage protection switch equipped with protection devices.

- The normal operating range is 90%-110% of the local rated voltage.
- The minimum clearance between the air conditioner and the combustibles is 1.5 m.
- The power cable enables communication between the indoor and outdoor units. You must first choose the right cable size before preparing it for connection.

#### ✚ **Grounding Requirements**

- The air conditioner is the type I electrical appliance and must ensure a reliable grounding.
- Do not connect the grounding wire to a gas pipe, water pipe, lightning rod, telephone line, or a circuit poorly grounded to the earth.
- The grounding wire is specially designed and shall not be used for other purpose, nor shall it be fastened with a common tapping screw.

#### ✚ **Others**

- The connection method of the air conditioner and the power cord and the interconnection method of each independent element shall be subject to the wiring diagram affixed to the machine.
- The model and rating value of the fuse shall be subject to the silkscreen on corresponding controller or fuse sleeve.

## **8-2 Installation of Indoor Unit**

### ➤ **Installation Parts-checking**

Packing list of the indoor unit

<b>NO.</b>	<b>Name</b>	<b>Quantity</b>	<b>Unit</b>
1	Indoor Unit	1	Set
2	Remote Controller	1	PC
3	Batteries(7#)	2	PC
4	Instructions	1	Set
5	Drain pipe	1	PC

#### **NOTE:**

※ All accessories shall be subject to actual packaging material, and if there is any difference, please understand.

### ➤ **Selection of Installation location**

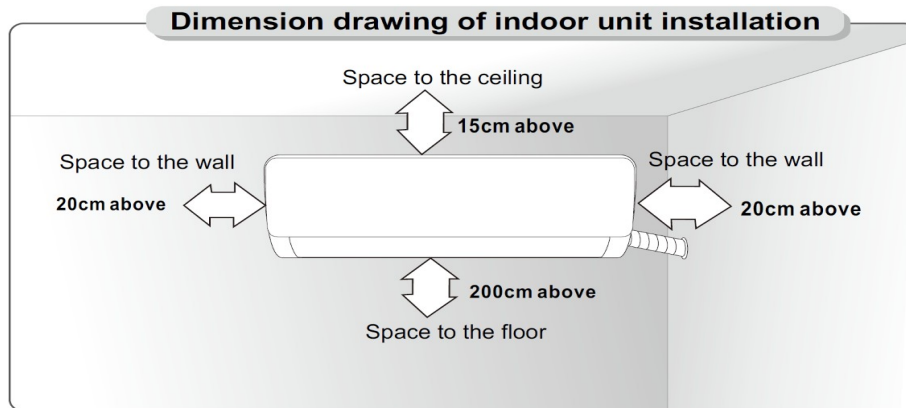

➤ **Mounting plate**

1. The wall for installation of the indoor unit shall be hard and firm, so as to prevent vibration.
2. Use the "+" type screw to fasten the peg board, horizontally mount the peg board on the wall, and ensure the lateral horizontal and longitudinal vertical.
3. Pull the peg board by hand after the installation, to confirm whether it is solid.

➤ **Wall-**

1. Make a hole with an electric hammer or a water drill

at the predetermined position on the wall for piping, which shall slant outwardly by 5°-10°.

2. To protect the piping and the cables from being damaged running through the wall, and from the rodents that may inhabit in the hollow wall, a pipe protecting ring shall be installed and sealed with putty.

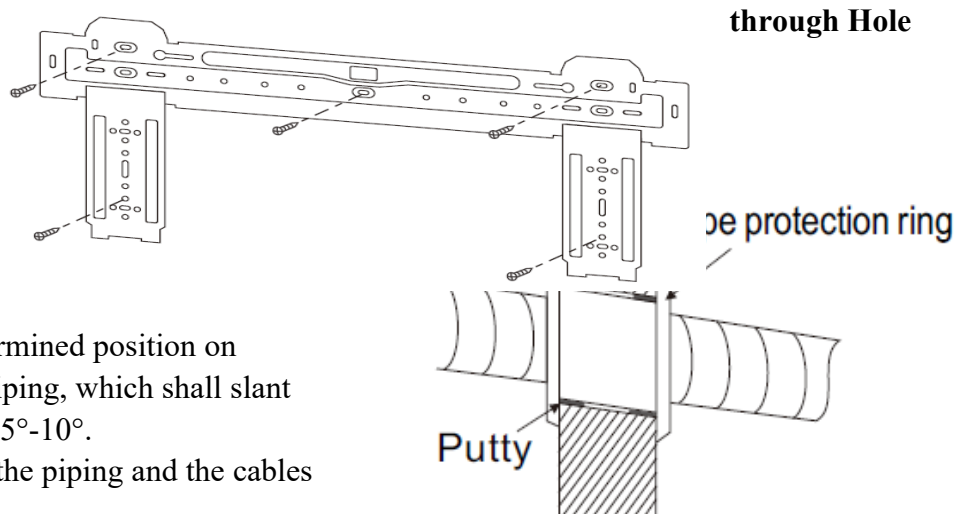

**Note: Usually, the wall hole is  $\Phi 60\text{mm}$ ~ $\Phi 80\text{mm}$ . Avoid pre-buried power wire and hard wall when making the hole.**

➤ **Route of Pipeline**

1. Depending on the position of the unit, the piping may be routed sideway from the left or the right ( Fig 1 ), or vertically from the back( Fig 2 )(depending on the pipe length of the indoor unit). In the case of sideway routing, cut off the outlet cutting stock of the opposite side.
2. The power cord may be routed separately from the piping. Cut off the outlet cutting

stock and then run the power cord through the hole, keeping the remaining part as a protection from rodents.

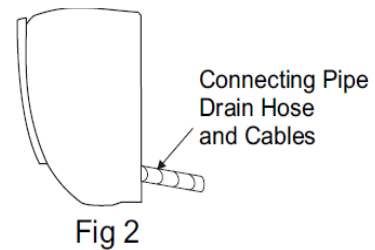
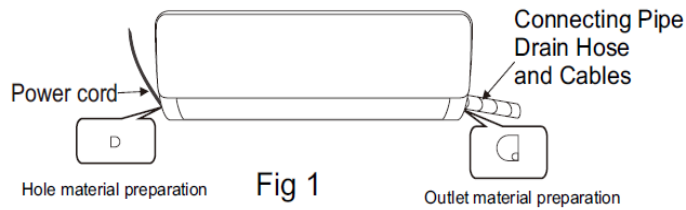

### ➤ Drain pipe connection

1. Remove the mountings and pull the indoor unit pipe out of the housing.
2. Connect the connecting pipe to the indoor unit:  
Aim at the pipe center, tighten the Taper nut with fingers, and then tighten the T nut with a torque wrench, and the direction is shown in diagram on the right. The torque used is shown in the following table.

**Tightening torque table**

The size of pipe(mm)	Torque(N·m)
Φ6/Φ6.35	15 ~ 25
Φ9 /Φ9.5 2	35 ~ 40
Φ12/Φ12.7	45 ~ 60
Φ15.88	73 ~ 78
Φ19.05	75 ~ 80

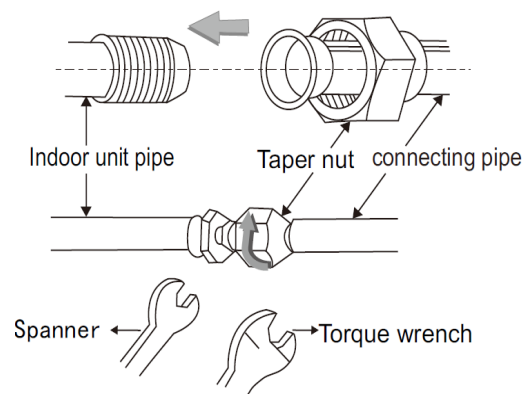

### ➤ Wrap the Piping

1. Use the insulation sleeve to wrap the joint part the indoor unit and the connection pipe, and then use insulating material to pack and seal insulation pipe, to prevent generation of condensate water on the joint part.
2. Connect the water outlet with drain pipes, and make the connection pipe, cables, and the drain hose straight.
3. Use plastic cable ties to wrap the connecting pipes, cables and drain hose. Run the pipe sloping downward.

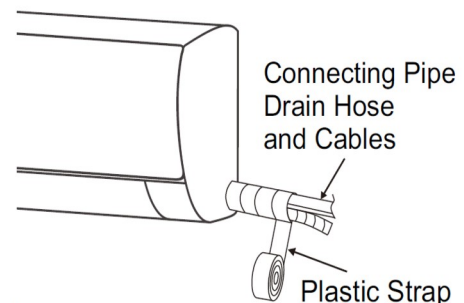

### ➤ Fixing the indoor unit

1. Hang the indoor unit on the peg board, and move the unit from left to right to ensure that the hook is properly positioned in the peg board.
2. Push toward the lower left side and the upper right side of the unit toward the peg board, until the hook is embedded in the slot and makes a "click" sound.

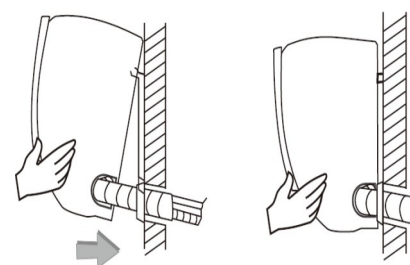

➤ **Electric Connection Requirement**

- Loosen the screws and remove from the unit.
- Connect the cables respectively to the corresponding terminals of the terminal board of the indoor unit (see the wiring diagram), and if there are signals connected to the plug, just conduct butt joint.
- Ground wire: Remove the grounding screw out of the electric bracket, cover the grounding wire end onto the grounding screw and screw it into the grounding hole.
- Fix the cable reliably with fasteners (Pressing board).
- Put the E-parts cover back in its original place and fasten it with screws.

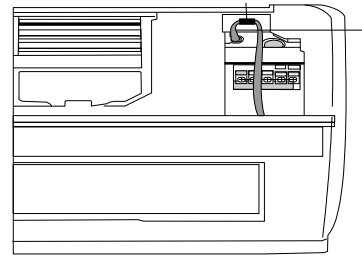

Wiring Diagram

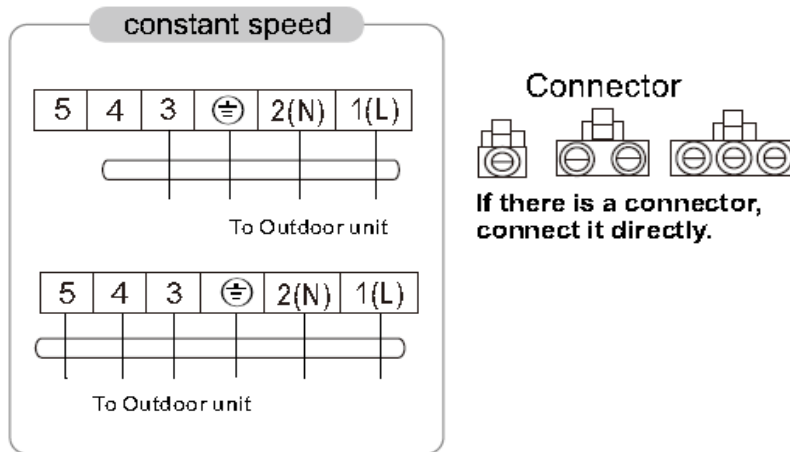

**NOTE:**

- ※ This manual usually includes the wiring mode for the different kind of A/C. We cannot exclude the possibility that some special type of wiring diagrams are not included.
- ※ The diagram are for reference only. If the entity is difference with this wiring diagram, please refer to the detailed wiring diagram adhered on the unit which you purchased.

**8-3 Installation of outdoor Unit**

➤ **Packing list of the outdoor unit**

NO.	Name	Quantity	Unit
1	Outdoor Unit	1	Set



2	Connecting pipe	2	PC
3	Plastic Strap	1	ROLL
4	Pipe Protection Ring	1	Set
5	Luting (putty)	1	PACKET

➤ Selection of Installation location

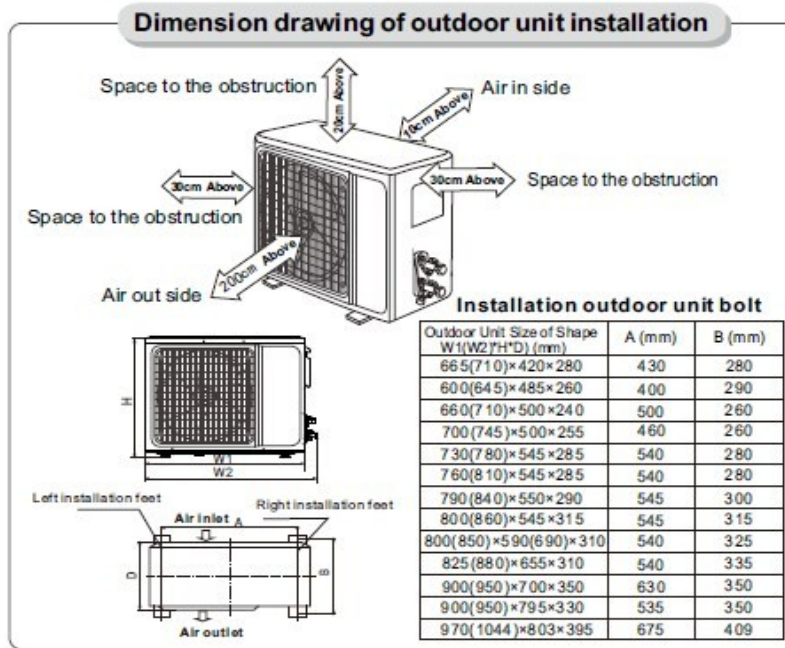

➤ Install the connection pipe

Connect the Outdoor Unit with Connecting Pipe: Aim the counter-bore of the connecting pipe at the stop valve, and tighten the Taper nut with fingers. Then tighten the Taper nut with a torque wrench.

★When prolonging the piping, extra amount of refrigerant must be added so that the operation and performance of the air conditioner will not be compromised.

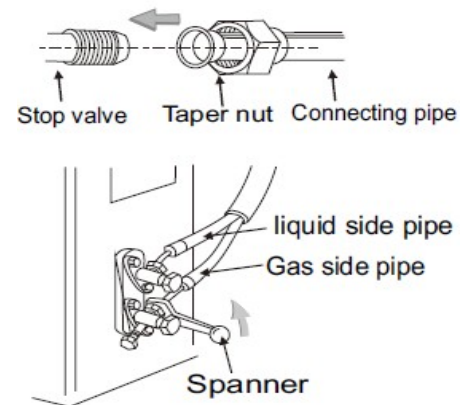

Piping length	Amount of refrigerant to be added	
≤5M	Not needed	
5- 15M	CC≤12000Btu	20g/m
	CC≥18000Btu	30g/m

**Note: This table is for reference only.**

➤ Wiring Connection

1. Loosen the screws and remove E-parts cover from the unit.
2. Connect the cables respectively to the corresponding terminals of the terminal board of the outdoor unit (see the wiring diagram), and if there are signals connected to the plug, just conduct butt joint.
3. Ground wire: Remove the grounding screw out of the electric bracket, cover the grounding wire end onto the grounding screw and screw it into the grounding hole.
4. Fix the cable reliably with fasteners (Pressing board).

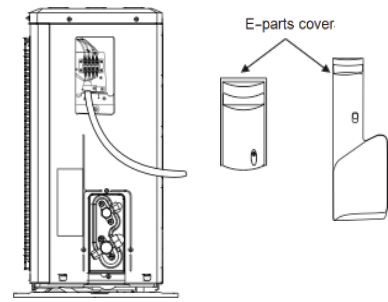

➤ **Wiring diagram**

Wiring Diagram

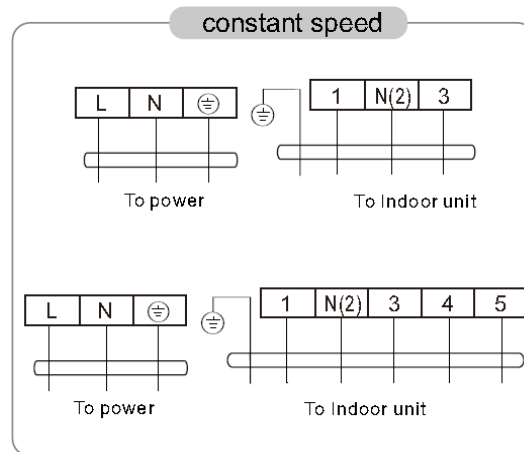

Connector

If there is a connector, connect it directly.

**NOTE:**

- ※ This manual is usually includes the wiring mode for the different kind of A/C. We cannot exclude the possibility that some special type of wiring diagrams are not included.
- ※ The diagram are for reference only. If the entity is difference with this wiring diagram, please refer to the detailed wiring diagram adhered on the unit which you purchased.

➤ **Expelling the air**

★ **Outdoor unit refrigerant discharging method**

After the pipe side connection is complete, proceed as follows.

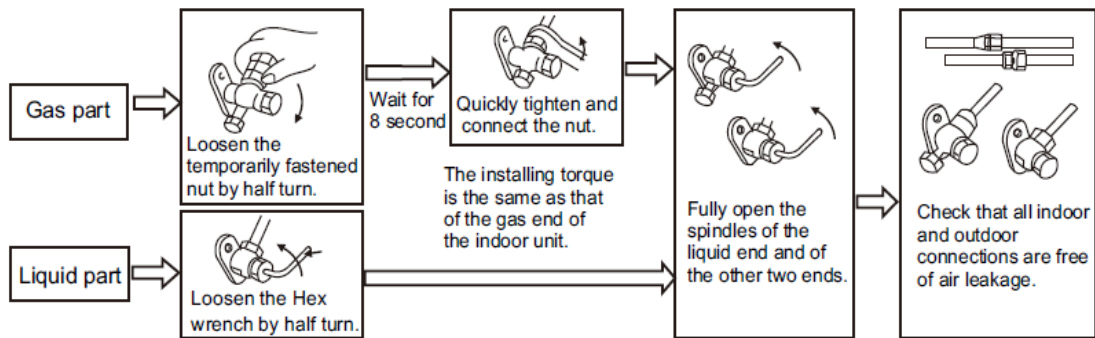

**★Vacuum Pumping Method (R410A refrigerant evacuation must use the vacuum pumping method)**

Before working on the air conditioner, remove the cover of the stop valve(gas and liquid valves)and be sure to retighten it afterward.(to prevent the potential air leakage)

1. To prevent air leakage and spilling tighten all connecting nut of all flare tubes.
2. Connect the stop valve, charge hose, manifold valve, and vacuum pump.
3. Fully open the handle Lo of the manifold valve and apply vacuum for at least 15 minutes and check that the compound vacuum gauge reads -0.1MPa(-76cmHg).
4. After applying vacuum, fully open the stop valve with a hex wrench.
5. Check that both indoor and outdoor connections are free of air leakage.

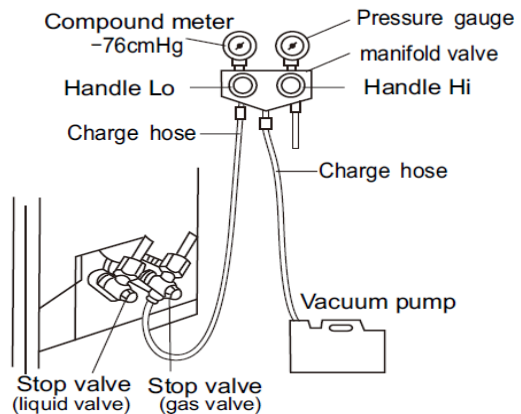

➤ **Outdoor condensation drainage(Heat pump type only)**

When the unit is heating, the condensing water and defrosting water can be out reliably through the drain house.

**Installation:**

Install the outdoor drain elbow in  $\Phi 25$  hole on the base plate, and joint the drain hose to the elbow, so that the waste water formed in the outdoor unit can be drained out to a proper plate.

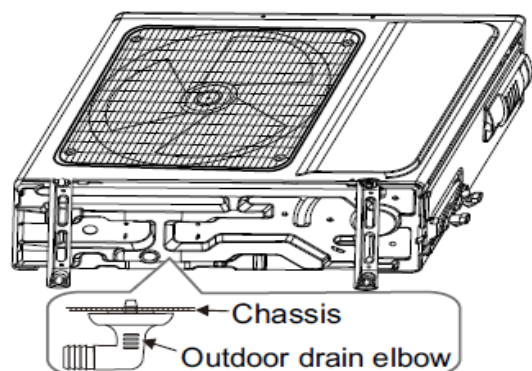

## **8-4 Check after installation and test operation**

### **1. Check after installation**

#### **★ Electrical Safety Check**

- ① If the supply voltage is as required.
- ② If there is any faulty or miss connection in each of the power, signal and grounding wires.
- ③ If the grounding wire of the air conditioner is securely grounded.

#### **★ Installation Safety Check**

- ① If the installation is secure.
- ② If the water drain is smooth.
- ③ If the wiring and piping are correctly installed.
- ④ Check that no foreign matter or tools are left inside the unit.

#### **★ Leak test of the refrigerant**

Depending on the installation method, the following methods may be used to check for suspect leak, on areas such as the four connections of the outdoor unit and the cores of the cut-off valves and t-valves:

- ① Bubble method: Apply of spray a uniform layer of soap water over the suspected leak spot and observe carefully for bubble.
- ② Instrument method: Checking for leak by pointing the probe of the leak detector according to the instruction to the suspect points of leak.

### **2. Test operation**

#### **★ Test preparation**

- ※Verify that all piping and connection cables are well connected.
- ※Confirm that the valves at the gas side the liquid-side are fully open.
- ※Connect the power cord to an independent power socket.
- ※Install batteries in remote control.

#### **★ Test Operation method**

- ① Turn on the power and push the ON/OFF switch button of the remote controller to start the air conditioner.
- ② Select COOL, HEAT (not available on cool-only models), SWING and other operation modes with the remote controller and see if the operation is ok.

## 9. Maintenance

### 9-1 Troubleshooting Guide

Many error codes many appears on this air conditionor, and this troubleshooting guide is prepared for the maintenance personnel to detect the error position and the parts to be replaced during the troubleshooting process. In this Guide, the Troubleshooting Method is guided by the Error Name, and the Reference Code under the General Index is the error code of the Indoor Unit unit of the mainstream model supplied by the Company.

#### General index:

No.	Error Name	Reference Code
1	Overcurrent Protection of Indoor Unit	E0
2	Indoor Unit temperature sensor error	E1
3	Outdoor Unit coil sensor error	E2
4	Indoor Unit coil sensor error	E3
5	Indoor Unit motor error of <b>wall mounted air conditioner</b> (PG motor)	E4
6	Indoor Unit motor error of <b>wall mounted air conditioner</b> (DC motor)	E4
7	Indoor EE Failure	Eb
8	High-pressure protection	P2
9	Liquid Deficiency Protection	P3

**Example:**

<b>Explanation of error</b>	<b>Cause:</b> explain the principle of the specific error. <b>Inspection path:</b> The basic order of troubleshooting. Related key position
<b>Tools required for inspection</b>	Tools that should be carried for such troubleshooting, and replacing parts that may be necessary for such error.
<b>Frequent problematic part</b>	Any possibly broken part related to the error may be the parts that need to be replaced.
<b>Inspection procedure and key points</b>	All the troubleshooting procedures for the reference of maintenance staff are prepared from simple to complex, from surface to Indoor Unit, and from test to replacement. Although these key points do not cover all the error, and difficult or special problems are not included as well, but they can cover most of the common error.
<b>Special attention</b>	Here are some often-overlooked problems for the reference of the maintenance personnel.

The problems in the market are always more than we think, so it is necessary for the maintenance personnel to understand the principle of air conditioning operation, and to make a flexible judgment of the fault in combination with the actual conditions. We welcome the maintenance personnel to constantly put forward new problems in the actual work, record the solutions and enrich our troubleshooting guide list.

**(1) E0 - Overcurrent Protection of Indoor Unit**

<p><b>Explanation of error</b></p>	<p>Cause: The main PCB detects that the working current of the system exceeds the upper limit of protection, and will indicate "indoor unit overcurrent protectin:. The air conditioner stopps running for protection and displays the failure code E0. Inspection path: current transformer → power line → compressor line → connector assembly</p>
<p><b>Tools required for inspection</b></p>	<p>Current clamp and multimeter</p>
<p><b>Frequent problematic part</b></p>	<p>Indoor unit panel, power line, compressor and complete machine</p>
<p><b>Inspection procedure and key points</b></p>	<ol style="list-style-type: none"> <li>1. If it is a fixed-frequency model, observe whether the live line passes through the current transformer; if not, lay the line accordingly and reboot for inspection.</li> <li>2. The current clamp is used to measure the working current and determine whether it is within the normal working current range of the nameplate. If normal working current is detected, it may be the fault of the current transformer and replace the main PCB of the indoor unit.</li> <li>3. Measure whether the power supply voltage is within the normal operating voltage range; if the working voltage is not normal, it is necessary to consider whether the local grid voltage is stable.</li> <li>4. If the working current exceeds the range and the working voltage is normal, the system may be blocked and the air-conditioning may be overloaded, which needs to be checked according to the actual situation.</li> </ol>

**(2) E1- Indoor Unit temperature sensor error**

<p><b>Explanation of error</b></p>	<p><b>Cause:</b> The detection of short circuit or open circuit of Indoor Unit temperature sensor during the inspection of main PCB in the Indoor Unit machine, indicated by “Indoor Unit temperature sensor error”.  <b>Inspection path:</b> Sensor→Sensor wire→Connectors→Indoor Unit main PCB</p>
<p><b>Tools required for inspection</b></p>	<p>Multimeter, 15KΩ standard sensor (25℃)</p>
<p><b>Frequent problematic part</b></p>	<p>Indoor Unit temperature sensor, Indoor Unit main PCB</p>
<p><b>Inspection procedure and key points</b></p>	<ol style="list-style-type: none"> <li>1. Check whether there's resistance problem, short circuit or open circuit in the sensor; the resistance value shall be within a reasonable range (15KΩ under the temperature of 25℃)</li> <li>2. Check whether the sensor wire is broken.</li> <li>3. Check whether the terminal connectors are well fixed; check whether the weld between the terminal and the main PCB is loose, and pull the terminal slightly for inspection if necessary.</li> <li>4. Check whether the sensor is affected with damp.</li> <li>5. In case no standard sensor is available at present, replace the Indoor Unit temperature sensor by other sensor asides, and then check whether the error still exists; if the error disappears, replace the sensor; if the error still exists, check the Indoor Unit main PCB and change if necessary.</li> </ol>



<b>Special attention</b>	<p>Most Indoor Unit temperature sensors have a resistance value of 15KΩ.</p> <p>Do not use improper sensor during repairing and maintenance, or it may led to the wrong temperature sensing of the machine, the start error or shutdown error. You can switch the air conditioner to the “Blowing” mode, and judge the accuracy of sensor though environmental temperature displayed on the screen.</p> <p>In case a sensor with the resistance value over 15KΩ is used, the detected temperature will be much lower than the actual temperature, which may lead to the shutdown error under heating mode, or the startup error under cooling mode.</p> <p>In case a sensor with the resistance value below 15KΩ is used, the detected temperature will be much higher than the actual temperature, which may lead to the startup error under heating mode, or the shutdown error under cooling mode.</p>
--------------------------	---

**(3) E2 -Outdoor Unit coil sensor error**

<b>Explanation of error</b>	<p><b>Cause:</b> The detection of short circuit or open circuit of Outdoor Unit coil sensor during the inspection of Outdoor Unit main PCB, indicated by “Outdoor Unit coil sensor error”.</p> <p><b>Inspection path:</b> Sensor→Sensor wire→Connectors→Outdoor Unit main PCB</p>
<b>Tools required for inspection</b>	Multimeter, 20KΩ standard sensor (25℃ )
<b>Frequent problematic part</b>	Outdoor Unit coil sensor, Outdoor Unit main PCB
<b>Inspection procedure and key points</b>	<ol style="list-style-type: none"> <li>1. Check whether there’s resistance problem, short circuit or open circuit in the sensor; the resistance value shall with a reasonable range (about 20KΩ)</li> <li>2. Check whether the sensor wire is broken.</li> <li>3. Check whether the terminal connectors are well fixed; check whether the weld between the terminal and the main PCB is loose, and pull the terminal slightly for inspection if necessary.</li> <li>4. Check whether the sensor is affected with damp. The coil sensor is quite easy to be affected with damp in case the lead of coil sensor is above the copper pipe.</li> <li>5. In case no standard sensor is available at present, replace the temperature sensor of Outdoor Unit coil by other sensor asides, and then check whether the error still exists; if the error disappears, replace the sensor; if the error still exists, check the Indoor Unit main PCB and change if necessary.</li> </ol>

<b>Special attention</b>	<p>Most Indoor Unit temperature sensors have a resistance value of 20KΩ.</p> <p>Do not use improper sensor during repairing and maintenance, or it may led to the start of protection mode due to wrong temperature sensing of the machine, or the protection error.</p> <p>In case a sensor with the resistance value over 20KΩ is used, the detected temperature will be much lower than the actual temperature, which may lead to the frequent entering of defrost mode, the illusory defrosting or the protection error during the cooling process.</p> <p>In case a sensor with the resistance value below 20KΩ is used, the detected temperature will be much higher than the actual temperature, which may lead to defrost error during the heating process, or the start of protection during the cooling process.</p>
--------------------------	--

**(4) E3 -Indoor Unit coil sensor error**

<b>Explanation of error</b>	<p><b>Cause:</b> The detection of short circuit or open circuit of Indoor Unit coil sensor during the inspection of Indoor Unit main PCB, indicated by “Indoor Unit coil sensor error”.</p> <p><b>Inspection path:</b> Sensor→Sensor wire→Connectors→Indoor Unit main PCB</p>
<b>Tools required for inspection</b>	Multimeter,, 5KΩ or 20KΩ standard sensee (25℃)
<b>Frequent problematic part</b>	Indoor Unit temperature sensor, Indoor Unit main PCB
<b>Inspection procedure and key points</b>	<ol style="list-style-type: none"> <li>1. Check whether there’s resistance problem, short circuit or open circuit in the sensor; the resistance value shall with a reasonable range (about 20KΩ)</li> <li>2. Check whether the sensor wire is broken.</li> <li>3. Check whether the terminal connectors are well fixed; check whether the weld between the terminal and the main PCB is loose., and pull the terminal slightly for inspection if necessary.</li> <li>4. Check whether the sensor is affected with damp. The coil sensor is quite easy to be affected with damp in case the lead of coil sensor is above the copper pipe.</li> <li>5. In case no standard sensor is available at present, replace the temperature sensor of Indoor Unit coil by other sensor asides, and then check whether the error still exists; if the error disappears, replace the sensor; if the error still exists, check the Indoor Unit main PCB and change if necessary.</li> </ol>

<b>Special attention</b>	<p>Most Indoor Unit temperature sensors have a resistance value of 20KΩ.</p> <p>Do not use improper sensor during repairing and maintenance, or it may led to the start of anti-frosting or overheat protection mode due to wrong temperature sensing of the machine.</p> <p>In case a sensor with the resistance value over 20KΩ is used, the detected temperature will be much lower than the actual temperature, which may lead to the high pressure of cold-blast protection system during the heating process, or the frequent start of anti-freezing protection during the cooling process.</p> <p>n case a sensor with the resistance value below 20KΩ is used, the detected temperature will be much higher than the actual temperature, which may lead to the frequent start of overheat protection mode during the heating or the overload protection during the cooling process.</p>
--------------------------	---

**( 5 ) E4 -Indoor Unit motor error of wall mounted air conditioner ( PG motor )**

<p><b>Explanation of error</b></p>	<p><b>Cause:</b> PG motor is equipped with speed feedback signal line. When the feedback signal of speed is not received by the Indoor Unit main PCB, it has no way to recognize the rotating speed of motor, which will be indicated as “Indoor Unit motor error”. Main causes for the disappearance of speed feedback signal are as follows: The fan is stucked; 2. The speed feedback component in the motor is broken; 3. Error of receiving circuit for the speed feedback signal from the Indoor Unit main PCB.</p>
<p><b>Tools required for inspection</b></p>	<p>Multimeter, A PG motor in normal working condition</p>
<p><b>Frequent problematic part</b></p>	<p>Mechanical jam problem of Indoor Unit motor, PG motor, Indoor Unit main PCB</p>
<p><b>Inspection procedure and key points</b></p>	<ol style="list-style-type: none"> <li>1. Check whether the motor can work for a period of time before the error occurs. If yes, the reason of mechanical jam can be exclude.</li> <li>2. Disconnect the power supply and move the fan blade of Indoor Unit machine by hand to see if there’s any resistance. Some occasional Indoor Unit motor error may relate to bearing coordination.</li> <li>3. Reconnect the drive wire and speed feedback wire, thus to exclude any motor error due to connector loosening.</li> <li>4. Check whether the plug-in terminal of speed feedback on the PCB is loose, and pull the terminal slightly for inspection if necessary.</li> <li>5. Replace the motor in the faulted air conditioner with other PG motor (do not fix it with the fan for the time being), if the main PCB still indicates “Indoor Unit motor error”, then replace the Indoor Unit main PCB; if the error disappears, replace the Indoor Unit motor.</li> </ol>
<p><b>Special attention</b></p>	<p>The Indoor Unit main PCB will not indicates “Indoor Unit motor error” when the Indoor Unit motor is still rotating; sometimes such error will not be reported when obvious motor problems exist (such as the low-speed rotation due to damaged motor capacitors, or non-uniform rotating speed due to abnormal speed feedback. Therefore, patience of the maintenance staff is required for the troubleshooting of motor error. You shall compare it with the normal condition, and detect and solve the problem in a flexible way.</p>

**(6) E4- Indoor Unit motor error of wall mounted air conditioner (DC motor)**

<p><b>Explanation of error</b></p>	<p><b>Cause:</b> The Indoor Unit motor of some highly energy efficient models is DC motor using a green plug through which the Indoor Unit main PCB can drive the motor and sense the current rotational speed feedback. When the Indoor Unit main PCB cannot receive the rotational speed feedback signal of the motor, it will indicate “DC motor error”. Disappearance of the rotational speed feedback signal may be caused by:  1 The fan is stuck and cannot work; 2 The speed feedback element inside the motor is destroyed; 3 There’s something wrong with the speed feedback signal receiving circuit of the Indoor Unit main PCB.  <b>Inspection path:</b> Is DC motor stuck by foreign matter→motor destroyed → Motor terminal connectors→Indoor Unit main PCB</p>
<p><b>Tools required for inspection</b></p>	<p>Multimeter, a DC motor in normal working condition</p>
<p><b>Frequent problematic part</b></p>	<p>Mechanical jam of Indoor Unit motor, Indoor Unit DC motor, Indoor Unit main PCB</p>
<p><b>Inspection procedure and key points</b></p>	<ol style="list-style-type: none"> <li>1. Check whether the motor accelerates to extremely high speed before the error occurs. If it can work for a period, the reason of mechanical jam can be excluded.</li> <li>2. Plug and unplug the terminal of the DC motor again to exclude any motor error due to connector loosening, and pull the terminal slightly for inspection if necessary.</li> <li>3. Replace the motor in the faulted air conditioner with other DC motor to plug in the Indoor Unit main PCB (do not fix it with the fan for the time being), if the main PCB still indicates “DC motor error”, then replace the Indoor Unit main PCB; if the error disappears, replace the DC motor.</li> <li>4. Multimeter can be used to distinguish whether it is main PCB problem or motor problem by: connect the motor with the main PCB and pay attention to the second (yellow) and fourth (black) wire from the outermost side among four lines of the terminal of the DC motor. After the air conditioner powers on in the cooling mode for a while, the voltage between the yellow and black wires should rise gradually and the motor should accelerates slowly, if the DC motor still won’t rotate, then the DC motor is destroyed.</li> </ol>

<b>Special attention</b>	<b>Five lead wires division:</b> Count from the outermost side of the four wires of the DC motor terminal, the first blue wire is the speed feedback wire with a voltage of 0.5-5V when the motor rotates; the second yellow wire is the motor driving wire with a voltage of 2.0-7.5V when the motor rotates; the second white wire is 15V power cord with a voltage of 15V in normal condition; the fourth black wire is 0V DC earth wire which is the benchmark of all the voltage tests; the fifth (red) wire is 310V wire which is strong with a voltage of 310V in normal condition, so be careful of electric shock.
--------------------------	---

**(7) Eb- Indoor EE Failure**

<b>Explanation of error</b>	Cause: Many parameters need to be preset for the running of the indoor unit of the air conditioner and such parameters are placed in a data storage 8-foot chip, which is called "EEPROM" or "EE" for short. The motor on the Indoor Unit main PCB can only work after reading the data stored in EE and if not read, the failure code "Outdoor EE Failure" will be indicated and raised in the indoor unit. Reasons for data not being read are as follows: 1. wrong EE chip data format; 2. EE chip is broken; 3. bad contact of EE or fault of EE reading circuit; 4. backward installation of EE chip. Inspection path: Indoor Unit main PCB.
<b>Tools required for inspection</b>	/
<b>Frequent problematic part</b>	Bad contact of EE, Indoor Unit main PCB.
<b>Inspection procedure and key points</b>	Replace the Indoor Unit main PCB directly.

**(8) P2- High-pressure protection**

<b>Explanation of error</b>	Cause: In standby state or when the equipment is running, the High-pressure switch is disconnected three times (within 20 minutes) and reported as " High-pressure protection"; Inspection path: High-pressure switch cable → connector → High-pressure switch → main PCB
<b>Tools required for inspection</b>	Multimeter, connectoin line and High-pressure swtich
<b>Frequent problematic part</b>	High-pressure swtich connectoin line, fluorine deficiency of unit and High-pressure swtich
<b>Inspection procedure and key points</b>	<ol style="list-style-type: none"><li>1. Check whether the plug-in terminals are firmly connected and whether the terminals and the main PCB are welded loosely. If necessary, gently pull them to check;</li><li>2. Use a multimeter to measure whether it is disconnected;</li><li>3. Use the multimeter to check the state of the High-pressure swtich and check whether it is in the OFF state (normally OFF, unusual disconnection);</li><li>4. If the pressure is normal and the High-pressure switch is kept open, it is positive that the pressure voltage is faulted;</li><li>5. If the pressure switch is normal and the connection line is tact and the failure is still reported, replace the corresponding main PCB.</li></ol>

<b>Special attention</b>	The reason why High-pressure switches are often disconnected is the leakage of equipment. When the high voltage switch is off, first check whether the air conditioner's pressure is normal. If it is normal but the failure is still displayed after replacing the Outdoor Unit main PCB, it is possible that the connecting pipe may be too long or the Outdoor Unit ambient temperature is too low
--------------------------	---

**(9) P3- Liquid Deficiency Protection**

<b>Explanation of error</b>	Cause: The liquid volume of the system is less than 30%, which leads to non-refrigeration and liquid shortage protection. Inspection path: whether the valves of the outdoor unit are opened → whether the evaporator, condenser, connection pipe are damaged or cracked → whether the environmental temperature sensor and the coil temperature sensor are damaged at the same time
<b>Tools required for inspection</b>	Hex nut, multimeter, pressure gauge
<b>Frequent problematic part</b>	Stop valve, evaporator, condenser and connection pipe
<b>Inspection procedure and key points</b>	<ol style="list-style-type: none"> <li>1. Check the stop valve and turn it counterclockwise with hexagons to see if the valve is not open and the opening is not enough;</li> <li>2. Check whether the evaporator, condenser and connection pipe are damaged or cracked, and focus on checking whether there is refrigerant leakage in the welding part and connection pipe joint;</li> <li>3. Measure the temperature sensor with the multimeter at ambient temperature, and whether the coil temperature sensor has abnormal resistance at the same time.</li> </ol>



## 9-2 Troubleshooting for Normal Malfunction

### ➤ The Foremost Inspecting Items

- ① The input voltage must be within +10% tolerance of the rated Voltage. If it is not the case, the air-conditioner will probably not work normally.
- ② Check the connecting cord between indoor unit and outdoor unit to see if it is properly connected. The connecting must be done according to the wiring diagram, please also notice that even different models may have the connecting cord of the same specification. Please check if the marks at the connecting terminal and the marks on the cord can match, otherwise, the air-conditioner will not work normally.
- ③ If the following phenomena are found, the problem is not from the air-conditioner itself.

NO.	Problems	Causes
1	The motor is heard operating but the air-conditioner does not work when the indoor unit is powered on	Since the air-conditioner is powered on, it will come to working condition as long as you press the ON/OFF button of the remote control and the Signal is well received.

2	The compressor stops running but the indoor Motor keeps working when it is at cooling mode with the indoor temperature higher than set temperature.	If you turn off the air-conditioner and restart it immediately, it will return to normal in 3 minutes, after that, the air-conditioner will automatically adjust the indoor motor speed to what you set.
3	The compressor works discontinuously at dehumidifying mode.	The air-conditioner will automatically control the working of the compressor according to the inside temperature.
4	The air-conditioner does not work while the LED display is on.	The TIMER is set with the A/C; it will be in hold on condition. If the TIMER setting is cancelled, the air-conditioner will return to normal working condition.
5	The compressor works discontinuously at cooling and dehumidifying mode, and the indoor Motor slows down.	The compressor stops Indoor Unit or the Motor slows down to prevent the indoor heat exchanger from being frozen.

## ➤ Fault Diagnosis by Symptom

### ① No Power Display

#### (1) Items

- a) Check if the input voltage is correct?
- b) Check if the AC power supply connecting is correct?
- c) Check if the output voltage of the manostat L7805 (IC2) is correct?

#### (2) Trouble shooting procedure

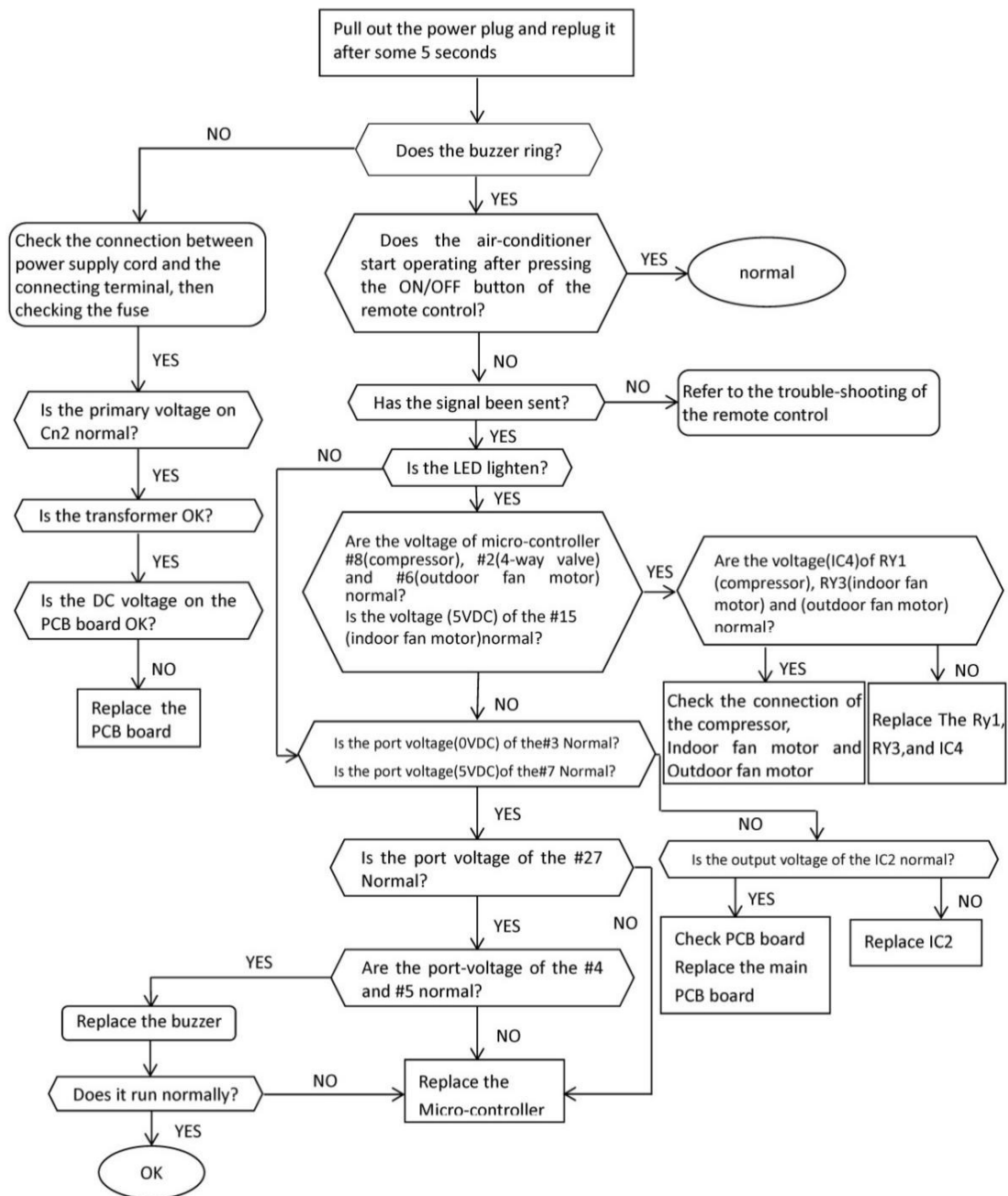

## ②The Indoor Motor Does Not Work

### (1) Items

- a) Check if the indoor Motor is connected correctly to the connector (CN8)?
- b) Check if the AC input voltage is correct?
- c) Check if the IC of indoor Motor is connected correctly to the connector (CN2)?
- d) Check if the capacity of indoor Motor is connected correctly to the connector (CN8)?

## (2) Trouble shooting procedure

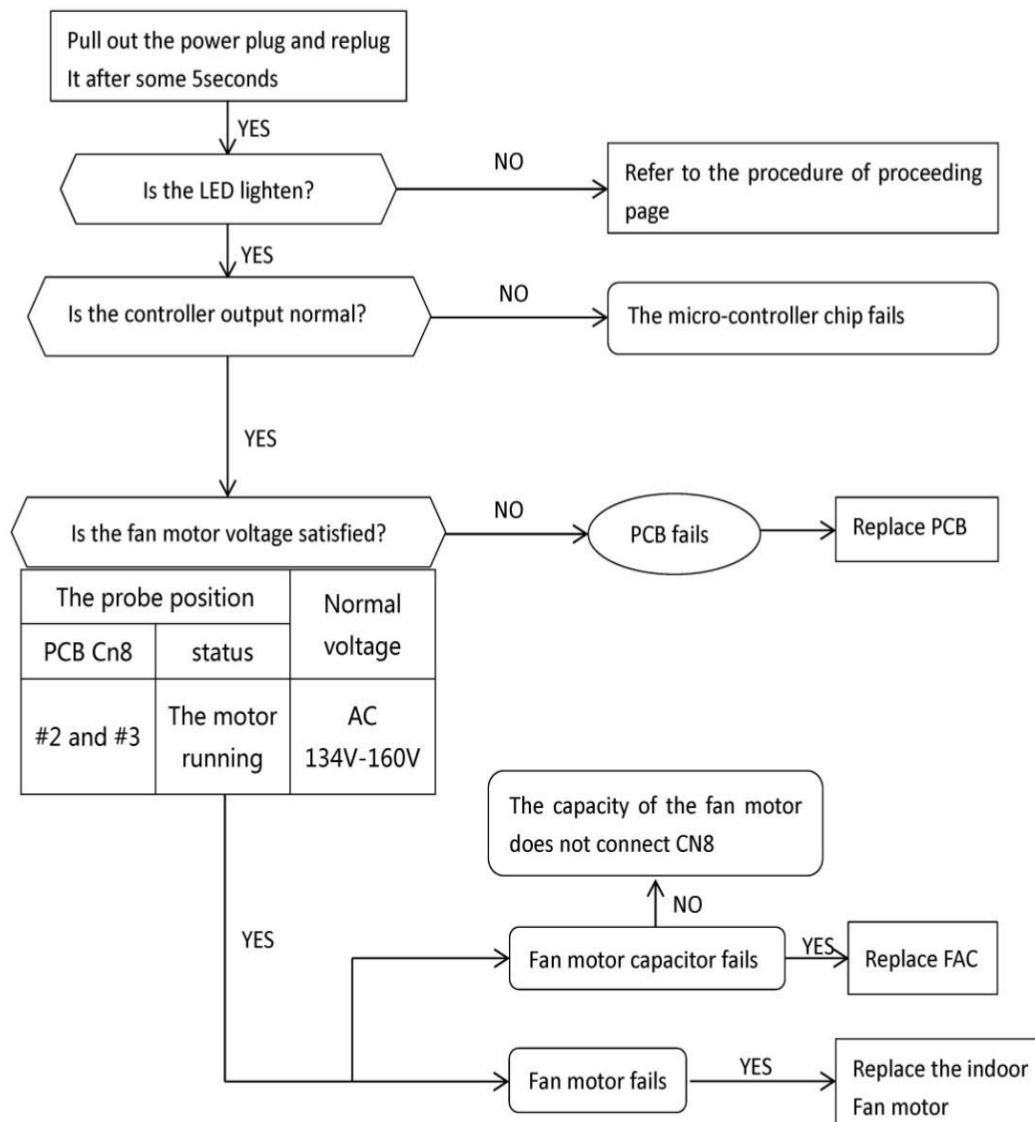

## ③The Outdoor Unit Does Not Work

### (1) Items

- a) Check if the input voltage is correct?
- b) Check if the wire connection of the outdoor connecting terminal is correct?

### (2) Trouble shooting procedure

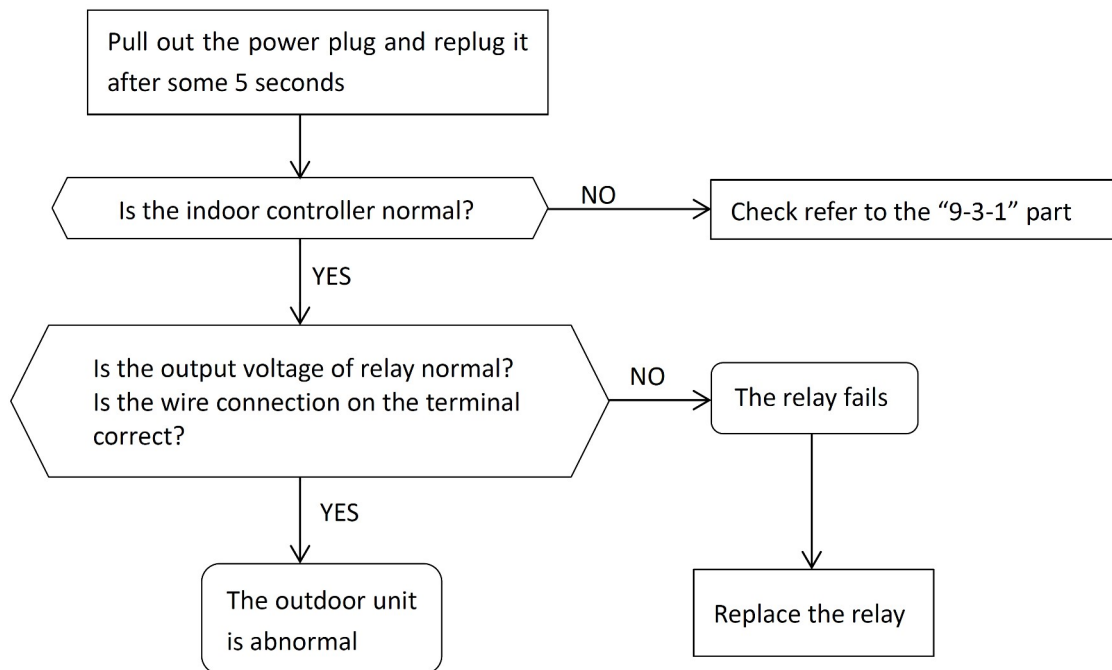

#### ④The Step Motor Does Not Work

(1) Items

- a) Check if the input voltage is correct?
- b) Check if the step motor controlling the up-down movement firmly connected to Cn2?

(2) Trouble shooting procedure

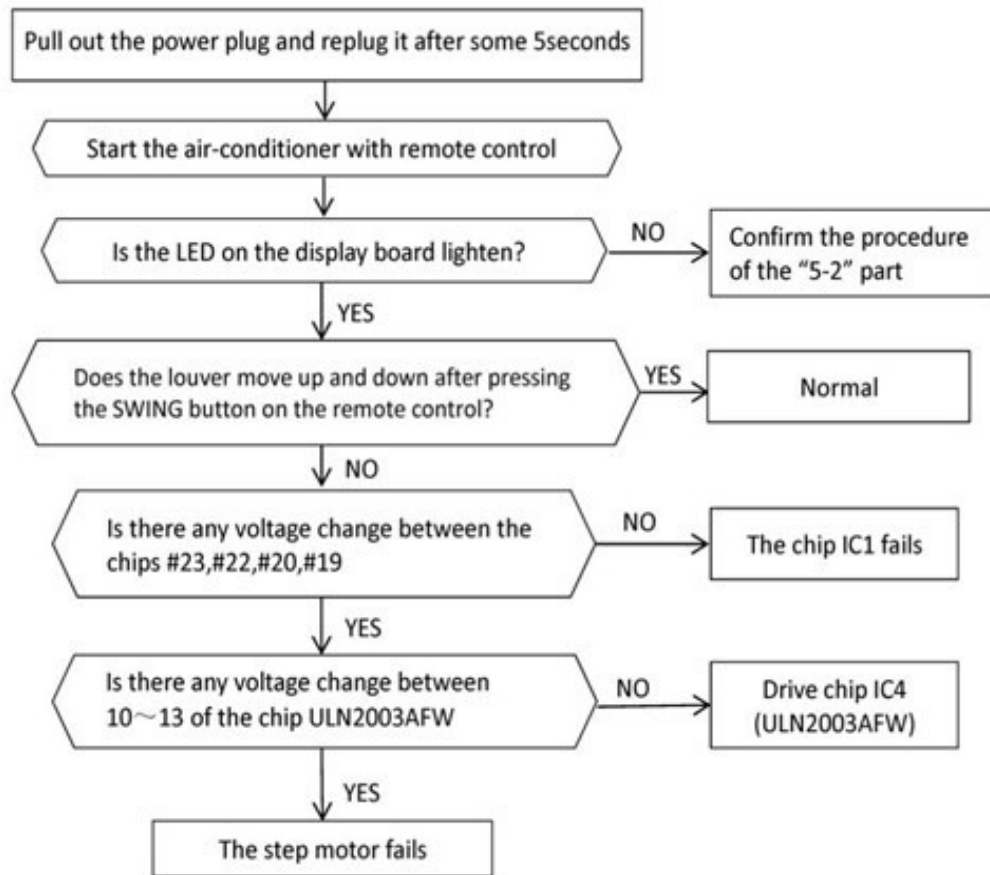

⑤ Heating Mode Can Work, But No Hot Air Blow

- (1) Check if the set temperature is lower than the indoor temperature?
- (2) Check if the indoor PCB is connected to the terminal correctly?

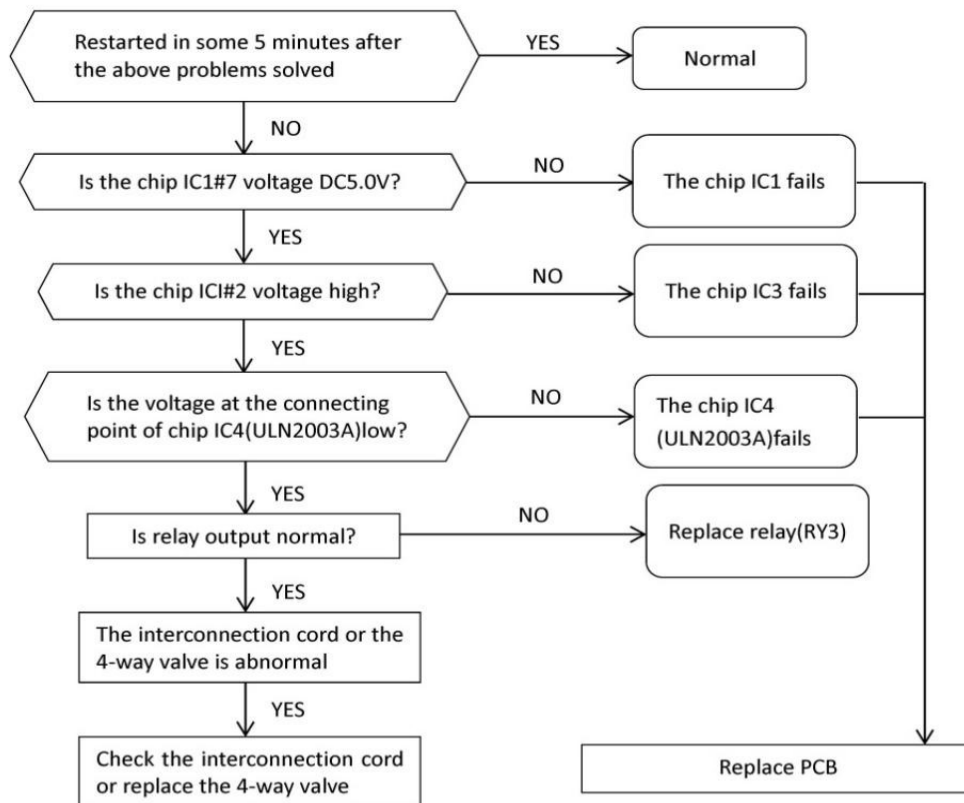

### ⑥ Remote Control Can Not Work

Trouble shooting procedure

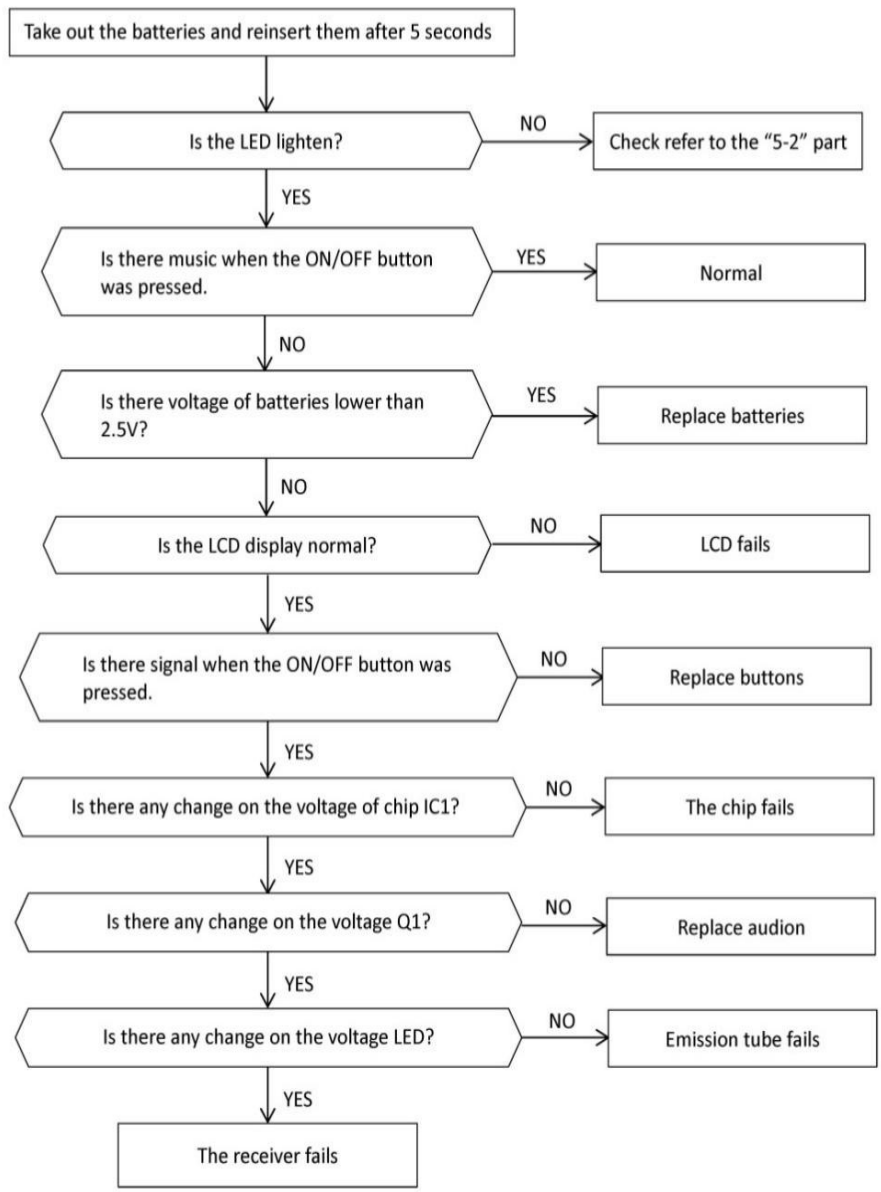



## 10. Exploded Views and Parts List

### 10-1 Indoor Unit

#### ➤ Exploded View

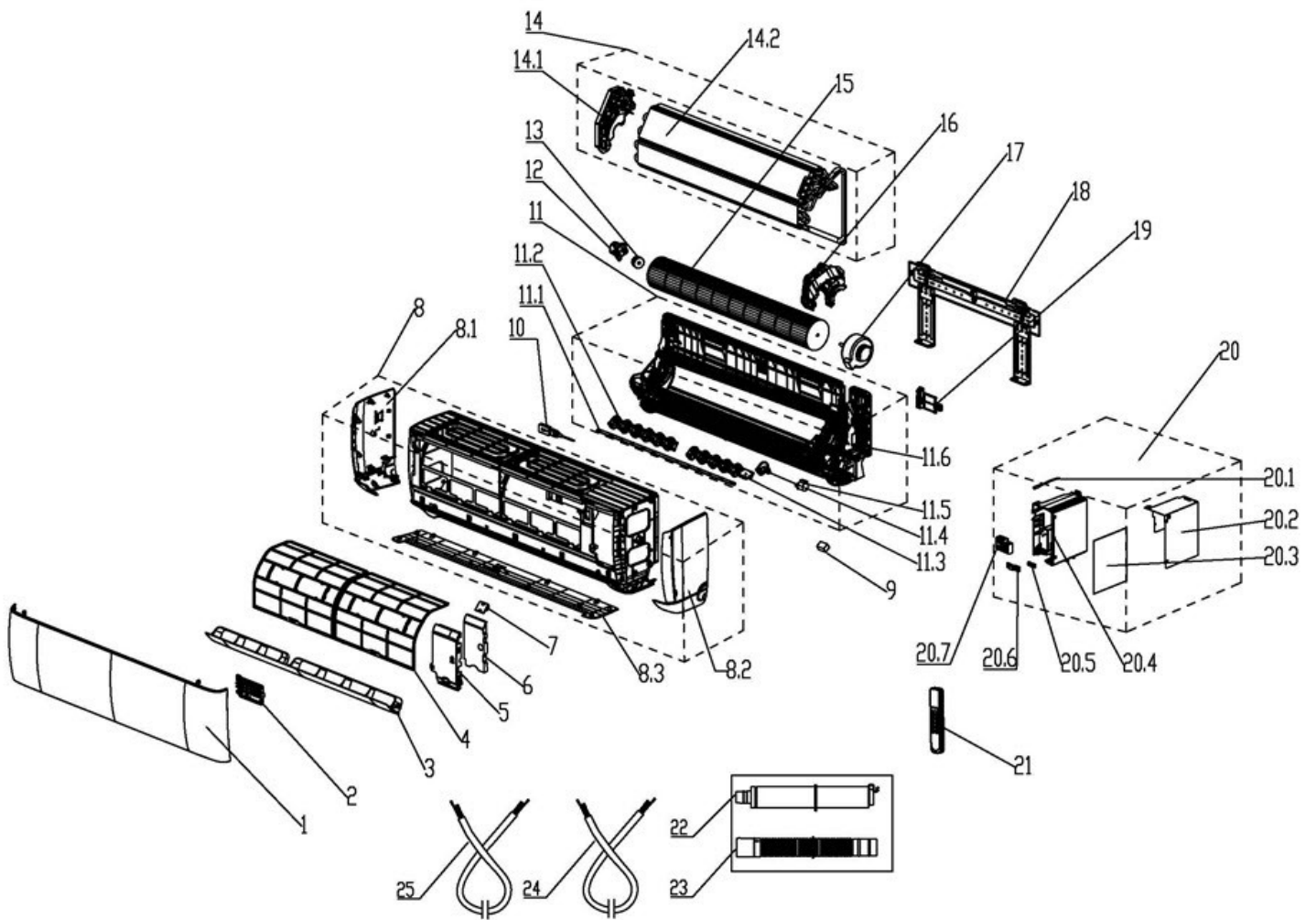

➤ **Part List**

<b>NO.</b>	<b>Part Name</b>	<b>Quantity</b>	<b>NO.</b>	<b>Part Name</b>	<b>Quantity</b>
1	panel	1	13	Evaporator assembly	1
2	Display board	1	13.1	Evaporator left side carriage	1
3	Air louver	1	13.2	Evaporator part A	1
4	Filter	2	13.3	Evaporator part B	1
5	Medium frame decorative strip	1	14	Motor cover	1
6	Left side panel	1	15	IDU Motor	1
7	Medium frame	1	16	Mounting plate assembly	1
8	Right side panel	1	17	Pipe clamp	1
9	Chassis assembly	1	19	Main controller	1
9.1	Manual louver link	1	19.3	Control box	1
9.2	air blade (vertical)	2	19.4	Main control board	1
9.3	Air louver	1	19.7	Terminal board	1
9.7	Chassis	1	20	Control box cover	1
9.8	Drain jam	1	24	Remote controller	1
9.9	Shaft sleeve	1	25	Medium frame wiring cover	1
9.10	Step motor	1	27	Screw cover	1
10	Bearing assembly	1	28	Outlet pipe assembly	1
11	Bearing fixed chassis	1	29	Drain hose	
12	Cross flow motor	1			

## 10-2 Outdoor Unit

### ➤ Exploded View

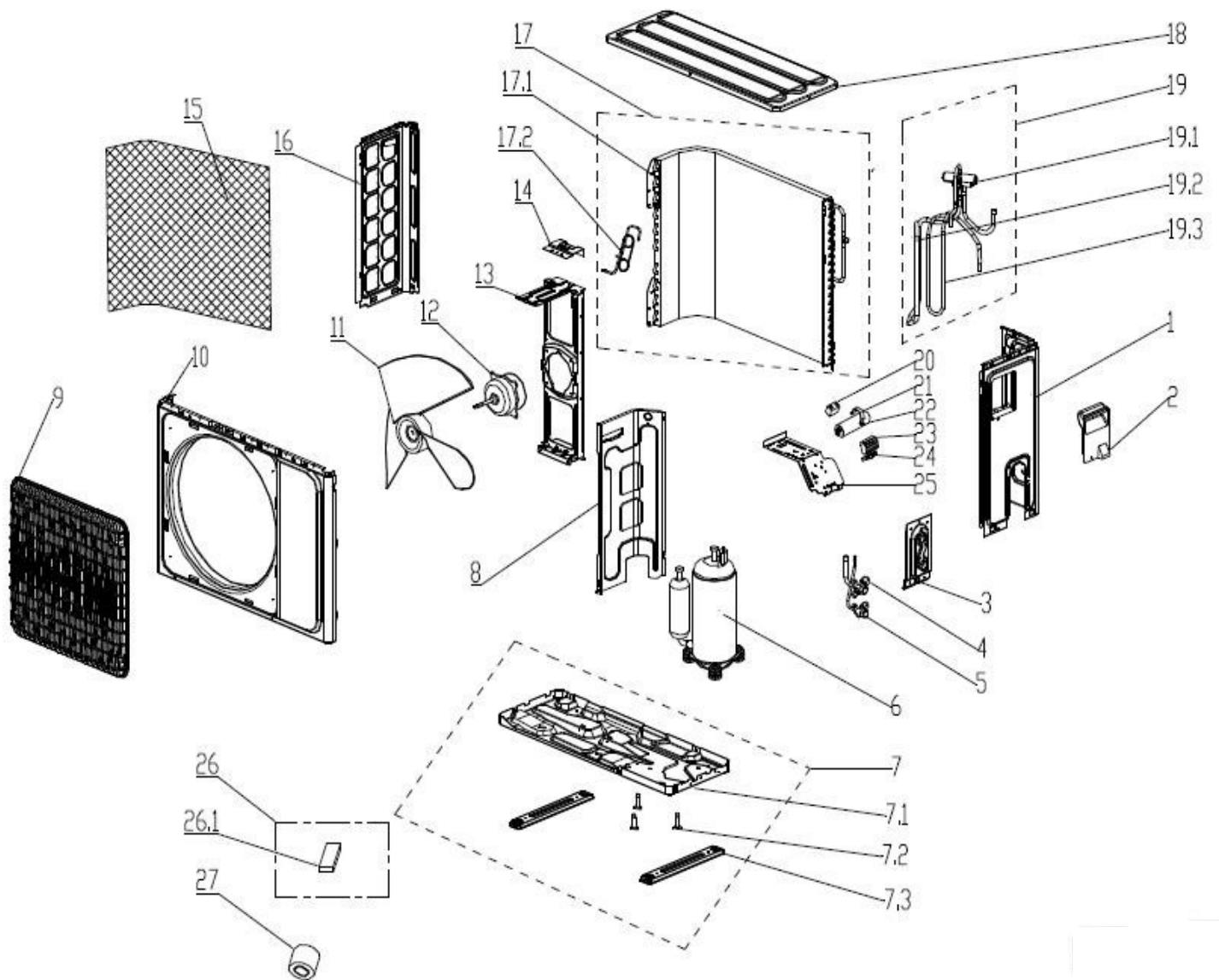

➤ **Part List**

<b>NO.</b>	<b>Part Name</b>	<b>Quantity</b>	<b>NO.</b>	<b>Part Name</b>	<b>Quantity</b>
1	Right side board	1	17	Condenser assembly	1
2	E-parts cover	1	17.1	Condenser assembly	1
3	Valve plate	1	17.2	Capillary assembly	1
4	Stop valve	1	18	Top cover	1
5	Stop valve	1	19	4-way valve tubing assembly	1
6	Compressor assembly	1	19.1	4-way valve	1
7	Chassis assembly	1	19.2	Suction pipe assembly	1
7.1	Chassis	1	19.3	Discharge pipe assembly	1
7.2	Compressor footing bolt	3	20	Motor capacitor	1
7.3	Base footing	2	21	Capacitor clamp	1
8	Partition board	1	22	Compressor capacitor	1
9	Panel grille	1	23	Terminal board	1
10	Panel	1	24	Cable clamp	1
11	Axial flow motor	1	24	Cable clamp	1
12	Motor	1	25	E-parts bracket	1
13	Motor support	1	26	Accessories	1
14	Hanging ear of condenser	1	26.1	Putty	1
15	Rear grille	1	27	Plastic tie	1
16	Left side board	1			

## 11. Removal Procedure

Stop operation of the air conditioner and remove the power cord before repairing the unit.

### 11-1 Indoor Unit

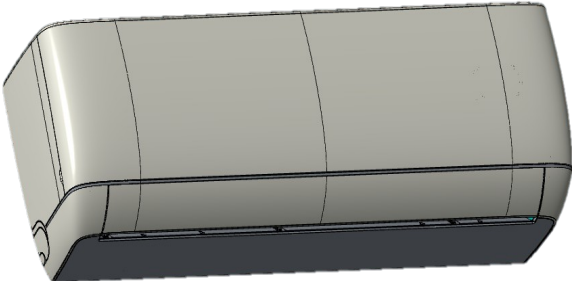
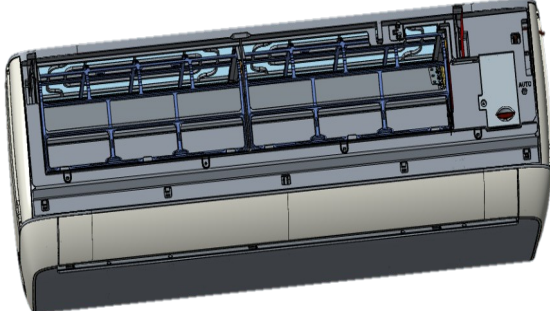
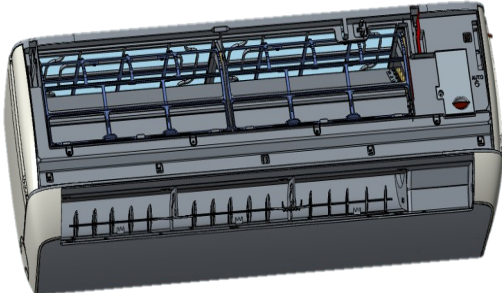
Parts	Procedure	Diagram
Front Panel	1) Turn off the power, hold the middle panel with the middle finger, 2) open the panel upwards, remove the panel fixing shaft, and remove the panel.	
air louver	Remove axial sleeve of air louver, bend the louver outwards and then remove the louver.	
air filter	Loosen the clasp of filter, push the filter inward and then draw it upward to remove it.	

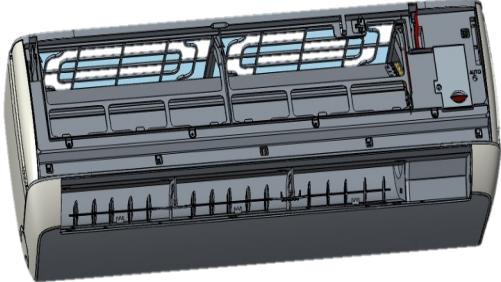
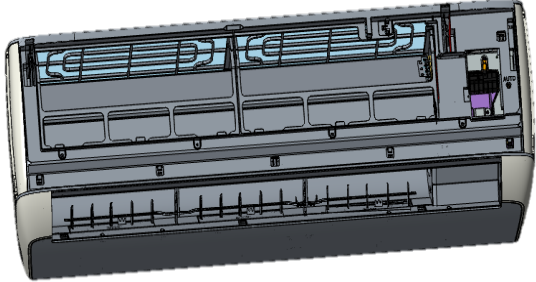
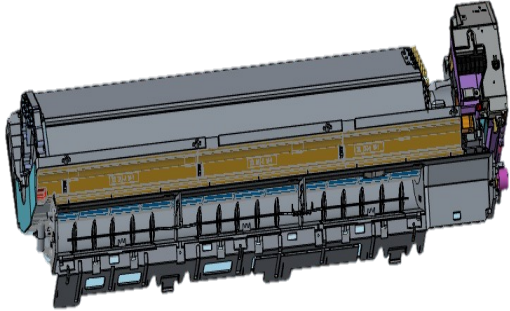
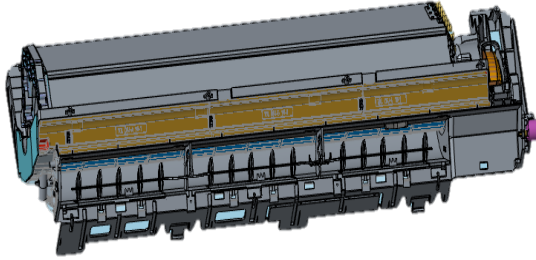
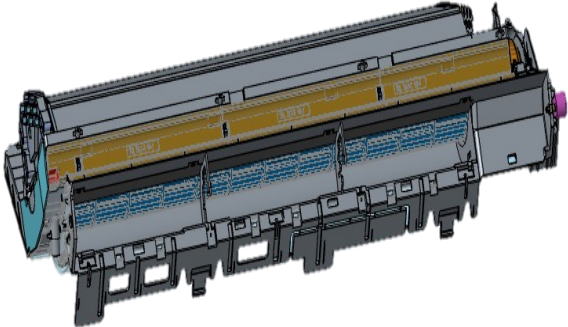

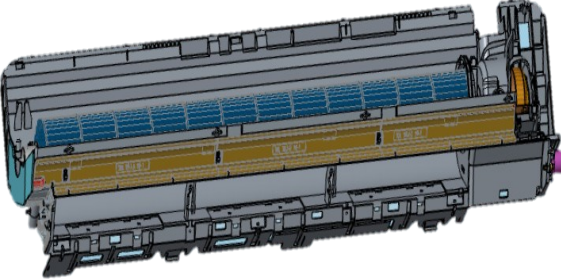
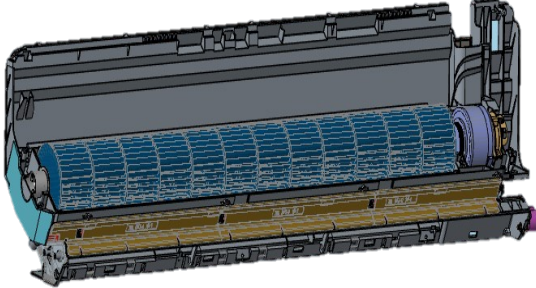
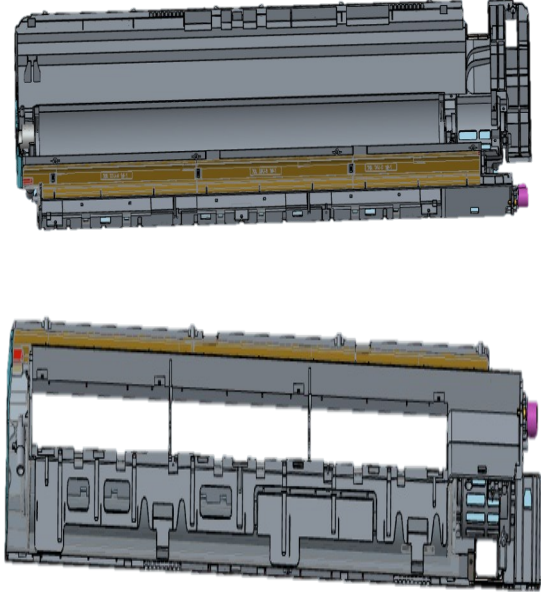
<p>Medium frame wiring cover</p>	<p>Loosen the screws of the medium frame wiring cover with screwdriver , remove the electric box cover.</p>	
<p>medium frame</p>	<p>Loosen the clasps of the medium frame , remove the medium frame.</p>	
<p>Electrical Parts (Main PCB)</p>	<ol style="list-style-type: none"> <li>1) Take all the connector of PCB upper side out.(Including Power cord)</li> <li>2) Detach the outdoor unit connection wire from the terminal block.</li> <li>3) If pulling the main PCB up, it will be taken out.</li> </ol>	
<p>air vent, louver link</p>	<p>Remove axial sleeve of louver link, bend the air vent outwards and then remove the air vent and louver link.</p>	
<p>Heat Exchanger</p>	<ol style="list-style-type: none"> <li>1) Loosen fixing earth screws of right side.</li> <li>2) Detach the connection pipe.</li> <li>3) Detach the holder pipe at the rear side.</li> <li>4) Loosen fixing screws of right and left side.</li> <li>5) Detach the heat exchanger from the indoor unit.</li> </ol>	

<p>Motor press plate</p>	<p>Remove the screw of the motor press plate and then remove the press plate.</p>	
<p>Motor &amp; Cross Motor</p>	<ol style="list-style-type: none"> <li>1) Loosen fixing screws and detach the motor holder.</li> <li>2) Loosen fixing screw of motor. (with a M6 wrench)</li> <li>3) Detach the motor from the motor.</li> <li>4) Detach the motor from the left holder bearing.</li> </ol>	
<p>volute</p>	<p>Remove screws on volute and remove the volute.</p>	



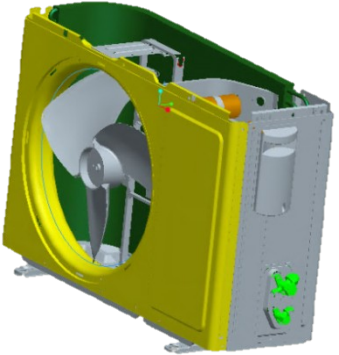

## 11-2 Outdoor Unit

Part	Procedure	Diagram
top cover	Turn off the power , remove connection screws among top cover plate, front panel and right side panel, then remove the top cover.	
panel grille	Remove connection screws between the front grille and the front panel .Then remove the front grille.	
Front panel	Remove connection screws connecting the front panel with the chassis and the motor support , and remove the front pannel.	

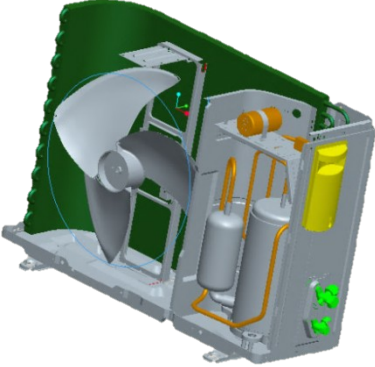
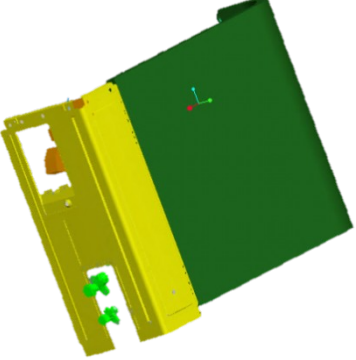
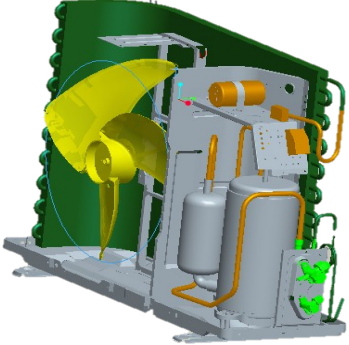
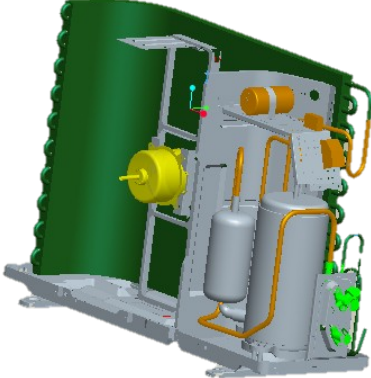
<p>E-part cover</p>	<p>Remove connection screws Connecting the right side panel, then remove the E-part cover.</p>	
<p>Right side panel</p>	<p>Remove connection screws connecting the right side panel with the valve support and electric box, then remove the right side panel.</p>	
<p>Axial flow blade</p>	<p>Remove the nut fixing the blade and then remove the axial flow blade.</p>	
<p>Outer motor</p>	<p>Remove the tapping screws fixing the motor, pull out the lead-out wire and remove the motor.</p>	

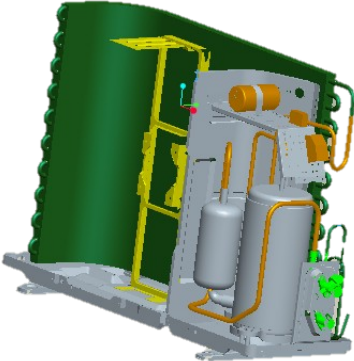
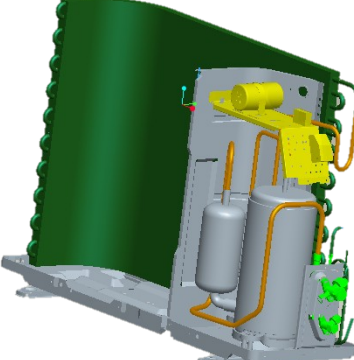
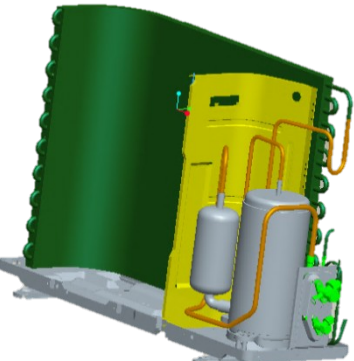
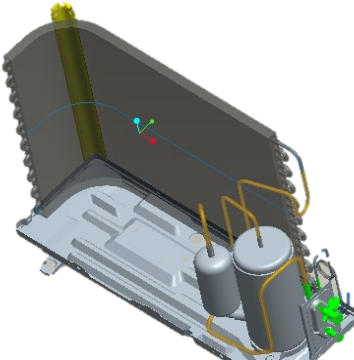
<p>Motor support</p>	<p>Remove the tapping screws fixing the motor support . Lift motor support to remove it.</p>	
<p>Electric box assy</p>	<p>Loosen the wire and disconnect the terminal. Lift to remove the electric box assy.</p>	
<p>Partition board</p>	<p>Loosen the screws of the partition board , then lift and pull the partition board to remove .</p>	
<p>left side support plate</p>	<p>Remove connection screws connecting the left side support plate with the valve support, then remove the left side support plate.</p>	

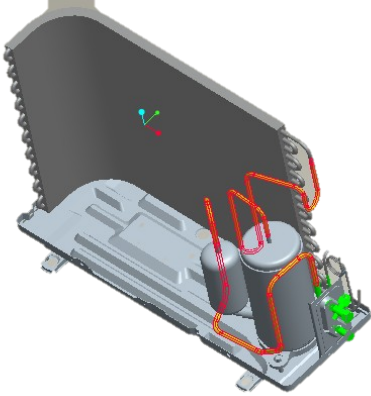
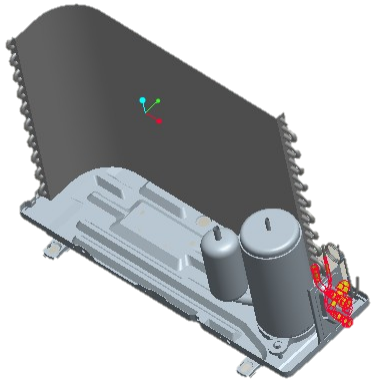
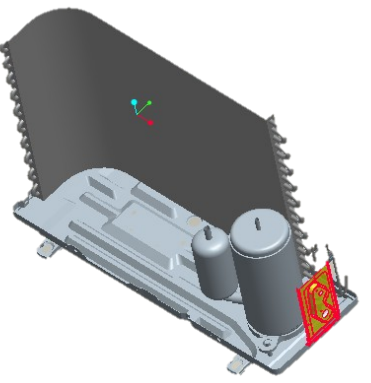
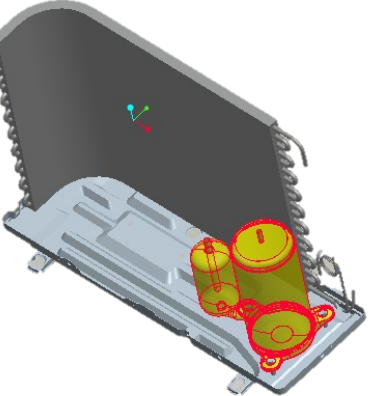
<p>Pipeline assembly</p>	<p>After the unit is discharged, Unscrew the fastening nut of the 4-way Valve Assy coil and remove the pipeline assembly.</p>	
<p>Stop valve assembly</p>	<ol style="list-style-type: none"> <li>1) Remove the screws fixing the gas valve.</li> <li>2) Unsolder the welding spot connecting gas valve and air return pipe and remove the gas valve.</li> <li>3) Remove the screws fixing liquid valve. Unsolder the welding spot connecting liquid valve and remove the liquid valve.</li> </ol>	
<p>Valve plate</p>	<p>Loosen 1 footing screws of valve plate, remove the valve plate.</p>	
<p>Compressor</p>	<p>Loosen 3 footing screws of compressor, Remove and remove the compressor.</p>	

condenser

Loosen fixing screws Connecting chassis, and remove the condenser. Last remaining chassis.

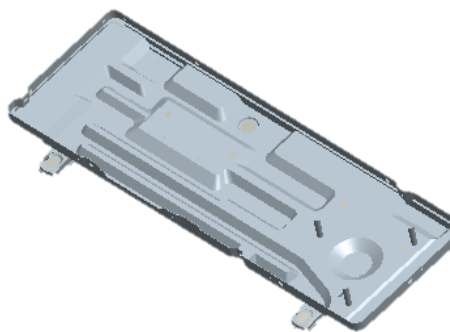
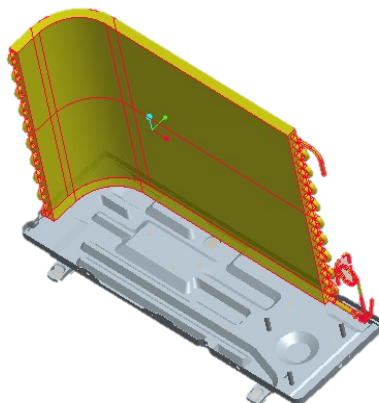

## Appendix

### AUX Common Sensor R-T Analysis Table

Temperature sensor R-T analysis table (15K)									
Sensor standard resistance : 15K $\Omega$ $\pm$ 3%      B:B(25/50)=3950K $\pm$ 2% Reference temperature : 25 (°C)									
MCU_A/D exchange $\pm$ 3LSB ( at10bit )									
Series (sampling) resistor : 10 ( K $\Omega$ ) $\pm$ 1% (except disk sensor)									
Single chip (A/D reference voltage) supply voltage : 5V									
Temp ( °C )	Resistance ( K $\Omega$ )			MCU Input voltage ( V )			A/D Exchange value		
	MIN	TYP	MAX	MIN	TYP	MAX	MIN	TYP	MAX
-25.0	183.4	199.1	216.0	0.219	0.239	0.261	42	49	56
-24.0	172.8	187.4	203.0	0.233	0.253	0.276	45	52	60
-23.0	162.9	176.5	190.9	0.247	0.268	0.292	47	55	63
-22.0	153.7	166.2	179.6	0.261	0.284	0.308	50	58	66
-21.0	145.0	156.7	169.1	0.277	0.300	0.326	54	61	70
-20.0	136.9	147.7	159.2	0.293	0.317	0.344	57	65	73
-19.0	129.2	139.3	150.0	0.310	0.335	0.363	60	69	77
-18.0	122.1	131.4	141.4	0.327	0.354	0.382	64	72	81
-17.0	115.4	124.1	133.3	0.346	0.373	0.402	68	76	85
-16.0	109.1	117.2	125.7	0.365	0.393	0.424	72	81	90
-15.0	103.1	110.7	118.6	0.385	0.414	0.446	76	85	94
-14.0	97.59	104.6	112.0	0.406	0.436	0.469	80	89	99
-13.0	92.37	98.88	105.8	0.428	0.459	0.493	85	94	104
-12.0	87.45	93.52	99.92	0.451	0.483	0.518	89	99	109
-11.0	82.83	88.48	94.43	0.474	0.508	0.543	94	104	114
-10.0	78.48	83.74	89.27	0.499	0.533	0.570	99	109	120
-9.0	74.39	79.29	84.43	0.525	0.560	0.598	104	115	125
-8.0	70.54	75.10	79.88	0.551	0.588	0.626	110	120	131
-7.0	66.90	71.15	75.61	0.579	0.616	0.656	116	126	137
-6.0	63.48	67.44	71.59	0.607	0.646	0.686	121	132	144
-5.0	60.25	63.95	67.80	0.637	0.676	0.718	127	138	150
-4.0	57.21	60.65	64.24	0.668	0.708	0.750	134	145	157
-3.0	54.34	57.55	60.89	0.699	0.740	0.784	140	152	163
-2.0	51.63	54.62	57.73	0.732	0.774	0.818	147	158	171
-1.0	49.07	51.86	54.76	0.766	0.808	0.853	154	166	178
0.0	46.65	49.25	51.95	0.800	0.844	0.890	161	173	185
1.0	44.37	46.79	49.31	0.836	0.880	0.927	168	180	193
2.0	42.21	44.47	46.81	0.873	0.918	0.965	176	188	201
3.0	40.17	42.28	44.46	0.911	0.956	1.005	183	196	209
4.0	38.24	40.20	42.24	0.949	0.996	1.045	191	204	217
5.0	36.41	38.25	40.14	0.989	1.036	1.086	200	212	225

6.0	34.68	36.39	38.16	1.030	1.078	1.128	208	221	234
7.0	33.05	34.64	36.29	1.072	1.120	1.170	216	229	243
8.0	31.50	32.99	34.52	1.114	1.163	1.214	225	238	252
9.0	30.03	31.42	32.84	1.158	1.207	1.258	234	247	261
10.0	28.64	29.94	31.26	1.203	1.252	1.304	243	256	270
11.0	27.32	28.53	29.77	1.248	1.298	1.350	253	266	279
12.0	26.07	27.20	28.35	1.294	1.344	1.396	262	275	289
13.0	24.89	25.94	27.01	1.341	1.391	1.443	272	285	299
14.0	23.76	24.74	25.74	1.389	1.439	1.491	281	295	308
15.0	22.69	23.61	24.54	1.437	1.488	1.540	291	305	318
16.0	21.68	22.53	23.40	1.486	1.537	1.589	301	315	328
17.0	20.72	21.51	22.32	1.536	1.587	1.639	312	325	339
18.0	19.80	20.55	21.30	1.587	1.637	1.689	322	335	349
19.0	18.94	19.63	20.33	1.637	1.687	1.739	332	346	359
20.0	18.11	18.75	19.40	1.689	1.739	1.790	343	356	370
21.0	17.33	17.93	18.53	1.741	1.790	1.841	354	367	380
22.0	16.58	17.14	17.70	1.793	1.842	1.893	364	377	391
23.0	15.87	16.39	16.91	1.846	1.895	1.945	375	388	401
24.0	15.19	15.68	16.16	1.899	1.947	1.997	386	399	412
25.0	14.55	15.00	15.45	1.953	2.000	2.049	397	410	423
26.0	13.91	14.36	14.80	2.004	2.053	2.103	407	420	434
27.0	13.31	13.74	14.18	2.056	2.106	2.157	418	431	445
28.0	12.73	13.16	13.59	2.107	2.159	2.212	429	442	456
29.0	12.18	12.60	13.03	2.159	2.212	2.267	439	453	467
30.0	11.66	12.08	12.49	2.211	2.264	2.321	450	464	478
31.0	11.17	11.57	11.98	2.262	2.318	2.374	460	475	489
32.0	10.69	11.09	11.49	2.314	2.371	2.429	471	486	500
33.0	10.24	10.63	11.03	2.365	2.424	2.483	481	496	511
34.0	9.816	10.20	10.59	2.416	2.475	2.536	492	507	522
35.0	9.408	9.782	10.16	2.468	2.528	2.589	502	518	533
36.0	9.019	9.385	9.758	2.518	2.579	2.641	513	528	544
37.0	8.648	9.007	9.372	2.568	2.631	2.694	523	539	555
38.0	8.294	8.645	9.003	2.619	2.682	2.745	533	549	565
39.0	7.957	8.300	8.651	2.668	2.732	2.797	543	560	576
40.0	7.635	7.971	8.315	2.718	2.782	2.847	554	570	586
41.0	7.328	7.657	7.993	2.766	2.832	2.898	564	580	596
42.0	7.034	7.356	7.686	2.815	2.881	2.947	573	590	607
43.0	6.755	7.069	7.391	2.863	2.929	2.996	583	600	617
44.0	6.487	6.795	7.110	2.910	2.977	3.045	593	610	627
45.0	6.232	6.532	6.841	2.957	3.024	3.092	603	619	636
46.0	5.988	6.282	6.584	3.003	3.071	3.139	612	629	646
47.0	5.755	6.042	6.337	3.049	3.117	3.185	621	638	655
48.0	5.532	5.812	6.101	3.094	3.162	3.231	631	648	665
49.0	5.319	5.593	5.875	3.138	3.207	3.275	640	657	674
50.0	5.115	5.382	5.659	3.181	3.251	3.319	649	666	683
51.0	4.919	5.180	5.450	3.225	3.294	3.362	657	675	692
52.0	4.732	4.987	5.251	3.267	3.336	3.405	666	683	700

53.0	4.553	4.802	5.060	3.309	3.378	3.446	675	692	709
54.0	4.382	4.625	4.877	3.350	3.419	3.487	683	700	717
55.0	4.219	4.457	4.703	3.390	3.459	3.527	691	708	725
56.0	4.061	4.293	4.534	3.429	3.498	3.566	699	716	733
57.0	3.911	4.137	4.373	3.468	3.537	3.604	707	724	741
58.0	3.767	3.988	4.218	3.506	3.574	3.642	715	732	749
59.0	3.630	3.845	4.070	3.543	3.611	3.678	723	740	756
60.0	3.498	3.708	3.927	3.580	3.648	3.714	730	747	764
61.0	3.371	3.577	3.791	3.616	3.683	3.749	737	754	771
62.0	3.250	3.450	3.660	3.650	3.717	3.783	745	761	778
63.0	3.134	3.329	3.534	3.685	3.751	3.816	752	768	785
64.0	3.022	3.213	3.413	3.718	3.784	3.848	758	775	791
65.0	2.915	3.102	3.297	3.751	3.816	3.880	765	782	798
66.0	2.813	2.995	3.185	3.783	3.848	3.911	772	788	804
67.0	2.714	2.892	3.078	3.814	3.878	3.941	778	794	810
68.0	2.620	2.793	2.975	3.845	3.908	3.970	784	800	816
69.0	2.529	2.698	2.876	3.874	3.938	3.999	790	806	822
70.0	2.442	2.607	2.781	3.903	3.966	4.026	796	812	828
71.0	2.358	2.519	2.689	3.932	3.994	4.054	802	818	833
72.0	2.278	2.435	2.601	3.960	4.021	4.080	808	823	839
73.0	2.200	2.354	2.516	3.987	4.047	4.106	813	829	844
74.0	2.126	2.276	2.435	4.013	4.073	4.131	819	834	849
75.0	2.055	2.201	2.356	4.039	4.098	4.155	824	839	854
76.0	1.986	2.129	2.280	4.064	4.122	4.178	829	844	859
77.0	1.920	2.060	2.208	4.088	4.146	4.201	834	849	863
78.0	1.857	1.993	2.138	4.112	4.169	4.223	839	854	868
79.0	1.796	1.929	2.070	4.135	4.191	4.245	844	858	872
80.0	1.737	1.867	2.005	4.158	4.213	4.266	849	863	877
81.0	1.681	1.808	1.942	4.180	4.234	4.287	853	867	881
82.0	1.626	1.750	1.882	4.201	4.255	4.307	857	871	885
83.0	1.574	1.695	1.824	4.222	4.275	4.326	862	876	889
84.0	1.524	1.642	1.767	4.243	4.295	4.344	866	880	893
85.0	1.475	1.590	1.713	4.262	4.314	4.363	870	884	897
86.0	1.428	1.541	1.661	4.282	4.332	4.381	874	887	900
87.0	1.383	1.493	1.611	4.300	4.350	4.398	878	891	904
88.0	1.340	1.447	1.562	4.319	4.368	4.414	881	895	907
89.0	1.298	1.403	1.515	4.336	4.385	4.431	885	898	910
90.0	1.258	1.360	1.470	4.354	4.401	4.446	889	901	914
91.0	1.219	1.319	1.426	4.370	4.417	4.462	892	905	917
92.0	1.181	1.279	1.384	4.387	4.433	4.477	895	908	920
93.0	1.145	1.241	1.343	4.403	4.448	4.491	899	911	923
94.0	1.110	1.204	1.304	4.418	4.463	4.505	902	914	926
95.0	1.077	1.168	1.266	4.433	4.477	4.518	905	917	928
96.0	1.044	1.134	1.229	4.448	4.491	4.532	908	920	931
97.0	1.013	1.100	1.194	4.462	4.505	4.544	911	923	934
98.0	0.9826	1.068	1.160	4.476	4.518	4.557	914	925	936
99.0	0.9535	1.037	1.127	4.489	4.530	4.569	916	928	939



100.0	0.9252	1.007	1.095	4.502	4.543	4.580	919	930	941
101.0	0.8981	0.9778	1.064	4.515	4.555	4.592	922	933	943
102.0	0.8717	0.9497	1.034	4.527	4.566	4.603	924	935	946
103.0	0.8463	0.9225	1.005	4.539	4.578	4.613	927	938	948
104.0	0.8218	0.8963	0.9767	4.551	4.589	4.624	929	940	950
105.0	0.7981	0.8710	0.9497	4.562	4.599	4.634	931	942	952

**Temperature sensor R-T analysis table (20K)**

Sensor standard resistance : 20K $\Omega$ $\pm$ 3% B:B(25/50)=3950K $\pm$ 2% reference temperature : 25 ( $^{\circ}$ C )									
MCU_A/D exchange $\pm$ 3LSB ( at10bit )									
Series ( sampling ) resistor : 10 ( K $\Omega$ ) $\pm$ 1%									
Single chip (A/D reference voltage) supply voltage : 5V									
Temp ( $^{\circ}$ C)	Resistance ( K $\Omega$ )			MCU Input voltage ( V )			A/D Exchange value		
	MIN	TYP	MAX	MIN	TYP	MAX	MIN	TYP	MAX
-30	318.3	347.0	377.6	0.128	0.140	0.154	23	29	34
-29	299.6	326.2	354.6	0.136	0.149	0.163	25	30	36
-28	282.2	306.9	333.4	0.144	0.158	0.173	27	32	38
-27	265.9	289.0	313.5	0.153	0.167	0.183	28	34	40
-26	250.8	272.2	295.1	0.162	0.177	0.194	30	36	43
-25	236.6	256.5	277.9	0.172	0.188	0.205	32	38	45
-24	223.3	241.9	261.8	0.182	0.198	0.216	34	41	47
-23	210.9	228.2	246.7	0.193	0.210	0.229	37	43	50
-22	199.2	215.3	232.6	0.204	0.222	0.241	39	45	52
-21	188.3	203.3	219.4	0.216	0.234	0.255	41	48	55
-20	178.0	192.0	207.0	0.228	0.248	0.268	44	51	58
-19	168.3	181.4	195.4	0.241	0.261	0.283	46	54	61
-18	159.2	171.4	184.4	0.255	0.276	0.298	49	56	64
-17	150.7	162.0	174.2	0.269	0.291	0.314	52	60	67
-16	142.6	153.2	164.6	0.284	0.306	0.331	55	63	71
-15	135.0	144.9	155.5	0.299	0.323	0.348	58	66	74
-14	127.9	137.1	147.0	0.315	0.340	0.366	62	70	78
-13	121.2	129.8	138.9	0.333	0.358	0.385	65	73	82
-12	114.9	122.9	131.4	0.350	0.376	0.404	69	77	86
-11	108.9	116.4	124.3	0.369	0.396	0.424	73	81	90
-10	103.3	110.3	117.7	0.388	0.416	0.445	76	85	94
-9	98.00	104.5	111.4	0.408	0.437	0.467	81	89	99
-8	93.01	99.10	105.6	0.429	0.458	0.490	85	94	103
-7	88.29	93.98	100.0	0.450	0.481	0.513	89	98	108
-6	83.84	89.15	94.78	0.473	0.504	0.538	94	103	113
-5	79.63	84.60	89.85	0.496	0.529	0.563	99	108	118
-4	75.67	80.30	85.12	0.521	0.554	0.589	104	113	124
-3	71.91	76.24	80.75	0.546	0.580	0.616	109	119	129
-2	68.37	72.41	76.62	0.572	0.607	0.644	114	124	135
-1	65.02	68.79	72.72	0.599	0.635	0.672	120	130	141
0	61.85	65.37	69.04	0.627	0.663	0.702	125	136	147
1	58.85	62.14	65.56	0.656	0.693	0.732	131	142	153
2	56.01	59.08	62.28	0.686	0.724	0.764	137	148	159
3	53.33	56.20	59.18	0.717	0.755	0.796	144	155	166
4	50.79	53.46	56.25	0.748	0.788	0.829	150	161	173
5	48.38	50.88	53.43	0.782	0.821	0.864	157	168	180
6	46.10	48.43	50.81	0.815	0.856	0.899	164	175	187
7	43.94	46.12	48.34	0.850	0.891	0.934	171	182	194
8	41.90	43.92	45.99	0.886	0.927	0.971	178	190	202
9	39.95	41.85	43.78	0.922	0.964	1.009	186	198	210

10	38.11	39.88	41.68	0.960	1.002	1.047	194	205	218
11	36.37	38.02	39.69	0.998	1.041	1.087	201	213	226
12	34.71	36.25	37.81	1.038	1.081	1.127	209	221	234
13	33.14	34.57	36.03	1.078	1.122	1.168	218	230	242
14	31.65	32.98	34.34	1.119	1.163	1.210	226	238	251
15	30.23	31.47	32.74	1.161	1.206	1.252	235	247	259
16	28.88	30.04	31.22	1.204	1.249	1.295	244	256	268
17	27.61	28.69	29.78	1.248	1.292	1.339	252	265	277
18	26.39	27.40	28.41	1.292	1.337	1.384	262	274	286
19	25.24	26.17	27.12	1.337	1.382	1.429	271	283	296
20	24.14	25.01	25.89	1.383	1.428	1.475	280	293	305
21	23.09	23.90	24.72	1.430	1.475	1.521	290	302	315
22	22.10	22.85	23.61	1.477	1.522	1.568	300	312	324
23	21.16	21.85	22.55	1.525	1.570	1.616	309	321	334
24	20.26	20.90	21.55	1.574	1.618	1.664	319	331	344
25	19.40	20.00	20.60	1.623	1.667	1.712	329	341	354
26	18.55	19.14	19.73	1.670	1.716	1.763	339	351	364
27	17.74	18.32	18.91	1.718	1.765	1.814	349	362	375
28	16.97	17.55	18.12	1.766	1.815	1.866	359	372	385
29	16.24	16.80	17.37	1.815	1.865	1.917	369	382	396
30	15.54	16.10	16.66	1.864	1.916	1.970	379	392	406
31	14.88	15.43	15.98	1.913	1.966	2.022	389	403	417
32	14.25	14.79	15.33	1.962	2.017	2.074	399	413	428
33	13.65	14.18	14.71	2.011	2.068	2.127	409	424	439
34	13.08	13.59	14.12	2.061	2.119	2.179	419	434	449
35	12.53	13.04	13.55	2.111	2.170	2.231	429	444	460
36	12.01	12.51	13.01	2.160	2.221	2.284	439	455	471
37	11.52	12.00	12.50	2.210	2.272	2.336	450	465	481
38	11.05	11.52	12.01	2.260	2.323	2.388	460	476	492
39	10.60	11.06	11.54	2.309	2.374	2.440	470	486	503
40	10.17	10.62	11.09	2.358	2.425	2.492	480	497	513
41	9.757	10.20	10.66	2.408	2.475	2.543	490	507	524
42	9.367	9.803	10.25	2.457	2.525	2.594	500	517	534
43	8.994	9.420	9.856	2.506	2.575	2.645	510	527	545
44	8.638	9.054	9.480	2.554	2.624	2.695	520	537	555
45	8.298	8.705	9.121	2.602	2.673	2.745	530	547	565
46	7.973	8.371	8.778	2.650	2.722	2.794	540	557	575
47	7.663	8.051	8.449	2.698	2.770	2.843	549	567	585
48	7.367	7.745	8.134	2.745	2.818	2.891	559	577	595
49	7.083	7.453	7.832	2.792	2.865	2.939	569	587	605
50	6.812	7.176	7.543	2.838	2.911	2.986	578	596	615
51	6.553	6.905	7.267	2.883	2.958	3.032	588	606	624
52	6.305	6.649	7.002	2.929	3.003	3.078	597	615	633
53	6.068	6.403	6.747	2.974	3.048	3.123	606	624	643
54	5.841	6.168	6.504	3.018	3.093	3.168	615	633	652
55	5.623	5.942	6.270	3.061	3.136	3.212	624	642	661
56	5.415	5.726	6.046	3.104	3.179	3.255	633	651	670

57	5.216	5.519	5.831	3.147	3.222	3.297	641	660	678
58	5.025	5.321	5.625	3.188	3.263	3.339	650	668	687
59	4.842	5.131	5.428	3.229	3.304	3.380	658	677	695
60	4.667	4.948	5.238	3.270	3.345	3.420	667	685	703
61	4.499	4.773	5.055	3.310	3.385	3.459	675	693	711
62	4.338	4.605	4.880	3.349	3.423	3.498	683	701	719
63	4.183	4.444	4.712	3.388	3.462	3.536	691	709	727
64	4.035	4.289	4.551	3.425	3.499	3.573	699	717	735
65	3.893	4.140	4.396	3.463	3.536	3.609	706	724	742
66	3.756	3.998	4.247	3.499	3.572	3.645	714	732	749
67	3.625	3.861	4.103	3.535	3.607	3.679	721	739	757
68	3.500	3.729	3.966	3.570	3.642	3.713	728	746	763
69	3.379	3.603	3.833	3.604	3.676	3.747	735	753	770
70	3.263	3.481	3.706	3.638	3.709	3.779	742	760	777
71	3.152	3.364	3.583	3.671	3.741	3.811	749	766	783
72	3.045	3.252	3.466	3.703	3.773	3.842	755	773	790
73	2.942	3.144	3.352	3.735	3.804	3.872	762	779	796
74	2.843	3.040	3.243	3.766	3.834	3.902	768	785	802
75	2.748	2.940	3.138	3.797	3.864	3.931	775	791	808
76	2.657	2.844	3.037	3.826	3.893	3.959	781	797	814
77	2.569	2.751	2.940	3.855	3.921	3.986	787	803	819
78	2.485	2.662	2.846	3.884	3.949	4.013	792	809	825
79	2.403	2.577	2.756	3.911	3.976	4.039	798	814	830
80	2.325	2.494	2.669	3.938	4.002	4.064	804	820	835
81	2.250	2.415	2.585	3.965	4.027	4.089	809	825	840
82	2.178	2.338	2.504	3.991	4.053	4.113	814	830	845
83	2.108	2.264	2.426	4.016	4.077	4.137	819	835	850
84	2.041	2.193	2.351	4.040	4.101	4.159	824	840	855
85	1.976	2.125	2.279	4.064	4.124	4.182	829	845	859
86	1.914	2.059	2.209	4.088	4.146	4.203	834	849	864
87	1.854	1.995	2.142	4.111	4.168	4.225	839	854	868
88	1.796	1.934	2.077	4.133	4.190	4.245	843	858	872
89	1.740	1.875	2.014	4.155	4.211	4.265	848	862	877
90	1.687	1.818	1.954	4.176	4.231	4.284	852	866	880
91	1.635	1.763	1.895	4.197	4.251	4.303	856	871	884
92	1.585	1.710	1.839	4.217	4.270	4.322	861	874	888
93	1.537	1.659	1.785	4.236	4.289	4.340	865	878	892
94	1.490	1.609	1.732	4.256	4.307	4.357	869	882	895
95	1.446	1.561	1.681	4.274	4.325	4.374	872	886	899
96	1.402	1.515	1.632	4.292	4.342	4.391	876	889	902
97	1.360	1.471	1.585	4.310	4.359	4.407	880	893	905
98	1.320	1.428	1.539	4.327	4.375	4.422	883	896	909
99	1.281	1.386	1.495	4.344	4.391	4.437	887	899	912
100	1.243	1.346	1.452	4.360	4.407	4.452	890	903	915
101	1.207	1.307	1.411	4.376	4.422	4.466	893	906	918
102	1.172	1.270	1.371	4.392	4.437	4.480	896	909	921
103	1.137	1.233	1.332	4.407	4.451	4.494	900	912	923

104	1.104	1.198	1.295	4.422	4.465	4.507	903	914	926
105	1.070	1.164	1.258	4.436	4.479	4.521	906	917	929

**Temperature sensor R-T analysis table (50K)**

Sensor standard resistance : 50K $\Omega$  $\pm$ 2%      B:B(25/50)=3950K $\pm$ 2%      reference temperature : 25 (  $^{\circ}$ C )

MCU\_A/D exchange  $\pm$ 2LSB ( at8bit )

Series ( sampling ) resistor : 5.1 ( K $\Omega$  )  $\pm$ 1%

Single chip (A/D reference voltage) supply voltage : 5V

Temp ( $^{\circ}$ C)	Resistance ( K $\Omega$ )			MCU Input voltage ( V )			A/D Exchange value		
	MIN	TYP	MAX	MIN	TYP	MAX	MIN	TYP	MAX
-20	465.7	486.2	507.3	0.049	0.052	0.055	1	3	5
-19	439.7	458.7	478.3	0.052	0.055	0.058	1	3	5
-18	415.2	432.9	451.2	0.055	0.058	0.061	1	3	5
-17	392.2	408.8	425.8	0.059	0.062	0.065	1	3	5
-16	370.7	386.1	402	0.062	0.065	0.069	1	3	6
-15	350.5	364.8	379.6	0.066	0.069	0.072	1	4	6
-14	331.5	344.9	358.6	0.069	0.073	0.077	2	4	6
-13	313.7	326.2	339	0.073	0.077	0.081	2	4	6
-12	296.9	308.6	320.5	0.078	0.081	0.085	2	4	6
-11	281.2	292	303.2	0.082	0.086	0.090	2	4	7
-10	266.4	276.5	286.9	0.086	0.091	0.095	2	5	7
-9	252.4	261.8	271.5	0.091	0.096	0.100	3	5	7
-8	239.3	248.1	257.1	0.096	0.101	0.105	3	5	7
-7	226.9	235.1	243.6	0.102	0.106	0.111	3	5	8
-6	215.2	222.9	230.8	0.107	0.112	0.117	3	6	8
-5	204.3	211.5	218.8	0.113	0.118	0.123	4	6	8
-4	193.9	200.6	207.5	0.119	0.124	0.129	4	6	9
-3	184.1	190.4	196.8	0.125	0.130	0.136	4	7	9
-2	174.9	180.8	186.8	0.132	0.137	0.143	5	7	9
-1	166.2	171.7	177.3	0.138	0.144	0.150	5	7	10
0	158	163.1	168.4	0.146	0.152	0.158	5	8	10
1	150.2	155	159.9	0.153	0.159	0.166	6	8	10
2	142.9	147.4	152	0.161	0.167	0.174	6	9	11
3	136	140.2	144.5	0.169	0.175	0.182	7	9	11
4	129.4	133.3	137.4	0.177	0.184	0.191	7	9	12
5	123.2	126.9	130.6	0.186	0.193	0.201	8	10	12
6	117.3	120.8	124.3	0.195	0.203	0.210	8	10	13
7	111.8	115	118.3	0.205	0.212	0.220	8	11	13
8	106.5	109.6	112.6	0.215	0.222	0.231	9	11	14
9	101.5	104.4	107.2	0.225	0.233	0.241	10	12	14
10	96.82	99.47	102.2	0.235	0.244	0.253	10	12	15
11	92.34	94.83	97.35	0.247	0.255	0.264	11	13	16
12	88.1	90.43	92.79	0.258	0.267	0.276	11	14	16
13	84.08	86.26	88.47	0.270	0.279	0.289	12	14	17
14	80.26	82.31	84.37	0.282	0.292	0.302	12	15	17
15	76.64	78.55	80.49	0.295	0.305	0.315	13	16	18
16	73.2	74.99	76.8	0.308	0.318	0.329	14	16	19
17	69.93	71.62	73.31	0.322	0.332	0.343	14	17	20

18	66.83	68.41	69.99	0.336	0.347	0.358	15	18	20
19	63.88	65.36	66.85	0.351	0.362	0.373	16	19	21
20	61.08	62.47	63.86	0.366	0.377	0.389	17	19	22
21	58.42	59.72	61.02	0.382	0.393	0.405	18	20	23
22	55.88	57.1	58.32	0.398	0.410	0.422	18	21	24
23	53.47	54.61	55.76	0.415	0.427	0.439	19	22	24
24	51.18	52.25	53.32	0.433	0.445	0.457	20	23	25
25	49	50	51	0.450	0.463	0.476	21	24	26
26	46.88	47.86	48.84	0.468	0.481	0.495	22	25	27
27	44.87	45.82	46.78	0.487	0.501	0.515	23	26	28
28	42.95	43.88	44.82	0.506	0.521	0.535	24	27	29
29	41.12	42.03	42.95	0.526	0.541	0.557	25	28	30
30	39.38	40.27	41.17	0.546	0.562	0.578	26	29	32
31	37.73	38.59	39.47	0.567	0.584	0.601	27	30	33
32	36.15	37	37.85	0.588	0.606	0.624	28	31	34
33	34.64	35.47	36.3	0.611	0.629	0.647	29	32	35
34	33.21	34.02	34.83	0.633	0.652	0.671	30	33	36
35	31.84	32.63	33.42	0.656	0.676	0.696	32	35	38
36	30.54	31.31	32.08	0.680	0.700	0.722	33	36	39
37	29.29	30.04	30.8	0.704	0.726	0.748	34	37	40
38	28.11	28.84	29.58	0.729	0.751	0.774	35	38	42
39	26.97	27.69	28.41	0.755	0.778	0.802	37	40	43
40	25.89	26.59	27.29	0.781	0.805	0.830	38	41	44
41	24.86	25.54	26.22	0.807	0.832	0.858	39	43	46
42	23.87	24.53	25.2	0.835	0.861	0.887	41	44	47
43	22.93	23.57	24.23	0.862	0.889	0.917	42	46	49
44	22.03	22.66	23.29	0.891	0.919	0.948	44	47	51
45	21.17	21.78	22.4	0.920	0.949	0.978	45	49	52
46	20.34	20.94	21.54	0.949	0.979	1.010	47	50	54
47	19.56	20.14	20.73	0.979	1.010	1.042	48	52	55
48	18.8	19.37	19.94	1.010	1.042	1.075	50	53	57
49	18.08	18.63	19.2	1.041	1.075	1.109	51	55	59
50	17.39	17.93	18.48	1.073	1.107	1.143	53	57	61
51	16.73	17.26	17.79	1.105	1.140	1.177	55	58	62
52	16.1	16.61	17.13	1.138	1.175	1.212	56	60	64
53	15.5	15.99	16.5	1.172	1.209	1.247	58	62	66
54	14.92	15.4	15.9	1.205	1.244	1.283	60	64	68
55	14.36	14.83	15.32	1.239	1.279	1.320	61	66	70
56	13.83	14.29	14.76	1.274	1.315	1.357	63	67	71
57	13.32	13.77	14.23	1.309	1.351	1.394	65	69	73
58	12.83	13.27	13.71	1.346	1.388	1.432	67	71	75
59	12.36	12.79	13.22	1.382	1.425	1.471	69	73	77
60	11.91	12.33	12.75	1.418	1.463	1.510	71	75	79
61	11.48	11.89	12.3	1.455	1.501	1.549	73	77	81
62	11.07	11.46	11.87	1.492	1.540	1.588	74	79	83
63	10.67	11.06	11.45	1.530	1.578	1.628	76	81	85
64	10.29	10.67	11.05	1.568	1.617	1.668	78	83	87

65	9.927	10.29	10.66	1.607	1.657	1.708	80	85	89
66	9.577	9.931	10.29	1.646	1.696	1.749	82	87	92
67	9.24	9.585	9.94	1.684	1.736	1.790	84	89	94
68	8.916	9.253	9.599	1.723	1.777	1.831	86	91	96
69	8.605	8.934	9.271	1.763	1.817	1.872	88	93	98
70	8.307	8.627	8.955	1.803	1.858	1.914	90	95	100
71	8.02	8.331	8.652	1.843	1.899	1.955	92	97	102
72	7.744	8.048	8.36	1.883	1.939	1.997	94	99	104
73	7.479	7.775	8.079	1.923	1.981	2.039	96	101	106
74	7.224	7.512	7.809	1.963	2.022	2.081	99	104	109
75	6.979	7.26	7.549	2.004	2.063	2.123	101	106	111
76	6.743	7.017	7.299	2.044	2.104	2.165	103	108	113
77	6.516	6.783	7.059	2.085	2.146	2.208	105	110	115
78	6.298	6.558	6.827	2.126	2.187	2.250	107	112	117
79	6.088	6.342	6.603	2.167	2.229	2.292	109	114	119
80	5.886	6.133	6.388	2.207	2.270	2.334	111	116	121
81	5.691	5.932	6.181	2.248	2.311	2.375	113	118	124
82	5.504	5.739	5.982	2.289	2.353	2.417	115	120	126
83	5.323	5.552	5.789	2.329	2.394	2.459	117	123	128
84	5.149	5.373	5.604	2.370	2.435	2.500	119	125	130
85	4.982	5.2	5.425	2.410	2.476	2.542	121	127	132
86	4.82	5.033	5.253	2.450	2.517	2.583	123	129	134
87	4.665	4.872	5.087	2.491	2.557	2.624	126	131	136
88	4.515	4.717	4.927	2.531	2.598	2.664	128	133	138
89	4.371	4.568	4.772	2.571	2.638	2.705	130	135	140
90	4.232	4.424	4.623	2.610	2.677	2.745	132	137	143
91	4.097	4.285	4.479	2.650	2.717	2.785	134	139	145
92	3.968	4.151	4.341	2.688	2.756	2.824	136	141	147
93	3.843	4.021	4.207	2.727	2.796	2.864	138	143	149
94	3.722	3.897	4.077	2.766	2.834	2.903	140	145	151
95	3.606	3.776	3.952	2.805	2.873	2.941	142	147	153
96	3.494	3.66	3.832	2.843	2.911	2.979	144	149	155
97	3.386	3.548	3.716	2.880	2.949	3.017	145	151	156
98	3.281	3.439	3.603	2.918	2.986	3.054	147	153	158
99	3.181	3.335	3.495	2.955	3.023	3.091	149	155	160
100	3.083	3.233	3.39	2.991	3.060	3.128	151	157	162
101	2.989	3.136	3.288	3.028	3.096	3.164	153	159	164
102	2.898	3.041	3.19	3.064	3.132	3.200	155	160	166
103	2.811	2.95	3.096	3.099	3.168	3.235	157	162	168
104	2.726	2.862	3.004	3.135	3.203	3.270	159	164	169
105	2.644	2.777	2.916	3.169	3.237	3.304	160	166	171
106	2.565	2.695	2.83	3.204	3.271	3.338	162	167	173
107	2.488	2.615	2.748	3.238	3.305	3.372	164	169	175
108	2.415	2.538	2.667	3.272	3.339	3.404	166	171	176
109	2.343	2.464	2.59	3.305	3.371	3.437	167	173	178
110	2.274	2.392	2.515	3.338	3.404	3.469	169	174	180
111	2.207	2.323	2.443	3.370	3.435	3.500	171	176	181



112	2.143	2.255	2.373	3.401	3.467	3.531	172	178	183
113	2.08	2.19	2.305	3.433	3.498	3.562	174	179	184
114	2.02	2.127	2.239	3.464	3.528	3.592	175	181	186
115	1.961	2.066	2.176	3.494	3.558	3.621	177	182	187
116	1.905	2.007	2.114	3.524	3.588	3.650	178	184	189
117	1.85	1.95	2.055	3.554	3.617	3.679	180	185	190
118	1.797	1.895	1.997	3.583	3.645	3.707	181	187	192
119	1.746	1.841	1.941	3.612	3.674	3.734	183	188	193
120	1.696	1.789	1.887	3.640	3.702	3.762	184	190	195
121	1.648	1.739	1.834	3.668	3.729	3.788	186	191	196
122	1.602	1.69	1.784	3.695	3.756	3.814	187	192	197
123	1.556	1.643	1.734	3.722	3.782	3.840	189	194	199
124	1.513	1.598	1.687	3.748	3.807	3.865	190	195	200
125	1.471	1.554	1.641	3.774	3.832	3.889	191	196	201
126	1.43	1.511	1.596	3.799	3.857	3.914	193	197	202
127	1.39	1.469	1.552	3.824	3.882	3.937	194	199	204
128	1.351	1.429	1.51	3.849	3.906	3.961	195	200	205
129	1.314	1.39	1.469	3.873	3.929	3.984	196	201	206
130	1.278	1.352	1.43	3.896	3.952	4.006	197	202	207
131	1.243	1.315	1.391	3.920	3.975	4.028	199	204	208
132	1.209	1.28	1.354	3.943	3.997	4.050	200	205	209
133	1.176	1.245	1.318	3.965	4.019	4.071	201	206	210
134	1.144	1.212	1.283	3.987	4.040	4.091	202	207	211
135	1.113	1.179	1.249	4.008	4.061	4.112	203	208	213
136	1.083	1.148	1.216	4.030	4.081	4.131	204	209	214
137	1.054	1.117	1.184	4.050	4.102	4.151	205	210	215
138	1.026	1.088	1.153	4.070	4.121	4.169	206	211	215
139	0.9986	1.059	1.123	4.090	4.140	4.188	207	212	216
140	0.9721	1.031	1.093	4.110	4.159	4.206	208	213	217
141	0.9463	1.004	1.065	4.129	4.178	4.224	209	214	218
142	0.9213	0.9778	1.037	4.148	4.196	4.241	210	215	219
143	0.897	0.9523	1.011	4.166	4.213	4.258	211	216	220
144	0.8734	0.9275	0.9845	4.184	4.231	4.275	212	217	221
145	0.8505	0.9034	0.9593	4.202	4.248	4.291	213	217	222
146	0.8283	0.8801	0.9347	4.219	4.264	4.307	214	218	223
147	0.8068	0.8574	0.9108	4.236	4.280	4.323	215	219	223
148	0.7858	0.8354	0.8877	4.252	4.296	4.338	216	220	224
149	0.7655	0.814	0.8652	4.269	4.312	4.353	217	221	225
150	0.7458	0.7932	0.8433	4.284	4.327	4.368	217	222	226

---

This Service Manual belongs to AUX Imp. & Exp. Company Limited  
Technical support Department  
Ningbo, China  
Printed on 2018-10-18  
Code No. ASW20180106001

Any unauthorized use of Manual can be punished under applicable International and/or domestic law.